

Wire-to-Board Connectors

Except for DUO-TYNE flag connectors, which are exclusively for wire-to-board application, the connectors presented in this section are primarily wire-to-board connectors, but do have some board-to-board capabilities. These connectors are available in a wide range of styles to suit almost any wire-to-board application. This versatile connector family features snap-in contacts of various configurations including crimp, post, eyelet and solder types.

Wire-to-board crimp, snap-in contacts are easily inserted into the connector housing and are furnished in reel-fed strip form for automatic machine application and loose piece for hand tool termination. The Wire-to-Board Printed Circuit Board Connector family includes:

Crimp Snap Twin Leaf Connectors

(Pages 154-163)

These connectors are designed for high density wire-to-board applications and feature bifurcated, crimp and solder eyelet contacts on .100 [2.54] and .125 [3.18] centers. Design flexibility allows the customer to save by purchasing only enough contacts for his circuit design requirements. Contact styles include crimp, solder eyelet and vertical and right-angle posts, in a variety of sizes.

AMP-LEAF Connectors

(Pages 164-172)

These connectors are for single- or double-sided printed circuit boards. Snap-in contacts lock in place on .156 [3.96] centers, maintaining constant pressure on circuit paths. Contact options are available for precision crimped terminations and solder dip applications.

High Current Connectors

(Pages 173-176)

Designed for a current capability of up to 30 amperes, these connectors are an economical answer to the costly problem of interconnecting high current printed circuitry. Styles are available for wire-to-board and board-to-board applications. Contacts are on .312 [7.92] centers.

DUO-TYNE Flag Connectors

(Pages 177-180)

These economical connectors are designed to meet the quality and reliability requirements of industries such as appliance controls, vending machine subassemblies, television, stereo, business machines and other areas with similar control needs. The right-angle design of the connector permits close-quarter cabling. Contacts are doubly locked in when a PC board is inserted.

Wire-to-Board Connector Selection Guide

**Crimp Snap
Twin Leaf Connectors
(Pages 154-163)**

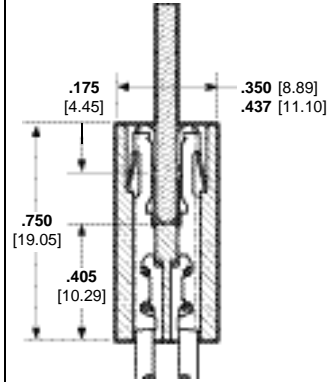

**AMP-LEAF
Connectors
(Pages 164-172)**

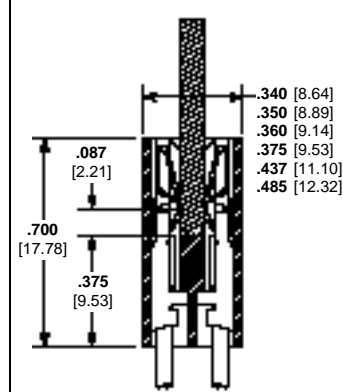

Centerlines

.100 [2.54]	X	
.125 [3.18]	X	
.156 [3.96]	X	X
.197 [5.00]		
.260 [6.60]		
.312 [7.92]		

Styles

Crimp	X	X
Right-Angle Post	X	X
Wrap-Type Post	X	X
Solder Eyelet	X	X
Solder Tail	X	X
Double Sided	X	X
Single Sided	X	X

**High Current
Connectors
(Pages 173-176)**

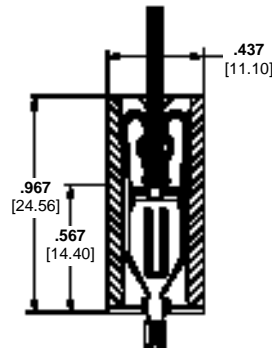

**DUO-TYNE Flag
Connectors
(Pages 177-180)**

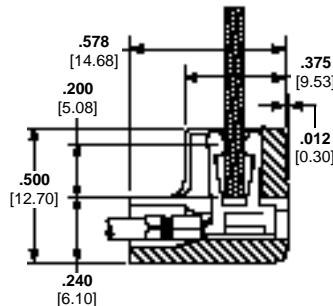

Centerlines

.100 [2.54]		
.125 [3.18]		
.156 [3.96]		X
.197 [5.00]		
.260 [6.60]		
.312 [7.92]	X	

Styles

Crimp	X	X
Right-Angle Post		
Wrap-Type Post		
Solder Eyelet		
Solder Tail	X	
Double Sided	X	X*
Single Sided		

*Double-sided board; single readout.

Wire-to-Board Connectors

Crimp Snap Twin Leaf Connectors

Product Facts

- Crimp snap-in, solder eye-let, .025 [0.64] square posted and right angle contacts on .100 [2.54], .125 [3.18] or .156 [3.96] centers
- Customer buys only enough contacts to meet circuit and retention requirements
- Contacts bifurcated for redundancy
- Single leaf version available for higher contact normal forces
- Low insertion forces
- Accommodates AWG 16-28 [1.4-0.08 mm²] wire range and insulation diameters .035-.105 [0.89-2.67]
- Large variety of connector sizes
- Cavity identification on face of card slot and wire entry
- High speed automatic machine terminations provide uniform reliability at lowest applied cost
- Recognized under the Component Program of Underwriters Laboratories Inc. File No. E28476
- Certified by Canadian Standards Association File No. LR 7189

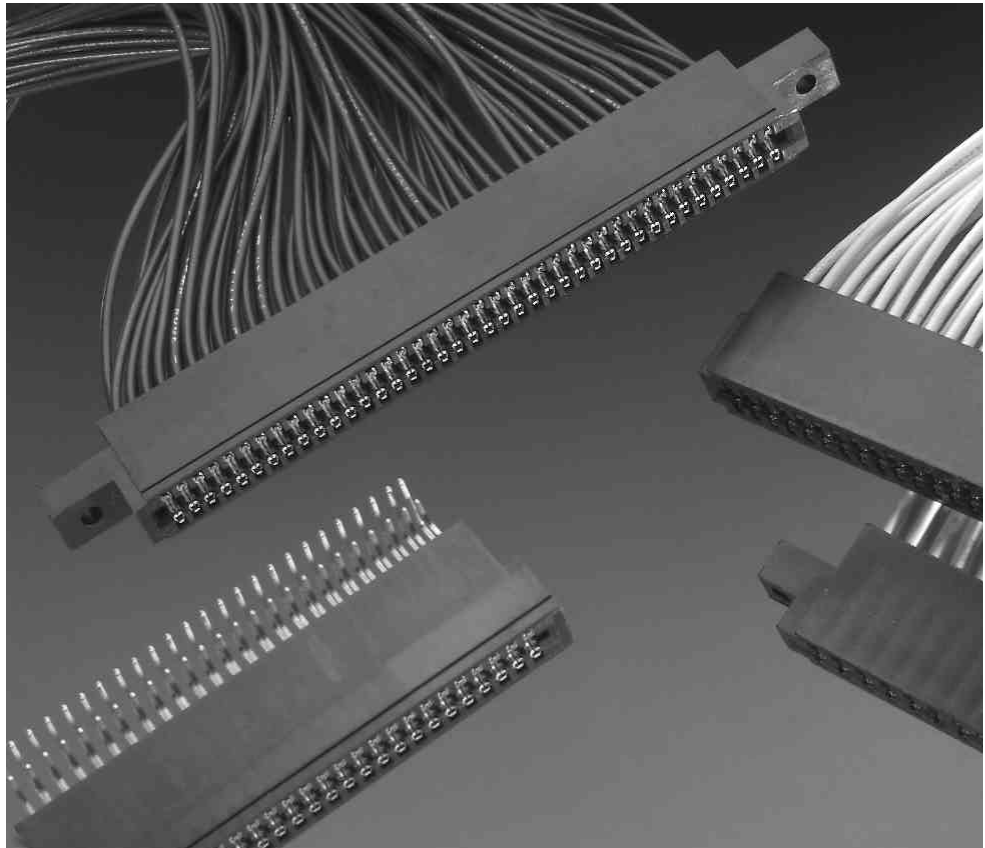

The Crimp Snap Twin Leaf Connector is designed especially for high density wire-to-board applications. Termination styles include crimp, solder, posted and right angle, in a variety of sizes.

Design flexibility allows the customer to save by purchasing only enough contacts for the circuit requirements. Easy replaceability of each contact cuts repair cost in the event of contact or wire damage.

Performance Specifications

Contact Rating*: 5 amperes, continuous 3 amperes, max. (for .025 [0.64] posted contacts)

Contact Resistance: 10 milliohms, max.

Insulation Resistance: 5000 megohms (initial)
1000 megohms

Voltage Rating:
.100 [2.54] Centerline-1000 Vrms
.125 [3.18] Centerline-1500 Vrms
.156 [3.96] Centerline-1800 Vrms

Insertion Force (per pair): Twin Leaf-10 oz. [2.78 N], max.; 7.6 oz. [2.11 N], avg. Non-Bifurcated Contacts-20 oz. [5.57 N], max.

Extraction Force (per pair): Twin Leaf-0.7 oz. [0.195 N], min.; 1.2 oz. [0.334 N], avg.

Operating Temperature: -55°C to +105°C

*Consult Tyco Electronics engineering when paralleling contacts for power applications.

Crimp Snap Twin Leaf Connectors (Continued)

Crimp, Snap-In Contacts

Material and Finish:

Phosphor bronze, plated .000030 [0.00076] nickel on entire contact, with the addition of one of the following platings:

Plating A—.000030 [0.00076] gold in mating area

Plating B—.000015 [0.00038] gold in mating area

Plating C—.000050 [0.00127] gold in mating area, with gold flash on remainder of contact

Plating D—.000015 [0.00038] gold in mating area, with gold flash on remainder of contact

Note: Tin plating is available upon request.

Related Product Data:

Performance Specifications—page 154

Application Tooling—pages 184,185

Connector Housings—pages 157, 159, 161

Technical Documents:

(pages 186, 187):

Product Specification 108-9031

Application Specification 114-9004

Instruction Sheets

408-7527, 408-7529, 408-7531, 408-7551, 408-7556, 408-7583

Note: Only loose piece contacts manufactured and supplied by Tyco Electronics are to be used with the hand tools listed on this page. No attempt should be made to produce loose piece parts from a strip since special cutoff tooling is required to assure a properly functioning part.

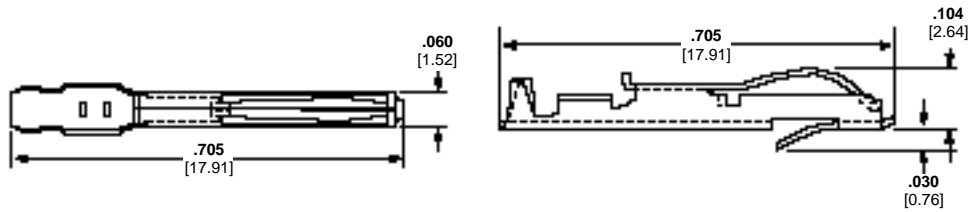

Connector Centerline	Wire Size Range AWG/mm ²	Insulation Dia. Range	Contact Finish (Plating)	Contact Part Numbers		Applicator for AMP-O-LECTRIC Machine*	Applicator for Stripper/Crimper Machine	Color Code	Hand Tool
				Loose Piece	Strip Form				
.100 2.54	28-24 0.08-0.2	.035-.055 0.89-1.40	A	583616-4	583616-2	466577-4	466912-1	Orange	90268-1
			B	583616-5	583616-3				
			C	583616-9	583616-8				
			D	1-583616-1	1-583616-0				
.125 3.18	24-20 0.2-0.6	.048-.060 1.22-1.52	A	583853-5	583853-3	466622-2	466919-1	Green	91535-1
			B	583853-4	583853-2				
			C	583853-9	583853-8				
			D	1-583853-1	1-583853-0				
.156 3.96	28-24 0.08-0.2	.035-.055 0.89-1.40	A	583616-4	583616-2	466577-4	466912-1	Orange	90268-1
			B	583616-5	583616-3				
			C	583616-9	583616-8				
			D	1-583616-1	1-583616-0				
.156 3.96	24-20 0.2-0.6	.048-.060 1.22-1.52	A	583853-5	583853-3	466622-2	466919-1	Green	91535-1
			B	583853-4	583853-2				
			C	583853-9	583853-8				
			D	1-583853-1	1-583853-0				
.156 3.96	22-18 0.3-0.9	.049-.095 1.24-2.41	A	583649-6	583649-3	466713-2	466928-1	Violet	90264-1
			B	583649-5	583649-2				
			C	583649-7	583649-4				
			D	1-583649-1	1-583649-0				
.156 3.96	20-16 0.6-1.4	.073-.090 1.85-2.29	A	583875-6	583875-5	687775-2	—	White	90285-1
			B	583875-3	583875-2				
			C	583875-3	583875-2				
			D	583875-3	583875-2				

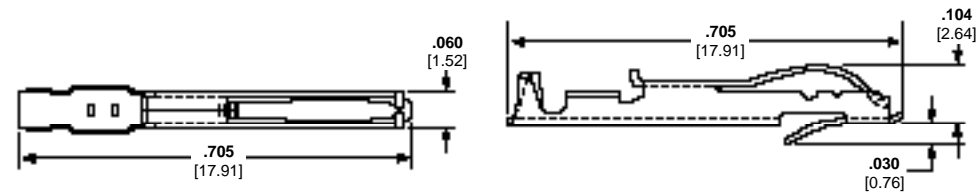

Crimp, Snap-In Contacts, Non-Bifurcated

Material and Finish:

Phosphor bronze, plated .000030 [0.00076] nickel on entire contact, with the addition of one of the following platings:

Plating A—.000030 [0.00076] gold in mating area

Plating B—.000015 [0.00038] gold in mating area

Note: Tin plating is available upon request.

Related Product Data:

(See above)

Connector Centerline	Wire Size Range AWG/mm ²	Insulation Dia. Range	Contact Finish (Plating)	Contact Part Numbers		Applicator for AMP-O-LECTRIC Machine*	Applicator for Stripper/Crimper Machine	Color Code	Hand Tool
				Loose Piece	Strip Form				
.100 2.54	28-24 0.08-0.2	.035-.055 0.89-1.40	A	531476-5	531476-4	466577-4	466912-1	Orange	90268-1
			B	531477-5	531477-4				
			C	531477-4	531477-2				
			D	531477-4	531477-2				
.125 3.18	24-20 0.2-0.6	.048-.060 1.22-1.52	A	531477-5	531477-4	466622-2	466919-1	Green	91535-1
			B	531477-3	531477-2				
			C	531477-3	531477-2				
			D	531477-3	531477-2				
.156 3.96	22-18 0.3-0.9	.045-.095 1.14-2.41	A	—	531478-4	466713-2	466928-1	Violet	90264-1
			B	531476-5	531476-4				
			C	531477-5	531477-4				
			D	531477-3	531477-2				
.156 3.96	24-20 0.2-0.6	.048-.060 1.22-1.52	A	531476-5	531476-4	466577-4	466912-1	Orange	90268-1
			B	531477-5	531477-4				
			C	531477-3	531477-2				
			D	531477-3	531477-2				
.156 3.96	22-18 0.3-0.9	.045-.095 1.14-2.41	A	—	531478-4	466713-2	466928-1	Violet	—

*Applicators are for AMP-O-LECTRIC Model "K" machines. Consult Tyco Electronics for applicators for other bench machines and lead-making machines.

Snap-In Solder Eyelet Contacts

Material and Finish:

Phosphor bronze, plated .000030 [0.00076] nickel on entire contact, with the addition of one of the following platings:

Plating A—.000030 [0.00076] gold in mating area

Plating B—.000015 [0.00038] gold in mating area

Solder eyelet portion is tin plated.

Note: Tin plating of entire contact is available upon request.

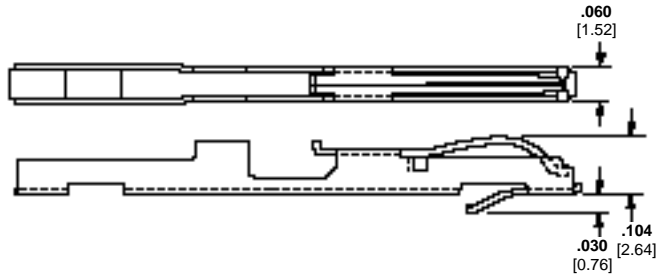

Related Product Data:

Performance Specifications—page 154

Connector Housings—pages 157, 159, 161

Connector Centerline	Contact Finish (Plating)	Part Numbers
.100 2.54	A B	583854-3 583854-5
.125 3.18	A	530245-3

Technical Documents

(pages 186, 187):

Product Specification
108-9031

Application Specification
114-9004

Instruction Sheets 408-7527,
408-7529

Snap-In Wrap Post Contacts

Material and Finish:

Contact—Phosphor bronze, plated .000015 [0.00038] gold in mating area, with entire contact underplated .000030 [0.00076] nickel

Post—Phosphor bronze, tin-plated

Note: Tin plated contacts are available upon request.

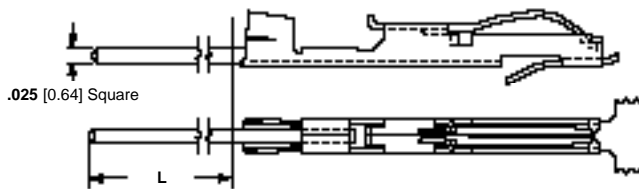

Connector Centerline Spacing	Dimension L	Part Numbers
.100 2.54	.451 11.46	583879-1
	.535 13.59	583879-4
.125 3.18	.525 13.34	583884-1
	.525 13.34	583884-1

Related Product Data:

Performance Specifications—page 154

Connector Housings—pages 157, 159, 161

Technical Documents:

(pages 186, 187):

Product Specification
108-9031

Application Specification
114-9004

Instruction Sheets 408-7527,
408-7529

Hand



Contact Extraction Tool



Crimp Snap Twin Leaf Connectors, .100 [2.54] Centerline

Housings

Material: Black glass-filled polyester, 94V-0 rated

Related Product Data:

Performance Specifications—page 154

Contacts—pages 155, 156

Accessories—page 162*

PCB Edge Pattern—page 163

Technical Documents:

(pages 186, 187):

Product Specification 108-9031

Application Specification 114-9004

Instruction Sheet 408-7527

With Mounting Ears

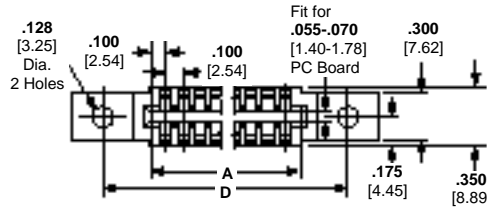

Without Mounting Ears

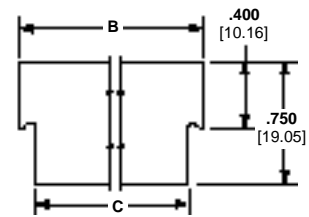
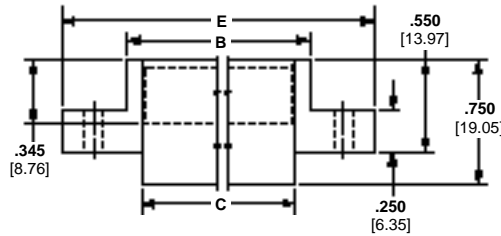
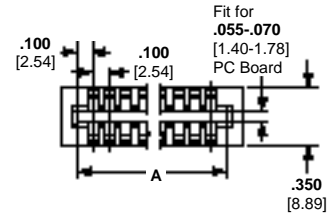

No. of Dual Positions	Dimensions					Part Numbers	
	A	B	C	D	E	Without Mounting Ears	With Mounting Ears
6	.700	.900	.720	—	—	2-583717-1	—
	17.78	22.86	18.29	1.175	1.430	—	583861-5
7	.800	1.000	.820	—	—	2-583717-3	—
	20.32	25.4	20.83	—	—	—	—
8	.900	1.100	.920	—	—	3-583717-9	—
	22.86	27.94	23.36	—	—	—	—
10	1.100	1.300	1.120	1.700	2.100	583717-1	583718-1
	27.94	33.02	28.49	43.18	53.34	—	583861-7
13	1.200	1.400	1.600	—	—	3-583717-3	—
	30.48	35.56	40.64	—	—	—	—
14	1.500	1.700	1.520	—	—	2-583717-7	—
	38.1	43.16	38.61	—	—	—	—
15	1.600	1.800	1.620	2.200	2.600	583717-3	583718-3
	40.64	45.72	41.15	55.88	66.04	—	583861-9
17	1.800	2.000	1.820	2.400	2.800	583717-5	1-583861-1
	45.72	50.8	46.30	60.96	71.12	—	—
18	1.900	2.100	1.920	—	—	583717-7	—
	48.26	53.34	48.76	—	—	—	—
20	2.100	2.300	2.120	—	—	3-583717-1	—
	53.34	58.42	53.84	—	—	—	—
22	2.300	2.500	2.320	2.900	3.300	583717-9	583718-9
	58.42	63.50	58.93	73.66	83.82	—	—
25	2.600	2.800	2.620	3.200	3.600	1-583717-1	1-583718-1
	66.04	71.12	66.55	81.28	91.44	—	—
30	3.100	3.300	3.120	3.700	4.100	1-583717-3	1-583718-3
	78.74	83.82	79.25	93.98	104.14	—	583861-1
32	3.300	3.500	3.320	3.900	4.300	—	2-583718-7
	83.82	88.90	84.33	99.06	109.22	—	—
36	3.700	3.900	3.720	4.175	4.430	—	2-583861-5
	93.98	93.06	94.49	106.04	112.52	—	—
40	4.100	4.300	4.120	4.700	5.100	—	1-583718-5
	104.14	109.22	104.65	119.38	129.54	—	583861-3
50	5.100	5.300	5.120	5.700	6.100	1-583717-9	1-583718-7
	129.54	134.62	130.05	144.78	154.94	—	2-583861-1

Note: Other connector sizes can be made available, consult Tyco Electronics.

Crimp Snap Twin Leaf Connectors, .100 [2.54] Centerline (Continued)

Housings Preloaded with Right-Angle Posts

Material and Finish:

Housing—Black glass-filled polyester, 94V-0 rated

Contacts—Phosphor bronze, plated .000015 [0.00038] gold in mating area, with entire contact underplated .000030 [0.00076] nickel

Posts—Phosphor bronze, tin plated

Related Product Data:

Performance Specifications—page 154

Accessories—page 162*

PCB Edge Pattern and Hole Layout—page 163

Technical Documents:

(pages 186, 187):

Product Specification 108-9031

Application Specification 114-9004

Instruction Sheet 408-7527

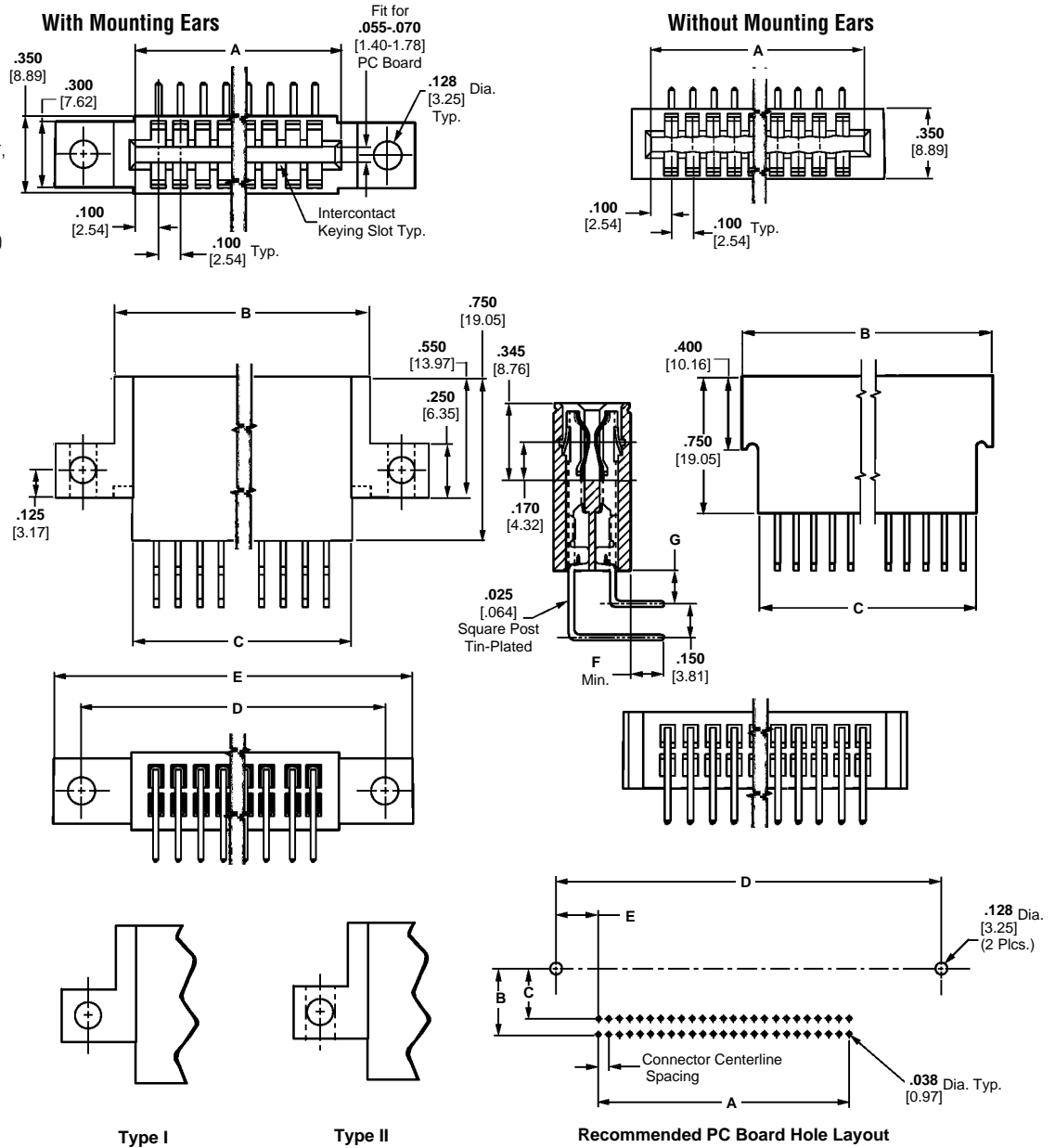

No. of Dual Pos.	Dimensions							Posted Assembly Part Numbers		
	A	B	C	D	E	F	G	Right-Angle Post With Mounting Ears		Right-Angle Post Without Mounting Ears
	Type I	Type II								
10	1.100 27.94	1.300 33.02	1.120 28.49	1.575 40.01	1.830 46.48	—	—	—	583900-5	—
17	1.800 45.72	2.000 50.80	1.820 46.23	—	—	.090 2.29	.150 3.81	—	—	530218-5
22	2.300 58.42	2.500 63.50	2.320 58.93	2.900 73.66	3.300 83.82	.090 2.29	.150 3.81	—	1-583900-3	530218-9
25	2.600 66.04	2.800 71.12	2.620 66.55	3.200 81.28	3.600 91.44	.090 2.29	.150 3.81	583900-1	—	530218-1
28	2.900 73.66	3.100 78.74	2.920 74.16	3.375 85.72	3.630 92.20	.090 2.29	.150 3.81	—	583900-6	—
30	3.100 78.74	3.200 81.28	3.120 79.25	3.700 93.98	4.100 104.14	.090 2.29	.150 3.81	—	583900-4	530218-6
50	5.100 129.54	5.300 134.62	5.120 130.05	5.575 141.61	5.830 148.08	—	—	583900-3	—	—

Note: Other connector sizes can be made available, consult Tyco Electronics.

Crimp Snap Twin Leaf Connectors, .125 [3.18] Centerline

Housings

Material: Black glass-filled polyester
94V-0 rated

Related Product Data:

Performance Specifications—
page 154

Contacts—pages 155, 156

Accessories—page 162

PCB Edge Pattern—page 163

Technical Documents:

(pages 186, 187):

Product Specification
108-9031

Application Specification
114-9004

Instruction Sheet 408-7527

With Mounting Ears

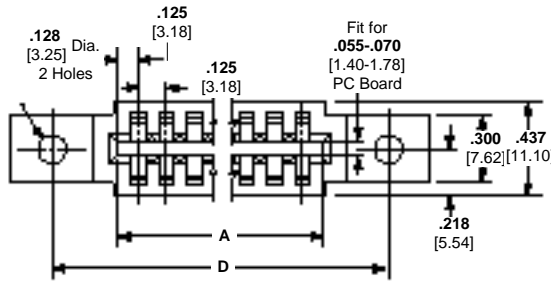

Without Mounting Ears

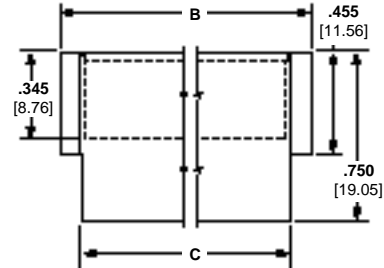
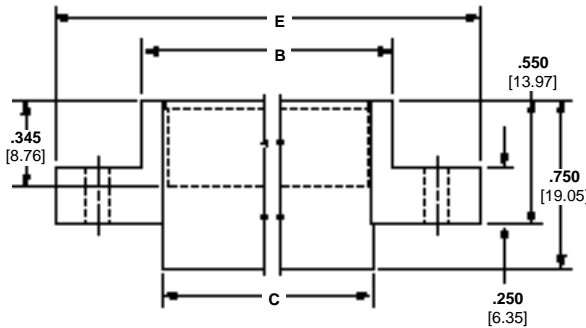
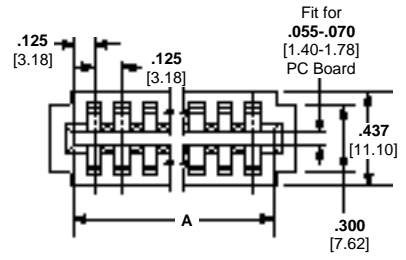

No. of Dual Positions	Dimensions					Part Numbers	
	A	B	C	D	E	Without Mounting Ears	With Mounting Ears
6	.875 22.23	1.035 26.29	.845 21.46	1.295 32.89	1.555 39.50	583873-1	583864-1
10	1.375 34.93	1.535 38.99	1.345 34.16	1.795 45.59	2.055 52.20	—	583864-3
15	2.000 50.80	2.160 54.86	1.970 50.04	2.420 61.47	2.680 68.07	583873-5	—
22	2.875 73.03	3.035 77.09	2.845 72.26	3.295 83.69	3.555 90.30	583873-9	583864-9
25	3.250 82.55	3.410 86.61	3.220 81.79	3.670 93.22	3.930 99.82	—	—
28	3.625 92.08	3.785 96.14	3.595 91.31	4.045 102.74	4.305 109.35	—	1-583864-3
30	3.875 98.43	4.035 102.49	3.845 97.66	4.295 109.09	4.555 115.70	—	2-583864-1
40	5.125 130.17	5.285 134.23	5.095 129.41	5.545 140.84	5.805 147.44	—	1-583864-7
44	5.625 142.88	5.785 146.94	5.595 142.11	6.045 153.54	6.305 160.15	1-583873-9	—

Note: Other connector sizes can be made available, consult Tyco Electronics.

Crimp Snap Twin Leaf Connectors, .125 [3.18] Centerline (Continued)

Housings Preloaded with Right-Angle Posts

Material and Finish:

Housing—Black glass-filled polyester, 94V-0 rated

Contacts—Phosphor bronze, plated .000030 [0.00076] gold in mating area, with entire contact underplated .000030 [0.00076] nickel

Posts—Phosphor bronze, tin-plated

Related Product Data:

Performance Specifications—page 154

Accessories—page 162

PCB Edge Pattern and Hole Layout—page 163

Technical Documents:

(pages 186, 187):

Product Specification 108-9031

Application Specification 114-9004

Instruction Sheet 408-7527

With Mounting Ears

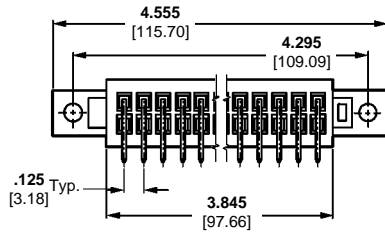
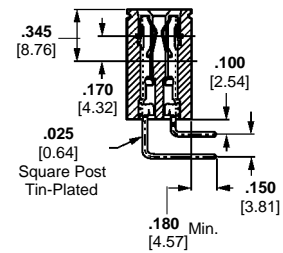
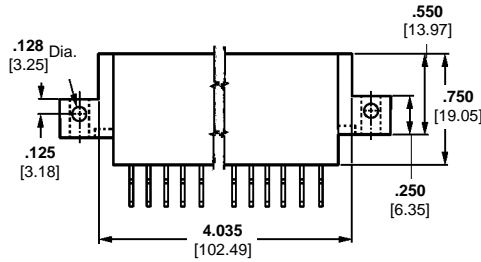
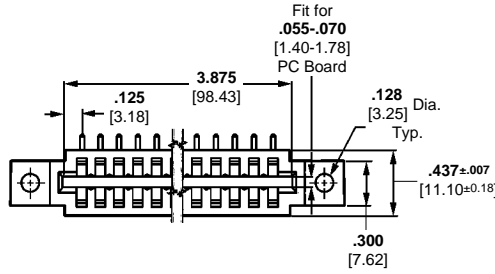

**30 Dual Positions,
Part No. 530238-8**

Crimp Snap Twin Leaf Connectors, .156 [3.96] Centerline

Housings

Material: Black glass-filled polyester, 94V-0 rated

Related Product Data:

- Performance Specifications**—page 154
- Contacts**—pages 155, 156
- Accessories**—page 162
- PCB Edge Pattern**—page 163

Technical Documents:

- (pages 186, 187):
- Product Specification 108-9031
- Application Specification 114-9004
- Instruction Sheet 408-7527

With Mounting Ears

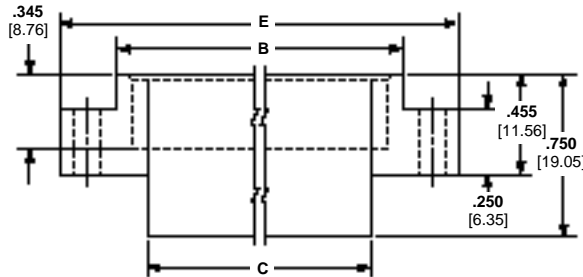
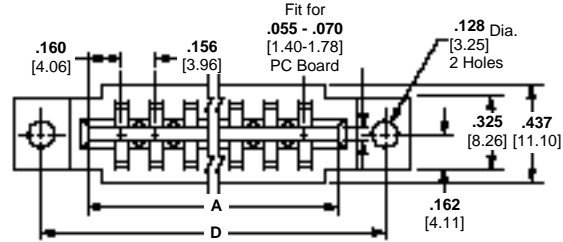

No. of Dual Positions	Dimensions					Part Numbers Mounting Ears
	A	B	C	D	E	
6	1.100 27.94	1.264 32.11	.976 24.79	1.535 38.99	1.785 45.34	1-583859-3
8	1.412 35.86	1.576 40.03	1.288 32.72	1.847 46.91	2.097 53.26	2-583859-1
10	1.724 43.79	1.888 47.96	1.600 40.64	2.159 54.84	2.409 61.19	583859-9
12	2.036 51.71	2.200 55.88	1.912 48.56	2.471 62.76	2.721 69.11	1-583859-5
15	2.504 63.60	2.668 67.77	2.380 60.45	2.939 74.65	3.189 81.00	583859-7
18	2.972 75.49	3.136 79.55	2.848 72.34	3.407 86.54	3.657 92.89	583859-5
22	3.596 91.34	3.760 95.50	3.472 88.19	4.031 102.39	4.281 108.74	583859-3
28	4.532 115.11	4.696 119.28	4.408 111.96	4.967 126.16	5.217 132.51	583859-1
36	5.780 146.81	5.944 150.96	5.656 143.66	6.215 157.86	6.465 164.21	2-583859-3

Note: Other connector sizes can be made available, consult Tyco Electronics.

Accessories for Crimp Snap Twin Leaf Connectors

Dummy Contacts

Material: Phosphor bronze

Related Product Data:

The dummy contact is used in sparsely loaded housings to balance contact pressure. For specific recommendations, consult Tyco Electronics.

Technical Documents

(pages 186, 187):
Instruction Sheet 408-7527

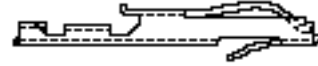

Tin Plated — **Part No. 583857-5**
.000030 [0.00076] Nickel Plated — **Part No. 583857-6**
Gold Flash-Over-Nickel Plate — **Part No. 583857-7**

Retaining Spring

Material: Stainless steel

Related Product Data:

Retaining springs are used for single sided PC board applications. Use one spring per 6 empty cavities.

Technical Documents

(pages 186, 187):
Instruction Sheet 408-7527



Unplated — **Part No. 583691-2**
Gold Flash-Over-Nickel Plate — **Part No. 583691-3**

Keying Plugs

Technical Documents

(pages 186, 187):
Instruction Sheet 408-7527

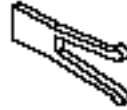

On-Contact Plug
Natural Nylon — **Part No. 583764-1**

Intercontact Plug
Natural Nylon — **Part No. 583274-1**
Glass-Filled Polyester — **Part No. 583274-3**

Locking Key

Material: Nylon

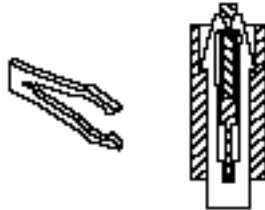

On-Contact Clip
Part No. 530213-1

Mounting Block

Material: Natural color nylon

Kit Part No. 531250-4

Each kit includes 2 mounting blocks
2 self tapping screws,
#5 x .437 [11.10]
2 roll pins
.075 x .250 [1.57 x 6.35]

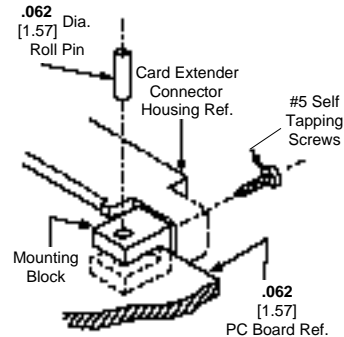

**Recommended PC Board
Edge Pattern**

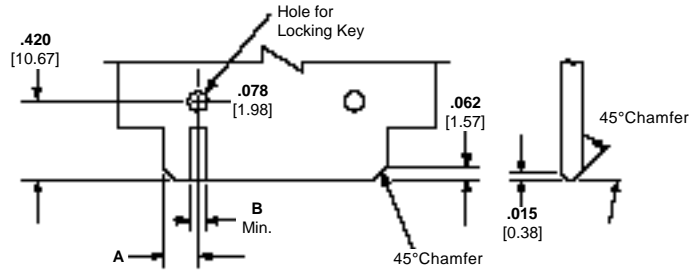

Connector Centerline Spacing	Dimensions	
	A	B
.100	.093	.052
2.54	2.36	1.32
.125	.118	.078
3.18	3.00	1.98
.156	.153	.094
3.96	3.89	2.39

**Recommended PC Board
Hole Layout**

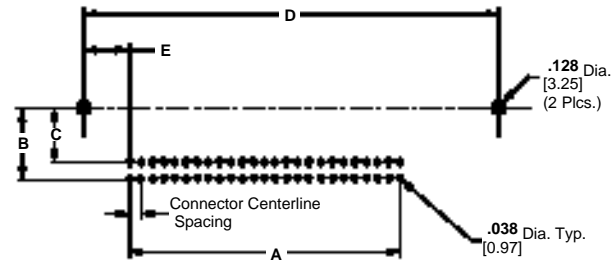

Connector Centerline Spacing: .100 [2.54]

No. of Dual Positions	Dimensions				
	A	B	C	D	E
10	.900 22.86	.625 15.88	.475 12.07	1.575 40.01	.400 10.16
17	1.600 40.64	—	—	—	—
20	1.900 48.26	.625 15.88	.375 9.53	2.575 65.41	.337 8.56
22	2.100 53.34	.625 15.88	4.75 12.07	2.900 73.66	.337 8.56
25	2.400 60.96	.625 15.88	.475 12.07	3.200 81.28	.400 10.16
30	2.900 73.66	—	—	3.700 93.98	.400 10.16
50	4.900 124.46	.525 13.34	.375 9.53	5.575 141.61	.337 8.56

Connector Centerline Spacing: .125 [3.18]

No. of Dual Positions	Dimensions				
	A	B	C	D	E
30	3.625 92.08	—	—	4.295 109.09	.350 8.89

AMP-LEAF Connectors

Product Facts

- Contacts on .156 [3.96] centers
- Glass-filled polyester, phenolic or diallyl phthalate housings
- Closed card entry design helps prevent overstressing of contacts
- Gold-over-nickel plated contacts
- Locking lance permits easy contact replacement
- Keying
- Contacts maintain exact pressures on the circuit paths, despite repeated insertions and extractions
- Recognized under the Component Program of Underwriters Laboratories Inc. File No. E28476 
- Certified by Canadian Standards Association**, File No. LR 7189 

**CSA certification pending for certain products, as noted.

Performance Specifications

Contact Current Rating*:

5.0 amperes, max.

Contact Engaging Force:

16 oz. [4.4 N], max.

Contact Separation Force:

2 oz. [0.6 N], min.

Vibration:

MIL-STD-202, Method 201

Operating Temperature:

Contacts -40°C to +85°C

Storage Temperature:

-40°C to +85°C

Housings:

Glass-Filled Polyester, -55°C to +105°C

Glass-Filled Phenolic, -65°C to +125°C

Diallyl Phthalate, -65°C to +125°C

*Consult Tyco Electronics engineering when paralleling contacts for power applications.

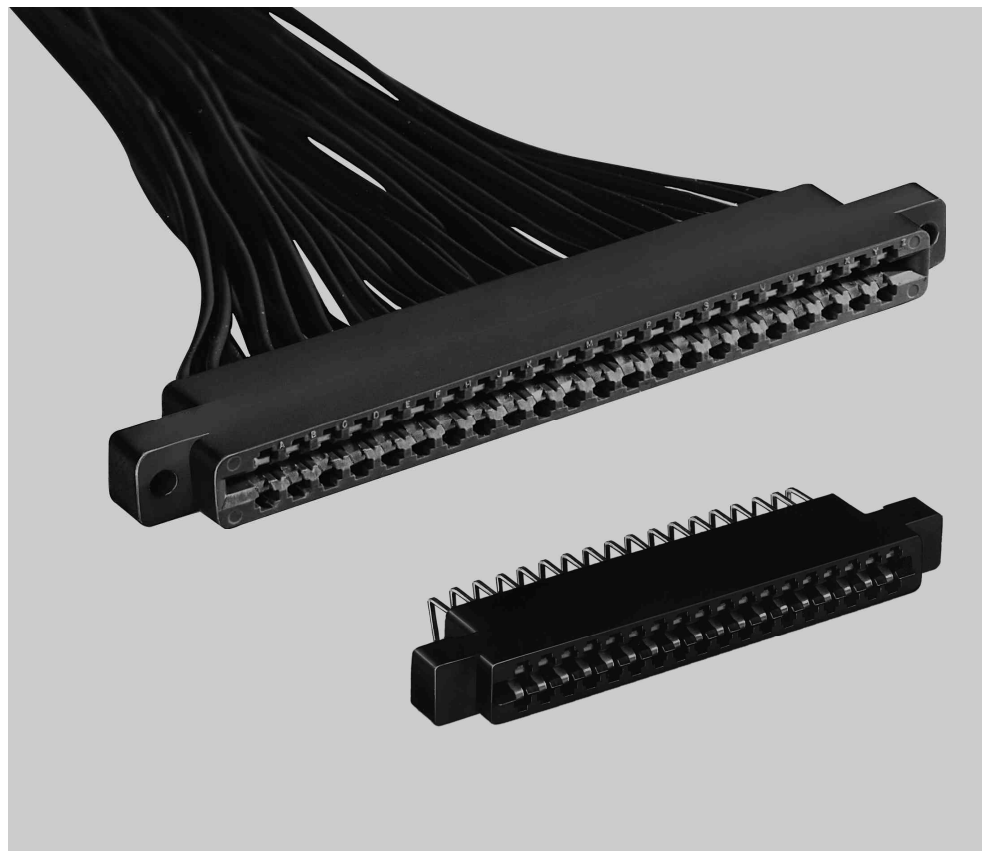

AMP-LEAF Connectors are available with crimp, snap-in contacts or preloaded with right-angle posted contacts.

The crimp type printed circuit connector is supplied with the housing unloaded—the user buys only enough contacts to satisfy circuit requirements. This feature, when coupled with the Tyco Electronics matched tooling, contributes substantially to lower installed costs.

Right-angle posted connectors are supplied in various sizes, with preloaded contacts on one or both sides. The solder-type posts are formed 90° from the housing to permit right-angle interfacing between mother and daughter boards.

AMP-LEAF Connectors (Continued)

Crimp, Snap-In Contacts

Material and Finish:

Phosphor bronze, plated as follows:
Plating A—.000100-.000200 [0.00254-0.00508] tin (lubricant must be used)

Plating B—.000030 [0.00076] min. gold in mating area, gold flash on remainder of contact, with entire contact underplated .000050 [0.00127] min. nickel

Plating C—.000015 [0.00038] min. gold in mating area, gold flash on remainder of contact, with entire contact underplated .000050 [0.00127] min. nickel

Plating D—.000030 [0.00076] min. gold over .000050 [0.00127] min. nickel in mating area, remainder of contact gold flash over .000015 [0.00038] min. nickel

Plating E—.000030 [0.00076] min. gold in mating area, with entire contact underplated .000050 [0.00127] min. nickel

Plating F—.000015 [0.00038] min. gold in mating area, with entire contact underplated .000050 [0.00127] min. nickel

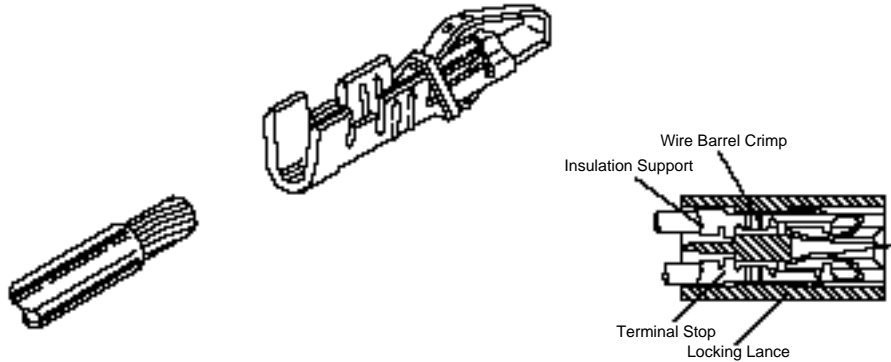

Wire Range AWG/mm ²	Insulation Range		Contact Part Numbers		Contact Finish	Applicator for AMP-O-LECTRIC Machine*	Hand Tool
	Single Wire	Double Wire	Loose Piece	Strip Form			
26-22 0.12-0.4	.050-.064 1.27-1.63	—	583990-3	583204-2	B	466366-2	90028-3
			—	343371-1	D		
			—	583361-2	A		
22-18 0.3-0.9	.055-.080 1.40-2.03	.120 3.05 Max.	583989-3	583361-3	B	466367-2	90017-3 (1 #22-20) 90028-3 (2 #22) 90101-3 (1 #20)
			583989-4	583361-4	C		
			—	583555-4	E		
			—	583555-6	F		
			—	—	—		
16 1.25-1.40	.108 2.74 Max.	.080-.160 2.03-4.06	583991-3	60151-6	B	466368-2	90031-8 (2 #18) 90101-3 (2 #20) 90101-3 (1 #16)

*Applicators are for AMP-O-LECTRIC Model "K" machines. Consult Tyco Electronics for applicators for other bench machines and lead-making machines.

- Notes:** 1. Shorting contacts are available, consult Tyco Electronics.
2. Contacts and housings to accommodate .093 [2.36] thick PC boards can be made available, consult Tyco Electronics.

Related Product Data:

Performance Specifications—
page 164

Connector Housings—
pages 167-169

Application Tooling—
pages 184, 185

Technical Documents:

- (pages 186, 187):
Product Specifications
108-9013, 108-9043
Application Specification
114-9003
Instruction Sheets
408-6591, 408-7045, 408-7622,
408-7623, 408-7624, 408-7625,
408-7626
Crimp Inspection Sheet
CI 8050-33

Hand Crimping Tool



Contact Extraction Tool

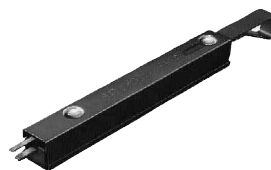

Extraction Tool Number	Used with Housings
465195-1	480110-2, -5
	480142-2, -3
	582140-5
	582147-5
	582264-2
	582500-2
	582963-2
	583167-3
	583280-1
	583617-1
	583680-1
	583685-1
	583722-1
	583723-1
	583724-1
583725-1	
583726-1	
465195-2	480133-2

Dummy Contact

Material:

Phosphor bronze



- Plain Finish—
Part No. 66084-1
Tin Finish—
Part No. 66084-2
Gold Finish—
Part No. 66084-3

Technical Documents:

- (pages 186, 187):
Instruction Sheet 408-7037

AMP-LEAF Connectors (Continued)

Solder Eyelet Contact

Material and Finish:

Phosphor bronze, plated .000015 [0.00038] min. gold in contact area, gold flash on remainder of contact, with entire contact underplated .000050 [0.00127] min. nickel

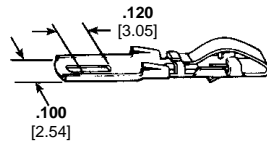

Standard Eyelet Type Contact
Part No. 66067-5
(For .055-.070 [1.4-1.78]
Thick PC Boards)

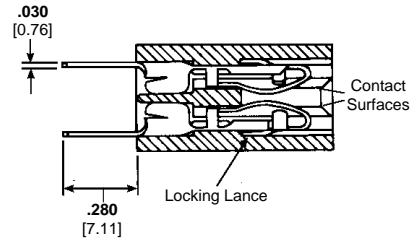

Note: Solder tab will accommodate a maximum of two 16 AWG [1.25-1.4 mm²] solid wires, or two 18 AWG [0.8-0.9 mm²] stranded wires.

Post Type Contacts

Material and Finish:

Phosphor bronze, plated .000015 [0.00038] min. gold in contact area, tin on post, with entire contact underplated .000050 [0.00127] min. nickel

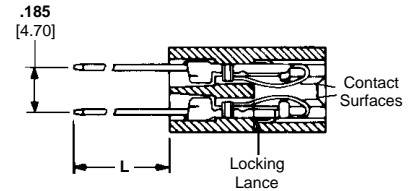

Post Length L	Loose Piece Contact Part No. (.045 x .045 [1.14 x 1.14] Post)
.960 24.38	1-582355-3
.560 14.22	1-582355-5

Note: Post type contacts are for .055-.070 [1.4-1.78] thick PC boards.

Solder Dip Contacts

Material and Finish:

Phosphor bronze, plated .000015 [0.00038] min. gold in contact area or, plated .000030 [0.00076] min. gold in contact area, tin on post, with entire contact underplated .000050 [0.00127] min. nickel

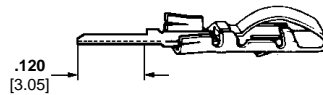

Solder Dip Contact
Part No. 583294-2 (.000015)
Part No. 583294-1 (.000030)
(For .062 [1.57]
Thick PC Board)

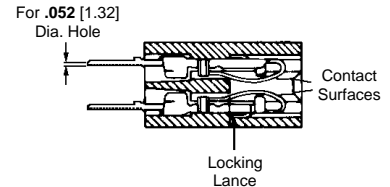

AMP-LEAF Connectors, .156 [3.96] Centerline

Glass-Filled Polyester Housings

Material: Glass-filled polyester

Related Product Data:

Card Guide Assembly—page 171

PC Board Thickness—.055-.070 [1.40-1.78]

Performance Specifications—page 164

Contacts—pages 165, 166

Accessories—page 171

PC Board Layout—page 172

Technical Documents:

(pages 186, 187):

Product Specifications

108-9013, 108-9043

Application Specification

114-9003

Instruction Sheet 408-7037

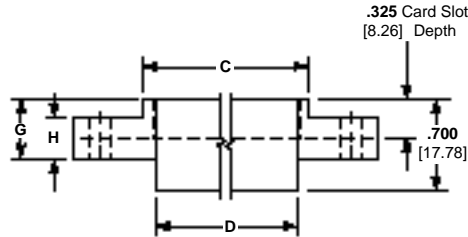
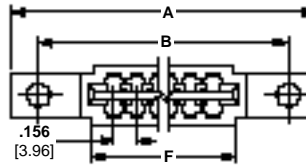

No. of Dual Positions	Dimensions										Housing Part Numbers
	A	B	C	D	E	F	G	H	J	K	
6	1.785 45.34	1.535 38.99	1.264 32.11	.976 24.79	.125 3.18	1.100 27.94	.456 11.58	.250 6.35	.300 7.62	.350 8.89	583722-1
10	2.409 61.19	2.159 54.84	1.888 47.96	1.600 40.64	.125 3.18	1.724 43.79	.456 11.58	.250 6.35	.300 7.62	.350 8.89	583723-1
12	2.721 69.11	2.471 62.76	2.200 55.88	1.912 48.56	.125 3.18	2.036 51.71	.456 11.58	.250 6.35	.300 7.62	.350 8.89	583724-1*
15	3.189 81.00	2.939 74.65	2.668 67.77	2.380 60.45	.128 3.25	2.504 63.60	.456 11.58	.250 6.35	.300 7.62	.350 8.89	583680-1
18	3.657 92.89	3.407 86.54	3.136 79.65	2.848 72.34	.125 3.18	2.972 75.49	.456 11.58	.250 6.35	.300 7.62	.350 8.89	583725-1
18	3.657 92.89	3.407 86.54	3.136 79.65	2.848 72.34	.156 3.96	2.972 75.49	.456 11.58	.250 6.35	.300 7.62	.350 8.89	583725-3
22	4.281 108.74	4.031 102.39	3.760 95.50	3.472 88.19	.125 3.18	3.596 91.34	.456 11.58	.250 6.35	.300 7.62	.350 8.89	583617-1
22	4.281 108.74	4.031 102.39	3.760 95.50	3.472 88.19	.156 3.96	3.596 91.34	.456 11.58	.250 6.35	.300 7.62	.350 8.89	583617-3
25	4.749 120.62	4.499 114.27	4.228 107.39	3.940 100.01	.125 3.18	4.064 103.23	.456 11.58	.250 6.35	.300 7.62	.350 8.89	583726-1
30	5.529 140.44	5.279 134.09	5.008 127.20	4.720 119.89	.125 3.18	4.844 123.04	.456 11.58	.250 6.35	.300 7.62	.350 8.89	583685-1
36	7.015 178.18	6.578 167.08	5.942 150.92	5.722 145.33	.156 3.96	5.782 146.86	.455 11.55	.290 7.36	.325 8.25	.437 11.10	583552-1

*CSA certification pending.

Note: Other connector sizes can be made available, consult Tyco Electronics.

Glass-Filled Phenolic Housings

Material: Glass-filled phenolic per MIL-M-14F

Related Product Data:

Card Guide Assembly—page 171

Performance Specifications—page 164

Contacts—pages 165, 166

Accessories—page 171

PC Board Layout—page 172

Technical Documents:

(pages 186, 187):

Product Specifications
108-9013, 108-9043

Application Specification
114-9003

Instruction Sheet 408-7037

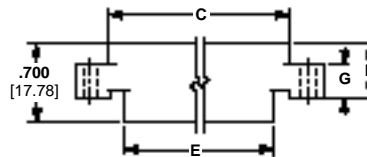
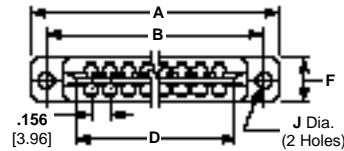

No. of Dual Positions	Dimensions										Board Thickness	Housing Part Numbers
	A	B	C	D	E	F	G	H	J			
8	1.982	1.767	1.550	1.410	1.288	.340	.250	.458	.125	.055-.070	582140-5	
	50.34	44.88	39.37	35.81	32.72	8.64	6.35	11.63	3.18	1.40-1.78		
10	2.407	2.157	1.866	1.722	1.598	.360	.250	.456	.128	.055-.070	582963-2*	
	61.14	54.79	47.90	43.74	40.59	9.14	6.35	11.58	3.25	1.40-1.78		
10	—	—	1.886	1.722	1.598	.360	—	—	—	.055-.070	583280-1 ¹	
			47.90	43.74	40.59	9.14				1.40-1.78		
15	3.182	2.854	2.621	2.506	2.376	.350	.250	.466	.187	.055-.070	480110-5	
	80.82	72.49	66.57	63.65	60.35	8.89	6.35	11.84	4.75	1.40-1.78		
15	3.182	2.854	2.621	2.506	2.376	.350	.250	.466	.125	.055-.070	1-582147-5*	
	80.82	72.49	66.57	63.65	60.35	8.89	6.35	11.84	3.18	1.40-1.78		
15	3.182	2.933	2.621	2.506	2.376	.350	.250	.466	.128	.055-.070	582500-5	
	80.82	74.49	66.57	63.65	60.35	8.89	6.35	11.84	3.25	1.40-1.78		
18	3.650	3.400	3.088	2.948	2.843	.375	.155	.406	.156	.055-.070	480133-5	
	92.71	86.36	78.43	74.87	72.21	9.52	3.93	10.31	3.96	1.40-1.78		
22	4.274	4.025	3.754	3.591	3.466	.350	.250	.456	.125	.055-.070	480142-3	
	108.56	102.24	95.35	91.21	88.04	8.89	6.35	11.58	3.18	1.40-1.78		
25	4.741	4.493	4.221	4.058	3.933	.350	.250	.456	.125	.055-.070	583167-3*	
	120.42	114.12	107.21	103.07	99.90	8.89	6.35	11.58	3.18	1.40-1.78		
32	6.365	5.928	5.292	5.132	5.072	.485	.290	.455	.187	.084-.104	582264-2,3	
	161.67	150.57	134.42	130.35	128.83	12.32	7.37	11.56	4.75	2.13-2.64		

*CSA certification pending.

¹Housing without mounting ears.

²Housing does not accommodate intercontact keying plug.

³For .086 to .104 [2.18 to 2.64] thick PC boards (special contacts required).

Note: Other connector sizes can be made available, consult Tyco Electronics.

Diallyl Phthalate Housings

Material: Diallyl phthalate per MIL-M-14F

Related Product Data:

Card Guide Assembly—page 171

Performance Specifications—page 164

Contacts—pages 165, 166

Accessories—page 171

PC Board Layout—page 172

Technical Documents:

(pages 186, 187):

Product Specifications
108-9013, 108-9043

Application Specification
114-9003

Instruction Sheet 408-7037

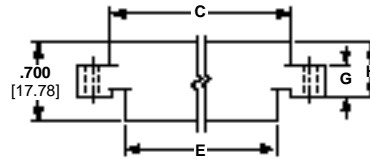
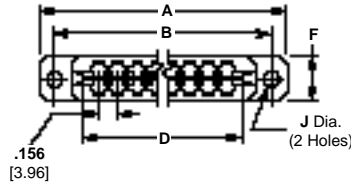

Single Slot Housing

No. of Dual Positions	Dimensions										Board Thickness	Housing Part Numbers
	A	B	C	D	E	F	G	H	J			
15	3.187	2.859	2.625	2.510	2.380	.350	.250	.466	.187	.055-.070	480110-2	
	80.95	72.62	66.68	63.75	60.45	8.89	6.35	11.84	4.15	1.40-1.78		
15	3.187	2.938	2.625	2.510	2.380	.350	.250	.466	.128	.055-.070	582500-2	
	80.95	74.63	66.68	63.75	60.45	8.89	6.35	11.84	3.25	1.40-1.78		
18	3.656	3.406	3.093	2.953	2.848	.375	.155	.406	.156	.055-.070	480133-2	
	92.86	86.51	78.56	75.01	72.34	9.53	3.94	10.31	3.96	1.40-1.78		
22	4.281	4.031	3.760	3.596	3.472	.350	.250	.456	.125	.055-.070	480142-2	
	108.74	102.39	95.90	91.34	88.19	8.89	6.35	11.58	3.18	1.40-1.78		

Note: Other connector sizes can be made available, consult Tyco Electronics.

AMP-LEAF Connectors, .156 [3.96] Centerline (Continued)

Housings Preloaded with Right-Angle Post Contacts

Material and Finish:

Housing—See chart below

Contacts—Phosphor bronze, plated .000015 [0.00038] min. gold in mating area, with entire contact underplated .000050 [0.00127] min. nickel

Post—Phosphor bronze, tin plated

Retaining Spring—Stainless steel

Related Product Data:

Card Guide Assembly—page 171

Performance Specifications—page 164

Accessories—page 171

PC Board Layout—page 172

Technical Documents:

(pages 186, 187):

Product Specification
108-9013

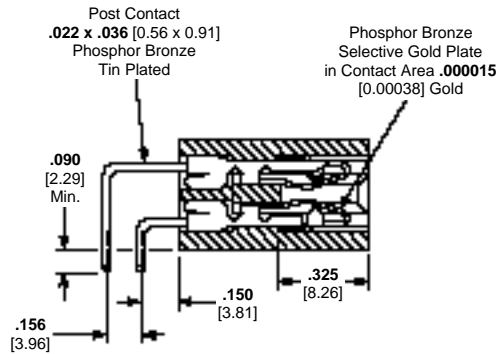
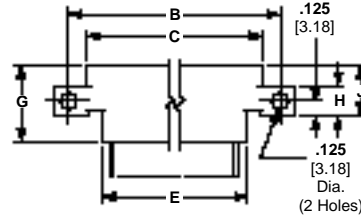
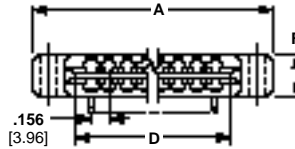

No. of Dual Positions	Dimensions									Part Numbers	Housing Material
	A	B	C	D	E	F	G	H	J		
10	2.407	2.157	1.886	1.722	1.598	.360	.700	.250	.456	583599-1*	
	61.14	54.79	47.9	43.74	40.59	9.14	17.78	6.35	11.58		
15	3.182	2.933	2.621	2.506	2.376	.350	.700	.250	.466	583545-1*	Glass-Filled Phenolic
	80.82	74.5	66.57	63.65	60.35	8.89	17.78	6.35	11.84		
18	3.650	3.400	3.088	2.948	2.843	.375	.700	.250	.406	583544-1*	
	92.71	86.36	78.44	74.88	72.21	9.53	17.78	6.35	10.31		
22	4.274	4.025	3.754	3.591	3.466	.350	.700	.250	.456	583458-2*	Glass-Filled Phenolic
	108.56	102.24	95.35	91.21	88.04	8.89	17.78	6.35	11.58		
28	4.281	4.031	3.760	3.596	3.472	.350	.700	.250	.456	583975-1*	Glass-Filled Polyester
	108.74	102.39	95.50	91.34	88.19	8.89	17.78	6.35	11.58		
28	5.270	4.961	4.680	4.527	4.402	.350	.700	.250	.456	530061-1*	Glass-Filled Phenolic
	133.86	126.01	118.87	114.99	111.81	8.89	17.78	6.35	11.58		

*CSA certification pending.

- Notes:** 1. Other connector sizes can be made available, consult Tyco Electronics.
2. Finished hole size is .048-.054 [1.22-1.37] diameter.

AMP-LEAF Connector Accessories

Keying Plugs

Material: Nylon

Technical Documents:

(pages 186, 187):
Instruction Sheets 408-7036,
408-7037, 408-7068, 408-7339

Commoning Springs

Material and Finish:

Beryllium copper, gold plated

Technical Documents:

(pages 186, 187):
Instruction Sheet 408-7419

Retaining Springs

Material: Stainless steel

Technical Documents:

(pages 186, 187):
Instruction Sheets 408-7035,
408-7037

Card Guides

Material: Glass-filled nylon, black

Technical Documents:

(pages 186, 187):
Instruction Sheets 408-7557,
408-7565

On-Contact Keying Plug

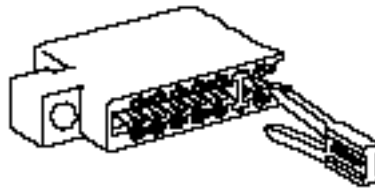

.055-.070 [1.4-1.78] Board Thickness—Part No. 480143-1

Intercontact Keying Plugs



.040 [1.02] Wide—Part No. 582501-1
.025 [0.64] Wide—Part No. 583274-1



.055-.070 [1.4-1.78] thk. PC board—Part No. 66092-1

.055-.070 [1.4-1.78] and
.084-.104 [2.13-2.64] thk. PC board with locking latches—
Part No. 583454-1



Nickel Finish—Part No. 42973-1
Plain Finish—Part No. 42973-2
Gold Finish—Part No. 42973-3

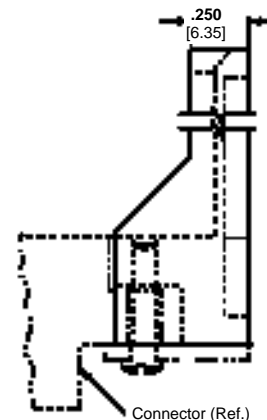
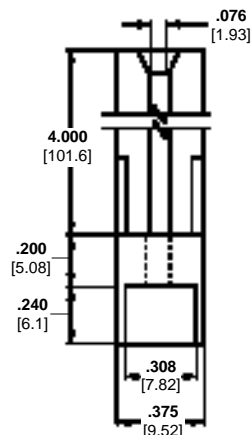
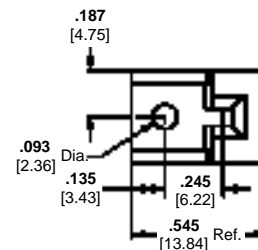

Card Guide Part Number 583760-1

Note: Card guides may be used with all connector housings having mounting ears.

AMP-LEAF Connector PC Board Layouts

**Recommended
PC Board Layouts**

Technical Documents:

(pages 186, 187):

Instruction Sheet 408-7037

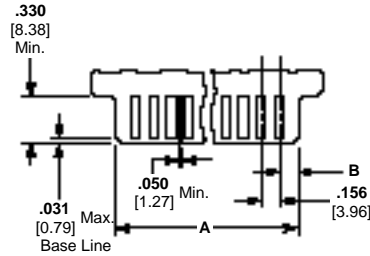

Note: Slot for intercontact keying may be located between any two pads (except the first two and last two pads).

No. of Positions	Housing Material	Dimensions	
		A	B
8	P	1.396	.152
		35.46	3.86
10	P	1.709	.151
		43.40	3.84
15	DP	2.491	.153
	P	63.27	3.89
18	DP	2.487	.152
		63.17	3.86
22	DP	2.940	.144
		74.68	3.66
25	P	3.583	.153
		91.00	3.89
32	P	3.578	.151
		90.88	3.84
32	P	4.043	.150
		102.69	3.81
32	P	5.117	.140
		129.97	3.56

DP = Diallyl Phthalate

P = Phenolic

Note: Board thickness **.055-.070** [1.4-1.78] all positions except 32 position—**.084-.104** [2.13-2.64].

High Current Connectors

Product Facts

- High current capability up to 30 amperes*
- UL rated 94V-0 glass-filled thermoplastic housings
- Choice of wire-to-board and board-to-board (solder tail) connector configurations in 3, 4, 8, 9, 10 and 12 contact sizes
- Heavy duty contacts made of high conductivity copper alloy with tin-over-nickel plating
- Contacts on .312 [7.92] centers
- Large redundant areas of contact provide excellent electrical continuity
- Connectors available for mating with .062 [1.57], .093 [2.36] and .125 [3.18] thick double-sided PC boards
- Contacts furnished in strip form for automatic machine termination and loose form for hand tool application
- Recognized under the Component Program of Underwriters Laboratories Inc. File No. E28476
- Certified by Canadian Standards Association File No. LR 7189

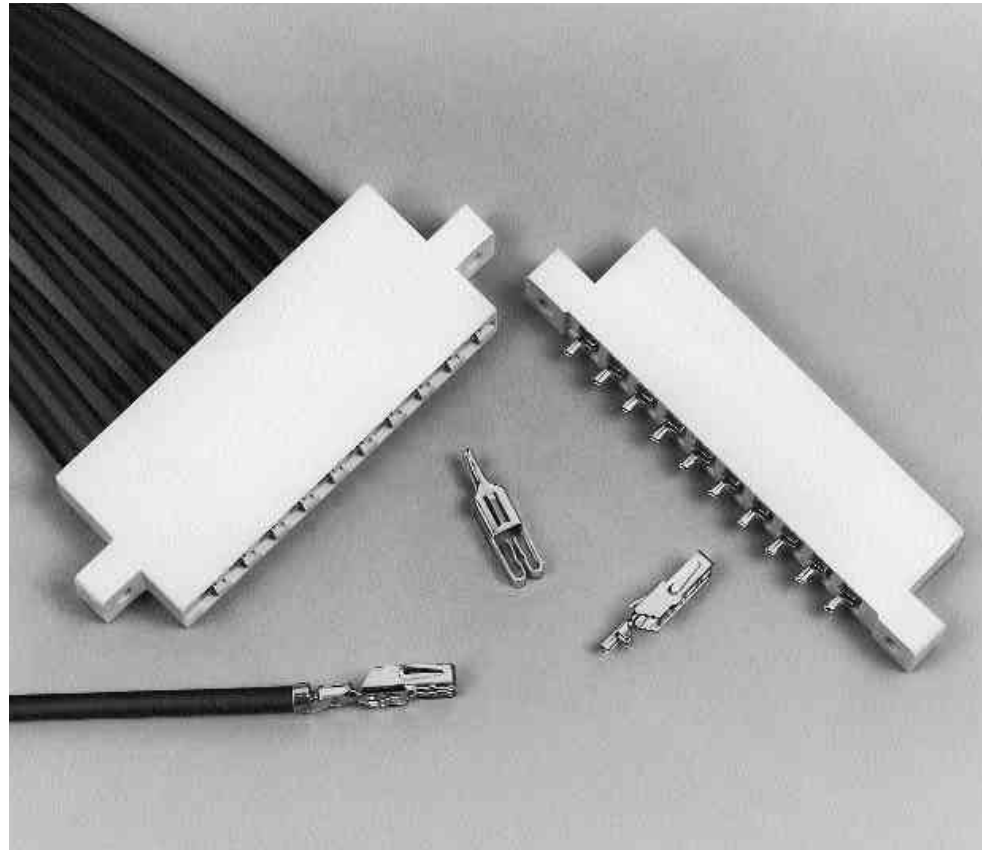

AMP High Current Edge Connectors are an economical answer to the costly issue of interconnecting high current printed circuitry. Designed for a current capability of up to 30 amperes*, these connectors feature UL rated 94V-0, rugged glass-filled thermoplastic housings and high conductivity copper alloy contacts with bright tin-over-nickel plating. Contacts are on .312 [7.92] centers.

Connectors are available in 3, 4, 8, 9, 10 and 12 contact positions and in a choice of two styles for board-to-board and wire-to-board applications.

The board-to-board connectors are supplied preloaded with solder tail contacts and are designed to mate with .062 [1.57] thick double-sided daughter boards.

Wire-to-board housings are available with and without mounting ears and with capabilities of mating with .062 [1.57], .093 [2.36] and .125 [3.18] thick double-sided daughter boards. These housings are designed to accept crimp, snap-in contacts which can accommodate a wire size range of 16-10 AWG [1.25-6 mm²]. Contacts are furnished in strip form for automatic machine termination and in loose form for hand tool application.

While the basic contact is designed to carry 30 amperes* of current, the actual number of contacts in a connector carrying 30 amperes is limited by the "T" rise of the connector and the PC board.

Performance Specifications

- Contact Current Rating*:**
30 amperes, max.
- Dielectric Withstanding Voltage (Sea Level):**
1800 VAC
- Operating Voltage:**
250 VAC, max.
- Insulation Resistance:**
1000 megohms, min.
- Contact Resistance @ 30 amperes:**
2 milliohms, max.
- Operating Temperature:**
-40°C to +95°C
- Contact Engagement Force:**
40 oz. [11.12 N], max.

***When used with a .180 [4.57] wide double-sided PC board with 5 oz. [0.14 Kg] min. copper each side. Consult Tyco Electronics engineering when paralleling contacts for power applications.**

High Current Connectors (Continued)

Crimp, Snap-In Contacts

Material and Finish:

A—Copper alloy CDA-195 plated
.000150 [0.00381] bright tin over
.000030 [0.00076] nickel
B—Copper alloy CDA-195 plated
.000150 [0.00381] silver all over

Related Product Data:

Performance Specifications—
page 173

Connector Housings—page 175

Application Tooling—pages 184, 185

Technical Documents:

(pages 186, 187):

Product Specification
108-9045

Application Specification
114-9005

Instruction Sheets 408-7782,
408-7783, 408-7802

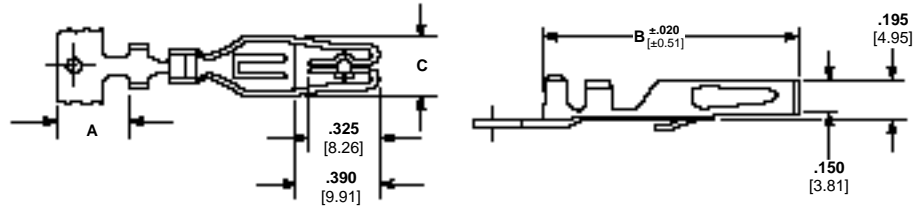

Plating	Wire Size Range		Ins. Dia. Range	Dimensions			Mateable Daughter Board Thickness	Contact Part Numbers		Applicator for AMP-O-LECTRIC Machine	Hand Tool 69710-1 Die Insert
	AWG	mm ²		A	B	C		Loose Piece	Strip Form		
A	16-14	1.25-2	.090-.145 2.29-3.68	.260 6.60	1.160 29.46	.285 7.24	.062 1.57	530518-1	530517-2	466439-2	90333-1
A	12-10	3-6	.160-.210 4.06-5.33	.190 4.83	1.230 31.24	.285 7.24	.062 1.57	530520-1	530519-2	466438-2	90332-1
B	12-10	3-6	.160-.210 4.06-5.33	.190 4.83	1.230 31.24	.285 7.24	.062 1.57	—	530519-3	466438-2	90332-1
A	12-10	3-6	.160-.210 4.06-5.33	.190 4.83	1.230 31.24	.347 8.81	.093 2.36	—	531373-2	466438-2	90332-1

*Applicators are for AMP-O-LECTRIC Model "K" machines. Consult Tyco Electronics for applicators for other bench machines and lead-making machines.



**Hand Crimping Tool
69710-1**



**Extraction Tool
91116-1**

High Current Connectors, .312 [7.92] Centerline

Housings

With Mounting Ears

Material: White glass-filled polyester, 94V-0 rated

Related Product Data:

Performance Specifications—
page 173

Contacts—page 174

Technical Documents:

(pages 186, 187):

Product Specification

108-9045

Instruction Sheet 408-9123

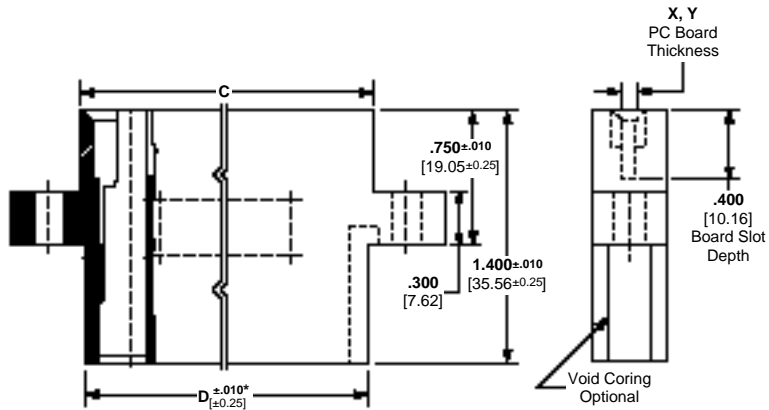
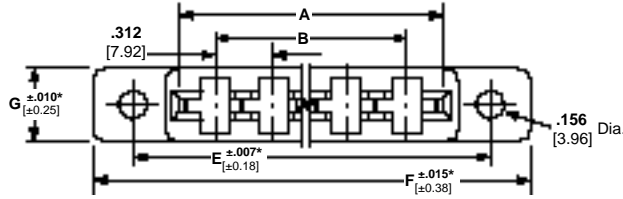

No. of Pos.	Dimensions							Housing Part Numbers	
	A	B	C	D	E	F	G	X = .062 [1.57]	Y = .093 [2.36]
								With Mtg. Ears	With Mtg. Ears
3	1.024 26.01	.624 15.85	1.164 29.57	1.114 28.3	1.538 39.07	1.972 50.09	.500 12.70	—	531370-2
4	1.336 33.93	.936 23.77	1.476 37.49	1.426 36.22	1.850 46.99	2.284 58.01	.437 11.10	530521-3	—
8	2.584 65.63	2.184 55.47	2.724 69.19	2.674 67.92	3.098 78.69	3.532 89.71	.437 11.10	530521-6	—
9	2.896 73.56	2.496 63.40	3.036 77.11	2.986 75.84	3.410 86.61	3.844 97.64	.437 11.10	530521-7	—
12	3.832 97.33	3.432 87.17	3.972 100.89	3.922 99.62	4.346 110.39	4.780 121.41	.437 11.10	530521-9	—

- Notes:**
1. X Housings designed to accept .055-.070 [1.4-1.78] thick daughter boards; use intercontact Keying Plug No. 530533-1.
 2. Y Housings designed to accept .084-.102 [2.13-2.59] thick daughter boards; use intercontact Keying Plug No. 531369-1. + Contact 531373-2.
 3. Use Extraction Tool No. 91116-1 to remove contacts. (Refer to Instruction Sheet 408-7782).
 4. Other connector sizes can be made available, consult Tyco Electronics.

High Current Connectors .312 [7.92] Centerline (Continued)

Housings Preloaded with Solder Tail Contacts

Material and Finish:

Housing—White glass-filled polyester, 94V-0 rated

Contacts—

A—Copper alloy CDA-195 plated .000150 [0.00381] bright tin over .000030 [0.00076] nickel

B—Copper alloy CDA-195 plated .000150 [0.00381] silver plate over .000030 [0.00076] thk. nickel

C—Copper alloy CDA-195 plated .000030 [0.00076] gold in contact area, .000150 [0.00381] tin-lead solder post, over .000030 [0.00076] nickel

Related Product Data:

Performance Specifications— page 173

Technical Documents:

(pages 186, 187):

Product Specification
108-9045

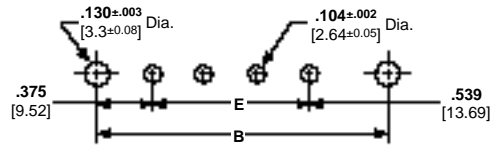
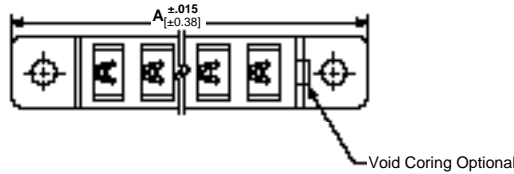
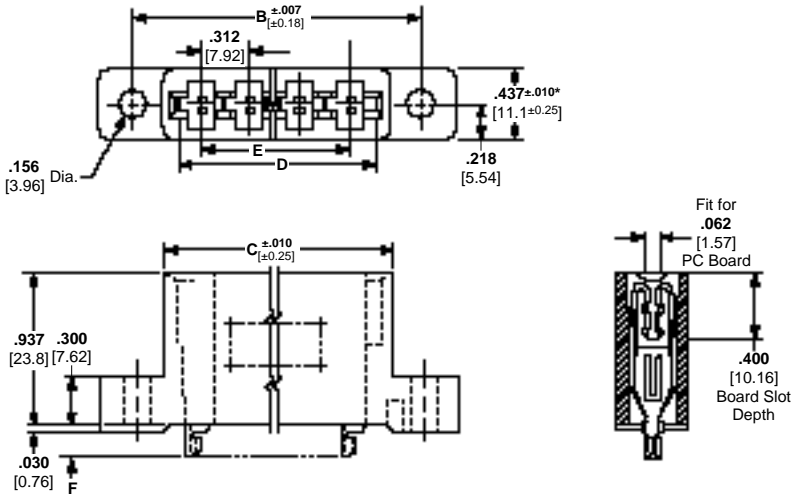

PC Board Thickness: .062 [1.57]

Recommended PC Board Hole Layout



*May go to .020 [0.51] over nominal at top center of housing.

No. of Positions	Dimensions						Plating	Connector Part Numbers
	A	B	C	D	E	F		
3	1.972	1.538	1.164	1.024	.624	.180	A	531353-2
	50.09	39.07	29.57	26.01	15.85	4.57		
4	2.284	1.850	1.476	1.336	.936	.180	A	531353-3
	58.01	46.99	37.49	33.93	23.77	4.57		
5	2.593	2.162	1.788	1.648	1.248	.180	A	531353-4
	65.86	54.91	45.42	41.86	31.70	4.57		
6	2.908	2.474	2.100	1.960	1.560	.180	A	531353-5
	73.86	62.84	53.35	49.78	39.62	4.57		
8	3.532	3.098	2.724	2.584	2.184	.180	A	531353-6
						4.57		
	89.71	78.69	69.19	66.63	55.47	.283	B	146912-2
						7.19		
9	3.844	3.410	3.036	2.896	2.496	.180	A	531353-7
						4.57		
10	4.156	3.722	3.348	3.208	2.808	.180	A	531353-8
						4.57		
	105.56	94.54	85.04	81.48	71.32	.283	B	146912-3
						7.19		
12	4.780	4.346	3.972	3.832	3.432	.180	A	531353-9
						4.57		
	121.41	110.39	100.89	97.33	87.17	.283	B	146912-1
						7.19		

Notes: 1. A .062 [1.57] thick dummy PC board should be inserted into the connector during soldering to a mother board.
2. Other connector sizes can be made available, consult Tyco Electronics.

DUO-TYNE Flag Connectors

Product Facts

- Right angle design permits cabling in close quarters
- Recessed contacts help prevent arcing
- Sizes and configurations available with or without mounting ears
- Lowest installed costs achieved through high-speed compression crimping with AMP matched tooling
- Meets quality and reliability requirements for appliance controls, vending machine subassemblies and business machines
- Recognized under the Component Program of Underwriters Laboratories Inc. File No. E28476 
- Certified by Canadian Standards Association File No. LR 7189 



This flag-type connector is designed to meet the quality and reliability of such equipment as appliance controls, vending machine subassemblies, television, stereo, business machines and other applications with similar control needs.

Among its assembly-saving features is a right-angle design which permits cabling in close quarters, where it does not require frame mounting to attach

the keyed housing to the card cutout and double locking of the contacts when a PC board is inserted. In addition, contacts are recessed to prevent arcing. All sizes and configurations are available with or without mounting ears. Added to low initial cost, lowest installed costs are achieved through high-speed compression crimping with Tyco Electronics matched tooling.

Performance Specifications

Contact Rating*:
5 amperes

High Potential:
2200 VAC, rms

Operating Temperature:
-40°C to +105°C

Vibration:
10 to 55 cps per MIL-STD-1344, Method 202

*Consult Tyco Electronics engineering when paralleling contacts for power applications.

DUO-TYNE Flag Connectors (Continued)

Tapered Beam Crimp, Snap-In Contacts

Material and Finish:

Beryllium copper or phosphor bronze (see chart) plated as follows:

Plating A—.000030 [0.00076] gold in mating area, with entire contact under-plated .000050 [0.00127] nickel

Plating B—.000015 [0.00127] gold in mating area, with entire contact under-plated .000050 [0.00127] nickel

Plating C—.000150 [0.00381] tin

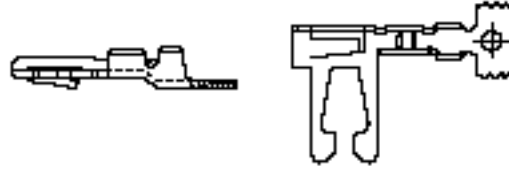

Related Product Data:

Performance Specifications—page 177

Connector Housings—page 179

Application Tooling—pages 184, 185

Technical Documents:

(pages 186, 187):

Product Specification 108-9038

Application Specification 114-9002

Instruction Sheets 408-7047, 408-7780, 408-7848, 408-7849

Wire Size Range		Insulation Dia. Range	Material	Contact Finish (Plating)	Contact Part Numbers		Applicator for AMP-O-LECTRIC Machine*	Hand Tool
AWG	mm ²				Loose Piece	Strip Form		
26-22	0.12-0.4	.035-.055 0.89-1.40	Beryllium Copper	A	530005-3	530004-6	466586-2	90094-4
				B	—	530004-7		
				B	—	530002-7		
22-18	0.3-0.9	.060-.090 1.52-2.29	Phosphor Bronze	C	—	530002-5	466424-2	90027-4
				A	—	530002-3		
				C	—	530006-5		
18-16	0.8-1.4	.090-.130 2.29-3.30	Beryllium Copper	A	—	530006-6	466413-2	—
				B	530007-3	—		
				C	—	530006-2		
18-16	0.8-1.4	.090-.130 2.29-3.30	Phosphor Bronze	C	—	530505-5	466413-2	—

*Applicators are for AMP-O-LECTRIC Model "K" machines. Consult Tyco Electronics for applicators for other bench machines and lead-making machines.

Hand Crimping Tool



Contact Extraction Tool 810992-1



DUO-TYNE Flag Connectors (Continued)

Housings, With and Without Mounting Ears

Material: Natural nylon

Related Product Data:

Performance Specifications—page 177

Contacts—page 178

PC Board Layout—page 181

Technical Documents:

(pages 186, 187):

Product Specification 108-9038

Application Specification 114-9002

Instruction Sheet 408-7047

On-Contact Keying Plug

Material: Nylon

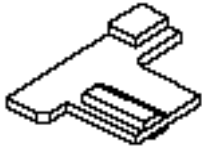

Part Number 583661-1

Technical Documents:

(pages 186, 187):

Instruction Sheet 408-7486

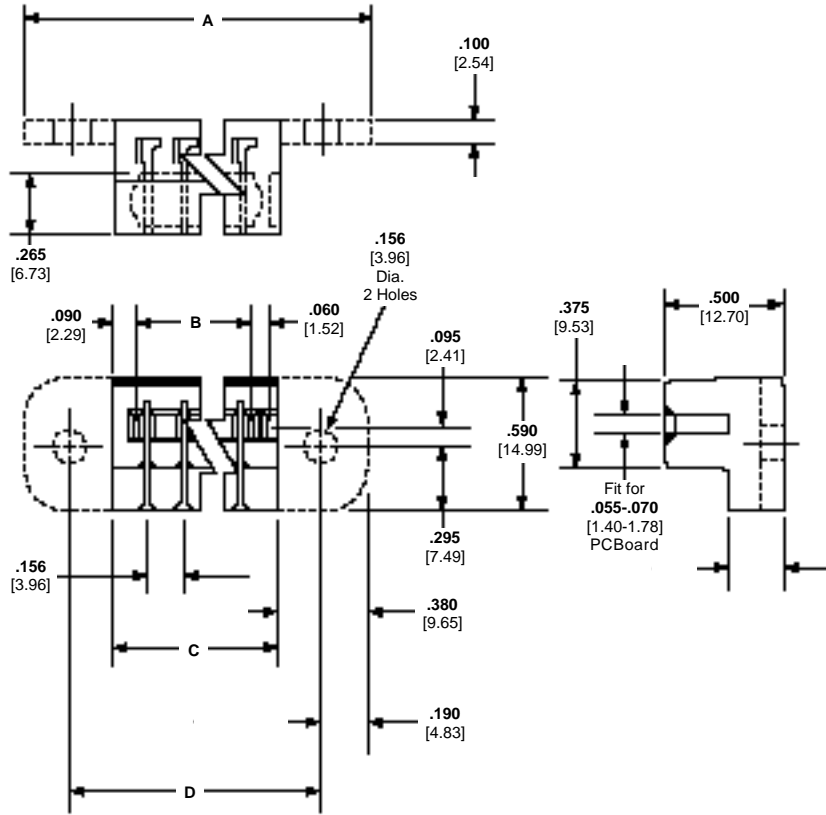

No. of Pos.	Dimensions				Part Numbers			
					With Mounting Ears		Without Mounting Ears	
	A	B	C	D	For Ins. Dia. Range	For Ins. Dia. Range	For Ins. Dia. Range	For Ins. Dia. Range
3	1.384 35.15	.414 10.52	.624 15.85	1.004 25.50	582380-9	—	—	—
5	—	.736 22.40	.936 27.74	—	—	—	582370-9	530853-2
6	1.852 47.04	.882 22.40	1.092 27.74	1.472 37.39	582382-9	530509-1	582371-9	530853-3
9	2.320 58.93	1.350 34.29	1.560 39.62	1.940 49.28	582383-9	530509-2	582375-9	—
12	2.788 70.82	1.818 46.18	2.028 51.51	2.408 61.16	582384-9	530509-6	582376-9	530853-5
14	3.100 78.74	2.130 54.10	2.340 59.44	2.720 69.09	582385-9	530509-7	582372-9	530853-6
15	3.256 82.70	2.286 58.06	2.496 63.40	2.876 73.05	582386-9	530509-3	582377-9	—
18	3.724 94.59	2.754 69.95	2.964 75.29	3.344 84.94	582387-9	530509-8	582378-9	530853-8
22	4.348 110.44	3.378 85.80	3.588 91.14	3.968 100.79	582388-9	530509-9	582379-9	—

Note: Other connector sizes can be made available, consult Tyco Electronics.

DUO-TYNE Flag Connectors (Continued)

Recommended PC Board Layouts

Related PC Board Data:

Recommended Board Thickness—
.055-.070 [1.40-1.78]

Recommended Chamfer of Mating Edge of Boards—.015 [0.38] x 45°

Recommended Pad Plating—Tin
.000150-.000400 [0.00381-0.01016]
thick

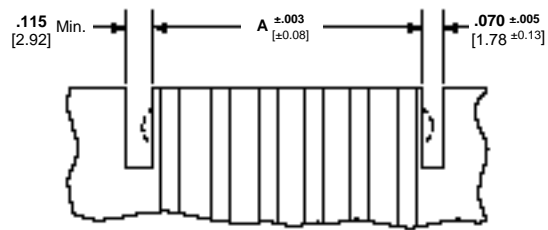
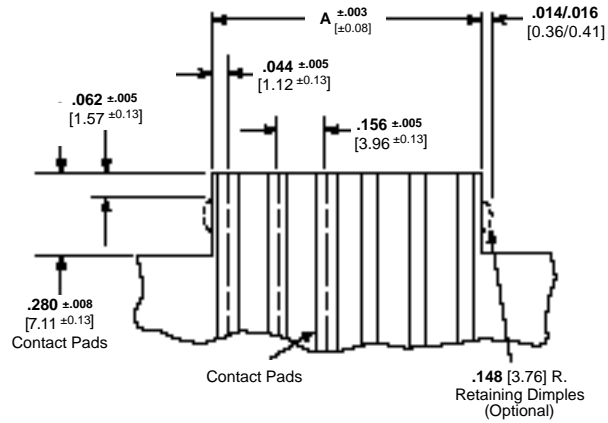

No. of Positions	Dimension A
3	.400 10.16
5	.712 18.09
6	.868 22.05
9	1.337 33.96
12	1.805 45.85
14	2.117 53.77
15	2.272 57.71
18	2.741 69.62
22	3.365 85.47

Printed Circuit Board Connector Hood Assemblies

Product Facts

- Can be used with the highly versatile AMP-LEAF and Crimp Snap Twin Leaf printed circuit edge connectors
- Clamping capabilities for wire bundles to .550 [13.97] maximum diameter
- Available with 90° or 180° cable outlet
- All plastic construction—thermoplastic material UL rated 94V-0 for electrical and mechanical applications up to + 105°C
- Thermoplastic material has excellent resistance to common commercial cleaners when used at moderate temperatures
- Separate hood assembly halves permit easy cable dressing
- Furnished in convenient kit form—each kit includes four cable clamp sizes

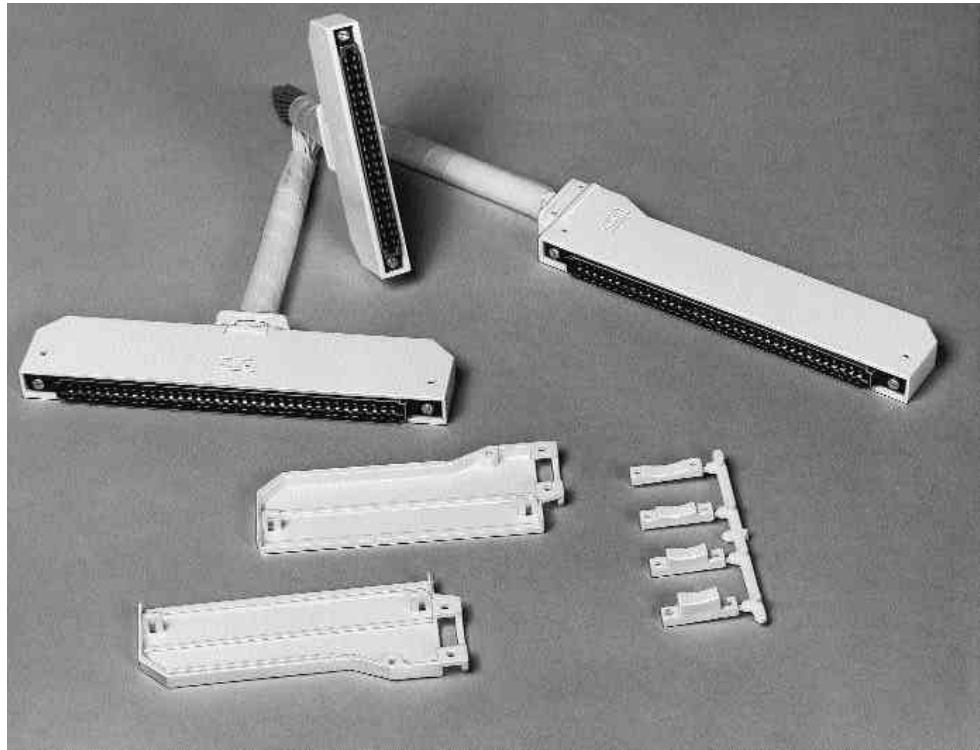

For use with the following connectors:

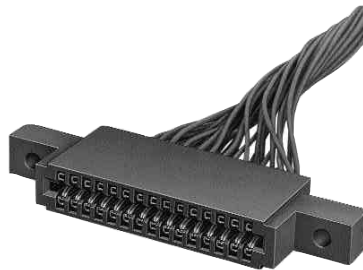

Crimp Snap Twin Leaf Connectors
(Pages 154-163)

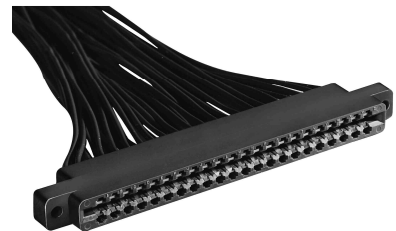

AMP-LEAF Connectors
(Pages 164-172)

90° Cable Outlet

Material: Natural color thermoplastic

Related Product Data:

Crimp Snap Twin Leaf Connectors—pages 154-163

AMP-LEAF Connectors—pages 164-172

Technical Documents:
(pages 186, 187):

Instruction Sheet 408-7719

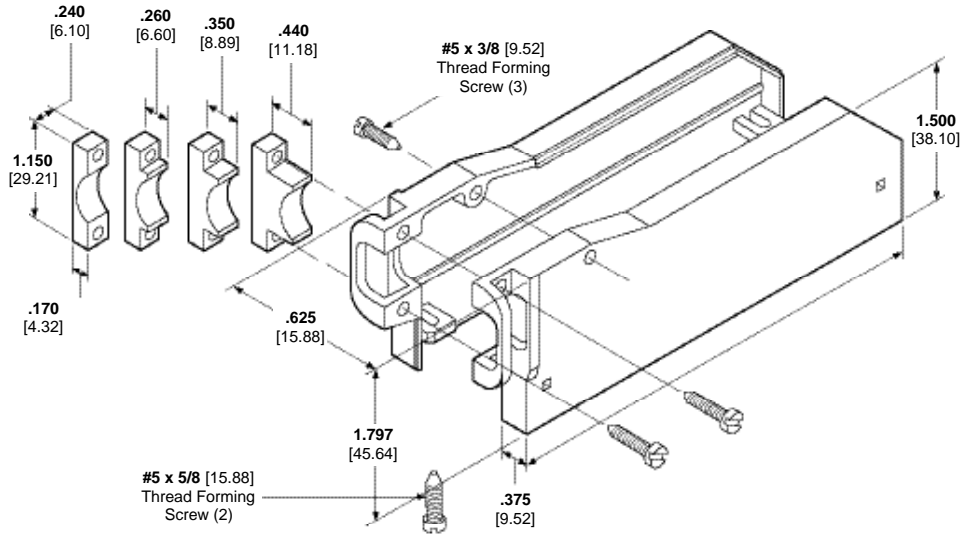

No. of Contact Pos.	Connector Size			Hood L Dim. (Max.)	Connector Width .380 [9.65] Max.		Connector Width .437 [11.10]	
	Contact Centers	Mtg. Hole Centers	Length (Max.)		AMP Connector Family	Hood Assembly Kit Number*	AMP Connector Family	Hood Assembly Kit Number*
18	1.56 3.96	3.406 86.51	3.685 93.60	3.826 97.18	AMP-LEAF	530088-3	—	—
22	.156 3.96	4.031 102.39	4.296 109.12	4.451 113.06	—	—	Crimp Snap Twin Leaf	1-530088-4

*All screws and four sizes of cable clamps are supplied with each kit.

Note: Other hood sizes can be made available, consult Tyco Electronics.

Printed Circuit Board Connector Hood Assemblies (Continued)

180° Cable Outlet

Material: Natural color thermoplastic

Related Product Data:

AMP-LEAF Connectors—
pages 164-172

Technical Documents:

(pages 186, 187):
Instruction Sheet 408-7719

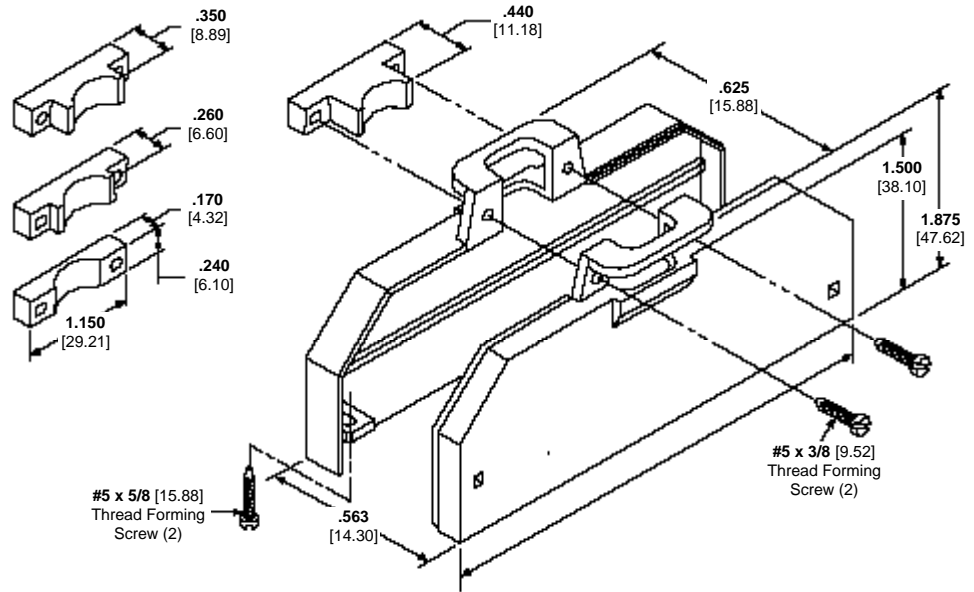

No. of Pos.	Connector Size			Hood L Dim. (Max.)	Connector Width .380 [9.65] Max.	
	Contact Centers	Mtg. Hole Centers	Length (Max.)		AMP Connector Family	Hood Assembly Kit Number*
22	.156 3.96	4.031 102.39	4.321 109.76	4.451 113.06	AMP-LEAF	530087-4

*All screws and four sizes of cable clamps are supplied with each kit.

Note: Other hood sizes can be made available, consult Tyco Electronics.

Application Tooling for Wire Crimp Contacts

Tooling shown on this page is designed to terminate wire crimp contacts used in various wire-to-board connectors.

**AMP-O-LECTRIC Model "G" Terminating Machine
(Shown with Optional Crimp Quality Monitor)**



The AMP-O-LECTRIC Model "G" is a semi-automatic bench-top machine for terminating wire using reeled terminals and contacts. It features a quiet and reliable direct motor drive, micro-processor controls for ease of setup and operation, and guarding and lighting designed for operator convenience and safety. Three versions are available: with

automatic precision adjust and machine-mounted sensors, or with manual precision adjust with or without sensors. All versions will accept existing Tyco Electronics ministyle applicators with minor modifications.

For further details, request Tyco Electronics Catalog 65828.

**AMP-O-MATIC Model II Stripper/Crimper Machine
(Shown with Optional Crimp Quality Monitor)**



This machine also strips wire, and is therefore used to terminate jacketed cable. It features manual precision adjust, keyed strip blades for faster, more accurate setups, and an efficient scrap removal system. Applicators are interchangeable. All adjustments can be made from the front of the machine without special tools.

Entry Level Terminator (ELT), 1338600-(x)

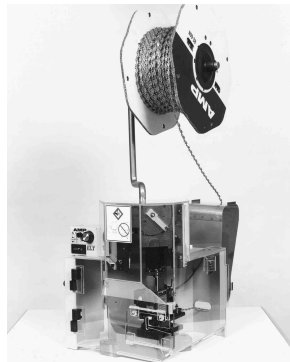

Semiautomatic Bench Terminator for side- and end-feed reeled terminals and contacts. The ELT uses a DC motor with gear box drive. The result is a small-footprint design that is fast and quiet. Cycle time is less than 0.400 sec. with an operation sound level of 76dBa. With a crimp force capacity of 3,000 pounds, the ELT is available for all

but the highest crimp force applications. Optional equipment is also available to meet your specific application requirements.

For more information, request catalog 1308382.

Optional Stripping Module for the ELT and AMP-O-LECTRIC Model G

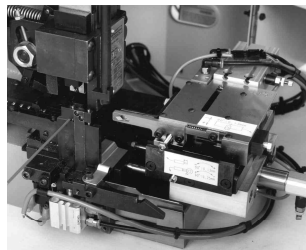

The combination of the Stripping Module with the AMP-O-LECTRIC Model G Terminator or the Entry Level Terminator provides an economical, proficient method of stripping wire and crimping terminals on the same machine. Wires are stripped moments before crimping, meaning there is virtually no chance

of damaging wire conductors during handling or storage. Once the wire is fed into the start sensor the Stripping Module does the rest, improving placement accuracy.

For more information, request catalog 1309085.

Application Tooling for Wire Crimp Contacts (Continued)

**AMPOMATOR CLS IV+
Lead-Making Machines, 356500-1, -2**



Fully-automatic machines that measure, cut, strip and terminate single leads. Microprocessor-controlled, and programmed and operated using an easy-to-follow, menu-driven touchscreen. Features include direct-drive terminating units with precision crimp height adjustment, fully programmable setups,

wire runout and splice detection, and motorized pre-feed with wire straightener. Crimp quality monitoring is also available. For more information, request catalog 124324.

Crimp Quality Monitor (CQM), 1320420-1, -2



This unique system provides 100% on-the-fly crimp inspection. It measures the crimp height of each termination, and evaluates the quality of each crimp. If a crimp is questionable, the monitor alerts the operator with both visual and audible alarms. It also provides ports for printing and networking. When used with

AMP-O-LECTRIC Model "G" Termination Machines, the monitor is mounted to the machine. When used with AMPOMATOR CLS IV Lead-Making Machines, it is integrated into the machine's operating system. For more information, request catalog 82275.

CERTI-CRIMP Straight Action Hand Tools (SAHT)



Premium grade hand tools. Feature ratchet control to provide complete crimp cycle. Die sets close in a straight line. Include a contact locator and wire stop, plus an insulation crimp adjustment lever, when applicable. Approximate weight 1.3 lb [0.59 kg].

For more information, request catalog 65780.

626 Pneumatic Tool System



Lightweight, air-operated modular tooling system. Accepts a wide variety of interchangeable heads for crimping various types of contacts, terminals and splices onto wires ranging 6-26 AWG [13-0.12 mm²], plus coaxial and fiber optic cable. Available with either hand- or foot-actuation switch. Optional ratchet

control available to provide complete crimp cycle. For more information, request catalog 124208.

The following is a list of technical documents covering the application, performance and maintenance of the AMP Card Edge Connectors presented in this catalog.

Product Specifications describe technical performance characteristics and verification tests. They are intended for the Design, Component and Quality Engineer.

Application Specifications describe requirements for using the product in its intended application and/or crimping information. They are intended for the Packaging and Design Engineer and the Setup person.

Instruction Sheets provide instructions for assembling or applying the product. They are intended for the Manufacturing Assembler or Operator.

Solder Type Board-to-Board Connectors

Standard Edge .050 Series PCI Connectors

Product Specification:

108-14034 Standard Edge .050 Series PCI Connector

Application Specification:

114-26012 Standard Edge .050 Series PCI Connector

Standard Edge .050 Series Connectors

Product Specification:

108-14034 Standard Edge .050 Series Connector

Application Specification:

114-26012 Standard Edge .050 Series Connector

Standard Edge II Connectors

Product Specification:

108-9039 Standard Edge II Connector

Low Profile Connectors

Product Specification:

108-9044 Low Profile Edge Connector

Instruction Sheet:

408-7772 Contact Replacement, Low Profile Edge Connector

Twin Leaf Mother Board Connectors

Product Specification:

108-9027 Twin Leaf Mother Board Connector

Instruction Sheets:

408-7479 Keying Plugs, Twin Leaf Mother Board Connector

408-7498 Connector Layout, Twin Leaf Mother Board Connector

408-7506 Card Guides, Twin Leaf Mother Board Connector

Rotary Cam ZIF Connectors

Product Specification:

108-9048 Rotary Cam PC Board Edge Connector

Instruction Sheet:

408-7911 Rotary Cam ZIF Connectors

Linear ZIF Connectors

Product Specifications:

108-14015 Linear ZIF PC Board Edge Connector, .100 [2.54] Centerline

108-26003 ACTION PIN Contacts

Application Specification:

114-26003 Linear ZIF PC Board Edge Connector, .100 [2.54] Centerline

Instruction Sheets:

408-2665 Linear ZIF, Carrier Removal Tool Series 265924

408-2995 Linear ZIF, Housing Wing Removal and Replacement Tool 266233-1

408-2999 Linear ZIF, T-Bar Insertion Tool Series 266267

408-6915 Linear ZIF, Housing Assembly Insertion Tool Series 313136

408-6916 Linear ZIF, T-Bar Insertion Tool Series 313139

Press-Fit Board-to-Board Connectors

AMP PACE Connectors

Product Specifications:

108-14019 AMP PACE Connector, .125 x .250 [3.18 x 6.35] Centerline

108-26003 ACTION PIN Contacts

Application Specification:

114-26002 AMP PACE Connector

Instruction Sheets:

408-2933 Contact Replacement Tool .100 x .200 [2.54 x 5.08] and .125 x .250 [3.18 x 6.35], AMP PACE Connector

408-2978 Seating Tool Ground Module, AMP PACE Connector

408-2979 Seating Tool Power Module, AMP PACE Connector

408-6726 Seating Tool, .156 x .200 [3.96 x 5.08] Part No. 59955, AMP PACE Connector

408-6727 Seating Tool, .125 x .125 [3.18 x 3.18] Part No. 59953, AMP PACE Connector

408-6881 Contact Replacement Tool .100 x .100 [2.54 x 2.54] with and without Scoops AMP PACE Connector

408-9058 Seating Tool .100 x .200 [2.54 x 5.08] with Card Scoops, Part No. 58150, AMP PACE Connector

408-9063 Seating Tool .125 x .250 [3.18 x 6.35] Part No. 58142, AMP PACE Connector

408-9067 Seating Tool .100 x .200 [2.54 x 5.08] Part No. 58140, AMP PACE Connector

408-9091 Accessories and Tooling, .100 x .200 [2.54 x 5.08] AMP PACE Connector

408-9119 Seating Tool, .125 x .250 [3.18 x 6.35] with Card Scoops, Part No. 58184, AMP PACE Connector

408-9186 Contact Replacement Tool; .100 x .200 [2.54 x 5.08], .125 x .125 [3.18 x 3.18], .125 x .250 [3.18 x 6.35] with Scoops, .156 x .200 [3.96 x 5.08], AMP PACE Connector

408-9188 Seating Tool .100 x .100 [2.54 x 2.54] Part No. 58200, AMP PACE Connector

ECONOMATE Connectors

Product Specification:

108-26002 ECONOMATE Connector

Instruction Sheet:

408-9091 Accessories and Tooling, .100 x .200 [2.54 x 5.08] AMP PACE Connector

Wire-to-Board Connectors

Crimp Snap Twin Leaf Connectors

Product Specification:

108-9031 Crimp Snap Twin Leaf Connector (Bifurcated Contacts)

Application Specification:

114-9004 Contact, Twin Leaf Connector

Instruction Sheets:

- 408-7527** Accessories and Contacts, Crimp Snap Twin Leaf Connector
- 408-7529** Extraction Tool 91073-1
- 408-7531** Hand Tool 90268-1, Single Crimp, 28-24 AWG [0.08-0.2 mm²] Wire
- 408-7551** Hand Tool 90264-1, Double Crimp, 22-20 AWG [0.3-0.6 mm²] and 18 AWG [0.8-0.9 mm²] Wire
- 408-7583** Hand Tool 90285-1, Double Crimp, 20-18 AWG [0.5-0.9 mm²] and 16 AWG [1.25-1.4 mm²] Wire
- 408-8547** CERTI-CRIMP II Straight Action Hand Tools

AMP-LEAF Connectors

Product Specifications:

108-9013 AMP-LEAF Connector
108-9043 AMP-LEAF Connector, Tin Plated Contacts

Application Specification:

114-9003 Contact, AMP-LEAF Connector

Instruction Sheets:

- 408-6951** Lubricant for tin plating, fretting, corrosion
- 408-7035** Retaining Spring 42973
- 408-7036** On-Contact Keying Plugs 480143 and 582756
- 408-7037** Accessories and Contacts, AMP-LEAF Connector
- 408-7045** Extraction Tool 465195
- 408-7068** Intercontact Keying Plug 582501
- 408-7339** Intercontact Keying Plug 583274
- 408-7419** Commoning Springs
- 408-7622** Hand Tool 90017-3, 22-20 AWG [0.3-0.6 mm²], Two 22 AWG [0.3-0.4 mm²] or One 18 AWG [0.8-0.9 mm²] Wire
- 408-7623** Hand Tool 90028-3, 26-22 AWG [0.12-0.4 mm²], Two 22 AWG [0.3-0.4 mm²] Wires
- 408-7624** Hand Tool 90031-8, Two 18 AWG [0.8-0.9 mm²] Wires
- 408-7626** Hand Tool 90101-3, 20 AWG [0.5-0.6 mm²] or Two 20 AWG [0.5-0.6 mm²] Wires

High Current Connectors

Product Specification:

108-9045 High Current Edge Connector

Application Specification:

114-9005 Contact, High Current Edge Connector

Instruction Sheets:

- 408-7782** Extraction Tool 91116-1, High Current Connector
- 408-7783** Die Inserts 90332-1 and 90332-2
- 408-7802** Die Inserts 90333-1 and 90333-2
- 408-9123** High Current Connectors

DUO-TYNE Flag Connectors

Product Specification:

108-9038 DUO-TYNE Flag Connector, Tapered Beam Contact

Application Specification:

114-9002 Contact, DUO-TYNE Flag Connector

Instruction Sheets:

- 408-7047** DUO-TYNE Flag Right-Angle Connector
- 408-7486** On-Contact Keying Plug 583661
- 408-7780** Hand Tool 90335-1, 18-16 AWG [0.8-1.4 mm²] Wire
- 408-7848** Hand Tool 90027-4, 22-18 AWG [0.3-0.9 mm²] Wire
- 408-7849** Hand Tool 90094-4, 26-22 AWG [0.12-0.4 mm²] Wire

Printed Circuit Board Connector Hood Assemblies

Instruction Sheet:

408-7719 Printed Circuit Board Connector Hood Assemblies

Part Number Cross Reference—Tyco Part Number to Acquired Part Number

All Tyco Electronic Part Numbers without a corresponding acquired Part Number are listed as base part numbers only. Complete part numbers (with prefixes and/or suffixes) are shown on the page(s) indicated.
Contact Engineering if no corresponding Tyco Number is available.

Tyco Part Number	Acquired Part Number	Page Number
11299	—	9
42973	—	171
58084	—	117
58140	—	115
58142	—	115
58143	—	115
58150	—	115
58184	—	115
58200	—	115
58210	—	115
58218	—	115
59881	—	112
60151	—	165
66067	—	166
66084	—	165
66092	—	171
69710	—	174
90017	—	165
90027	—	174
90028	—	165
90031	—	165
90094	—	174
90101	—	165
90264	—	155
90268	—	155
90285	—	155
90332	—	174
90333	—	174
91081	—	72
91088	—	72
91116	—	174,175
91535	—	155
98014	—	57
98341	—	150
117169	—	112,122
117249	—	124,126
117269	—	124,126
117272	—	126
117285	—	121,126
117296	—	121,126
117311	—	123
117793	—	126
117795	—	120,126
117796	—	126
117798	—	120,126
117879	—	126
117880	—	126
118243	—	123
118778	—	121
118951	—	120
118982	—	100,102, 104,105, 106,108, 110,111, 120,121
119136	—	123
119163	—	103
119196	—	88
119200	—	107
119202	—	107
119216	—	103
119216	—	103
119237	—	101
119254	—	110
119256	—	110
119311	—	88
119341	—	112
119413	—	101
119552	—	105
119677	—	103

Tyco Part Number	Acquired Part Number	Page Number
119726	—	103
119734	—	101
119736	—	101
119738	—	103
119790	—	110
119791	—	103
119802	—	100,102, 104,106, 108,110, 111,120
119822	—	107
119831	—	101
119840	—	107
119841	—	107
119853	—	104
119880	—	105
119950	—	93
145031	—	14
145089	—	23
145098	—	9
145113	—	8
145116	—	176
145154	—	9
145165	—	10
145166	—	8
145167	—	9
145168	—	10
145169	—	8
145246	—	10
146912	—	176
147400	—	85
147668	—	129
176137	—	17
176139	—	25
265868	—	126
265871	—	95,115, 126
265879	—	126
265881	—	126
265902	—	126
265904	—	126
265905	—	126
265906	—	126
265910	—	126
265911	—	126
265912	—	126
265924	—	95,126
265931	—	126
265937	—	126
265962	—	126
266129	—	126
266220	—	115
266233	—	95,186
266235	—	95
266264	—	95
266267	—	95
313136	—	95
313139	—	95
313256	—	95
343371	—	165
350396	—	21
356500	—	185
465195	—	165
466366	—	165
466367	—	165
466368	—	165
466413	—	178
466424	—	178
466438	—	174
466439	—	174
466577	—	155
466586	—	178
466622	—	155
466713	—	155
466912	—	155
466919	—	155
466928	—	155

Tyco Part Number	Acquired Part Number	Page Number
480110	—	165,168, 169
480133	—	165,168, 169
480142	—	165,168, 169
480143	—	171
530002	—	178
530004	—	178
530005	—	178
530006	—	178
530007	—	178
530030	—	72
530061	—	170
530087	—	183
530088	—	182
530213	—	162
530218	—	158
530238	—	160
530245	—	156
530265	—	72
530267	—	72
530268	—	72
530270	—	72
530278	—	72
530282	—	72
530286	—	72
530290	—	72
530291	—	72
530292	—	66
530384	—	22
530396	—	21
530505	—	178
530509	—	179
530517	—	174
530518	—	174
530519	—	174
530520	—	174
530521	—	175
530533	—	175
530654	—	62
530655	—	62
530656	—	62
530657	—	62
530659	—	60
530662	—	60
530663	—	60
530664	—	60
530666	—	62
530667	—	62
530668	—	62
530669	—	62
530671	—	60
530672	—	60
530673	—	60
530674	—	60
530677	—	62
530678	—	62
530689	—	62
530825	—	21
530826	—	22
530841	—	20
530842	—	20
530843	—	17
530844	—	18
530851	—	170
530853	—	179
531004	—	80
531007	—	78
531019	—	74
531020	—	74
531021	—	74
531023	—	77
531024	—	77
531025	—	78
531026	—	78
531250	—	22,162

Part Number Cross Reference
Tyco Part Number to Acquired Part Number

Part Number Cross Reference—Tyco Part Number to Acquired Part Number

Tyco Part Number	Acquired Part Number	Page Number	Tyco Part Number	Acquired Part Number	Page Number	Tyco Part Number	Acquired Part Number	Page Number
531341	—	20	583723	—	165,167	0-1437261-2	C8D50PF29023	138
531353	—	176	583724	—	165,167	0-1437261-5	C8D50PF29033	138
531369	—	175	583725	—	165,167	0-1437261-6	C8D50PF29043	140
531370	—	175	583726	—	165,167	0-1437262-4	C6D06PF29013	148
531373	—	174,175	583752	—	72	0-1437262-5	C6D06PF29043	148
531395	—	75	583753	—	72	0-1437262-6	C6D10PF29022	146
531395	—	75	583754	—	72	0-1437262-7	C6D10PF29043	148
531396	—	75	583755	—	72	0-1437262-9	C6D15PF29022	146
531414	—	76	583760	—	171	0-1437263-7	C7D06PF29023	142
531433	—	62	583764	—	162	0-1437263-8	C7D06PF29043	144
531476	—	155	583853	—	155	0-1437264-3	C1D18PF29015	131
531477	—	155	583854	—	156	0-1437264-6	C1D20PF29015	131
531478	—	155	583857	—	162	0-1437264-7	C1D20PF29043	131
531534	—	66	583859	—	161	0-1437264-9	C1D25PF29013	131
531863	—	79	583861	—	157	0-1437267-5	A6D06DS29A3	54
532563	—	79	583864	—	159	0-1437267-6	A6D10DS29A2	54
532600	—	23	583873	—	159	0-1437267-7	A6D10DS29C2	54
536128	—	25	583875	—	155	0-1437267-8	A6D10DS29C3	54
582140	—	165,168	583879	—	156	0-1437267-9	A6D10RA29A	56
582147	—	165,168	583884	—	156	0-1437268-4	A7D06DS29C2	49
582264	—	165,168	583900	—	158	0-1437268-5	A7D06RA29C	52
582355	—	166	583975	—	170	0-1437268-6	A7D06RA29E	52
582370	—	179	583989	—	165	0-1437268-7	A7D10DS29C2	49
582371	—	179	583990	—	165	0-1437268-8	A7D10RA29AM231	51
582372	—	179	583991	—	165	0-1437268-9	A7D10WW29A3	49
582375	—	179	645115	—	87	0-1437270-1	A8D31DS29B3	43
582376	—	179	645116	—	91	0-1437270-2	A8D31DS29C2	43
582377	—	179	645135	—	84	0-1437270-3	A8D31DS29D2	43
582378	—	179	645142	—	92	0-1437270-4	A8D31RA29A	46
582379	—	179	645145	—	85	0-1437270-6	A8D31RA29C	46
582380	—	179	645146	—	89	0-1437270-7	A8D31RA29CM233	47
582382	—	179	645147	—	86	0-1437270-8	A8D31RA29E	46
582383	—	179	645149	—	90	0-1437270-9	A8D31RA29F	46
582384	—	179	645155	—	66	0-1437274-3	C7D06DS29C1	36
582385	—	179	645169	—	25	0-1437274-5	C7D15DS29C1	36
582386	—	179	645200	—	176	0-1437274-7	C7D15DS29C3	36
582387	—	179	645235	—	24	0-1437274-8	C7D18DS29C3	36
582388	—	179	645293	—	80,82	0-1437274-9	C7D22DS29C1	36
582500	—	165,168, 169	645384	—	23	0-1437276-2	C8D31DS29A3	32
582501	—	171	645394	—	105	0-1437276-3	C8D31DS29C1	31
582963	—	165,168	650025	—	17,18, 20,21, 22,23, 24,25, 63	0-1437276-5	C8D31DS29C2	31
583167	—	165,168	650059	—	109	0-1437276-6	C8D31DS29C3	32
583204	—	165	650083	—	79	0-1437276-8	C8D31DS29D1	31
583274	—	162,171	650090	—	12	0-1437276-9	C8D31DS29D3	32
583280	—	165,168	650091	—	13	1-1437260-4	C8D06PF29013	140
583294	—	166	650092	—	12	1-1437260-5	C8D06PF29043	140
583361	—	165	650118	—	23	1-1437261-1	C8D60PF29023	138
583407	—	66,72	650122	—	103	1-1437262-0	C6D15PF29023	146
583425	—	71	650123	—	103	1-1437262-3	C6D18PF29013	148
583454	—	171	650124	—	103	1-1437262-4	C6D18PF29023	146
583458	—	170	650148	—	117	1-1437262-8	C6D22PF29013	148
583485	—	66,72	650149	—	117	1-1437262-9	C6D22PF29023	146
583486	—	66,72	650150	—	117	1-1437263-4	C7D18PF29012	144
583533	—	66,72	650179	—	14	1-1437263-5	C7D18PF29013	144
583544	—	170	650181	—	12	1-1437263-6	C7D18PF29022	142
583545	—	170	650187	—	23	1-1437263-7	C7D18PF29023	142
583552	—	167	650207	—	18	1-1437263-8	C7D18PF29043	144
583555	—	165	650263	—	17	1-1437263-9	C7D20PF29012	144
583599	—	170	650281	—	117	1-1437264-0	C1D25PF29015	131
583616	—	155	650297	—	103	1-1437264-5	C1D35PF29013	131
583617	—	165,167	650616	—	25	1-1437264-6	C1D35PF29015	131
583649	—	155	650718	—	20	1-1437265-0	W8D18PF29063	136
583660	—	68,72	650719	—	14	1-1437265-2	W8D22PF29043	134
583661	—	179	650728	—	19	1-1437265-3	W8D25PF29013	134
583671	—	70	678034	—	107	1-1437265-4	W8D25PF29063	136
583679	—	68,72	678035	—	111	1-1437265-5	W8D25PF29093	136
583680	—	165,167	687775	—	155	1-1437265-6	W8D28PF29013	134
583685	—	165,167	810992	—	178	1-1437265-7	W8D28PF29093	136
583691	—	162	1320420	—	185	1-1437266-0	98230	150
583692	—	68,72	1338600	—	184	1-1437266-1	98231	150
583694	—	66	1437266	—	151	1-1437266-6	98236	150
583714	—	72	1490560	—	150	1-1437266-8	98238	150
583715	—	68,72	1490563	—	150	1-1437267-0	A6D10RA29AM233	56
583717	—	157	1571235	—	109	1-1437267-1	A6D10RA29C	56
583718	—	157				1-1437267-2	A6D10RA29E	56
583722	—	165,167				1-1437267-3	A6D10WW29A3	54
						1-1437267-4	A6D12DS29C2	54

Part Number Cross Reference—Tyco Part Number to Acquired Part Number

Tyco Part Number	Acquired Part Number	Page Number	Tyco Part Number	Acquired Part Number	Page Number	Tyco Part Number	Acquired Part Number	Page Number
1-1437267-5	A6D12RA29A	54	2-1437263-8	C7D28PF29013	144	3-1437260-8	C8D22PF29013	140
1-1437267-6	A6D12WW29A3	54	2-1437263-9	C7D28PF29023	142	3-1437262-3	C6D36PF29013	148
1-1437267-7	A6D15DS29A2	54	2-1437264-2	C1D50PF29013	131	3-1437262-4	C6D36PF29023	146
1-1437267-9	A6D15DS29C2	54	2-1437264-3	C1D50PF29015	131	3-1437262-6	C6D43PF29013	148
1-1437268-1	A7D15DS29A2	49	2-1437264-4	C1D50PF29017	132	3-1437262-8	C6D43PF29022	146
1-1437268-2	A7D15DS29C2	49	2-1437265-0	W8D30PF29013	134	3-1437262-9	C6D43PF29023	146
1-1437268-3	A7D15RA29C	52	2-1437265-1	W8D30PF29043	134	3-1437263-1	C7D30PF29013	144
1-1437268-4	A7D15RA29E	52	2-1437265-3	W8D35PF29013	134	3-1437263-2	C7D30PF29023	142
1-1437268-5	A7D15WW29A3	49	2-1437265-5	W8D35PF29063	136	3-1437263-3	C7D30PF29043	144
1-1437268-6	A7D18DS29A2	49	2-1437265-6	W8D36PF29013	134	3-1437263-9	C7D35PF29012	144
1-1437268-7	A7D18DS29B2	49	2-1437265-7	W8D36PF29043	134	3-1437264-3	C6D36DS29C3	39
1-1437268-8	A7D18WW29A3	49	2-1437265-8	W8D36PF29093	136	3-1437264-4	C9D020PF60048	129
1-1437268-9	A7D22DS29C2	49	2-1437267-0	A6D15RA29E	56	3-1437264-5	C9D030PF60048	129
1-1437269-9	A8D10DS29A2	43	2-1437267-1	A6D15WW29A3	54	3-1437264-6	C9D060PF60048	129
1-1437270-0	A8D31WW29A3	44	2-1437267-2	A6D18DS29A2	54	3-1437265-0	W8D40PF29013	134
1-1437270-2	A8D35DS29A2	43	2-1437267-3	A6D18DS29C2	54	3-1437265-4	W8D50PF29012	134
1-1437270-3	A8D35DS29C2	43	2-1437267-4	A6D18RA29A	56	3-1437265-5	W8D50PF29013	134
1-1437270-4	A8D35RA29C	46	2-1437267-5	A6D18WW29A3	54	3-1437265-6	W8D50PF29043	134
1-1437270-5	A8D35WW29A3	44	2-1437267-7	A6D22DS29A2	54	3-1437265-7	W8D50PF29062	136
1-1437270-6	A8D36DS29A2	43	2-1437267-8	A6D22DS29B2	54	3-1437265-9	W8D60PF29013	134
1-1437270-7	A8D36DS29B3	43	2-1437267-9	A6D22DS29C2	54	3-1437266-5	98336	150
1-1437270-8	A8D36DS29C2	43	2-1437268-1	A7D25DS29A2	49	3-1437266-9	9836701	151
1-1437270-9	A8D36DS29C3	43	2-1437268-2	A7D25RA29FM232	51	3-1437267-0	A6D22RA29A	56
1-1437273-3	C6D06DS29A1	39	2-1437268-3	A7D28DS29A2	49	3-1437267-1	A6D22RA29C	56
1-1437273-4	C6D06DS29C1	39	2-1437268-4	A7D28DS29B2	49	3-1437267-2	A6D22WW29A3	54
1-1437273-5	C6D06DS29C3	39	2-1437268-5	A7D28DS29C2	49	3-1437267-4	A6D25DS29C2	54
1-1437273-6	C6D06DS29D1	39	2-1437268-8	A7D28RA29AM231	51	3-1437267-5	A6D28DS29A2	54
1-1437273-7	C6D06DS29D3	39	2-1437268-9	A7D28RA29C	52	3-1437267-6	A6D28DS29C2	54
1-1437273-8	C6D06DS29D4	40	2-1437269-0	A8D10DS29C2	43	3-1437267-7	A6D28RA29A	56
1-1437273-9	C6D10DS29A1	39	2-1437269-1	A8D10RA29A	46	3-1437267-8	A6D28RA29C	56
1-1437274-0	C7D22DS29D3	36	2-1437269-2	A8D10RA29C	46	3-1437267-9	A6D28RA29E	56
1-1437274-1	C7D25DS29C1	36	2-1437269-3	A8D10RA29CM233	47	3-1437268-0	A7D28RA29CM232	51
1-1437274-3	C7D28DS29A1	36	2-1437269-4	A8D10RA29E	46	3-1437268-1	A7D28RA29E	52
1-1437274-4	C7D28DS29A3	36	2-1437269-5	A8D10WW29A3	44	3-1437268-2	A7D28RA29EM231	51
1-1437274-6	C7D28DS29B3	36	2-1437269-7	A8D12DS29A2	43	3-1437268-3	A7D28WW29A3	49
1-1437274-7	C7D28DS29C1	36	2-1437269-8	A8D12DS29C2	43	3-1437268-4	A7D30DS29A2	49
1-1437274-8	C7D28DS29C3	36	2-1437269-9	A8D12RA29C	46	3-1437268-5	A7D30DS29C2	49
1-1437274-9	C7D28DS29D1	36	2-1437270-0	A8D36RA29A	46	3-1437268-6	A7D30RA29AM231	51
1-1437276-0	C8D35DS29A1	31	2-1437270-1	A8D36RA29C	46	3-1437268-7	A7D30WW29A3	49
1-1437276-1	C8D35DS29A3	32	2-1437270-2	A8D36RA29E	46	3-1437268-8	A7D35DS29A2	49
1-1437276-3	C8D35DS29C3	32	2-1437270-3	A8D36RA29EM233	47	3-1437268-9	A7D35DS29C2	49
1-1437276-4	C8D35DS29E3	32	2-1437270-4	A8D36WW29A3	44	3-1437269-0	A8D12RA29E	46
1-1437276-5	C8D36DS29A3	32	2-1437270-6	A8D40DS29A3	43	3-1437269-1	A8D12RA29EM233	47
1-1437276-6	C8D36DS29C1	31	2-1437270-7	A8D40DS29C2	43	3-1437269-2	A8D12WW29A3	44
1-1437276-8	C8D36DS29C2	31	2-1437270-8	A8D40RA29E	46	3-1437269-8	A8D15DS29A2	43
1-1437276-9	C8D36DS29C3	32	2-1437270-9	A8D40WW29A3	44	3-1437269-9	A8D15DS29C2	43
1437260-4	9820302	151	2-1437273-0	C6D10DS29B3	39	3-1437270-0	A8D43DS29C2	43
1437260-5	9820305	151	2-1437273-1	C6D10DS29C1	39	3-1437270-1	A8D43RA29A	46
1437260-6	9836301	151	2-1437273-2	C6D10DS29C4	40	3-1437270-2	A8D43RA29C	46
1437260-7	9836702	151	2-1437273-3	C6D12DS29A4	40	3-1437270-3	A8D43RA29E	46
1437266-3	9818002	151	2-1437273-4	C6D12DS29C1	39	3-1437270-4	A8D43WW29A3	44
1437266-4	9818004	151	2-1437273-5	C6D12DS29C3	39	3-1437270-5	A8D44DS29A2	43
1437266-5	9818005	151	2-1437273-6	C6D15DS29A1	39	3-1437270-6	A8D44DS29C2	43
1437266-6	9820301	151	2-1437273-7	C6D15DS29B3	39	3-1437270-7	A8D44DS29C3	44
1437266-7	9820401	151	2-1437273-8	C6D15DS29C1	39	3-1437270-8	A8D44RA29CM233	47
1437266-8	98206	150	2-1437273-9	C6D15DS29C3	39	3-1437270-9	A8D50DS29A2	43
1437266-9	98224	150	2-1437274-0	C7D28DS29D3	36	3-1437273-0	C6D15DS29D1	39
1437274-1	98293	150	2-1437274-2	C7D28DS29E3	36	3-1437273-1	C6D15DS29D3	39
2-1437260-0	C8D10PF29013	140	2-1437274-3	C7D28PF29032	142	3-1437273-2	C6D18DS29A1	39
2-1437260-2	C8D10PF29023	138	2-1437274-4	C7D30DS29A3	36	3-1437273-3	C6D18DS29A3	39
2-1437260-3	C8D10PF29043	140	2-1437274-5	C7D30DS29C3	36	3-1437273-4	C6D18DS29C1	39
2-1437260-4	C8D12PF29013	140	2-1437274-6	C7D30DS29C4	37	3-1437273-5	C6D22DS29A1	39
2-1437260-5	C8D12PF29023	138	2-1437274-7	C7D30PF29032	142	3-1437273-6	C6D22DS29A3	39
2-1437260-6	C8D12PF29043	140	2-1437274-8	C7D31DS29A3	36	3-1437273-7	C6D22DS29B4	40
2-1437260-7	C8D15PF29013	140	2-1437274-9	C7D31DS29C3	36	3-1437273-8	C6D22DS29C1	39
2-1437260-9	C8D15PF29023	138	2-1437275-9	C8D06DS29C1	31	3-1437273-9	C6D22DS29D1	39
2-1437262-0	C6D22PF29043	148	2-1437276-0	C8D36DS29D1	31	3-1437274-0	C7D31DS29D3	36
2-1437262-4	C6D28PF29013	148	2-1437276-1	C8D36DS29D2	31	3-1437274-1	C7D35DS29C1	36
2-1437262-6	C6D28PF29023	146	2-1437276-2	C8D36DS29D3	32	3-1437274-2	C7D36DS29C1	36
2-1437262-7	C6D28PF29033	146	2-1437276-3	C8D36DS29E3	32	3-1437274-3	C7D36DS29C3	36
2-1437262-8	C6D28PF29043	148	2-1437276-5	C8D40DS29A1	31	3-1437274-4	C7D36DS29D3	36
2-1437262-9	C6D30PF29023	146	2-1437276-6	C8D40DS29A3	32	3-1437274-6	C7D40DS29C1	36
2-1437263-0	C7D20PF29013	144	2-1437276-7	C8D40DS29C1	31	3-1437274-7	C7D40DS29C3	36
2-1437263-1	C7D20PF29023	142	2-1437276-9	C8D40DS29C3	32	3-1437274-8	C7D40DS29D3	36
2-1437263-3	C7D22PF29013	144	3-1437260-0	C8D15PF29043	140	3-1437274-9	C7D43DS29C1	36
2-1437263-4	C7D22PF29023	142	3-1437260-5	C8D20PF29023	138	3-1437275-0	C8D06DS29C2	31
2-1437263-7	C7D28PF29012	144	3-1437260-6	C8D20PF29043	140	3-1437275-1	C8D06DS29C3	32

Part Number Cross Reference
Tyco Part Number to Acquired Part Number

Part Number Cross Reference—Tyco Part Number to Acquired Part Number

Tyco Part Number	Acquired Part Number	Page Number
9-1437269-4	A8D30WW29A3	44
9-1437269-5	A8D30WW29B3	44
9-1437269-8	A8D31DS29A2	43
9-1437269-9	A8D31DS29A3	43
9-1437275-0	C8D28DS29D3	32
9-1437275-1	C8D28PF29012	140
9-1437275-3	C8D30DS29C1	31
9-1437275-5	C8D30DS29C3	32
9-1437275-6	C8D30DS29D1	31
9-1437275-7	C8D30DS29D3	32
9-1437275-8	C8D30DS29E1	31
9-1437275-9	C8D30DS29E3	32
AP3	—	149
BMEP 1K/2K	—	149
BMEP 3T/5T	—	149
MEP 6T/12T	—	149
Model G	—	184
SAHT	—	185

Part Number Cross Reference—Acquired Part Number to Tyco Part Number

Acquired Part Number	Tyco Part Number	Page Number
C8D60PF29143	—	138
C9D020PF60048	3-1437264-4	129
C9D030PF60048	3-1437264-5	129
C9D040PF60048	—	129
C9D050PF60048	—	129
C9D060PF60048	3-1437264-6	129
W8D18DS29063	—	34
W8D18DS29093	—	34
W8D18PF29012	—	134
W8D18PF29013	—	134
W8D18PF29042	—	134
W8D18PF29043	—	134
W8D18PF29062	—	136
W8D18PF29063	1-1437265-0	136
W8D18PF29092	—	136
W8D18PF29093	—	136
W8D20DS29063	—	34
W8D20DS29093	—	34
W8D20PF29012	—	134
W8D20PF29013	—	134
W8D20PF29042	—	134
W8D20PF29043	—	134
W8D20PF29062	—	136
W8D20PF29063	—	136
W8D20PF29092	—	136
W8D20PF29093	—	136
W8D22DS29063	—	34
W8D22DS29093	—	34
W8D22PF29012	—	134
W8D22PF29013	—	134
W8D22PF29042	—	134
W8D22PF29043	1-1437265-2	134
W8D22PF29062	—	136
W8D22PF29063	—	136
W8D22PF29092	—	136
W8D22PF29093	—	136
W8D25DS29063	—	34
W8D25DS29093	—	34
W8D25PF29012	—	134
W8D25PF29013	1-1437265-3	134
W8D25PF29042	—	134
W8D25PF29043	—	134
W8D25PF29062	—	136
W8D25PF29063	1-1437265-4	136
W8D25PF29092	—	136
W8D25PF29093	1-1437265-5	136
W8D28DS29063	—	34
W8D28DS29093	—	34
W8D28PF29012	—	134
W8D28PF29013	1-1437265-6	134
W8D28PF29042	—	134
W8D28PF29043	—	134
W8D28PF29062	—	136
W8D28PF29063	—	136
W8D28PF29092	—	136
W8D28PF29093	1-1437265-7	136
W8D30DS29063	—	34
W8D30DS29093	—	34
W8D30PF29012	—	134
W8D30PF29013	2-1437265-0	134
W8D30PF29042	—	134
W8D30PF29043	2-1437265-1	134
W8D30PF29062	—	136
W8D30PF29063	—	136
W8D30PF29092	—	136
W8D30PF29093	—	136
W8D35DS29063	—	34
W8D35DS29093	—	34
W8D35PF29012	—	134
W8D35PF29013	2-1437265-3	134
W8D35PF29042	—	134
W8D35PF29043	—	134
W8D35PF29062	—	136
W8D35PF29063	2-1437265-5	136
W8D35PF29092	—	136
W8D35PF29093	—	136
W8D36DS29063	—	34
W8D36DS29093	—	34
W8D36PF29012	—	134
W8D36PF29013	2-1437265-6	134
W8D36PF29042	—	134
W8D36PF29043	2-1437265-7	134
W8D36PF29062	—	136
W8D36PF29063	—	136
W8D36PF29092	—	136
W8D36PF29093	2-1437265-8	136
W8D40DS29063	—	34
W8D40DS29093	—	34

Acquired Part Number	Tyco Part Number	Page Number
W8D40PF29012	—	134
W8D40PF29013	3-1437265-0	134
W8D40PF29042	—	134
W8D40PF29043	—	134
W8D40PF29062	—	136
W8D40PF29063	—	136
W8D40PF29092	—	136
W8D40PF29093	—	136
W8D43DS29063	—	34
W8D43DS29093	—	34
W8D43PF29012	—	134
W8D43PF29013	—	134
W8D43PF29042	—	134
W8D43PF29043	—	134
W8D43PF29062	—	136
W8D43PF29063	—	136
W8D43PF29092	—	136
W8D43PF29093	—	136
W8D45DS29063	—	34
W8D45DS29093	—	34
W8D45PF29012	—	134
W8D45PF29013	—	134
W8D45PF29042	—	134
W8D45PF29043	—	134
W8D45PF29062	—	136
W8D45PF29063	—	136
W8D45PF29092	—	136
W8D45PF29093	—	136
W8D50DS29063	—	34
W8D50DS29093	—	34
W8D50PF29012	3-1437265-4	134
W8D50PF29013	3-1437265-5	134
W8D50PF29042	—	134
W8D50PF29043	3-1437265-6	134
W8D50PF29062	3-1437265-7	136
W8D50PF29063	—	136
W8D50PF29092	—	136
W8D50PF29093	—	136
W8D60DS29063	—	34
W8D60DS29093	—	34
W8D60PF29012	—	134
W8D60PF29013	3-1437265-9	134
W8D60PF29042	—	134
W8D60PF29043	—	134
W8D60PF29062	—	136
W8D60PF29063	—	136
W8D60PF29092	—	136
W8D60PF29093	—	136

For additional component solutions for Industrial Machinery, Instrumentation, Security, and related applications, request the following brochures:

Brochure No. 889439 – Industrial Machinery

Brochure No. 1307285 – Instrumentation

Brochure No. 1308325 – Security

These brochures list catalog sources for connectors, switches, terminal blocks, relays, timers, circuit breakers, and cable assemblies available from Tyco Electronics.

Related Product Information

tyco
Electronics

interconnect solutions for...

AGASTAT
ALCOSWITCH
AMP
AXICOM
BUCHANAN
HTS
OEG
P&B
SCHRACK

- Connectors
- Switches
- Terminal Blocks
- Relays & Circuit Breakers
- Visit our web-site: www.tycoelectronics.com

Industrial Machinery

tyco
Electronics

interconnect solutions for...

AGASTAT
ALCOSWITCH
AMP
AXICOM
BUCHANAN
CI
MICRODOT
OEG
P&B
SCHRACK

- Cable Assemblies
- Connectors
- Relays & Circuit Breakers
- Switches
- Terminal Blocks
- Visit our web-site: www.tycoelectronics.com

Instrumentation

tyco
Electronics

interconnect solutions for...

AMP
Alcoswitch
BUCHANAN

- Interconnection Expertise...
- Concept to Production...
- Products and Services...
- Visit our web-site: www.tycoelectronics.com

Security

Americas

Argentina – Buenos Aires
 Phone: +54-11-4733-2200
 Fax: +54-11-4733-2250

Brasil – São Paulo
 Phone: +55-11-3611-1311
 Fax: +55-11-3611-0397

Canada – Markham
 Phone: +905-475-6222
 Fax: +905-474-5520
**Product Information Center:
 (Technical Support)**
 Phone: +905-470-4425
 Fax: +905-474-5525

Colombia – Bogota
 Phone: +57-1-240-9396
 Fax: +57-1-660-0206

Mexico – Mexico City
 Phone: +52-55-5-729-0425
 Fax: +52-55-5-398-1430

United States – Harrisburg, PA
 Phone: +717-564-0100
 Fax: +717-986-7575
**Product Information Center:
 (Technical Support)**
 Phone: +800-522-6752
 Fax: +717-986-7575

**For Latin/South American
 Countries not shown**
 Phone: +57-1-240-9396
 Fax: +57-1-660-0206

Asia/Pacific

Australia – Sydney
 Phone: +61-2-9840-8200
 Fax: +61-2-9899-5649
**Product Information Center:
 (Technical Support)**
 Phone: +61-2-9554-2600
 Fax: +61-2-9502-2556

India – Bangalore
 Phone: +91-80-841-0200
 Fax: +91-80-841-0210

Indonesia – Jakarta
 Phone: +6221-526-7852
 Fax: +6221-526-7856

Japan – Kawasaki, Kanagawa
 Phone: +81-44-844-8079
 Fax: +81-44-844-8733
**Product Information Center:
 (Technical Support)**
 Phone: +81-44-844-8013
 Fax: +81-44-812-3200
Raychem Products
 Phone: +81-44-900-5102
 Fax: +81-44-5025-5027

Korea – Seoul
 Phone: +82-2-3274-0535
 Fax: +82-2-3274-0524/0531

Malaysia – Selangor
 Phone: +60-3-7053055
 Fax: +60-3-7053066

New Zealand – Auckland
 Phone: +64-9-634-4580
 Fax: +64-9-634-4586

Philippines – Makati City
 Phone: +632-867-8641
 Fax: +632-867-8661

People's Republic of China
 Hong Kong
 Phone: +852-2735-1628
 Fax: +852-2735-0243

Shanghai
 Phone: +86-21-6485-0602
 Fax: +86-21-6485-0728

Shunde
 Phone: +86-765-775-1368
 Fax: +86-765-775-2823

Singapore – Singapore
 Phone: +65-482-0311
 Fax: +65-482-1012

Raychem Products
 Phone: +65-486-6151
 Fax: +65-654-5514

Taiwan – Taipei
 Phone: +886-2-2664-9977
 Fax: +886-2-2664-9900

Thailand – Bangkok
 Phone: +66-2-955-0500
 Fax: +66-2-955-0505

Vietnam – Ho Chi Minh City
 Phone: +84-8-8232-546/7
 Fax: +84-8-8221-443

Europe/Middle East/Africa

Austria – Vienna
 Phone: +43-190-560-0
 Fax: +43-190-560-1333

Belgium – Kessel-Lo
 Phone: +32-16-352-300
 Fax: +32-16-352-352

Bulgaria – Sofia
 Phone: +359-2-971-2152
 Fax: +359-2-971-2153

Czech Republic – Kurim
 Phone: +420-5-41-162-111
 Fax: +420-5-41-162-223

Denmark – Viby J
 Phone: +45-70-15-52-00
 Fax: +45-86-29-51-33

Egypt – Cairo
 Phone: +20-2-417-76-47
 Fax: +20-2-419-23-34

Estonia – Tallinn
 Phone: +372-65-05-474
 Fax: +372-65-05-470

Finland – Helsinki
 Phone: +358-95-12-34-20
 Fax: +358-95-12-34-250

France – Cergy-Pontoise
 Phone: +33-1-3420-8888
 Fax: +33-1-3420-8600
**Product Information Center:
 (Technical Support)**
 Phone: +33-1-3420-8943
 Fax: +33-1-3420-8623

France
Tyco Electronics Export – St Ouen L'Aumone
 Phone: +33-1-3440-7200
 Fax: +33-1-3440-7220 or
 +33-1-3440-7230

Germany – Bensheim
 Phone: +49-6251-133-0
 Fax: +49-6251-133-1600
**Product Information Center:
 (Technical Support)**
 Phone: +49-6251-133-1999
 Fax: +49-6251-133-1988

Germany – Langen
 Phone: +49-6103-709-0
 Fax: +49-6103-709-1223

Germany – Speyer
 Phone: +49-6232-30-0
 Fax: +49-6232-30-2243

Germany
HTS Division – Neunkirchen
 Phone: +49-2247-305-0
 Fax: +49-2247-305-122

Great Britain – Stanmore Middlesex
 Phone: +44-181-954-2356
 Fax: +44-181-954-6234
**Product Information Center:
 (Technical Support)**
 Freephone GB: 0800-267-666
 Phone: +44-141 810 8967...69
 Fax: +44-141 810 8971

Great Britain – Dorcan, Swindon
Raychem Products
 Phone: +44-1793-528171
 Fax: +44-1793-572516

Greece – Athens
 Phone: +30-1-9370-396/397
 Fax: +30-1-9370-655

Hungary – Budapest
 Phone: +36-1-289-1000
 Fax: +36-1-289-1010

Ireland – Dublin
 Phone: +353-1-820-3000
 Fax: +353-1-820-9790

Israel – Yokneam
 Phone: +972-4-959-0508
 Fax: +972-4-959-0506

Italy – Collegno (Torino)
 Phone: +39-011-4012-111
 Fax: +39-011-4031-116

Lithuania – Vilnius
 Phone: +370-5-21-31-402
 Fax: +370-5-21-31-403

Netherlands – 's-Hertogenbosch
 Phone: +31-73-6246-246
 Fax: +31-73-6212-365
**Product Information Center:
 (Technical Support)**
 Phone: +31-73-6246-999
 Fax: +31-73-6246-998

Norway – Nesbru
 Phone: +47-66-77-88-99
 Fax: +47-66-77-88-55

Poland – Warsaw
 Phone: +48-22-5490-888
 Fax: +48-22-5490-880

Romania – Bucharest
 Phone: +40-1-311-3479+3596
 Fax: +40-1-312-0574

Russia – Moscow
 Phone: +7-095-926-55-06...09
 Fax: +7-095-926-55-05

Russia – St. Petersburg
 Phone: +7-812-325-30-83
 Fax: +7-812-325-32-88

Scotland – Dundee
Madison Cable Products
 Phone: +44-1382-508080
 Fax: +44-1382-505060

Slovakia – Banská Bystrica
 Phone: +421-48-415-20-11/12
 Fax: +421-48-415-20-13

Slovenia – Ljubljana
 Phone: +386-1561-3270
 Fax: +386-1561-3240

South Africa – Port Elizabeth
 Phone: +27-41-405-4500
 Fax: +27-41-486-1314

Spain – Barcelona
 Phone: +34-93-291-0330
 Fax: +34-93-201-7879
**Product Information Center:
 (Technical Support):**
 Phone: +34-93-291-0330
 Fax: +34-93-200-3779

Sweden – Upplands Väsby
 Phone: +46-8-50-72-50-00
 Fax: +46-8-50-72-50-01

Switzerland – Steinach
 Phone: +41-71-447-0447
 Fax: +41-71-447-0444

Turkey – Istanbul
 Phone: +90-212-281-8181...3
 +90-212-282-5130/5430
 Fax: +90-212-281-8184

Ukraine – Kiev
 Phone: +38-044-238-6908
 Fax: +38-044-568-5740

tyco

Electronics

TYCO ELECTRONICS CORPORATION
WWW.TYCOELECTRONICS.COM

AMP

