

(2,54mm) .100"

IDSS, IDSD, IDMS, IDMD SERIES

# SLIM BODY FLAT RIBBON IDC CABLES

## SPECIFICATIONS

### IDSS, IDSD

For complete specifications see [www.samtec.com?IDSS](http://www.samtec.com?IDSS) or [www.samtec.com?IDSD](http://www.samtec.com?IDSD)

#### Insulator Material:

Black Glass Filled Polyester



#### Plating:

Au over 50µ" (1,27µm) Ni or Sn over 100µ" (2,54µm) Cu or 50µ" (1,27µm) Ni

#### Wire:

28 AWG 7/36 stranded Tinned Copper

#### Temperature Range:

-20°C to +105°C (Rainbow Cable)  
-40°C to +105°C (Gray Cable)

#### Contact:

BeCu

#### Current Rating:

1A

#### Contact Resistance:

10 mΩ max

#### Lead Size Range:

(0,56mm) .022" SQ to (0,71mm) .028" SQ

#### Lead Insertion Depth:

(5,59mm) .220" to (6,22mm) .245"

#### Insertion Force:

(Single contact only)

4oz avg.

((0,64mm) .025" SQ probe)

#### Withdrawal Force:

(Single contact only)

3oz avg.

((0,64mm) .025" SQ probe)

RoHS Compliant: Yes

## SPECIFICATIONS

### IDMS, IDMD

For complete specifications see [www.samtec.com?IDMS](http://www.samtec.com?IDMS) or [www.samtec.com?IDMD](http://www.samtec.com?IDMD)

#### Insulator Material:

Black Glass Filled Polyester



#### Plating:

Au over 50µ" (1,27µm) Ni or Sn over 100µ" (2,54µm) Cu or 50µ" (1,27µm) Ni

#### Wire:

28 AWG 7/36 stranded Tinned Copper

#### Temperature Range:

-20°C to +105°C (Rainbow Cable)  
-40°C to +105°C (Gray Cable)

#### Terminal:

Phosphor Bronze

#### Current Rating:

1A

RoHS Compliant: Yes

#### Note:

This Series is non-standard, non-returnable.

Mates with: TSW, MTSW, TSM, EJH

IDSD Mates with: TST, HTST, ZST

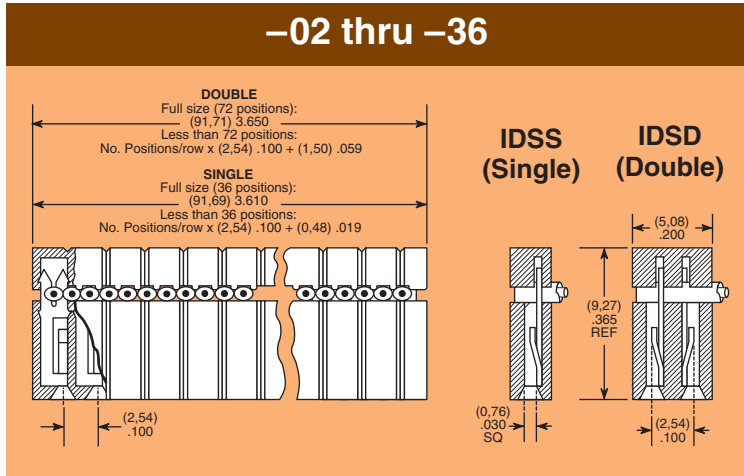
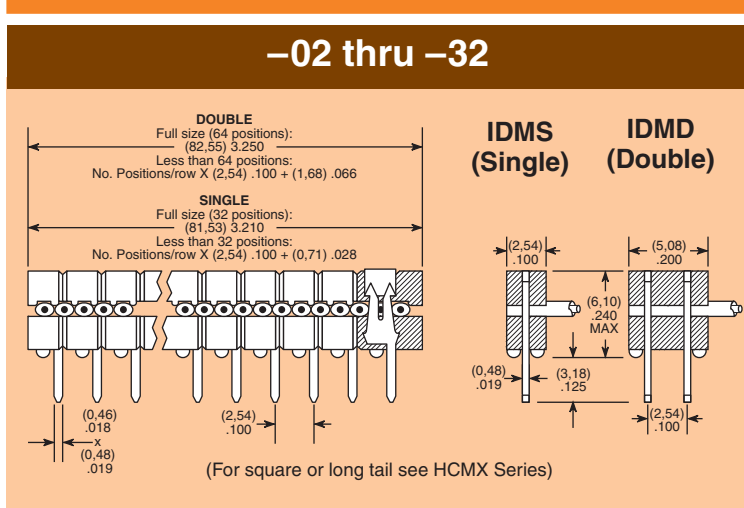
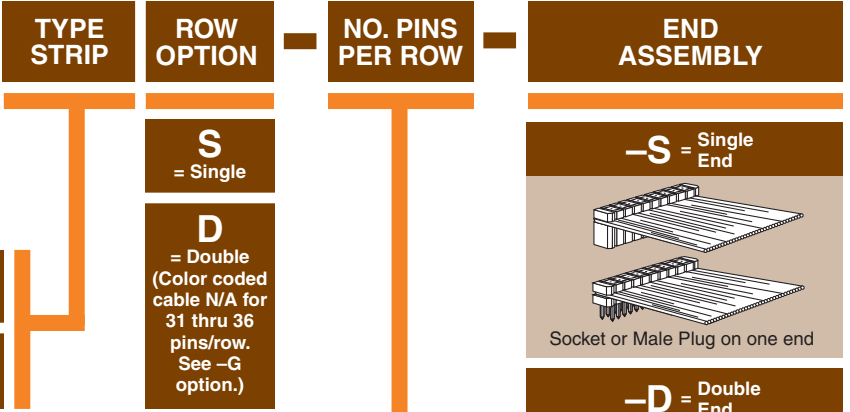

## EJECTOR HEADERS & LOCKING CLIPS

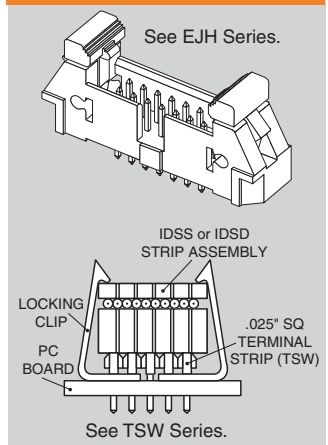

Due to technical progress, all designs, specifications and components are subject to change without notice.

[WWW.SAMTEC.COM](http://WWW.SAMTEC.COM)

SAMTEC USA • Tel: 1-800-SAMTEC-9 or 812-944-6733 SAMTEC SILICON VALLEY • Tel: 408-395-5900 SAMTEC SOUTHERN CALIFORNIA • Tel: 1-800-726-8329 SAMTEC UK • Tel: 44 01236 739292  
 SAMTEC GERMANY • Tel: +49 (0) 89 / 89460-0 SAMTEC FRANCE • Tel: 33 01 60 95 06 60 SAMTEC ITALY • Tel: 39 039 6890337 SAMTEC NORDIC/BALTIC • Tel: +46-84477280 SAMTEC BENELUX • Tel: 44 01236 739292  
 SAMTEC ISRAEL • Tel: 972-3-7526600 SAMTEC INDIA • Tel: +91-80-3272 1612 SAMTEC ASIA PACIFIC • Tel: 65 6745-5955 SAMTEC JAPAN • Tel: 045-475-1385 SAMTEC CHINA • Tel: 86-21-61103766  
 SAMTEC TAIWAN • Tel: 886-2-2735-6109 SAMTEC HONG KONG • Tel: 852-26904858 SAMTEC KOREA • Tel: 82-31-717-5685 SAMTEC SOUTH AFRICA • Tel: 27 11 452 8112 SAMTEC ANZ • Tel: 613 9512 7747

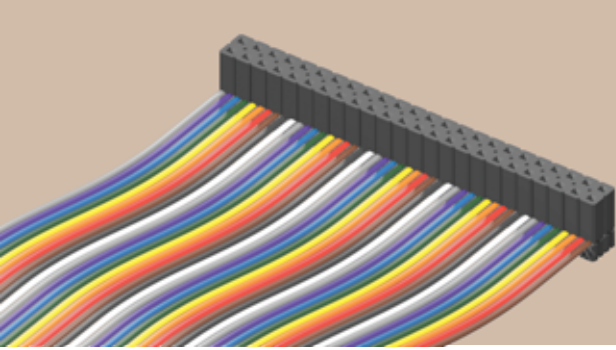

IDSD-24-S-05.00

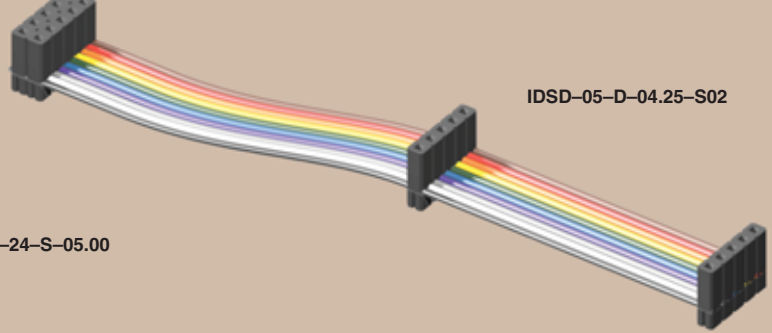

IDSD-05-D-04.25-S02

### ASSEMBLED LENGTH

— “XX.XX”  
= Assembled Length

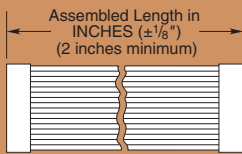

### OPTION

#### POLARIZING KEY

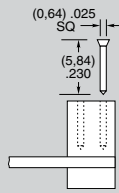

Optional polarizing key for use with IDSS & IDSD Series. Also polarizes SSW, SSQ, ESW & ESQ Series. Black High Temperature Thermoplastic

Order: Part Number PK-01-06  
(Available in wheels of six each)

### ALSO AVAILABLE

#### Molded-To-Position IDC Assemblies

- Low Profile
  - Skinny side locks
  - Dual beam contacts
  - Single and double row (6,35mm) .025" square and (5,84mm) .230" length tail available
- Call Samtec for HCXX Series.

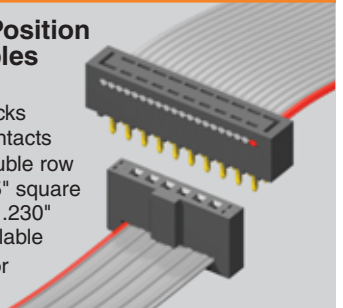

—T = Tin Plating (Both ends)

—C = Tin IDM = 10 $\mu$ m (0,25 $\mu$ m) Gold IDS (-T End Assembly Required)

—A = 10 $\mu$ m (0,25 $\mu$ m) Gold IDM = Tin IDS (-T End Assembly Required)

Standard plating is selective gold over BeCu contact for IDS; Selective gold over phosphor bronze for IDM.

1

—ST “X”  
= Stripped & Tinned

Specify Suffix from table. All dimensions are  $\pm 1/16"$ . Not available in 28 positions and higher.

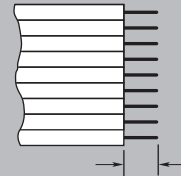

4

—S “XX”  
= Daisy Chain Single

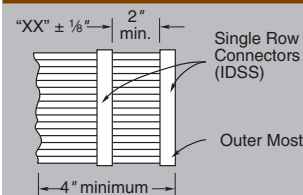

When mating double row connector with two single row connectors, the outer most single will be connected to Conductor #1 and the inside single to Conductor #2.

7

—R  
= Reversed

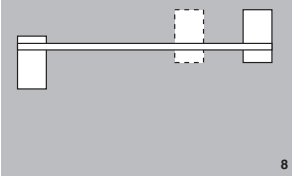

8

—P “XX”  
= Polarized

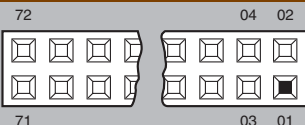

Specify “XX” as position. For Double the same position will be polarized on both ends. (Not available on IDM or EDM, unless transfer, then only the socket is polarized.)

2

—G  
= Gray Cable

Specify —G for Gray cable. Gray cable has one red edge. IDSS and IDMS uses .100" centerline cable. IDSD and IDMD uses .050" centerline cable. Cable is 28 AWG 7/36 copper wire. Standard cable is same as above except color coded.

3

—B “XX”  
= Breakout

Specify “XX” as number of conductors to be broken out.

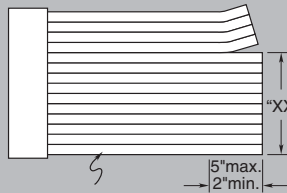

Breakout starts with Number 1 lead indicated by brown wire or red stripe. Shown on top side.

5

—D “XX”  
= Daisy Chain, Double

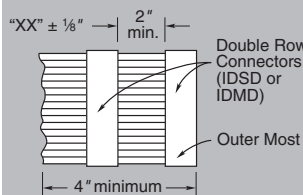

7

—W “XX”  
= Wiring Reversed Daisy Chain, Single

Same as —S “XX” except outer strip connected to Conductor #2 and inside strip connected to Conductor #1.

7

—M  
= Middle Reversed

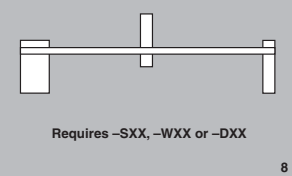

8

—O  
= Outside Reversed

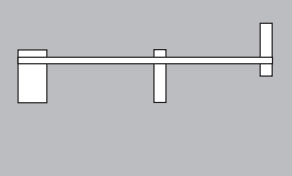

8

—RW  
= Reversed Wiring

#1 wire opposite position #1.

6

Due to technical progress, all designs, specifications and components are subject to change without notice.

WWW.SAMTEC.COM

SAMTEC USA • Tel: 1-800-SAMTEC-9 or 812-944-6733 SAMTEC SILICON VALLEY • Tel: 408-395-5900 SAMTEC SOUTHERN CALIFORNIA • Tel: 1-800-726-8329 SAMTEC UK • Tel: 44 01236 739292  
 SAMTEC GERMANY • Tel: +49 (0) 89 / 89460-0 SAMTEC FRANCE • Tel: 33 01 60 95 06 60 SAMTEC ITALY • Tel: 39 039 6890337 SAMTEC NORDIC/BALTIC • Tel: +46-84477280 SAMTEC BENELUX • Tel: 44 01236 739292  
 SAMTEC ISRAEL • Tel: 972-3-7526600 SAMTEC HONG KONG • Tel: +91-80-3272 1612 SAMTEC ASIA PACIFIC • Tel: 65 6745-5955 SAMTEC JAPAN • Tel: 045-475-1385 SAMTEC CHINA • Tel: 86-21-61103766  
 SAMTEC TAIWAN • Tel: 886-2-2735-6109 SAMTEC HONG KONG • Tel: 852-26904858 SAMTEC KOREA • Tel: 82-31-717-5685 SAMTEC SOUTH AFRICA • Tel: 27 11 452 8112 SAMTEC ANZ • Tel: 613 9512 7747