

# DTA114EET1 Series

Preferred Devices

## Bias Resistor Transistors

### PNP Silicon Surface Mount Transistors with Monolithic Bias Resistor Network

This new series of digital transistors is designed to replace a single device and its external resistor bias network. The Bias Resistor Transistor (BRT) contains a single transistor with a monolithic bias network consisting of two resistors; a series base resistor and a base-emitter resistor. The BRT eliminates these individual components by integrating them into a single device. The use of a BRT can reduce both system cost and board space. The device is housed in the SC-75/SOT-416 package which is designed for low power surface mount applications.

#### Features

- Simplifies Circuit Design
- Reduces Board Space
- Reduces Component Count
- The SC-75/SOT-416 package can be soldered using wave or reflow. The modified gull-winged leads absorb thermal stress during soldering eliminating the possibility of damage to the die.
- Pb-Free Packages are Available

#### MAXIMUM RATINGS ( $T_A = 25^\circ\text{C}$ unless otherwise noted)

Rating	Symbol	Value	Unit
Collector-Base Voltage	$V_{CBO}$	50	Vdc
Collector-Emitter Voltage	$V_{CEO}$	50	Vdc
Collector Current	$I_C$	100	mAdc

#### THERMAL CHARACTERISTICS

Rating	Symbol	Value	Unit
Total Device Dissipation, FR-4 Board (Note 1) @ $T_A = 25^\circ\text{C}$ Derate above $25^\circ\text{C}$	$P_D$	200 1.6	mW mW/ $^\circ\text{C}$
Thermal Resistance, Junction-to-Ambient (Note 1)	$R_{\theta JA}$	600	$^\circ\text{C}/\text{W}$
Total Device Dissipation, FR-4 Board (Note 2) @ $T_A = 25^\circ\text{C}$ Derate above $25^\circ\text{C}$	$P_D$	300 2.4	mW mW/ $^\circ\text{C}$
Thermal Resistance, Junction-to-Ambient (Note 2)	$R_{\theta JA}$	400	$^\circ\text{C}/\text{W}$
Junction and Storage Temperature Range	$T_J, T_{stg}$	-55 to +150	$^\circ\text{C}$

Stresses exceeding Maximum Ratings may damage the device. Maximum Ratings are stress ratings only. Functional operation above the Recommended Operating Conditions is not implied. Extended exposure to stresses above the Recommended Operating Conditions may affect device reliability.

1. FR-4 @ Minimum Pad.
2. FR-4 @  $1.0 \times 1.0$  Inch Pad.



ON Semiconductor®

<http://onsemi.com>

## PNP SILICON BIAS RESISTOR TRANSISTORS

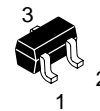
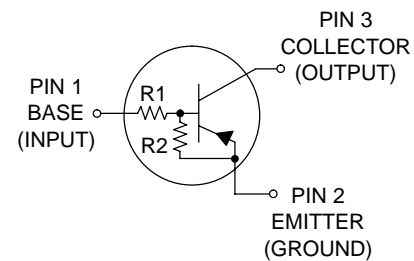

SC-75 (SOT-416)  
CASE 463  
STYLE 1

#### MARKING DIAGRAM

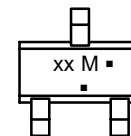

xx = Specific Device Code  
xx = (Refer to page 2)  
M = Date Code\*  
▪ = Pb-Free Package

(Note: Microdot may be in either location)

\*Date Code orientation may vary depending upon manufacturing location.

#### ORDERING INFORMATION

See detailed ordering and shipping information in the package dimensions section on page 2 of this data sheet.

Preferred devices are recommended choices for future use and best overall value.

## DTA114EET1 Series

### ORDERING INFORMATION AND RESISTOR VALUES

Device	Marking	R1 (K)	R2 (K)	Package	Shipping†
DTA114EET1	6A	10	10	SC-75	3000 Tape & Reel
DTA114EET1G				SC-75 (Pb-Free)	3000 Tape & Reel
DTA124EET1	6B	22	22	SC-75	3000 Tape & Reel
DTA124EET1G				SC-75 (Pb-Free)	3000 Tape & Reel
DTA144EET1	6C	47	47	SC-75	3000 Tape & Reel
DTA144EET1G				SC-75 (Pb-Free)	3000 Tape & Reel
DTA114YET1	6D	10	47	SC-75	3000 Tape & Reel
DTA114YET1G				SC-75 (Pb-Free)	3000 Tape & Reel
DTA114TET1	6E	10	∞	SC-75	3000 Tape & Reel
DTA114TET1G				SC-75 (Pb-Free)	3000 Tape & Reel
DTA143TET1	6F	4.7	∞	SC-75	3000 Tape & Reel
DTA143TET1G				SC-75 (Pb-Free)	3000 Tape & Reel
DTA123EET1	6H	2.2	2.2	SC-75	3000 Tape & Reel
DTA123EET1G				SC-75 (Pb-Free)	3000 Tape & Reel
DTA143EET1	43	4.7	4.7	SC-75	3000 Tape & Reel
DTA143EET1G				SC-75 (Pb-Free)	3000 Tape & Reel
DTA143ZET1	6K	4.7	47	SC-75	3000 Tape & Reel
DTA143ZET1G				SC-75 (Pb-Free)	3000 Tape & Reel
DTA124XET1	6L	22	47	SC-75	3000 Tape & Reel
DTA124XET1G				SC-75 (Pb-Free)	3000 Tape & Reel
DTA123JET1	6M	2.2	47	SC-75	3000 Tape & Reel
DTA123JET1G				SC-75 (Pb-Free)	3000 Tape & Reel
DTA115EET1	6N	100	100	SC-75	3000 Tape & Reel
DTA115EET1G				SC-75 (Pb-Free)	3000 Tape & Reel
DTA144WET1	6P	47	22	SC-75	3000 Tape & Reel
DTA144WET1G				SC-75 (Pb-Free)	3000 Tape & Reel

†For information on tape and reel specifications, including part orientation and tape sizes, please refer to our Tape and Reel Packaging Specifications Brochure, BRD8011/D.

## DTA114EET1 Series

### ELECTRICAL CHARACTERISTICS (T<sub>A</sub> = 25°C unless otherwise noted)

Characteristic	Symbol	Min	Typ	Max	Unit
<b>OFF CHARACTERISTICS</b>					
Collector–Base Cutoff Current (V <sub>CB</sub> = 50 V, I <sub>E</sub> = 0)	I <sub>CBO</sub>	–	–	100	nAdc
Collector–Emitter Cutoff Current (V <sub>CE</sub> = 50 V, I <sub>B</sub> = 0)	I <sub>CEO</sub>	–	–	500	nAdc
Emitter–Base Cutoff Current (V <sub>EB</sub> = 6.0 V, I <sub>C</sub> = 0)	I <sub>EBO</sub>	–	–	0.5	mAdc
	DTA114EET1	–	–	0.2	
	DTA124EET1	–	–	0.1	
	DTA144EET1	–	–	0.2	
	DTA114YET1	–	–	0.9	
	DTA114TET1	–	–	1.9	
	DTA143TET1	–	–	2.3	
	DTA123EET1	–	–	1.5	
	DTA143EET1	–	–	0.18	
	DTA143ZET1	–	–	0.13	
	DTA124XET1	–	–	0.2	
	DTA123JET1	–	–	0.05	
	DTA115EET1	–	–	0.13	
	DTA144WET1	–	–		
Collector–Base Breakdown Voltage (I <sub>C</sub> = 10 μA, I <sub>E</sub> = 0)	V <sub>(BR)CBO</sub>	50	–	–	Vdc
Collector–Emitter Breakdown Voltage (Note 3) (I <sub>C</sub> = 2.0 mA, I <sub>B</sub> = 0)	V <sub>(BR)CEO</sub>	50	–	–	Vdc

3. Pulse Test: Pulse Width < 300 μs, Duty Cycle < 2.0%

### ELECTRICAL CHARACTERISTICS (T<sub>A</sub> = 25°C unless otherwise noted)

Characteristic	Symbol	Min	Typ	Max	Unit
<b>ON CHARACTERISTICS (Note 4)</b>					
DC Current Gain (V <sub>CE</sub> = 10 V, I <sub>C</sub> = 5.0 mA)	h <sub>FE</sub>	35	60	–	–
	DTA114EET1	60	100	–	
	DTA124EET1	80	140	–	
	DTA144EET1	80	140	–	
	DTA114YET1	160	250	–	
	DTA114TET1	160	250	–	
	DTA143TET1	8.0	15	–	
	DTA123EET1	15	27	–	
	DTA143EET1	80	140	–	
	DTA143ZET1	80	130	–	
	DTA124XET1	80	140	–	
	DTA123JET1	80	150	–	
	DTA115EET1	80	140	–	
	DTA144WET1	80	140	–	
Collector–Emitter Saturation Voltage (I <sub>C</sub> = 10 mA, I <sub>E</sub> = 0.3 mA) (I <sub>C</sub> = 10 mA, I <sub>B</sub> = 5 mA) (I <sub>C</sub> = 10 mA, I <sub>B</sub> = 1 mA)	V <sub>CE(sat)</sub>	–	–	0.25	Vdc
	DTA123EET1				
	DTA114TET1/DTA143TET1				
	DTA143ZET1/DTA124XET1				
	DTA143EET1				
Output Voltage (on) (V <sub>CC</sub> = 5.0 V, V <sub>B</sub> = 2.5 V, R <sub>L</sub> = 1.0 kΩ)	V <sub>OL</sub>	–	–	0.2	Vdc
	DTA114EET1	–	–	0.2	
	DTA124EET1	–	–	0.2	
	DTA114YET1	–	–	0.2	
	DTA114TET1	–	–	0.2	
	DTA143TET1	–	–	0.2	
	DTA123EET1	–	–	0.2	
	DTA143EET1	–	–	0.2	
	DTA143ZET1	–	–	0.2	
	DTA124XET1	–	–	0.2	
	DTA123JET1	–	–	0.2	
(V <sub>CC</sub> = 5.0 V, V <sub>B</sub> = 3.5 V, R <sub>L</sub> = 1.0 kΩ)	DTA144EET1	–	–	0.2	
(V <sub>CC</sub> = 5.0 V, V <sub>B</sub> = 5.5 V, R <sub>L</sub> = 1.0 kΩ)	DTA115EET1	–	–	0.2	
(V <sub>CC</sub> = 5.0 V, V <sub>B</sub> = 4.0 V, R <sub>L</sub> = 1.0 kΩ)	DTA144WET1	–	–	0.2	

5. Pulse Test: Pulse Width < 300 μs, Duty Cycle < 2.0%

## DTA114EET1 Series

### ELECTRICAL CHARACTERISTICS ( $T_A = 25^\circ\text{C}$ unless otherwise noted) (continued)

Characteristic	Symbol	Min	Typ	Max	Unit
<b>ON CHARACTERISTICS</b> (Note 6)					
Output Voltage (off) ( $V_{CC} = 5.0\text{ V}$ , $V_B = 0.5\text{ V}$ , $R_L = 1.0\text{ k}\Omega$ ) ( $V_{CC} = 5.0\text{ V}$ , $V_B = 0.25\text{ V}$ , $R_L = 1.0\text{ k}\Omega$ ) DTA114TET1 DTA143TET1 DTA123EET1 DTA143EET1	$V_{OH}$	4.9	–	–	Vdc
Input Resistor DTA114EET1 DTA124EET1 DTA144EET1 DTA114YET1 DTA114TET1 DTA143TET1 DTA123EET1 DTA143EET1 DTA143ZET1 DTA124XET1 DTA123JET1 DTA115EET1 DTA144WET1	$R_1$	7.0 15.4 32.9 7.0 7.0 3.3 1.5 3.3 3.3 15.4 1.54 70 32.9	10 22 47 10 10 4.7 2.2 4.7 4.7 22 2.2 100 47	13 28.6 61.1 13 13 6.1 2.9 6.1 6.1 28.6 2.86 130 61.1	$\text{k}\Omega$
Resistor Ratio DTA114EET1/DTA124EET1 DTA144EET1/DTA115EET1 DTA114YET1 DTA114TET1/DTA143TET1 DTA123EET1/DTA143EET1 DTA143ZET1 DTA124XET1 DTA123JET1 DTA144WET1	$R_1/R_2$	0.8 0.17 – 0.8 0.055 0.38 0.038 1.7	1.0 0.21 – 1.0 0.1 0.47 0.047 2.1	1.2 0.25 – 1.2 0.185 0.56 0.056 2.6	–

6. Pulse Test: Pulse Width < 300  $\mu\text{s}$ , Duty Cycle < 2.0%

# DTA114EET1 Series

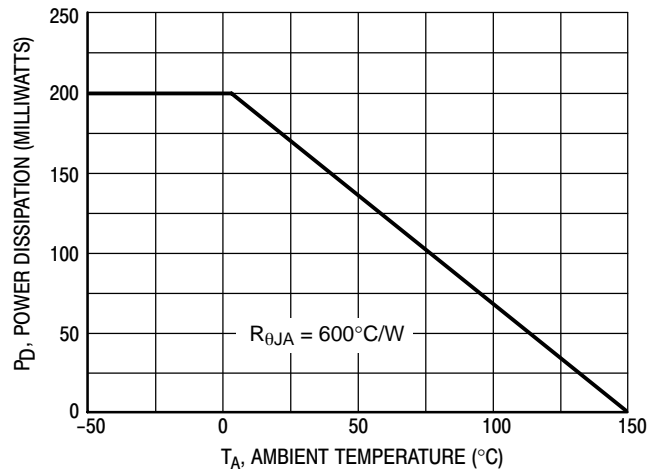

Figure 1. Derating Curve

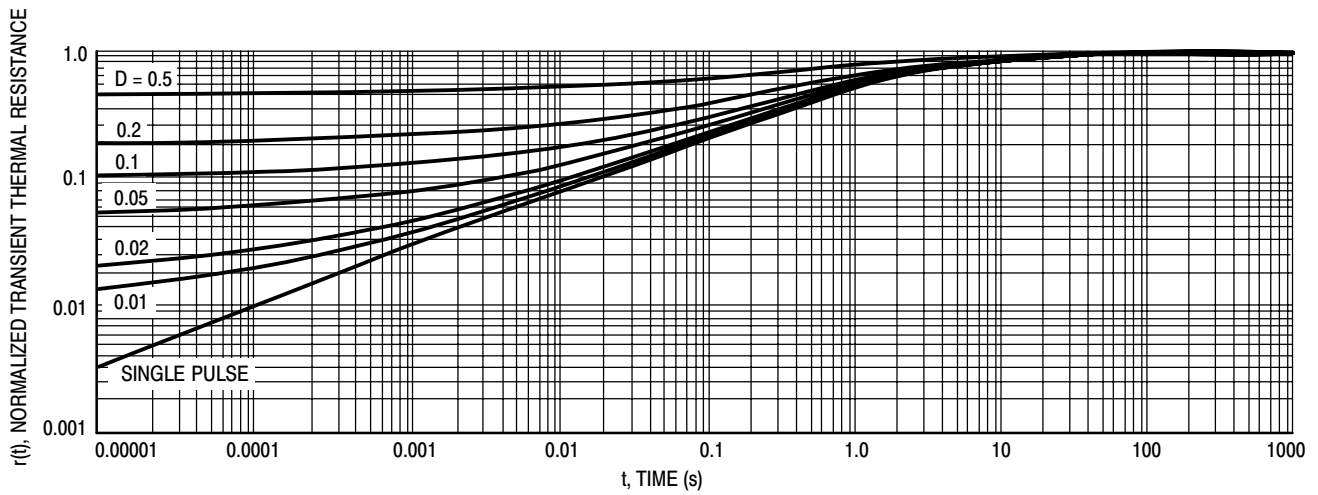

Figure 2. Normalized Thermal Response

# DTA114EET1 Series

## TYPICAL ELECTRICAL CHARACTERISTICS – DTA114EET1

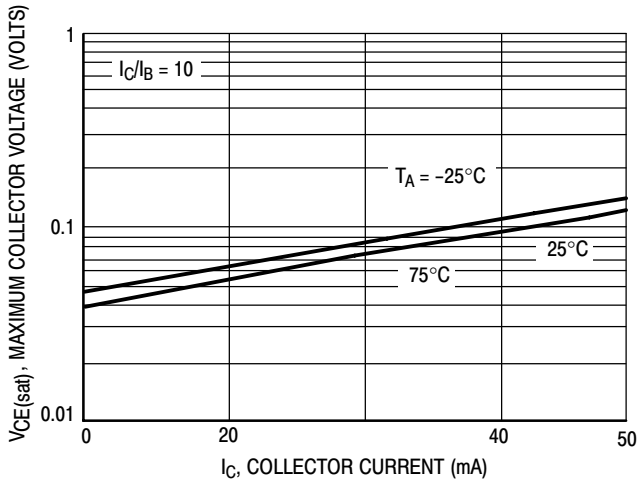

Figure 3.  $V_{CE(sat)}$  versus  $I_C$

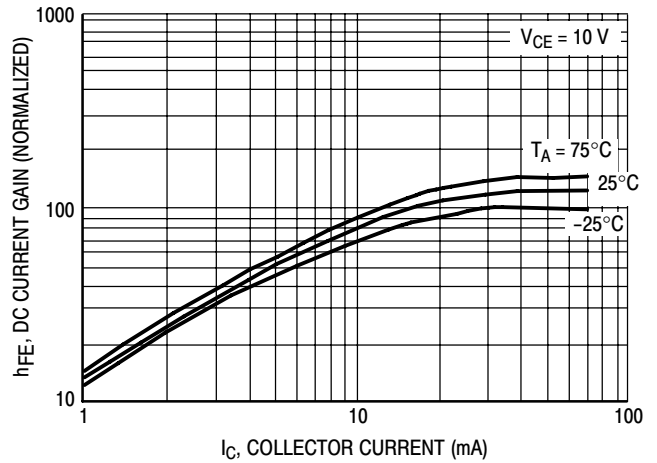

Figure 4. DC Current Gain

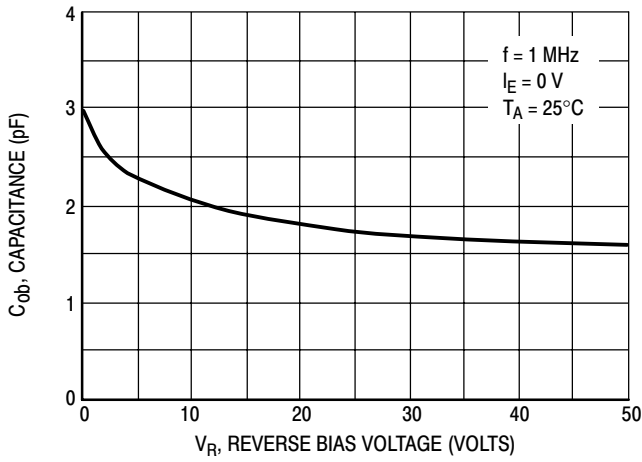

Figure 5. Output Capacitance

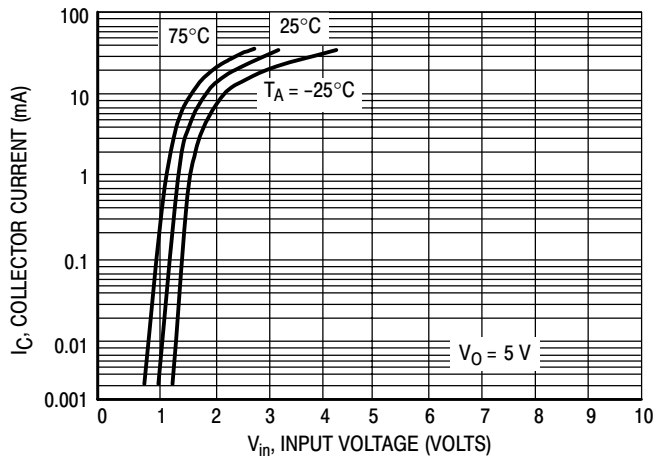

Figure 6. Output Current versus Input Voltage

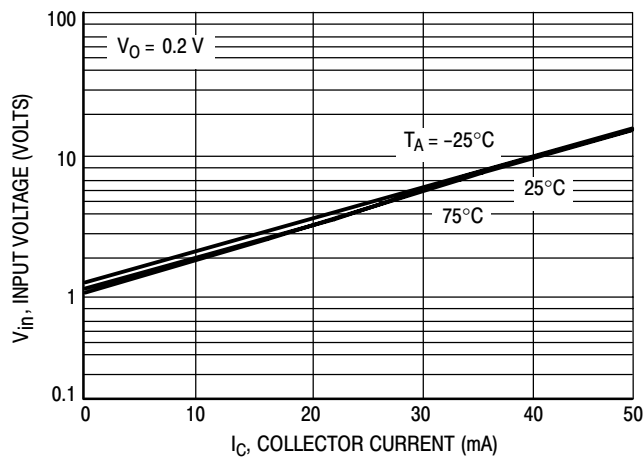

Figure 7. Input Voltage versus Output Current

# DTA114EET1 Series

## TYPICAL ELECTRICAL CHARACTERISTICS – DTA123EET1

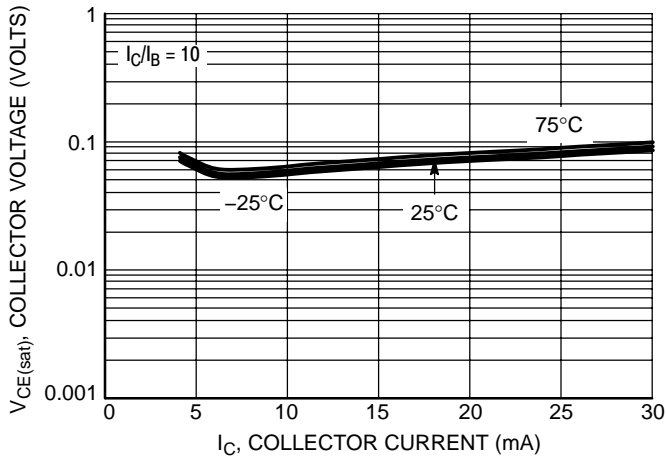

Figure 8.  $V_{CE(sat)}$  versus  $I_C$

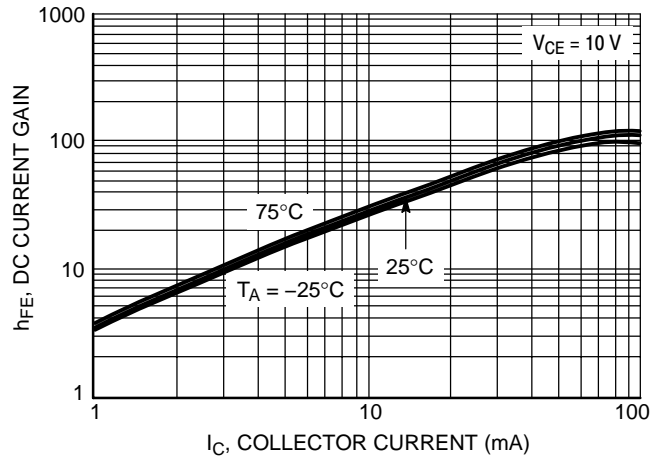

Figure 9. DC Current Gain

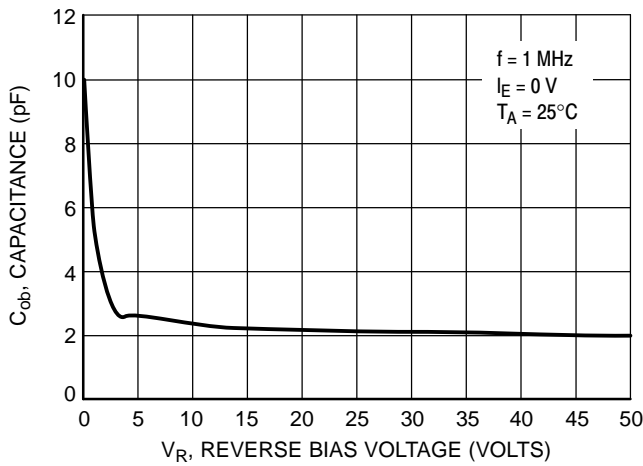

Figure 10. Output Capacitance

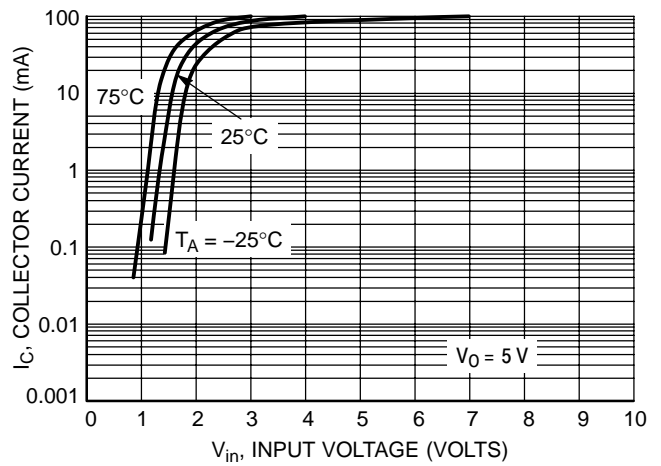

Figure 11. Output Current versus Input Voltage

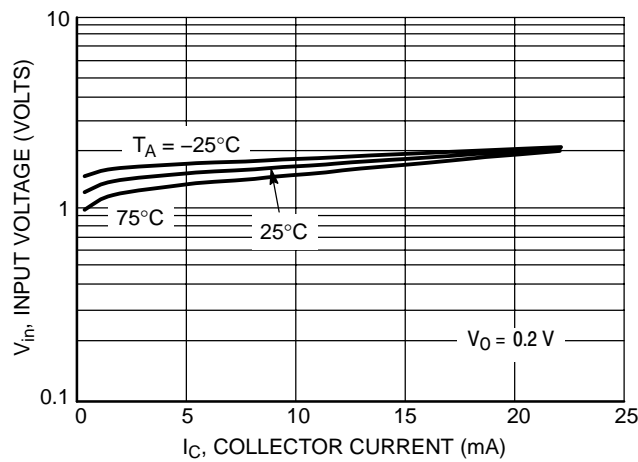

Figure 12. Input Voltage versus Output Current

# DTA114EET1 Series

## TYPICAL ELECTRICAL CHARACTERISTICS – DTA124EET1

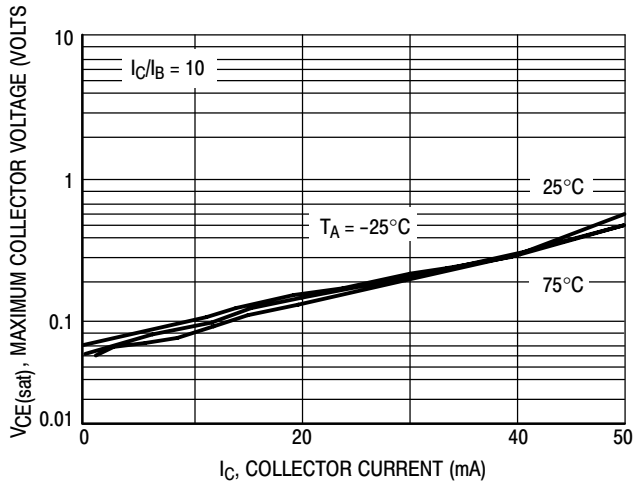

Figure 13.  $V_{CE(sat)}$  versus  $I_C$

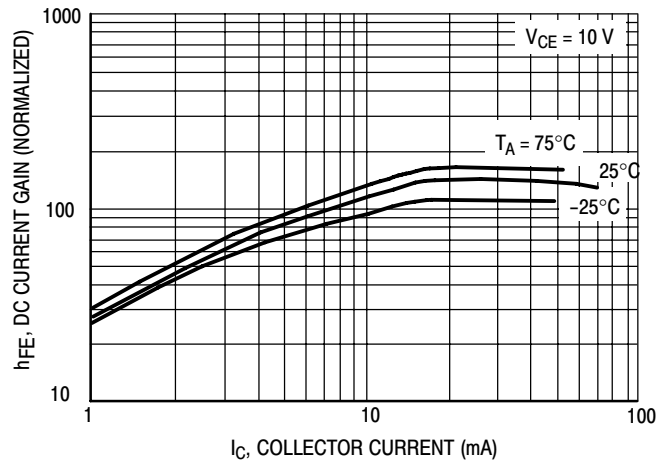

Figure 14. DC Current Gain

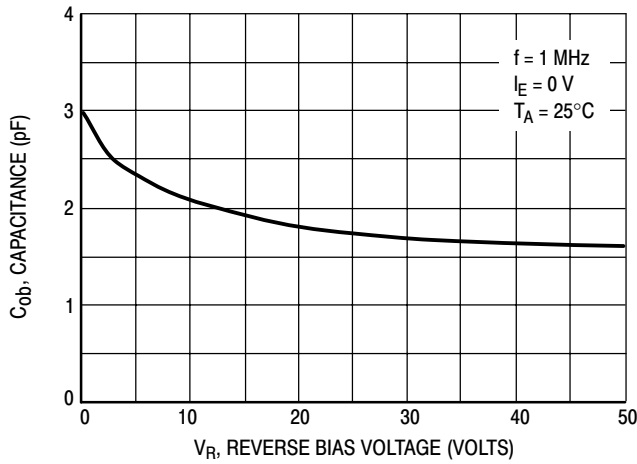

Figure 15. Output Capacitance

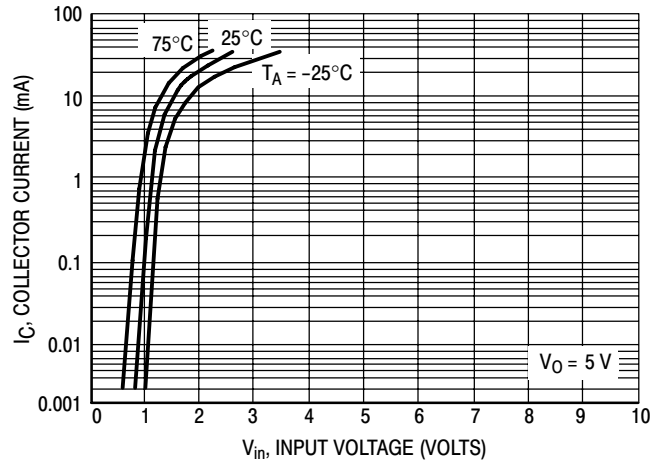

Figure 16. Output Current versus Input Voltage

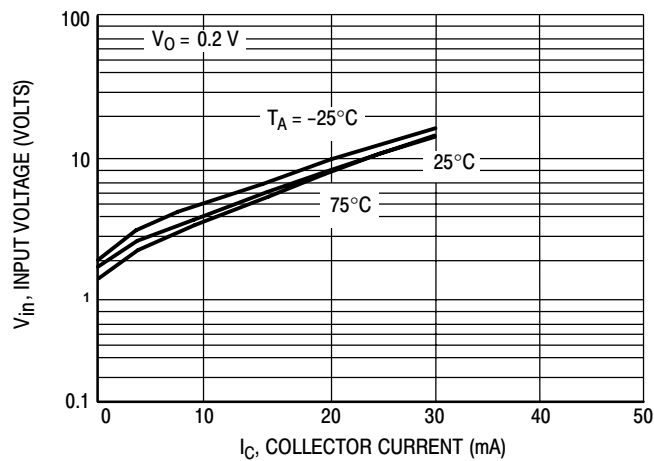

Figure 17. Input Voltage versus Output Current



# DTA114EET1 Series

## TYPICAL ELECTRICAL CHARACTERISTICS – DTA144EET1

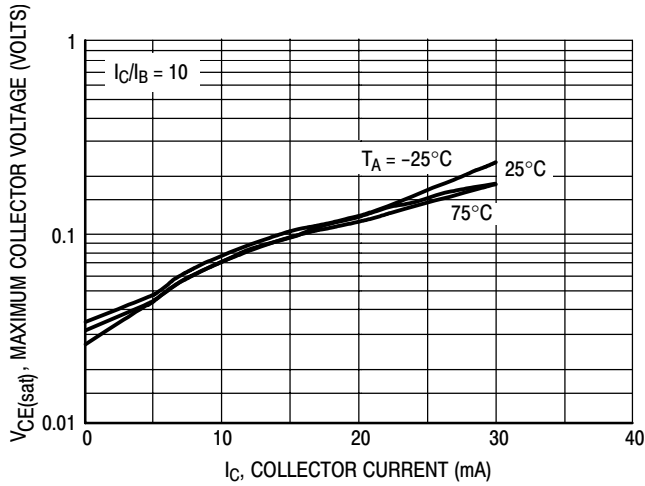

Figure 18.  $V_{CE(sat)}$  versus  $I_C$

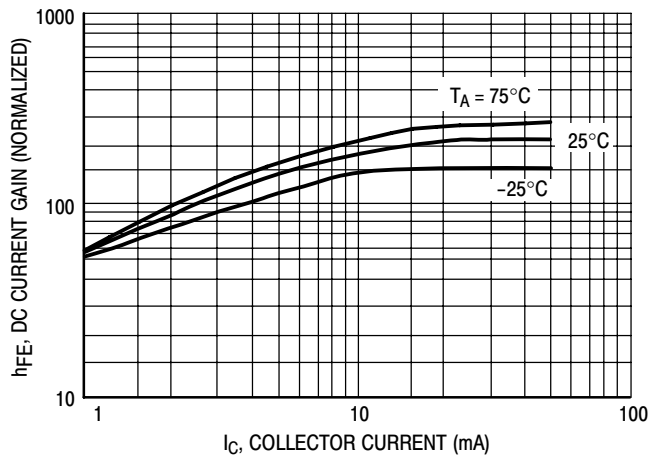

Figure 19. DC Current Gain

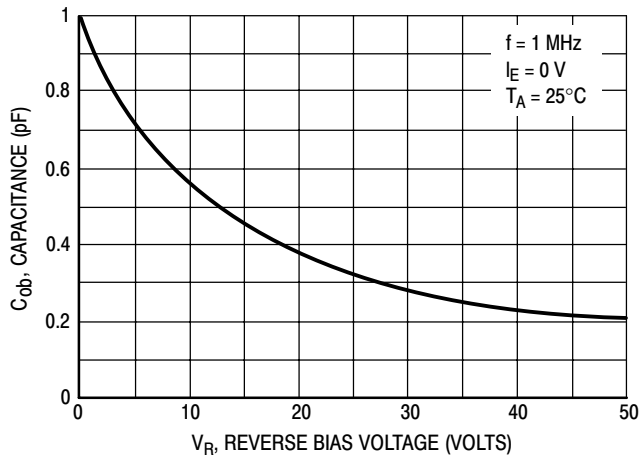

Figure 20. Output Capacitance

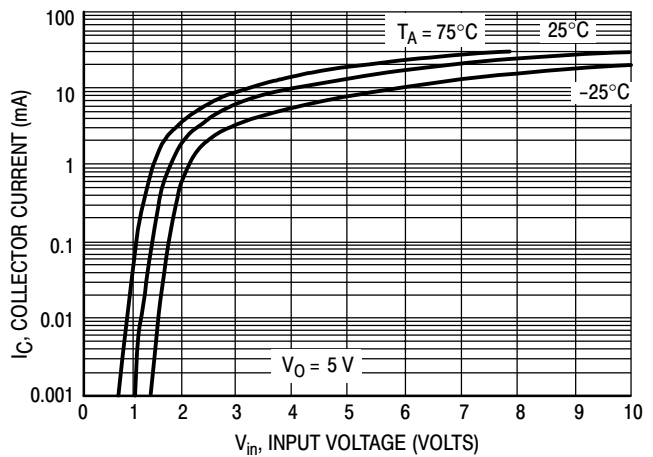

Figure 21. Output Current versus Input Voltage

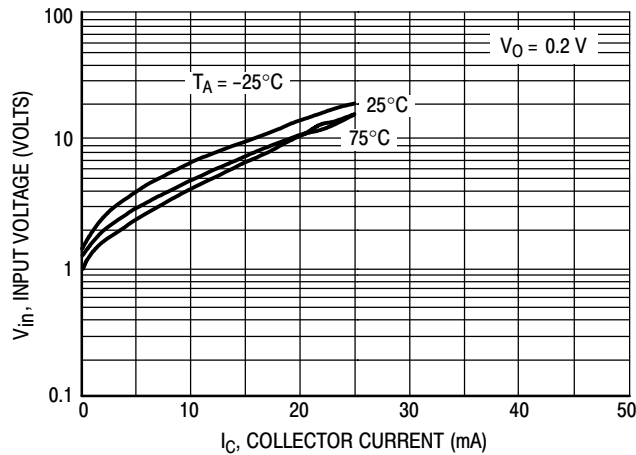

Figure 22. Input Voltage versus Output Current

TYPICAL ELECTRICAL CHARACTERISTICS – DTA114YET1

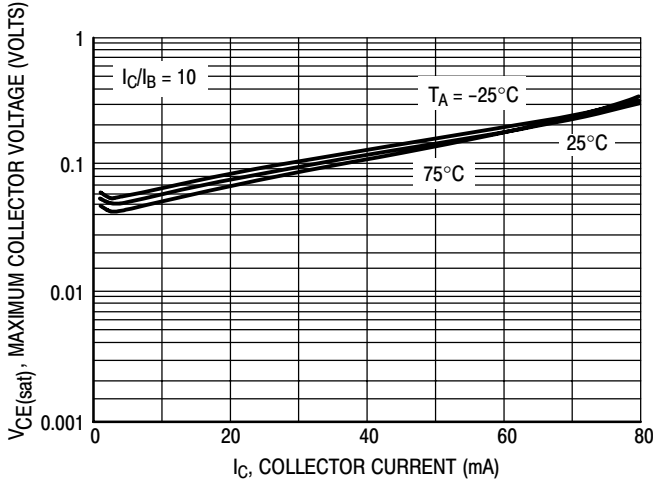

Figure 23.  $V_{CE(sat)}$  versus  $I_C$

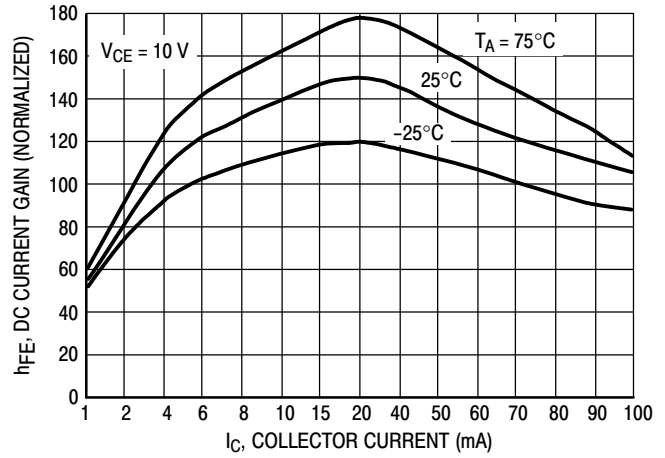

Figure 24. DC Current Gain

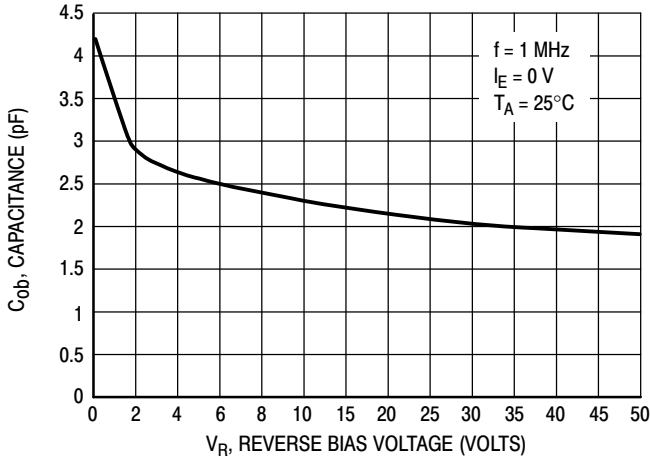

Figure 25. Output Capacitance

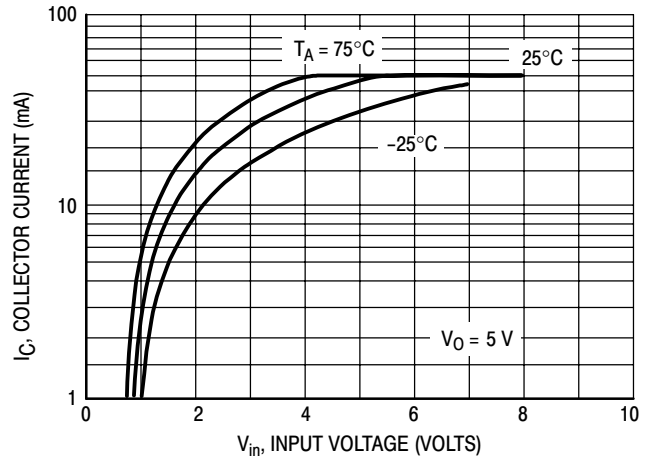

Figure 26. Output Current versus Input Voltage

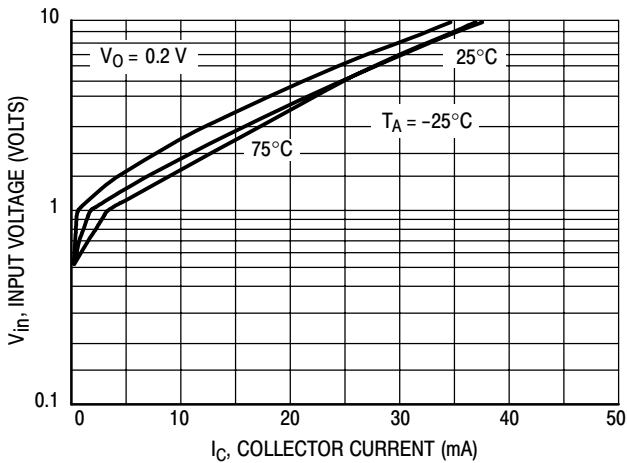

Figure 27. Input Voltage versus Output Current

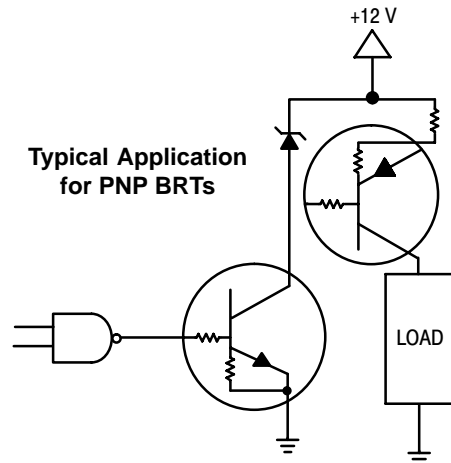
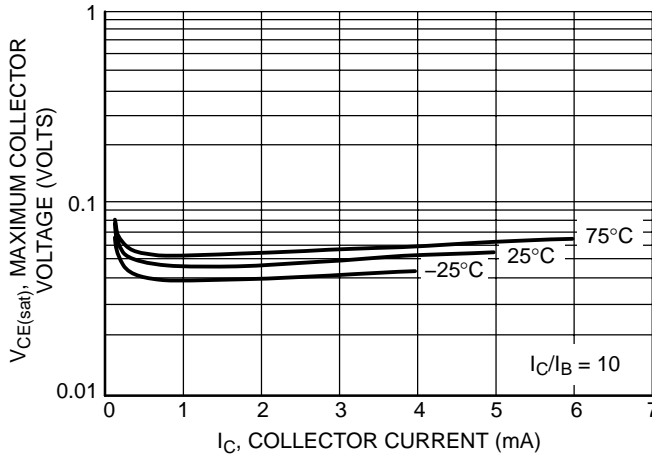

Figure 28. Inexpensive, Unregulated Current Source

# DTA114EET1 Series

## TYPICAL ELECTRICAL CHARACTERISTICS — DTA115EET1



**Figure 29. Maximum Collector Voltage versus Collector Current**

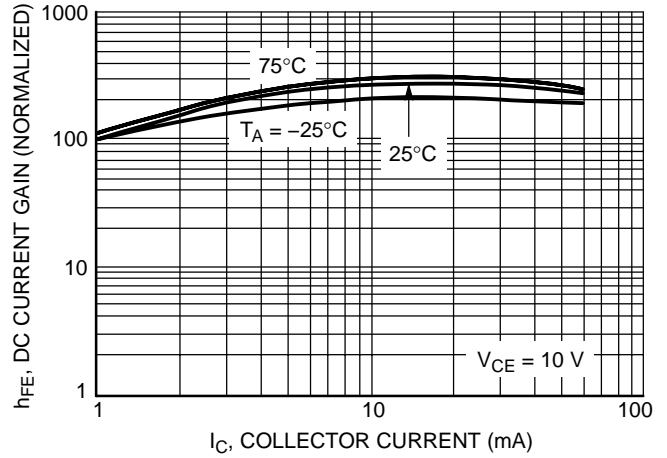

**Figure 30. DC Current Gain**

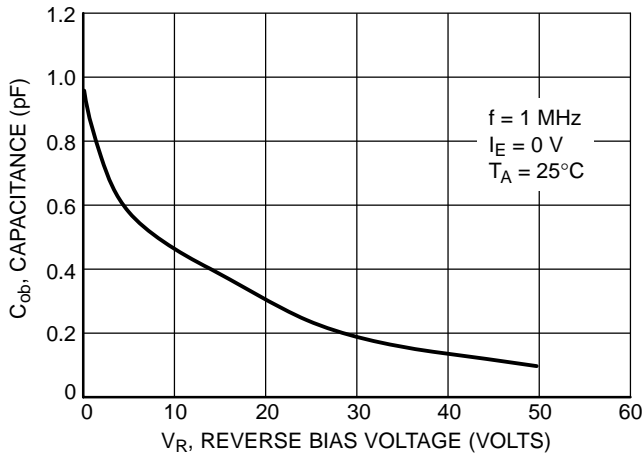

**Figure 31. Output Capacitance**

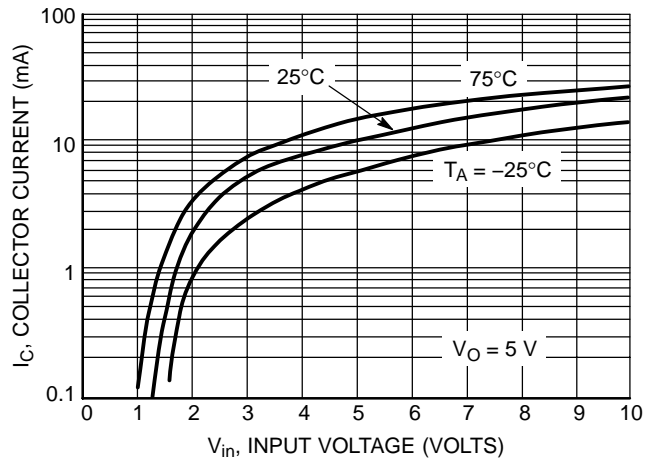

**Figure 32. Output Current versus Input Voltage**

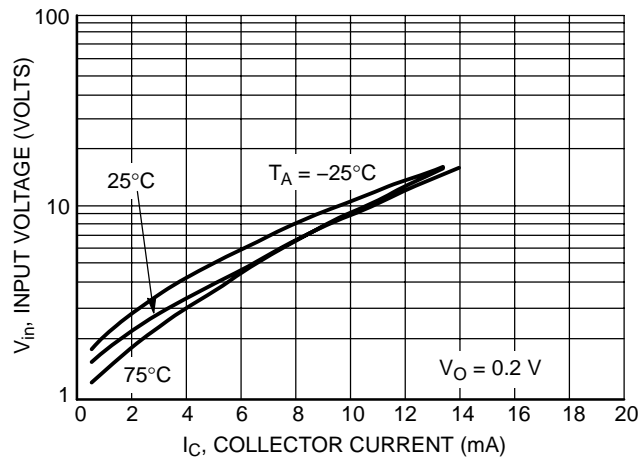

**Figure 33. Input Voltage versus Output Current**

# DTA114EET1 Series

## TYPICAL ELECTRICAL CHARACTERISTICS — DTA144WET1

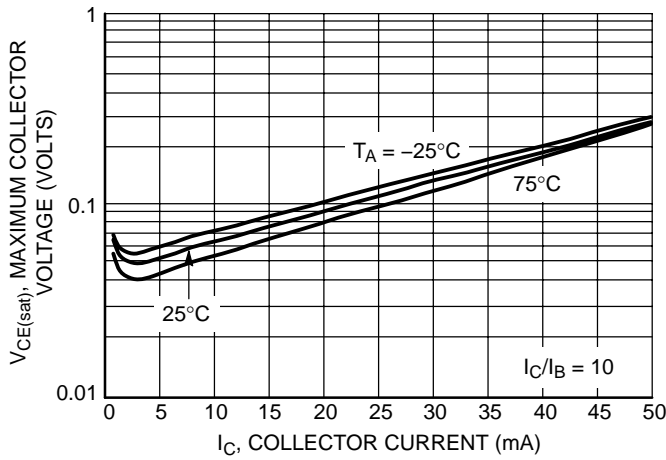

**Figure 34. Maximum Collector Voltage versus Collector Current**

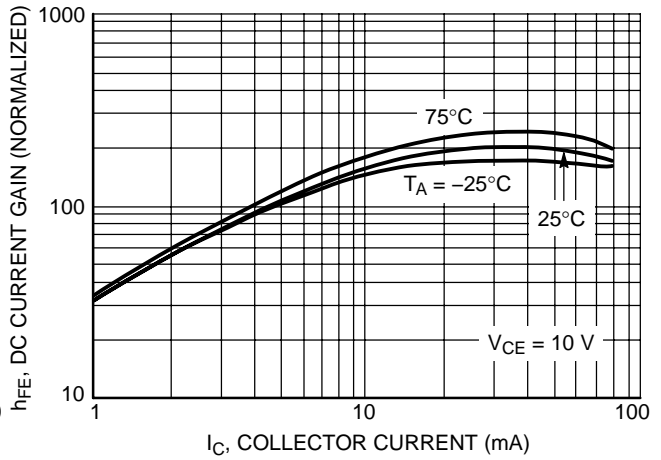

**Figure 35. DC Current Gain**

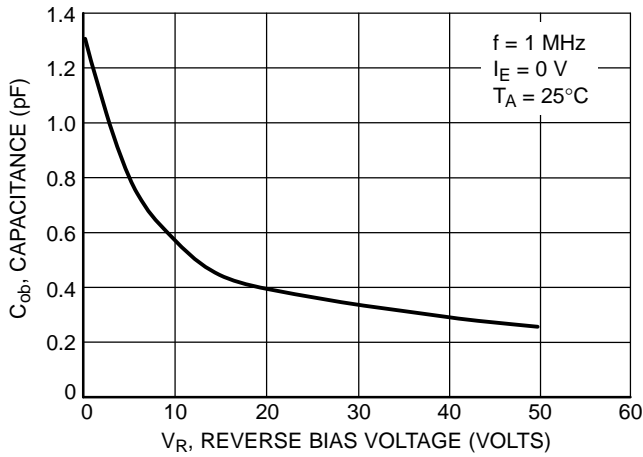

**Figure 36. Output Capacitance**

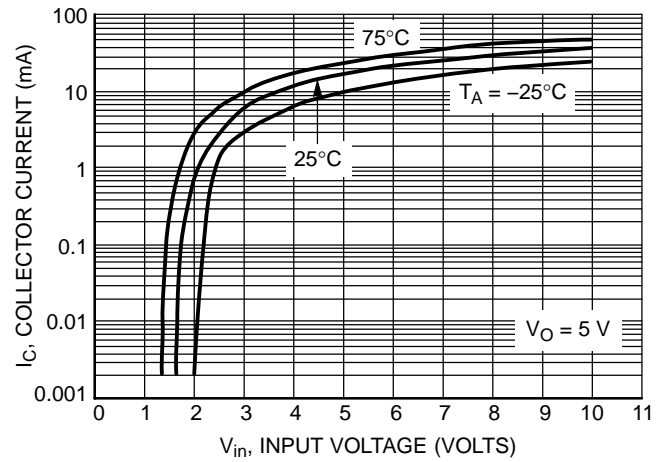

**Figure 37. Output Current versus Input Voltage**

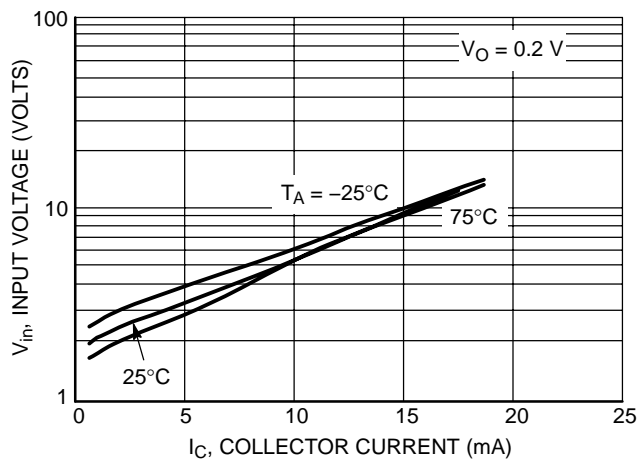
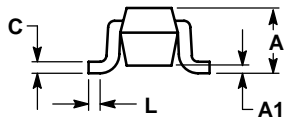
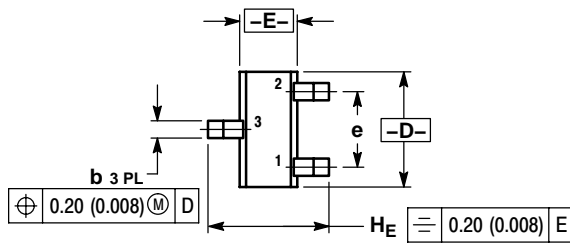

**Figure 38. Input Voltage versus Output Current**

# DTA114EET1 Series

## PACKAGE DIMENSIONS

SC-75/SOT-416  
CASE 463-01  
ISSUE F



- NOTES:  
1. DIMENSIONING AND TOLERANCING PER ANSI Y14.5M, 1982.  
2. CONTROLLING DIMENSION: MILLIMETER.

DIM	MILLIMETERS			INCHES		
	MIN	NOM	MAX	MIN	NOM	MAX
A	0.70	0.80	0.90	0.027	0.031	0.035
A1	0.00	0.05	0.10	0.000	0.002	0.004
b	0.15	0.20	0.30	0.006	0.008	0.012
C	0.10	0.15	0.25	0.004	0.006	0.010
D	1.55	1.60	1.65	0.059	0.063	0.067
E	0.70	0.80	0.90	0.027	0.031	0.035
e	1.00 BSC			0.04 BSC		
L	0.10	0.15	0.20	0.004	0.006	0.008
H <sub>E</sub>	1.50	1.60	1.70	0.061	0.063	0.065

- STYLE 1:  
PIN 1. BASE  
2. EMITTER  
3. COLLECTOR

### SOLDERING FOOTPRINT\*

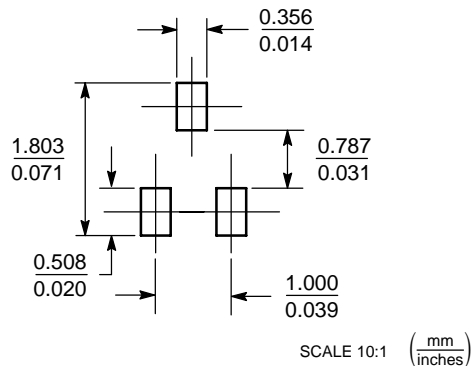

\*For additional information on our Pb-Free strategy and soldering details, please download the ON Semiconductor Soldering and Mounting Techniques Reference Manual, SOLDERRM/D.

ON Semiconductor and are registered trademarks of Semiconductor Components Industries, LLC (SCILLC). SCILLC reserves the right to make changes without further notice to any products herein. SCILLC makes no warranty, representation or guarantee regarding the suitability of its products for any particular purpose, nor does SCILLC assume any liability arising out of the application or use of any product or circuit, and specifically disclaims any and all liability, including without limitation special, consequential or incidental damages. "Typical" parameters which may be provided in SCILLC data sheets and/or specifications can and do vary in different applications and actual performance may vary over time. All operating parameters, including "Typicals" must be validated for each customer application by customer's technical experts. SCILLC does not convey any license under its patent rights nor the rights of others. SCILLC products are not designed, intended, or authorized for use as components in systems intended for surgical implant into the body, or other applications intended to support or sustain life, or for any other application in which the failure of the SCILLC product could create a situation where personal injury or death may occur. Should Buyer purchase or use SCILLC products for any such unintended or unauthorized application, Buyer shall indemnify and hold SCILLC and its officers, employees, subsidiaries, affiliates, and distributors harmless against all claims, costs, damages, and expenses, and reasonable attorney fees arising out of, directly or indirectly, any claim of personal injury or death associated with such unintended or unauthorized use, even if such claim alleges that SCILLC was negligent regarding the design or manufacture of the part. SCILLC is an Equal Opportunity/Affirmative Action Employer. This literature is subject to all applicable copyright laws and is not for resale in any manner.

### PUBLICATION ORDERING INFORMATION

**LITERATURE FULFILLMENT:**  
Literature Distribution Center for ON Semiconductor  
P.O. Box 61312, Phoenix, Arizona 85082-1312 USA  
**Phone:** 480-829-7710 or 800-344-3860 Toll Free USA/Canada  
**Fax:** 480-829-7709 or 800-344-3867 Toll Free USA/Canada  
**Email:** orderlit@onsemi.com

**N. American Technical Support:** 800-282-9855 Toll Free  
USA/Canada

**Japan:** ON Semiconductor, Japan Customer Focus Center  
2-9-1 Kamimeguro, Meguro-ku, Tokyo, Japan 153-0051  
**Phone:** 81-3-5773-3850

**ON Semiconductor Website:** <http://onsemi.com>

**Order Literature:** <http://www.onsemi.com/litorder>

For additional information, please contact your local Sales Representative.

DTA114EET1/D