

PRODUCT NUMBER
SEE TABLE

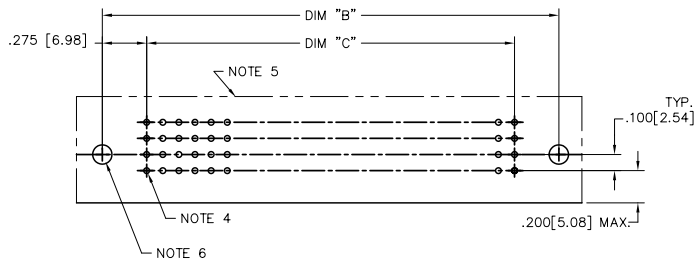
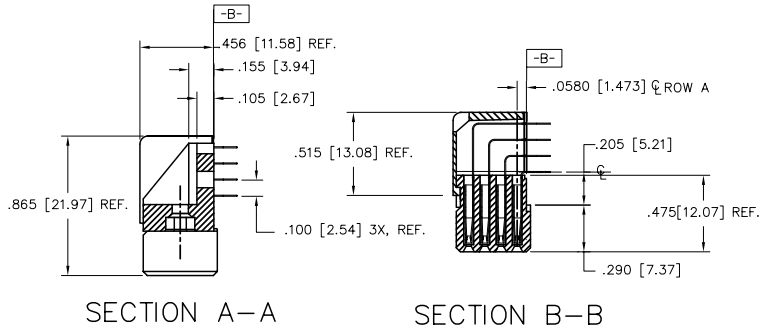

RECOMMENDED PCB LAYOUT
(ALL HOLES LOCATED ON .100[2.54]
GRID UNLESS OTHERWISE SHOWN)

mat'l code	NOTE 3	surface	ISO 1902	tolerance	ISO 406 ISO 1101	projection	product family	HPC
itr	ecm no	dr	date	tolerances unless otherwise specified		INCH/MM	title	
w				angles	linear		scale	4 ROW R/A RECEPTACLE PRESS FIT
				0°±2°	XXX.X/XXX.X	1:1	dwg no	sheet 2 of 7 size
				dr	D.INGRAM	7/13/05	50642 A3	
				engr	D.HORCHLER	7/13/05	type	
				chr	T.BREWBAKER	7/13/05	Product Customer Drawing	
				appd	D.HORCHLER	7/13/05		
sheet index	revision sheet							

PRODUCT NUMBER
SEE TABLE

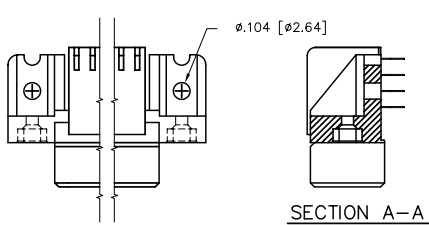

SPECIAL FEATURE OPTION A
SEE NOTE 6

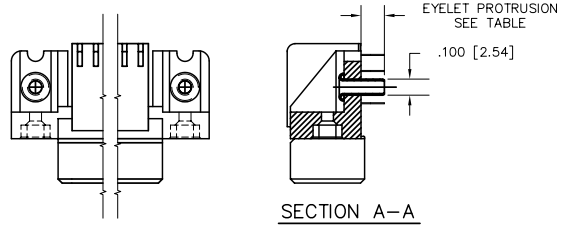

SPECIAL FEATURE OPTION B
SEE NOTE 6

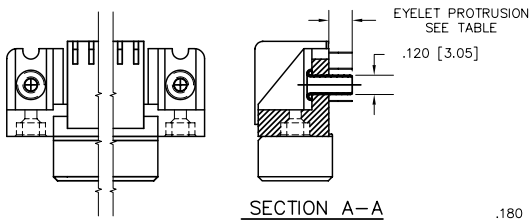

SPECIAL FEATURE OPTION C
SEE NOTE 6

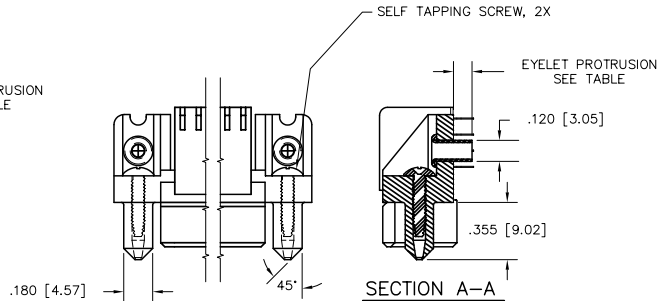

SPECIAL FEATURE OPTION D
SEE NOTE 6

mat'l. code		surface	tolerance	projection	product family
NOTE 3		ISO 1902	ISO 406		HPC
			ISO 1101		
itr	ecrn no	dr	date	title	
				4 ROW R/A RECEPTACLE	
				PRESS FIT	
w				dwg no	sheet 3 of 7 size
				50642	A3
				type	Product Customer Drawing
sheet	revision				
index	sheet				

PRODUCT NUMBER
SEE TABLE

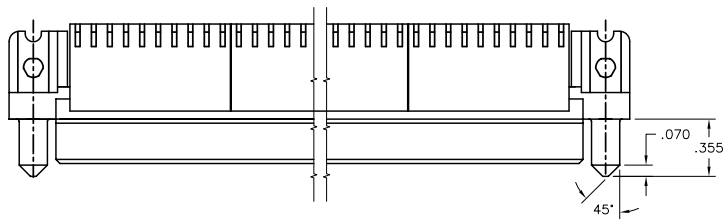

SPECIAL FEATURE OPTION E
SEE NOTE 6

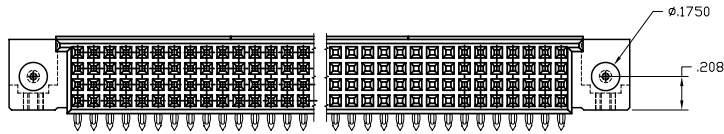

mat'l. code		surface		tolerance		projection		product family	
NOTE 3		ISO 1802		ISO 406		1st angle		HPC	
itr	ecm no	dr	date	tolerances unless otherwise specified				title	
w				angles	linear	INCH/MM		4 ROW R/A RECEPTACLE PRESS FIT	
				0°±2°	XXX±.05/XXX.13	scale 1:1		dwg no	
				dr	D.INGRAM	7/13/05	FCJ		sheet 4 of 7
				enrg	D.HORCHLER	7/13/05	50642		A3
				chr	T.BREWBAKER	7/13/05	type		Product Customer Drawing
				appd	D.HORCHLER	7/13/05			
sheet	revision								
index	sheet								

PDM: Rev:W STATUS:Released Printed: Feb 20, 2010

PRODUCT NUMBER
50642-XX004
50642-XX004LF

SELECT LOAD (50642-XX004 AND 50642-XX004LF ONLY)

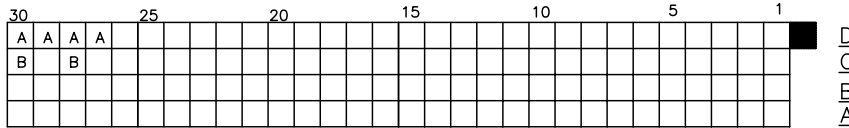
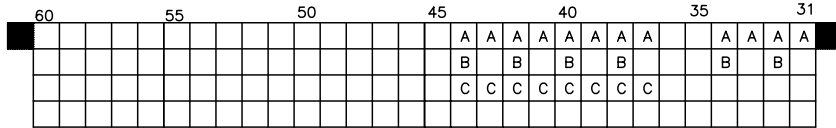

TERM.
1

SPECIAL NOTES FOR -XX004 AND -XX004LF ONLY:

1. ALL POSITIONS ARE LOADED, EXCEPT OMITTS AS SHOWN.
2. COLUMN 1, ROW A IS DESIGNATED AS SIGNAL TERM. 1, AS VIEWED FROM THE MATING FACE.
3. BECAUSE OF THE SELECT LOAD TERMINAL POSITIONS, ONLY 2 PRESS BLOCKS NEED TO BE INSTALLED-ONE PLACED STARTING IN COL. 25(*) AND ENDING IN COL. 34 THE OTHER PLACED STARTING IN COL. 35(*) AND ENDING IN COL.44.
4. SIGNAL DATA FOR 50642-XX004 AND -XX004LF:

SIZE 4 x 60
TOTAL NO. OF POSITIONS - 240
NO. OF POSITIONS LOADED - 032

ITEM KEY	QTY.
A	16
B	8
C	8
BLANK	208

mat'l code	surface ISO 1902	tolerance ISO 406 ISO 1101	projection ASME Y14.5	product family HPC
NOTE 3	tolerances unless otherwise specified		INCH/MM	title 4 ROW R/A RECEPTACLE PRESS FIT
tr	ecm no	dr	date	scale 1:1
w				dwg no 50642
				sheet 5 of 7 size A3
				type Product Customer Drawing
dr	D.INGRAM	7/13/05		
enrg	D.HORCHLER	7/13/05		
chr	T.BREWBAKER	7/13/05		
appd	D.HORCHLER	7/13/05		
sheet index	revision	sheet		

PRODUCT NUMBER	NUMBER OF POSITIONS NOTE 2	TAIL LENGTH	SPECIAL FEATURES SEE NOTE 6	SOLDER TAIL PLATING	CONTACT PLATING	EYELET PROTRUSION	GUIDE PINS
50642-1YYYE	YYY	.125±.010/3.18±.25	-	TIN LEAD	30u"/.76u Au	N/A	NONE
50642-1YYYELF	YYY	.125±.010/3.18±.25	-	TIN	30u"/.76u GXT	N/A	NONE
50642-1YYYEA	YYY	.125±.010/3.18±.25	"A"	TIN LEAD	30u"/.76u Au	N/A	NONE
50642-1YYYEALF	YYY	.125±.010/3.18±.25	"A"	TIN	30u"/.76u GXT	N/A	NONE
50642-1YYYEB	YYY	.125±.010/3.18±.25	"B"	TIN LEAD	30u"/.76u Au	.145/3.68	NONE
50642-1YYYEBLF	YYY	.125±.010/3.18±.25	"B"	TIN	30u"/.76u GXT	.145/3.68	NONE
50642-1YYYEC	YYY	.125±.010/3.18±.25	"C"	TIN LEAD	30u"/.76u Au	.115/2.92	NONE
50642-1YYYECLF	YYY	.125±.010/3.18±.25	"C"	TIN	30u"/.76u GXT	.115/2.92	NONE
50642-1YYYED	YYY	.125±.010/3.18±.25	"D"	TIN LEAD	30u"/.76u Au	.115/2.92	2
50642-1YYYEDLF	YYY	.125±.010/3.18±.25	"D"	TIN	30u"/.76u GXT	.115/2.92	2
50642-1YYYEE	YYY	.125±.010/3.18±.25	"E"	TIN LEAD	30u"/.76u Au	N/A	2
50642-1YYYEELF	YYY	.125±.010/3.18±.25	"E"	TIN	30u"/.76u GXT	N/A	2
50642-1YYYF	YYY	.145±.010/3.68±.25	-	TIN LEAD	30u"/.76u Au	N/A	NONE
50642-1YYYFLF	YYY	.145±.010/3.68±.25	-	TIN	30u"/.76u GXT	N/A	NONE
50642-1YYYFA	YYY	.145±.010/3.68±.25	"A"	TIN LEAD	30u"/.76u Au	N/A	NONE
50642-1YYYFALF	YYY	.145±.010/3.68±.25	"A"	TIN	30u"/.76u GXT	N/A	NONE
50642-1YYYFC	YYY	.145±.010/3.68±.25	"C"	TIN LEAD	30u"/.76u Au	.145/3.68	NONE
50642-1YYYFCLF	YYY	.145±.010/3.68±.25	"C"	TIN	30u"/.76u GXT	.145/3.68	NONE
50642-1YYYFD	YYY	.145±.010/3.68±.25	"D"	TIN LEAD	30u"/.76u Au	.145/3.68	2
50642-1YYYFDLF	YYY	.145±.010/3.68±.25	"D"	TIN	30u"/.76u GXT	.145/3.68	2
50642-1YYYFE	YYY	.145±.010/3.68±.25	"E"	TIN LEAD	30u"/.76u Au	N/A	2
50642-1YYYFELF	YYY	.145±.010/3.68±.25	"E"	TIN	30u"/.76u GXT	N/A	2
50642-XX004	240	.125±.010/3.18±.25	SEE SHEET 5	TIN LEAD	30u"/.76u Au	N/A	NONE
50642-XX004LF	240	.125±.010/3.18±.25	SEE SHEET 5	TIN	30u"/.76u GXT	N/A	NONE

mat'l code	NOTE 3	surface	ISO 1902	tolerance	ISO 406	projection	product family	HPC
itr	ecm no	dr	date	tolerances unless otherwise specified	angles	linear	INCH/MM	title
w				0°±2°	D	JINGRAM	7/13/05	4 ROW R/A RECEPTACLE PRESS FIT
				enrg	D.HORCHLER	7/13/05	scale	1:1
				chr	T.BREWBAKER	7/13/05	FCJ	dwg no
				appd	D.HORCHLER	7/13/05	50642	sheet 6 of 7
sheet index	revision sheet							size
								A3
								type
								Product Customer Drawing

PRODUCT NUMBER
SEE TABLE

NOTES:

1. PRODUCT NUMBERING CODE

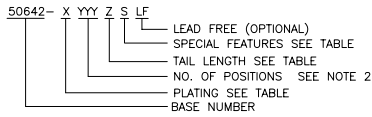

PRODUCT NUMBERING CODE FOR SELECT LOAD

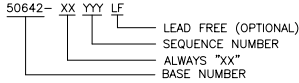

- THIS PRODUCT IS CONFIGURED IN SIZES OF 6 THRU 80 COLUMNS IN INCREMENTS OF ONE, i.e. 6, 7, 8, 9,79, 80.
- MATERIAL: PRESS BLOCK - HIGH TEMP THERMOPLASTIC; HOUSING--GLASS AND MINERAL FILLED HIGH TEMPERATURE THERMOPLASTIC, FLAME RETARDANT PER UL94V-0. COLOR--BLACK CONTACT--BeCu
- DRILLED HOLE DIA OF .0453±.001 INCH FINISHED TO .0400±.0030 INCH BY PLATING SnPb OR OTHER PLATING 0.0003 TO 0.0006 INCHES THICK WITH A COPPER UNDERPLATE AS NEEDED.
- INFORMATION DOCUMENT: FOR PCB STAY- AWAY ZONE, SEE TA-0954.
- SPECIAL FEATURES (SEE PRODUCT NUMBER TABLE, AND DETAILS ON SHEET 3)
 - IF NO SPECIAL FEATURE CODE IS SELECTED, PCB MOUNTING HOLE DIMENSION TO BE $\phi.120\pm.003[3.05\pm 0.07]$
 - "A" PCB MOUNTING HOLE DIMENSION TO BE $\phi.100\pm.003[2.54\pm 0.07]$
 - "B" INCLUDES PRE-INSTALLED EYELETS FOR PCB ATTACHMENT IN A $\phi.100\pm.003[2.54\pm 0.07]$ MOUNTING HOLE. (E TAIL ONLY)
 - "C" INCLUDES PRE-INSTALLED EYELETS FOR PCB ATTACHMENT IN A $\phi.120\pm.003[3.05\pm 0.07]$ MOUNTING HOLE.
 - "D" INCLUDES PRE-INSTALLED EYELETS WITH MOLDED GUIDE PINS FOR PCB ATTACHMENT IN A $\phi.120\pm.003[3.05\pm 0.07]$ MOUNTING HOLE.
 - "E" INCLUDES MOLDED GUIDE PINS WITH TRI-HOLE SHAPED MOUNTING HOLES. (EYELETS NOT INSTALLED)
- LENGTH CALCULATIONS:
 DIMENSION "A" CALCULATION = $.100 [2.54] \times \text{NO. OF COLUMNS} + .75 [19.1]$
 DIMENSION "B" CALCULATION = $.100 [2.54] \times \text{NO. OF COLUMNS} + .450 [11.43]$
 DIMENSION "C" CALCULATION = $.100 [2.54] \times \text{NO. OF COLUMNS} - .100 [2.54]$
- MANUFACTURE'S LOGO, PN, AND LOT CODE TO APPEAR ON THIS SURFACE.
- THIS PRODUCT (WITH "LF" SUFFIX) MEETS EUROPEAN UNION DIRECTIVES AND OTHER COUNTRY REGULATIONS AS DESCRIBED IN GS-22-008.
- THIS HOUSING WILL WITHSTAND EXPOSURE TO 260°C PEAK TEMPERATURE FOR 10-30 SECONDS IN A CONVECTION, INFRA-RED OR VAPOR PHASE REFLOW OVEN.
- ALL POSITIONS ARE LOADED EXCEPT FOR -XXXXY ASSEMBLIES WHICH HAVE SELECTIVE LOADING.

mat'l code	NOTE 3	surface	ISO 1902	tolerance	ISO 406	projection	product family
itr	ecr no	dr	date	tolerances unless otherwise specified			HPC
w				angles	linear	INCH/MM	title
				0°±2°	XXX±.05/XXX±.13	scale 1:1	4 ROW R/A RECEPTACLE PRESS FIT
				dr	D.INGRAM	7/13/05	dwg no
				engr	D.HORCHLER	7/13/05	sheet 7 of 7
				chr	T.BREWBAKER	7/13/05	size
				appd	D.HORCHLER	7/13/05	A3
sheet	revision						type
index	sheet						Product Customer Drawing