

PRODUCT NUMBER
SEE TABLE

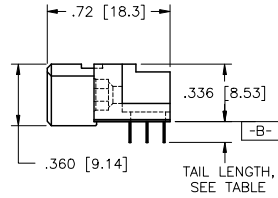
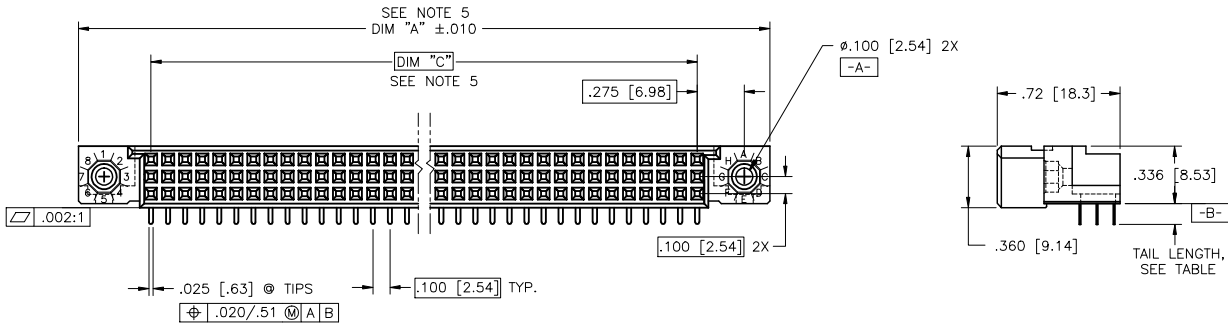
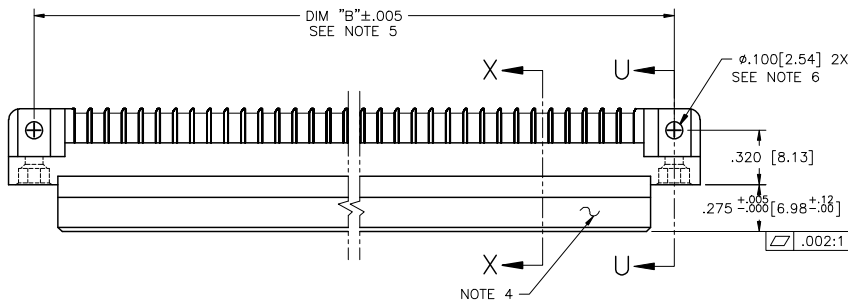

mal't. code				surface	tolerance	projection	product family
NOTE 3				ISO 1902	ISO 1906 ISO 1901		HPC
lfr	ec'n no	dr	date	tolerances unless otherwise specified		INCH/MM	title
J	V00254	JWS	1/13/00	angles	XX±.01/XX±.03		3 ROW R/A RECEPTACLE
K	V01300	HTB	4/13/00	linear	XXX±.005/XX±.013	scale 1:1	SOLDER TO BOARD, 0 G.P.
L	V05-0895	DCH	9/20/05	0'±2'	XXXX±.0020/XXX±.0061		dwg no
M	V05-1052	DAI	11/17/05	dr	G.PETERS	6/5/96	sheet 1 of 5
N	M06-0283	MHT	7/27/06	engr	S.CLARK	6/3/95	size
P	M07-0099	AGS	2/09/07	chr	S.CLARK	6/5/95	A3
R	M08-0280	AGS	9/30/08	appd	S.CLARK	6/5/95	type
sheet	revision	R	R	R	R	R	Product Customer Drawing
index	sheet	1	2	3	4	5	

PDM: Rev:R STATUS:Released Printed: Feb 18, 2010

PRODUCT NUMBER
SEE TABLE

NOTES:

- ① PRODUCT NUMBERING CODE:
50294 - X YYY Z S LF
 - LEAD FREE (OPTIONAL)
 - SPECIAL FEATURES (NOTE 6)
 - TAIL LENGTH (SEE TABLE)
 - NO. OF POSITIONS (NOTE 2)
 - PLATING (SEE TABLE)
 - BASE NUMBER
- ② THIS PRODUCT IS CONFIGURED IN SIZES OF 6 thru 80 COLUMNS IN INCREMENTS OF ONE.
i.e.: 6,7,8,9.....79,80.
- ③ HOUSING MATERIAL: GLASS & MINERAL FILLED HIGH-TEMP THERMOPLASTIC, FLAME RETARDANT PER UL94 V-0.
CONTACT MATERIAL: BeCu
- ④ MANUFACTURE'S NAME, PART NUMBER AND LOT CODE TO APPEAR ON THIS SURFACE PER BUS-12-108.
- ⑤ LENGTH DIMENSION FORMULAS:
DIM "A" = .100/2.54 x NO. OF COLUMNS + .75/19.1
DIM "B" = .100/2.54 x NO. OF COLUMNS + .450/11.43
DIM "C" = .100/2.54 x NO. OF COLUMNS - .100/2.54
- ⑥ SPECIAL FEATURES (SEE SHEET 3) AND TABLE.
- = IF CODE IS OMITTED FROM PRODUCT NUMBER: CONNECTOR IS PROVIDED AS SHOWN, NO SPECIAL FEATURES ARE SELECTED. FOR P.C.B. ATTACHMENT IN A ϕ .120[3.05] MOUNTING HOLE.
"A" = IF SPECIFIED, PRE-INSTALLED CLAW FOR P.C.B. ATTACHMENT IN A ϕ .100[2.54] MOUNTING HOLE. AVAILABLE IN "E" TAIL LENGTH ONLY.
"B" = IF SPECIFIED, PRE-INSTALLED CLAW FOR P.C.B. ATTACHMENT IN A ϕ .120[3.05] MOUNTING HOLE.
"C" = IF SPECIFIED, MOLDED GUIDE PINS WITH PRE-INSTALLED CLAW FOR P.C.B. ATTACHMENT IN A ϕ .120[3.05] MOUNTING HOLE.
"D" = IF SPECIFIED, MOLDED GUIDE PINS WITH ϕ .120[3.05] MOUNTING HOLE (NO CLAW).
- ⑦ CLAW DIMENSION DETERMINED BY P.C.B. HOLE DIAMETER.
8. THIS PRODUCT (WITH "LF" SUFFIX) MEETS EUROPEAN UNION DIRECTIVES AND OTHER COUNTRY REGULATIONS AS DESCRIBED IN GS-22-008.
9. THIS HOUSING WILL WITHSTAND EXPOSURE TO 260 DEGREES C PEAK TEMPERATURE FOR 10-30 SECONDS IN A CONVECTION, INFRA-RED OR VAPOR PHASE REFLOW OVEN.
- ⑩ PLATING OPTION:
MAY BE EITHER GOLD OR GXT PLATED AT MANUFACTURER'S OPTION.

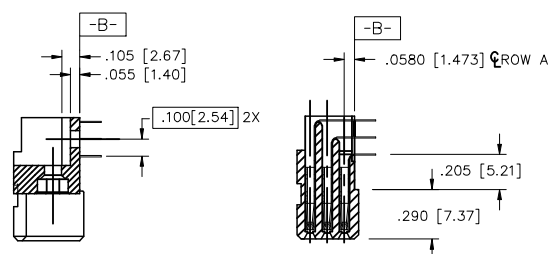

SECTION U-U
NO SPECIAL FEATURE

SECTION X-X

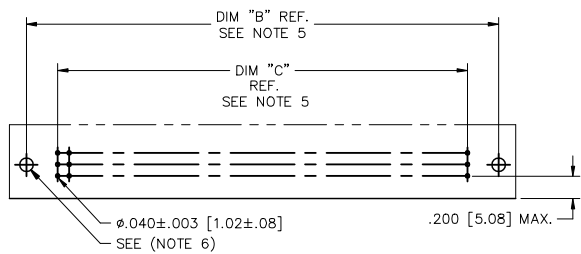

RECOMMENDED PCB LAYOUT
(ALL HOLES LOCATED ON .100 [2.54] GRID UNLESS OTHERWISE SPECIFIED)

mal't code		surface		tolerance		projection		product family		
NOTE 3		ISO 1902		ISO 146		ISO 1001		HPC		
lfr	ecn no	dr	date	tolerances unless otherwise specified		INCH/MM		title		
R				angles	linear	XX±.01/XX±0.3		3 ROW R/A RECEPTACLE		
				0'±2'		XXX±.005/XX±0.13		SOLDER TO BOARD, 0 G.P.		
						XXXX±.0020/XXX±0.061		scale 1:1		
		dr	G.PETERS	6/5/96		FCJ		dwg no		
		eng	S.CLARK	6/3/95				sheet 2 of 5		size
		chr	S.CLARK	6/5/95				50294		A3
		appd	S.CLARK	6/5/95				type Product Customer Drawing		
sheet	revision									
index	sheet									

PRODUCT NUMBER
SEE TABLE

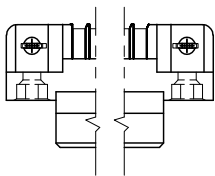

SECTION U-U

SPECIAL FEATURE OPTION "A"
SEE NOTE 6

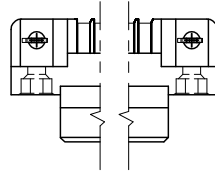

SECTION U-U

SPECIAL FEATURE OPTION "B"
SEE NOTE 6

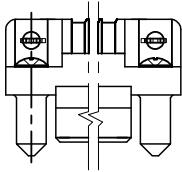

SECTION U-U

SPECIAL FEATURE OPTION "C"
SEE NOTE 6

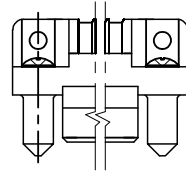

SECTION U-U

SPECIAL FEATURE OPTION "D"
SEE NOTE 6

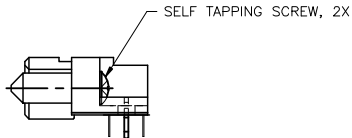

SEE NOTE 7

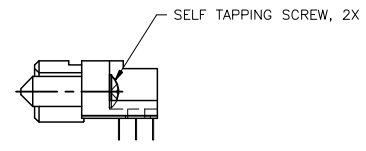

mal't. code		surface		tolerance	projection	product family	
NOTE 3		ISO 1302		ISO 148	HPC	HPC	
				ISO 1001			
lfr	ecm no	dr	date	tolerances unless otherwise specified		title	
R				angles	linear	3 ROW R/A RECEPTACLE	
					XX±.01/XX±0.3	SOLDER TO BOARD, 0 G.P.	
					XXX±.005/XX±0.13		
				0'±2'	XXXX.0000/XXX0.061	scale 1:1	
		dr	G.PETERS	6/5/96	FCJ	dwg no	
		eng	S.CLARK	6/3/95		50294	sheet 3 of 5 size
		chr	S.CLARK	6/5/95		A3	
		appd	S.CLARK	6/5/95		type	Product Customer Drawing
sheet	revision						
index	sheet						

PRODUCT NUMBER NOTE 1 AND 2	NUMBER OF POSITIONS SEE NOTE 2	TAIL LENGTH ±.010/0.25	SPECIAL FEATURES SEE NOTE 6	TAIL PLATING	CONTACT PLATING SEE NOTE 10
50294-1YYYE	YYY	.125/3.18	NONE	TIN-LEAD	30µ"/0.76µ Au
50294-1YYYEA	YYY	.125/3.18	"A"		30µ"/0.76µ Au
50294-1YYYEB	YYY	.125/3.18	"B"		30µ"/0.76µ Au
50294-1YYYEC	YYY	.125/3.18	"C"		30µ"/0.76µ Au
50294-1YYYED	YYY	.125/3.18	"D"		30µ"/0.76µ Au
50294-1YYYF	YYY	.145/3.68	NONE		30µ"/0.76µ Au
50294-1YYYFB	YYY	.145/3.68	"B"		30µ"/0.76µ Au
50294-1YYYFC	YYY	.145/3.68	"C"		30µ"/0.76µ Au
50294-1YYYFD	YYY	.145/3.68	"D"		30µ"/0.76µ Au
50294-1YYYH	YYY	.180/4.57	NONE		30µ"/0.76µ Au
50294-1YYYHB	YYY	.180/4.57	"B"		30µ"/0.76µ Au
50294-1YYYHC	YYY	.180/4.57	"C"		30µ"/0.76µ Au
50294-1YYYHD	YYY	.180/4.57	"D"		30µ"/0.76µ Au
50294-3YYYE	YYY	.125/3.18	NONE		50µ"/1.27µ Au
50294-3YYYEA	YYY	.125/3.18	"A"		50µ"/1.27µ Au
50294-3YYYEB	YYY	.125/3.18	"B"		50µ"/1.27µ Au
50294-3YYYEC	YYY	.125/3.18	"C"		50µ"/1.27µ Au
50294-3YYYED	YYY	.125/3.18	"D"		50µ"/1.27µ Au
50294-3YYYF	YYY	.145/3.68	NONE		50µ"/1.27µ Au
50294-3YYYFB	YYY	.145/3.68	"B"		50µ"/1.27µ Au
50294-3YYYFC	YYY	.145/3.68	"C"		50µ"/1.27µ Au
50294-3YYYFD	YYY	.145/3.68	"D"		50µ"/1.27µ Au
50294-3YYYH	YYY	.180/4.57	NONE		50µ"/1.27µ Au
50294-3YYYHB	YYY	.180/4.57	"B"		50µ"/1.27µ Au
50294-3YYYHC	YYY	.180/4.57	"C"		50µ"/1.27µ Au
50294-3YYYHD	YYY	.180/4.57	"D"	TIN-LEAD	50µ"/1.27µ Au

PRODUCT NUMBER NOTE 1 AND 2	NUMBER OF POSITIONS SEE NOTE 2	TAIL LENGTH ±.010/0.25	SPECIAL FEATURES SEE NOTE 6	TAIL PLATING	CONTACT PLATING SEE NOTE 10
50294-1YYEFL	YYY	.125/3.18	NONE	TIN	30µ"/0.76µ Au
50294-1YYEALF	YYY	.125/3.18	"A"		30µ"/0.76µ Au
50294-1YYEBLF	YYY	.125/3.18	"B"		30µ"/0.76µ Au
50294-1YYECLF	YYY	.125/3.18	"C"		30µ"/0.76µ Au
50294-1YYEDLF	YYY	.125/3.18	"D"		30µ"/0.76µ Au
50294-1YYFLF	YYY	.145/3.68	NONE		30µ"/0.76µ Au
50294-1YYFBLF	YYY	.145/3.68	"B"		30µ"/0.76µ Au
50294-1YYFCLF	YYY	.145/3.68	"C"		30µ"/0.76µ Au
50294-1YYFDLF	YYY	.145/3.68	"D"		30µ"/0.76µ Au
50294-1YYHLF	YYY	.180/4.57	NONE		30µ"/0.76µ Au
50294-1YYHBLF	YYY	.180/4.57	"B"		30µ"/0.76µ Au
50294-1YYHCLF	YYY	.180/4.57	"C"		30µ"/0.76µ Au
50294-1YYHDLF	YYY	.180/4.57	"D"		30µ"/0.76µ Au
50294-3YYEFL	YYY	.125/3.18	NONE		50µ"/1.27µ Au
50294-3YYEALF	YYY	.125/3.18	"A"		50µ"/1.27µ Au
50294-3YYEBLF	YYY	.125/3.18	"B"		50µ"/1.27µ Au
50294-3YYECLF	YYY	.125/3.18	"C"		50µ"/1.27µ Au
50294-3YYEDLF	YYY	.125/3.18	"D"		50µ"/1.27µ Au
50294-3YYFLF	YYY	.145/3.68	NONE		50µ"/1.27µ Au
50294-3YYFBLF	YYY	.145/3.68	"B"		50µ"/1.27µ Au
50294-3YYFCLF	YYY	.145/3.68	"C"		50µ"/1.27µ Au
50294-3YYFDLF	YYY	.145/3.68	"D"		50µ"/1.27µ Au
50294-3YYHLF	YYY	.180/4.57	NONE		50µ"/1.27µ Au
50294-3YYHBLF	YYY	.180/4.57	"B"		50µ"/1.27µ Au
50294-3YYHCLF	YYY	.180/4.57	"C"		50µ"/1.27µ Au
50294-3YYHDLF	YYY	.180/4.57	"D"	TIN	50µ"/1.27µ Au

TABLE CONTINUED ON SHEET 5



Copyright FCI

mal't code		surface		tolerance		projection		product family	
NOTE 3		ISO 1302		ISO 148		ASME Y14.5		HPC	
ltr	ecr no	dr	date	linear		INCH/MM		title	
R				0'±2'		1:1		3 ROW R/A RECEPTACLE SOLDER TO BOARD, 0 G.P.	
sheet index		revision sheet		dr		engr		dwg no	
				G.PETERS		S.CLARK		50294	
				6/5/96		6/3/95		sheet 4 of 5 size	
				6/5/95		6/5/95		A3	
				6/5/95				type Product Customer Drawing	

PRODUCT NUMBER NOTE 1 AND 2	NUMBER OF POSITIONS SEE NOTE 2	TAIL LENGTH ±.010/0.25	SPECIAL FEATURES SEE NOTE 6	TAIL PLATING	CONTACT PLATING SEE NOTE 10
50294-5YYYE	YYY	.125/3.18	NONE	TIN/LEAD	30μ"/0.76μ GXT
50294-5YYYELF	YYY	.125/3.18	NONE	TIN	
50294-5YYYEA	YYY	.125/3.18	"A"	TIN/LEAD	
50294-5YYYEALF	YYY	.125/3.18	"A"	TIN	
50294-5YYYEB	YYY	.125/3.18	"B"	TIN/LEAD	
50294-5YYYEBLF	YYY	.125/3.18	"B"	TIN	
50294-5YYYEC	YYY	.125/3.18	"C"	TIN/LEAD	
50294-5YYYECLF	YYY	.125/3.18	"C"	TIN	
50294-5YYYED	YYY	.125/3.18	"D"	TIN/LEAD	
50294-5YYYEDLF	YYY	.125/3.18	"D"	TIN	
50294-5YYYF	YYY	.145/3.68	NONE	TIN/LEAD	
50294-5YYYFLF	YYY	.145/3.68	NONE	TIN	
50294-5YYYFB	YYY	.145/3.68	"B"	TIN/LEAD	
50294-5YYYFBLF	YYY	.145/3.68	"B"	TIN	
50294-5YYYFC	YYY	.145/3.68	"C"	TIN/LEAD	
50294-5YYYFCLF	YYY	.145/3.68	"C"	TIN	
50294-5YYYFD	YYY	.145/3.68	"D"	TIN/LEAD	
50294-5YYYFDLF	YYY	.145/3.68	"D"	TIN	
50294-5YYYH	YYY	.180/4.57	NONE	TIN/LEAD	
50294-5YYYHLF	YYY	.180/4.57	NONE	TIN	
50294-5YYYHB	YYY	.180/4.57	"B"	TIN/LEAD	
50294-5YYYHBLF	YYY	.180/4.57	"B"	TIN	
50294-5YYYHC	YYY	.180/4.57	"C"	TIN/LEAD	
50294-5YYYHCLF	YYY	.180/4.57	"C"	TIN	
50294-5YYYHD	YYY	.180/4.57	"D"	TIN/LEAD	
50294-5YYYHDLF	YYY	.180/4.57	"D"	TIN	30μ"/0.76μ GXT

mal't. code		surface	tolerance	projection	product family
NOTE 3		ISO 1902	ISO 148 ISO 1001		HPC
lfr	ecn no	dr	date	title	
R				3 ROW R/A RECEPTACLE SOLDER TO BOARD, 0 G.P.	
angles		linear	linear	INCH/MM	scale
0°±2'		XXX±.01/XX±0.3	XXX±.005/XX±0.13	1:1	1:1
dr	G.PETERS	6/5/96		scale	
eng	S.CLARK	6/3/95		scale	
chr	S.CLARK	6/5/95		scale	
appd	S.CLARK	6/5/95		scale	
sheet	revision			scale	
index	sheet			scale	
				dwg no	
				50294	
				sheet 5 of 5	
				size A3	
				type Product Customer Drawing	

PDM: Rev:R STATUS:Released Printed: Feb 18, 2010