

Table of Contents

Z-PACK HM-Zd Connector	55-94
Product Line Overview	56
4, 3, and 2 Pair Right Angle Receptacle Assemblies	57-59
4 Pair Vertical Receptacle Assemblies	60
4, 3, and 2 Pair Vertical Pin Header Assemblies	61-63
4, 3, and 2 Pair Right Angle Pin Header Assemblies	64-66
Power and Guide Hardware	67-73
AdvancedTCA Connectors and Guide/Key Modules	74, 75
4 and 2 Pair Pin Headers for Cable Assemblies	76
4 Pair 5 and 10 Column Push-to-Release Cable Assemblies	77
2 Pair 5 and 10 Column Push-to-Release Cable Assemblies	77
4 Pair Cable Assemblies for Backplane Testing	77
Recommended Printed Circuit Board Layouts	78-88
PC Board Routing Guidelines	89
Connector Housing Gathering Capabilities	90
Mating Sequence Chart	91
Application Tooling and Equipment	92, 93
Compatible 2mm HM Products	94

AdvancedTCA is a trademark of PICMG-PCI Industrial Computer Mfg's. Group.

Z-PACK HM-Zd Product Line Overview

Product Facts

- Z-PACK HM-Zd connector is an extension of the Z-PACK 2mm HM product line
- Designed specifically for high speed differential applications
- A modular connector system with a standard module size of 25.00 [.984]
- Contact pitch is 1.50 [.059] within a pair and 3.00 [.118] pair to pair within a column; column to column pitch is 2.50 [.098]
- Card Pitch is less than 20.32 [.800] for 2 pair and 3 pair headers and 25.40 [1.000] for 4 pair headers
- Available in three versions:
 - 2 signal contact pairs per column (20 pairs per 25.00 [.984]) compatible with 5 row Z-PACK 2mm HM connector
 - 3 signal contact pairs per column (30 pairs per 25.00 [.984])
 - 4 signal contact pairs per column (40 pairs per 25.00 [.984]) compatible with 8 row Z-PACK 2mm HM connector
- Available in vertical and right angle press fit pin headers and right angle and vertical press fit receptacles
- Optimized footprint for improved electrical performance and ease of trace routing (unobstructed routing channels on both daughtercard and backplane)
- Pin header and receptacle have the exact same footprint to simplify PC board layout
- Designed to meet Telcordia requirements
- Recognized under the Component Program of Underwriters Laboratories Inc., File No. E28476 

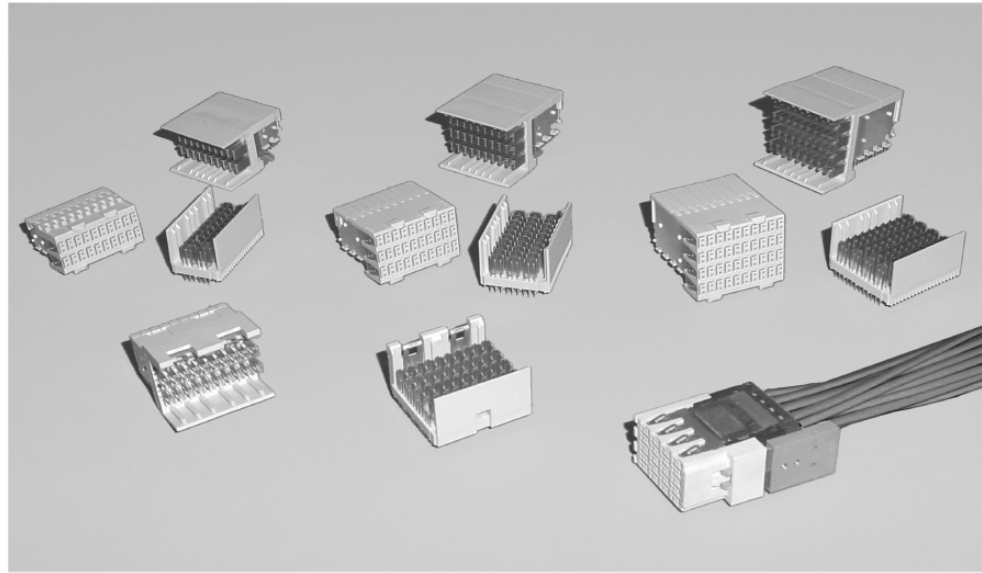

The Z-PACK HM-Zd connector system is a high speed, differential connector system, which is compatible with the Z-PACK 2mm HM connector line. Z-PACK HM-Zd connector provides Z-PACK 2mm HM connector users with a migration path for serial

switching applications from 3.125 Gb/s to 10+ Gb/s.

The Z-PACK HM-Zd connector system features a highly reliable dual beam contact system with fully encompassing grounds dedicated to each differential pair. In addition, the Z-PACK HM-Zd connector

footprint is optimized for both routability and system performance with the use of a 1.50 x 2.50 [.059 x .098] row to column grid. The connector design features a robust mating interface with integral prealignment and polarization built into the mating interface.

Availability

- Fully validated SPICE models: E-mail requests to modeling@tycoelectronics.com
- Samples: go to <http://tycoelectronics.custhelp.com>
- Pro/E models and IGES models: E-mail requests to TycoCAD@tycoelectronics.com
- White Papers: available on product website at <http://hmzd.tycoelectronics.com>
- Electrical Performance Report: <http://hmzd.tycoelectronics.com>
EPR #206C014
- Routing Guide: <http://hmzd.tycoelectronics.com>
Routing Guide #206C015-1

<http://hmzd.tycoelectronics.com>

Technical Documents

- Product Specification 108-2055
- Application Specification 114-13059
- Qualification Test Report 501-568

Material and Finish

- Contact Area Finish — 0.80µm Au min. over 1.3µm Ni min.
- Compliant Pin Finish — 0.8µm SnPb min. over 1.3µm Ni min.
- Contact Material — Copper Alloy
- Housing Material — Glass filled polyester, 94V-0 rated

Ratings

- Current — 0.7A per signal contact, fully energized 2A per shield, all shields energized
 - Operating Voltage — 500 VAC maximum, signal to signal 250 VAC maximum, signal to ground
 - Temperature — -65°C to 105°C
 - Mating Force — 0.38N maximum per contact (signal = 1 contact, ground = 1 contact)
 - Durability — 250 cycles
- * Reference Product Spec. 108-2055 for complete list of performance data.

IGES is a trademark of IAMBA Networks, Inc.

PRO/E is a trademark of Parametric Technology Corp.

TELCORDIA is a trademark of Telcordia Technologies, Inc.

Z-PACK HM-Zd Connector

4 Pair Right Angle Receptacle Assemblies

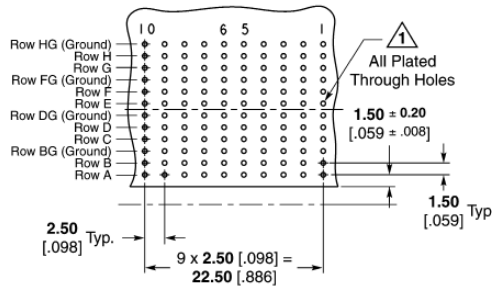
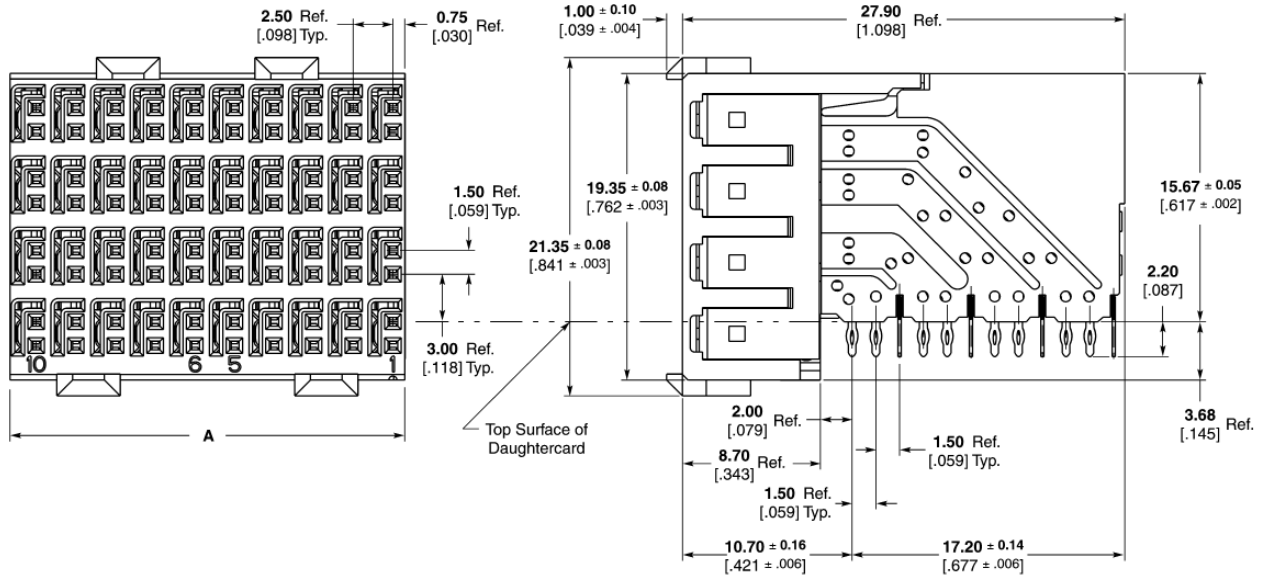

**Recommended PC Board Layout
Daughter Board, Component Side Shown**

1 PCB Hole Dim.
 Drilled Hole = **0.7000 ± 0.025** [.02756 ± .0010]
 Finished Hole = **0.60 ± 0.05** [.024 ± .002]
 Cu Thickness = **0.375 ± 0.0125** [.0148 ± .00049]
 SnPb Thickness = **0.007 ± 0.003** [.0003 ± .0001]

Note: For finishes other than Tin-Lead, reference Application Specification 114-13059.

Part Number	Column Count	Module Length (Dim. A)	Signals	Grounds	Application Tooling ²			Mates With*
					Insertion Receptacle	Repair		
						Housing Removal	Chiclet Removal	
1469251-1	5	12.40 .488	40	20	91347-5	1583224-5	1583248-1	1469252-1
6469001-1¹	10	25.00 .984	80	40	91347-1	1583224-1	1583248-1	6469002-1, 6469046-1, 6469074-1, 6469048-1
6469286-1	12	30.00 1.181	96	48	91347-3	1583224-2	1583248-1	6469287-1, 6469375-1
6469294-1	15	37.50 1.476	120	60	91347-2	1583224-3	1583248-1	6469296-1
6469061-1	20	50.00 1.969	160	80	91347-4	1583224-4	1583248-1	6469062-1, 6469099-1

¹ AdvancedTCA Zone 2 Daughtercard Connector.

² See page 93 for Instruction Sheet Number.

*Other options may be available. Contact Tyco Electronics at the numbers listed below for more information.

Z-PACK HM-Zd Connector (Continued)

3 Pair Right Angle Receptacle Assemblies

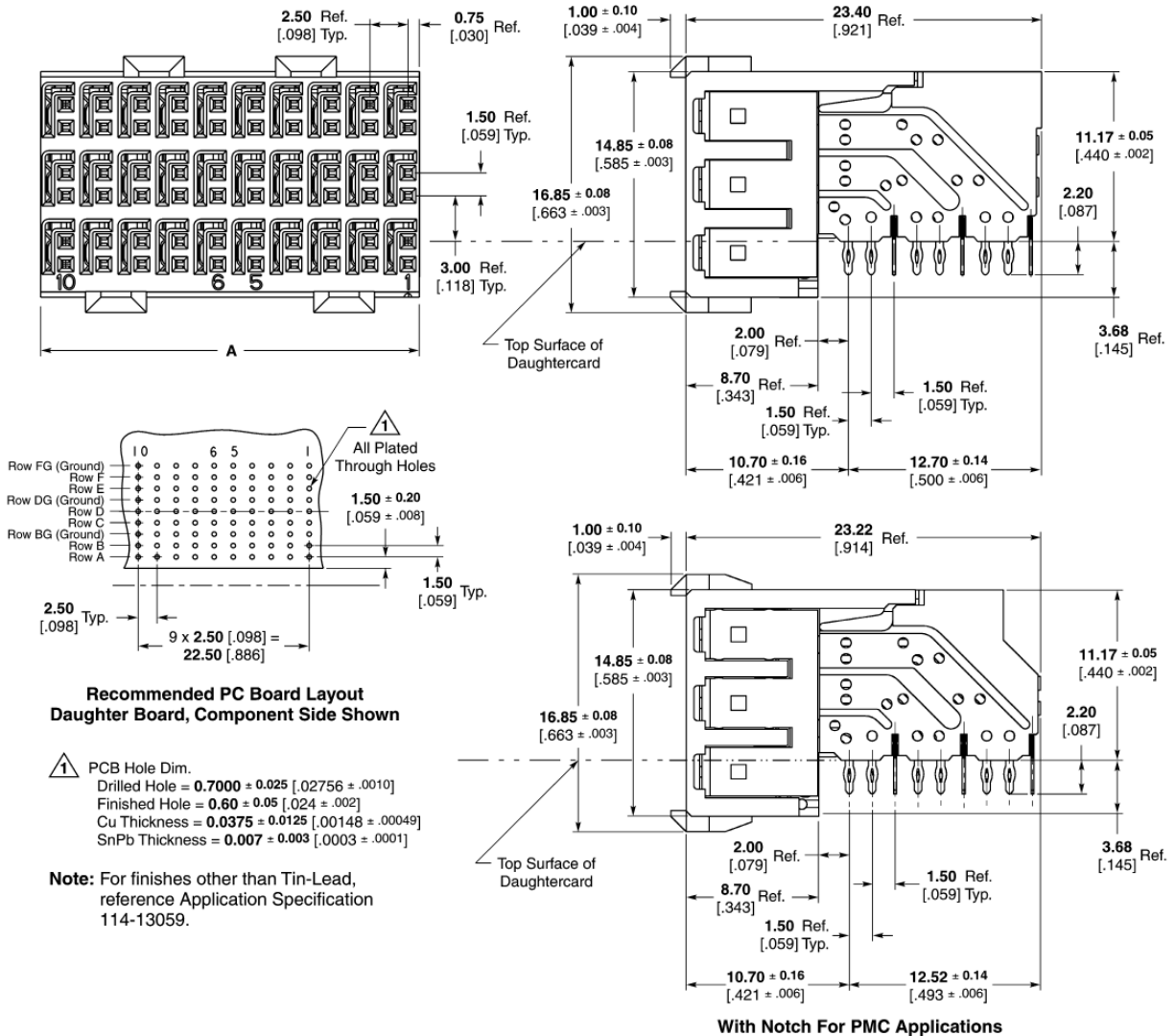

Part Number	Column Count	Module Length (Dim. A)	Signals	Grounds	Application Tooling ²			Mates With*
					Insertion	Repair		
					Receptacle	Housing Removal	Chiclet Removal	
6469081-1	10	25.00 .984	60	30	91376-1	1583224-1	1673952-1	6469083-1, 6469085-1, 6469183-1
1469514-1 ¹	10	25.00 .984	60	30	91376-1	1583224-1	1673952-1	6469083-1, 6469085-1, 6469183-1
6469179-1	15	37.50 1.476	90	90	91376-2	1583224-3	1673952-1	6469152-1

¹ For CompactPCI and AdvancedTCA PMC Applications.
² See page 93 for Instruction Sheet Number.
 *Other options may be available. Contact Tyco Electronics at the numbers listed below for more information.

AdvancedTCA is a trademark of PICMG-PCI Industrial Computer Mfg's. Group.
 CompactPCI is a trademark of PICMG-PCI Industrial Computer Mfg's. Group.

Note: All part numbers are RoHS compliant. Tin-Lead parts are RoHS compliant through exemption for lead in press-fit connectors.

Z-PACK HM-Zd Connector (Continued)

2 Pair Right Angle Receptacle Assemblies

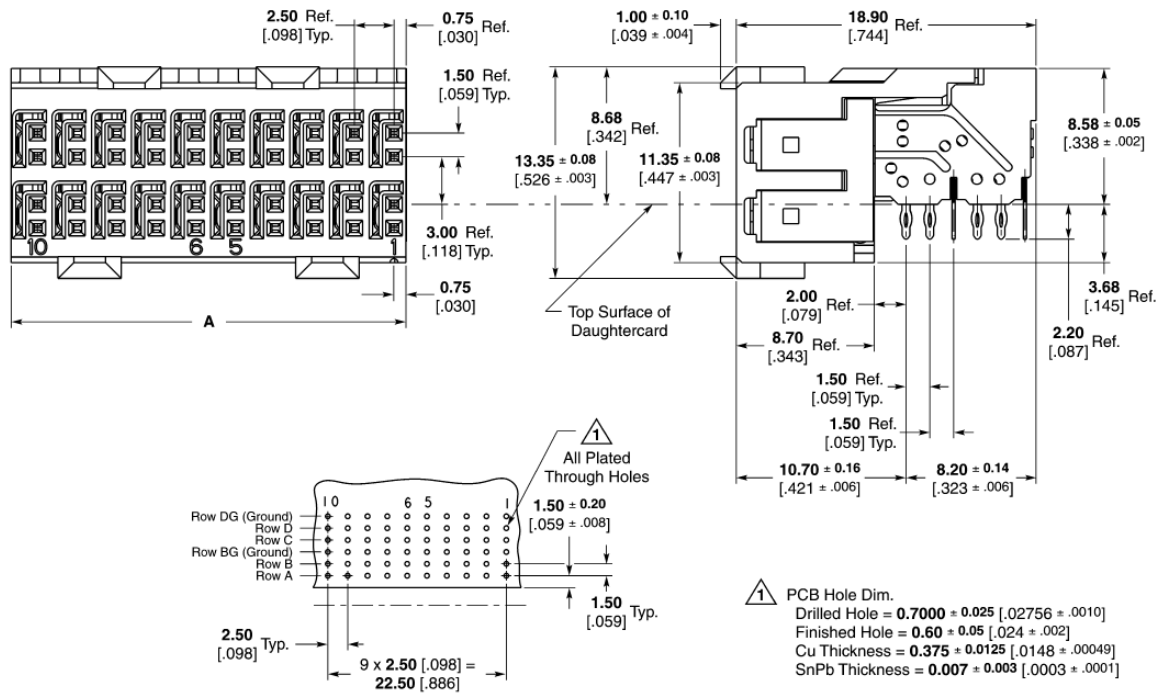

**Recommended PC Board Layout
Daughter Board, Component Side Shown**

Note: For finishes other than Tin-Lead, reference Application Specification 114-13059.

Part Number	Column Count	Module Length (Dim. A)	Signals	Grounds	Application Tooling ²			Mates With*
					Insertion	Repair		
					Receptacle	Housing Removal	Chiclet Removal	
6469028-1	10	25.00 .984	40	20	91350-1	1583224-1	1583249-1	6469025-1, 6469076-1, 6469169-1
6469077-1	20	50.00 1.969	80	40	91350-2	1583224-4	1583249-1	6469078-1, 6469101-1

¹ See page 93 for Instruction Sheet Number.

*Other options may be available. Contact Tyco Electronics at the numbers listed below for more information.

Note: All part numbers are RoHS compliant. Tin-Lead parts are RoHS compliant through exemption for lead in press-fit connectors.

Z-PACK HM-Zd Connector (Continued)

4 Pair Vertical Receptacle Assemblies

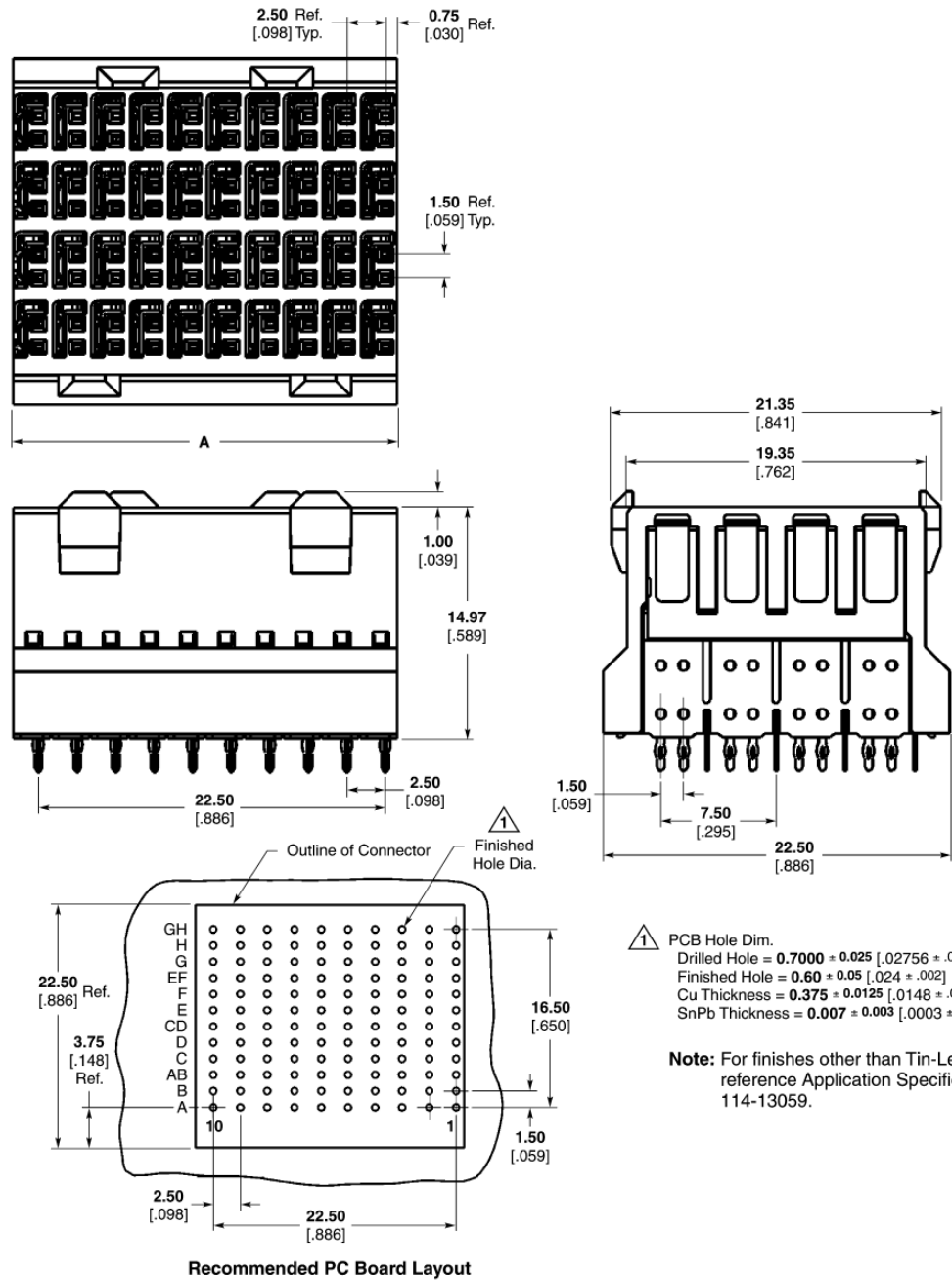

Part Number	Column Count	Module Length (Dim. A)	Signals	Grounds	Application Tooling ¹		Mates With
					Insertion Receptacle	Repair Housing Removal	
1469362-1	10	25.00 .984	80	40	1804401-1	1804402-1	6469002-1, 6469046-1, 6469074-1, 6469048-1

¹ See page 93 for Instruction Sheet Number.

Note: All part numbers are RoHS compliant. Tin-Lead parts are RoHS compliant through exemption for lead in press-fit connectors.

Z-PACK HM-Zd Connector (Continued)

4 Pair Vertical Pin Header Assemblies

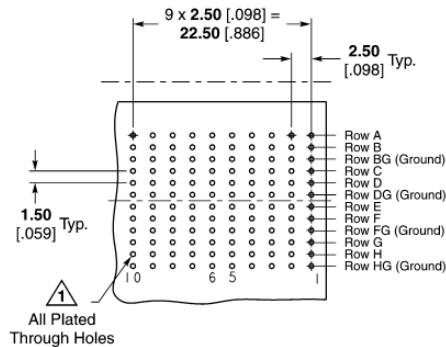
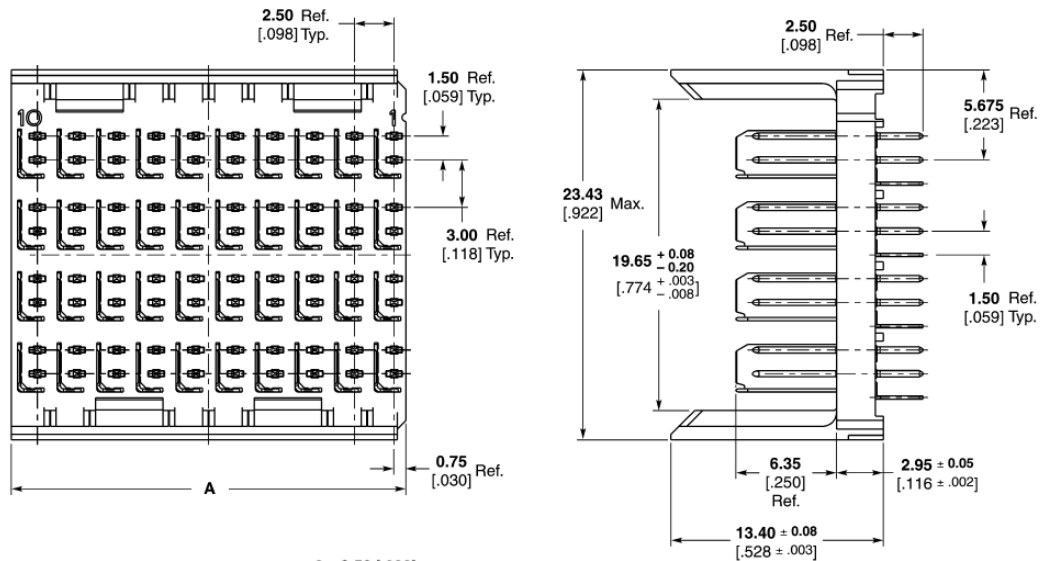

**Recommended PC Board Layout
Backplane Component Side Shown**

PCB Hole Dim.
 Drilled Hole = 0.7000 ± 0.025 [.02756 \pm .0010]
 Finished Hole = 0.60 ± 0.05 [.024 \pm .002]
 Cu Thickness = 0.375 ± 0.0125 [.0148 \pm .00049]
 SnPb Thickness = 0.007 ± 0.003 [.0003 \pm .0001]

Note: For finishes other than Tin-Lead, reference Application Specification 114-13059.

Part Number	Tail Length	Mating Pin Length	Column Count	Module Length (Dim. A)	Signals	Grounds	Application Tooling [§]				Mates With*
							Insertion Pin Header	Pin Removal	Housing Removal	Pin Insertion	
6469252-1	2.50 .098	5.30 .209	5	12.40 .488	40	20	91349-5	1583237-1	1583220-1	1583255-1	1469251-1
6469002-1¹	2.50 .098	5.30 .209	10	25.00 .984	80	40	91349-1	1583237-1	1583220-1	1583255-1	6469001-1, 1469362-1
6469046-1 ²	2.50 .098	5.30 .209	10	25.00 .984	80	40	91349-1	1583237-1	1583220-1	1583255-1	6469001-1, 1469362-1
6469074-1	1.80 .071	5.30 .209	10	25.00 .984	80	40	91349-1	1583237-1	1583220-1	1583255-1	6469001-1, 1469362-1
6469287-1	2.50 .098	5.30 .209	12	30.00 1.181	96	48	91349-3	1583237-1	1583220-1	1583255-1	6469286-1
6469296-1	2.50 .098	5.30 .209	15	37.50 1.476	120	60	91349-2	1583237-1	1583220-1	1583255-1	6469294-1
6469062-1	2.50 .098	5.30 .209	20	50.00 1.969	160	80	91349-4	1583237-1	1583220-1	1583255-1	6469061-1
6469099-1	1.80 .071	5.30 .209	20	50.00 1.969	160	80	91349-4	1583237-1	1583220-1	1583255-1	6469061-1

¹ AdvancedTCA Zone 2 Backplane Connector.

² Shallow Wall for Daughtercards thicker than 3.50 [.138].

[§] See page 93 for Instruction Sheet Number.

*Other options may be available. Contact Tyco Electronics at the numbers listed below for more information.

AdvancedTCA is a trademark of PICMG-PCI Industrial Computer Mfg's. Group.

Note: All part numbers are RoHS compliant. Tin-Lead parts are RoHS compliant through exemption for lead in press-fit connectors.

Z-PACK HM-Zd Connector (Continued)

3 Pair Vertical Pin Header Assemblies

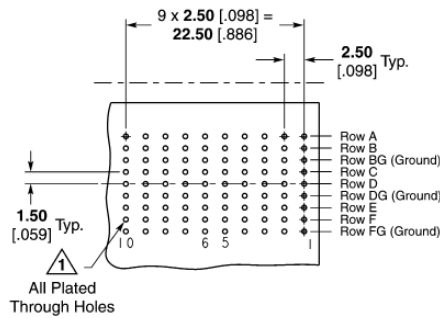
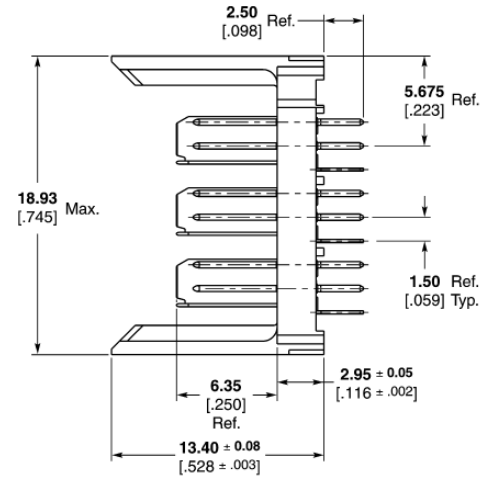
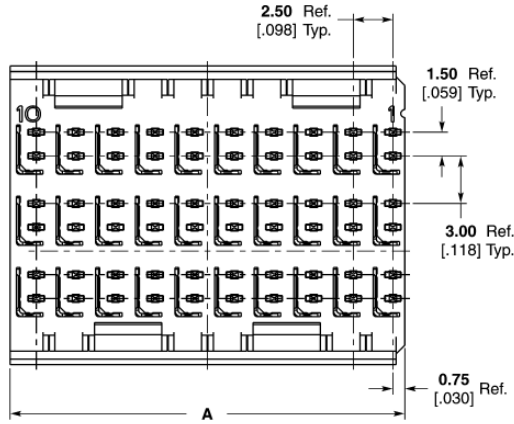

Recommended PC Board Layout Backplane, Component Side Shown

PCB Hole Dim.
 Drilled Hole = **0.7000 ± 0.025** [.02756 ± .0010]
 Finished Hole = **0.60 ± 0.05** [.024 ± .002]
 Cu Thickness = **0.0375 ± 0.0125** [.00148 ± .00049]
 SnPb Thickness = **0.007 ± 0.003** [.0003 ± .0001]

Note: For finishes other than Tin-Lead, reference Application Specification 114-13059.

Part Number	Tail Length	Mating Pin Length	Column Count	Module Length (Dim. A)	Signals	Grounds	Application Tooling ¹				Mates With*
							Insertion Pin Header	Pin Removal	Repair Housing Removal	Pin Insertion	
6469083-1	2.50 .098	5.30 .209	10	25.00 .984	60	30	91375-1	1583237-1	1725634-1	1583255-1	6469081-1
6469085-1	1.80 .071	5.30 .209	10	25.00 .984	60	30	91375-1	1583237-1	1725634-1	1583255-1	1469514-1
6469152-1	2.50 .098	5.30 .209	15	37.50 1.476	30	15	91375-2	1583237-1	1725634-1	1583255-1	6469179-1

¹ See page 93 for Instruction Sheet Number.

*Other options may be available. Contact Tyco Electronics at the numbers listed below for more information.

Note: All part numbers are RoHS compliant. Tin-Lead parts are RoHS compliant through exemption for lead in press-fit connectors.

Z-PACK HM-Zd Connector (Continued)

2 Pair Vertical Pin Header Assemblies

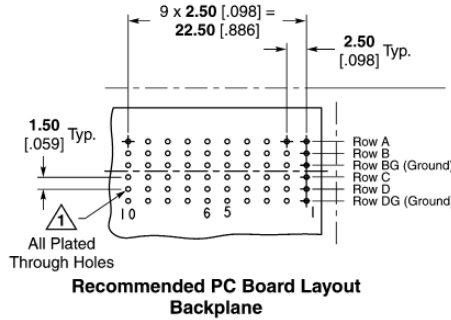
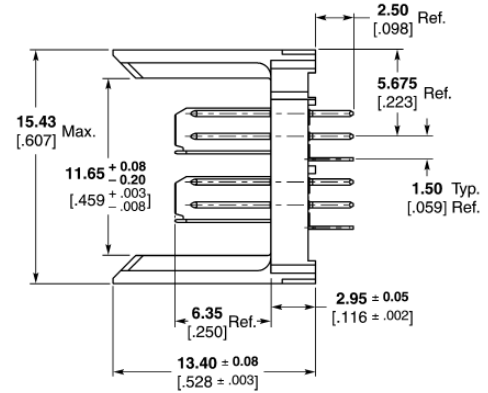
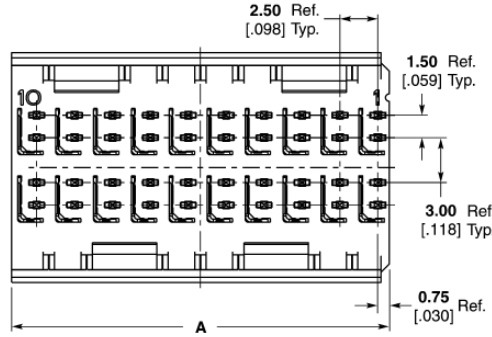

1 PCB Hole Dim.
 Drilled Hole = 0.7000 ± 0.025 [.02756 ± .0010]
 Finished Hole = 0.60 ± 0.05 [.024 ± .002]
 Cu Thickness = 0.375 ± 0.0125 [.0148 ± .00049]
 SnPb Thickness = 0.007 ± 0.003 [.0003 ± .0001]

Note: For finishes other than Tin-Lead, reference Application Specification 114-13059.

Part Number	Tail Length	Mating Pin Length	Column Count	Module Length (Dim. A)	Signals	Grounds	Application Tooling ¹				Mates With*
							Insertion Pin Header	Repair			
								Pin Removal	Housing Removal	Pin Insertion	
6469025-1	2.50 .098	5.30 .209	10	25.00 .984	40	20	91348-1	1583237-1	1583234-1	1583255-1	6469028-1
6469076-1	1.80 .071	5.30 .209	10	25.00 .984	40	20	91348-1	1583237-1	1583234-1	1583255-1	6469028-1
6469078-1	2.50 .098	5.30 .209	20	50.00 1.969	80	40	91348-2	1583237-1	1583234-1	1583255-1	6469077-1
6469101-1	1.80 .071	5.30 .209	20	50.00 1.969	80	40	91348-2	1583237-1	1583234-1	1583255-1	6469077-1

¹ See page 93 for Instruction Sheet Number.

*Other options may be available. Contact Tyco Electronics at the numbers listed below for more information.

Note: All part numbers are RoHS compliant. Tin-Lead parts are RoHS compliant through exemption for lead in press-fit connectors.

Z-PACK HM-Zd Connector (Continued)

**4 Pair
Right Angle Pin Header
Assemblies**

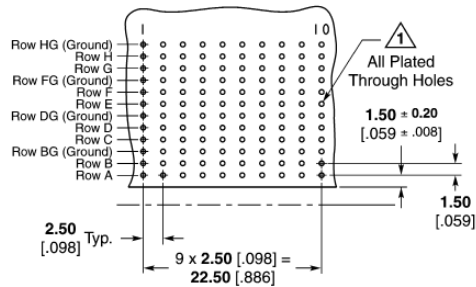
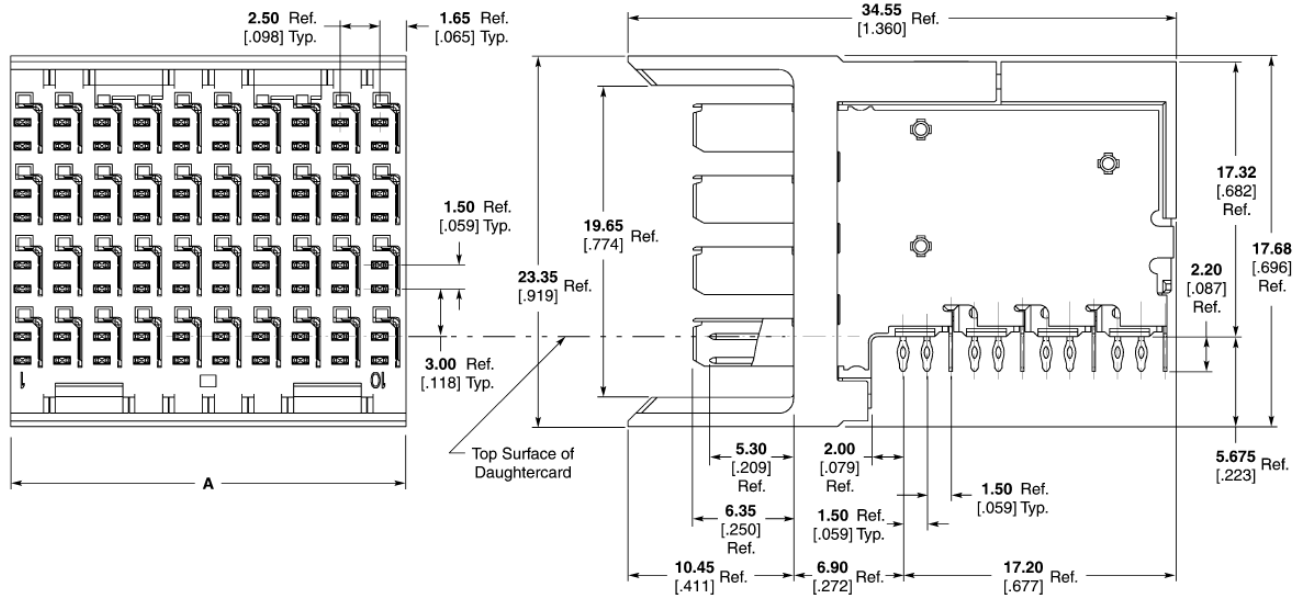

PCB Hole Dim.
 Drilled Hole = 0.7000 ± 0.025 [.02756 ± .0010]
 Finished Hole = 0.60 ± 0.05 [.024 ± .002]
 Cu Thickness = 0.0375 ± 0.0125 [.00148 ± .00049]
 SnPb Thickness = 0.007 ± 0.003 [.0003 ± .0001]

Note: For finishes other than Tin-Lead, reference Application Specification 114-13059.

**Recommended PC Board Layout
Component Side Shown**

Part Number	Tail Length	Mating Pin Length	Column Count	Module Length (Dim. A)	Signals	Grounds	Application Tooling ¹			Mates With*
							Insertion Receptacle	Repair Housing Removal	Repair Chiclet Removal	
6469048-1	2.20 .087	5.30 .209	10	25.00 .984	80	40	91378-1	1804174-1	1804177-1	6469001-1, 1469362-1
6469375-1	2.20 .087	5.30 .209	12	30.00 1.181	96	48	91378-3	1804174-1	1804177-1	6469286-1

¹ See page 93 for Instruction Sheet Number.

*Other options may be available. Contact Tyco Electronics at the numbers listed below for more information.

Note: All part numbers are RoHS compliant. Tin-Lead parts are RoHS compliant through exemption for lead in press-fit connectors.

Z-PACK HM-Zd Connector (Continued)

**3 Pair
Right Angle Pin Header
Assemblies**

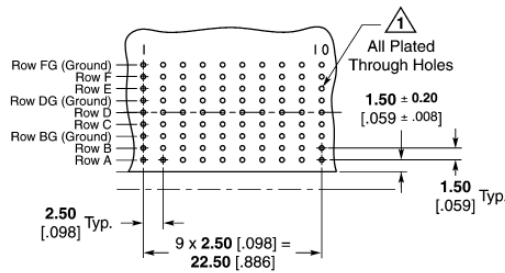
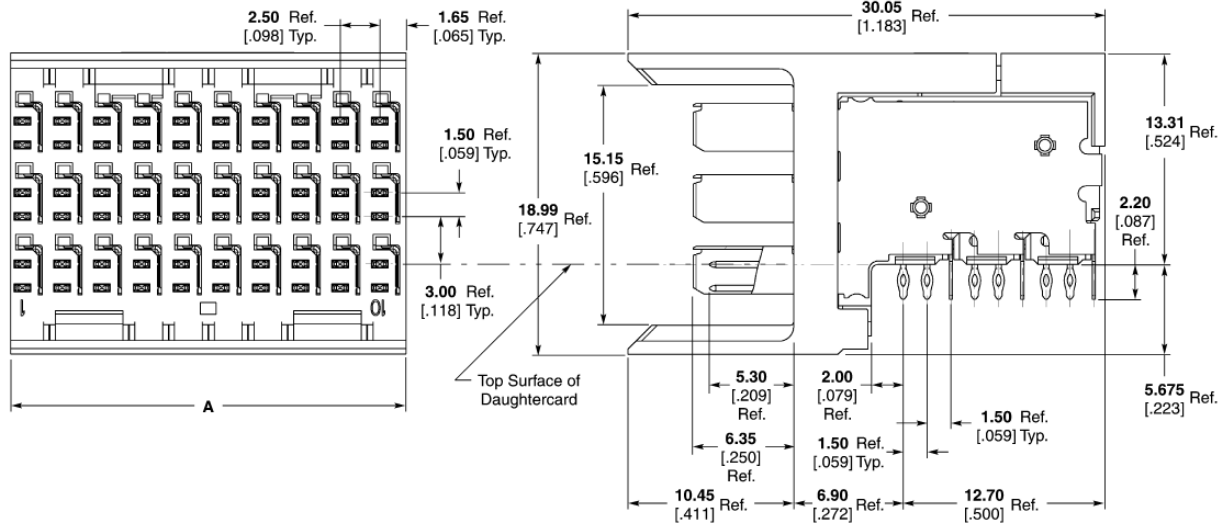

1 PCB Hole Dim.
 Drilled Hole = 0.7000 ± 0.025 [.02756 ± .0010]
 Finished Hole = 0.60 ± 0.05 [.024 ± .002]
 Cu Thickness = 0.0375 ± 0.0125 [.00148 ± .00049]
 SnPb Thickness = 0.007 ± 0.003 [.0003 ± .0001]

Note: For finishes other than Tin-Lead, reference Application Specification 114-13059.

**Recommended PC Board Layout
Component Side Shown**

Part Number	Tail Length	Mating Pin Length	Column Count	Module Length (Dim. A)	Signals	Grounds	Application Tooling ¹			Mates With*
							Insertion Pin Header	Repair Housing Removal	Repair Chiclet Removal	
6469183-1	2.20 .087	5.30 .209	10	25.00 .984	60	30	1804179-1	1804173-1	1804176-1	6469081-1, 1469514-1

¹ See page 93 for Instruction Sheet Number.

*Other options may be available. Contact Tyco Electronics at the numbers listed below for more information.

Note: All part numbers are RoHS compliant. Tin-Lead parts are RoHS compliant through exemption for lead in press-fit connectors.

Z-PACK HM-Zd Connector (Continued)

**2 Pair
Right Angle Pin Header
Assemblies**

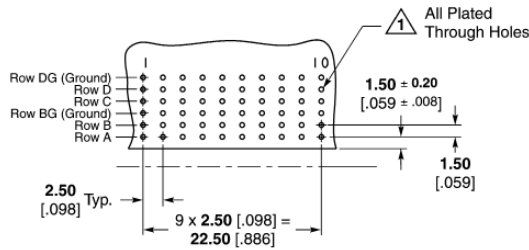
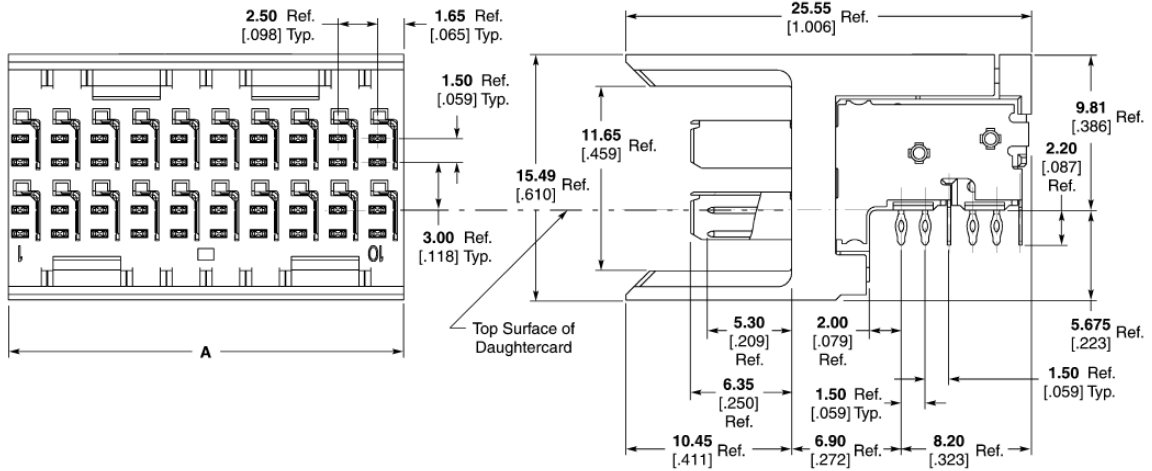

1 PCB Hole Dim.
 Drilled Hole = **0.7000 ± 0.025** [.02756 ± .0010]
 Finished Hole = **0.60 ± 0.05** [.024 ± .002]
 Cu Thickness = **0.0375 ± 0.0125** [.00148 ± .00049]
 SnPb Thickness = **0.007 ± 0.003** [.0003 ± .0001]

Note: For finishes other than Tin-Lead, reference Application Specification 114-13059.

**Recommended PC Board Layout
Component Side Shown**

Part Number	Tail Length	Mating Pin Length	Column Count	Module Length (Dim. A)	Signals	Grounds	Application Tooling ¹			Mates With*
							Insertion Pin Header	Repair Housing Removal	Repair Chiclet Removal	
6469169-1	2.20 .087	5.30 .209	10	25.00 .984	40	20	91377-1	1804171-1	1804175-1	6469028-1

¹ See page 93 for Instruction Sheet Number.

*Other options may be available. Contact Tyco Electronics at the numbers listed below for more information.

Note: All part numbers are RoHS compliant. Tin-Lead parts are RoHS compliant through exemption for lead in press-fit connectors.

Z-PACK HM-Zd Connector (Continued)

**Power and Guide Hardware
Universal Power Module
Vertical Receptacle (3 Pos.)**

The Tyco Electronics Universal Power Module is a three position, modular, hard metric board-to-board power connector designed to be compatible with Z-PACK 2mm HM connectors. The design is in an "inverse-sex" orientation and the vertical receptacle module meets the IEC 950 safety requirements for finger probe protection.

Both the headers and receptacle utilize Tyco Electronics ACTION PIN press-fit leads for ease of assembly onto printed circuit boards. Additionally, the vertical receptacle leads are polarized to allow only one orientation onto the printed circuit board, eliminating the possibility of reverse placement.

The Universal Power Module is compatible with a wide variety of other Tyco Electronics board-to-board connectors including Z-PACK HS3, Z-PACK HM-Zd and Z-PACK TinMan connectors.

The housings are thermoplastic and the contacts are offered in either a standard or high current copper alloy. Contact finish is gold over nickel on the mating surfaces. The contacts are designed to carry 10 amperes per contact in standard assemblies and 15 amperes per contact in the high current assemblies. Actual values may vary depending upon connector size, board design, etc.

The right angle header

contacts are available with sequenced lengths for "make-first/break-last" applications.

Generous alignment features designed into the housings and optional guide pins and receptacles make the Tyco Electronics Universal Power Module ideal for "blind mating" applications.

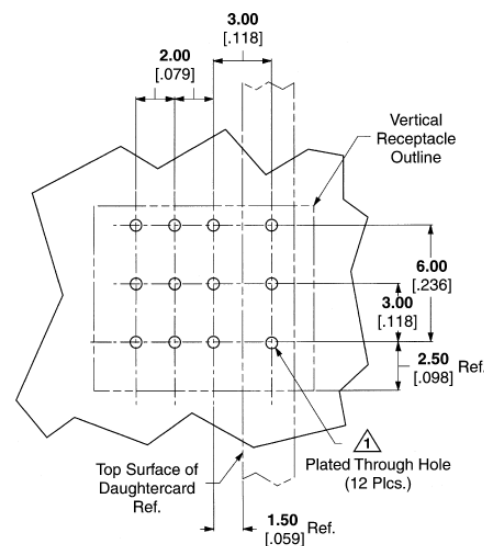
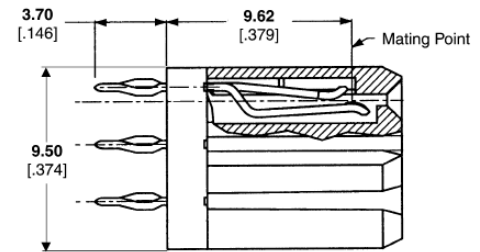
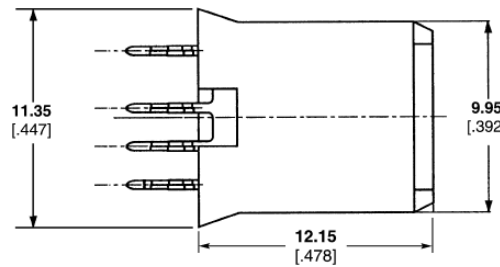
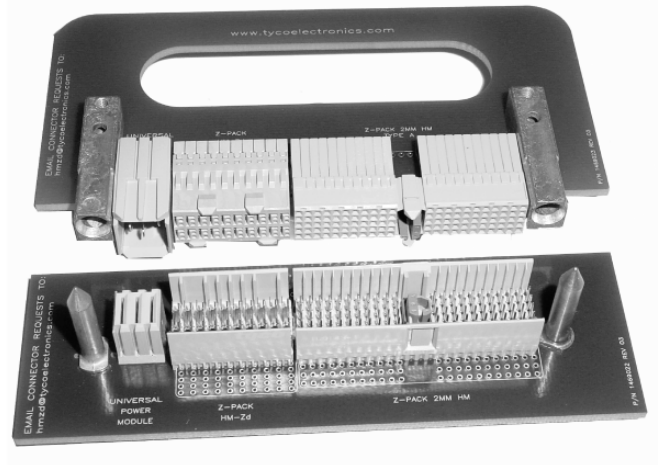

Recommended PC Board Hole Layout

	Position Loaded	Part Numbers
Vertical Receptacle	ABC	223955-2
	AC	223984-1
High Current	ABC	5-223955-2

PCB Hole Dim.
 Drilled Hole = 0.7000 ± 0.025 [0.02756 ± .0010]
 Finished Hole = 0.60 ± 0.05 [0.024 ± .002]
 Cu Thickness = 0.375 ± 0.0125 [0.0148 ± .00049]
 SnPb Thickness = 0.007 ± 0.003 [0.0003 ± .0001]

Note: For finishes other than Tin-Lead, reference Application Specification 114-1103.

Note: All part numbers are RoHS compliant. Tin-Lead parts are RoHS compliant through exemption for lead in press-fit connectors.

Z-PACK HM-Zd Connector (Continued)

Power and Guide Hardware
(Continued)

Expanded Universal Power Module Vertical Receptacles

Material and Finish

Housing — Polyester, gray
Contact — Copper alloy, plated 0.00127 [0.00050] min. gold in mating area, 0.00050 [0.00020] min. Tin-Lead on ACTION PIN product area, with entire contact underplated 0.00127 [0.00050] min. nickel

Related Product Data

Guiding Hardware (Optional) — pages 71-73

Application Tooling

Header
 Seating Tool, 224441-1
 Board Support Fixture, 224442-1
Receptacle
 Seating Tool, 224421-1
 Board Support Fixture, 217602-1

Technical Documents

Product Specification
 108-1651
Application Specification
 114-1103

Tyco Electronics Instruction Sheet

408-4169 (Receptacle)
 Seating Tool 224421-1)

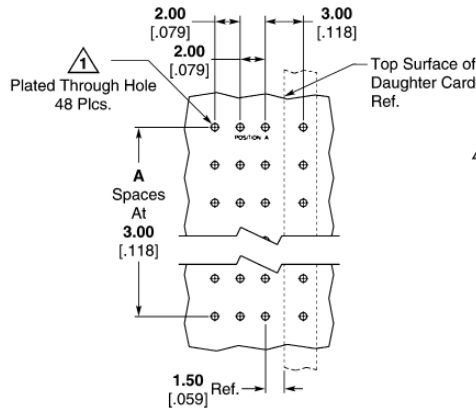
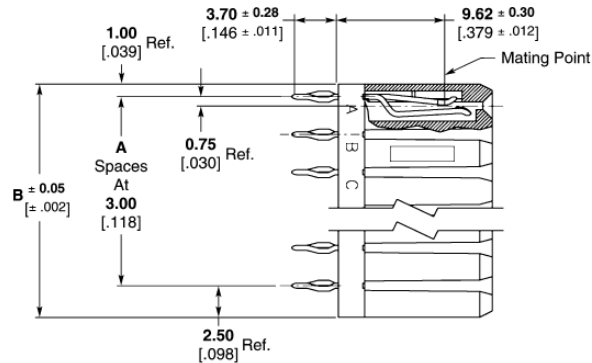
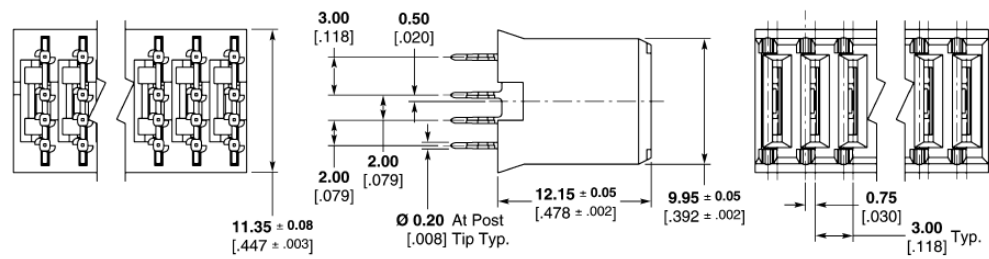

PCB Hole Dim.
 Drilled Hole = 0.7000 ± 0.025 [0.02756 ± 0.0010]
 Finished Hole = 0.60 ± 0.05 [0.024 ± 0.002]
 Cu Thickness = 0.375 ± 0.0125 [0.0148 ± 0.00049]
 SnPb Thickness = 0.007 ± 0.003 [0.0003 ± 0.0001]

Note: For finishes other than Tin-Lead, reference Application Specification 114-1103.

Recommended PCB Hole Layout

Position	A	B Ref.	Standard *10A Part Number	High Current *15A Part Number
4	3	12.50 .492	5223995-1	120953-1
5	4	15.50 .610	5223995-2	120953-2
6	5	18.50 .728	5223995-3	120953-3
7	6	21.50 .846	5223995-4	120953-4
8	7	24.50 .965	5223995-5	120953-5

*Reference Product Specification 108-1651.

Note: For additional Power Module options reference Catalog 1773096, "Power Connectors and Interconnection Systems," or contact your Tyco Electronics Sales Representative.

Note: All part numbers are RoHS compliant. Tin-Lead parts are RoHS compliant through exemption for lead in press-fit connectors.

Z-PACK HM-Zd Connector (Continued)

Power and Guide Hardware

(Continued)

Universal Power Module Right Angle Headers (3 Pos.)

Material and Finish

Housing — polyester, natural color
Contacts — Copper alloy, plated 0.00127 [0.00050] min. gold in mating area, 0.00050 [0.00020] min. Tin-Lead on ACTION PIN post area, with entire contact underplated 0.00127 [0.00050] min. nickel

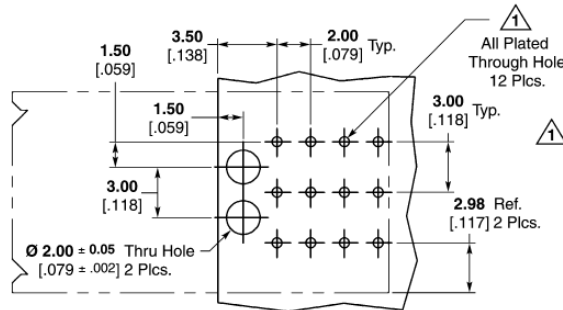
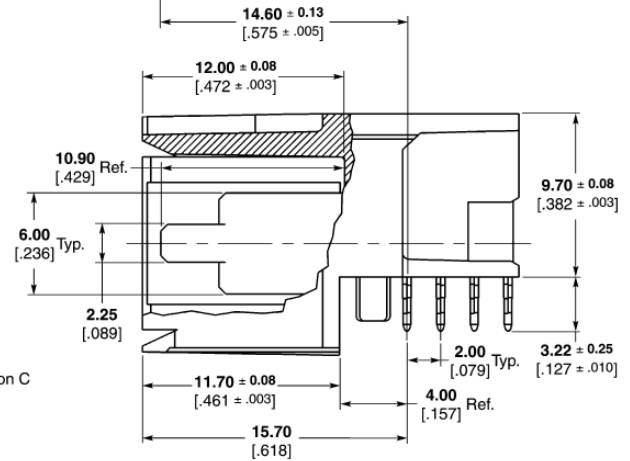
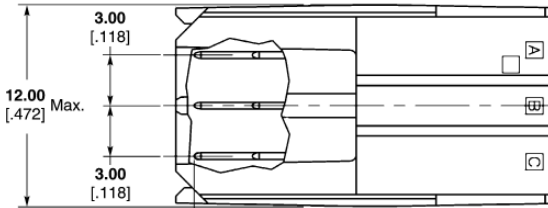
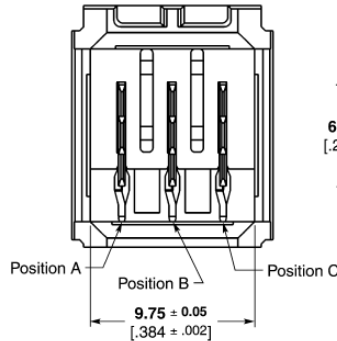
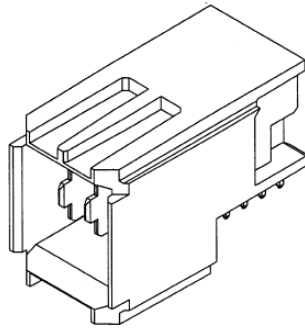

△ All Plated Through Hole 12 Plcs.
 △ PCB Hole Dim.
 Drilled Hole = 0.7000 ± 0.025 [0.02756 ± .0010]
 Finished Hole = 0.60 ± 0.05 [0.024 ± .002]
 Cu Thickness = 0.375 ± 0.0125 [0.0148 ± .00049]
 SnPb Thickness = 0.007 ± 0.003 [0.0003 ± .0001]

Note: For finishes other than Tin-Lead, reference Application Specification 114-1103.

Recommended PC Board Hole Layout

Note: For additional Power Module options reference Catalog 1773096, "Power Connectors and Interconnection Systems," or contact your Tyco Electronics Sales Representative.

Blade Length Dimensions			Standard *10A	High Current *15A
Position A	Position B	Position C	Right Angle Header Part Numbers	Right Angle Header Part Numbers
10.90 [.429]	10.90 [.429]	10.90 [.429]	5223961-1	5-5223961-1
10.90 [.429]	9.30 [.366]	10.90 [.429]	5223962-1	—
10.90 [.429]	9.30 [.366]	9.30 [.366]	5223968-1	—
10.90 [.429]	7.68 [.302]	10.90 [.429]	5223972-1	—
10.90 [.429]	7.68 [.302]	9.30 [.366]	5223971-1	—
10.90 [.429]	7.68 [.302]	7.68 [.302]	5223970-1	—
9.30 [.429]	10.90 [.429]	9.30 [.366]	5223963-1	—
9.30 [.366]	10.90 [.429]	7.68 [.302]	5223964-1	—
9.30 [.366]	9.30 [.366]	9.30 [.366]	5223967-1	—
9.30 [.366]	—	9.30 [.366]	5223975-1	—
9.30 [.366]	9.30 [.366]	7.68 [.302]	5223981-1	—
9.30 [.366]	7.68 [.302]	9.30 [.366]	5223965-1	—
7.68 [.302]	9.30 [.366]	7.68 [.302]	5223983-1	—
7.68 [.302]	7.68 [.302]	9.30 [.366]	5223980-1	—
7.68 [.302]	7.68 [.302]	7.68 [.302]	5223974-1	5-5223974-1

*Reference Product Specification 108-1651.

Note: All part numbers are RoHS compliant. Tin-Lead parts are RoHS compliant through exemption for lead in press-fit connectors.

Z-PACK HM-Zd Connector (Continued)

Power and Guide Hardware
(Continued)

Expanded Universal Power Module Right Angle Headers

Material and Finish

Housing — Polyester, gray
Contacts — Phosphor bronze, plated 0.00127 [.000050] min. gold in mating area, 0.00054 [.000021] min. Tin-Lead on ACTION PIN product area, with entire contact underplated 0.00127 [.000050] min. nickel

Related Product Data

Guiding Hardware (Optional) — pages 71-73

Application Tooling

Header
 Seating Tool, 224441-1
 Board Support Fixture, 224442-1

Receptacle
 Seating Tool, 224421-1
 Board Support Fixture, 217602-1

Technical Documents

Product Specification
 108-1651
Application Specification
 114-1103

Tyco Electronics Instruction Sheet
 408-4169 (Receptacle Seating Tool 224421-1)

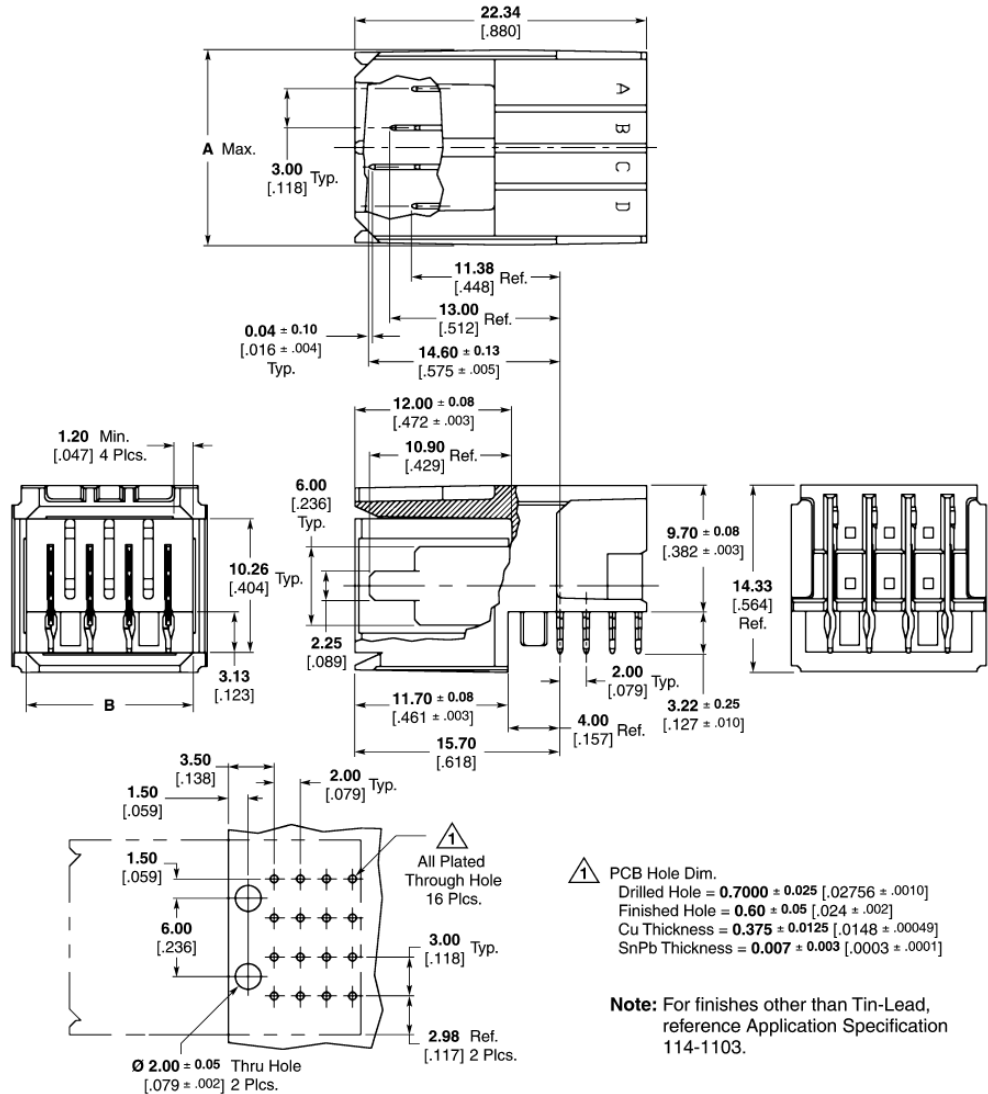

Recommended PC Board Hole Layout

Note: For finishes other than Tin-Lead, reference Application Specification 114-1103.

Positions	Dimensions		Standard *10A Base Part Number ¹	High Current *15A Base Part Number ¹
	A	B		
4	15.00 .591	12.75 .502	5646954	120954
5	18.00 .709	15.75 .620	5646955	120955
6	21.00 .827	18.75 .738	5646956	120956
7	24.00 .945	21.75 .856	5646957	120957
8	27.00 1.063	24.75 .974	5646958	120958

Note: For additional Power Module options reference Catalog 1773096, "Power Connectors and Interconnection Systems," or contact your Tyco Electronics Sales Representative.

¹ Dash number indicates sequence pattern. See customer drawing for specific dash numbers.
^{*}Reference Product Specification 108-1651.

Note: All part numbers are RoHS compliant. Tin-Lead parts are RoHS compliant through exemption for lead in press-fit connectors.

Z-PACK HM-Zd Connector (Continued)

Power and Guide Hardware

(Continued)

Guide Pin (Unkeyed)

Material and Finish

Guide Pin — Passivated stainless steel
Part Number 223956-1

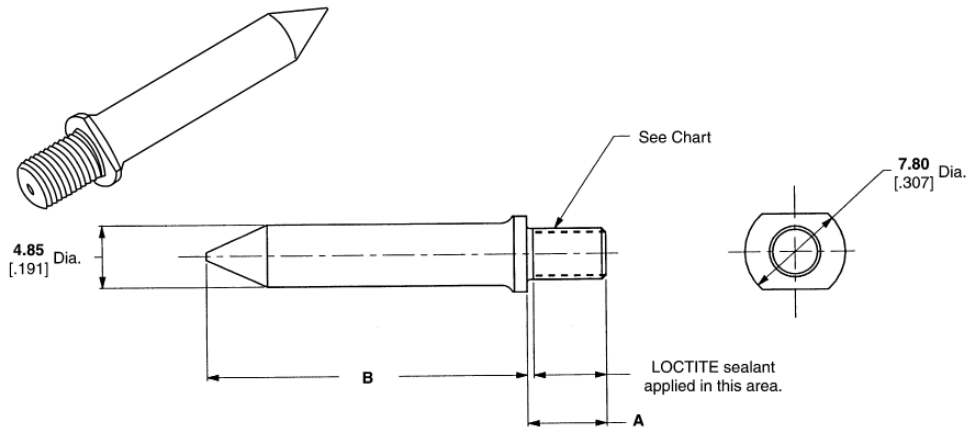

Dimension		Thread	Part Numbers
A	B		
7.50 [0.295]	24.73 [0.974]	M4 x 7-6g	223982-1 ¹
9.20 [0.362]	25.16 [0.991]	M4 x 7-6g	223969-7
12.70 [0.500]	25.16 [0.991]	8-32 UNC-2A	223969-4
12.70 [0.500]	25.16 [0.991]	M4 x 7-6g	223969-1
6.20 [0.244]	25.16 [0.991]	M4 x 7-6g	223956-1
12.70 [0.500]	31.25 [1.230]	8-32 UNC-2A	1-223969-0
3.80 ² [0.150]	27.16 [1.069]	M4 x 7-6h	120646-1
2.00 ² [0.079]	27.16 [1.069]	M3 x 0.5	223988-1

¹ 6.35 Hex Base.
² Internal Thread.

Female Guide Module (Unkeyed)

Material and Finish

Guide Module — Zinc alloy, chromate conversion coated

Related Product Data

Application Tooling —

Seating Tool, 224440-1
Board Support Fixture, 217603-1

Technical Documents

Product Specification

108-1651

Application Specification

114-1103

Part Number 223957-1

(as shown)

Part Number 223979-1

(dual alignment posts)

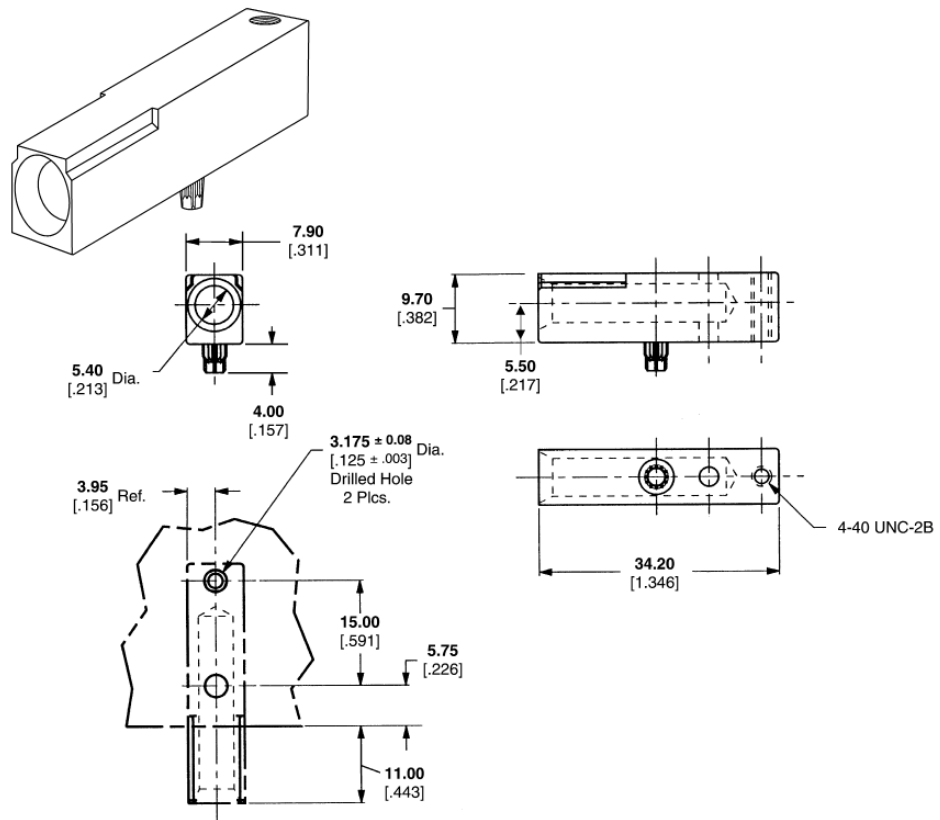

LOCTITE is a trademark of Henkel Corp.

Note: All part numbers are RoHS compliant.

Recommended PC Board Hole Layout

Z-PACK HM-Zd Connector (Continued)

Power and Guide Hardware
(Continued)

Guide Pin (Keyed)

Material and Finish

Guide Pin — Zinc alloy, chromate conversion coated

Part Number 223985

Dimension		Part Number
A	B	
25.16 .991	20.39 .803	223985-1
29.00 1.142	24.23 .954	223985-3

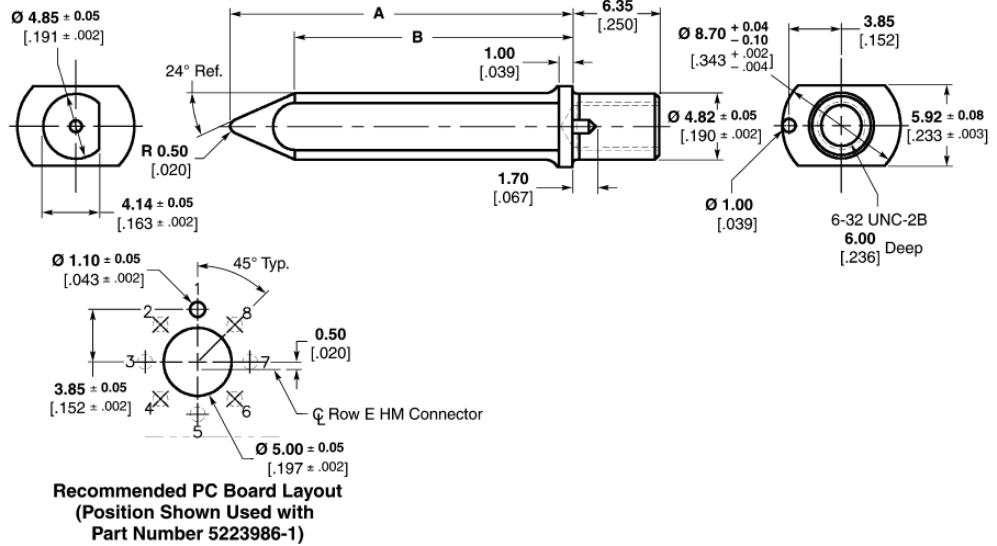

Female Guide Module (Keyed)

Material and Finish

Guide Module — Zinc alloy, chromate conversion coated

Part Number 5223986

Dim. A	Thread	Part Number
0°	4-40	5223986-1
45°	4-40	5223986-2
90°	4-40	5223986-3
135°	4-40	5223986-4
180°	4-40	5223986-5
225°	4-40	5223986-6
270°	4-40	5223986-7
315°	4-40	5223986-8
0°	M2.6	5120913-1
45°	M2.6	5120913-2
90°	M2.6	5120913-3
135°	M2.6	5120913-4
180°	M2.6	5120913-5
225°	M2.6	5120913-6
270°	M2.6	5120913-7
315°	M2.6	5120913-8

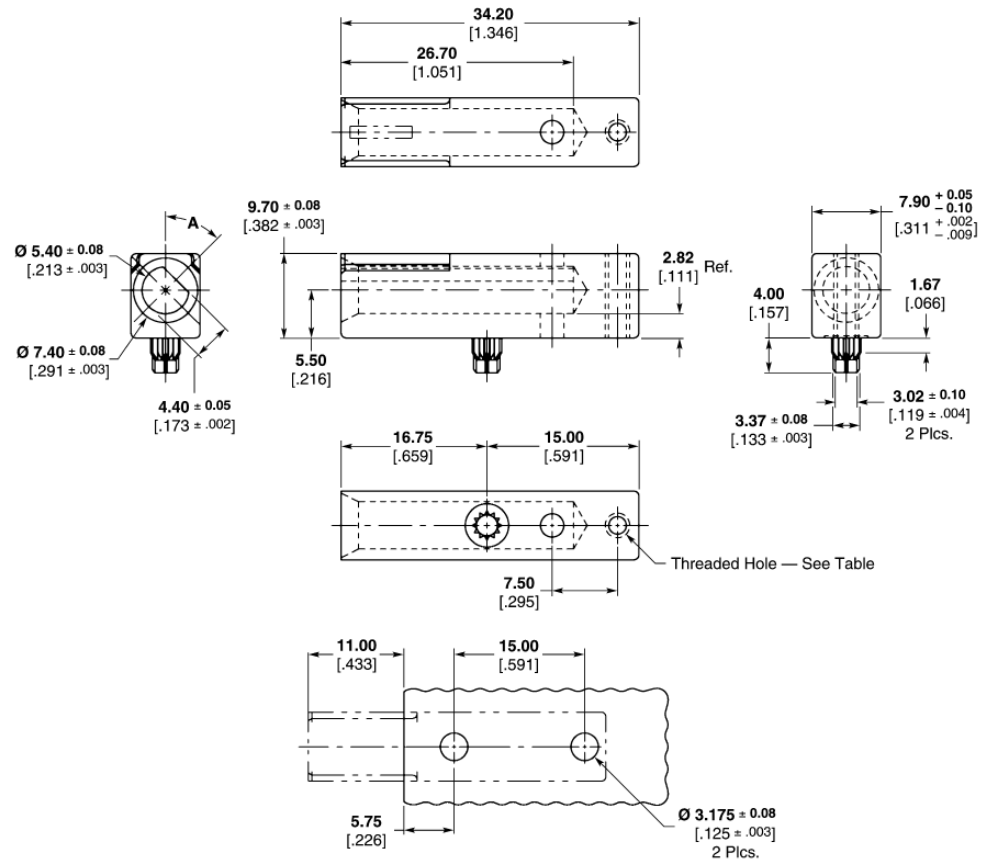

Note: All part numbers are RoHS compliant.

Z-PACK HM-Zd Connector (Continued)

Power and Guide Hardware
(Continued)

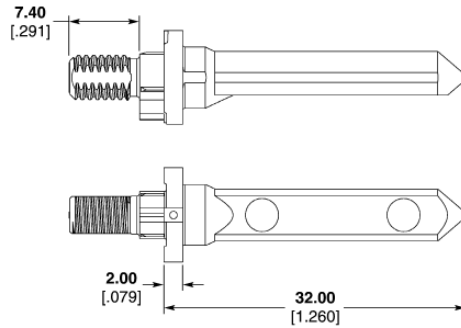

1-1410773-1 Series

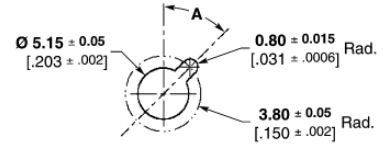

PCB Layout for Guidepost

Note: Key hole orientation (Dim. A) per mating guide module Part Number table (Orientation shown on PCB layout is for Part Number 1-1410297-2).

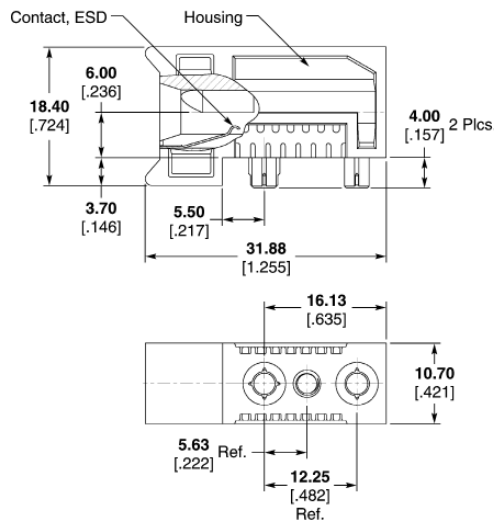

1-1410297 Series

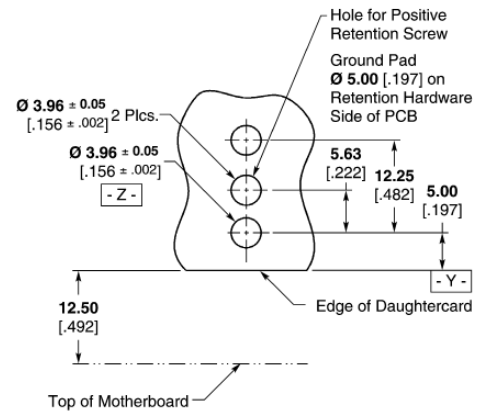

PCB Layout Connector Side

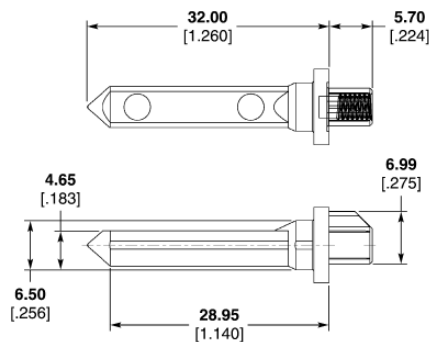

1410548 Series

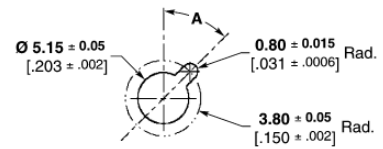

PCB Layout for Guidepost

Note: Key hole orientation (Dim. A) per mating guide module Part Number table (Orientation shown on PCB layout is for Part Number 1-1410297-2).

MULTIGIG RT Product Guide Modules

Description	Part Number
Keyed/ESD Guide Module Assembly, Daughtercard*	1-1410297-X
Keyed Guide Pin, Backplane**	1-1410773-X
Keyed Guide Pin, Backplane**	1410548-X

* See customer drawing for specific keying options.

** Internal and external threaded versions available, see customer drawings for available options.

Note: All part numbers are RoHS compliant.

Z-PACK HM-Zd Connector (Continued)

AdvancedTCA Connectors

AdvancedTCA Zone 2

Front Board Connector
4 Pair Right Angle Receptacle
Part Number 6469001-1
 See page 57 for more details

Backplane Connector
4 Pair Vertical Header
Part Number 6469002-1
 See page 61 for more details

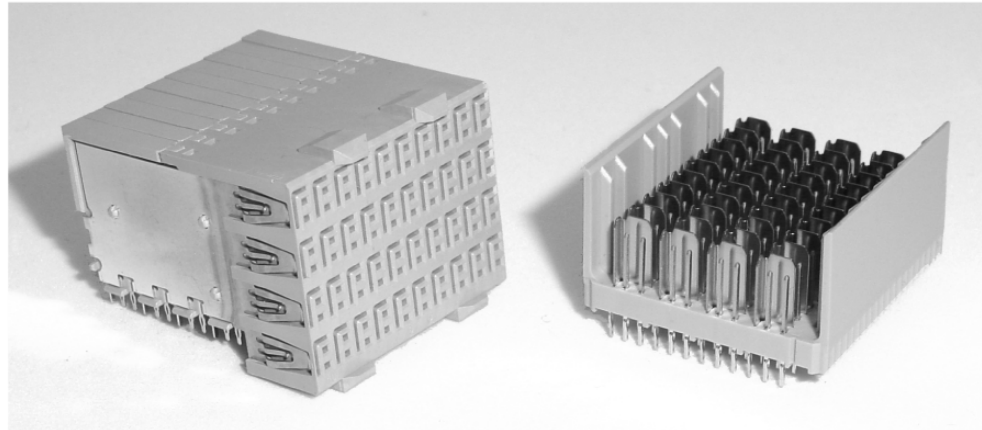

Front Board Connector

Backplane Connector

AdvancedTCA Product Guide/Keying Modules

The AdvancedTCA Guide Modules can be used in a wide variety of applications. For *motherboard-to-daughtercard applications* the vertical pin and right angle socket are used. This popular configuration is further supported by our wide offering of available keying positions. Each of the two keyed guide pins and guide sockets per module can be produced in a variety of different key positions. For *co-planar applications*, the right angle guide pins are used along with the right angle guide sockets. Both vertical and right angle guide pins are available in short or long sizes, to accommodate being used with different Tyco Electronics connectors.

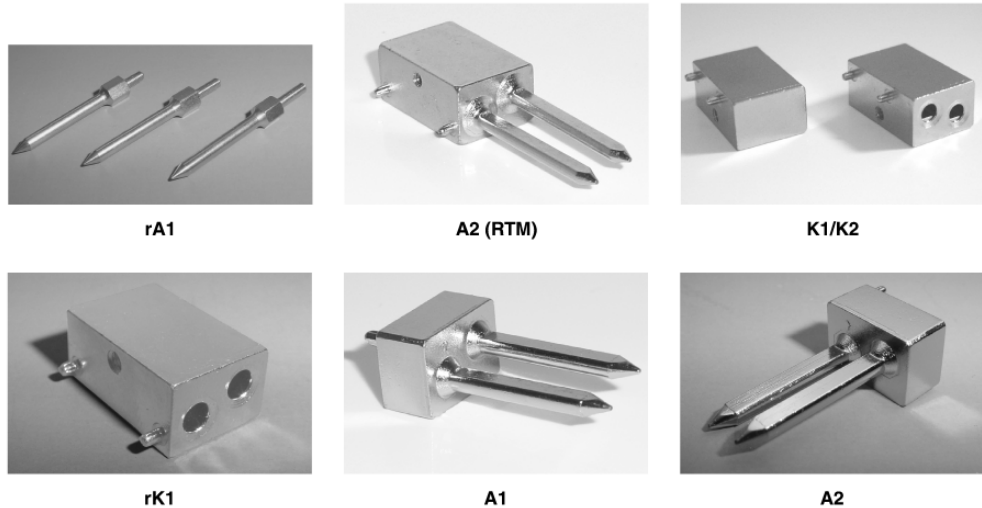

ATCA Name	ATCA Location	Description	Part Number
rA1	Backplane	Rear Alignment Post 3.00 – 4.00 [.118 – .157] PCB Thickness	1469269-2
rA1	Backplane	Rear Alignment Post 4.10 – 6.00 [.161 – .236] PCB Thickness	1469269-4
rA1	Backplane	Rear Alignment Post 6.10 – 8.00 [.240 – .315] PCB Thickness	1469269-6
A2 (RTM)	Rear Transition Module	Right Angle Male, Keyed	1-1469372-1
K1/K2	Front Board	Right Angle Female, Keyed	1-1469373-1
K1/K2	Front Board	Right Angle Female, Unkeyed Dummy	9-1469373-9
rK1	Rear Transition	Right Angle Female	1469374-1
A1	Backplane	Vertical Male, Keyed, Short	1-1469387-1
A2	Midplane	Vertical Male, Keyed, Long	1-1469388-1

AdvancedTCA is a trademark of PICMG-PCI Industrial Computer Mfg's. Group.

Note: All part numbers are RoHS compliant.

Z-PACK HM-Zd Connector (Continued)

AdvancedTCA Power Connectors (Zone 1)

Backplane Connector Straight, Compliant Press Fit Part Number 1766501-1

Material and Finish

Insulators — Thermoplastic, glass reinforced, black, UL94V-0

Signal Pins — Copper alloy

Power Contacts — High conductivity copper alloy, plated 0.0076 [0.00030] min. gold in mating area per Tyco Electronics Specification 112-162-5, over 0.00130 [0.00050] min. nickel per Tyco Electronics Specification 112-25-2

Solder tails — 0.0030 - 0.0043 [0.000120 - .000170] tin plated per lead free Tyco Electronics Specification 112-65-1, matt finish

Notes:

1. Mounting Holes ($\varnothing 2.00$ [0.079] x 5.00 [1.97] DP) for use with self tapping screw (customer supplied).
2. Positions 1-4 not populated and reserved for future use.

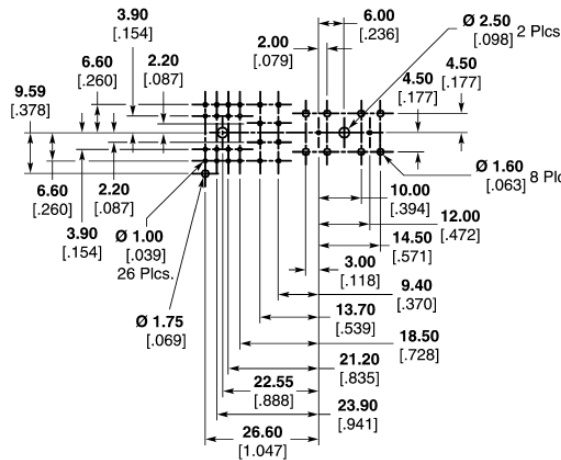
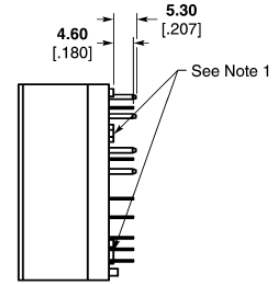
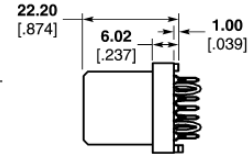
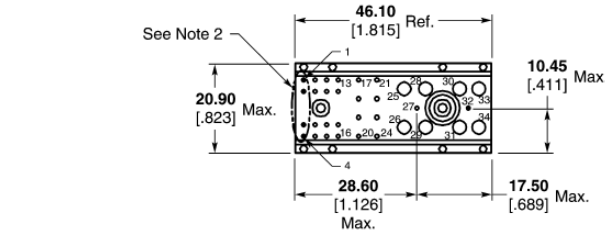

Printed Circuit Layout

Front Board Connector Right Angle, Compliant Press Fit Part Number 1766500-1

Material and Finish

Insulators — Thermoplastic, glass reinforced, black, UL94V-0

Signal Pins — Copper alloy

Power Contacts — High conductivity copper alloy, plated 0.00076 [0.00030] min. gold in mating area per Tyco Electronics Specification 112-162-5, over 0.00130 [0.00050] min. nickel per Tyco Electronics Specification 112-25-2

Solder Tails — 0.0030 - 0.0043 [0.000120 - .000170] tin plated per lead free Tyco Electronics Specification 112-65-1, matt finish

Notes:

1. Mounting Holes ($\varnothing 2.00$ [0.079] x 5.00 [1.97] DP) for use with self tapping screw (customer supplied).
2. Positions 1-4 not populated and reserved for future use.

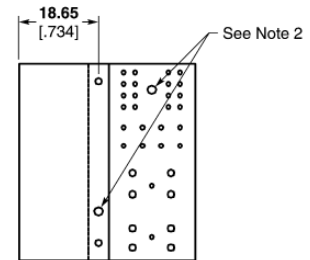
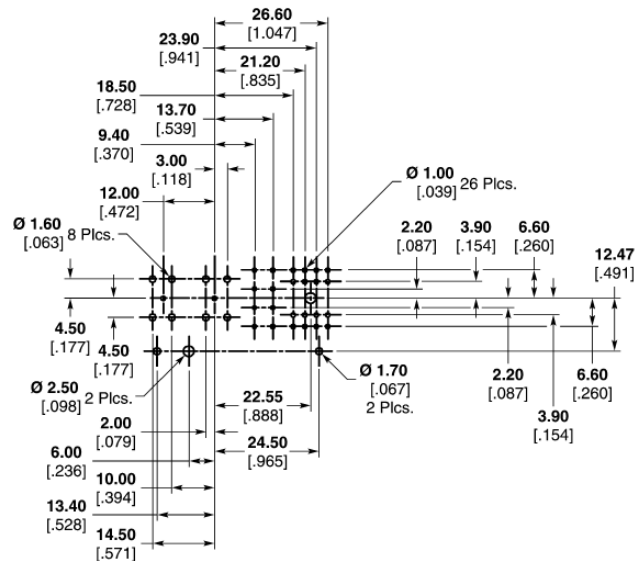
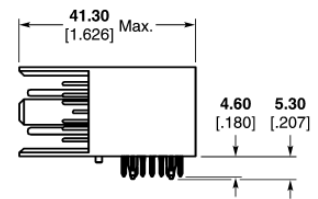
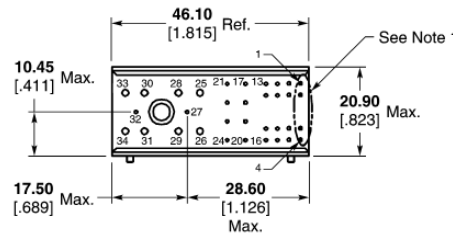

Printed Circuit Layout

AdvancedTCA is a trademark of PICMG-PCI Industrial Computer Mfg's. Group.

Note: All part numbers are RoHS compliant.

Z-PACK HM-Zd Connector (Continued)

Vertical Pin Headers for Cable Assemblies

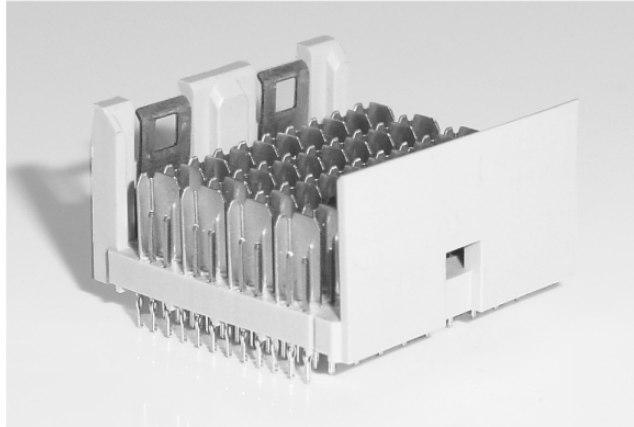

Note: 4 Pair Shown Above

Pair Count	Part Number	Tail Length	Mating Pin Length	Column Count	Module Length	Signals	Grounds	Insertion Pin Header	Application Tooling ²		
									Pin Removal	Housing Removal	Repair Pin Insertion
4	6469105-1 ¹	2.50 .098	5.30 .209	10	25.00 .984	80	40	91373-1	1583237-1	1725635-1	1583255-1
4	6469124-1 ¹	1.80 .071	5.30 .209	10	25.00 .984	80	40	91373-1	1583237-1	1725635-1	1583255-1
2	6469106-1 ¹	2.50 .098	5.30 .209	10	25.00 .984	40	20	91372-1	1583237-1	1804170-1	1583255-1
2	6469125-1 ¹	1.80 .071	5.30 .209	10	25.00 .984	40	20	91372-1	1583237-1	1804170-1	1583255-1

¹ With latch for cable assemblies.

² See page 93 for Instruction Sheet Number.
For PCB Layout, see page 61-63.

Right Angle Pin Headers for Cable Assemblies

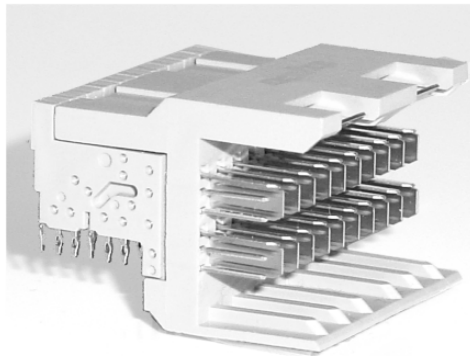

Note: 2 Pair Shown Above

Pair Count	Part Number	Tail Length	Mating Pin Length	Column Count	Module Length	Signals	Grounds	Insertion Pin Header	Application Tooling ²		
									Housing Removal	Repair Chiclet Removal	
4	6469668-1 ¹	2.20 .087	5.30 .209	10	25.00 .984	80	40	1804244-1	1804239-1		1804177-1
2	6469354-1 ¹	2.20 .087	5.30 .209	10	25.00 .984	40	20	1804178-1	1804172-1		1804175-1

¹ With latch for cable assemblies.

² See page 93 for Instruction Sheet Number.
For PCB Layout, see pages 64-66.

Note: All part numbers are RoHS compliant.

Z-PACK HM-Zd Connector (Continued)

**4 Pair 5 Column and
4 Pair 10 Column
Push-to-Release Cable
Assemblies**

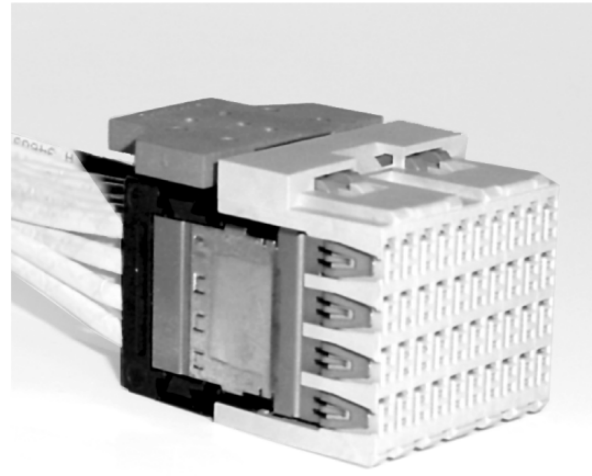
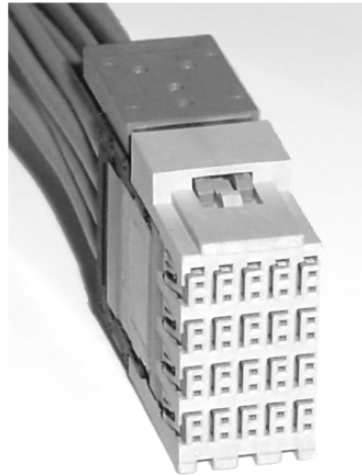

Note: Design shown for reference only. Contact Tyco Electronics for other variations and configurations.

**2 Pair 5 Column and
2 Pair 10 Column
Push-to-Release Cable
Assemblies**

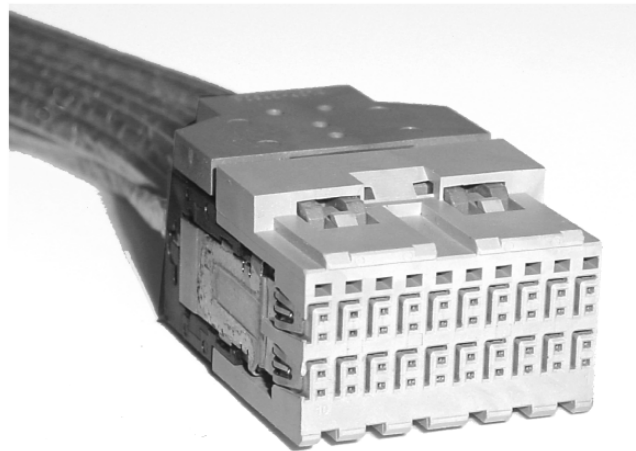

Note: Design shown for reference only. Contact Tyco Electronics for other variations and configurations.

**4 Pair
Cable Assemblies for
Backplane Testing**

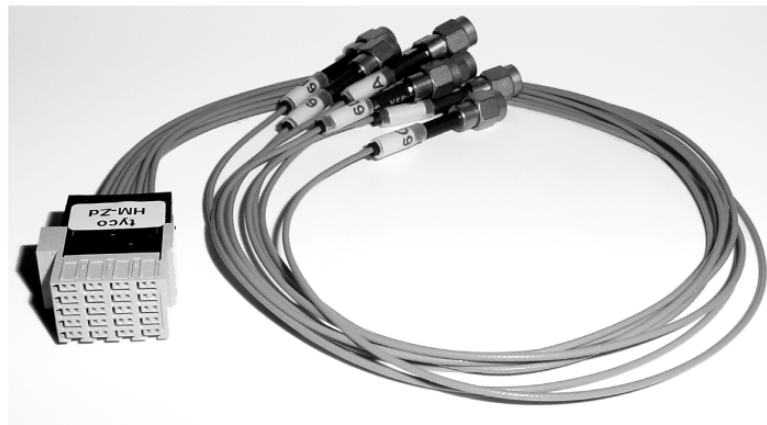

Note: Design shown for reference only. Contact Tyco Electronics for other variations and configurations.

Z-PACK HM-Zd Connector (Continued)

Recommended Printed Circuit Board Layouts

Z-PACK HM-Zd Backplane and Z-PACK 2mm HM Connectors

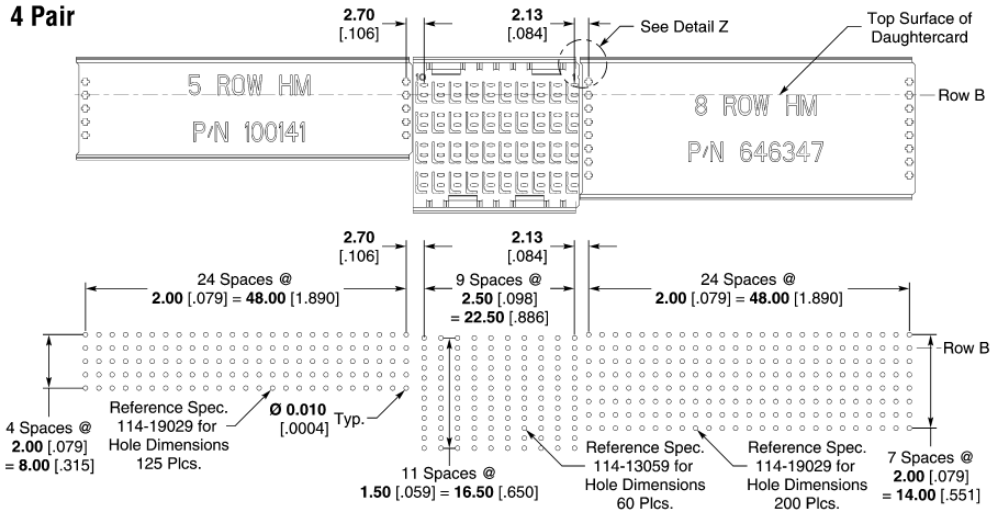
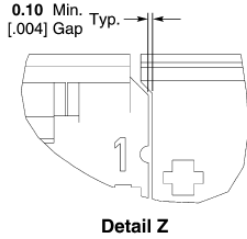

Note:

1. Dimensions shown represent minimum stacking dimensions allowable. Customer specific applications will dictate actual module spacing.

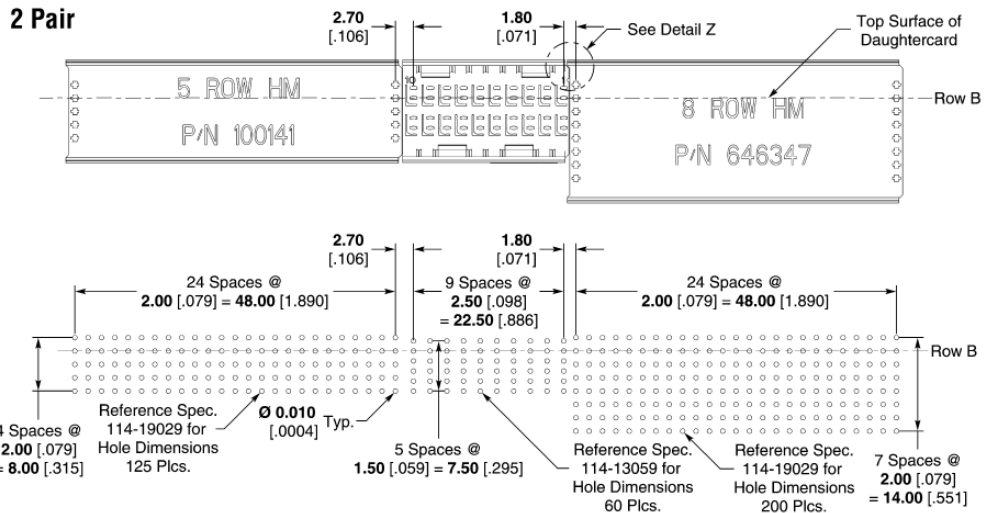
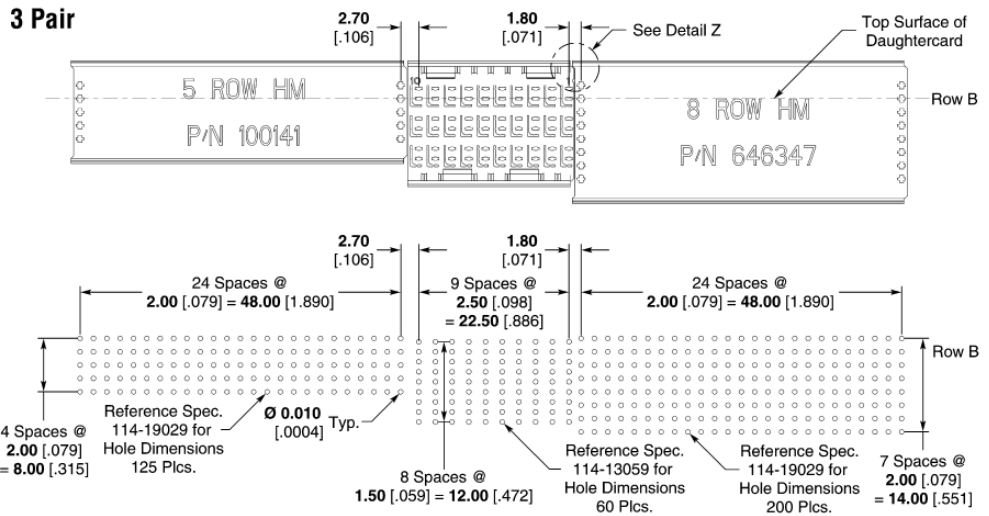

Z-PACK HM-Zd Connector (Continued)

Recommended Printed Circuit Board Layouts
(Continued)

Z-PACK HM-Zd Daughtercard and Z-PACK 2mm HM Connectors

4 Pair

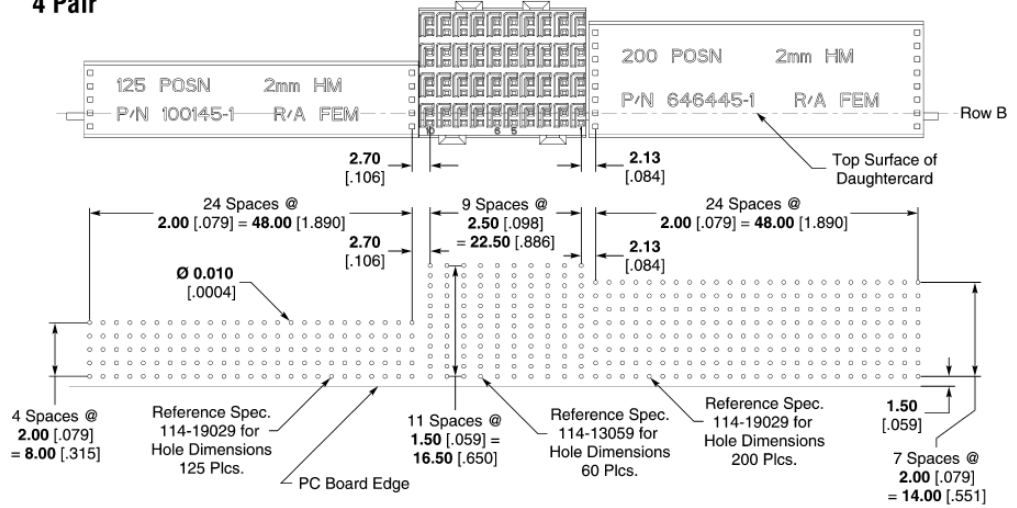

Note:

1. Dimensions shown represent minimum stacking dimensions allowable. Customer specific applications will dictate actual module spacing.

3 Pair

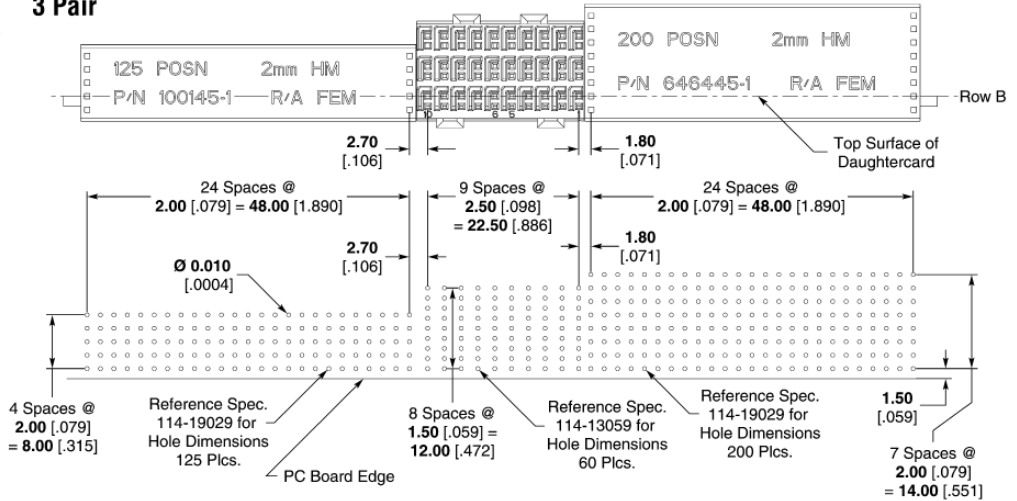

2 Pair

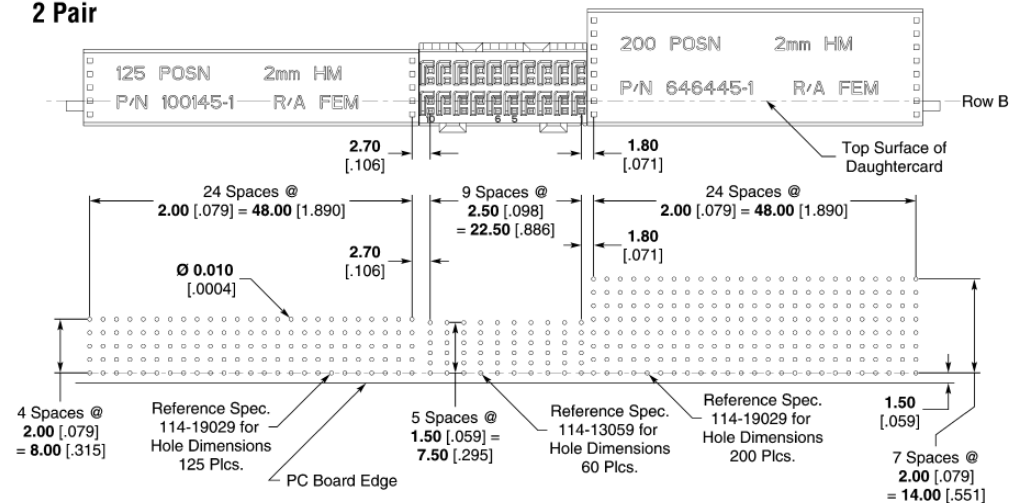

Z-PACK HM-Zd Connector (Continued)

Recommended Printed Circuit Board Layouts

(Continued)

Z-PACK HM-Zd Backplane Connector with Unkeyed Guide Pins

Note:

1. Dimensions shown represent minimum stacking dimensions allowable. Customer specific applications will dictate actual module spacing.

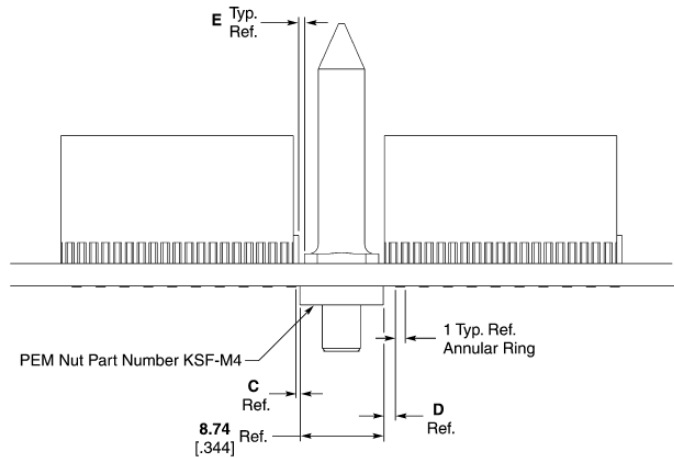
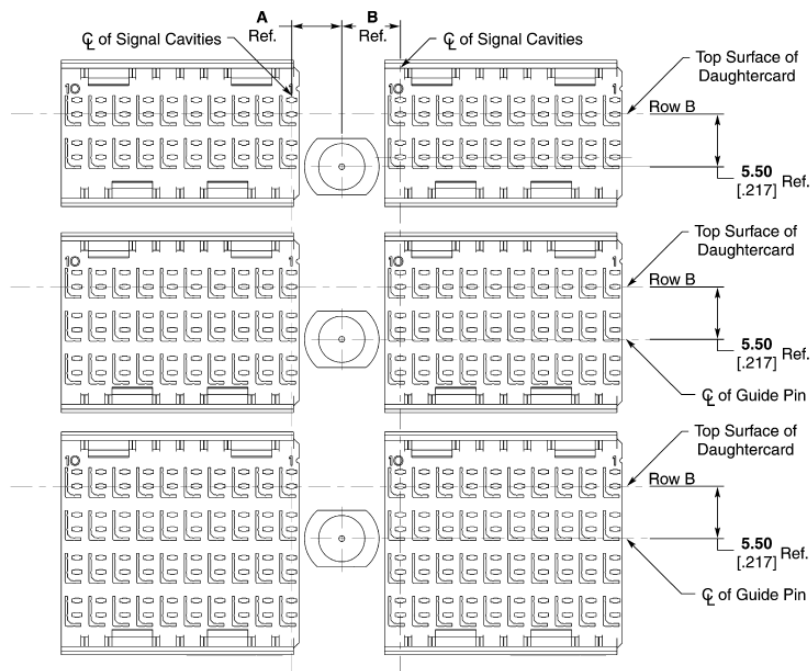

Dimension					Part Number
A	B	C	D	E	
5.25 .207	6.15 .242	0.40 .016	1.30 .051	0.60 .024	223956
5.52 .217	6.42 .253	0.65 .026	1.55 .061	0.42 .017	5223985

Note: All part numbers are RoHS compliant.

Z-PACK HM-Zd Connector (Continued)

Recommended Printed Circuit Board Layouts

(Continued)

Z-PACK HM-Zd Daughtercard Connector With Unkeyed Female Guide Modules

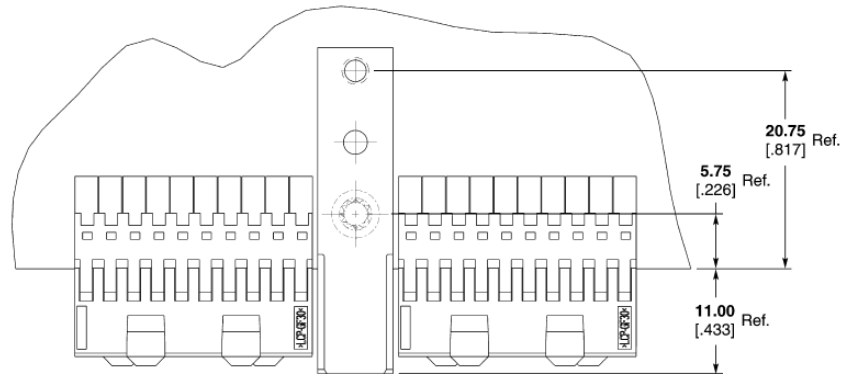

Note:

1. Dimensions shown represent minimum stacking dimensions allowable. Customer specific applications will dictate actual module spacing.

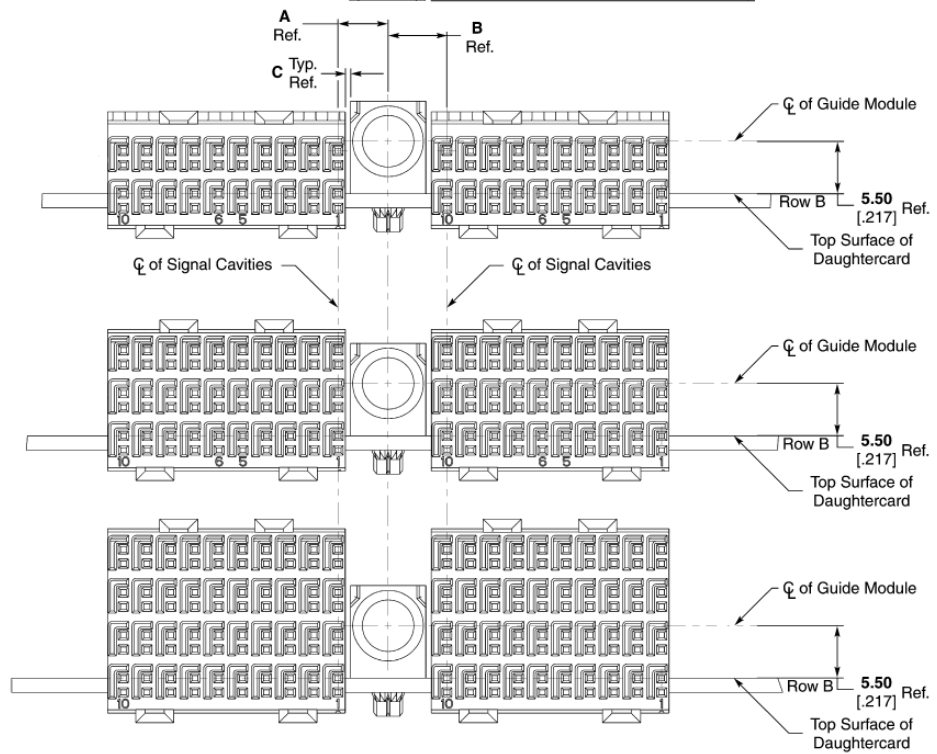

Dimension			Part Number
A	B	C	
5.25 .207	6.15 .242	0.56 .022	5223957
5.52 .217	6.42 .253	0.83 .033	5223986

Note: All part numbers are RoHS compliant.

Z-PACK HM-Zd Connector (Continued)

Recommended Printed Circuit Board Layouts

(Continued)

Z-PACK HM-Zd Backplane Connector and Universal Power Modules

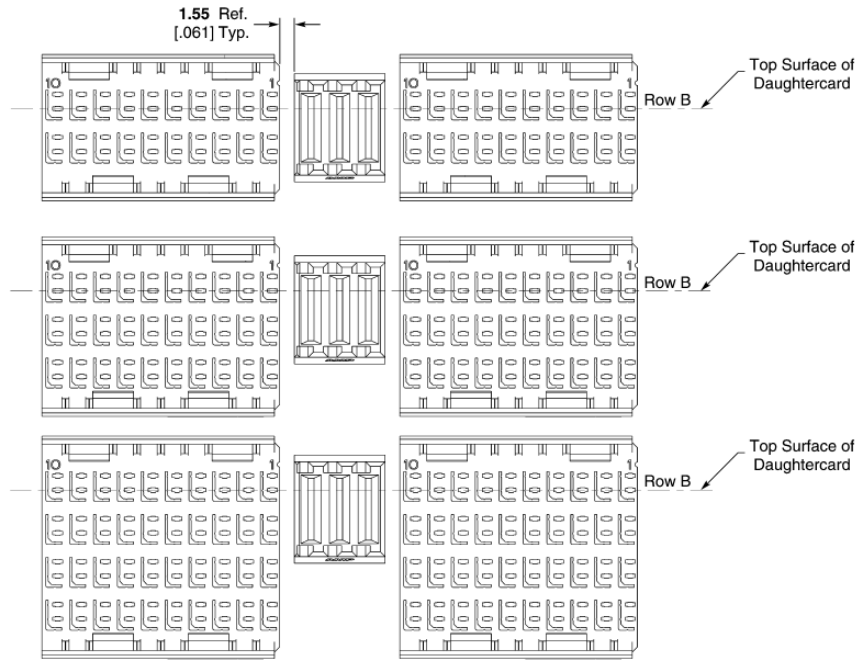

Note:

1. Dimensions shown represent minimum stacking dimensions allowable. Customer specific applications will dictate actual module spacing.

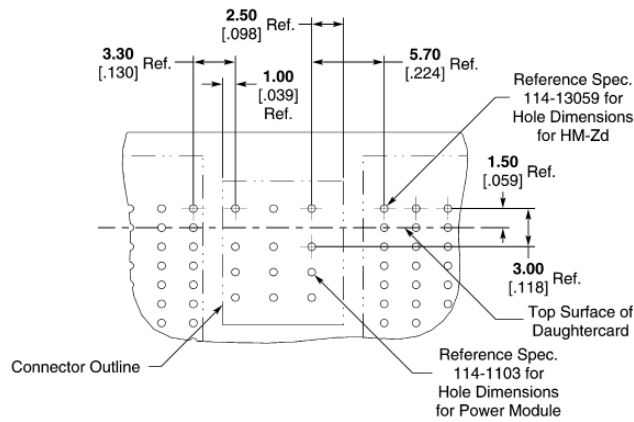

Recommended PC Board Layout Component Side

Z-PACK HM-Zd Connector (Continued)

Recommended Printed Circuit Board Layouts

(Continued)

Z-PACK HM-Zd Daughtercard Connector and Universal Power Modules

Note:

1. Dimensions shown represent minimum stacking dimensions allowable. Customer specific applications will dictate actual module spacing.

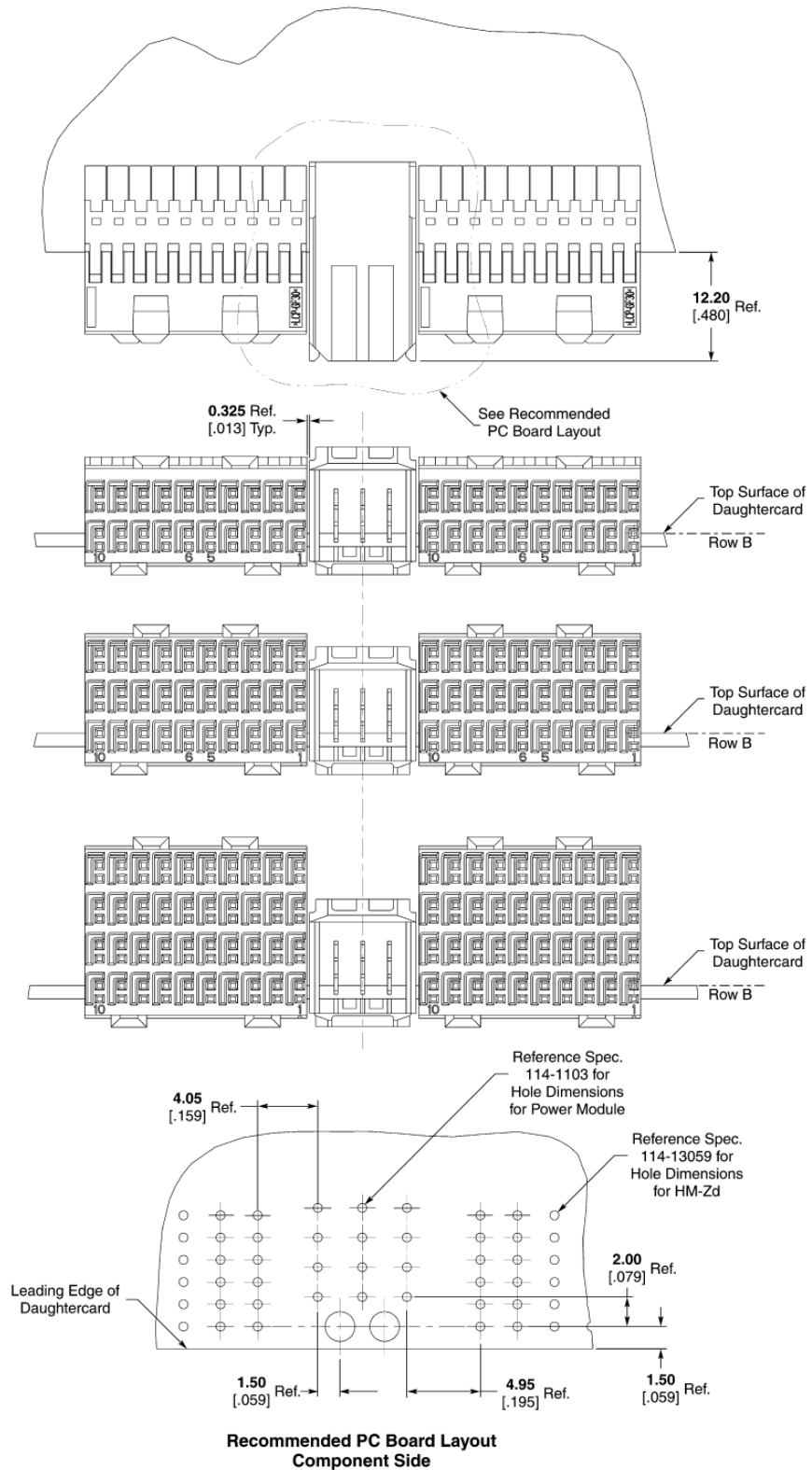

3
Z-PACK HM-Zd Connector

Z-PACK HM-Zd Connector (Continued)

**Recommended Printed
Circuit Board Layouts**

(Continued)

**Z-PACK HM-Zd Backplane
Connector and MULTIGIG RT
Connector Guide Modules**

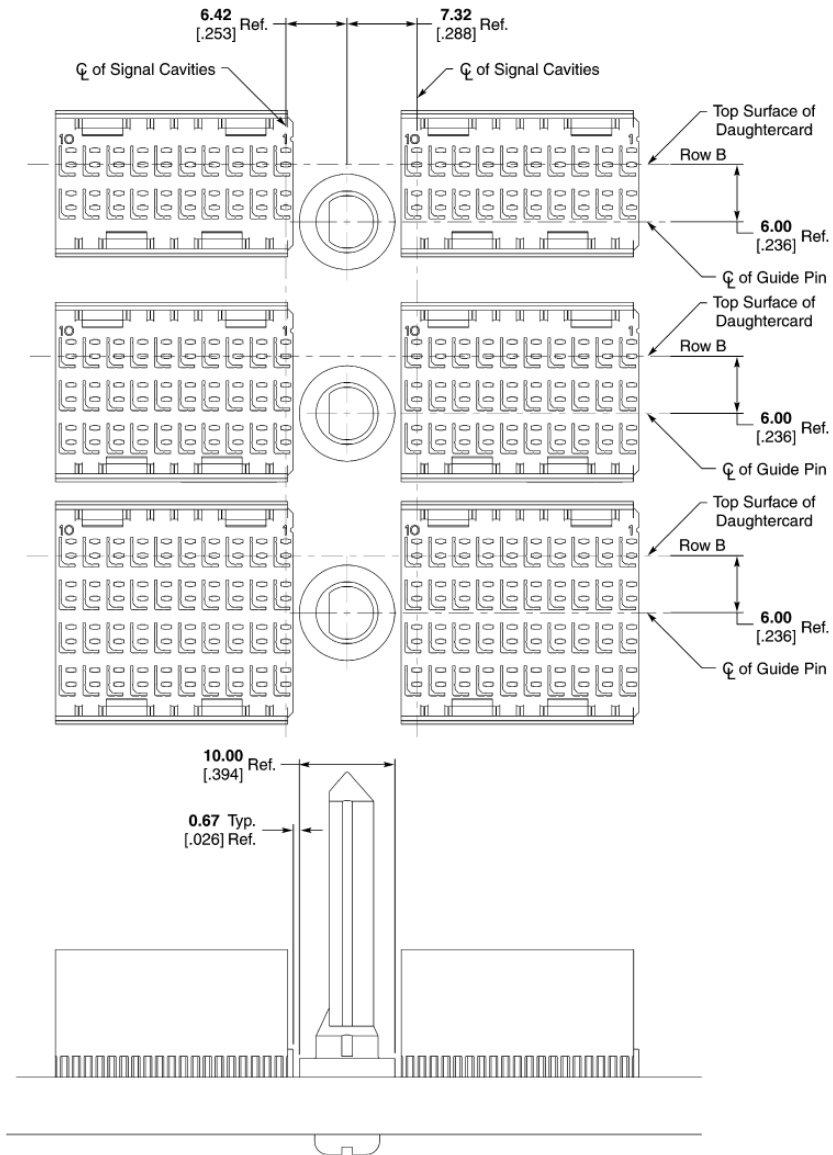

Note:

1. Dimensions shown represent minimum stacking dimensions allowable. Customer specific applications will dictate actual module spacing.

Z-PACK HM-Zd Connector (Continued)

**Recommended Printed
Circuit Board Layouts**

(Continued)

**Z-PACK HM-Zd Daughtercard
Connector and MULTIGIG RT
Connector Guide Modules**

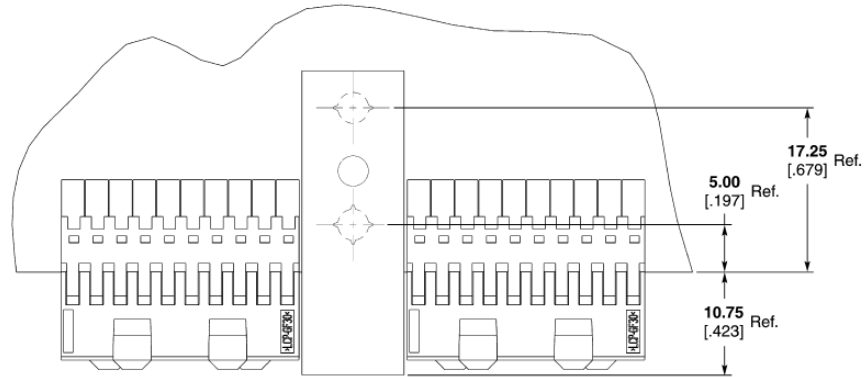

Note:

1. Dimensions shown represent minimum stacking dimensions allowable. Customer specific applications will dictate actual module spacing.

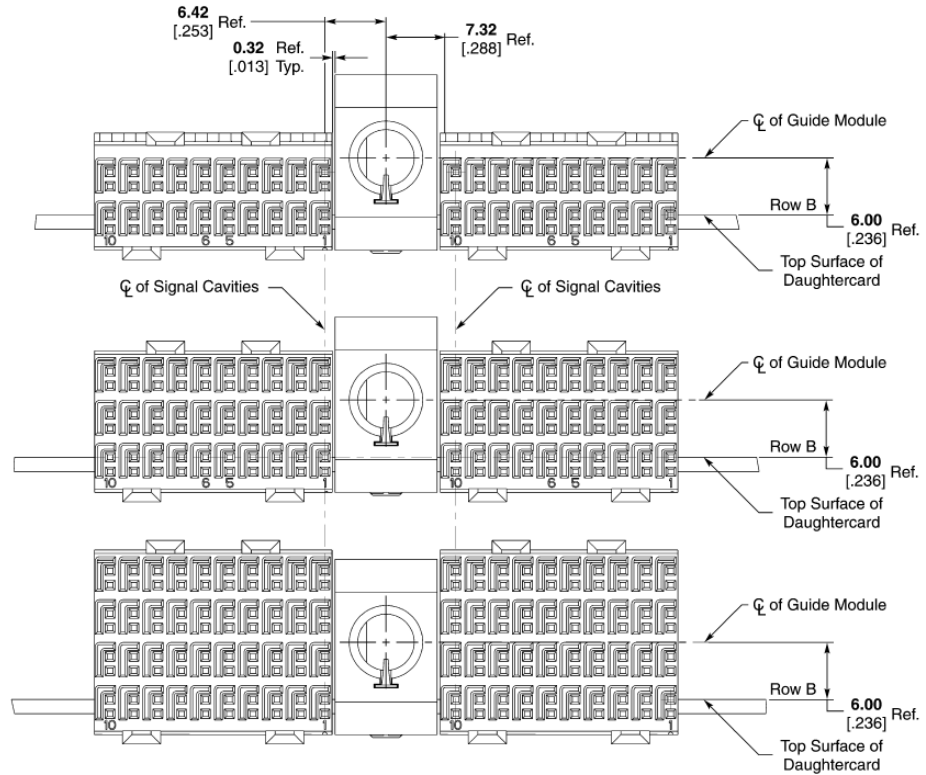

3
Z-PACK HM-Zd Connector

Z-PACK HM-Zd Connector (Continued)

Recommended Printed Circuit Board Layouts

(Continued)

Z-PACK HM-Zd Connector Recommended Midplane Layout Option #1

Notes:

1. Minimum recommended backplane thicknesses calculated using maximum and minimum tolerances. No statistical methods were used.
2. Refer to the customer print for complete column and row designations.

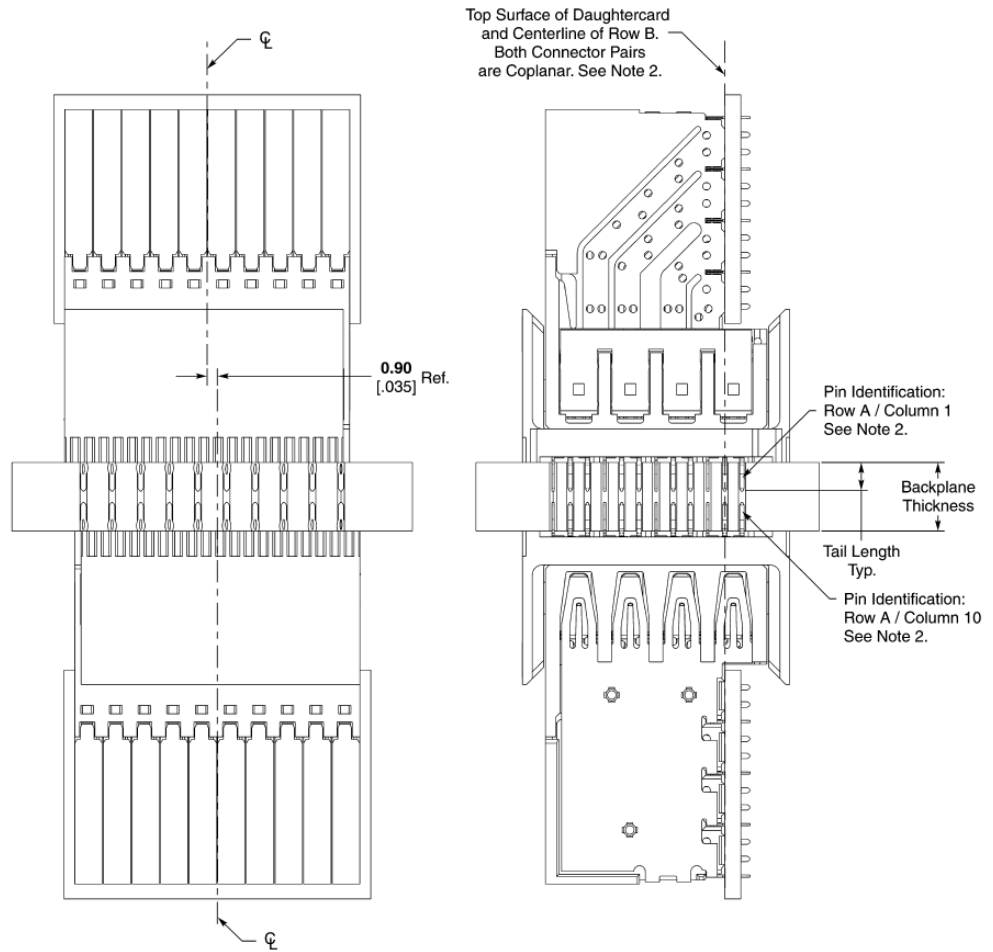

Tail Length	Min. Recommended Backplane Thickness
1.80 .071	4.00 .157
2.50 .098	5.40 .213

Z-PACK HM-Zd Connector (Continued)

Recommended Printed Circuit Board Layouts

(Continued)

Z-PACK HM-Zd Connector Recommended Midplane Layout Option #2

Notes:

1. Minimum recommended backplane thicknesses calculated using maximum and minimum tolerances. No statistical methods were used.
2. Refer to the customer print for complete column and row designations.
3. **An additional row of holes must be drilled to accommodate this midplane application.**

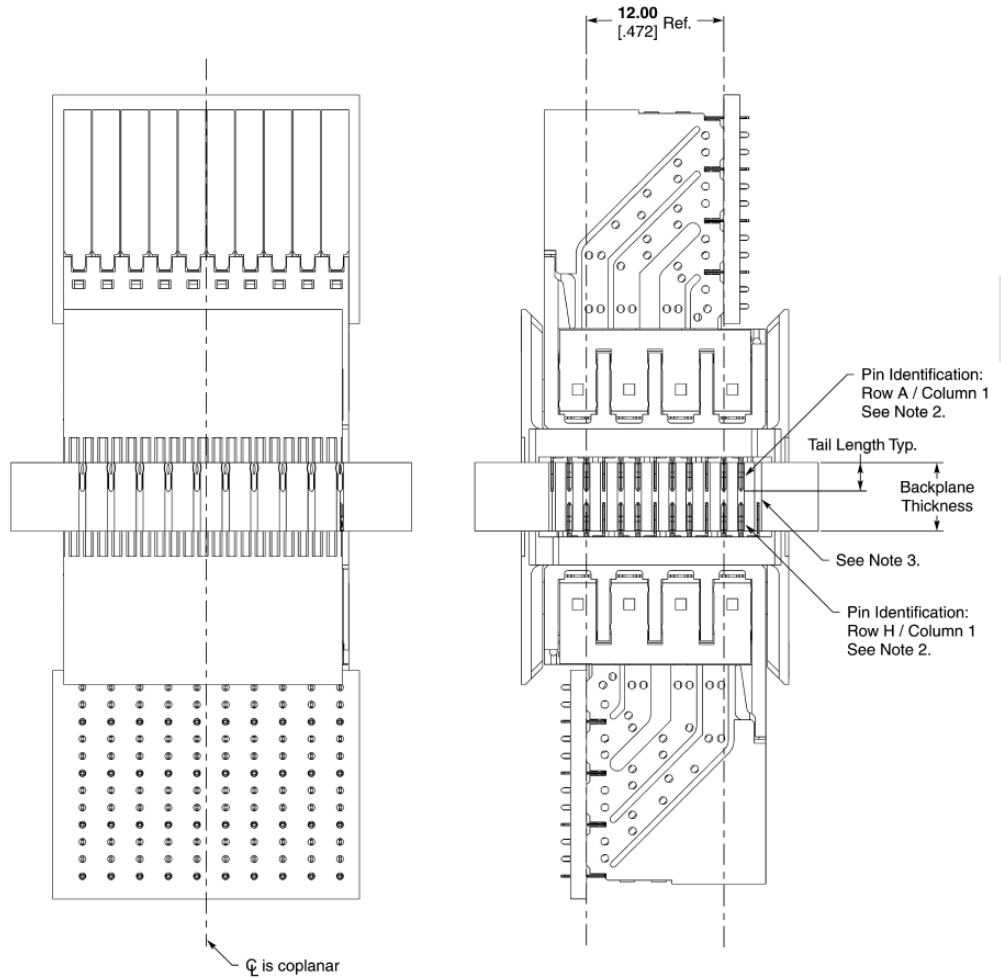

3
Z-PACK HM-Zd Connector

Tail Length	Min. Recommended Backplane Thickness
1.80 .071	4.00 .157
2.50 .098	5.40 .213

Z-PACK HM-Zd Connector (Continued)

**Recommended Printed
Circuit Board Layouts**

(Continued)

**Z-PACK HM-Zd Connector
Coplanar**

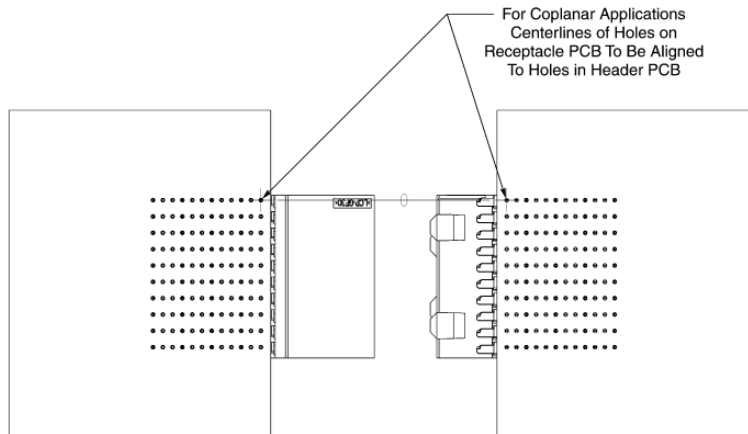
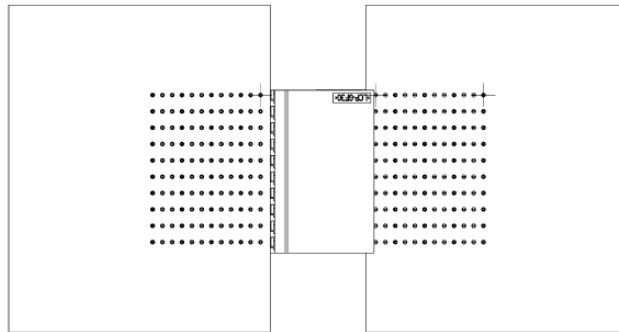
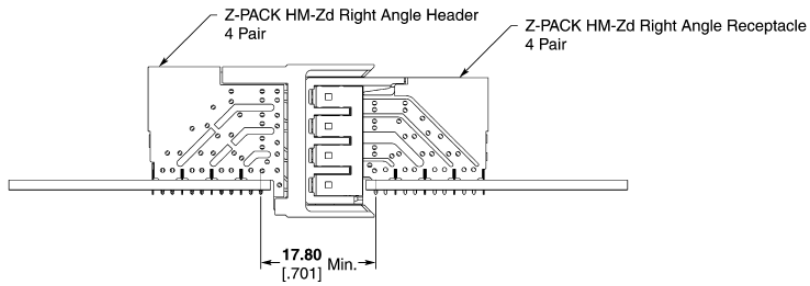
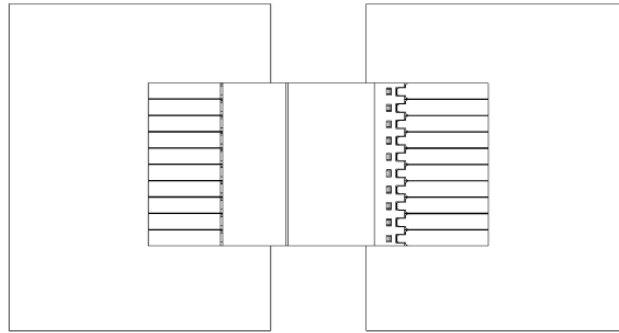

Z-PACK HM-Zd Connector (Continued)

Z-PACK HM-Zd Connector Footprint and PC Board Trace Routing

- Accounts for system design requirements
- Footprint is optimized for low noise and ease of routing
- Footprint permits wide traces for long runs and without having to separate differential pairs
- Footprint supports quad routing techniques (see below)

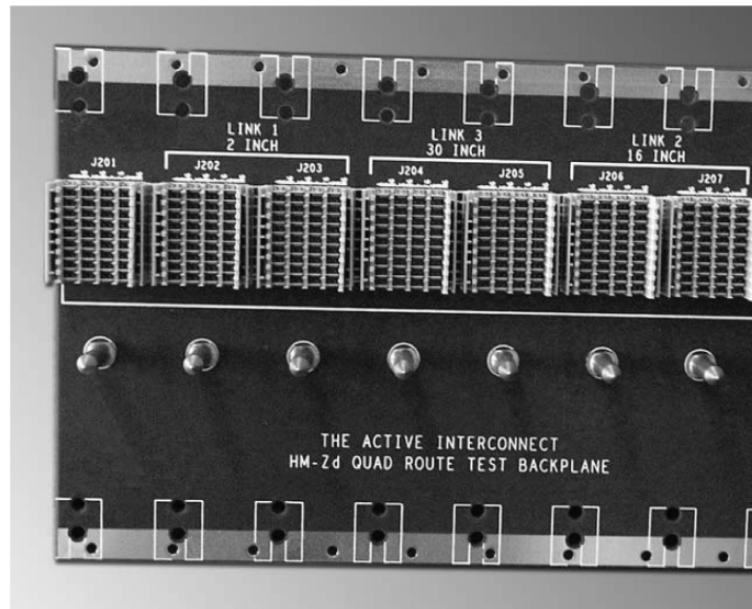

Benefits of Quad Routing

- **Better Platform Characteristics**
 - Performance variation due to layer connection is reduced
 - Crosstalk is reduced
 - Return loss is reduced
- **Enables a lower cost solution**
 - Cost of better materials is offset by reduced processing
 - Increased manufacturability—less layers and decreased aspect ratios
 - Decreased number of layers reduces the need for counterboring of PC boards

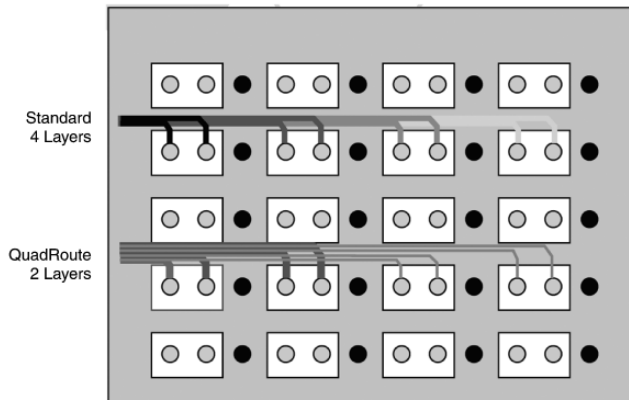

Notes Regarding Quad Routing:

1. Within pin field, center signal pairs between signal columns
2. Trace separation is increased over "standard" recommendations to further limit trace to trace crosstalk
3. Recommend Quad Routing pairs together that are propagating in the same direction

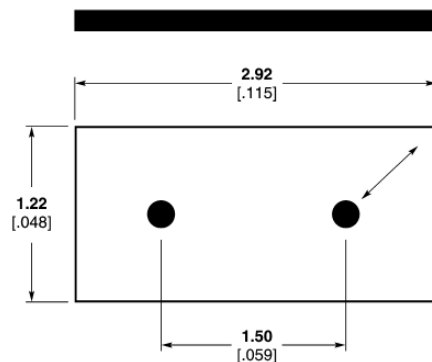
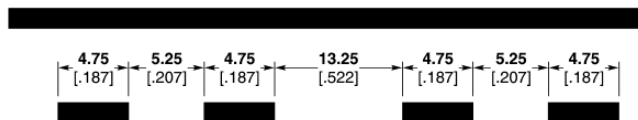

Notes Regarding Antipad Design:

1. An oval shaped antipad may be used to increase PC board manufacturability and to improve trace break-out
2. Antipad length shown is 2.92 [.114]. An antipad length up to 3.48 [.137] may be used.

For further details request Report # 20GC015-1 or visit http://catalog.tycoelectronics.com/TE/GeneralInfo/footprint_optimization.pdf

Z-PACK HM-Zd Connector (Continued)

Connector Housing Gathering Capabilities

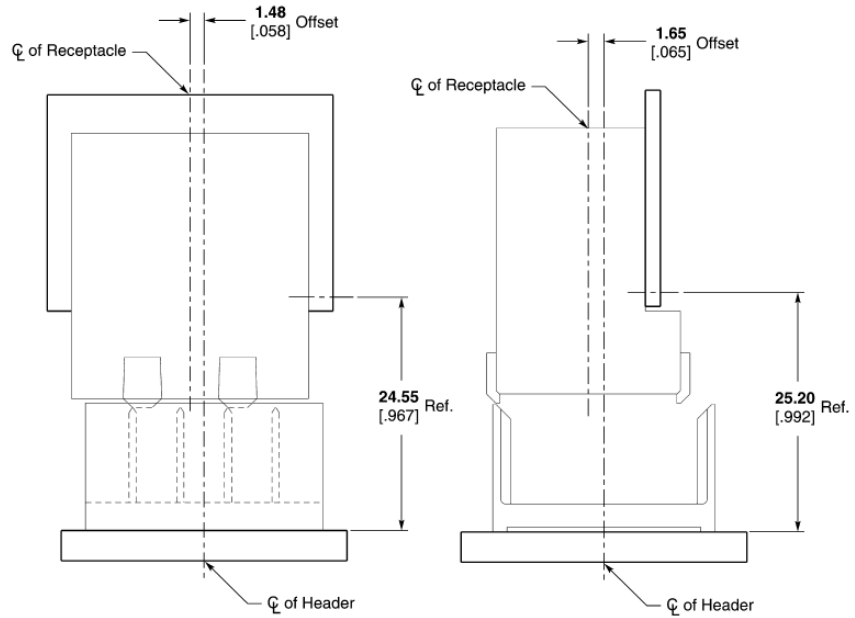

Note: Dimensions are at nominal conditions. The offsets are to be applied to either side of the header center line.

Z-PACK HM-Zd Connector (Continued)

Z-PACK HM-Zd Connector Mating Sequence Chart



Product Family	Dim. C	Dim. A Fully Mated	Contact	Dim B.		Fully Mated Wipe Length
				Reliable Mate	First Mate Last Break	
Z-PACK HM-Zd Product	1.50 .059	12.50 .492	Ground Shield	16.78 [.661]	17.55 [.691]	4.28 [.169]
			Signal Level 2	15.41 [.607]	15.85 [.624]	2.91 [.115]
			Signal Level 1	13.91 [.548]	14.35 [.565]	1.41 [.056]
Z-PACK HM-Zd Guide Hardware	3.00 .118	12.50 .492	24.0 mm Pin	27.50 [1.083]	33.40 [1.315]	N/A
			22.2 mm Pin	25.70 [1.012]	31.60 [1.244]	N/A
			Key Blocking Point	N/A	22.03 [.867]	N/A
Z-PACK TinMan Product	1.50 .059	12.50 .492	Ground Pins	16.44 [.647]	17.13 [.674]	3.94 [.155]
			Signal Level 2	14.94 [.588]	15.63 [.615]	2.44 [.096]
			Signal Level 1	N/A	N/A	N/A
Z-PACK 2mm HM Product	1.50 .059	12.50 .492	Signal Level 3	18.27 [.719]	18.84 [.742]	5.77 [.227]
			Signal Level 2	16.77 [.660]	17.34 [.683]	4.27 [.168]
			Signal Level 1	15.27 [.601]	15.84 [.624]	2.77 [.109]
MULTIGIG RT T1 Product	2.50 .098	12.50 .492	Ground	18.00 [.709]	—	5.50 [.217]
			Signal Level 3	18.00 [.709]	—	5.50 [.217]
			Signal Level 2	16.50 [.650]	—	4.00 [.157]
			Signal Level 1	15.00 [.591]	—	2.50 [.098]
MULTIGIG RT T2 Product	2.25 .089	12.50 .492	Ground	18.00 [.709]	—	5.50 [.217]
			Signal Level 3	18.00 [.709]	—	5.50 [.217]
			Signal Level 2	16.50 [.650]	—	4.00 [.157]
MULTIGIG RT Power Module	5.50 .217	12.50 .492	Power Level 3	23.75 [.935]	—	11.25 [.443]
			Power Level 2	22.25 [.876]	—	9.75 [.384]
			Power Level 1	20.75 [.817]	—	8.25 [.325]
MULTIGIG RT Guide Hardware	N/A	12.50 .492	Guide Pin Key	33.25 [1.309]	N/A	20.75 [.817]
			Guide ESD Contact	30.75 [1.211]	—	18.25 [.719]
Z-PACK HS3 Product	1.50 .059	12.50 .492	Ground	17.08 [.672]	17.60 [.693]	4.78 [.188]
			Signal Level 2	16.05 [.632]	16.47 [.648]	3.75 [.148]
			Signal Level 1	14.55 [.573]	14.97 [.589]	2.25 [.089]
UPM	3.50 .138	12.50 .492	Power Level 3	20.25 [.797]	20.95 [.825]	8.10 [.319]
			Power Level 2	18.65 [.734]	19.35 [.762]	6.50 [.256]
			Power Level 1	17.03 [.670]	17.73 [.698]	4.88 [.192]
UPM Guide Hardware	5.75 .226	12.50 .492	Guide Pin Key	31.39 [1.236]	36.16 [1.424]	N/A
			Keyed Guide Pin	31.39 [1.236]	36.16 [1.424]	N/A
			Keyed Guide Pin	35.23 [1.387]	40.00 [1.575]	N/A
MULTI-BEAM XL Right Angle Header to Vertical Receptacle	5.08 .200	14.73 .580	PreMate Power — Level 1	—	16.84 [.663]	5.61 [.221] Min.
			PostMate Power — Level 2	—	17.81 [.701]	4.34 [.171] Min.
			PreMate Signal — Level 2	—	18.26 [.719]	3.81 [.150] Min.
			PostMate Signal — Level 3	—	19.53 [.769]	2.54 [.100] Min.
MULTI-BEAM XL Right Angle Receptacle to Vertical Header	3.81 .150	13.21 .520	PreMate Power — Level 1	—	15.32 [.603]	5.61 [.221] Min.
			PostMate Power — Level 2	—	16.28 [.641]	4.34 [.171] Min.
			PreMate Signal — Level 2	—	16.74 [.659]	3.81 [.150] Min.
			PostMate Signal — Level 3	—	18.01 [.709]	2.54 [.100] Min.

3 Z-PACK HM-Zd Connector

Z-PACK HM-Zd Connector (Continued)

Z-PACK HM-Zd Connector Application Tooling and Equipment



1585280-1 Model AP3



1585696-1 Model BMEP 5T



1585699-1 Model MEP 6T

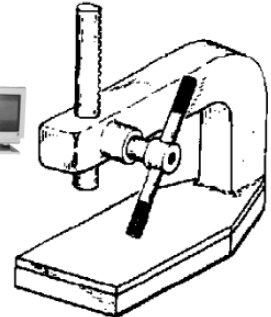

Typical Manual Arbor Frame Assembly (Commercially Available)

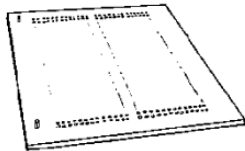

Typical PC Board Support (Customer Supplied)

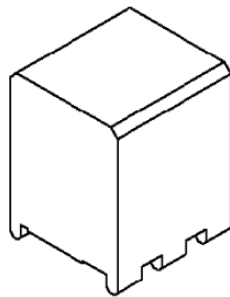

Typical Receptacle Seating Tool IS 408-8500

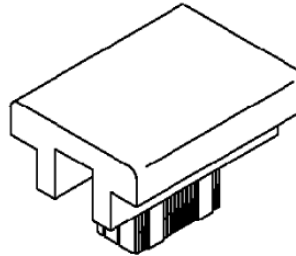

Typical Pin Header Seating Tool IS 408-8501

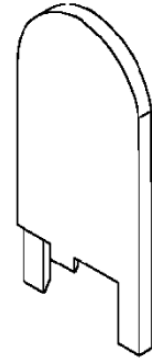

Typical Chiclet Removal Tool IS 408-8647

Typical Receptacle Housing Removal Tool IS 408-8644



Typical Pin (Post) Extraction Tool IS 408-8646

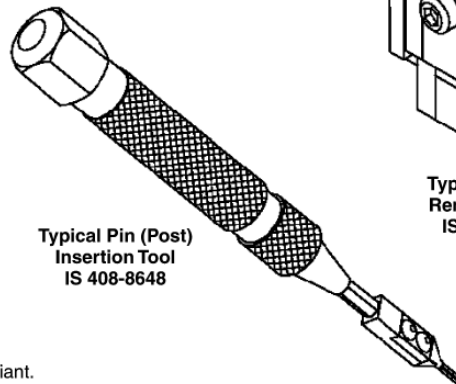
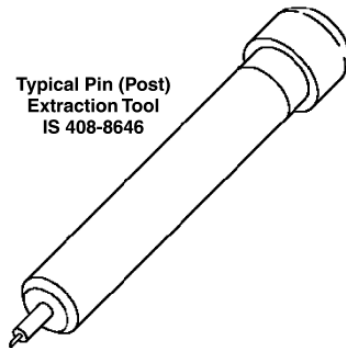

Typical Pin (Post) Insertion Tool IS 408-8648

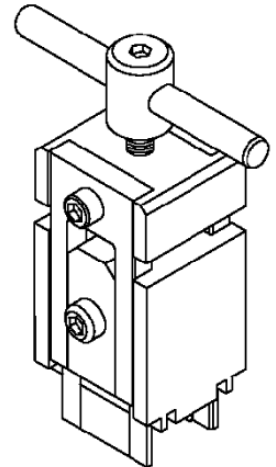

Typical Header Removal Tools IS 408-8645

Note: Typical power units from Tyco Electronics Automation Group include, but are not limited to those shown on this page.

Note: All part numbers are RoHS compliant.

Z-PACK HM-Zd Connector (Continued)

**Z-PACK HM-Zd Connector
Application Tooling and
Equipment** (Continued)

Type	Description	Instruction Sheet	Part Number
Board to Board Insertion Tooling	Seating Tool, Receptacle, 4 Pair, 10 Column	408-8500	91347-1
	Seating Tool, Receptacle, 4 Pair, 15 Column	408-8500	91347-2
	Seating Tool, Receptacle, 4 Pair, 12 Column	408-8500	91347-3
	Seating Tool, Receptacle, 4 Pair, 20 Column	408-8500	91347-4
	Seating Tool, Receptacle, 3 Pair	408-8500	91376-1
	Seating Tool, Receptacle, 2 Pair, 10 Column	408-8500	91350-1
	Seating Tool, Receptacle, 2 Pair, 20 Column	408-8500	91350-2
	Seating Tool, Header, 4 Pair, 10 Column	408-8501	91349-1
	Seating Tool, Header, 4 Pair, 15 Column	408-8501	91349-2
	Seating Tool, Header, 4 Pair, 12 Column	408-8501	91349-3
	Seating Tool, Header, 4 Pair, 20 Column	408-8501	91349-4
	Seating Tool, Header, 3 Pair	408-8501	91375-1
	Seating Tool, Header, 2 Pair, 10 Column	408-8501	91348-1
	Seating Tool, Header, 2 Pair, 20 Column	408-8501	91348-4
	Seating Tool, Right Angle Header, 4 Pair, 10 Column	408-8810	91378-1
	Seating Tool, Right Angle Header, 4 Pair, 12 Column	408-8810	91378-3
	Seating Tool, Right Angle Header, 3 Pair	Note 1	1804179-1
	Seating Tool, Right Angle Header, 2 Pair	Note 1	91377-1
Board to Board Repair Tooling	Receptacle Housing Removal Tool, 4, 3, 2 Pair, 10 Column	408-8644	1583224-1
	Receptacle Housing Removal Tool, 4, 3, 2 Pair, 12 Column	408-8644	1583224-2
	Receptacle Housing Removal Tool, 4, 3, 2 Pair, 15 Column	408-8644	1583224-3
	Receptacle Housing Removal Tool, 4, 3, 2 Pair, 20 Column	408-8644	1583224-4
	Housing Removal Tool, Vertical Header, 4 Pair	408-8645	1583220-1
	Housing Removal Tool, Vertical Pin Header, 3 Pair	408-8645	1725634-1
	Housing Removal Tool, Vertical Header, 2 Pair	408-8645	1583234-1
	Extraction Tool, Individual Pin, Header, 4, 3, 2 Pair	408-8646	1583237-1
	Chiclet Removal Tool, Receptacle, 4 Pair	408-8647	1583248-1
	Chiclet Removal Tool, Receptacle, 3 Pair	408-8867	1673952-1
	Chiclet Removal Tool, Receptacle, 2 Pair	408-8647	1583249-1
	Insertion Tool, Individual Pin, Header, 4, 3, 2 Pair	408-8648	1583255-1
	Housing Removal Tool, Right Angle Header, 4 Pair	Note 1	1804174-1
	Housing Removal Tool, Right Angle Header, 3 Pair	Note 1	1804173-1
	Housing Removal Tool, Right Angle Header, 2 Pair	Note 1	1804171-1
	Chiclet Removal Tool, Right Angle Header, 4 Pair	Note 1	1804177-1
	Chiclet Removal Tool, Right Angle Header, 3 Pair	Note 1	1804176-1
	Chiclet Removal Tool, Right Angle Header, 2 Pair	Note 1	1804175-1
Cable to Board Insertion Tooling	Seating Tool, Vertical Cable Header, 4 Pair	408-8785	91373-1
	Seating Tool, Vertical Cable Header, 2 Pair	408-8785	91372-1
	Seating Tool, Right Angle Cable Header, 4 Pair	Note 1	1804244-1
	Seating Tool, Right Angle Cable Header, 2 Pair	408-8785	1804178-1
Cable to Board Repair Tooling	Housing Removal Tool, Vertical Header, 4 Pair	408-8645	1725635-1
	Housing Removal Tool, Vertical Header, 2 Pair	Note 1	1804170-1
	Housing Removal Tool, Right Angle Header, 4 Pair	Note 1	1804239-1
	Housing Removal Tool, Right Angle Header, 2 Pair	Note 1	1804172-1
	Chiclet Removal Tool, Right Angle Header, 4 Pair	Note 1	1804177-1
Chiclet Removal Tool, Right Angle Header, 2 Pair	Note 1	1804175-1	

Note: 1. Contact Tyco Electronics for Instruction Sheet.

Note: All part numbers are RoHS compliant.

Z-PACK HM-Zd Connector (Continued)

Compatible 2mm HM Products

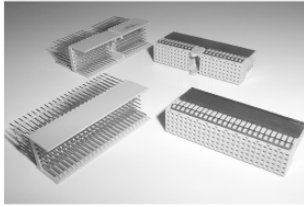

Z-PACK 2mm HM Type A & B Connector Modules

- Offered with five rows of signal contacts and two rows of ground contacts
- Type A offers center guiding and keying facility and 110 signal contacts
- Type B has 125 signal contacts
- Upper ground return shields are pre-fitted to receptacles and used with the 5+2 row male connectors
- Up to three levels of sequenced pins available on vertical pin headers
- Both types are end stackable without change in contact pitch

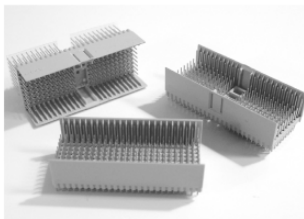

Z-PACK 2mm HM Type D & E Connector Modules

- Offered with 8 rows of signal contacts and two rows of ground contacts
- Type D offers center guiding and keying facility and 176 signal contacts
- Type E has 200 signal contacts
- Upper ground return shields are pre-fitted to receptacles and used with 8+2 row male connectors
- Up to three levels of sequenced pins available on vertical pin headers
- Both types are end stackable without change in contact pitch

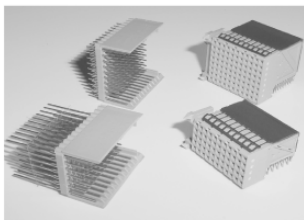

Z-PACK 2mm HM Type F & C Connector Modules

- Half size modules which are intended for use at the end of a column
- Type C has 55 signal pins and guidance features
- Type F has 88 signal pins and guidance features
- Upper ground return shields are pre fitted to receptacles and used with 5+2 and 8+2 row connectors
- Three levels of sequenced pins available on vertical pin headers
- Both types are end stackable without change in contact pitch

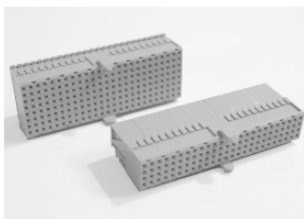

Type AB/ DE Modules

- Offers maximum signal density and alignment features of standard Type A & D modules
- Type AB offers 125 signal contacts and guiding and keying features
- Type DE offers 200 signal contacts and guiding and keying features
- Offers all the advantages of sequenced pins, pre-shielded receptacles and end stackable

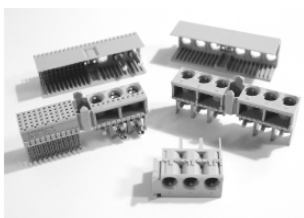

Type L M & N Connectors

- DIN contacts can be fitted to types L, M and N style housings either in power or coax options
- 5 row and 5+2 row connector options
- Type L accommodates up to 6 DIN contacts
- Type M connectors are loaded with 55 signal contacts in row A to E and 3 cavities for DIN style contacts
- Type N accommodates up to 3 DIN contacts

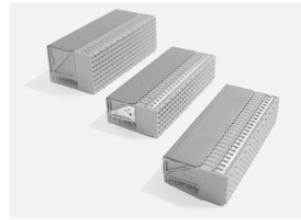

Receptacles with Upper and Lower Ground Return Shields

- Mates with 5+2 and 8+2 row male product to improve signal integrity
- Three levels of performance
 - a) reduced cross talk
 - b) ground return shields
 - c) reduced cross talk and ground return shields

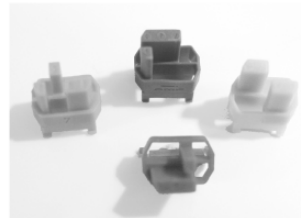

Z-PACK 2mm HM Connector Coding Keys

- Used in Type A, D, L and M male and female connectors
- Polarized features and used in the multi-purpose center of the male and female housings
- Keys are inserted in the mating faces of the housings
- Available in up to 70 different options

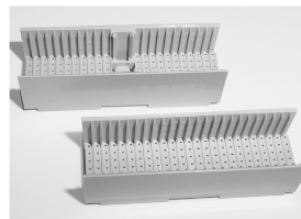

Shrouds

- Offered in type A, B, A/B, C, D, E, D/E, and F
- Product is offered in various standoff heights to accommodate a wide variety of pcb thicknesses

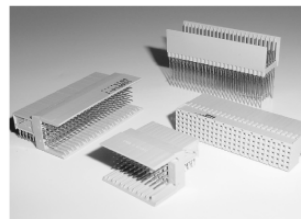

Right Angle Male Offering

- 5 row connector offering Type A, B & C style product mate with respective right angle product for card extender applications
- Type A has 110 signal contacts and center guidance and keying facility
- Type B offered in 25, 22 & 19 column offerings
- Type C has 55 signal contacts and guidance features
- Available in standard and reduced cross talk varieties

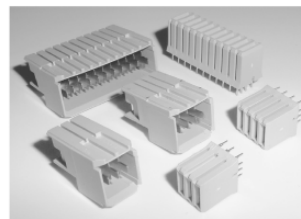

Universal Power Module

- Offered in 3 to 12 position sizes
- Inverse sex configuration offers a vertical receptacle for backplane applications
- Polarized vertical press fit leads
- Up to 15 amperes per contact with a durability rating of 250 mating cycles

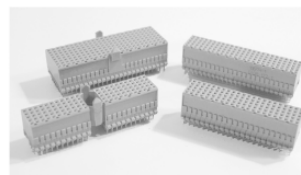

Vertical Receptacles

- 5 & 8 row product offering
- Used with either vertical or right angle males in application
- Type A & D offers center keying and guidance
- Type B & E offers 25 columns of signal contacts
- Type C & F is a half size module with guidance features