

Splash Proof/Sealed Universal MATE-N-LOK Connectors (Continued)

Connector Seals

Product Facts

- Economical splash proof/immersible sealed connector system
- No design changes to existing Universal MATE-N-LOK product
- Existing applications utilizing Universal MATE-N-LOK connectors can be upgraded to a splash proof system
- Utilizes two wire seals and one interface seal
- Wire AWG range is .5 - 2.0 mm [#20 - #14] with insulation diameter range 1.52 - 3.30 mm [.060 - .130 in.]
- 2.79 - 3.30 mm [.110 - .130 in.] insulation diameter passed European IP sealing level #5/7 (swirling dust/immersion to 1 meter for 30 minutes)
- 1.52 - 2.79 mm [.060 - .110 in.] insulation diameter passed European IP sealing level #5/6 (swirling dust/heavy seas)
- Universal MATE-N-LOK II keying plug can be used to seal unused circuits
- Primary application is for wire-to-wire, wire-to-board application must use a closed bottom header

Material:

Silicone rubber, blue color

Technical Documents:

Product Specification

108-031-1 Splash Proof Seal
Universal MATE-N-LOK
Connectors

Contacts—page 54

Instruction Sheet/Application Specification

408-3392 Universal MATE-N-LOK
Splash Proof Seals

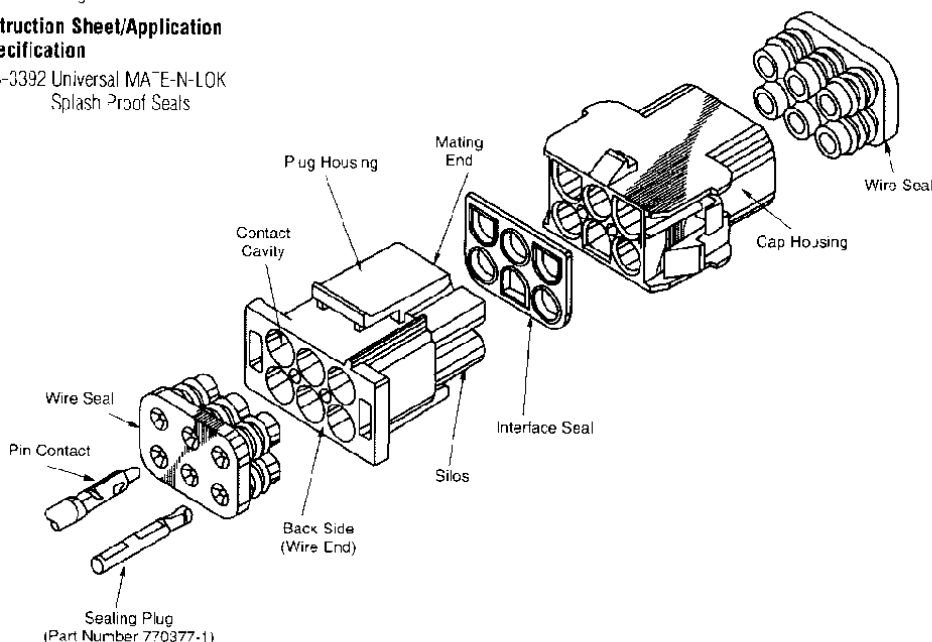

Number of Circuits	A Dim.	Interface Seal Part Numbers	Wire Seal Part Number
2	14.0 [.550]	794269-1	794270-1
3	20.3 [.800]	794271-1	794272-1
4	26.7 [1.050]	794273-1	794274-1
6	—	794275-1	794276-1
9	20.3 [.800]	794277-1	794278-1
12	26.7 [1.050]	794279-1	794280-1
15	26.7 [1.300]	794281-1	794282-1

Note: One interface seal and two wire seals required per mated assembly.

2, 3, 4 Circuit, In-Line

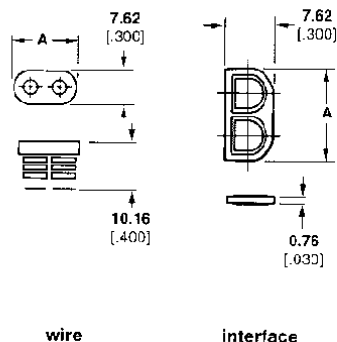

6 Circuit, Matrix

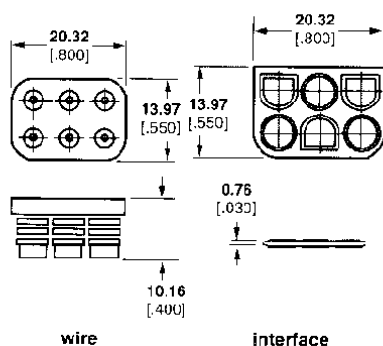

9, 12, and 15 Circuit, Matrix

