

12.5 mm Modular Panel Potentiometers Cermet (P11S) or Conductive Plastic Elements (P11A)



FEATURES

- 12.5 mm square single turn panel control
- Five shaft diameters and 29 terminal styles
- Multiple assemblies - up to seven modules
- Tests according to CECC 41 000
- GAM T1
- P11S version for industrial, military and aeronautics applications
- P11A version for professional audio applications
- Low current compatibility
- Shaft and panel sealed version
- Up to twenty-one indent positions
- Rotary and push/push switch options
- Concentric shafts
- Custom designs on request
- Trimmer version T11 (see document no. 51021)
- Compliant to RoHS directive 2002/95/EC



RoHS
COMPLIANT

VERSATILE	MODULAR	COMPACT	ROBUST
-----------	---------	---------	--------

CONFIGURATION EXAMPLE - Dimensions in mm (Inches)/Tolerance ± 0.5 mm (± 0.02 ")

Single module, single shaft, solder lugs, metric bushing and shaft

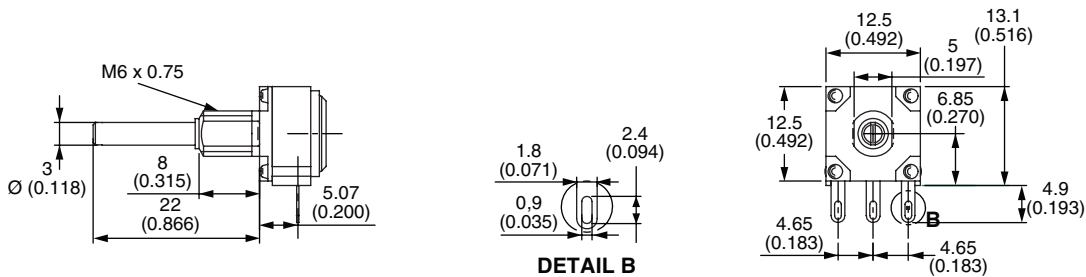

Single module, single shaft, vertical mounting, PC pins with support plate, metric bushing and shaft



Dual modules, single shaft, PC pins with front support plates, imperial bushing and shaft

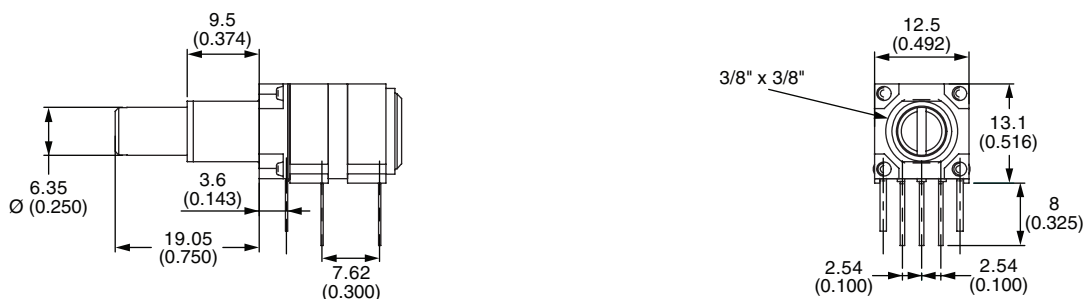



GENERAL SPECIFICATIONS

ELECTRICAL (INITIAL)			
		P11A	P11S
Resistive Element		Conductive plastic	Cermet
Electrical Travel		270° ± 10°	270° ± 10°
Resistance Range (1)	Linear Law	1 kΩ to 1 MΩ	20 Ω to 10 MΩ
	Non Linear Law	470 Ω to 500 kΩ	100 Ω to 2.2 MΩ
Tolerance	Standard	± 20 %	± 20 %
	On request	-	± 5 % or ± 10 %
Power Rating at 70 °C	Linear Law	0.5 W at + 70 °C	1 W at + 70 °C
	Non Linear Law	0.25 W at + 70 °C	0.5 W at + 70 °C
	Multiple Assemblies	0.25 W at + 70 °C per module	0.5 W at + 70 °C per module
Temperature Coefficient (Typical)		± 500 ppm	± 150 ppm
Limiting Element Voltage		350 V	350 V
End Resistance (Typical)		2 Ω	2 Ω
Contact Resistance Variation	Linear Law	1 %	2 % or 3 Ω
Independent Linearity (Typical)	Linear Law	± 5 %	± 5 %
Insulation Resistance		10 ⁶ MΩ min.	10 ⁶ MΩ min.
Dielectric Strength		1500 V _{RMS} min.	1500 V _{RMS} min.
Attenuation		90 dB max./0.05 dB min.	-
Mechanical Rotation Life		50 000 cycles	50 000 cycles

Note

(1) Consult Vishay Sfernice for other ohmic values

MECHANICAL (INITIAL)	
Mechanical Travel	300° ± 5°
Operating Torque (Typical)	0.4 Ncm to 1.8 Ncm max. (0.57 oz.-inch to 2.55 oz.-inch max.) 0.2 Ncm to 0.3 Ncm max. (0.28 oz.-inch to 0.42 oz.-inch max.)
End Stop Torque (All Bushing Except G)	25 Ncm max. (2.1 lb-inch max.) 80 Ncm max. (6.8 lb-inch max.)
End Stop Torque for Bushing G	40 Ncm max. (3.4 lb-inch max.)
Tightening Torque	150 Ncm max. (13 lb-inch max.) 250 Ncm max. (21 lb-inch max.)
Weight	7 g to 9 g per module (0.25 oz. to 0.32 oz.)

ENVIRONMENTAL		
	P11A	P11S
Operating Temperature Range	- 55 °C to + 125 °C	- 55 °C to + 125 °C
Climatic Category	55/125/21	55/125/56
Sealing	IP64	IP64

MARKING
<ul style="list-style-type: none"> • Potentiometer Module VISHAY logo, nominal ohmic value (Ω, kΩ, MΩ), two stars identify P11A version, tolerance in % - variation law, manufacturing date (four digits), "3" for the lead 3
<ul style="list-style-type: none"> • Switch Module Version, manufacturing date (four digits), "c" for common lead
<ul style="list-style-type: none"> • Indent Module Version, manufacturing date (four digits)

PACKAGING
<ul style="list-style-type: none"> • Box

PERFORMANCES				
TESTS	CONDITIONS	TYPICAL VALUE AND DRIFTS		
			P11S	P11A
Load Life	1000 h at + 70 °C (90°/30')	$\Delta R_T/R_T$ contact resistance variation	± 2 % ± 4 %	± 10 % ± 5 %
Temperature Cycle	- 55 °C to + 125 °C, 5 cycles	$\Delta R_T/R_T$	± 0.2 %	± 0.5 %
Moisture	+ 40 °C, 93 % relative humidity P11S: 56 days, P11A: 21 days	$\Delta R_T/R_T$ insulation resistance	± 2 % > 1000 MΩ	± 5 % > 10 MΩ
Rotational Life	P11S/P11A: 50 000 cycles	$\Delta R_T/R_T$ contact resistance variation	± 5 % ± 5 %	± 6 % ± 4 %
Climatic Sequence	Dry heat at + 125 °C/damp heat cold - 55 °C/damp heat 5 cycles	$\Delta R_T/R_T$	± 1 %	-
Shock	50 g, 11 ms 3 shocks - 3 directions	$\Delta R_T/R_T$ resistance setting change	± 0.2 % ± 0.5 %	± 0.2 % ± 0.5 %
Vibration	10 Hz to 55 Hz 0.75 mm or 10 g, 6 h	$\Delta R_T/R_T$ voltage setting change	± 0.2 % ± 0.5 %	± 0.2 % ± 0.5 %

ORDERING INFORMATION (Part Number 18 digits)													
<div style="display: flex; justify-content: space-around; font-weight: bold; font-size: 1.2em;"> P11S2Q0EASY00103MA </div>													
MODEL	STYLE	NUMBER OF MODULES	BUSHING	LOCATING PEG	SHAFT	SHAFT STYLE	LEADS	RESISTANCE CODE/ TOLERANCE/ TAPER OR SPECIAL					
P11	S = CERMET ELEMENT A = CONDUCTIVE PLASTIC (AUDIO)	1 2 3 4 5 6 7											

STANDARD RESISTANCE ELEMENT DATA											
STANDARD RESISTANCE VALUES	P11S CERMET						P11A CONDUCTIVE PLASTIC LINEAR LAW			TYPICAL TCR - 55 °C/+ 125 °C	
	LINEAR LAW			NON LINEAR LAW			MAX. POWER AT 70 °C	MAX. WORKING VOLTAGE	MAX. CUR. THROUGH WIPER	P11S	P11A
	MAX. POWER AT 70 °C	MAX. WORKING VOLTAGE	MAX. CUR. THROUGH WIPER	MAX. POWER AT 70 °C	MAX. WORKING VOLTAGE	MAX. CUR. THROUGH WIPER					
Ω	W	V	mA	W	V	mA	W	V	mA	ppm/°C	
22	1	4.69	213								
47		6.85	146								
50		7.07	141								
100		10	100								
200		14.8	67.4	0.5							
470		21.6	46.1		15.3	32.7					
500		22.4	44.7		15.8	31.6					
1K		31.6	31.6		22.4	22.4	0.5	22.4	22.4		
2.2K		46.9	21.3		33.2	15.1		33.2	15.1		
4.7K		63.5	14.5		48.5	10.3		48.5	10.3		
5K		70.7	14.1		50.0	10.0		50.0	10.0		
10K		100	10		79.7	7.07		79.7	7.07	± 150	± 500
22K		148	6.7		105	4.77		105	4.77		
47K		217	4.6		153	3.26		153	3.26		
50K		224	4.47		158	3.16		158	3.16		
100K	1	316	3.16	0.5	224	2.24	0.5	224	2.24		
220K	0.56	350	1.59	0.26	332	1.51	0.5	332	1.51		
470K	0.26	350	0.75	0.12	350	0.74	0.26	350	0.74		
500K	0.25	350	0.70	0.25	350	0.70	0.25	350	0.70		
1M	0.12	350	0.35		350	0.35					
2.2M	0.05	350	0.16								
4.7M	0.02	350	0.07								

ORDERING INFORMATION (Part Number 18 digits)																																																						
<div style="display: flex; justify-content: space-around; font-weight: bold; font-size: 1.2em;"> P11S2Q0EASY00103MA </div>																																																						
MODEL	STYLE	NUMBER OF MODULES	BUSHING				LOCATING PEG	SHAFT	SHAFT STYLE	LEADS	RESISTANCE CODE/TOLERANCE/TAPER OR SPECIAL																																											
P11			<table border="1"> <thead> <tr> <th></th> <th>Ø</th> <th>L</th> <th>Old Codes</th> </tr> </thead> <tbody> <tr><td>A</td><td>1/4"</td><td>1/4"</td><td>7, 77, 77-3</td></tr> <tr><td>B</td><td>1/4"</td><td>3/8"</td><td>71</td></tr> <tr><td>C</td><td>1/4"</td><td>1/2"</td><td>72</td></tr> <tr><td>D</td><td>1/4"</td><td>3/8"</td><td>71H</td></tr> <tr><td>E</td><td>1/4"</td><td>1/2"</td><td>72H</td></tr> <tr><td>F</td><td>3/8"</td><td>3/8"</td><td>2, 03, 0-</td></tr> <tr><td>G</td><td>8</td><td>8</td><td>TP, QP, VP, 2P, 7P</td></tr> <tr><td>Q</td><td>7</td><td>8</td><td>Q</td></tr> <tr><td>T</td><td>6</td><td>8</td><td>T</td></tr> <tr><td>V</td><td>10</td><td>9.5</td><td>V, CC, CC-3</td></tr> </tbody> </table>		Ø	L	Old Codes	A	1/4"	1/4"	7, 77, 77-3	B	1/4"	3/8"	71	C	1/4"	1/2"	72	D	1/4"	3/8"	71H	E	1/4"	1/2"	72H	F	3/8"	3/8"	2, 03, 0-	G	8	8	TP, QP, VP, 2P, 7P	Q	7	8	Q	T	6	8	T	V	10	9.5	V, CC, CC-3							
	Ø	L	Old Codes																																																			
A	1/4"	1/4"	7, 77, 77-3																																																			
B	1/4"	3/8"	71																																																			
C	1/4"	1/2"	72																																																			
D	1/4"	3/8"	71H																																																			
E	1/4"	1/2"	72H																																																			
F	3/8"	3/8"	2, 03, 0-																																																			
G	8	8	TP, QP, VP, 2P, 7P																																																			
Q	7	8	Q																																																			
T	6	8	T																																																			
V	10	9.5	V, CC, CC-3																																																			

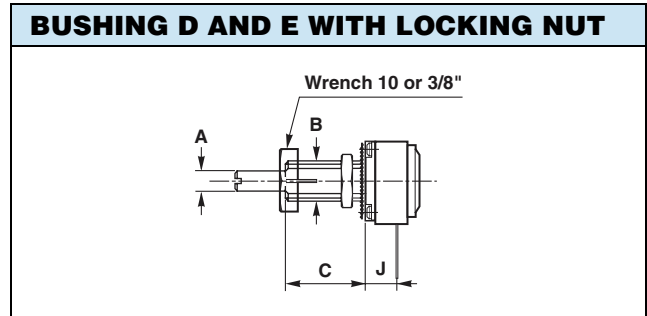
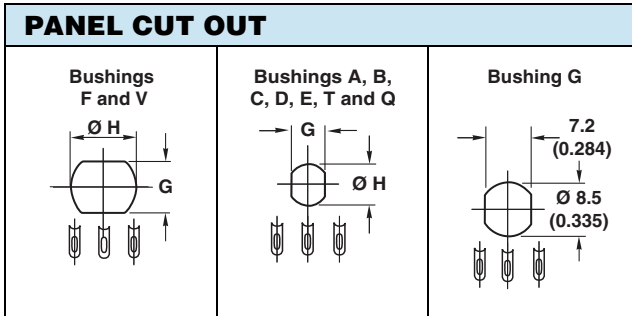
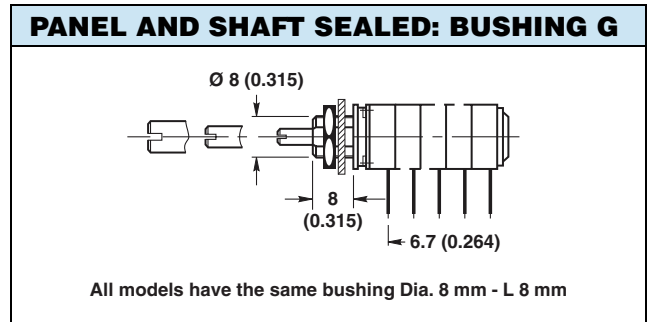

BUSHINGS		DIMENSIONS mm (± 0.5)					DIMENSIONS INCHES (± 0.01)					
		G	T	Q	V	A	B	C	D	E	F	
A	Shafts	Ø	All Dia.	3	4	6	1/8"	1/8"	1/8"	1/8"	1/8"	1/4"
B	Bushing	Ø	8	6	7	10	1/4"	1/4"	1/4"	1/4"	1/4"	3/8"
C		L	8	8	8	9.5	1/4"	3/8"	1/2"	3/8"	1/2"	3/8"
J	Lead Versions X.. Y..		6.7	5	5	7	0.200	0.200	0.200	0.200	0.200	0.278
	K		10.4	9.1	9.1	11.1	0.357	0.357	0.357	0.357	0.357	0.436
G	Panel		7.2	5.2	6.2	8.2	0.197	0.197	0.197	0.197	0.197	0.323
H	Cutout	Ø	8.5	6.5	7.5	10.5	0.268	0.268	0.268	0.268	0.268	0.394
	Thread		0.75				32 threads/inch					
	Wrench Nut		12	8	10	12	0.313	0.313	0.313	0.313	0.313	0.500
	Style									Slotted	Slotted	

- Notes**
- Hardware supplied in separate bags
 - Slotted bushing for locking nut option

ORDERING INFORMATION (Part Number 18 digits)																	
P	1	1	S	2	Q	0	E	A	S	Y	0	0	1	0	3	M	A
MODEL	STYLE	NUMBER OF MODULES	BUSHING	LOCATING PEG	SHAFT			SHAFT STYLE	LEADS	RESISTANCE CODE/TOLERANCE/TAPER OR SPECIAL							
				Old Codes A = B24 B = B30 C = B53 0 = Without peg													

LOCATING PEGS (Anti-Rotation Lug)				
<p>The locating peg is provided by a plate mounted on the bushing and positioned by the module sides. Four set positions are available, clock face orientation: 12, 3, 6, 9.</p> <p>All P11 bushings have a double flat. When panel mounting holes have been punched accordingly, an anti-rotation lug is not necessary.</p>				
CODE	VERSION	BUSHING A, B, C, D, E, T, Q	BUSHING F, V	EFFECTIVE HIGH PEG
A	Ø d mm	2	2	0.7
	L mm	6.2	6.2	
B	Ø d mm	2	2	0.7
	L mm	7.75	7.75	
C	Ø d mm	-	3.5	1.1
	L mm	-	13.5	
<p>Locating pegs are supplied in separate bags with nuts and washers</p>				

ORDERING INFORMATION (Part Number 18 digits)																	
P	1	1	S	2	Q	0	E	A	S	Y	0	0	1	0	3	M	A
MODEL	STYLE	NUMBER OF MODULES	BUSHING	LOCATING PEG	SHAFT			SHAFT STYLE	LEADS	RESISTANCE CODE/TOLERANCE/TAPER OR SPECIAL							
					Ø	L	Old Codes	S = Slotted R = Round F = Flatted K = Knurled/splined D = Custom									
					AA	3	9.5	K									
					AB	3	12.5	M									
					AJ	3	22	R									
					AP = Custom shaft												
					BA	1/8"	3/8"	CK									
					BB	1/8"	1/2"	CM									
					BG	1/8"	5/8"	CDM									
					BG	1/8"	5/8"	CD									
					BH	1/8"	3/4"	CH									
					BJ	1/8"	7/8"	CR									
					CC = Concentric shaft												
					EA	4	9.5	E									
					EB	4	12.5	F									
					EJ	4	22	G									
					FG	6	16	D									
					FH	6	19	I									
					FL	6	25	N									
					FR	6	50	S									
					GG	1/4"	5/8"	VD									
					GH	1/4"	3/4"	VHM, VH									
					GJ	1/4"	7/8"	VR									
					GL	1/4"	1"	VN									
					GO	1/4"	1.5"	VL									

SHAFTS

The shaft length are always measured from the mounting face.
 Standard shafts are designed by a 3 letter code (3 digits). Shafts slots are aligned to $\pm 10^\circ$ of the wiper position.

All standard shafts are slotted except flatted and splined, see exceptions for bushing.

FLATTED SHAFT

BUSHING: F
 SHAFT: GHF

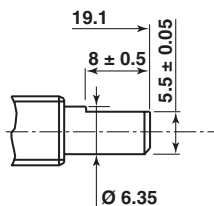

BUSHING: A
 SHAFT: BGF

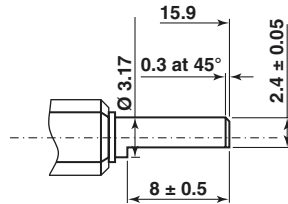

BUSHING: Q
 SPLINED SHAFT: FHK

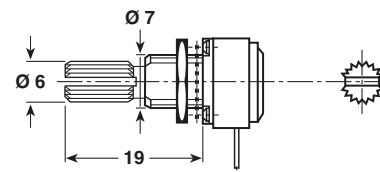
CUSTOM SHAFTS

When special shafts are required - flat, threaded ends, special shaft lengths, etc. a drawing is required.

STANDARD COMBINATION OF SHAFT STYLES AND BUSHINGS

SHAFT DIA.	BUSHING CODE	SHAFT LENGTH AND STYLE AVAILABLE IN STANDARD (Others on request)							
		AAS	ABS	AJS	BGS	BHS	GLS	GOS	GHF
3	T								
3.17	A	BAS	BBS	BGS	BGF	BHS		BJS	
3.17	B	BBS	BGS	BHS	BJS				
3.17	C	BGS	BHS	BJS					
4	Q	EAS	EBS	EJS	FHK				
6	V	FGS	FLS	FRS					
6.35	F	GGs	GHS	GJS	GLS	GOS		GHF	

ORDERING INFORMATION (Part Number 18 digits)																	
P	1	1	S	2	Q	0	E	A	S	Y	0	0	1	0	3	M	A
MODEL	STYLE	NUMBER OF MODULES	BUSHING	LOCATING PEG	SHAFT	SHAFT STYLE	LEADS						RESISTANCE CODE/ TOLERANCE/ TAPER OR SPECIAL				
							Available leads										
							A00	W00	X00	Y00	Z00						
							A10	W10	X03	Y03	Z03						
							A13	W20	X04	Y04	Z04						
							A14		X10		Z10						
							A20		X13		Z13						
							A23		X14		Z14						
							A24		X20		Z20						
									X23		Z23						
									X24		Z24						

FIRST DIGIT		SECOND DIGIT		THIRD DIGIT	
Y	Soldering lugs	0	Y = 4.65 mm (0.183") A, X, Z, W = 5.08 mm (0.200") pin spacing pins section 0.9 x 0.3 mm ² (0.035" x 0.012")	0	5.08 mm (0.200") space between modules
X	PCB pins	1	2.54 mm (0.100") pin spacing pin section 0.6 x 0.3 mm ² (0.024" x 0.012")	3	7.62 mm (0.300") space between modules
Z	PCB pins with front support plate	2	5.08 mm (0.200") pin spacing pins section 0.6 x 0.3 mm ² (0.024" x 0.012")	4	10.16 mm (0.400") space between modules
A	PCB pins with front and back support plates				
W	PCB pins - vertical mounting with 2 extra pins - 1 module only				

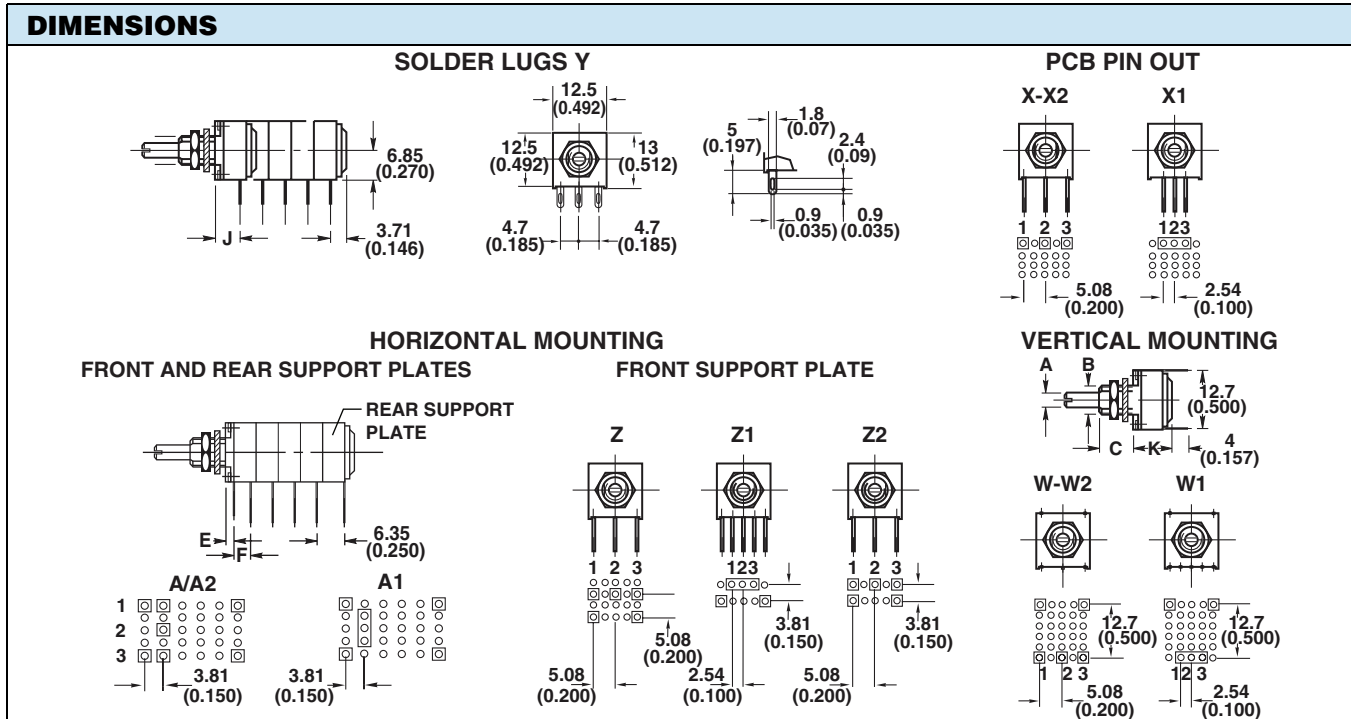

THE POSITION OF EACH MODULE IS FREE

BUSHINGS	G	T	Q	V	A	B	C	D	E	F	
	DIMENSIONS mm (± 0.5)				DIMENSIONS INCHES (± 0.02)						
E Leads Z00	3.15	1.85	1.85	3.85	0.071	0.071	0.071	0.071	0.071	0.150	
E Leads Z1, Z2, A..	2.8	1.6	1.6	3.6	0.063	0.063	0.063	0.063	0.063	0.140	
F	Leads Z0.: 5.08 mm (0.200")				Leads A.. Z1, Z2.: 3.81 mm (0.150")						
J Leads X.. Y..	6.7	5	5	7	0.200	0.200	0.200	0.200	0.200	0.278	
E Leads Z0. with Rotary Switch	1.45	0.15	0.15	2.15	0.006	0.006	0.006	0.006	0.006	0.0846	

ORDERING INFORMATION (Part Number 18 digits)																	
P	1	1	S	2	Q	0	E	A	S	Y	0	0	1	0	3	M	A
MODEL	STYLE	NUMBER OF MODULES	BUSHING	LOCATING PEG	SHAFT	SHAFT STYLE	LEADS	RESISTANCE CODE/ TOLERANCE/ TAPER OR SPECIAL									
								Resistance Code: 200 = 20 Ω to 106 = 10 MΩ Tolerance Code: M = 20 %, K = 10 %, J = 5 % Taper: A, L, W, F, S, R or special code given by Vishay									

RESISTANCE CODE
See Conversion Table for ohmic value

TOLERANCE
Standard: M = ± 20 %
On request: K = ± 10 %, J = ± 5 % (cermet only)



SPECIAL CODES GIVEN BY VISHAY
OPTION AVAILABLE
• Custom shaft
• Custom design on request
• Specific linearity
• Specific interlinearity
• Specific variation law
• Multiple assemblies with various modules

P11 OPTION: ROTARY SWITCH MODULES



- Rotary switches
- Current up to 2 A
- Actuation CW or CCW position

MODULES: RS ON/OFF SWITCH RSI CHANGEOVER SWITCH

The position of each module is free. RS and RSI rotary switches are housed in a standard P11 module size 12.7 mm x 12.7 mm x 5.08 mm (0.5" x 0.5" x 0.2"). They have the same terminal styles as the assembled electrical modules.

An assembly can comprise 1 or more switch modules.

Switch actuation is described as seen from the shaft end.

D: means actuation in maximum CCW position

F: means actuation in maximum CW position

The switch actuation travel is 25° with a total mechanical travel of 300° ± 5° and electrical travel of electrical module is 238° ± 10°.

Leads finish: Gold plated.

RDS SINGLE POLE SWITCH, NORMALLY OPEN

In full CCW position, the contact between 1 and 3 is open. It is made at the beginning of the travel in CW direction.

RSF SINGLE POLE SWITCH, NORMALLY OPEN

In full CW position, the contact between 1 and 3 is open. It is made at the beginning of the travel in CCW direction.

RSID SINGLE POLE CHANGEOVER

In full CCW position, the contact is made between 3 and 2 and open between 3 and 1. Switch actuation (CW direction) reverses these positions.

RSIF SINGLE POLE CHANGEOVER

In full CW position, the contact is made between 1 and 2 and open between 1 and 3. Switch actuation (CCW direction) reverses these positions.

SWITCH SPECIFICATIONS

Switching Power Maximum		62.5 VA v 15 VA =
Switching Current Maximum		0.25 A 250 V v 0.5 A 30 V =
Maximum Current Through Element		2 A
Contact Resistance		30 mΩ
Dielectric Strength	Terminal to Terminal	1000 V _{RMS}
	Terminal to Bushing	2000 V _{RMS}
Maximum Voltage Operation		250 V v 30 V =
Insulation Resistance Between Contacts		10 ⁶ MΩ
Life at P _{max} .		10 000 actuations
Minimal Travel		25°
Operating Temperature		- 40 °C to + 85 °C

ELECTRICAL DIAGRAM

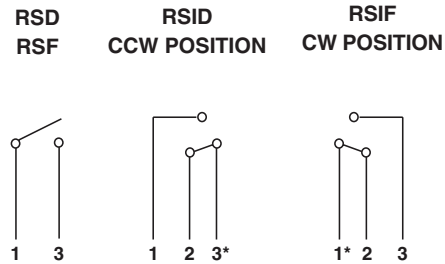

Note
• Common

ORDERING INFORMATION (First order only)

RSID

RSD	SPST: Single pole, open switch in CCW position - 2 pins
RSF	SPST: Single pole, open switch in CW position - 2 pins
RSID	SPDT: Single pole, changeover switch in CCW position - 3 pins
RSIF	SPDT: Single pole, changeover switch in CW position - 3 pins

P11 OPTION: PUSH/PUSH OR MOMENTARY/PUSH SWITCH MODULES

- Push/push or momentary push
- Current up to 2 A

**MODULES: PUSH/PUSH SWITCH RSPP
 MOMENTARY/PUSH SWITCH RSMP**

They have to be the last element of potentiometer

Options:

2 reversing switches F2 4 reversing switches F4

6 reversing switches F6 8 reversing switches F8

Not available with panel sealed option.

Number of modules before the switch limited to 3 modules.

Length of shaft (FMF) 25 mm maximum.

RSPP F2: PUSH/PUSH SWITCH WITH TWO REVERSING SWITCHES

Idle position: The contact is made between 1 and 2 and a and b. It is open between 2 and 3 and b and c.

Pushed position: The contact is made between 2 and 3 and b and c. It is open between 1 and 2 and a and b.

SWITCH SPECIFICATIONS

Switching Power Maximum		50 VA v
Switching Current Maximum		0.5 A v
Maximum Current Through Element		2 A
Contact Resistance		100 mΩ
Dielectric Strength	Terminal to Terminal	1500 V _{RMS}
	Terminal to Bushing	2000 V _{RMS}
Maximum Voltage Operation		250 V v
Insulation Resistance Between Contacts		10 ³ MΩ
Life at P _{max} .		100 000 actuations
Minimal Travel		3.3 mm to 4.7 mm
Operating Temperature		- 40 °C to + 70 °C

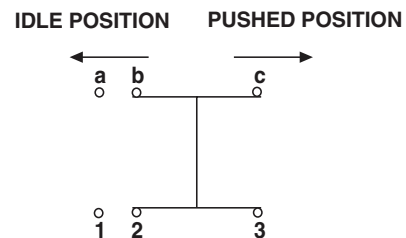
ELECTRICAL DIAGRAM
RSPP F2

ORDERING INFORMATION (First order only for special code creation)

RSPP
RSPP: Push/push

RSMP: Momentary/push

F2
F2: 2 reversing switches (standard version)

F4: 4 reversing switches

F6: 6 reversing switches

F8: 8 reversing switches

P11 OPTION: CONCENTRIC SHAFTS

The CC concentric shaft versions allies the total flexibility of the P11 modular system to the advantage of having two separate shafts.

The outer 6 mm or 1/4" or 1/8" dia. shaft drives the modules situated immediately behind the panel, before the spacer module.

The inner 3 mm or 1/8" or 0.07" dia. shaft drives the modules situated after the spacer module.

Spacer is available with a choice of two spacer thickness:
5.08 mm designations or 2.54 mm designation. See dimensional drawing

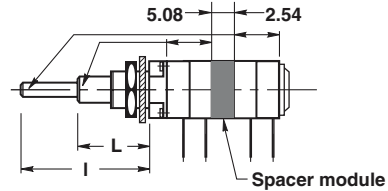

BUSHING CODE	OUTER SHAFT DIAMETER			INNER SHAFT DIAMETER		
	DIAMETER	LENGTH L	SHAFT STYLE	DIAMETER	LENGTH I	SHAFT STYLE
V	6	16	R	3	28.5	R
F	6.35 (1/4")	16	R	3.17 (1/8")	28.5	R
A	3.17 (1/8")	12.7 (1/2")	R	1.8 (0.07")	22.2 (7/8")	R

ORDERING INFORMATION (First order only for special code creation)

5.08

2.54: Mechanical spacer of 2.54 mm
5.08: Mechanical spacer of 5.08 mm

Customer should define witch modules is driven by each shaft (see example of ordering information at the end of the data sheet)

P11 OPTION: DETENT MODULES

The valley detents mechanism is housed in a standard P11 module. Up to 21 detents position available.

Count detents as follows: 1 for CCW position, 1 for full CW position, plus the other positions forming equal resistance increments (linear taper) - not equal angles.

Available now: CVID - CVIF - CVIM
CV3 - CV11 - CV21

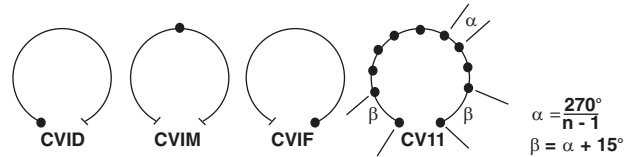

Rotational life: 10 000 cycles

ORDERING INFORMATION (First order only for special code creation)

CV1M

- CV1M** 1 detent at half travel
- CV1M J84** CV1M with accuracy of center point ± 2 % (all laws except S)
- CV1D** 1 detent at CCW position
- CV1F** 1 detent at CW position
- CV3** 3 detents
- CV11** 11 detents
- CV21** 21 detents

P11 OPTION: NEUTRAL MODULES "EN"

Neutral or screen module is housed in a standard P11 module. It is used as a screen between two electrical modules.

The leads can be connected to ground.

ORDERING INFORMATION (First order only for special code creation)

EN

EN Neutral module

P11 OPTION: CENTER CURRENT TAP "J"

The extra terminal is a solder lug connected at 50 % of electrical travel and situated in the potentiometer module opposite the terminals.

Center tap presents a short circuit of 11° of travel.

ORDERING INFORMATION (First order only)

J

J Center tap

P11 OPTION: SPECIAL LINEARITY - CONFORMITY

The independent linearity (conformity for the non linear laws) is the maximum gap ΔV between the actual variation curve and the theoretical variation curve the nearest to it. The linearity and the conformity are expressed in percentage of the total applied voltage E

$$\text{linearity conformity} = \frac{\pm \Delta V_{\max}}{E}$$

They are measured over 90 % of actual electrical travel (centered).
 On request linearity can be guaranteed in linear law.

ORDERING INFORMATION (First order only)

J123

J123 Independent linearity $\pm 3\%$ (linear law)
J145 Independent linearity $\pm 2\%$ (linear law)

For other request, contact us.

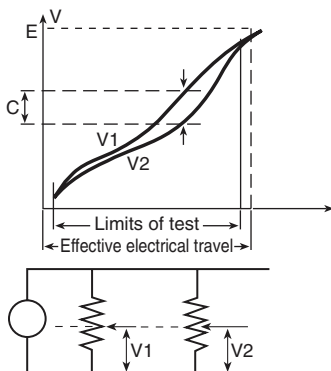
P11 OPTION: SPECIAL INTERLINEARITY - INTERCONFORMITY

It is the maximum deviation between the actual voltage outputs of 2 or more pot modules in the same assembly. It is expressed as a percentage of the total applied voltage, or in dB attenuation.

Interlinearity is measured between 2 pot modules, over 10 to 90 % of the attenuation.

The interlinearity or interconformity is expressed as a percentage of the total applied voltage:

$$I\% = \frac{|C|}{E}$$

Or in decibels by comparison between outputs V1 and V2

$$I \text{ dB} = 20 \log \frac{V_1}{V_2}$$

ORDERING INFORMATION (First order only)

J44

J44 Interlinearity $\pm 2\%$ (linear law)

For other request, contact us.

EXAMPLES OF FIRST ORDER INFORMATION

FIRST EXAMPLE: Triple module (switch is counted as a module)

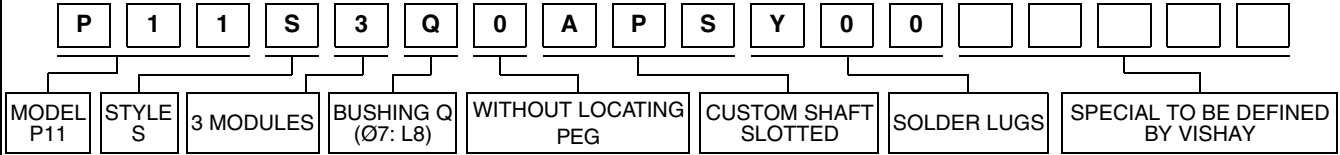

ORDERING INFORMATION:

PART NUMBER	P11S3Q0APSY00.....	
SHAFT AND BUSHING	See drawing of special shaft attached	
MODULE NO. 1	RSID	
MODULE NO. 2	103 M A	J123
MODULE NO. 3	503 M A	J

SECOND EXAMPLE: Concentric shaft with 2 modules on each shaft

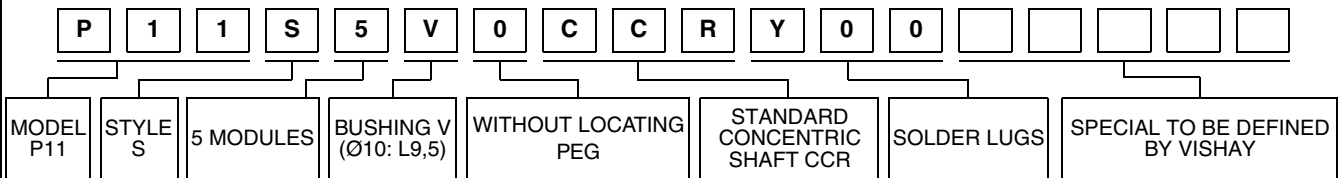

ORDERING INFORMATION:

PART NUMBER	P11S5V0CCRY00.....		
SHAFT AND BUSHING			
MODULE NO. 1	CV1M		Driven by outer shaft
MODULE NO. 2	502 K A		Driven by outer shaft
MODULE NO. 3	5.08		Mechanical spacer 5,08 mm
MODULE NO. 4	103 K A	J44	Driven by inner shaft
MODULE NO. 5	103 K A	J44	Driven by inner shaft

PART NUMBER DESCRIPTION (used on some Vishay document or label, for information only)

P11S	2	Q	0	EA	S	Y00	10K	20%	A				e3
MODEL	MODULES	BUSHING	LOCATING PEG	SHAFT	SHAFT STYLE	LEADS	VALUE	TOL.	TAPER	SPECIAL	SPECIAL	LEAD (Pb)- FREE	



Disclaimer

All product specifications and data are subject to change without notice.

Vishay Intertechnology, Inc., its affiliates, agents, and employees, and all persons acting on its or their behalf (collectively, "Vishay"), disclaim any and all liability for any errors, inaccuracies or incompleteness contained herein or in any other disclosure relating to any product.

Vishay disclaims any and all liability arising out of the use or application of any product described herein or of any information provided herein to the maximum extent permitted by law. The product specifications do not expand or otherwise modify Vishay's terms and conditions of purchase, including but not limited to the warranty expressed therein, which apply to these products.

No license, express or implied, by estoppel or otherwise, to any intellectual property rights is granted by this document or by any conduct of Vishay.

The products shown herein are not designed for use in medical, life-saving, or life-sustaining applications unless otherwise expressly indicated. Customers using or selling Vishay products not expressly indicated for use in such applications do so entirely at their own risk and agree to fully indemnify Vishay for any damages arising or resulting from such use or sale. Please contact authorized Vishay personnel to obtain written terms and conditions regarding products designed for such applications.

Product names and markings noted herein may be trademarks of their respective owners.