



Features

- Available in a variety of pin-out configurations
- Virtually infinite electrical circuit isolation
- Model 96 sealed for board wash
- Metal or plastic shaft options



91, 92, 93, 94, 95, 96 - 5/8" Square Single-Turn Panel Control
97, 99 - 5/8" Square Single-Turn Panel Control with Rotary Switch

Potentiometer Specifications

| Initial Electrical Characteristics ¹ | Conductive Plastic Element | Cermet Element |
|-----------------------------------------------------------------------------------|----------------------------------------|---------------------------------------|
| Standard Resistance Range | | |
| Linear Tapers (A, B, E, & H)..... | (B & E) 1 K ohms to 1 megohm..... | (A & H) 100 ohms to 1 megohm |
| Audio Tapers (C, D, F, G, S, & T) | (D,G,S, & T) 1 K ohms to 1 megohm..... | (C & F) 1 K ohms to 1 megohm |
| Total Resistance Tolerance..... | 10 % or 20 % | 5% or 10% |
| Independent Linearity..... | ±5 % | ±5 % |
| Absolute Minimum Resistance..... | 2 ohms maximum..... | 2 ohms maximum |
| Effective Electrical Angle..... | (Linear tapers) 240 ° ± 5 ° | (Linear tapers) 240 ° ± 6 ° |
| | (Audio tapers) 225 ° ± 5 ° | (Audio tapers) 225 ° ± 6 ° |
| Contact Resistance Variation | ±1 % | ±1 % or 3 ohms (whichever is greater) |
| Dielectric Withstanding Voltage (MIL-STD-202, Method 301) | | |
| Sea Level | 1,500 VAC minimum..... | 1,500 VAC minimum |
| 70,000 Feet..... | 500 VAC minimum..... | 500 VAC minimum |
| Insulation Resistance (500 VDC) | 1,000 megohms minimum..... | 1,000 megohms minimum |
| Power Rating (Voltage Limited By Power Dissipation or 350 VAC, Whichever Is Less) | | |
| +70 °C Single Section Assembly | (Linear tapers) 0.5 watt..... | (Linear tapers) 2 watts |
| | (Audio tapers) 0.25 watt | (Audio tapers) 1 watt |
| +70 °C Multiple Section Assembly | (Linear tapers) 0.5 watt/section..... | (Linear tapers) 1 watt/section |
| | (Audio tapers) 0.25 watt/section | (Audio tapers) 0.5 watt/section |
| +125 °C..... | 0 watt..... | 0 watt |
| Theoretical Resolution..... | Essentially infinite..... | Essentially infinite |

Environmental Characteristics¹

| | | |
|------------------------------------------------------------|------------------------------------------------|-------------------------------|
| Operating Temperature Range | -40 °C to +125 °C | -40 °C to +125 °C |
| Storage Temperature Range..... | -55 °C to +125 °C | -55 °C to +125 °C |
| Temperature Coefficient Over Storage | | |
| Temperature Range..... | ±1,000 ppm/°C..... | ±150 ppm/°C |
| Vibration (Single Section)..... | 15 G..... | 15 G |
| Total Resistance Shift..... | ±2 % maximum..... | ±2 % maximum |
| Voltage Ratio Shift..... | ±5 % maximum..... | ±5 % maximum |
| Shock (Single Section)..... | 30 G..... | 30 G |
| Total Resistance Shift..... | ±2 % maximum..... | ±2 % maximum |
| Voltage Ratio Shift..... | ±5 % maximum..... | ±5 % maximum |
| Load Life | 1,000 hours | 1,000 hours |
| Total Resistance Shift..... | ±10 % maximum..... | ±5 % maximum |
| Rotational Life (No Load) | 100,000 cycles | 100,000 cycles |
| Total Resistance Shift..... | (Linear tapers) 10 ohms or ±15 % TRS max. | (All tapers) ±5 % TRS max. |
| | (whichever is greater) | |
| | (Audio tapers) ±20 % maximum | |
| Contact Resistance Variation | | |
| @ 50,000 cycles | (Linear tapers) ±2 % | ±2 % |
| | (Audio tapers) ±3 % | ±3 % |
| Moisture Resistance (MIL-STD-202, Method 103, Condition B) | | |
| Total Resistance Shift..... | (Linear tapers) ±10 % TRS maximum | (All tapers) ±5 % TRS maximum |
| | (Audio tapers) ±20 % TRS maximum | |
| Insulation Resistance (500 VDC)..... | 100 megohms minimum | 100 megohms minimum |
| IP Rating (Model 96) | IP 65 | IP 65 |
| (All Others)..... | IP 40 | IP 40 |

*RoHS Directive 2002/95/EC Jan 27 2003 including Annex Specifications are subject to change without notice.

Customers should verify actual device performance in their specific applications.

Additional Features

- DPST and DPDT switch options
- RoHS compliant versions available*

91, 92, 93, 94, 95, 96 - 5/8" Square Single-Turn Panel Control
97, 99 - 5/8" Square Single-Turn Panel Control with Rotary Switch

BOURNS®

Potentiometer Specifications

Mechanical Characteristics¹

| | |
|---------------------------------------------------------------------------------------------------|----------------------------------------------------------------------------------------------------------------|
| Stop Strength (1/4" D shaft) | 45.19 N-cm (4 lb.-in.) |
| (1/8" D shaft) | 33.89 N-cm (3 lb.-in.) |
| Mechanical Angle..... | 300 ° ±5 ° |
| Torque | |
| Starting | 0.3 max. above average running torque |
| Running Torque | |
| Single or Dual Section (A, D & R Bushings)..... | 0.21 to 1.06 N-cm (0.3 to 1.5 oz.-in.) |
| Single or Dual Section (C & U Bushings)..... | 0.14 to 1.06 N-cm (0.2 to 1.5 oz.-in.) |
| Mounting | (Metal Bushing) 1.7-2.0 N-m (15-18 lb.-in.) maximum |
| Plastic Bushing) 56-79 N-cm (5-7 lb.-in.) maximum | |
| Variation..... | 0.35 N-cm (0.5 oz.-in.) maximum in 45 ° shaft travel |
| Weight (Single Section, Plastic Bushing)..... | 7.3 grams nominal |
| Weight (Single Section, Metal Bushing)..... | 12.7 grams nominal |
| (Each Additional Section) | 4 grams nominal |
| Terminals | Printed circuit terminals, J-Hooks or solder lugs |
| Soldering Condition | Recommended hand soldering using Sn95/Ag5 no clean solder, 0.025" wire diameter. |
| Maximum temperature 399 °C (750 °F) for 3 seconds. No wash process to be used with no clean flux. | |
| Marking | Manufacturer's trademark, date code, resistance, manufacturer's part number |
| Gangung (Multiple Section Potentiometers)..... | 2 cups maximum |
| Hardware..... | One lockwasher and one mounting nut is shipped with each potentiometer, except where noted in the part number. |

NOTE: All Model 90 performance specifications do not apply to units subjected to printed circuit board cleaning procedures, except for the sealed version (Model 96).

¹At room ambient: +25 °C nominal and 50 % relative humidity nominal, except as noted.

**91, 92, 93, 94, 95, 96 - 5/8" Square Single-Turn Panel Control
97, 99 - 5/8" Square Single-Turn Panel Control with Rotary Switch**

BOURNS®

Rotary Switch Specifications

Initial Electrical Characteristics¹

| | |
|-----------------------------------------------------------|----------------------------------------------------------------------|
| Contacts: | |
| DPST | N.O./N.O., N.C./N.C. or N.O./N.C. |
| DPDT | 2 N.O./N.C. (break before make) |
| Power Rating (Resistive Load): | |
| DPST | 2 A @ 125 volts RMS-60 Hz or 2 A @ 28 VDC, 1 A @ 250 volts RMS-60 Hz |
| DPDT | 1 A @ 125 volts RMS-60 Hz or 1 A @ 28 VDC |
| Contact Resistance (0.1 VDC-10 mA) | 10 milliohms nominal |
| Contact Bounce | 5 milliseconds maximum |
| Dielectric Withstanding Voltage (MIL-STD-202, Method 301) | |
| Sea Level | 1500 VAC minimum |
| Insulation Resistance | 1000 megohms minimum |

Environmental Characteristics¹

| | |
|--------------------------------------------------------------------------|----------------------------------------------------------|
| Operating Temperature Range | 0 °C to +70 °C |
| Exposure Temperature Range | -65 °C to +125 °C |
| Vibration (Dual Section)..... | 8 G |
| Contact Resistance..... | 10 milliohms maximum |
| Contact Bounce | 0.1 millisecond maximum |
| Shock (Dual Section)..... | 20 G |
| Contact Resistance..... | 10 milliohms maximum |
| Contact Bounce | 0.1 millisecond maximum |
| Rotational Life..... | 25,000 cycles |
| Switch Actuating Torque (50% Duty cycle @ Rated Power Load)..... | 1.41 to 4.94 N-cm (2 to 7 oz.-in.) |
| Contact Resistance..... | 100 milliohms maximum |
| Moisture Resistance (MIL-STD-202, Method 106, Condition B) | |
| Contact Resistance (0.1 VDC-10 mA) | 10 milliohms maximum |
| Insulation Resistance (After 24 Hours @ Room Temperature) (500 VDC)..... | 100 megohms minimum |
| Housing Material | High temperature, flame retardant, thermosetting plastic |

Mechanical Characteristics¹

| | |
|-------------------------------------------------------------------|--------------------------------------|
| Actuating Torque (Each Section, Switch Module Only)..... | 3.53 to 10.59 N-cm (5 to 15 oz.-in.) |
| Running Torque (Out of Detent, 2-4 Module Assembly) | 0.21 to 1.41 N-cm (0.3 to 2 oz.-in.) |
| Detent..... | CW or CCW standard |
| Actuation Angle..... | 20° ±5° |
| Contact Materials..... | Fine silver with gold overlay |
| Terminal Styles | Solder lug only |
| Standard Orientation..... | In-line with control terminals |
| Optional | Rotated 90° CCW from standard |
| Terminal Strength (Before and After Soldering Heat Exposure)..... | 0.9 kg (2 lbs.) minimum |

NOTE: Model 99 performance specifications do not apply to units subjected to printed circuit board cleaning procedures.

¹At room ambient: +25 °C nominal and 50 % relative humidity nominal, except as noted.

91, 92, 93, 94, 95, 96, 97, 99 - 5/8" Square Single-Turn

BOURNS®

Product Dimensions

Model 91 & 96 PC Pin Terminals, In-Line



Model 93 PC Pin Terminals, "L" Pattern



Model 95 Solder Lug Terminals, "Triangular" Pattern



TOLERANCES EXCEPT AS SHOWN: DECIMAL .XXX ± $\frac{.128}{.015}$ FRACTION ± 1/64
 .XX ± $\frac{.005}{.38}$ ANGLE ± 5°

DIMENSIONS: $\frac{\text{MM}}{\text{(INCHES)}}$

Model 92 J-Hooked Terminals, In-Line



Model 94 J-Hooked Terminals, "L" Pattern

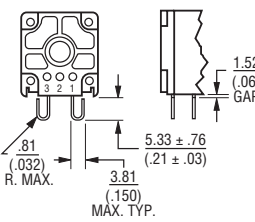

Bushing Styles

- 3/8 THREADLESS (9.53 mm) (STYLE 'D')
- 3/8-32 UNEF (9.53 mm) (STYLE 'A')
- 1/4-32 UNEF (6.35 mm) (STYLE 'C')
- M10 X 0.75-6g (STYLE 'R')
- M7 X 0.75-6g (STYLE 'U')

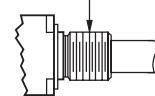

Model 97 1st Cup Same As Model 93 (2nd Cup - Switch)

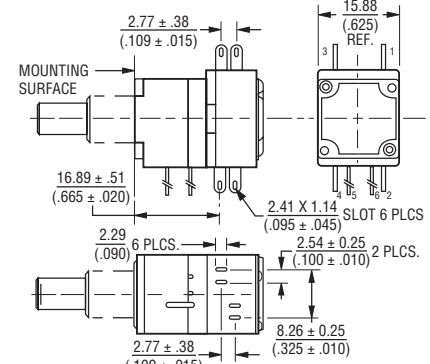

Model 99 1st Cup Same As Model 95 (2nd Cup - Switch)



Switch Module Variations Shaft Flat Orientation



Specifications are subject to change without notice.
 Customers should verify actual device performance in their specific applications.

91, 92, 93, 94, 95, 96, 97, 99 - 5/8" Square Single-Turn

BOURNS®

Product Dimensions

Plastic Shaft Styles

SHAFT TYPE "B" (USES BUSHING A OR D)

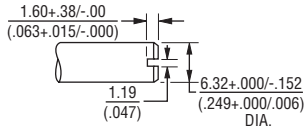

STD. LENGTHS:

| | | | |
|-----------------|-----------------|-----------------|-----------------|
| 12.70 (.500) | 15.88 (.625) | 19.05 (.750) | 22.23 (.875) |
|-----------------|-----------------|-----------------|-----------------|

SHAFT TYPE "D" (USES BUSHING C)

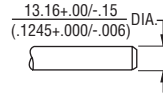

STD. LENGTHS:

| | | |
|-----------------|-----------------|-----------------|
| 12.70 (.500) | 15.88 (.625) | 19.05 (.750) |
|-----------------|-----------------|-----------------|

SHAFT TYPE "T" (USES BUSHING U)

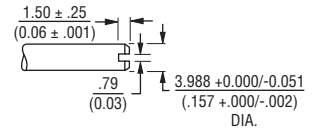

STD. LENGTHS:

| | | |
|-----------------|-----------------|-----------------|
| 12.00 (.472) | 16.00 (.630) | 22.00 (.866) |
|-----------------|-----------------|-----------------|

SHAFT TYPE "C" (USES BUSHING A OR D)

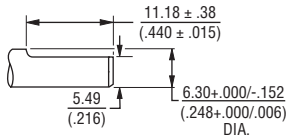

STD. LENGTHS:

| |
|-----------------|
| 22.23 (.875) |
|-----------------|

SHAFT TYPE "R" (USES BUSHING R)

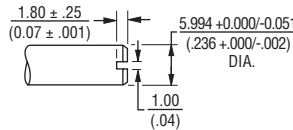

STD. LENGTHS:

| | | |
|----------------|----------------|----------------|
| 16.0 (.630) | 19.0 (.748) | 22.0 (.866) |
|----------------|----------------|----------------|

SHAFT TYPE "W" (USES BUSHING A OR D)

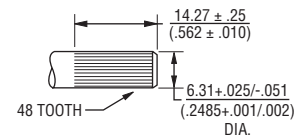

STD. LENGTHS:

| |
|-----------------|
| 25.40 (1.00) |
|-----------------|

Metal Shaft Styles

SHAFT TYPE "A" (USES BUSHING A)

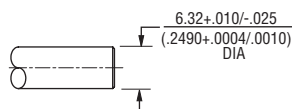

STD. LENGTHS:

| | | | | |
|-----------------|-----------------|-----------------|-----------------|-----------------|
| 12.70 (.500) | 15.88 (.625) | 19.05 (.750) | 22.23 (.875) | 25.4 (1.000) |
|-----------------|-----------------|-----------------|-----------------|-----------------|

SHAFT TYPE "H" (USES BUSHING A)

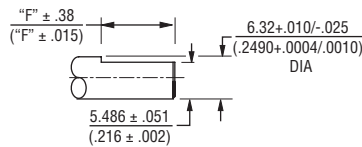

STD. LENGTHS:

| | | | | |
|-----------------|-----------------|-----------------|-----------------|-----------------|
| 12.70 (.500) | 15.88 (.625) | 19.05 (.750) | 22.23 (.875) | 25.4 (1.000) |
|-----------------|-----------------|-----------------|-----------------|-----------------|

FLAT LENGTH "F":

| | | | | |
|----------------|----------------|----------------|-----------------|-----------------|
| 1.60 (.063) | 4.78 (.188) | 7.95 (.313) | 11.13 (.438) | 14.30 (.563) |
|----------------|----------------|----------------|-----------------|-----------------|

SHAFT TYPE "V" (USES BUSHING U)

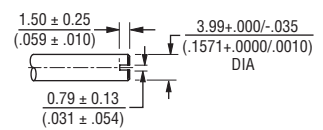

STD. LENGTHS:

| | | | |
|----------------|----------------|----------------|----------------|
| 12.0 (.472) | 16.0 (.630) | 19.0 (.748) | 22.0 (.866) |
|----------------|----------------|----------------|----------------|

SHAFT TYPE "G" (USES BUSHING A)

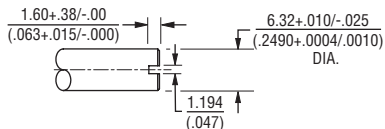

STD. LENGTHS:

| | | | | |
|-----------------|-----------------|-----------------|-----------------|-----------------|
| 12.70 (.500) | 15.88 (.625) | 19.05 (.750) | 22.23 (.875) | 25.4 (1.000) |
|-----------------|-----------------|-----------------|-----------------|-----------------|

SHAFT TYPE "J" (USES BUSHING R)

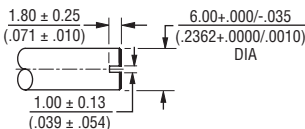

STD. LENGTHS:

| | | | |
|----------------|----------------|----------------|----------------|
| 12.0 (.472) | 16.0 (.630) | 19.0 (.748) | 22.0 (.866) |
|----------------|----------------|----------------|----------------|

SHAFT TYPE "Y" (USES BUSHING A)

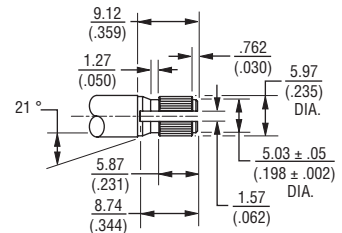

STD. LENGTHS:

| |
|-----------------|
| 19.05 (.750) |
|-----------------|

DIMENSIONS: $\frac{\text{MM}}{\text{(INCHES)}}$

TOLERANCES EXCEPT AS SHOWN: XX = ± .02
(.050)
XXX = ± .005
(.127)
XXXX = ± .0005
(.0127)

Specifications are subject to change without notice.
Customers should verify actual device performance in their specific applications.

How to Order 90 Series Panel Controls

BOURNS®

| | | | | | | | | | |
|----|---|---|---|---|---|----|---|---|----|
| 91 | A | 2 | A | - | A | 28 | - | A | 15 |
| 99 | A | 2 | A | - | B | 28 | - | A | 15 |

| | |
|-----|---|
| A15 | L |
| R51 | L |

Models 91 - 96: Part number for multiple section potentiometers must have a taper and resistance value for each section.

Models 97 & 99: Part number must contain a switch type.

| ANTI-ROTATION LUG | |
|-------------------|----------------------------------|
| A | Single .305" (7.8 mm) R, 90 °CW |
| C | Single .305" (7.8 mm) R, 270 °CW |
| D | No Lug |

| SHAFT LENGTH (FMS) | | AVAILABLE ONLY IN BUSHING |
|--------------------|-------------|---------------------------|
| Code | Description | Code |
| 16 | 1/2" L | A, C, D |
| 20 | 5/8" L | A, C, D |
| 24 | 3/4" L | A, C, D |
| 28 | 7/8" L | A, D |
| 32 | 1" L | A, D |
| METRIC | | |
| 12 | 12 mm L | U |
| 16 | 16 mm L | R, U |
| 19 | 19 mm L | R |
| 22 | 22 mm L | R, U |

| RoHS IDENTIFIER | |
|-----------------|---------------|
| L | Compliant |
| Blank | Non-Compliant |

| # SECTIONS | APPLICABLE MODELS |
|------------|------------------------------------------------------|
| 1 | Single Models 91 Thru 96 Only |
| 2 | Dual All Models, 2nd Section is a Switch in Model 99 |

| BUSHING | |
|---------|--------------------------------------------------------|
| A | Metal Plain 3/8" (9.53 mm) D x 3/8" (9.53 mm) L |
| C | Metal Plain 1/4" (6.35 mm) D x 1/4" (6.35 mm) L |
| D | Plastic Unthreaded 3/8" (9.53 mm) D x 3/8" (9.53 mm) L |
| R | Metal Plain 10 mm D x 9 mm L |
| U | Metal Plain 7 mm D x 9 mm L |

| SWITCH TYPE (MODELS 97 & 99 ONLY) | |
|-----------------------------------|-----------------------------------------------|
| (R50) | DPST N.O./N.C. CW Detent In-Line Term |
| (R51) | DPST N.O./N.C. CCW Detent In-Line Term |
| (R52) | DPST N.O./N.O. CW Detent In-Line Term |
| (R53) | DPST N.O./N.O. CCW Detent In-Line Term |
| (R54) | DPST N.C./N.C. CW Detent In-Line Term |
| (R55) | DPST N.C./N.C. CCW Detent In-Line Term |
| (R56) | DPST N.O./N.C. CW Detent Horz Term |
| (R57) | DPST N.O./N.C. CCW Detent Horz Term |
| (R58) | DPST N.O./N.O. CW Detent Horz Term |
| (R59) | DPST N.O./N.O. CCW Detent Horz Term |
| (R60) | DPST N.C./N.C. CW Detent Horz Term |
| (R61) | DPST N.C./N.C. CCW Detent Horz Term |
| (R70) | DPDT CW Detent In-Line Term |
| (R71) | DPDT CCW Detent In-Line Term |
| (R72) | DPDT CW Detent Horz Term |
| (R73) | DPDT CCW Detent Horz Term |

| MODEL | |
|-------|----------------------------------------------------|
| 91 | Single-Turn, In-Line PC Pins |
| 92 | Single-Turn, In-Line J-Hooks |
| 93 | Single-Turn, L-Pattern PC Pins |
| 94 | Single-Turn, L-Pattern J-Hooks |
| 95 | Single-Turn, Triangle-Pattern Solder Lugs |
| 96 | Single-Turn, In-Line PC Pins, Sealed* |
| 97 | Single-Turn, L-Pattern PC Pins w/Switch |
| 99 | Single-Turn, Triangle-Pattern Solder Lugs w/Switch |

*Model 96 is not available in multi-gang versions.

| SHAFT TYPE | | AVAILABLE ONLY IN | |
|------------|-----------------------------------------|--------------------|-----------------|
| | | LENGTHS (CODE) | BUSHINGS (CODE) |
| B | Plastic Single Slotted 1/4" (6.35 mm) D | 16,20,24,28 | A,D |
| C | Plastic Single Flatted 1/4" (6.35 mm) D | 24,28 | A,D |
| D | Plastic Single Plain 1/8" (3.18 mm) D | 16,20,24 | C |
| R | Plastic Single Slotted 6 mm D | Metric 16,19,22 | R |
| T | Plastic Single Slotted 4 mm D | Metric 16,19,22 | U |
| W | Plastic Single Knurled 1/4" (6.35 mm) D | 32 | A,D |
| A | Metal Single Plain 1/4" (6.35 mm) D | 16,20,24,28,32 | A |
| G | Metal Single Slotted 1/4" (6.35 mm) D | 16,20,24,28,32 | A |
| H | Metal Single Flatted 1/4" (6.35 mm) D | 16,20,24,28,32 | A |
| J | Metal Single Slotted 6 mm D | Metric 12,16,19,22 | R |
| V | Metal Single Slotted 4 mm D | Metric 12,16,19,22 | U |
| Y | Metal Single Knurled 1/4" (6.35 mm) D | 24 | A |

| ELEMENT TAPER TYPE/TOLERANCE | | RESISTANCE CODE VALUE IN OHMS | |
|------------------------------|------------------------|-------------------------------|---------------------|
| (A) | Linear Cermet ±10 % | (05) - 100 | (30) - 15 K |
| (H) | Linear Cermet ±5 % | (28) - 150 | (16) - 20 K |
| | | (06) - 200 | (17) - 25 K |
| | | (07) - 250 | (18) - 50 K |
| | | (08) - 500 | (19) - 75 K |
| | | (09) - 750 | (20) - 100 K |
| | | (10) - 1 K | (31) - 150 K |
| | | (29) - 1.5 K | (21) - 200 K |
| | | (11) - 2 K | (22) - 250 K |
| | | (12) - 2.5 K | (23) - 500 K |
| | | (13) - 5 K | (24) - 750 K |
| | | (14) - 7.5 K | (25) - 1 M |
| | | (15) - 10 K | |
| (B) | Linear C-P ±20 % | (10) - 1 K | (18) - 50 K |
| (E) | Linear C-P ±10 % | (12) - 2.5 K | (20) - 100 K |
| | | (13) - 5 K | (22) - 250 K |
| | | (15) - 10 K | (23) - 500 K |
| | | (16) - 20 K | (25) - 1 M |
| | | (17) - 25 K | |
| (C) | CW Audio Cermet ±10 % | (10) - 1 K | (18) - 50 K |
| (D) | CW Audio C-P ±20 % | (12) - 2.5 K | (20) - 100 K |
| (F) | CCW Audio Cermet ±10 % | (13) - 5 K | (22) - 250 K |
| (G) | CCW Audio C-P ±20 % | (15) - 10 K | (23) - 500 K |
| (S) | CW Audio C-P ±10 % | (17) - 25 K | (25) - 1 M |
| (T) | CCW Audio C-P ±10 % | | |

Boldface features are Bourns standard options. All others are available with higher minimum order quantities.

REV. 02/10

Specifications are subject to change without notice. Customers should verify actual device performance in their specific applications.