

*RoHS COMPLIANT
VERSIONS
AVAILABLE



BOURNS®

Features

- Space saving design
- Wide range of resistance values
- PC pin or solder lug terminals
- Metric shaft and bushing option
- Mounting brackets available
- Linear or audio taper versions

PC - "Slimline" 22 mm Square Single Turn Panel Control

Electrical Characteristics

| | |
|---|-------------------------|
| Standard Resistance Range | 500 ohms to 1 megohm |
| Linear Tapers | 1 K ohms to 500 K ohms |
| Audio Tapers | ±20 % |
| Total Resistance Tolerance | ±20 % |
| Independent Linearity | ±5 % |
| Absolute Minimum Resistance | 5 ohms maximum |
| Effective Electrical Angle | 270 ° ± 5 ° |
| Contact Resistance Variation | 7 % of total resistance |
| Dielectric Withstanding Voltage (MIL-STD-202, Method 301) | |
| Sea Level | 1,000 VAC minimum |
| 70,000 Feet | 500 VAC minimum |
| Insulation Resistance (500 V) | 1,000 ohms minimum |
| Power Rating @ 70 °C (Voltage Limited by Power Dissipation or 350 VAC, Whichever is Less) | |
| Linear | .75 watt |
| Audio | .25 watt |
| Theoretical Resolution | Essentially infinite |

Environmental Characteristics

| | |
|--|---|
| Operating Temperature Range | +1 °C to +125 °C |
| Storage Temperature Range | -40 °C to +125 °C |
| Temperature Coefficient Over Storage Temperature Range | ±1000 ppm/°C |
| Vibration | .20 G |
| Total Resistance Shift | ±1 % maximum |
| Voltage Ratio Shift | ±20 % maximum |
| Shock | .50 G |
| Total Resistance Shift | ±1 % maximum |
| Voltage Ratio Shift | ±20 % maximum |
| Load Life | 1,000 Hours @ Rated Power, 20 % RH, 70 °C |
| Total Resistance Shift | ±10 % maximum |
| Rotational Life (No Load) | 50,000 cycles |
| Total Resistance Shift (Linear taper) | ±10 ohms or 12 %, whichever is greater |
| Total Resistance Shift (Audio taper) | ±20 % maximum |
| Contact Resistance Variation | ±5 % maximum |
| Moisture Resistance | MIL-STD-303, Method 103, Condition B |
| Total Resistance Shift | ±20 % maximum |
| IP Rating | IP 40 |

Mechanical Characteristics

| | |
|--|---|
| Stop Strength (1/4 " and 6 mm Shaft Diameters) | 79.09 N-cm (7 lb.-in.) |
| Mechanical Angle | 300 ° ± 5 ° |
| Torque | |
| Starting (Detented) | 0.5-1.5 N-cm (0.75-2.25 oz.-in.) |
| Starting (Undetented) | 1.5 N-cm (2.25 oz.-in.) maximum |
| Running (Undetented) | 0.18 to 1.06 N-cm (0.25 to 1.5 oz.-in.) |
| Mounting | 79.09 N-cm (7 lb.-in.) maximum |
| Weight (Single Section) | .21 gm (0.75 oz.) maximum |
| Terminals | PC pin or solder lug |
| Soldering Condition | Recommended hand soldering using Sn95/Ag5 no clean solder, 0.025 " wire diameter. Maximum temperature 399 °C (750 °F) for 3 seconds. No wash process to be used with no clean flux. |
| Marking | Manufacturer's trademark, resistance value, part number, and date code |
| Ganging | .1 cup maximum |
| Hardware | One lockwasher and one mounting nut is shipped with each potentiometer, except where noted in the part number. |
| Detents | Center, 10, 20, 30, none |

For additional features or specifications not shown, consult factory.

FOR ORDERING INFORMATION SEE PAGE 4.

*RoHS Directive 2002/95/EC Jan 27 2003 including Annex
Specifications are subject to change without notice.

Customers should verify actual device performance in their specific applications.

PC - "Slimline" 22 mm Square Single Turn Panel Control

BOURNS®

Product Dimensions

SOLDER LUGS

(Dimensions not given are the same as PC pins (rear facing)).

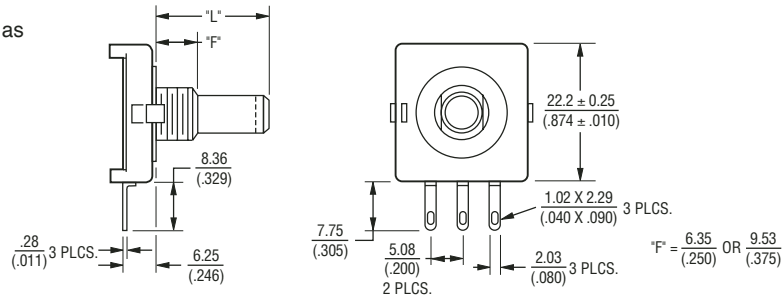

PC PINS (Rear Facing) With Rear Mounting Bracket

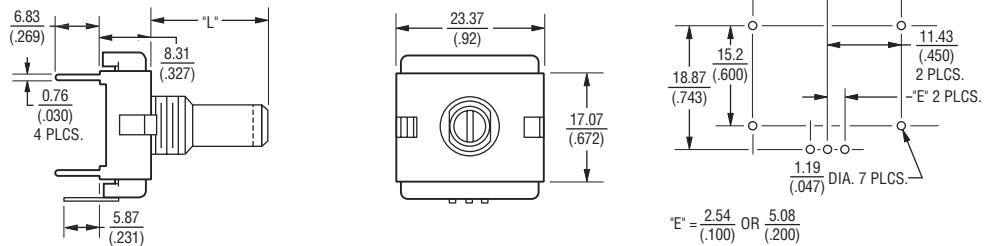

PC PINS (Side Exit) With Side Mounting Bracket

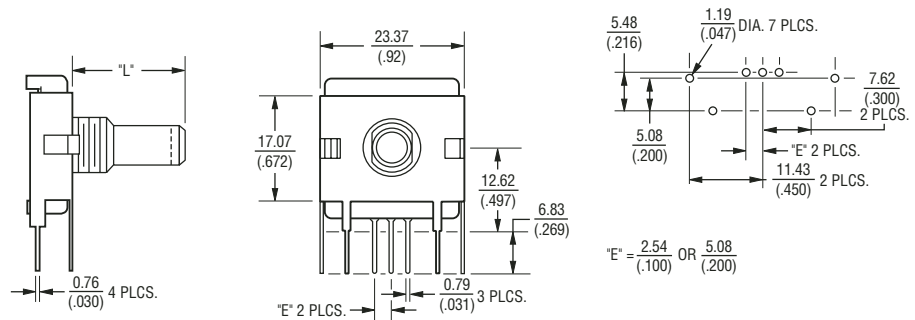

SHAFT STYLES AND ORIENTATION (Full CCW Rotation)

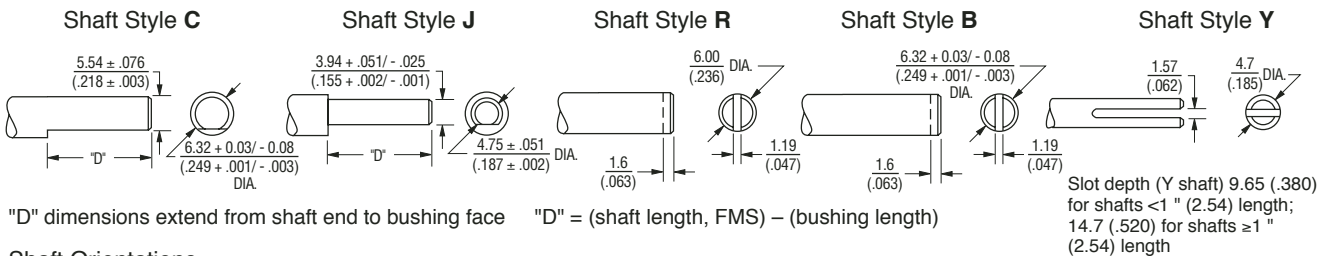

Shaft Orientations

Shaft Styles C, J

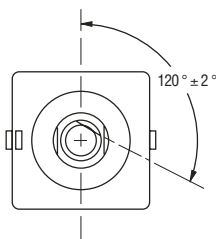

Shaft Styles B, R

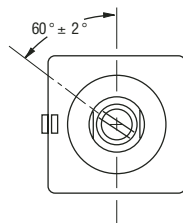

Shaft Style Y

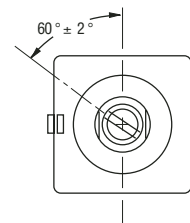

DIMENSIONS: MM (IN.)
 TOLERANCES EXCEPT WHERE NOTED:
 .XX = ± 0.25 (0.010)
 .XXX = ± 0.13 (0.005)

Specifications are subject to change without notice. Customers should verify actual device performance in their specific applications.

How to Order PC "Slimline" Panel Controls

BOURNS®

P C W 1 J - B 2 4 - B A B 1 0 3 L

| RoHS IDENTIFIER | |
|-----------------|---------------|
| Code | Description |
| L | Compliant |
| Blank | Non-Compliant |

| SHAFT LENGTH (FMS) | | |
|--------------------|------------------------------|------------------------|
| Code | Description | Available Shaft Styles |
| 16 | 1/2" (12.7 mm) Length | B |
| 20 | 5/8" (15.9 mm) Length | J |
| 24 | 3/4" (19 mm) Length | B, C, J, Y |
| 28 | 7/8" (22.2 mm) Length | B, C, J, Y |
| 32 | 1" (25.4 mm) Length | B, C, J, Y |
| 36 | 1-1/8" (28.6 mm) Length | B, C, J, Y |
| Metric | | |
| 19 | 19 mm Length | R |
| 22 | 22 mm Length | R |
| 24 | 24 mm Length | R |

| RESISTANCE VALUES | | | | | |
|-------------------|-------------|------------|--------------|------------|---------------|
| Code | TR | Code | TR | Code | TR |
| 501 | 500 Ω | 103 | 10 KΩ | 104 | 100 KΩ |
| 102 | 1 KΩ | 203 | 20 KΩ | 254 | 250 KΩ |
| 252 | 2.5 KΩ | 253 | 25 KΩ | 504 | 500 KΩ |
| 502 | 5 KΩ | 503 | 50 KΩ | 105 | 1 MΩ |

| ELEMENT TAPER VERSIONS | |
|------------------------|--------------------|
| Code | Taper Description |
| B | Lin. CP ±20 % |
| D | CW Audio CP ±20 % |
| G | CCW Audio CP ±20 % |

| SHAFT STYLES (See Outline Drawing) | |
|------------------------------------|--|
| Code | Description |
| B | 1/4" (6.35 mm) Dia. Slotted |
| C | 1/4" (6.35 mm) Dia. Flatted |
| J | 3/16" (4.76 mm) Dia. Flatted |
| R | 6 mm Dia. Slotted (Use Metric Lengths Only) |
| Y | 3/16" (4.76 mm) Dia. Split Shaft |

| DETENT CONFIGURATIONS | |
|-----------------------|--------------------|
| Code | Taper Description |
| A | No Detents |
| B | 10 Detents |
| C | Center Detent Only |
| D | 20 Detents |
| E | 30 Detents |
| F | CCW Detent Only |

| ANTI-ROTATION LUG | |
|-------------------|----------------------|
| Code | Description |
| J | 9:00 Position |
| D | None |

| NO. SECTIONS | |
|--------------|---------------|
| Code | Description |
| 1 | Single |

| BUSHING CONFIGURATION | | |
|-----------------------|---|------------------------|
| Code | Description | Available Shaft Styles |
| W | 9 mm x .250" (6.35 mm) Length Threaded M9 x 0.75 6g 5 PI | All |
| L | 9 mm x .375" (9.53 mm) Length Threaded M9 x 0.75 6g 5 PI | B, C, R |

| HOUSING TERMINAL CONFIGURATION | | | | | | | | | | | | | |
|--|----------|----------|---|---|---|---|---|---|---|---|---|---|---|
| Features | Code | | | | | | | | | | | | |
| | A | B | C | D | E | F | G | H | J | K | L | M | N |
| Rear Mounting Bracket | | X | | | | | | | X | X | | | X |
| Side Mounting Bracket | | | | | X | | X | | | | X | X | |
| Rear Facing Terminals .100" (2.54 mm) Centers | X | X | | | | | | | | | X | | |
| Side Exiting Terminals .100" (2.54 mm) Centers | | | | X | X | | | | | | X | | |
| Side Exiting Terminals .200" (5.08 mm) Centers | | | | | | X | X | | | | | X | |
| Solder Lugs .200" (5.08 mm) Centers | | | X | | | | | | | | | | |
| Rear Facing Terminals .200" (5.08 mm) Centers | | | | | | | | X | X | | | | X |
| Hardware Included | X | | X | X | | X | | X | | X | X | X | X |

Panel mount hardware not included as standard on bracketed versions. The sample part number demonstrates the identification code for Bourns Slimline Potentiometers. The part number shown is a commonly used model, typically available from stock.

Boldface features are Bourns standard options. All others are available with higher minimum order quantities.