



# Dual RF LDMOS Bias Controllers with I<sup>2</sup>C/SPI Interface

MAX1385/MAX1386

## General Description

The MAX1385/MAX1386 set and control bias conditions for dual RF LDMOS power devices found in cellular base stations. Each device includes a high-side current-sense amplifier with programmable gains of 2, 10, and 25 to monitor LDMOS drain current over the 20mA to 5A range. Two external diode-connected transistors monitor LDMOS temperatures while an internal temperature sensor measures the local die temperature of the MAX1385/MAX1386. A 12-bit ADC converts the programmable-gain amplifier (PGA) outputs, external/internal temperature readings, and two auxiliary inputs.

The two gate-drive channels, each consisting of 8-bit coarse and 10-bit fine DACs and a gate-drive amplifier, generate a positive gate voltage to bias the LDMOS devices. The MAX1385 includes a gate-drive amplifier with a gain of 2 and the MAX1386 gate-drive amplifier provides a gain of 4. The 8-bit coarse and 10-bit fine DACs allow up to 18 bits of resolution. The MAX1385/MAX1386 include autocalibration features to minimize error over time, temperature, and supply voltage.

The MAX1385/MAX1386 feature an I<sup>2</sup>C/SPI™-compatible serial interface. Both devices operate from a 4.75V to 5.25V analog supply (3.2mA supply current), a 2.7V to 5.25V digital supply (3.1mA supply current), and a 4.75V to 11.0V gate-drive supply (4.5mA supply current). The MAX1385/MAX1386 are available in a 48-pin thin QFN package.

## Applications

RF LDMOS Bias Control in Cellular Base Stations  
Industrial Process Control

## Features

- ◆ Integrated High-Side Drain Current-Sense PGA with Gain of 2, 10, or 25
- ◆ ±0.5% Accuracy for Sense Voltage Between 75mV and 250mV
- ◆ Full-Scale Sense Voltage of 100mV with Gain of 25
- ◆ Full-Scale Sense Voltage of 250mV with Gain of 10
- ◆ Common-Mode Range of 5V to 30V Drain Voltage for LDMOS
- ◆ Adjustable Low Noise 0 to 5V, 0 to 10V Output Gate-Bias Voltage Ranges with ±10mA Gate Drive
- ◆ Fast Clamp to 0V for LDMOS Protection
- ◆ 8-Bit DAC Control of Gate-Bias Voltage
- ◆ 10-Bit DAC Control of Gate-Bias Offset with Temperature
- ◆ Internal Die Temperature Measurement
- ◆ External Temperature Measurement by Diode-Connected Transistor (2N3904)
- ◆ Internal 12-Bit ADC Measurement of Temperature, Current, and Voltages
- ◆ Selectable I<sup>2</sup>C-/SPI-Compatible Serial Interface  
400kHz/1.7MHz/3.4MHz I<sup>2</sup>C-Compatible Control for Settings and Data Measurement  
16MHz SPI-Compatible Control for Settings and Data Measurement
- ◆ Internal 2.5V Reference
- ◆ Three Address Inputs to Control Eight Devices in I<sup>2</sup>C Mode

## Ordering Information/Selector Guide

PART	TEMP RANGE	PIN-PACKAGE	TEMP ERROR (°C)	V <sub>GATE</sub> (V)
MAX1385AETM+**	-40°C to +85°C	48 Thin QFN-EP*	±1	5
MAX1385BETM+	-40°C to +85°C	48 Thin QFN-EP*	±2	5
MAX1386AETM+**	-40°C to +85°C	48 Thin QFN-EP*	±1	10
MAX1386BETM+**	-40°C to +85°C	48 Thin QFN-EP*	±2	10

\*EP = Exposed pad.

\*\*Future product—contact factory for availability.

+Denotes a lead(Pb)-free/RoHS-compliant package.

**Pin Configuration and Typical Operating Circuit (I<sup>2</sup>C Mode)  
appear at end of data sheet.**

SPI is a trademark of Motorola, Inc.



Maxim Integrated Products 1

**For pricing, delivery, and ordering information, please contact Maxim Direct at 1-888-629-4642, or visit Maxim's website at [www.maxim-ic.com](http://www.maxim-ic.com).**

# Dual RF LDMOS Bias Controllers with I<sup>2</sup>C/SPI Interface

## ABSOLUTE MAXIMUM RATINGS

AV <sub>DD</sub> to AGND .....	-0.3V to +6V	Digital Inputs to DGND .....	-0.3V to the lower of +6V and (DV <sub>DD</sub> + 0.3V)
DV <sub>DD</sub> to DGND .....	-0.3V to +6V	SDA/DIN, SCL to DGND .....	-0.3V to +6V
AGND to DGND .....	-0.3V to +0.3V	Digital Outputs to DGND .....	-0.3V to (DV <sub>DD</sub> + 0.3V)
CS1+, CS1-, CS2+, CS2- to GATEGND .....	-0.3V to +32V	Maximum Continuous Current into Any Pin .....	50mA
CS1- to CS1+, CS2- to CS2+ .....	-6V to +0.3V	Continuous Power Dissipation (T <sub>A</sub> = +70°C)	
GATEV <sub>DD</sub> to GATEGND .....	-0.3V to +12V	48-Pin, 7mm x 7mm, Thin QFN (derate 27.8 mW/°C above +70°C) .....	2222mW
GATE1, GATE2 to GATEGND .....	-0.3V to (GATEV <sub>DD</sub> + 0.3V)	Maximum Junction Temperature .....	+150°C
SAFE1, SAFE2 to GATEGND .....	-0.3V to +6V	Operating Temperature Range .....	-40°C to +85°C
GATEGND to AGND .....	-0.3V to +0.3V	Storage Temperature Range .....	-65°C to +150°C
All Other Analog Inputs to AGND .....	-0.3V to the lower of +6V and (AV <sub>DD</sub> + 0.3V)	Lead Temperature (soldering, 10s) .....	+300°C

Stresses beyond those listed under "Absolute Maximum Ratings" may cause permanent damage to the device. These are stress ratings only, and functional operation of the device at these or any other conditions beyond those indicated in the operational sections of the specifications is not implied. Exposure to absolute maximum rating conditions for extended periods may affect device reliability.

## ELECTRICAL CHARACTERISTICS

(GATEV<sub>DD</sub> = +5.5V for the MAX1385, GATEV<sub>DD</sub> = +11V for the MAX1386, AV<sub>DD</sub> = DV<sub>DD</sub> = +5V, external V<sub>REFADC</sub> = +2.5V, external V<sub>REF-DAC</sub> = +2.5V, C<sub>REF</sub> = 0.1µF, unless otherwise noted. T<sub>A</sub> = -40°C to +85°C, unless otherwise noted. Typical values are at T<sub>A</sub> = +25°C.)

PARAMETER	SYMBOL	CONDITIONS	MIN	TYP	MAX	UNITS
<b>HIGH-SIDE CURRENT SENSE WITH PGA</b>						
Common-Mode Input Voltage Range	V <sub>CS+</sub> , V <sub>CS-</sub>		5		30	V
Common-Mode Rejection Ratio	CMRR	11V < V <sub>CS+</sub> < 30V		90		dB
Input-Bias Current	I <sub>CS+</sub>	V <sub>SENSE</sub> < 100mV over the common-mode range		120	195	µA
	I <sub>CS-</sub>			0.002	±2	
Full-Scale Sense Voltage Range	V <sub>SENSE</sub> = V <sub>CS+</sub> - V <sub>CS-</sub>	PGA gain = 25	0		100	mV
		PGA gain = 10	0		250	
		PGA gain = 2	0		1250	
Sense Voltage Range for Accuracy of ±0.5% V <sub>SENSE</sub>		PGA gain = 25	75		100	mV
		PGA gain = 10	75		250	
		PGA gain = 2	75		1250	
Sense Voltage Range for Accuracy of ±2% V <sub>SENSE</sub>		PGA gain = 25	20		100	mV
		PGA gain = 10	20		250	
		PGA gain = 2	20		1250	
Total PGAOUT Voltage Error		V <sub>SENSE</sub> = 75mV		±0.1	±0.5	%
PGAOUT Capacitive Load	C <sub>PGAOUT</sub>				100	pF
PGAOUT Settling Time	t <sub>HSCS</sub>	Settles to within ±0.5% of final value, R <sub>S</sub> = 50Ω, C <sub>GATE</sub> = 15pF		< 25		µs
Saturation Recovery Time		Settles to within ±0.5% accuracy; from V <sub>SENSE</sub> = 3 x full scale		< 45		µs
Sense-Amplifier Slew Rate		AV <sub>PGA</sub> = 2		0.5		V/µs
		AV <sub>PGA</sub> = 10		2		
		AV <sub>PGA</sub> = 25		2		

# Dual RF LDMOS Bias Controllers with I<sup>2</sup>C/SPI Interface

MAX1385/MAX1386

## ELECTRICAL CHARACTERISTICS (continued)

(GATEV<sub>DD</sub> = +5.5V for the MAX1385, GATEV<sub>DD</sub> = +11V for the MAX1386, AV<sub>DD</sub> = DV<sub>DD</sub> = +5V, external V<sub>REFADC</sub> = +2.5V, external V<sub>REF-DAC</sub> = +2.5V, C<sub>REF</sub> = 0.1μF, unless otherwise noted. T<sub>A</sub> = -40°C to +85°C, unless otherwise noted. Typical values are at T<sub>A</sub> = +25°C.)

PARAMETER	SYMBOL	CONDITIONS	MIN	TYP	MAX	UNITS
Sense-Amplifier Bandwidth		AvPGA = 2		900		kHz
		AvPGA = 10		720		
		AvPGA = 25		290		
<b>LDMOS GATE DRIVER (GAIN = 2 and 4)</b>						
Output Gate-Drive Voltage Range	VGATE	I <sub>GATE</sub> = ±1mA	0.75	GATEV <sub>DD</sub> - 0.75		V
		I <sub>GATE</sub> = ±10mA	1	GATEV <sub>DD</sub> - 1		
Output Impedance	RGATE	Measured at DC		0.1		Ω
VGATE Settling Time	t <sub>GATE</sub>	Settles to within ±0.5% of final value; R <sub>SERIES</sub> = 50Ω, C <sub>GATE</sub> = 15μF		10		ms
Output Capacitive Load (Note 1)	CGATE	No series resistance, R <sub>SERIES</sub> = 0Ω	0	10		nF
		R <sub>SERIES</sub> = 50Ω	0	25,000		
VGATE Noise		RMS noise; 1kHz - 1MHz		250		nV/√Hz
Maximum Power-On Transient				±100		mV
Output Short-Circuit Current Limit	I <sub>SC</sub>	1s, sinking or sourcing		±25		mA
Total Unadjusted Error No Autocalibration and Offset Removal (Note 2)	TUE	MAX1385, LOCODE = 128, HICODE = 180		±6	±20	mV
		MAX1386, LOCODE = 128, HICODE = 180		±12	±40	
Total Adjusted Error With Autocalibration and Offset Removal	TUE	MAX1385, LOCODE = 128, HICODE = 180		±1	±8	mV
		MAX1386, LOCODE = 128, HICODE = 180		±2	±16	
Drift		MAX1385, VGATE > 1V		±15		μV/°C
		MAX1386, VGATE > 1V		±30		
Clamp to Zero Delay				1		μs
Output Safe Switch On-Resistance	ROPSW	GATE_ clamped to AGND (Note 3)			500	Ω
Amplifier Bandwidth		MAX1385		300		kHz
		MAX1386		150		
Amplifier Slew Rate				0.375		V/μs
<b>MONITOR ADC DC ACCURACY</b>						
Resolution	NADC		12			Bits
Differential Nonlinearity	DNL <sub>ADC</sub>			±0.5	±2	LSB
Integral Nonlinearity	INL <sub>ADC</sub>	(Note 4)		±0.6	±2	LSB
Offset Error				±2	±4	LSB
Gain Error		(Note 5)		±2	±4	LSB
Gain Temperature Coefficient				±0.4		ppm/°C
Offset Temperature Coefficient				±0.4		ppm/°C

# Dual RF LDMOS Bias Controllers with I<sup>2</sup>C/SPI Interface

## ELECTRICAL CHARACTERISTICS (continued)

(GATEV<sub>DD</sub> = +5.5V for the MAX1385, GATEV<sub>DD</sub> = +11V for the MAX1386, AV<sub>DD</sub> = DV<sub>DD</sub> = +5V, external V<sub>REFADC</sub> = +2.5V, external V<sub>REFDAC</sub> = +2.5V, C<sub>REF</sub> = 0.1μF, unless otherwise noted. T<sub>A</sub> = -40°C to +85°C, unless otherwise noted. Typical values are at T<sub>A</sub> = +25°C.)

PARAMETER	SYMBOL	CONDITIONS	MIN	TYP	MAX	UNITS
Channel-to-Channel Offset Matching				±0.1		LSB
Channel-to-Channel Gain Matching				±0.1		LSB
<b>MONITOR ADC DYNAMIC ACCURACY (1kHz sine-wave input, 2.5Vp-p, up to 94.4ksps)</b>						
Signal-to-Noise Plus Distortion	SINAD			70		dB
Total Harmonic Distortion	THD	Up to the 5th harmonic		-82		dB
Spurious-Free Dynamic Range	SFDR			86		dB
Intermodulation Distortion	IMD	f <sub>IN1</sub> = 0.99kHz, f <sub>IN2</sub> = 1.02kHz		76		dB
Full-Power Bandwidth		-3dB point		10		MHz
Full-Linear Bandwidth		S/(N + D) > 68dB		100		kHz
<b>MONITOR ADC CONVERSION RATE</b>						
Power-Up Time	t <sub>PU</sub>	External reference		0.8		μs
		Internal reference		70		
Conversion Time	t <sub>CONV</sub>	Internally clocked		7.5	10	μs
<b>MONITOR ADC ANALOG INPUT (ADCIN1, ADCIN2)</b>						
Input Range	V <sub>ADCIN</sub>	Relative to AGND (Note 6)	0		V <sub>REF</sub>	V
Input Leakage Current		V <sub>IN</sub> = 0V and V <sub>IN</sub> = AV <sub>DD</sub>		±0.01	±1	μA
Input Capacitance	C <sub>ADCIN</sub>			34		pF
<b>TEMPERATURE MEASUREMENTS</b>						
Internal Sensor Measurement Error (Note 1)		MAX1385A/MAX1386A, T <sub>A</sub> = +25°C		±0.25		°C
		MAX1385A/MAX1386A, T <sub>A</sub> = T <sub>MIN</sub> to T <sub>MAX</sub>	-1.0	±0.25	+1.0	
		MAX1385B/MAX1386B, T <sub>A</sub> = +25°C		±0.25		
		MAX1385B/MAX1386B, T <sub>A</sub> = T <sub>MIN</sub> to T <sub>MAX</sub>	-2.0	±0.35	+2.0	
External Sensor Measurement Error (Notes 1, 7)		T <sub>A</sub> = +25°C		±0.4		°C
		T <sub>A</sub> = T <sub>MIN</sub> to T <sub>MAX</sub>	-3	±0.75	+3	
Temperature Resolution				1/8		°C/LSB
External Diode Drive			2.8		85	μA
Drive Current Ratio		(Note 8)		16.5		
<b>INTERNAL REFERENCE</b>						
REFADC/REFDAC Output Voltage	V <sub>REFADC</sub>	T <sub>A</sub> = +25°C	2.494	2.500	2.506	V
	V <sub>REFDAC</sub>	T <sub>A</sub> = +25°C	2.494	2.500	2.506	
REFADC/REFDAC Output Temperature Coefficient	T <sub>CREFADC</sub> , T <sub>CREFDAC</sub>			±14		ppm/°C
REFADC/REFDAC Output Impedance				6.5		kΩ

# Dual RF LDMOS Bias Controllers with I<sup>2</sup>C/SPI Interface

MAX1385/MAX1386

## ELECTRICAL CHARACTERISTICS (continued)

(GATEV<sub>DD</sub> = +5.5V for the MAX1385, GATEV<sub>DD</sub> = +11V for the MAX1386, AV<sub>DD</sub> = DV<sub>DD</sub> = +5V, external V<sub>REFADC</sub> = +2.5V, external V<sub>REF-DAC</sub> = +2.5V, C<sub>REF</sub> = 0.1μF, unless otherwise noted. T<sub>A</sub> = -40°C to +85°C, unless otherwise noted. Typical values are at T<sub>A</sub> = +25°C.)

PARAMETER	SYMBOL	CONDITIONS	MIN	TYP	MAX	UNITS
Capacitive Bypass at REF			270			nF
Power-Supply Rejection Ratio	PSRR	AV <sub>DD</sub> = +5V ±5%		70		dB
<b>EXTERNAL REFERENCE</b>						
REFADC Input Voltage Range	V <sub>REFADC</sub>	Limited code test	1.0		AV <sub>DD</sub>	V
REFADC Input Current	I <sub>REFADC</sub>	V <sub>REF</sub> = 2.5V, f <sub>SAMPLE</sub> = 174ksps		60	80	μA
		Acquisition/between conversions		±0.01	±1	
REFDAC Input Voltage Range	V <sub>REFDAC</sub>	(Note 9)	0.5		2.5	V
REFDAC Input Current		Static current when no DAC calibration		0.1		μA
<b>GATE-DRIVER COARSE-DAC DC ACCURACY</b>						
Resolution	N <sub>CDAC</sub>		8			Bits
Integral Nonlinearity	IN <sub>LCDAC</sub>	Measured at GATE; fine DAC set at full scale		±0.15	±1	LSB
Differential Nonlinearity	DN <sub>LCDAC</sub>	Guaranteed monotonic		±0.05	±0.5	LSB
<b>GATE-DRIVER FINE-DAC DC ACCURACY</b>						
Resolution	N <sub>FDAC</sub>		10			Bits
Integral Nonlinearity	IN <sub>LDAC</sub>	Measured at GATE; coarse DAC set at full scale		±0.25	±4	LSB
Differential Nonlinearity	DN <sub>LDAC</sub>	Guaranteed monotonic		±0.1	±1	LSB
<b>POWER SUPPLIES (Note 10)</b>						
Analog Supply Voltage	AV <sub>DD</sub>		4.75		5.25	V
Digital Supply Voltage	DV <sub>DD</sub>		2.7		AV <sub>DD</sub> + 0.3	V
Gate-Drive Supply Voltage	V <sub>GATEVDD</sub>		4.75		11.00	V
Analog Supply Current	I <sub>AVDD</sub>	AV <sub>DD</sub> = 5V		3.2	4	mA
Digital Supply Current	I <sub>DVDD</sub>	DV <sub>DD</sub> = 2.7V to 5.25V		3.1	4.3	mA
GATEV <sub>DD</sub> Supply Current	I <sub>GATEVDD</sub>		3	4.5	7	mA
Shutdown Current (Note 11)	I <sub>PD</sub>	I <sub>AVDD</sub>		0.1	2	μA
		I <sub>DVDD</sub>		0.1	2	
		I <sub>VDDGATE</sub>		0.1	2	

# Dual RF LDMOS Bias Controllers with I<sup>2</sup>C/SPI Interface

## ELECTRICAL CHARACTERISTICS (continued)

(GATEV<sub>DD</sub> = +5.5V for the MAX1385, GATEV<sub>DD</sub> = +11V for the MAX1386, AV<sub>DD</sub> = DV<sub>DD</sub> = +5V, external V<sub>REFADC</sub> = +2.5V, external V<sub>REF-DAC</sub> = +2.5V, C<sub>REF</sub> = 0.1μF, unless otherwise noted. T<sub>A</sub> = -40°C to +85°C, unless otherwise noted. Typical values are at T<sub>A</sub> = +25°C.)

PARAMETER	SYMBOL	CONDITIONS	MIN	TYP	MAX	UNITS
<b>V<sub>IH</sub> AND V<sub>IL</sub> FOR SDA/DIN AND SCL IN I<sup>2</sup>C OPERATION ONLY</b>						
Input High Voltage	V <sub>IH</sub>		0.7 x DV <sub>DD</sub>			V
Input Low Voltage	V <sub>IL</sub>				0.3 x DV <sub>DD</sub>	V
Input Hysteresis	V <sub>HYS</sub>		0.1 x DV <sub>DD</sub>			V
<b>V<sub>IH</sub> AND V<sub>IL</sub> FOR OPSAFE1 AND OPSAFE2</b>						
Input High Voltage	V <sub>IH</sub>		2.4			V
Input Low Voltage	V <sub>IL</sub>				0.4	V
<b>V<sub>IH</sub> AND V<sub>IL</sub> FOR ALL OTHER DIGITAL INPUTS</b>						
Input High Voltage	V <sub>IH</sub>		2.2			V
Input Low Voltage	V <sub>IL</sub>				0.7	V
<b>V<sub>OH</sub> AND V<sub>OL</sub> FOR A1/DOUT (SPI), SDA/DIN, ALARM</b>						
Output Low Voltage	V <sub>OL</sub>	I <sub>SINK</sub> = 3mA			0.4	V
Output High Voltage	V <sub>OH</sub>	I <sub>SOURCE</sub> = 2mA	DV <sub>DD</sub> - 0.5			V
<b>V<sub>OH</sub> AND V<sub>OL</sub> FOR SAFE1, SAFE2, BUSY</b>						
Output Low Voltage	V <sub>OL</sub>	I <sub>SINK</sub> = 0.5mA			0.4	V
Output High Voltage	V <sub>OH</sub>	I <sub>SOURCE</sub> = 0.5mA	DV <sub>DD</sub> - 0.5			V

# Dual RF LDMOS Bias Controllers with I<sup>2</sup>C/SPI Interface

MAX1385/MAX1386

## I<sup>2</sup>C SLOW-/FAST-MODE TIMING CHARACTERISTICS (Note 12, see Figure 1)

(GATEV<sub>DD</sub> = +5.5V for MAX1385, GATEV<sub>DD</sub> = +11V for MAX1386, AV<sub>DD</sub> = +5V, DV<sub>DD</sub> = 2.7V to 5.25V, external V<sub>REFADC</sub> = +2.5V, external V<sub>REFDAC</sub> = +2.5V, C<sub>REF</sub> = 0.1μF, T<sub>A</sub> = -40°C to +85°C, unless otherwise noted).

PARAMETER	SYMBOL	CONDITIONS	MIN	TYP	MAX	UNITS
Serial-Clock Frequency	f <sub>SCL</sub>		0		400	kHz
Bus Free Time Between STOP and START Condition	t <sub>BUF</sub>		1.3			μs
Hold Time Repeated START Condition	t <sub>HD;STA</sub>	After this period, the first clock pulse is generated	0.6			μs
SCL Pulse-Width Low	t <sub>LOW</sub>		1.3			μs
SCL Pulse-Width High	t <sub>HIGH</sub>		0.6			μs
Setup Time Repeated START Condition	t <sub>SU;STA</sub>		0.6			μs
Data Hold Time	t <sub>HD;DAT</sub>	(Note 13)	0		0.9	μs
Data Setup Time	t <sub>SU;DAT</sub>		100			ns
Rise Time of Both SDA and SCL Signals, Receiving	t <sub>R</sub>	(Note 14)	0		300	ns
Fall Time of Both SDA and SCL Signals, Receiving	t <sub>F</sub>	(Note 14)	0		300	ns
Fall Time of SDA Signal, Transmitting	t <sub>F</sub>	(Notes 14, 15)	20 + 0.1C <sub>b</sub>		250	ns
Setup Time for STOP Condition	t <sub>SU;STO</sub>		0.6			μs
Capacitive Load for Each Bus Line	C <sub>b</sub>				400	pF
Pulse Width of Spikes Suppressed by the Input Filter	t <sub>SP</sub>	(Note 16)	0		50	ns

# Dual RF LDMOS Bias Controllers with I<sup>2</sup>C/SPI Interface

## I<sup>2</sup>C HIGH-SPEED-MODE TIMING CHARACTERISTICS (Note 12, see Figure 2)

(GATEV<sub>DD</sub> = +5.5V for MAX1385, GATEV<sub>DD</sub> = +11V for MAX1386, AV<sub>DD</sub> = +5V, DV<sub>DD</sub> = 2.7V to 5.25V, external V<sub>REFADC</sub> = +2.5V, external V<sub>REFDAC</sub> = +2.5V, C<sub>REF</sub> = 0.1μF, T<sub>A</sub> = -40°C to +85°C, unless otherwise noted).

PARAMETER	SYMBOL	CONDITIONS	MIN	TYP	MAX	UNITS
Serial-Clock Frequency	f <sub>SCL</sub>		0		3.4	MHz
Setup Time Repeated START Condition	t <sub>SU;STA</sub>		160			ns
Hold Time Repeated START Condition	t <sub>HD;STA</sub>		160			ns
SCL Pulse-Width Low	t <sub>LOW</sub>		160			ns
SCL Pulse-Width High	t <sub>HIGH</sub>		60			ns
Data Setup Time	t <sub>SU;DAT</sub>		10			ns
Data Hold Time	t <sub>HD;DAT</sub>	(Note 17)	0		70	ns
Rise Time of SCL Signal, Receiving	t <sub>RCL</sub>		10		40	ns
Rise Time of SCL Signal After a Repeated START Condition and After an Acknowledge Bit, Receiving	t <sub>RCL1</sub>		10		80	ns
Fall Time of SCL Signal, Receiving	t <sub>FCL</sub>		10		40	ns
Rise Time of SDA Signal, Receiving	t <sub>RDA</sub>		10		80	ns
Fall Time of SDA Signal, Transmitting	t <sub>FDA</sub>		10		80	ns
Setup Time for STOP Condition	t <sub>SU;STO</sub>		160			ns
Capacitive Load for Each Bus Line	C <sub>b</sub>	(Note 18)			100	pF
Pulse Width of Spikes That are Suppressed by the Input Filter	t <sub>SP</sub>		0		10	ns



# Dual RF LDMOS Bias Controllers with I<sup>2</sup>C/SPI Interface

MAX1385/MAX1386

## SPI TIMING CHARACTERISTICS (Note 12, See Figure 3)

(GATEV<sub>DD</sub> = +5.5V for the MAX1385, GATEV<sub>DD</sub> = +11V for the MAX1386, AV<sub>DD</sub> = +5V, DV<sub>DD</sub> = 2.7V to 5.25V, external V<sub>REFDAC</sub> = +2.5V, external V<sub>REFDAC</sub> = +2.5V, C<sub>REF</sub> = 0.1μF, T<sub>A</sub> = -40°C to +85°C, unless otherwise noted.)

PARAMETER	SYMBOL	CONDITIONS	MIN	TYP	MAX	UNITS
SCL Clock Period	t <sub>CP</sub>		62.5			ns
SCL High Time	t <sub>CH</sub>		25			ns
SCL Low Time	t <sub>CL</sub>		25			ns
DIN Setup Time	t <sub>DS</sub>		10			ns
DIN Hold Time	t <sub>DH</sub>		0			ns
SCL Fall to DOUT Transition	t <sub>DO</sub>	C <sub>LOAD</sub> = 30pF			20	ns
$\overline{\text{CSB}}$ Fall to DOUT Enable	t <sub>DV</sub>	C <sub>LOAD</sub> = 30pF			40	ns
$\overline{\text{CSB}}$ Rise to DOUT Disable	t <sub>TR</sub>	C <sub>LOAD</sub> = 30pF (Note 12)			100	ns
$\overline{\text{CSB}}$ Rise or Fall to SCL Rise	t <sub>CSS</sub>		25			ns
$\overline{\text{CSB}}$ Pulse-Width High	t <sub>CSW</sub>		100			ns
Last Clock Rise to $\overline{\text{CSB}}$ Rise	t <sub>CSH</sub>		50			ns

**Note 1:** Guaranteed by design.

**Note 2:** Total unadjusted errors are for the entire gain drive channel including the 8- and 10-bit DACs and the gate driver. They are all measured at the GATE1 and GATE2 outputs. Offset removal refers to presetting the drain current after a room temperature calibration by the user. This effectively removes the channel offset.

**Note 3:** During power-on reset, the output safe switch is closed. The output safe switch opens once both AV<sub>DD</sub> and DV<sub>DD</sub> supply voltages are established.

**Note 4:** Integral nonlinearity is the deviation of the analog value at any code from its theoretical value after the gain and offset errors have been removed.

**Note 5:** Offset nulled.

**Note 6:** Absolute range for analog inputs is from 0 to AV<sub>DD</sub>.

**Note 7:** The MAX1385/MAX1386 and external sensor are at the same temperature. External sensor measurement error is tested with a diode-connected 2N3904.

**Note 8:** The drive current ratio is defined as the large drive current divided by the small drive current in a temperature measurement. See the *Temperature Measurements* section for further details.

**Note 9:** Guaranteed monotonicity. Accuracy might be degraded at lower V<sub>REFDAC</sub>.

**Note 10:** Supply current limits are valid only when digital inputs are at DV<sub>DD</sub> or DGND. Timing specifications are only guaranteed when inputs are driven rail-to-rail.

**Note 11:** Shutdown supply currents are typically 0.1μA. Maximum specification is limited by automated test equipment.

**Note 12:** All timing specifications referred to V<sub>IH</sub> or V<sub>IL</sub> levels.

**Note 13:** A master device must provide a hold time of at least 300ns for the SDA signal (referred to V<sub>IL</sub> of SCL) to bridge the undefined region of SCL's falling edge.

**Note 14:** C<sub>b</sub> = total capacitance of one bus line in pF; t<sub>R</sub> and t<sub>F</sub> are measured between 0.3 x DV<sub>DD</sub> and 0.7 x DV<sub>DD</sub>.

**Note 15:** For a device operating in an I<sup>2</sup>C-compatible system.

**Note 16:** Input filters on the SDA and SCL inputs suppress noise spikes less than 50ns.

**Note 17:** A device must provide a data hold time to bridge the undefined part between V<sub>IH</sub> and V<sub>IL</sub> of the falling edge of the SCL signal. An input circuit with a threshold as low as possible for the falling edge of the SCL signal minimizes this hold time.

**Note 18:** C<sub>b</sub> = total capacitance of one bus line in pF. For bus loads between 100pF and 400pF, the timing parameters should be linearly interpolated.



# Dual RF LDMOS Bias Controllers with I2C/SPI Interface

MAX1385/MAX1386

## Typical Operating Characteristics

(GATEV<sub>DD</sub> = +5.5V for the MAX1385, GATEV<sub>DD</sub> = +11V for the MAX1386, AV<sub>DD</sub> = DV<sub>DD</sub> = +5V, external V<sub>REFDAC</sub> = +2.5V, external V<sub>REFDAC</sub> = +2.5V, C<sub>REF</sub> = 0.1μF, T<sub>A</sub> = +25°C, unless otherwise noted.)

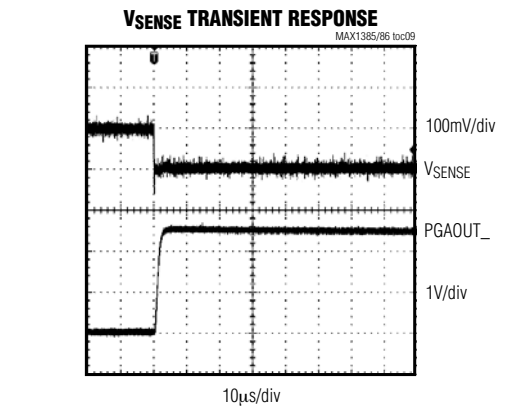
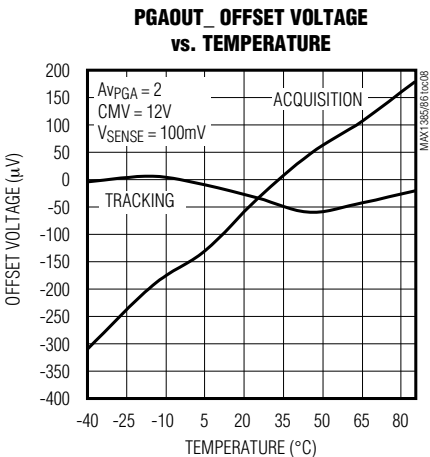
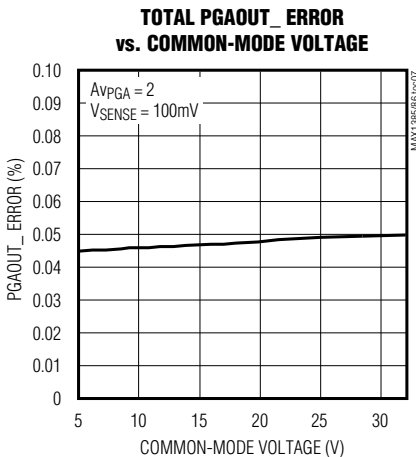
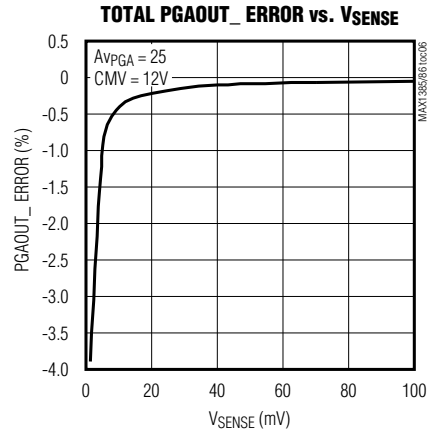
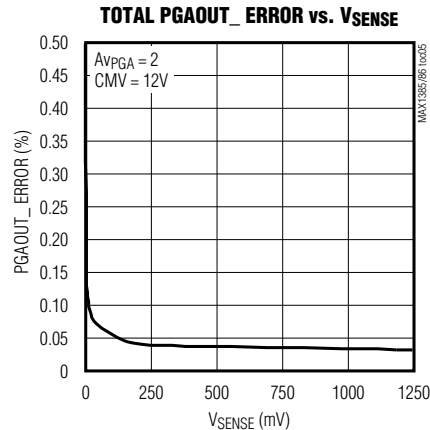
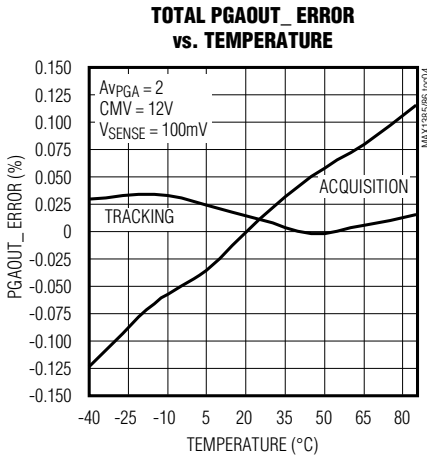
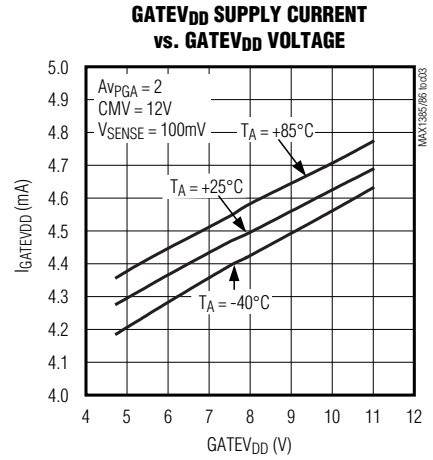
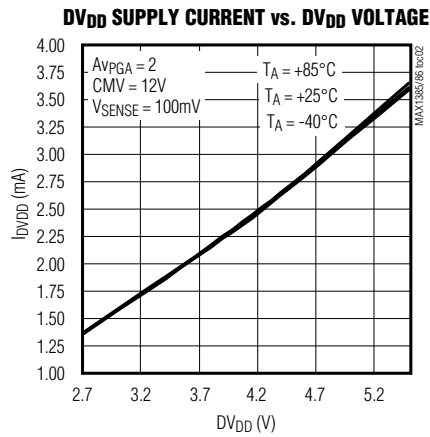
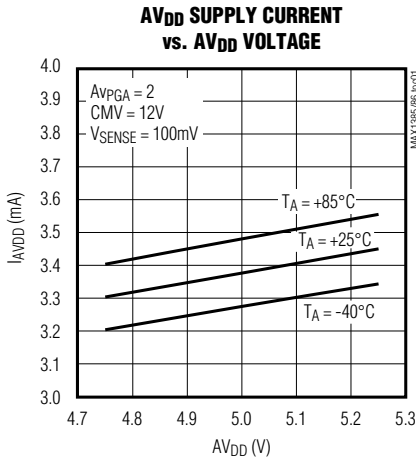

# Dual RF LDMOS Bias Controllers with I2C/SPI Interface

## Typical Operating Characteristics (continued)

(GATEV<sub>DD</sub> = +5.5V for the MAX1385, GATEV<sub>DD</sub> = +11V for the MAX1386, AV<sub>DD</sub> = DV<sub>DD</sub> = +5V, external V<sub>REFADC</sub> = +2.5V, external V<sub>REFDAC</sub> = +2.5V, C<sub>REF</sub> = 0.1μF, T<sub>A</sub> = +25°C, unless otherwise noted.)

**PGAOUT\_ 0mV TO 250mV  
V<sub>SENSE</sub> TRANSIENT RESPONSE**

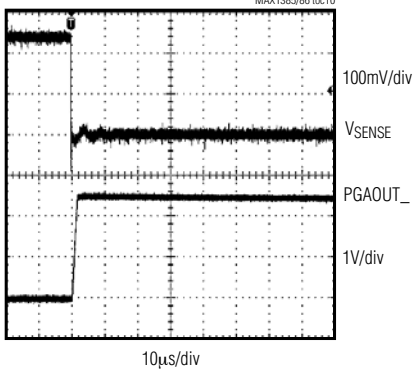

**PGAOUT\_ PEDESTAL ERROR  
DURING CALIBRATION**

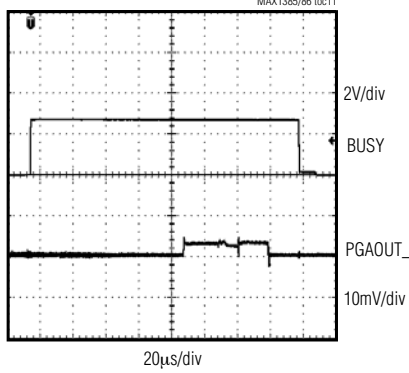

**GATE\_ OFFSET COMPENSATED  
ERROR vs. TEMPERATURE**

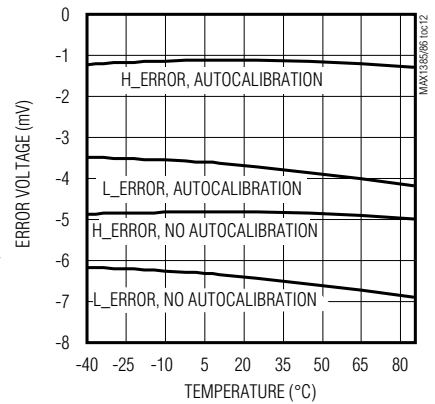

**V<sub>GATE</sub> vs. POWER-ON TIME**

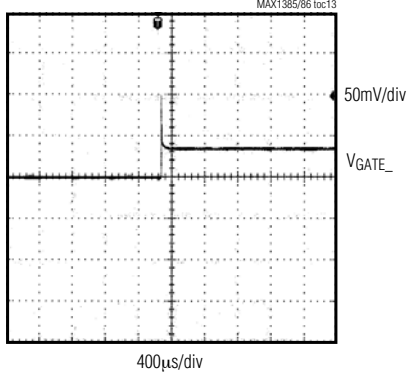

**GATE\_ SETTling TIME  
vs. LOAD CAPACITANCE**

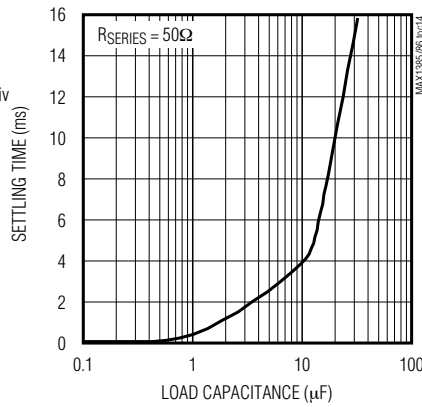

**CHARGE CURRENT vs. V<sub>GATE</sub>**

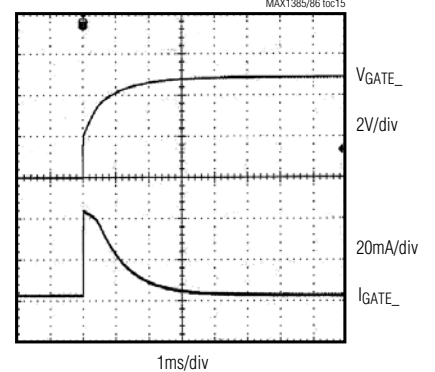

**GATE\_ VOLTAGE SWING  
vs. LOAD RESISTANCE**

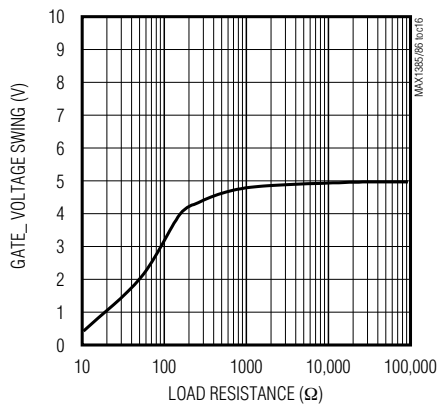

**GLITCH ENERGY**

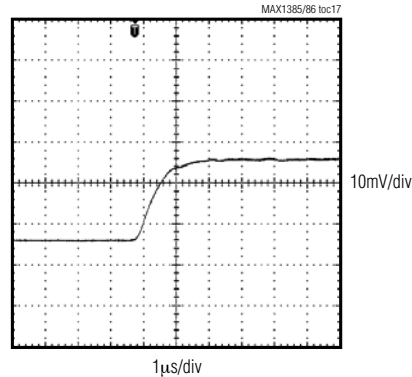

# Dual RF LDMOS Bias Controllers with I2C/SPI Interface

MAX1385/MAX1386

## Typical Operating Characteristics (continued)

(GATEV<sub>DD</sub> = +5.5V for the MAX1385, GATEV<sub>DD</sub> = +11V for the MAX1386, AV<sub>DD</sub> = DV<sub>DD</sub> = +5V, external V<sub>REFDAC</sub> = +2.5V, external V<sub>REFDAC</sub> = +2.5V, C<sub>REF</sub> = 0.1μF, T<sub>A</sub> = +25°C, unless otherwise noted.)

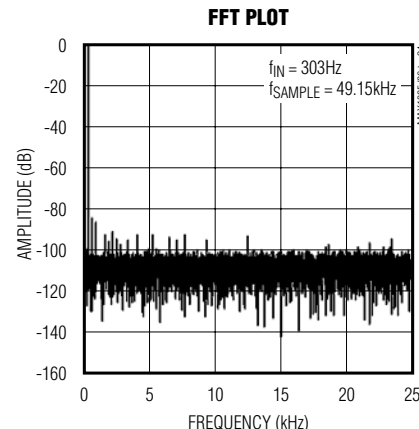
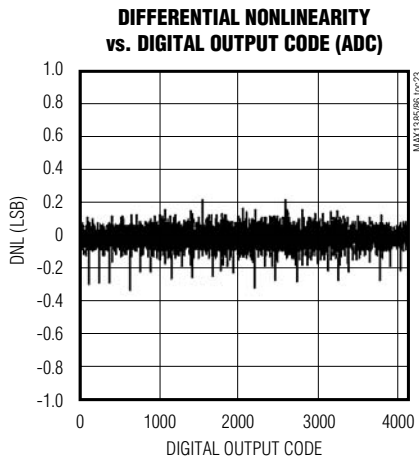
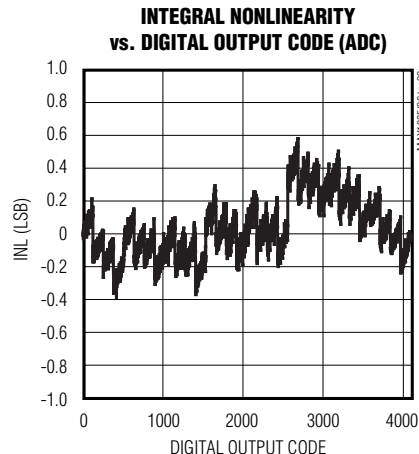
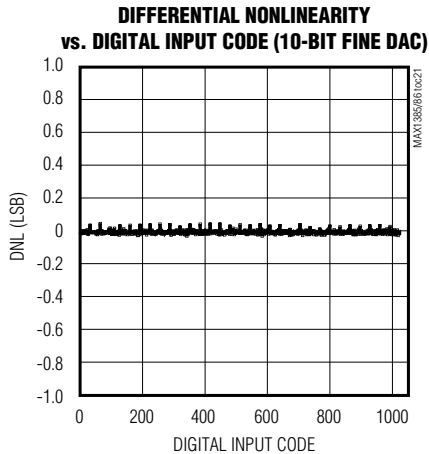
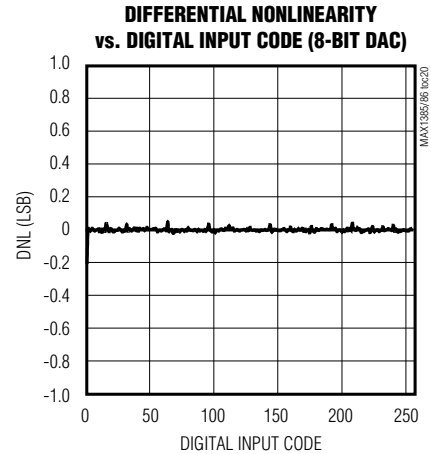
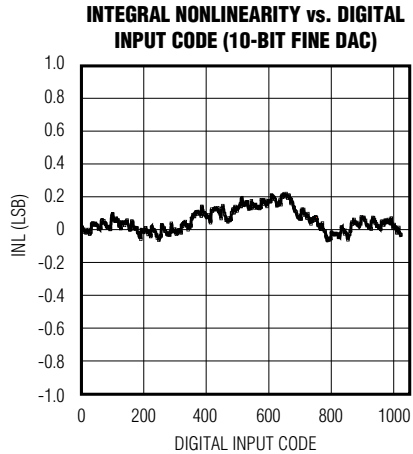
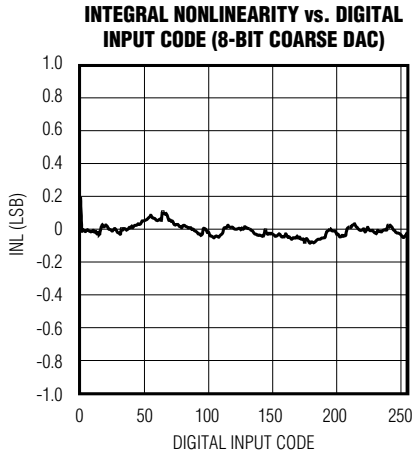

# Dual RF LDMOS Bias Controllers with I2C/SPI Interface

## Typical Operating Characteristics (continued)

(GATEV<sub>DD</sub> = +5.5V for the MAX1385, GATEV<sub>DD</sub> = +11V for the MAX1386, AV<sub>DD</sub> = DV<sub>DD</sub> = +5V, external V<sub>REFADC</sub> = +2.5V, external V<sub>REFDAC</sub> = +2.5V, C<sub>REF</sub> = 0.1μF, T<sub>A</sub> = +25°C, unless otherwise noted.)

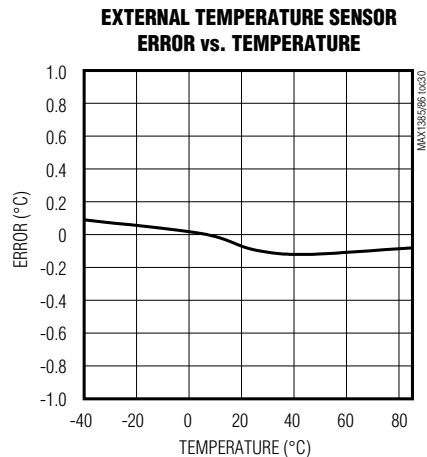
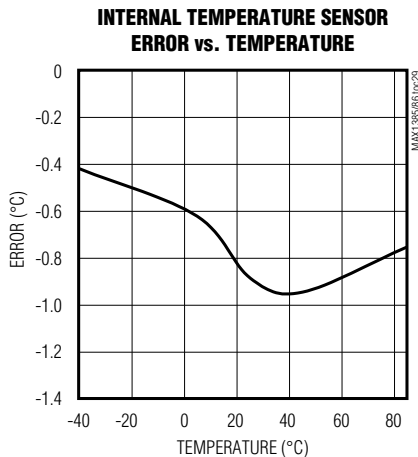
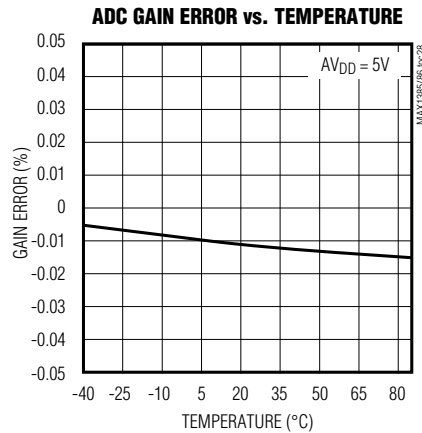
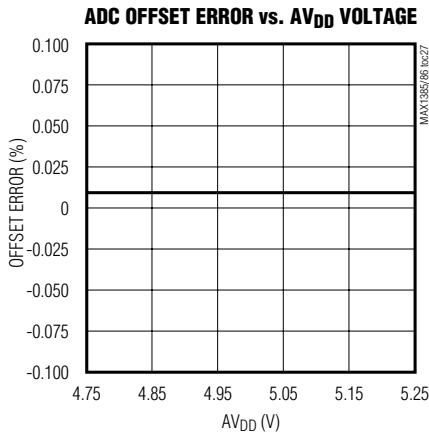
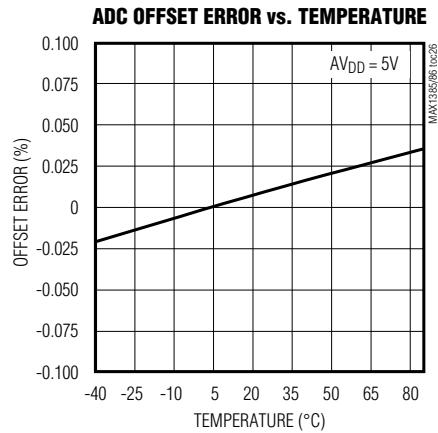
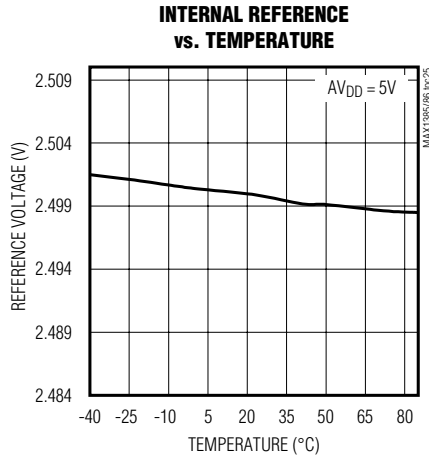

# Dual RF LDMOS Bias Controllers with I<sup>2</sup>C/SPI Interface

## Pin Description

PIN	NAME	FUNCTION
1	DGND	Digital Ground
2	SAFE1	Safe Status Channel 1 Output. Programmable active-high or active-low. SAFE1 asserts when programmed channel 1 temperature threshold or current threshold has been reached.
3	A0/ $\overline{\text{CSB}}$	I <sup>2</sup> C-Compatible Address 0/ SPI-Compatible Chip Select. See the <i>Digital Serial Interface</i> section. In SPI mode, drive A0/ $\overline{\text{CSB}}$ low to select the device.
4	$\overline{\text{CNVST}}$	Active-Low Conversion-Start Input. Drive $\overline{\text{CNVST}}$ low to start a conversion (clock modes 01 and 11). Connect $\overline{\text{CNVST}}$ to DV <sub>DD</sub> when initiating conversions through the serial interface (clock mode 00).
5	SEL	Mode Select. Connect SEL to DGND to select I <sup>2</sup> C mode. Connect SEL to DV <sub>DD</sub> to select SPI mode.
6	ALARM	Alarm Output. Program ALARM for comparator or interrupt output modes (see the <i>Alarm Modes</i> section). Program ALARM to assert on any combination of channel temperature or current thresholds.
7	SAFE2	Safe Status Channel 2 Output. Programmable active-high or active-low. SAFE2 asserts when programmed channel 2 temperature threshold or current threshold has been reached.
8, 19, 25, 28, 35–39, 42, 46	N.C.	No Connection. Not internally connected.
9	REFDAC	DAC Reference Input/Output
10	REFADC	ADC Reference Input/Output
11	DXP1	Diode Positive Input 1. Connect to anode of temperature diode or the base and collector of an npn transistor.
12	DXN1	Diode Negative Input 1. Connect to cathode of temperature diode or the emitter of an npn transistor.
13	DXP2	Diode Positive Input 2. Connect to anode of temperature diode or the base and collector of an npn transistor.
14	DXN2	Diode Negative Input 2. Connect to cathode of temperature diode or the emitter of an npn transistor.
15	ADCIN1	ADC Input 1
16	ADCIN2	ADC Input 2
17	PGAOUT2	Programmable-Gain Amplifier Output 2
18	AV <sub>DD</sub>	Analog Power-Supply Input
20, 21, 22	AGND	Analog Ground

MAX1385/MAX1386

## Dual RF LDMOS Bias Controllers with I<sup>2</sup>C/SPI Interface

### Pin Description (continued)

PIN	NAME	FUNCTION
23	GATEGND	Gate-Drive Amplifier Ground
24	GATEV <sub>DD</sub>	Gate-Drive Amplifier Supply Input
26	OPSAFE2	Operating Safe Channel 2 Input. Drive OPSAFE2 high to clamp GATE2 to AGND.
27	CS2+	Current-Sense Positive Input 2. CS2+ is the external sense resistor connection to the LDMOS 2 supply.
29	CS2-	Current-Sense Negative Input 2. CS2- is the external sense resistor connection to the LDMOS 2 drain.
30	GATE2	Channel 2 Gate-Drive Amplifier Output
31	GATE1	Channel 1 Gate-Drive Amplifier Output
32	CS1-	Current-Sense Negative Input 1. CS1- is the external sense resistor connection to the LDMOS 1 drain.
33	CS1+	Current-Sense Positive Input 1. CS1+ is the external sense resistor connection to the LDMOS 1 supply.
34	OPSAFE1	Operating Safe Channel 1 Input. Drive OPSAFE1 high to clamp GATE1 to AGND.
40	PGAOUT1	Programmable-Gain Amplifier Output 1
41	A2/N.C.	I <sup>2</sup> C-Compatible Address 2. See the <i>Digital Serial Interface</i> section.
		No Connection. Leave unconnected in SPI mode.
43	SCL	Digital Serial Clock Input
44	SDA/DIN	I <sup>2</sup> C-Compatible Serial Data Input/Output
		SPI-Compatible Serial Data Input
45	A1/DOUT	I <sup>2</sup> C-Compatible Address 1. See the <i>Digital Serial Interface</i> section.
		SPI-Compatible Serial Data Output
47	BUSY	Device Busy Output. See the <i>BUSY Output</i> section
48	DV <sub>DD</sub>	Digital Supply Input
—	EP	Exposed Pad. Connect to AGND. Internally connected to analog ground.



# Dual RF LDMOS Bias Controllers with I2C/SPI Interface

## Functional Diagram

MAX1385/MAX1386

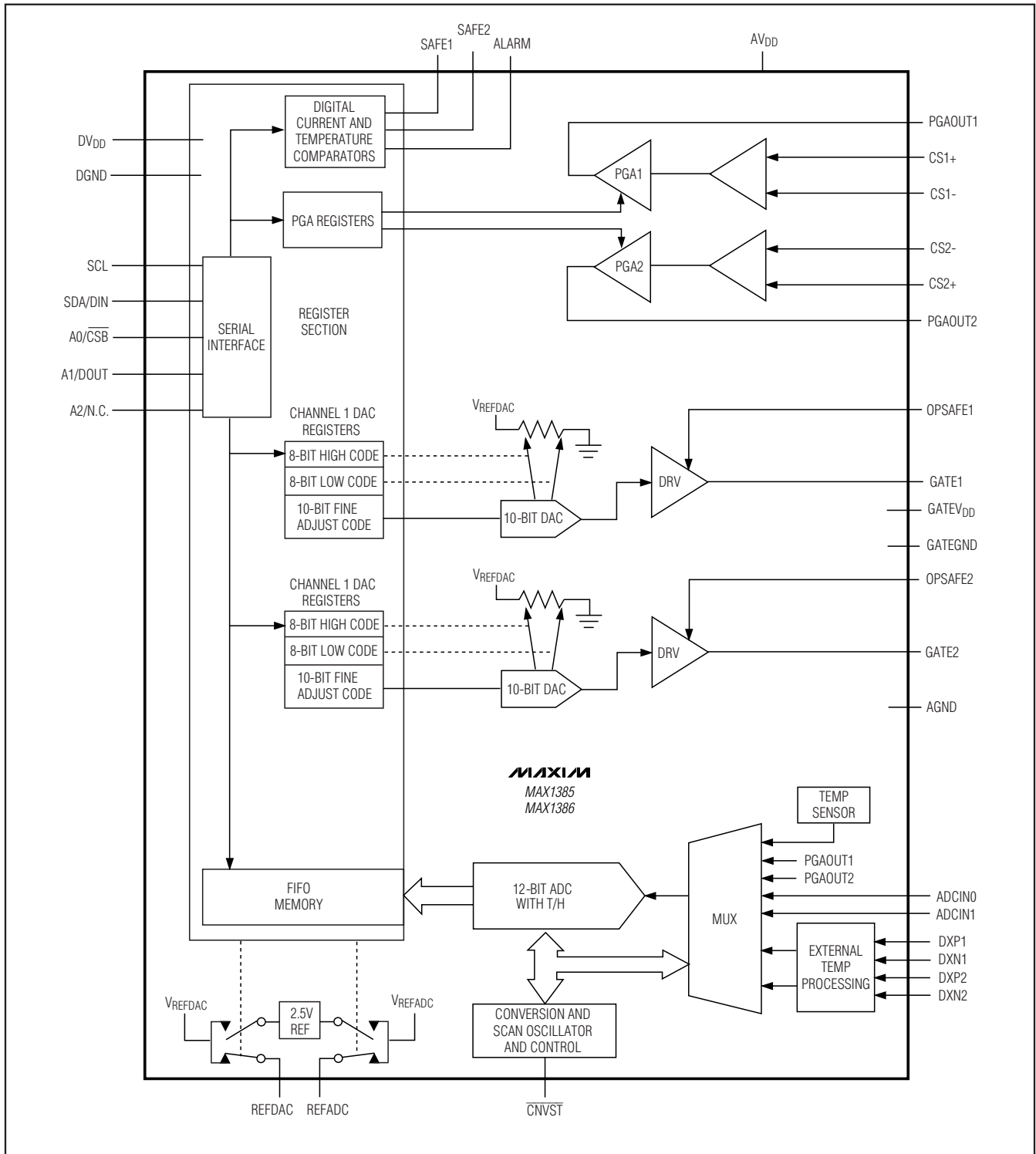

# Dual RF LDMOS Bias Controllers with I<sup>2</sup>C/SPI Interface

## Detailed Description

The MAX1385/MAX1386 set and control bias conditions for dual RF LDMOS power devices found in cellular base stations. Each device includes a high-side current-sense amplifier with programmable gains of 2, 10, and 25 to monitor the LDMOS drain current over the 20mA to 5A range. Two external diode-connected transistors monitor the LDMOS temperatures while an internal temperature sensor measures the local die temperature of the MAX1385/MAX1386. A 12-bit ADC converts the programmable-gain amplifier (PGA) outputs, external/internal temperature readings, and two auxiliary inputs.

The two gate-drive channels, each consisting of 8-bit coarse and 10-bit fine DACs and a gate-drive amplifier, generate a positive gate voltage to bias the LDMOS devices. The MAX1385 includes a gate-drive amplifier with a gain of 2 and the MAX1386 gate-drive amplifier provides a gain of 4. The 8-bit coarse and 10-bit fine DACs allow up to 18 bits of resolution. The MAX1385/MAX1386 include autocalibration modes to minimize error over time, temperature, and supply voltage.

The MAX1385/MAX1386 feature an I<sup>2</sup>C/SPI-compatible serial interface. Both devices operate from a 4.75V to 5.25V analog supply (3.2mA supply current), a 2.7V to 5.25V digital supply (3.1mA supply current), and a 4.75V to 11.0V gate-drive supply (4.5mA supply current).

### Power-On Reset

On power-up, the MAX1385/MAX1386 are in full power-down mode (see the *SSHUT (Write)* section). To change to normal power mode, write two commands to the Software Shutdown register. The first command sets FULLPD to 0 (other bits in the Software Shutdown register are ignored). A second command is needed to activate any internal blocks. The recommended sequence of commands to ensure reliable startup following the application of power, is given in the *Appendix: Recommended Power-Up Code Sequence* section.

### ADC Description

The MAX1385/MAX1386 ADC uses a fully differential successive approximation register (SAR) conversion technique and on-chip track-and-hold (T/H) circuitry to convert temperature and voltage signals into 12-bit digital results. The analog inputs accept single-ended input signals. Single-ended signals are converted using a unipolar transfer function. See the ADC transfer function of Figure 25 for more information.

The internal ADC block converts the results of the die temperature, remote diode temperature readings, PGAOUT1, PGAOUT2, ADCIN1, or ADCIN2 voltages according to which bits are set in the ADC Conversion register (see the *ADCCON (Write)* section). The results of the conversions are written to FIFO memory. The FIFO holds up to 15 words (each word is 16 bits) with channel tags to indicate which channel the 12-bit data comes from. The FIFO indicates an overflow condition and an underflow condition (read of an empty FIFO) by the Flag register (see the *RDFLAG (Read)* section) and channel tags. The FIFO always stores the most recent conversion results and allows the oldest data to be overwritten. Read the latest result stored in the FIFO by sending the appropriate read command byte (see the *FIFO (Read)* section).

Read the data stored in the FIFO through the FIFO Read register. The *FIFO (Read)* section details which channel is being read and whether the FIFO has overflowed.

### Analog-to-Digital Conversion Scheduling

The MAX1385/MAX1386 ADC multiplexer scans selected inputs in the order shown in Table 1. The ADC multiplexer skips over the items that are not selected in the Analog-to-Digital Conversion register. When writing a conversion command before a conversion is complete, the pending conversion may be canceled. In addition, using the serial interface while the ADC is converting may degrade the performance of the ADC.

### ADC Clock Modes

The MAX1385/MAX1386 offer three different conversion/acquisition modes (known as clock modes) selectable through the Device Configuration register (see the *DCFIG (Read/Write)* section). Clock Mode 10 is reserved and cannot be used. For conversion/acquisition examples and timing diagrams, see the *Applications Information* section.

If the analog-to-digital conversion requires the internal reference (temperature measurement or voltage measurement with internal reference selected) and the reference has not been previously forced on, the device inserts a worst-case delay of 81μs, for the reference to settle, before commencing the analog-to-digital conversion. The reference remains powered up while there are pending conversions. If the reference is not forced on, it automatically powers down at the end of a scan or when CONCONV in the Analog-to-Digital Conversion register is set back to 0.

## Dual RF LDMOS Bias Controllers with I<sup>2</sup>C/SPI Interface

### Clock Mode 00

In clock mode 00, power-up, acquisition, conversion, and power-down are all initiated by writing to the Analog-to-Digital Conversion register and performed automatically using the internal oscillator. This is the default clock mode. The ADC sets the BUSY output high, powers up, scans all requested channels, stores the results in the FIFO, and then powers down. After the scan is complete, BUSY is pulled low and the results for all the commanded channels are available in the FIFO.

### Clock Mode 01

In clock mode 01, power-up, acquisition, conversion, and power-down are all initiated by setting  $\overline{\text{CNVST}}$  low for at least 40ns. Conversions are performed automatically using the internal oscillator. The ADC sets the BUSY output high, powers up, scans all requested channels, stores the results in the FIFO, and then powers down. After the scan is complete, BUSY is pulled low and the results for all the commanded channels are available in the FIFO.

### Clock Mode 11

In clock mode 11, conversions are initiated one at a time through  $\overline{\text{CNVST}}$  in the order shown in Table 1 and performed using the internal oscillator. In this mode, the acquisition time is controlled by the time  $\overline{\text{CNVST}}$  is brought low.  $\overline{\text{CNVST}}$  is resynchronized by the internal oscillator, which means there is a one-clock-cycle uncertainty (typically 320ns) in the exact sampling instant. Different timing parameters apply depending whether the conversion is temperature, voltage, using the external reference, or using the internal reference.

**Table 1. Order of ADC Conversion Scan**

ORDER OF SCAN	DESCRIPTION OF CONVERSION
1	Internal device temperature
2	External diode 1 temperature
3	PGAOUT1 for current sense
4	ADCIN1
5	External diode 2 temperature
6	PGAOUT2 for current sense
7	ADCIN2

For a temperature conversion, set  $\overline{\text{CNVST}}$  low for at least 40ns. The BUSY output goes high and the temperature conversion results are available after an additional 94 $\mu$ s (when BUSY goes low again). Thus, the worst-case conversion time of the initial temperature sensor scan (allowing the internal reference to settle) is 175 $\mu$ s. Subsequent temperature scans only take 85 $\mu$ s worst case as the internal reference and temperature sensor circuits are already powered.

For a voltage conversion while using an internal or external reference, set  $\overline{\text{CNVST}}$  low for at least 2 $\mu$ s but less than 6.7 $\mu$ s. The BUSY output goes high and the conversion results are available after an additional 7.5 $\mu$ s (typ) when BUSY goes low again.

Continuous conversion is not supported in this clock mode (see the *ADCCON (Write)* section).

### Changing Clock Modes During ADC Conversions

If a change is made to the clock mode in the Device Configuration register while the ADC is already performing a conversion (or series of conversions), the following descriptions show how the MAX1385/MAX1386 respond:

- **CKSEL = 00 and is then changed to another value**

The ADC completes the already triggered series of conversions and then goes idle. The BUSY output remains high until the conversions are completed. The MAX1385/MAX1386 then respond in accordance with the new CKSEL mode.

- **CKSEL = 01 and is then changed to another value**

If waiting for the initial external trigger, the MAX1385/MAX1386 immediately exit clock mode 01, power down the ADC, and go idle. The BUSY output stays low and waits for the external trigger. If a conversion sequence has started, the ADC completes the requested conversions and then goes idle. The BUSY output remains high until the conversions are completed. The MAX1385/MAX1386 then respond in accordance with the new CKSEL mode.

- **CKSEL = 11 and is then changed to another value**

If waiting for an external trigger, the MAX1385/MAX1386 immediately exit clock mode 11, power down the ADC, and go idle. The BUSY output stays low and waits for the external trigger.

## Dual RF LDMOS Bias Controllers with I<sup>2</sup>C/SPI Interface

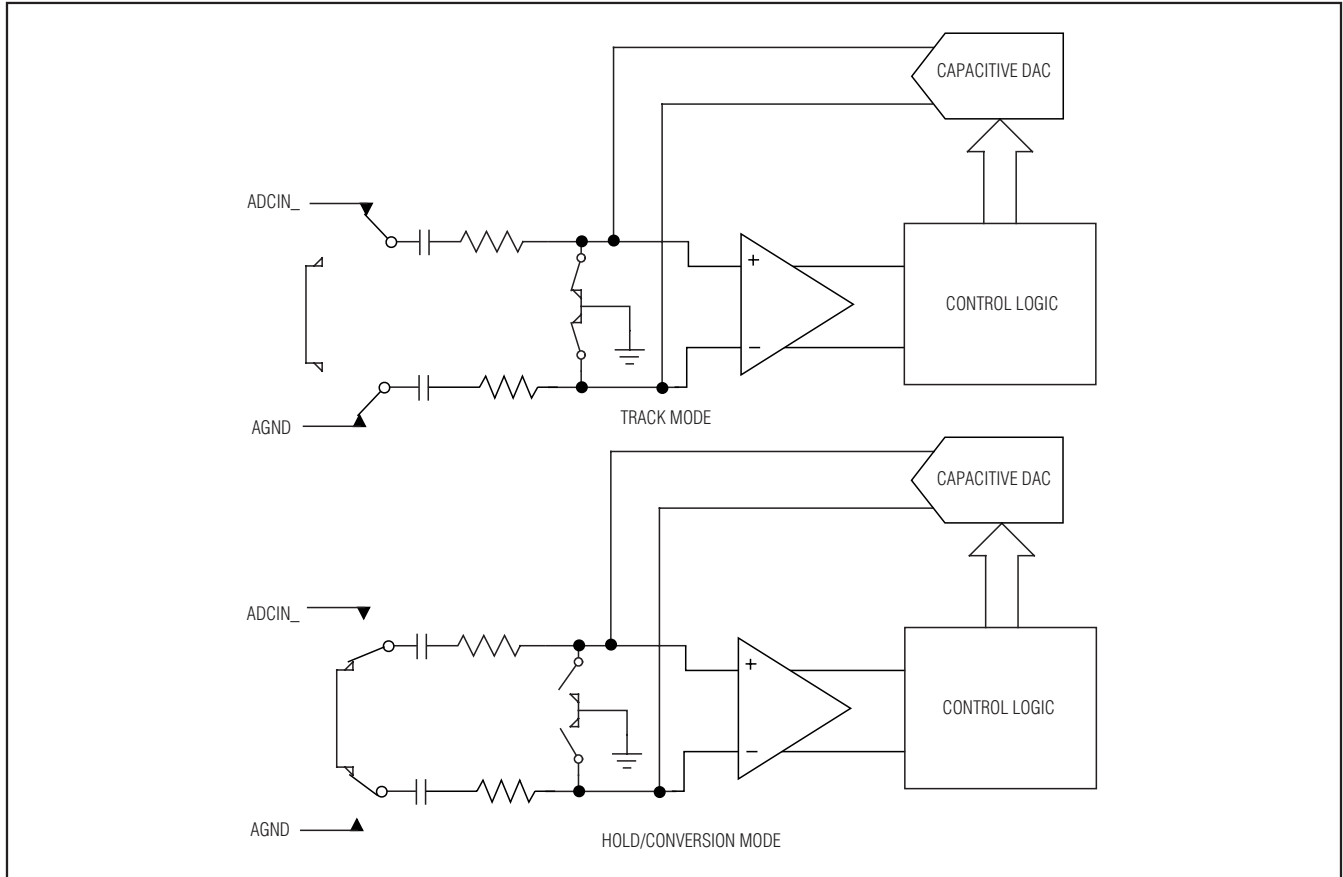

Figure 4. Equivalent ADC Input Circuit

### Analog Input Track and Hold

The equivalent circuit (Figure 4) shows the MAX1385/MAX1386 ADC input architecture. In track mode, a positive input capacitor is connected to ADCIN\_ and a negative input capacitor is connected to AGND. After the T/H enters hold mode, the difference between the sampled positive and negative input voltages is converted. The input capacitance charging rate determines the time required for the T/H to acquire an input signal. If the input signal's source impedance is high, the required acquisition time lengthens.

Any source impedance below 300Ω does not significantly affect the ADC's AC performance. A high-imped-

ance source can be accommodated either by lengthening  $t_{ACQ}$  or by placing a 1μF capacitor between the positive input and AGND. The combination of the analog input source impedance and the capacitance at the analog input creates an RC filter that limits the analog input bandwidth.

### Analog-Input Bandwidth

The ADC's input-tracking circuitry has a 10MHz bandwidth to digitize high-speed transient events. Anti-alias prefiltering of the input signals is necessary to avoid high-frequency signals aliasing into the frequency band of interest.

# Dual RF LDMOS Bias Controllers with I<sup>2</sup>C/SPI Interface

## Analog-Input Protection

Internal ESD protection diodes clamp all analog inputs to AV<sub>DD</sub> and AGND, allowing the inputs to swing from AGND - 0.3V to AV<sub>DD</sub> + 0.3V without damage. If an analog input voltage exceeds the supplies, limit the input current to 2mA.

## DAC Description

The MAX1385/MAX1386 include two 8-bit and 10-bit DAC blocks to independently control the voltage on each LDMOS gate. Both 10-bit and 8-bit DACs can be automatically calibrated to minimize output error over time, temperature, and supply voltage. The 8-bit and 10-bit DACs have unipolar transfer functions and have a relationship to the output voltage by the following equation:

$$V_{DACOUT} = \frac{V_{REF}}{2^8} \times LOCODE + \frac{V_{REF}}{2^8} \times [HICODE - LOCODE] \times \frac{FINECODE}{2^{10}}$$

where LOCODE, HICODE, and FINECODE are the low wiper (8 bits), high wiper (8 bits), and fine DAC (10 bits) values written to the DAC by the user. LOCODE, HICODE, and FINECODE represent the values in the DAC input registers and may or may not be the actual values in the DAC output registers depending whether autocalibration is used or not (see the 8-Bit Coarse-DAC Adjustment section). To find the actual voltage at GATE\_, multiply the V<sub>DACOUT</sub> result by 2 (MAX1385) or 4 (MAX1386). Due to the buffer amplifiers, the voltage at GATE\_ cannot be set below 100mV above AGND. It is recommended that the LOCODE for DAC1 and DAC2 are set so that the minimum possible output at GATE\_ is 200mV (MAX1385) and 400mV (MAX1386).

The DACs can be operated to produce an 18-bit monotonic DAC with 12-bit (typ) INL. Write to either HICODE or LOCODE in a leapfrog fashion, without commanding autocalibration, to configure the 18-bit monotonic DAC. When LOCODE > HICODE, invert the value of FINECODE.

## 8-Bit Coarse-DAC Adjustment

Each DAC control block contains a resistor string with wipers that serve as an 8-bit coarse DAC. Wipers are set by writing to the appropriate DAC input registers and/or using the Load DAC Control register (LDAC)

commands. The output of a coarse DAC is not updated until the appropriate DAC output register(s) have been set. See Figure 5 for the relationship between DAC input registers, DAC output registers, and wipers.

DAC output registers are not directly accessible to the user. Choose which input register to write to based on whether automatic low or high calibration is desired, or if updates to the output of the DAC need to be initiated immediately. In the case of automatic low or high calibration, a correction code is added to or subtracted from the 10-bit fine-DAC input register. Transfers from the DAC input registers to DAC output registers can occur immediately after a write to the appropriate DAC input register or on a software command through the Software LDAC register. See the *Register Descriptions* section for bit-level descriptions of these registers.

## 10-Bit Fine-DAC Adjustment

Each DAC control block contains a 10-bit fine DAC that operates between the high and low wiper positions from the 8-bit coarse DAC. The 10-bit fine DAC also has an optional automatic calibration mode and can be updated immediately or on a software-issued command in the Software LDAC register. Writing to the appropriate fine-DAC input register determines whether automatic calibration is used and/or when the DAC is updated. See Figure 6 for the relationship between DAC input registers, DAC output registers, and the Software LDAC register.

The fine-DAC output registers are not directly accessible. Choose which DAC input register to write to based on whether automatic fine calibration is desired, or whether updates to the output of the DAC need to be initiated immediately. In the case of automatic fine calibration, a correction code is added to or subtracted from the input register code and transferred to the appropriate fine-DAC output register. Transfers from a fine-DAC input register to a fine-DAC output register can occur immediately after a write to the appropriate DAC input register or on a software command through the Software LDAC register. See the *Register Descriptions* section for bit-level detail of these registers.

# Dual RF LDMOS Bias Controllers with I2C/SPI Interface

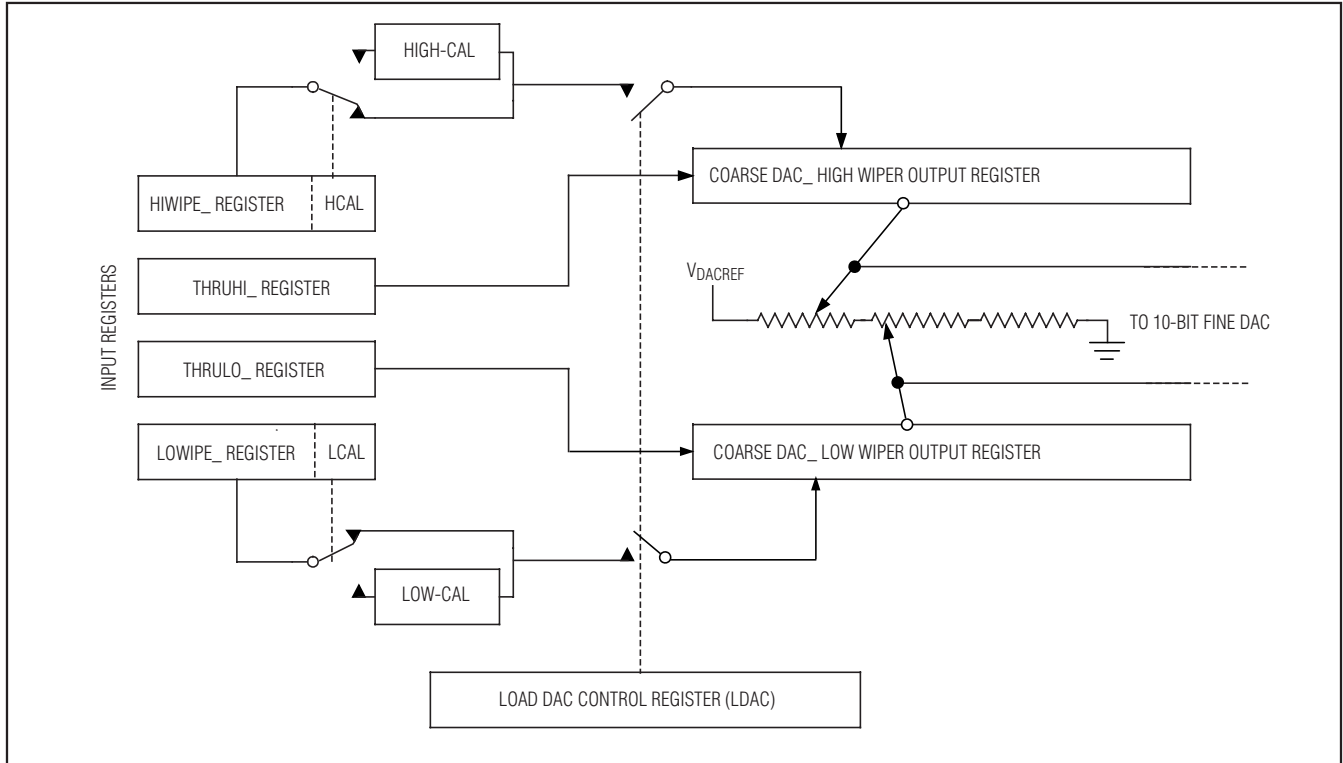

Figure 5. Coarse-DAC Register Diagram

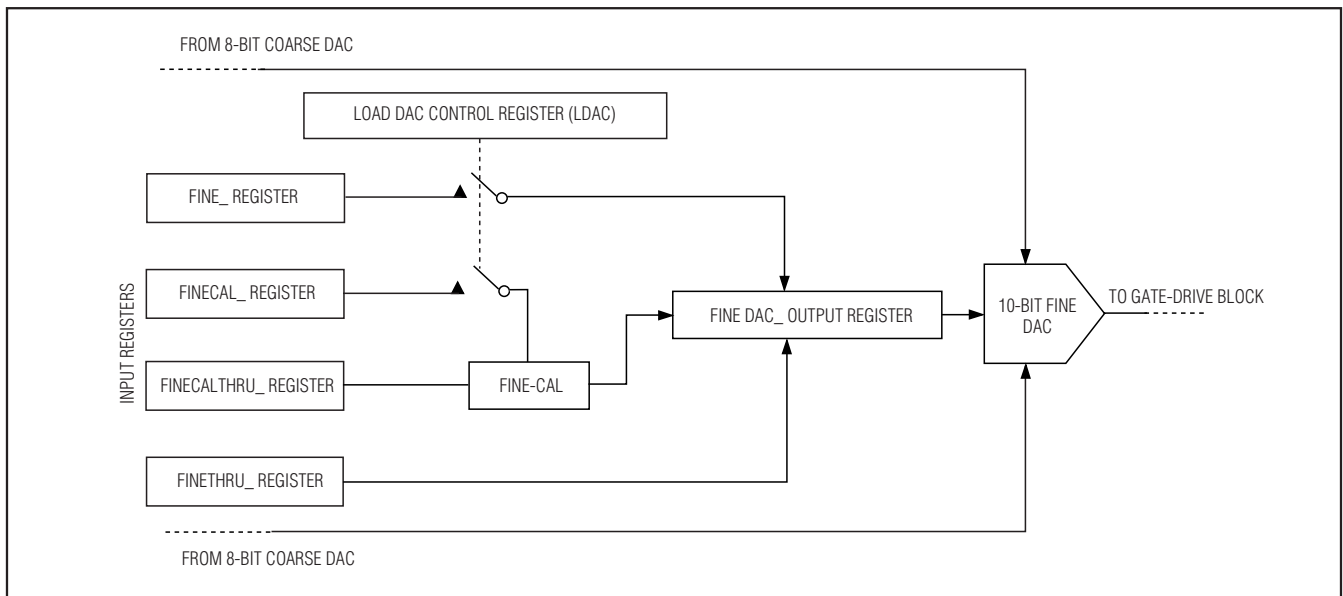

Figure 6. Fine-DAC Register Diagram

# Dual RF LDMOS Bias Controllers with I<sup>2</sup>C/SPI Interface

## ADC/DAC References

The MAX1385/MAX1386 provide an internal low-noise 2.5V reference for the ADCs, DACs, and temperature sensor. See the *Device Configuration Register* section for information on configuring the device for external or internal reference. Connect a voltage source to REFADC in the 1V to AV<sub>DD</sub> range when using an external ADC reference. Connect a voltage source to REF-DAC in the 0.5V to 2.5V range when using an external DAC reference. When using an external voltage reference, bypass the reference pin with a 0.1μF capacitor to AGND.

The internal reference has a lowpass filter to reduce noise. The device allows 60μs (typ) and 81μs (typ) worst case for the reference to settle before permitting an analog-to-digital conversion. If reference mode 11 is selected, the required settling time is longer. In this case, the user should set at least one of DAC1PD, DAC2PD, or FBGON in the Software Shutdown register, any of which forces the reference to be permanently powered up.

## Temperature Measurements

The MAX1385/MAX1386 measure the internal die temperature and two external remote-diode temperature sensors. Set up a temperature conversion by writing to the Analog-to-Digital Conversion register (see the *ADCCON (Write)* section). Optionally program SAFE1 and SAFE2 outputs to depend on programmed temperature thresholds.

The MAX1385/MAX1386 can perform temperature measurements with an internal diode-connected transistor. The diode bias current changes from 66μA to 4μA to produce a temperature-dependent bias voltage difference. The second conversion result at 4μA is subtracted from the first at 66μA to calculate a digital value that is proportional to the absolute temperature. The stored data result is the aforementioned digital code minus an offset to adjust from Kelvin to Celsius.

The reference voltage for the temperature measurements is always derived from the internal reference source. Temperature results are in degrees Celsius (two's-complement form).

The temperature-sensing circuits power up for the first temperature measurement in an analog-to-digital conversion scan. The temperature-sensing circuits remain powered until the end of the scan to avoid a possible 67μs delay of internal reference power-up time for each individual temperature channel. If the continuous convert bit CONCONV is set high and the current ADC channel selection includes a temperature channel, the temperature-sensor circuits remain powered up until the CONCONV bit is set low.

The external temperature-sensor drive current ratio has been optimized for a 2N3904 npn transistor with an ideality factor of 1.0065. The nonideality offset is removed internally by a preset digital coefficient. Use of a transistor with a different ideality factor produces a proportionate difference in the absolute measured temperature. More details on this topic and others related to using an external temperature sensor can be found in Maxim Application Note 1057: *Compensating for Ideality and Series Resistance Differences Between Thermal Sense Diodes* and Application Note 1944: *Temperature Monitoring Using the MAX1253/MAX1254 and MAX1153/MAX1154*.

## High-Side Current-Sense PGAs

The MAX1385/MAX1386 provide two high-side current-sense amplifiers with programmable gain. The current-sense amplifiers are unidirectional and provide a 5V to 30V input common-mode range. Both CS1+ and CS2+ must be within the specified common-mode range for proper operation of each amplifier.

The sense amplifiers measure the load current, I<sub>LOAD</sub>, through an external sense resistor, R<sub>SENSE\_</sub>, between the CS<sub>+</sub> and CS<sub>-</sub> inputs. The full-scale sense voltage range (V<sub>SENSE\_</sub> = V<sub>CS+</sub> - V<sub>CS-</sub>) depends on the programmed gain, A<sub>VPGA\_</sub> (see the *DCFIG (Read/Write)* section). The sense amplifiers provide a voltage output at PGAOUT<sub>-</sub> according to the following equation:

$$V_{PGAOUT\_} = A_{VPGA\_} \times (V_{CS\_+} - V_{CS\_ -})$$

These outputs are also routed to the internal 12-bit ADC so that a digital representation of the amplified voltages can be read through the FIFO.

The PGA scales the sensed voltages to fit the input range of the ADC. Program the PGA with gains of 2, 10, and 25 by setting the PGSET<sub>-</sub> bits (see the *DCFIG (Read/Write)* section). The input stages have nominal input offset voltages of 0mV that can be adjusted by a trim DAC (not shown in the *Functional Diagram*) over the -3mV to +3mV range in 25μV steps. Autocalibration can be used to control the trim DAC to minimize the effective channel input offset voltage (see the *PGACAL (Write)* section). The PGA feedback network is referenced to AGND.

## ALARM Output

The state of ALARM is logically equivalent to the inclusive OR of SAFE1 and SAFE2. The exception to this statement is when ALARM is configured for output interrupt mode (see the *Alarm Modes* section). When in output-interrupt mode, ALARM stays in its asserted state until its associated flag is cleared by reading from the

# Dual RF LDMOS Bias Controllers with I<sup>2</sup>C/SPI Interface

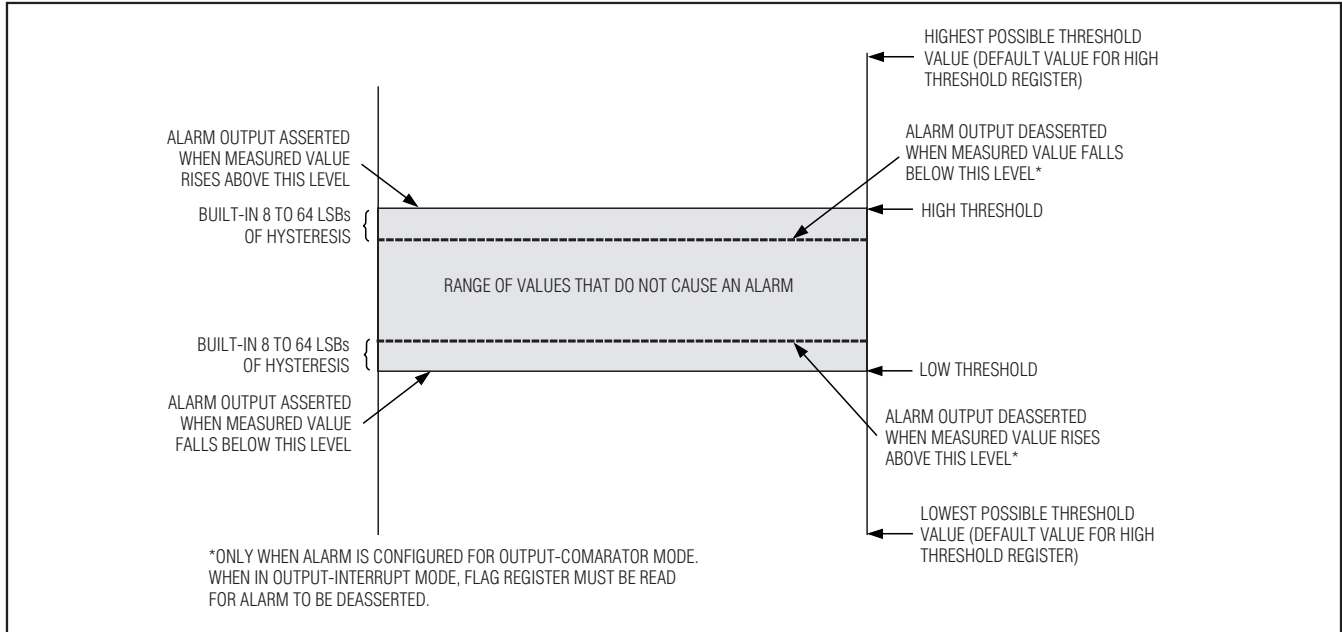

Figure 7. Window-Threshold-Mode Diagram

Flag register. Configure ALARM for open-drain/push-pull and active-high/active-low by setting the respective bits in the Hardware Alarm Configuration register.

### SAFE1/SAFE2 Outputs

Set up the SAFE1 and SAFE2 outputs to allow Wired-OR/AND-type logic functions or to create additional interrupt-type signals to replace or supplement the existing ALARM output. SAFE1 and SAFE2 do not have any internal pullup/pulldown devices.

The SAFE1 and SAFE2 output buffers are CMOS-compatible, noninverting, output buffers capable of driving to within 0.5V of either digital rail. The SAFE1 and SAFE2 outputs power up as active-high CMOS outputs with standard logic levels. Configure the SAFE1 and SAFE2 outputs for open-drain or push-pull by setting the appropriate bits in the Hardware Alarm Configuration register. When configuring SAFE1 and SAFE2 as open-drain outputs, an external pullup resistor is required.

### BUSY Output

The BUSY output is forced high to show that the MAX1385/MAX1386 are busy for a variety of reasons:

- The ADC is in the middle of a user-commanded conversion cycle (but not in continuous convert mode)
- The ADC is in the middle of an internally triggered conversion cycle (for a self-calibration measurement)
- The device is in the middle of DAC calibration calculations
- The device is in the middle of power-up initialization
- One of the PGA channels is undergoing self-calibration

The serial interface remains active regardless of the state of the BUSY output. Wait until BUSY goes low to read the current conversion data from the FIFO. When BUSY is high as a result of an ADC conversion, do not enter a second conversion command until BUSY has gone low to indicate the previous conversion is complete. The rising edge of BUSY occurs on the next internal oscillator clock after the start of a new conversion (either by  $\overline{\text{CNVST}}$  or an interface command).



# Dual RF LDMOS Bias Controllers with I<sup>2</sup>C/SPI Interface

MAX1385/MAX1386

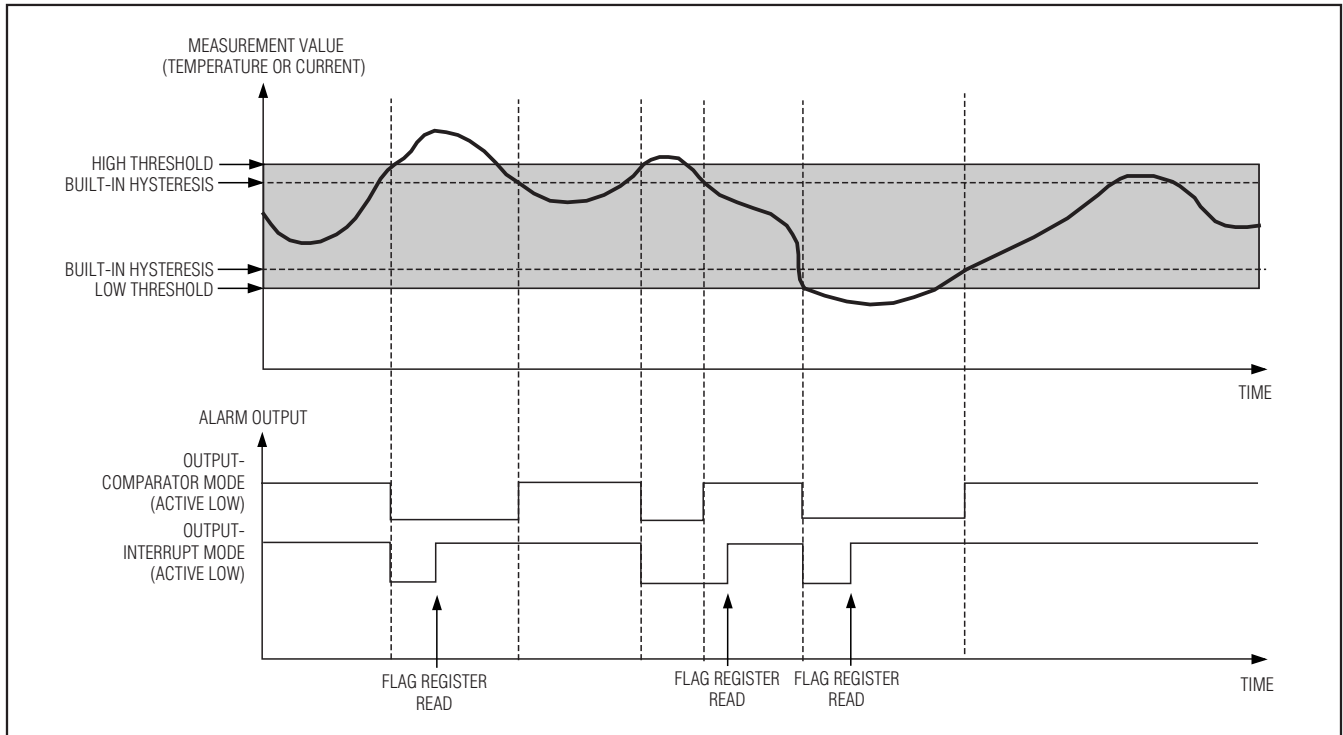

Figure 8. Window-Threshold-Mode Timing Diagram

In single-conversion mode (CKSEL = 11), the BUSY signal remains high until the ADC has completed the current conversion (not the entire scan, just the current conversion), the data has been moved into the FIFO, and the alarm limits for the channel have been checked (if enabled). In multiple-conversion mode (CKSEL = 01 or CKSEL = 00), the BUSY signal remains high until all channels have been scanned and the data from the final channel has been moved into the FIFO and checked for alarm limits (if enabled). In continuous-conversion mode (CONCONV = 1), the BUSY signal does not go high as a result of ADC conversions; however, BUSY does go high when CONCONV is removed and remains high until the current scan is complete and the ADC sequence halts.

After commanding any of the DAC autocalibration components, wait for BUSY to go low before setting OSCPD to 1.

### Alarm Modes

The MAX1385/MAX1386 contain several programmable modes for configuring outputs ALARM, SAFE1, and SAFE2 behavior. Window-threshold mode allows SAFE\_ to assert when the temperature/current is too high or too low (outside the window). Hysteresis-threshold mode allows SAFE\_ to assert when the temperature/

current is too high, and then to deassert when the temperature/current falls back to an appropriate level. ALARM asserts when SAFE1 and/or SAFE2 asserts. Program ALARM for output-comparator mode to stay asserted after an alarm condition until temperature/current levels are back below programmed thresholds. Program ALARM for output-interrupt mode to stay asserted after an alarm condition until the Flag register is read.

### Window-Threshold Mode

In window-threshold mode, ADC readings of current/temperature are compared to the configured current/temperature low/high thresholds that are programmed to cause an alarm condition. If an ADC reading falls out of the configured window and ALARM is configured for output-comparator mode, ALARM asserts until the current/temperature reading falls back into the window (past the built-in hysteresis). If an ADC reading falls out of the configured window and ALARM is configured for output-interrupt mode, ALARM asserts until the Flag register is read. Set the amount of built-in hysteresis from 8 LSBs to 64 LSBs (see the *ALMSCFG (Read/Write)* section). See Figures 7 and 8.

# Dual RF LDMOS Bias Controllers with I<sup>2</sup>C/SPI Interface

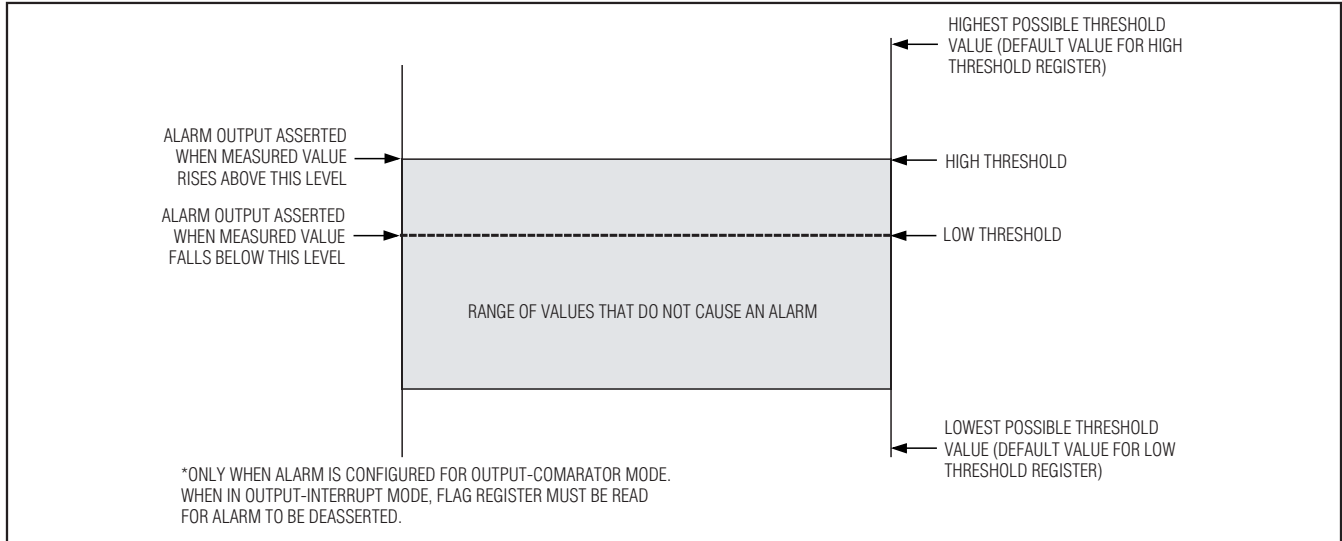

Figure 9. Hysteresis-Threshold-Mode Diagram

### Hysteresis-Threshold Mode

In hysteresis-threshold mode, ADC readings of current/temperature are compared to the configured current/temperature low/high thresholds that are programmed to cause an alarm condition. If an ADC reading exceeds its respective configured threshold and ALARM is configured for output-comparator mode, ALARM asserts until the current/temperature reading falls back below its respective threshold. If an ADC reading exceeds its respective configured threshold and ALARM is configured for output-interrupt mode, ALARM asserts until the Flag register is read. See Figures 9 and 10.

### Register Descriptions

Communicate with the MAX1385/MAX1386 through the I<sup>2</sup>C/SPI-compatible serial interface. Complete read and write operations consist of slave address bytes, command bytes, and data bytes. The following register descriptions cover the contents of command bytes and data bytes. See the *Digital Serial Interface* section for a detailed description of how to construct full read and write operations. All registers are volatile and are reset to default states upon removal of power. These default states are referred to as power-on reset (POR) states. All accessible MAX1385/MAX1386 registers are shown in Table 2.

### TH1 and TH2 (Read/Write)

Write to Channel 1 and Channel 2 High Temperature Threshold registers by sending the appropriate write command byte followed by data bits D15–D0 (see Table 3). Bits D15–D12 are don't care. Read channel 1 and channel 2 high-temperature thresholds by sending the appropriate read command byte. Channel 1 and Channel 2 Temperature Threshold registers are compared to temperature readings from the remote diode connected transistors. Temperature data is in two's-complement format and the LSB corresponds to 1/8°C (see Figure 26 for the Temperature Transfer Function).

### TL1 and TL2 (Read/Write)

Write to Channel 1 and Channel 2 Low-Temperature-Threshold registers by sending the appropriate write command byte followed by data bits D15–D0 (see Table 4). Bits D15–D12 are don't care. Read channel 1 and channel 2 low-temperature thresholds by sending the appropriate read command. Channel 1 and Channel 2 Temperature Threshold registers are compared to temperature readings from the remote diode connected transistors. Temperature data is in two's-complement format and the LSB corresponds to 1/8°C (see Figure 26 for the Temperature Transfer Function).

# Dual RF LDMOS Bias Controllers with I<sup>2</sup>C/SPI Interface

MAX1385/MAX1386

**Table 2. Register Listing (See Appendix: Recommended Power-Up Code Sequence section)**

REGISTER DESCRIPTION	MNEMONIC	HEX COMMAND	
		WRITE	READ
Analog-to-Digital Conversion	ADCCON	62	—
Channel 1 High-Current Threshold	IH1	24	A4
Channel 1 High-Temperature Threshold	TH1	20	A0
Channel 1 Low-Current Threshold	IL1	26	A6
Channel 1 Low-Temperature Threshold	TL1	22	A2
Channel 2 High-Current Threshold	IH2	2C	AC
Channel 2 High-Temperature Threshold	TH2	28	A8
Channel 2 Low-Current Threshold	IL2	2E	AE
Channel 2 Low-Temperature Threshold	TL2	2A	AA
Coarse DAC1 High Wiper Input	HIWIPE1	34	B4
Coarse DAC1 Low Wiper Input	LOWIPE1	36	B6
Coarse DAC1 Write-Through High Wiper Input	THRUHI1	74	B4
Coarse DAC1 Write-Through Low Wiper Input	THRULO1	76	B6
Coarse DAC2 High Wiper Input	HIWIPE2	3A	BA
Coarse DAC2 Low Wiper Input	LOWIPE2	3C	BC
Coarse DAC2 Write-Through High Wiper Input	THRUHI2	7A	BA
Coarse DAC2 Write-Through Low Wiper Input	THRULO2	7C	BC
Device Configuration	DCFIG	30	B0
FIFO Memory	FIFO	—	80
Fine DAC1 Input Read	RDFINE1	—	B8
Fine DAC1 Input Register with Autocalibration	FINECAL1	38	—
Fine DAC1 Input Without Autocalibration	FINE1	50	—
Fine DAC1 Write-Through Input with Autocalibration	FINECALTHRU1	78	—
Fine DAC1 Write-Through Input Without Autocalibration	FINETHRU1	52	—
Fine DAC2 Input Read	RDFINE2	—	BE
Fine DAC2 Input Register with Autocalibration	FINECAL2	3E	—
Fine DAC2 Input Without Autocalibration	FINE2	54	—
Fine DAC2 Write-Through Input with Autocalibration	FINECALTHRU2	7E	—
Fine DAC2 Write-Through Input Without Autocalibration	FINETHRU2	56	—
Flag	RDFLAG	—	EA
Hardware Alarm Configuration	ALMHCFG	60	E0
PGA Calibration Control	PGACAL	4E	—
Software Clear	SCLR	68	—
Software LDAC	LDAC	66	—
Software Shutdown	SSHUT	64	—
Software Alarm Configuration	ALMSCFG	32	B2

# Dual RF LDMOS Bias Controllers with I2C/SPI Interface

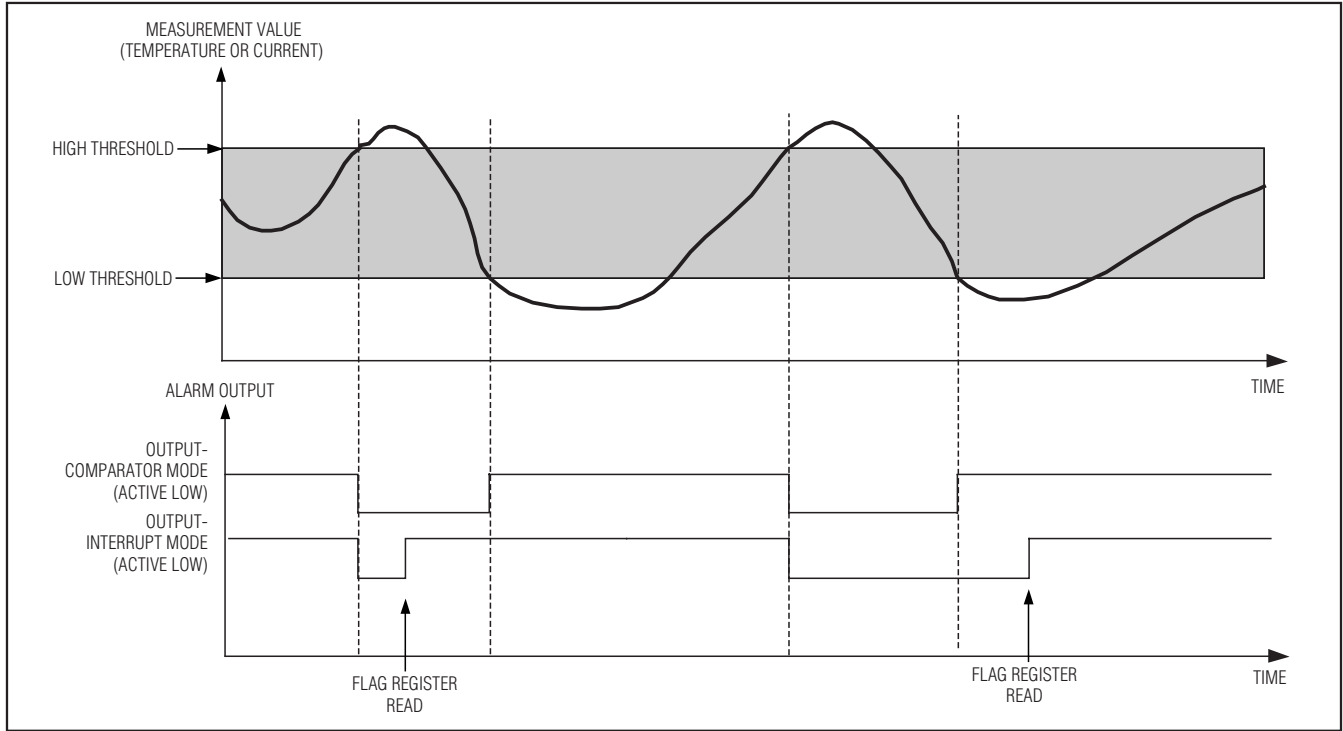

Figure 10. Hysteresis-Threshold-Mode Timing Diagram

Table 3. TH1 and TH2 (Read/Write)

	D15	D14	D13	D12	D11 (MSB)	D10	D9	D8	D7	D6	D5	D4	D3	D2	D1	D0 (LSB)
POR	X	X	X	X	0	1	1	1	1	1	1	1	1	1	1	1
Bit Value (°C)	X	X	X	X	-256	+128	+64	+32	+16	+8	+4	+2	+1	+0.5	+0.25	+0.125

X = Don't care.

### IH1 and IH2 (Read/Write)

Write to Channel 1 and Channel 2 High-Current-Threshold registers by sending the appropriate write command byte followed by data bits D15–D0 (see Table 5). Bits D15–D12 are don't care. Read channel 1 and channel 2 high-current thresholds by sending the appropriate read command byte. Channel 1 and Channel 2 Current-Threshold registers are compared to ADC readings at PGAOUT1 and PGAOUT2. Use the following equation to find the required threshold code for a specified threshold current:

$$I_{THRESH} = I_{DRAIN} \times R_{SENSE} \times A_{VPGA} \times \frac{4096}{V_{REFADC}}$$

where  $I_{DRAIN}$  is the current threshold in amperes,  $R_{SENSE}$  is the sense resistor,  $A_{VPGA}$  is the voltage gain of the PGA,  $V_{REFADC}$  is the ADC reference voltage, and  $I_{THRESH}$  is the resulting threshold register value in decimal.

### IL1 and IL2 (Read/Write)

Write to Channel 1 and Channel 2 Low-Current-Threshold registers by sending the appropriate write command byte followed by data bits D15–D0 (see Table 6). Bits D15–D12 are don't care. Read channel 1 and channel 2 low-current thresholds by sending the appropriate read command byte. Channel 1 and Channel 2 Low-Current Threshold registers are compared to ADC readings at PGAOUT1 and PGAOUT2.

# Dual RF LDMOS Bias Controllers with I<sup>2</sup>C/SPI Interface

**Table 4. TL1 and TL2 (Read/Write)**

	D15	D14	D13	D12	D11 (MSB)	D10	D9	D8	D7	D6	D5	D4	D3	D2	D1	D0 (LSB)
POR	X	X	X	X	1	0	0	0	0	0	0	0	0	0	0	0
Bit Value (°C)	X	X	X	X	-256	+128	+64	+32	+16	+8	+4	+2	+1	+0.5	+0.25	+0.125

X = Don't care.

**Table 5. IH1 and IH2 (Read/Write)**

	D15	D14	D13	D12	D11 (MSB)	D10	D9	D8	D7	D6	D5	D4	D3	D2	D1	D0 (LSB)
POR	X	X	X	X	1	1	1	1	1	1	1	1	1	1	1	1
Bit Value	X	X	X	X	—	—	—	—	—	—	—	—	—	—	—	—

X = Don't care.

**Table 6. IL1 and IL2 (Read/Write)**

	D15	D14	D13	D12	D11 (MSB)	D10	D9	D8	D7	D6	D5	D4	D3	D2	D1	D0 (LSB)
POR	X	X	X	X	0	0	0	0	0	0	0	0	0	0	0	0
Bit Value	X	X	X	X	—	—	—	—	—	—	—	—	—	—	—	—

X = Don't care.

Use the following equation to find the required threshold code for a specified threshold current:

$$I_{\text{THRESH}} = I_{\text{DRAIN}} \times R_{\text{SENSE}} \times A_{\text{VPGA}} \times \frac{4096}{V_{\text{REFADC}}}$$

where  $I_{\text{DRAIN}}$  is the current threshold in amperes,  $R_{\text{SENSE}}$  is the sense resistor,  $A_{\text{VPGA}}$  is the voltage gain of the PGA,  $V_{\text{REFADC}}$  is the ADC reference voltage, and  $I_{\text{THRESH}}$  is the resulting threshold register value in decimal.

### DCFIG (Read/Write)

Select PGA gain settings, clock modes, and DAC and ADC reference modes by sending the appropriate write command byte followed by data bits D15–D0 (see Table 7). Bits D15–D10 are don't care. Read the Device Configuration register by sending the appropriate read command byte. Program PG2SET1 and PG2SET0 to set channel 2's current-sense amplifier gain (see Table 7a). Program PG1SET1 and PG1SET0 to set channel 1's current-sense amplifier gain (see Table 7a). Set CKSEL1 and CKSEL0 to determine the conversion and acquisition timing clock modes (see Table 7b). See the *ADC Clock Modes* section for a functional description

of each clock mode. Set REFADC1 and REFADC0 to select external/internal reference for the ADC (see Table 7c). Set REFDAC1 and REFDAC0 to select external/internal reference for both DACs (see Table 7d).

When mode 11 is selected, the external capacitor that is connected to the REFADC is charged by a resistor with a typical value of 400kΩ. This time constant needs to be allowed for powering up the reference. Avoid leakage paths to REFADC.

### ALMSCFG (Read/Write)

The Software Alarm Configuration register controls the behavior of outputs SAFE1, SAFE2, and ALARM. Write to the Software Alarm Configuration register by sending the appropriate write command byte followed by data bits D15–D0 (see Table 8). Bits D15–D12 are don't care. Read the Software Alarm Configuration register by sending the appropriate command byte.

Set ALMSCLR to 1 to immediately set all temperature/current threshold registers to their POR state. In addition, temperature-/current-related bits of the Flag register are also reset to their POR state. The ALMSCLR resets to 0 immediately after a write. Set ALARMCMP to 1 to enable output-comparator mode for ALARM and to 0 to enable output-interrupt mode for ALARM (see the

# Dual RF LDMOS Bias Controllers with I<sup>2</sup>C/SPI Interface

**Table 7. DCFIG (Read/Write)**

BIT NAME	DATA BIT	POR	FUNCTION
X	D15–D10	X	Don't care
PG2SET1	D9	0	PGA 2 gain-setting
PG2SET0	D8	0	PGA 2 gain-setting
PG1SET1	D7	0	PGA 1 gain-setting
PG1SET0	D6	0	PGA 1 gain-setting
CKSEL1	D5	0	Clock mode and $\overline{\text{CNVST}}$ configuration
CKSEL0	D4	0	Clock mode and $\overline{\text{CNVST}}$ configuration
REFADC1	D3	0	ADC reference select
REFADC0	D2	0	ADC reference select
REFDAC1	D1	0	DAC reference select
REFDAC0	D0	0	DAC reference select

*Alarm Modes* section). Setting ALARMCMP does not affect SAFE1 and SAFE2 outputs. Program ALARMHYST1 and ALARMHYST0 to set the amount of built-in hysteresis used in window-threshold mode.

See the *ALARM Output* and *SAFE1/SAFE2 Outputs* sections for a description of the relationship between ALARM and SAFE1 and SAFE2. Set TALARM2 to 1 to allow channel 2 temperature measurements to control the state of SAFE2 and ALARM based on channel 2 temperature thresholds. Set TWIN2 to 0 to enable hysteresis-threshold mode and to 1 to enable window-threshold mode for channel 2 temperature measurements (see the *Alarm Modes* section). Set IALARM2 to 1 to allow channel 2 current measurements to control the state of SAFE2 and ALARM based on channel 2 current thresholds. Set IWIN2 to 0 to enable hysteresis-threshold mode and to 1 to enable window-threshold mode for channel 2 current measurements.

Set TALARM1 to 1 to allow channel 1 temperature measurements to control the state of SAFE1 and ALARM based on channel 1 temperature thresholds. Set TWIN1 to 0 to enable hysteresis-threshold mode and to 1 to enable window-threshold mode for channel 1 temperature measurements (see the *Alarm Modes* section). Set IALARM1 to 1 to allow channel 1 current measurements to control the state of SAFE1 and ALARM based on channel 1 current thresholds. Set IWIN1 to 0 to enable hysteresis-threshold mode and to 1 to enable window-threshold mode for channel 1 current measurements.

### HIWIPE1 and HIWIPE2 (Read/Write)

Write to the Coarse DAC1/DAC2 High Wiper Input register by sending the appropriate write command byte

**Table 7a. Gain-Setting Modes**

PG_SET1	PG_SET0	FUNCTION
0	0	PGA_gain of 2
0	1	PGA_gain of 10
1	X	PGA_gain of 25

X = Don't care.

**Table 7b. Clock Modes**

CKSEL1	CKSEL0	CONVERSION CLOCK	ACQUISITION/SAMPLING
0	0	Internal	Internally timed acquisitions and conversions. Conversions started by a write to the Analog-to-Digital Conversion register or setting the CONCONV bit.
0	1	Internal	Internally timed acquisitions and conversions. Conversions begin with a high-to-low transition at $\overline{\text{CNVST}}$ .
1	0	—	Reserved. Do not use.
1	1	Internal	Externally timed acquisitions by $\overline{\text{CNVST}}$ . Conversions internally timed.

**Table 7c. ADC Reference Selection**

REFADC1	REFADC0	DESCRIPTION
0	X	External. Bypass REFADC with a 0.1 $\mu$ F capacitor to AGND.
1	0	Internal. Leave REFADC unconnected.
1	1	Internal. Connect a 0.1 $\mu$ F capacitor to REFADC for better noise performance.

X = Don't care.

followed by data bits D15–D0 (see Table 9). Bits D14–D8 are don't care. Read the Coarse DAC1/DAC2 High Wiper Input register by sending the appropriate read command byte. The DAC output is not updated until an LDAC command is issued, at which point the

# Dual RF LDMOS Bias Controllers with I<sup>2</sup>C/SPI Interface

**Table 7d. DAC Reference Selection**

REFDAC1	REFDAC0	DESCRIPTION
0	X	External. Bypass REFDAC with a 0.1μF capacitor to AGND.
1	0	Internal. Leave REFDAC unconnected.
1	1	Internal. Connect a 0.1μF capacitor to REFDAC for extra decoupling and better noise performance.

X = Don't care.

DAC input register is transferred to the appropriate DAC output register. Automatic calibration of the high wiper is initiated if the HCAL bit in the DAC input register is set to 1 when the appropriate LDAC command is issued.

### **LOWIPE1 and LOWIPE2 (Read/Write)**

Write to the Coarse DAC1/DAC2 Low Wiper Input register by sending the appropriate command byte followed by data bits D15–D0 (see Table 10). Bits D14–D8 are don't care. Read the Coarse DAC1/DAC2 Low Wiper Input register by sending the appropriate read command byte. The DAC output is not updated until an LDAC command is issued, at which point the DAC input register is transferred to the appropriate DAC output register. Automatic calibration of the low wiper is initiated if the LCAL bit in the DAC input register is set to 1 when the appropriate LDAC command is issued.

### **FINECAL1 and FINECAL2 (Write)**

Write to the Fine DAC1/DAC2 Input register with auto-calibration by sending the appropriate write command byte followed by data bits D15–D0 (see Table 11). Bits D15–D10 are don't care. A write to these registers triggers the autocalibration but does not automatically update the output of the DAC. Write to the Software LDAC register (LDAC) to transfer the Fine DAC Input register contents to the Fine DAC Output register, thereby updating the output of the DAC. POR contents for these registers are all zeros. Read the DAC input register values written to Fine DAC1 and DAC2 Input registers through the Fine DAC1/DAC2 Input Read register. These read registers contain the latest user-write to any Fine DAC1 or Fine DAC2 Input Read register and do not contain autocalibration-corrected values.

### **PGACAL (Write)**

Write to the PGA Calibration Control register to calibrate PGA1 and PGA2 internal amplifiers. Write to the PGA Calibration Control register by sending the appropriate write command byte followed by data bits D15–D0 (see

Table 12). Bits D15–D8 are reserved and must be set to 0. Bits D7–D3 are don't care. Set FIRSTB to 1 to enable tracking-calibration mode, and to 0 to enable acquisition-calibration mode.

During an offset calibration trial, for either mode, the corresponding PGAOUT<sub>n</sub> is put into hold, which produces a pedestal error for 67μs typically and BUSY is set to 1. In acquisition mode, the calibration routine operates continuously, first on channel 1 and then on channel 2, until the channel-input offset voltage error has been reduced to within 50μV. The time taken for both channels to complete acquisition depends upon the initial channel offset voltage error but should never be longer than 112ms. In tracking mode, a pair of offset calibration trials, first on channel 1 and then on channel 2, are made each time DOCAL is set to 1 or every 20ms if the SELFTIME bit is set to 1. To reject noise, the offset trim DAC code (not shown in the *Functional Diagram*) only increments or decrements after the results of 16 calibration trials have been averaged.

Set FIRSTB to 0 and DOCAL to 1 to initiate an acquisition calibration. Acquisition must be done before tracking the first time a PGA calibration is commanded. Set FIRSTB to 1, DOCAL to 1, and SELFTIME to 0 to trigger an offset calibration trial on PGA1 and PGA2. At the end of the routine, DOCAL returns to 0. Set FIRSTB to 1, DOCAL to 1 (optional to trigger calibration once immediately before SELFTIME starts periodic calibrations), and SELFTIME to 1, just once, to trigger periodic offset-calibration trials (approximately every 20ms). Set SELFTIME to 0 to halt the periodic calibration.

### **FINE1 and FINE2 (Write)**

Write to the Fine DAC1/DAC2 Input register without auto-calibration by sending the appropriate write command byte followed by data bits D15–D0 (see Table 13). Bits D15–D10 are don't care. A write to these registers does not trigger the autocalibration and does not automatically update the output of the DAC. Write to the Software LDAC register (LDAC) to transfer the DAC input register contents to the Fine DAC Output register, thereby updating the output of the fine DAC. POR contents for these registers are all zeros. Read the DAC input register values written to Fine DAC1 and DAC2 Input registers through the Fine DAC1/DAC2 Input Read register. These read registers contain the latest user-write to any Fine DAC1 or Fine DAC2 Input Read register and do not contain autocalibration corrected values.

### **FINETHRU1 and FINETHRU2 (Write)**

Write to the Fine DAC1/DAC2 Write-Through Input register without autocalibration by sending the appropriate write command byte followed by data bits D15–D0 (see

## Dual RF LDMOS Bias Controllers with I<sup>2</sup>C/SPI Interface

**Table 8. ALMSCFG (Read/Write)**

BIT NAME	DATA BIT	POR	FUNCTION
X	D15–D12	X	Don't care
ALMSCLR	D11	0	1 = Temp/current thresholds set to POR state 0 = Temp/current thresholds unaffected
ALARMCMP	D10	0	1 = ALARM in output-comparator mode 0 = ALARM in output-interrupt mode
ALARMHYST1	D9	0	Thresholds hysteresis (ALARMHYST1 is MSB) 00 = 8 LSBs of hysteresis 01 = 16 LSBs of hysteresis 10 = 32 LSBs of hysteresis 11 = 64 LSBs of hysteresis
ALARMHYST0	D8	0	
TALARM2	D7	0	1 = SAFE2 and ALARM dependent on channel 2 temperature 0 = SAFE2 and ALARM not dependent on channel 2 temperature
TWIN2	D6	0	1 = Channel 2 temperature thresholds are in window-threshold mode 0 = Channel 2 temperature thresholds are in hysteresis-threshold mode
IALARM2	D5	0	1 = SAFE2 and ALARM dependent on channel 2 current 0 = SAFE2 and ALARM not dependent on channel 2 current
IWIN2	D4	0	1 = Channel 2 current thresholds are in window-threshold mode 0 = Channel 2 current thresholds are in hysteresis-threshold mode
TALARM1	D3	0	1 = SAFE1 and ALARM dependent on channel 1 temperature 0 = SAFE1 and ALARM not dependent on channel 1 temperature
TWIN1	D2	0	1 = Channel 1 temperature thresholds are in threshold-window mode 0 = Channel 1 temperature thresholds are in hysteresis-threshold mode
IALARM1	D1	0	1 = SAFE1 and ALARM dependent on channel 1 current 0 = SAFE1 and ALARM not dependent on channel 1 current
IWIN1	D0	0	1 = Channel 1 current thresholds are in window-threshold mode 0 = Channel 1 current thresholds are in hysteresis-threshold mode

X = Don't care.

**Table 9. HIWIPE1 and HIWIPE2 (Read/Write)**

BIT NAME	DATA BIT	POR	FUNCTION
HCAL	D15	1	1 = High wiper autocalibration. 0 = No high wiper autocalibration.
—	D14–D8	X	Don't care.
—	D7–D0	0000 0000	8-bit coarse high wiper DAC input code. D7 is the MSB.

Table 14). Bits D15–D10 are don't care. A write to these registers does not trigger the autocalibration but immediately updates the output of the DAC by transferring the DAC input register to the DAC output register (writing through the input register). POR contents for these registers are all zeros. Read the DAC input register val-

ues written to Fine DAC1 and DAC2 Input registers through the Fine DAC1/DAC2 Input Read register. These read registers contain the latest user write to any Fine DAC1 or Fine DAC2 Input Read register and do not contain autocalibration corrected values.



# Dual RF LDMOS Bias Controllers with I<sup>2</sup>C/SPI Interface

**Table 10. LOWIPE1 and LOWIPE2 (Read/Write)**

BIT NAME	DATA BIT	POR	FUNCTION
LCAL	D15	1	1 = Low wiper autocalibration. 0 = No low wiper autocalibration.
—	D14–D8	X	Don't care.
—	D7–D0	0000 0000	8-bit coarse low wiper DAC input code. D7 is the MSB.

### ALMHCFG (Read/Write)

The Hardware Alarm Configuration register controls SAFE1, SAFE2, and ALARM outputs. Write to the Hardware Alarm Configuration register by sending the appropriate write command byte followed by data bits D15–D0 (see Table 15). Bits D15–D8 are don't care. Read the Hardware Alarm Configuration register by sending the appropriate read command byte.

Set SETSAFE1 to 1 to immediately force SAFE1 active. This is especially useful when SAFE1 is connected to OPSAFE1, giving the user software control over shutting down the LDMOS transistor. Set SETSAFE1 to 0 for normal operation. SETSAFE2 has the same functionality as SETSAFE1 but for channel 2.

Set ALARMPOL to 1 to configure ALARM active-low. Set it to 0 to configure ALARM active-high. Set ALARMOPN to 1 to configure ALARM open-drain. Set it to 0 to configure ALARM push-pull. Set SAFE1POL to 1 to configure SAFE1 for active-low, and to 0 for active-high. Set SAFE2POL to 1 to configure SAFE2 for active-low, and to 0 for active-high. Set SAFE1OPN to 1 to configure SAFE1 for open-drain, and to 0 for push-pull. Set SAFE2OPN to 1 to configure SAFE2 for open-drain, and to 0 for push-pull.

When connecting SAFE1 and SAFE2 outputs to OPSAFE1 and OPSAFE2 inputs, configure the device as follows:

- 1) Set SAFE1POL and SAFE2POL to 0s.

**Table 11. FINECAL1 and FINECAL2 (Write)**

DATA BIT	POR	FUNCTION
D15–D10	X	Don't care.
D9–D0	00 0000 0000	10-bit fine DAC input code. D9 is the MSB.

- 2) Set SAFE1OPN and SAFE2OPN to 0s.

This ensures that when SAFE1 and SAFE2 are asserted, and connected to OPSAFE1 and OPSAFE2, the LDMOS transistors are shut off.

### ADCCON (Write)

The Analog-to-Digital Conversion register selects which inputs to the ADC are converted. Write to the Analog-to-Digital Conversion register by sending the appropriate write command byte followed by data bits D15–D0 (see Table 16). Bits D15–D12 are don't care. Bits D11–D8 are reserved bits and need to be set to 0. Read the results of the conversions in the FIFO by sending the appropriate read command byte. See the *ADC Description* section for a complete description of the ADC.

Set CONCONV to 1 to convert selected inputs to the ADC continuously and to 0 to convert selected inputs to the ADC only once. Set ADCSEL2 to 1 to select voltages at ADCIN2 to be converted. Set IEXT2 to 1 to select voltages at PGAOUT2 to be converted. Set

**Table 12. PGACAL (Write)**

BIT NAME	DATA BIT	RESET STATE	FUNCTION
RESERVED	D15–D8	0	Reserved. Set to 0.
X	D7–D3	X	Don't care.
FIRSTB	D2	0	1 = Tracking calibration mode. 0 = Acquisition calibration mode.
DOCAL	D1	0	1 = Initiate the calibration defined by FIRSTB (one time). 0 = Do not initiate a calibration.
SELFTIME	D0	0	1 = Initiate periodic calibrations defined by FIRSTB (every 15ms). 0 = Stop periodic calibrations.

## Dual RF LDMOS Bias Controllers with I<sup>2</sup>C/SPI Interface

TEXT2 to 1 to select the temperature at external diode 2 to be converted. Set ADCSEL1 to 1 to select voltages at ADCIN1 to be converted. Set IEXT1 to 1 to select voltages at PGAOUT1 to be converted. Set TEXT1 to 1 to select the temperature at external diode 1 to be converted. Set TINT to 1 to select the internal temperature of the MAX1385/MAX1386 to be converted.

During continuous conversions (CONCONV = 1), the ADC does not trigger the BUSY signal. When CONCONV is set to 0, the current scan (not just the current conversion) is completed and the ADC waits for the next command. During continuous conversions, the FIFO overflows if the user does not read it quickly enough. When the FIFO overflows, it contains a mixture of old and new conversion results (see the *RDFLAG* (Read) section). Continuous conversion mode is only available in clock modes 00 and 01.

### SSHUT (Write)

The Software Shutdown register shuts down all internal blocks at once or the DAC, ADC, and PGA blocks individually. Write to the Software Shutdown register by sending the appropriate write command byte followed by data bits D15–D0 (see Table 17). Bits D15–D8 and D6, D5, and D4 are don't care.

Set FULLPD to 1 to shut down all internal blocks and reduce the AV<sub>DD</sub> supply current to 0.2μA. FULLPD is set to 1 at power-up. To change to normal power mode, write two commands to the Software Shutdown register. The first command sets FULLPD to 0 (other bits in the Software Shutdown register are ignored). A second command is needed to activate any internal blocks. FULLPD overrides all other shutdown bits; however, all shutdown bits retain their data when FULLPD is set to 1. This means that if DAC1 and PGA1 are shut down before FULLPD is set to 1, they remain shut down after FULLPD is set to 0 again.

Set FBGON to 1 to force the internal bandgap reference to be powered at all times. Set FBGON to 0 to transfer power-down control of the internal reference to the ADC. In the event of DAC1PD or DAC2PD being set to 0, the internal bandgap is forced on. Set OSCPD to 1 to shut down the internal oscillator. When the oscillator is shut down, the ADC ceases conversions and internal PGA calibration halts. Any interface command restarts the oscillator and allows the system to resume from where it left off. Set DAC2PD to 1 to shut down DAC2 and PGA2. Set DAC1PD to 1 to shut down DAC1 and PGA1. DAC1PD and DAC2PD power down the individual blocks regardless of additional commands; however, writes are still permitted to the DACs and PGAs. For maximum accuracy, do not command a DAC calibration while a DAC is powered down or powering up.

**Table 13. FINE1 and FINE2 (Write)**

DATA BIT	POR	FUNCTION
D15–D10	X	Don't care.
D9–D0	00 0000 0000	10-bit fine DAC input code. D9 is the MSB.

**Table 14. FINETHRU1 and FINETHRU2 (Write)**

DATA BIT	POR	FUNCTION
D15–D10	X	Don't care.
D9–D0	00 0000 0000	10-bit fine DAC input code. D9 is the MSB.

### LDAC (Write)

The Software LDAC register controls the loading of the DAC output registers with values from DAC input registers, allowing the user to update several changes to the DAC all at once (see Table 18). Write to the Software LDAC register by sending the appropriate write command byte followed by data bits D15–D0. Bits D15–D6 are don't care. Any bit set to 1 in the Software LDAC register is immediately set to 0 thereafter.

**Table 15. ALMHCFG (Read/Write)**

BIT NAME	DATA BIT	POR	FUNCTION
X	D15–D8	X	Don't care
SETSAFE1	D7	0	1 = Force SAFE1 active immediately 0 = Normal operation
SETSAFE2	D6	0	1 = Force SAFE2 active immediately 0 = Normal operation
ALARMPOL	D5	0	1 = ALARM is active-low 0 = ALARM is active-high
ALARMOPN	D4	0	1 = ALARM is open-drain 0 = ALARM is push-pull
SAFE1POL	D3	0	1 = SAFE1 is active-low 0 = SAFE1 is active-high
SAFE1OPN	D2	0	1 = SAFE1 is open-drain 0 = SAFE1 is push-pull
SAFE2POL	D1	0	1 = SAFE2 is active-low 0 = SAFE2 is active-high
SAFE2OPN	D0	0	1 = SAFE2 is open-drain 0 = SAFE2 is push-pull

# Dual RF LDMOS Bias Controllers with I<sup>2</sup>C/SPI Interface

MAX1385/MAX1386

**Table 16. ADCCON (Write)**

BIT NAME	DATA BIT	POR	FUNCTION
X	D15–D12	X	Don't care
Reserved	D11–D8	0	Reserved; set these bits to 0
CONCONV	D7	0	1 = Continuous conversions (repeated scans) 0 = Noncontinuous conversions (one scan)
ADCSEL2	D6	0	1 = Select voltages at ADCIN2 to be converted 0 = Do not select voltages at ADCIN2 to be converted
IEXT2	D5	0	1 = Select voltages at PGAOUT2 to be converted 0 = Do not select voltages at PGAOUT2 to be converted
TEXT2	D4	0	1 = Select temperature at remote diode 2 to be converted 0 = Do not select temperature at remote diode 2 to be converted
ADCSEL1	D3	0	1 = Select voltages at ADCIN1 to be converted 0 = Do not select voltages at ADCIN1 to be converted
IEXT1	D2	0	1 = Select voltages at PGAOUT1 to be converted 0 = Do not select voltages at PGAOUT1 to be converted
TEXT1	D1	0	1 = Select temperature at remote diode 1 to be converted 0 = Do not select temperature at remote diode 1 to be converted
TINT	D0	0	1 = Select internal temperature of device to be converted 0 = Do not select internal temperature of device to be converted

Set FINECH2 to 1 to load the fine DAC2 output register with the latest write to DAC2 input registers FINE2 or FINECAL2. This means that if FINE2 is written to after FINECAL2, FINE2 is sent to the fine DAC2 output register (no calibration code) when FINECH2 is set to 1. Set HIGHCH2 to 1 to load DAC input register HIWIPE2 into the Coarse DAC2 High Wiper register. Autocalibration of the DAC2 high wiper occurs if the HCAL bit in HIWIPE2 is set to 1. Set LOWCH2 to 1 to load DAC input register LOWIPE2 into the Coarse DAC2 Low Wiper register. Autocalibration of the DAC2 low wiper occurs if the LCAL bit in LOWIPE2 is set to 1.

Set FINECH1 to 1 to load the fine DAC1 output register with the latest write to DAC input registers FINE1 or FINECAL1. If FINECAL1 is written to after FINE1, FINECAL1 is sent to the fine DAC1 output register (with calibration code) when FINECH1 is set to 1. Set HIGHCH1 to 1 to load DAC input register HIWIPE1 into the Coarse DAC1 output register. Autocalibration of the DAC1 high wiper occurs if the HCAL bit in HIWIPE1 is set to 1. Set LOWCH1 to 1 to load DAC input register LOWIPE1 into the coarse DAC1 output register. Autocalibration of the DAC1 low wiper occurs if the LCAL bit in LOWIPE1 is set to 1.

### SCLR (Write)

Write to the Software Clear register to reset the DACs and FIFO to their POR states (see Table 19). Write to the Software Clear register by sending the appropriate write command byte followed by data bits D15–D0. Bits D15–D10 are don't care. A write to bits D5–D0 in the Software Clear register immediately changes the appropriate DAC output to its power-on state (regardless of LDAC). To reset all registers at once, set FULLRESET to 0 and ARMRESET to 1. Next set FULLRESET to 1 and ARMRESET to 0. This 2-byte reset operation protects the registers from being fully reset by inadvertent user writes. After a full reset, the device is in shutdown mode and the SSHUT register needs to be written to for full operation.

Set CLFIFO to 1 to clear the entire 15-word FIFO and FIFO-associated flag bits in the Flag register. Set HIGHCL2 to 1 to reset the Coarse DAC2 High Wiper Output and Input registers to their POR states. Set LOWCL2 to 1 to reset the coarse DAC2 High Wiper Output and Input registers to their POR states. Set FINECL1 to 1 to reset Fine DAC1 Output and Input registers to their POR states. Set HIGHCL1 to 1 to reset the Coarse DAC1 High Wiper Output and Input registers to their POR states. Set LOWCL1 to 1 to reset the

## Dual RF LDMOS Bias Controllers with I<sup>2</sup>C/SPI Interface

Table 17. SSHUT (Write)

BIT NAME	DATA BIT	POR	FUNCTION
X	D15–D8	X	Don't care
FULLPD	D7	1	1 = Shut down all internal blocks 0 = Do not shut down all internal blocks
X	D6, D5, D4	X	Don't care
FBGON	D3	0	1 = Force internal bandgap reference to be powered always 0 = Let the ADC control power-down of the internal reference
OSCPD	D2	0	1 = Shut down the internal oscillator 0 = Do not shut down the internal oscillator
DAC2PD	D1	1	1 = Power down DAC2 0 = Do not power down DAC2
DAC1PD	D0	1	1 = Power down DAC1 0 = Do not power down DAC1

Table 18. LDAC (Write)

BIT NAME	DATA BIT	POR	FUNCTION
X	D15–D6	X	Don't care
FINECH2	D5	N/A	1 = Update fine DAC2 with FINE2 or FINECAL2 0 = Do not update DAC2
HIGHCH2	D4	N/A	1 = Update coarse DAC2 with HIWIPE2 0 = Do not update DAC2
LOWCH2	D3	N/A	1 = Update coarse DAC2 with LOWIPE2 0 = Do not update DAC2
FINECH1	D2	N/A	1 = Update fine DAC1 with FINE1 or FINECAL1 0 = Do not update DAC1
HIGHCH1	D1	N/A	1 = Update coarse DAC1 with HIWIPE1 0 = Do not update DAC1
LOWCH1	D0	N/A	1 = Update coarse DAC1 with LOWIPE1 0 = Do not update DAC1

Coarse DAC1 Low Wiper Output and Input registers to their POR states. Set FINECL2 to 1 to reset Fine DAC2 Output and Input registers to their POR states.

### THRUH1 and THRUH2 (Read/Write)

Write to the Coarse DAC1/DAC2 Write-Through High Wiper Input register by sending the appropriate write command byte followed by data bits D15–D0 (see Table 20). Bits D15–D8 are don't care. Writing to one of these registers automatically writes through to the appropriate DAC output register, thereby updating the DAC output immediately. Writing to one of these registers does not trigger automatic high wiper calibration. Read the Coarse DAC1/DAC2 Write-Through High

Wiper Input register by sending the appropriate read command byte.

### THRULO1/THRULO2 (Read/Write)

Write to the Coarse DAC1/DAC2 Write-Through Low Wiper Input register by sending the appropriate write command byte followed by data bits D15–D0 (see Table 21). Bits D15–D8 are don't care. Writing to one of these registers automatically writes through to the appropriate DAC output register, thereby updating the DAC output immediately. Writing to one of these registers does not trigger automatic low wiper calibration. Read the Coarse DAC1/DAC2 Write-Through Low

# Dual RF LDMOS Bias Controllers with I<sup>2</sup>C/SPI Interface

**Table 19. SCLR (Write)**

BIT NAME	DATA BIT	POR	FUNCTION
X	D15–D10	X	Don't care
FULLRESET	D9	N/A	Full reset of all DAC registers is a two write operation: 1) FULLRESET = 0, ARMRESET = 1 2) FULLRESET = 1, ARMRESET = 0
ARMRESET	D8	0	
X	D7	X	Don't care
CLFIFO	D6	N/A	1 = Clear FIFO and FIFO flag bits 0 = Do not clear FIFO or FIFO flag bits
HIGHCL2	D5	N/A	1 = Reset coarse DAC2 high wiper to its POR state 0 = Do not reset coarse DAC2 high wiper to its POR state
LOWCL2	D4	N/A	1 = Reset coarse DAC2 low wiper to its POR state 0 = Do not reset coarse DAC2 low wiper to its POR state
FINECL1	D3	N/A	1 = Reset fine DAC1 to its POR state 0 = Do not reset fine DAC1 to its POR state
HIGHCL1	D2	N/A	1 = Reset coarse DAC1 high wiper to its POR state 0 = Do not reset coarse DAC1 high wiper to its POR state
LOWCL1	D1	N/A	1 = Reset coarse DAC1 low wiper to its POR state 0 = Do not reset coarse DAC1 low wiper to its POR state
FINECL2	D0	N/A	1 = Reset fine DAC2 to its POR state 0 = Do not reset fine DAC2 to its POR state

Wiper Input register by sending the appropriate read command byte.

### ***FINETHRUCAL1 and FINETHRUCAL2 (Write)***

Write to the Fine DAC1/DAC2 Write-Through Input register with autocalibration by sending the appropriate write command byte followed by data bits D15–D0 (see Table 22). Bits D15–D10 are don't care. A write to these registers not only triggers the autocalibration but immediately updates the output of the DAC by transferring the DAC input register with correction code to the Fine DAC output register. POR contents for these registers are all zeros. Read the DAC Input register values written to Fine DAC1 and DAC2 Input registers through the Fine DAC1/DAC2 Input Read register. These read registers contain the latest user-write to any Fine DAC1 or Fine DAC2 Input register and do not contain autocalibration-corrected values.

### ***FIFO (Read)***

Read the oldest result in the FIFO by sending the appropriate read command byte and reading out data bits D15–D0 (see Table 23). Bits D15–D12 are channel tag bits that indicate the source of the conversion. Bits D11–D0 contain the conversion result. Reading from

the FIFO when the FIFO is empty results in the current contents of the Flag read register to be sent.

### ***RDFINE1 and RDFINE2 (Read)***

Read the Fine DAC1/DAC2 Input Read register by sending the appropriate read command byte and reading out data bits D15–D0 (see Table 24). Data contains the last write to any Fine DAC1/DAC2 Input registers and does not contain autocalibration-corrected values.

### ***RDFLAG (Read)***

The Flag register contains important system information regarding ADC/FIFO status and alarm conditions. Read the Flag register by sending the appropriate read command byte and reading out data bits D15–D0 (see Table 25). Bits D15–D12 are don't care. ADCBUSY is set to 1 when the ADC is busy, an ALARM value is being checked, or the ADC results are being loaded into the FIFO. ADCBUSY is set to 0 when the ADC has completed all the conversions in the current scan.

ALUBUSY is set to 1 when the ALU is busy and set to 0 when it is not. ALUBUSY is set to 1 for 134µs at power-up for initialization. FIFOEMP is set to 1 when the FIFO is empty and set to 0 when the FIFO contains data. Writing to the appropriate bit in the Software Clear register empties the FIFO and sets the FIFOEMP bit to 1.

## Dual RF LDMOS Bias Controllers with I<sup>2</sup>C/SPI Interface

FIFOOVER is set to 1 when the FIFO overflows. FIFOOVER is set to 0 after reading the Flag register.

All threshold-related bits in the Flag register can be cleared at once by writing to the ALMSCLR bit in the Software Alarm Configuration register (see the *ALMSCFG (Read/Write)* section). HIGHI2 is set to 1 when the channel 2 current exceeds its high threshold. HIGHI2 resets to 0 after reading the Flag register. LOWI2 is set to 1 when the channel 2 current drops below its low threshold. LOWI2 resets to 0 after reading the Flag register. HIGHT2 is set to 1 when the channel 2 temperature measurement exceeds its high threshold. HIGHT2 resets to 0 after reading the Flag register. The LOWT2 is set to 1 when the channel 2 temperature measurement drops below its low threshold. LOWT2 resets to 0 after reading the Flag register.

HIGHI1 is set to 1 when the channel 1 current exceeds its high threshold. HIGHI1 resets to 0 after reading the Flag register. LOWI1 is set to 1 when the channel 1 current drops below its low threshold. LOWI1 resets to 0 after reading the Flag register. HIGHT1 is set to 1 when the channel 1 temperature measurement exceeds its high threshold. HIGHT1 resets to 0 after reading the Flag register. LOWT1 is set to 1 when the channel 1 temperature measurement drops below its low threshold. LOWT1 resets to 0 after reading the Flag register.

### Digital Serial Interface

The MAX1385/MAX1386 contain an I<sup>2</sup>C-/SPI-compatible serial interface for configuration. Connect the mode-select input, SEL, to DGND to select I<sup>2</sup>C mode. In I<sup>2</sup>C mode, the MAX1385/MAX1386 provide address inputs A0 to A2 to allow eight devices to be connected on the same bus (see the *Slave Address Byte* section). Connect SEL to DVDD to select SPI mode. In SPI mode, drive A0/ $\overline{CSB}$  low to select the device. The MAX1385/MAX1386 support fast (400kHz) and high-speed (1.7MHz or 3.4MHz) data-transfer modes. Data transfers occur in 8-bit bytes with acknowledge (ACK) or not-acknowledge (NACK) bits following each byte. The MAX1385/MAX1386 are permanent slaves and do not generate their own clock signals. Figure 11 shows the various read/write formats.

### Write Format

Use the following sequence to write a single word (see Figure 11):

- 1) After generating a START condition (S or Sr), address the MAX1385/MAX1386 by sending the appropriate slave address byte with its corresponding R/W bit set to zero (see the *Slave Address Byte* section). The MAX1385/MAX1386 answer with an ACK bit (see the *Acknowledge Bits* section).

**Table 20. THRUHI1 and THRUHI2 (Read/Write)**

DATA BIT	POR	FUNCTION
D15–D8	X	Don't care.
D7–D0	0000 0000	8-bit coarse high wiper DAC input code. D7 is the MSB.

**Table 21. THRULO1 and THRULO2 (Read/Write)**

DATA BIT	POR	FUNCTION
D15–D8	X	Don't care.
D7–D0	0000 0000	8-bit coarse high wiper DAC input code. D7 is the MSB.

**Table 22. FINETHRUCAL1 and FINETHRUCAL2 (Write)**

DATA BIT	POR	FUNCTION
D15–D10	X	Don't care.
D9–D0	00 0000 0000	10-bit fine DAC input code. D9 is the MSB.

- 2) Send the appropriate write command byte (see the *Command Byte* section). The MAX1385/MAX1386 answer with an ACK bit.
- 3) Send the most significant 8-bit section of the 16-bit data word, sending the MSBs first (see the *Data Bytes* section). The MAX1385/MAX1386 answer with an ACK bit.
- 4) Send the least significant 8-bit section of the 16-bit data word, sending the MSBs first. The MAX1385/MAX1386 answer with an ACK bit.
- 5) Generate a (repeated) START or STOP condition (Sr or P).

To write to a block of registers, use the same steps as above but repeat steps 2, 3, and 4 without any START, STOP, or repeated START conditions (Sr). Finish the block write by generating a STOP condition.

### Read Format

All read operations can begin with a Sr as well as an S condition. One type of read is a 5-byte operation, one is a 3-byte operation, and the other is a continuous read operation. The 5-byte operation reads from the register address contained in one of the 5 bytes sent. The 3-byte operation reads from the last register address accessed. Use the following 5-byte sequence to read

# Dual RF LDMOS Bias Controllers with I<sup>2</sup>C/SPI Interface

MAX1385/MAX1386

**Table 23. FIFO (Read)**

DATA BITS						CONVERSION ORIGIN	
D15	D14	D13	D12	D11		D0	
0	0	0	0	MSB	BITS D11-D0 CONTAIN THE CONVERSION RESULT	LSB	Internal temperature sensor
0	0	0	1	MSB		LSB	Channel 1 external temperature
0	0	1	0	MSB		LSB	Channel 1 drain current (PGAOUT1)
0	0	1	1	MSB		LSB	ADCIN1
0	1	0	0	MSB		LSB	Channel 2 external temperature
0	1	0	1	MSB		LSB	Channel 2 drain current (PGAOUT2)
0	1	1	0	MSB		LSB	ADCIN2
0	1	1	1	—		—	Reserved
1	0	0	0	—		—	Reserved
1	0	0	1	—		—	Reserved
1	0	1	0	—		—	Reserved
1	0	1	1	—		—	Reserved
1	1	0	0	—		—	Reserved
1	1	0	1	—		—	Reserved
1	1	1	0	MSB		LSB	Conversion may be corrupted. This occurs only when arriving data causes the FIFO to overflow at the same time data is being read out.
1	1	1	1	MSB		LSB	Empty FIFO. The current value of the Flag register is provided in place of the FIFO data.

16 bits of data from a MAX1385/MAX1386 register (see Figure 11):

- 1) After generating a START condition (S or Sr), address the MAX1385/MAX1386 by sending the appropriate slave address byte and its corresponding R/W bit set to a 0 (see the *Slave Address Byte* section). The MAX1385/MAX1386 then answer with an ACK bit (see the *Acknowledge Bits* section).
- 2) Send the appropriate read command byte (see the *Command Byte* section). The MAX1385/MAX1386 answer with an ACK bit.
- 3) After generating a repeated START condition (Sr), address the MAX1385/MAX1386 once more by sending the appropriate slave address byte and its R/W bit set to 1. The MAX1385/MAX1386 answer with an ACK bit.
- 4) The MAX1385/MAX1386 transmit the most significant 8-bit data byte of the 16-bit data word with the MSB first. Afterwards, the master needs to send an ACK bit.
- 5) The MAX1385/MAX1386 transmit the least significant 8-bit byte of the 16-bit word with the MSB first.

**Table 24. RDFINE1 and RDFINE2 (Read)**

DATA BITS	POR	FUNCTION
D15–D10	X	Don't care.
D9–D0	00 0000 0000	10-bit fine DAC input code. D9 is the MSB.

- 6) The master issues a NACK bit and then generates a repeated START or STOP condition (Sr or P).

Continue to poll the current register or read multiple words (e.g., empty FIFO of several conversion results) by omitting step 6 and keep issuing ACK bits after each data byte. Use the following 3-byte sequence to read 16 bits of data from the last accessed MAX1385/MAX1386 register:

- 1) After generating a START condition (S or Sr), address the MAX1385/MAX1386 by sending the appropriate 7-bit slave address byte and its corresponding R/W bit set to 1 (see the *Slave Address Byte* section). The MAX1385/MAX1386 then answer with an ACK bit (see the *Acknowledge Bits* section).

# Dual RF LDMOS Bias Controllers with I<sup>2</sup>C/SPI Interface

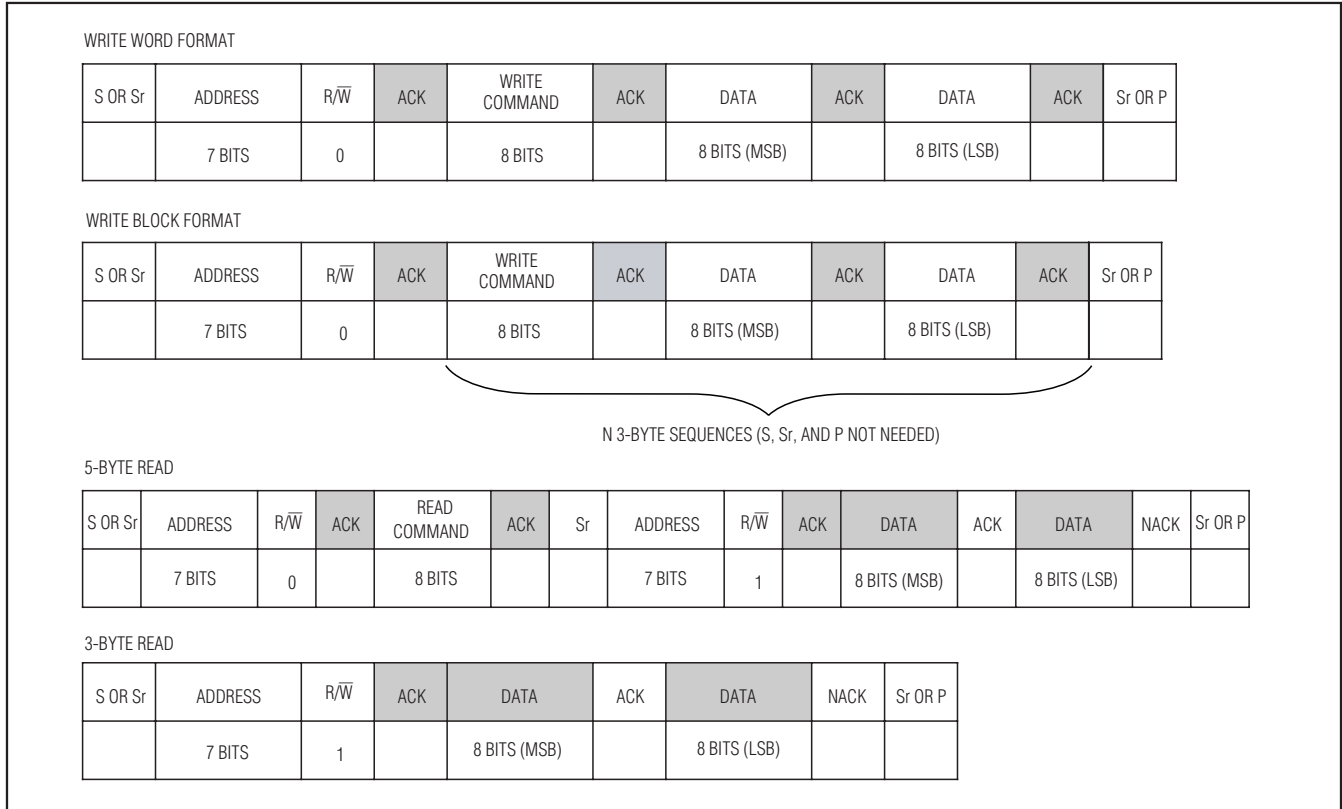

Figure 11. Read/Write Formats

- 2) The MAX1385/MAX1386 then transmit the contents of the last register accessed starting with the most significant 8-bit byte of the 16-bit word. MSBs are sent first. Afterwards, the master needs to send an ACK bit.
- 3) The MAX1385/MAX1386 transmit the least significant 8-bit byte of the 16-bit word. MSBs are sent first.
- 4) The master issues a NACK bit and then generates a repeated START or STOP condition (Sr or P).

Poll the current register by omitting step 4 and continuing to issue ACK bits after each data byte.

### Stringing Commands

The MAX1385/MAX1386 allow commands to be strung together to minimize configuration time, which is especially useful in HS mode. Figure 12 shows an example of stringing a write and read command together to form a write/readback command.

Figure 13 shows another useful sequence for a read-modify-write application.

### Slave Address Byte

The MAX1385/MAX1386 include a 7-bit-long slave address. The first 4 bits (MSBs) of the slave address are factory programmed and always 0x4h. The logic state of the address inputs (A2, A1, and A0) determine the 3 LSBs of the device address (see Figure 14). Connect A2, A1, and A0 to DVDD or DGND. A maximum of eight MAX1385/MAX1386 devices can be connected on the same bus at one time using these address inputs.

The 8th bit of the address byte is a R/W bit. The address byte R/W bit is set to 0 to notify the device that a command byte will be written to the device next. The address byte R/W bit is set to 1 to notify the device that a control byte will not be sent and to immediately send data from the last accessed register.



# Dual RF LDMOS Bias Controllers with I<sup>2</sup>C/SPI Interface

MAX1385/MAX1386

**Table 25. RDFLAG (Read)**

BIT NAME	DATA BIT	POR	FUNCTION
X	D15– D12	X	Don't care
ADCBUSY	D11	0	1 = ADC is busy 0 = ADC is not busy
ALUBUSY	D10	1	1 = ALU is busy 0 = ALU is not busy
FIFOEMP	D9	0	1 = FIFO is empty 0 = FIFO is not empty
FIFOOVER	D8	0	1 = FIFO overflowed 0 = FIFO not overflowed
HIGHI2	D7	0	1 = Channel 2 high current threshold exceeded 0 = Channel 2 high current threshold not exceeded
LOWI2	D6	0	1 = Channel 2 low current threshold surpassed 0 = Channel 2 low current threshold not surpassed
HIGHT2	D5	0	1 = Channel 2 high temperature threshold exceeded 0 = Channel 2 high temperature threshold not exceeded
LOWT2	D4	0	1 = Channel 2 low temperature threshold surpassed 0 = Channel 2 low temperature threshold not surpassed
HIGHI1	D3	0	1 = Channel 1 high current threshold exceeded 0 = Channel 1 high current threshold not exceeded
LOWI1	D2	0	1 = Channel 1 low current threshold surpassed 0 = Channel 1 low current threshold not surpassed
HIGHT1	D1	0	1 = Channel 1 high temperature threshold exceeded 0 = Channel 1 high temperature threshold not exceeded
LOWT1	D0	0	1 = Channel 1 low temperature threshold surpassed 0 = Channel 1 low temperature threshold not surpassed

### Command Byte

The MAX1385/MAX1386 use read and write command bytes (see Figure 15). The command byte consists of 8 bits and contains the address of the register. The command byte also communicates to the device whether a read or write operation occurs. See the *Register Description* section for details on how to access specific registers through the command byte.

### Data Bytes

Data bytes are clocked in/out of the device with the MSB first and the LSB last (see Figure 16). See the *Register Description* section for a description of data bytes for each register.

### Bit Transfer

One data bit is transferred during each SCL clock cycle. The data on SDA must remain stable during the high period of the SCL clock pulse. Changes in SDA

while SCL is high and stable are considered control signals (see the *START and STOP Conditions* section). Both SDA and SCL remain high when the bus is not active. The interface can support fast (400kHz) and high-speed (1.7MHz or 3.4MHz) data-transfer modes.

### START and STOP Conditions

The master initiates a transmission with a START condition (S), which is a high-to-low transition on SDA while SCL is high. The master terminates a transmission with a STOP condition (P), which is a low-to-high transition on SDA while SCL is high (Figure 17). A repeated START condition (Sr) can be used in place of a STOP condition to leave the bus active and the interface transfer speed unchanged (see the *Fast/High-Speed Modes* section).

# Dual RF LDMOS Bias Controllers with I2C/SPI Interface

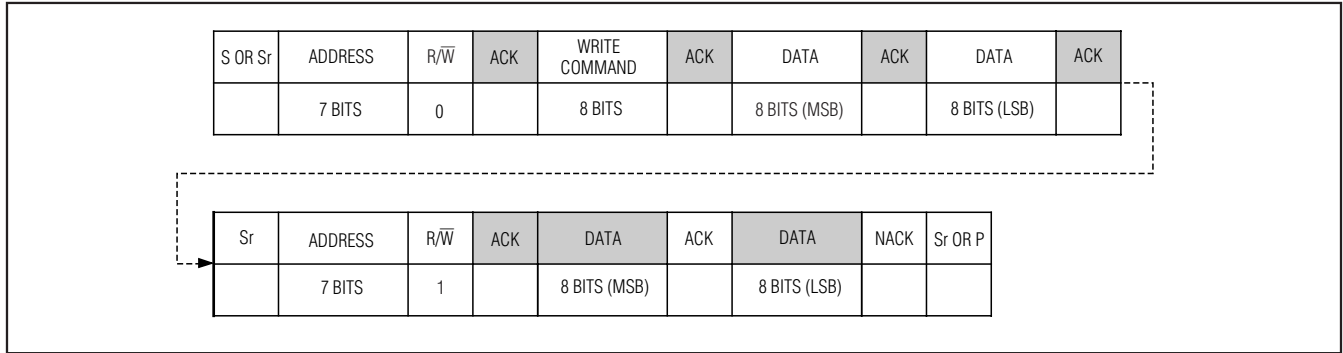

Figure 12. Write/Readback Sequence

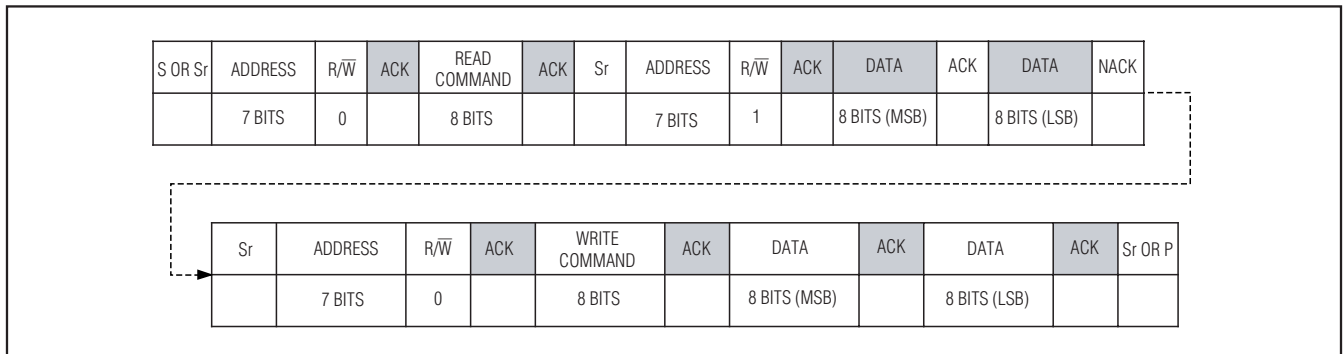

Figure 13. Read-Modify-Write Sequence

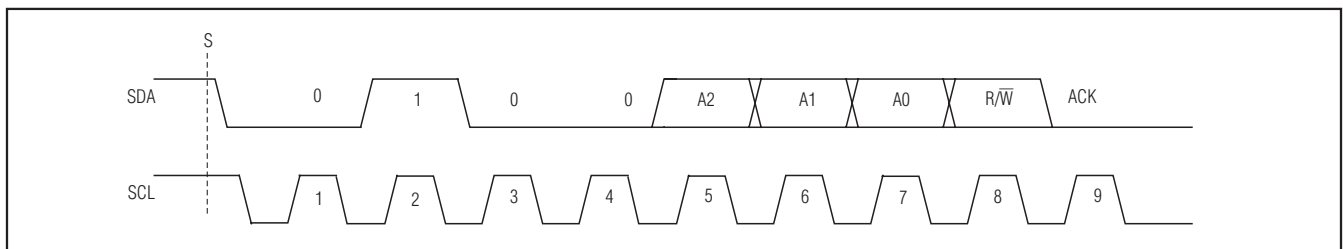

Figure 14. Slave Address Byte

### Acknowledge Bits

Data transfers are acknowledged with an acknowledge bit (ACK) or a not-acknowledge bit (NACK). Both the master and the MAX1385/MAX1386 generate ACK bits. To generate an ACK, SDA must be pulled low before the rising edge of the ninth clock pulse and kept low during the high period of the ninth clock pulse (see Figure 20). To generate a NACK, SDA is pulled high before the rising edge of the ninth clock pulse and is left high for the duration of the ninth clock pulse.

Monitoring NACK bits allow for detection of unsuccessful data transfers. NACK bits can also be used by the master to interrupt the current data transfer to start another data transfer. The MAX1385/MAX1386 do not issue an ACK after the last byte of a full reset write to the Software Clear register.

### Fast/High-Speed Modes

At power-up, the bus timing is set for slow-/fast-speed mode (FS mode), which allows bus speeds up to 400kHz. The MAX1385/MAX1386 are configurable for

# Dual RF LDMOS Bias Controllers with I<sup>2</sup>C/SPI Interface

MAX1385/MAX1386

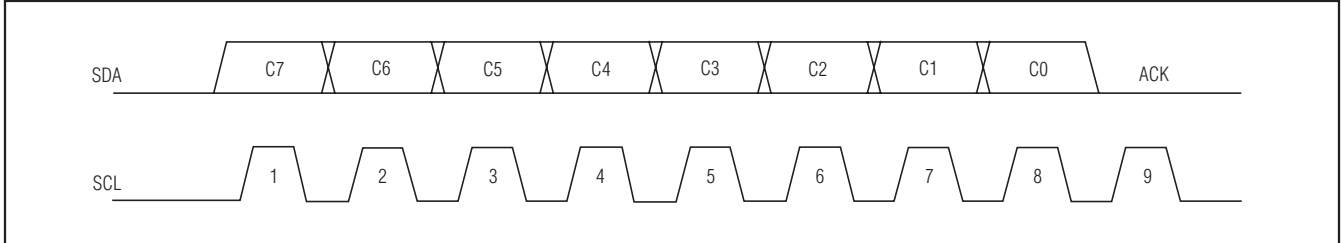

Figure 15. Command Byte

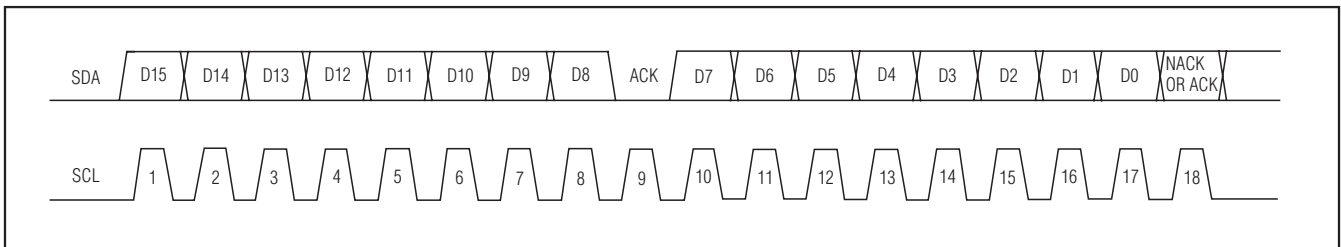

Figure 16. Data Bytes

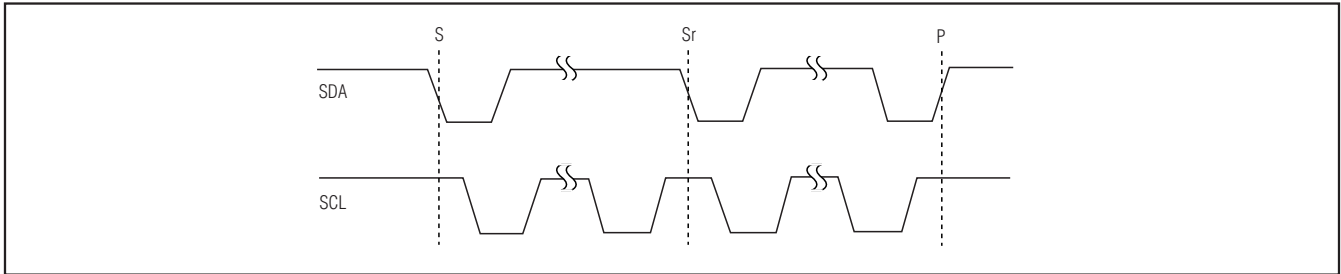

Figure 17. START and STOP Conditions

high-speed mode (HS mode), allowing bus speeds up to 3.4MHz. Execute the following procedure to change from FS mode to HS mode (see Figure 21).

- 1) Generate a START condition (S).
- 2) Send byte 00001XXX (X = don't care). The MAX1385/MAX1386 issue a NACK bit.
- 3) HS mode is entered on the 10th rising clock edge.

To remain in HS mode, use repeated START conditions (Sr) in place of the normal STOP conditions (P) (see Figure 22). All the same write and read formats supported in FS mode are supported in HS mode (with the replacement of repeated START conditions for STOP conditions). Generating a STOP condition (P) while in HS mode changes the bus speed back to FS mode.

## SPI Digital Serial Interface

The MAX1385/MAX1386 feature a 4-wire SPI-compatible serial interface capable of supporting data rates up to 16MHz. Full data transfers occur in 24-bit sections. The first 8-bit byte is a command byte (C7–C0). The next 16 bits are data bits (D15–D0). Clock signal SCL may idle low or high but data is always clocked in on the rising edge of SCL (CPOL = CPHA).

### Write Format

Use the following sequence to write 16 bits of data to a MAX1385/MAX1386 register (see Figure 18):

- 1) Pull  $\overline{\text{CSB}}$  low to select the device.
- 2) Send the appropriate write command byte (see the *Command Byte* section). The command byte is clocked in on the rising edge of SCL.

# Dual RF LDMOS Bias Controllers with I<sup>2</sup>C/SPI Interface

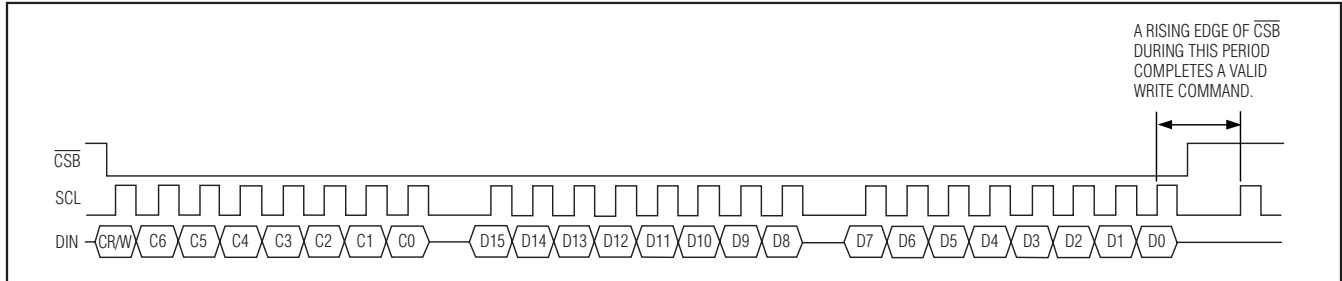

Figure 18. SPI Write Format

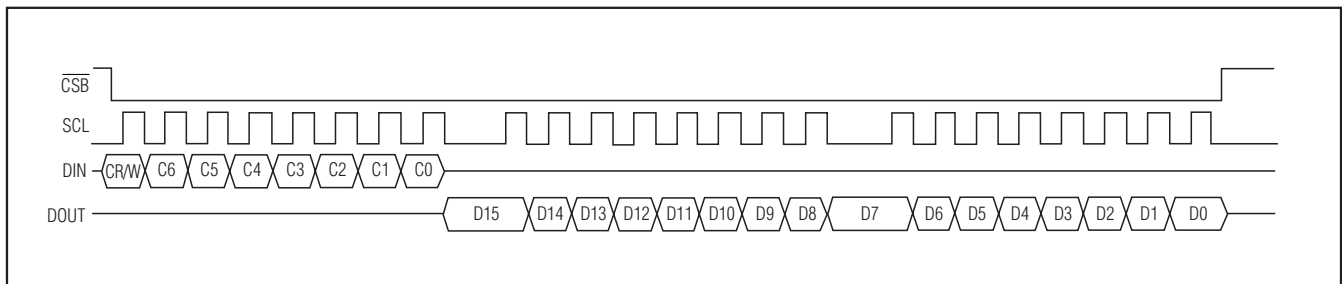

Figure 19. SPI Read Format

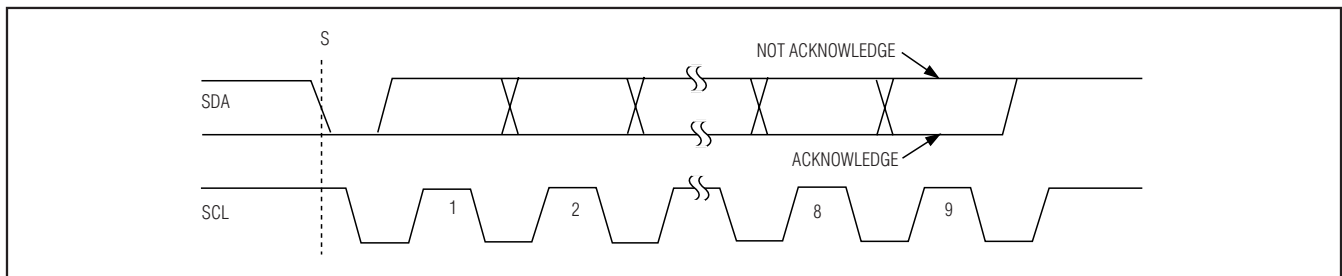

Figure 20. Acknowledge Bits

- 3) Send 16 bits of data (D15–D0) starting with the most significant bit and ending with the least significant bit. Data is clocked in on the rising edges of SCL.
- 4) Pull  $\overline{\text{CSB}}$  high.

### Read Format

Use the following sequence to read 16 bits of data from a MAX1385/MAX1386 register (see Figure 19):

- 1) Pull  $\overline{\text{CSB}}$  low to select the device.
- 2) Send the appropriate read command byte (see the *Command Byte* section). The command byte is clocked in on the rising edges of SCL.
- 3) Receive 16 bits of data. Data is clocked out on the falling edges of SCL.
- 4) Pull  $\overline{\text{CSB}}$  high.

### Command Byte

The MAX1385/MAX1386 use read and write command bytes. The command byte consists of 8 bits and contains the address of the register (C7–C0, see Figures 18 and 19). The command byte also communicates to the device whether a read or write operation occurs. See the *Register Description* section for details on how to access specific registers through the command byte.

### Data Bytes

Data bytes are clocked in/out of the device with the most significant bit first and the least significant bit last (D15–D0, see Figures 18 and 19). See the *Register Description* section for a description of data bytes for each register.

# Dual RF LDMOS Bias Controllers with I<sup>2</sup>C/SPI Interface

MAX1385/MAX1386

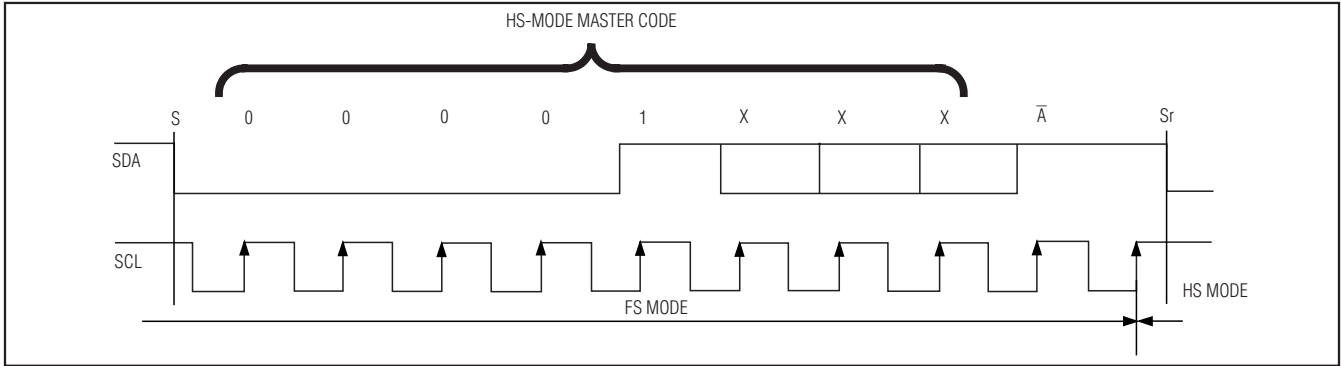

Figure 21. Changing to HS Mode

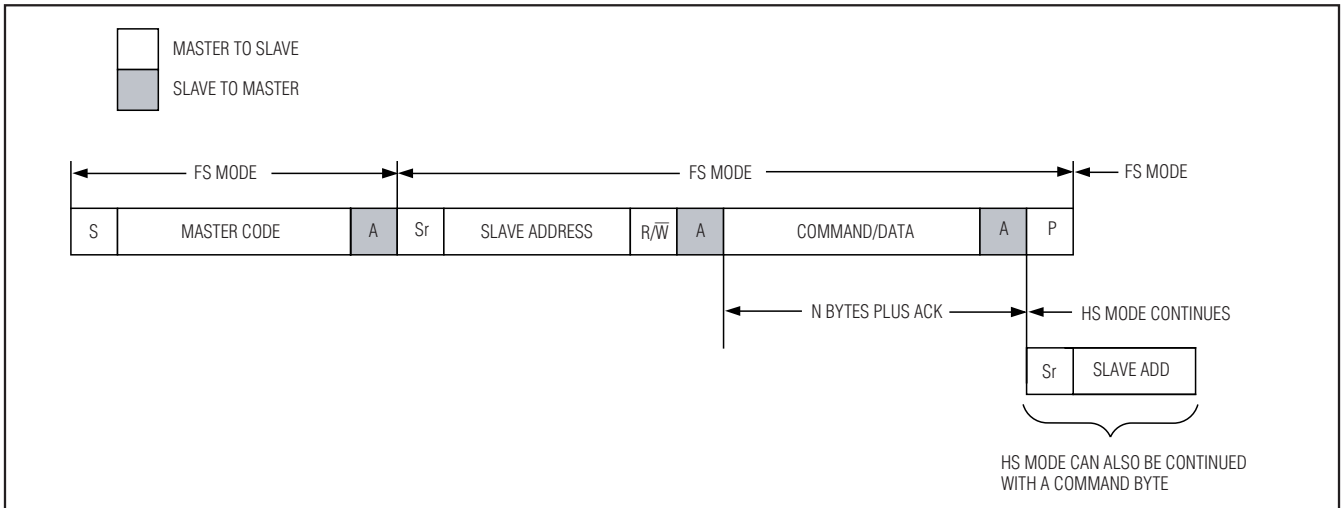

Figure 22. Changing to FS Mode or Staying in HS Mode

## Applications Information

### ADC Clock Mode 11

See Figure 23 for an example of configuring a conversion scan for internal temperature, PGAOUT1, and ADCIN1 in clock mode 11 using the internal reference. Timing symbols are referenced in the *Miscellaneous Timing Characteristics* section.

See Figure 24 for an example of configuring a conversion scan for ADCIN1, external temperature sensor 2, and PGAOUT2 in clock mode 11 using the internal reference. Timing symbols are referenced in the *Miscellaneous Timing Characteristics* section.

### Temperature-Threshold Examples

Table 26 shows some examples of temperature settings in two's-complement form.

### Leap-Frogging the DACs for 18 Bits of Resolution

Each DAC stage is configurable for leapfrog operation by using the 8-bit coarse DACs in conjunction with the 10-bit fine DAC. Use the following procedure for setting 18 bits of resolution:

- 1) Write to the Coarse DAC1/DAC2 Write-Through Low Wiper Input register (THRULO1/THRULO2)
- 2) Write to the Coarse DAC1/DAC2 Write-Through High Wiper Input register (THRUHIGH1/THRUHIGH2) with a value one higher or one lower than written to the low wiper register.

# Dual RF LDMOS Bias Controllers with I2C/SPI Interface

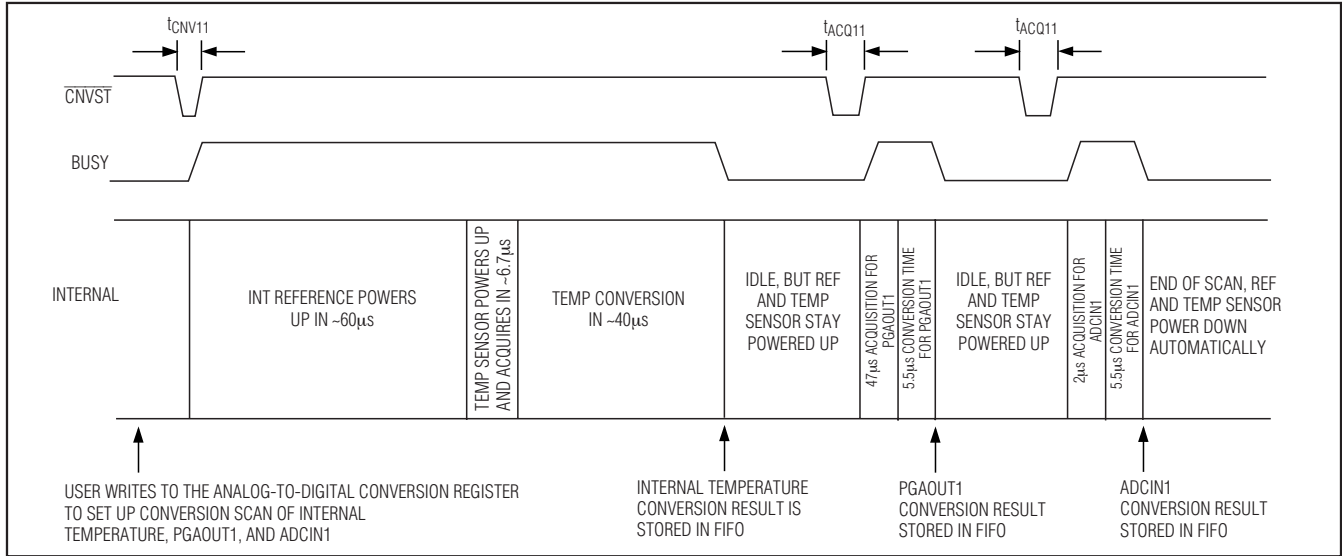

Figure 23. ADC Clock Mode 11, Example 1

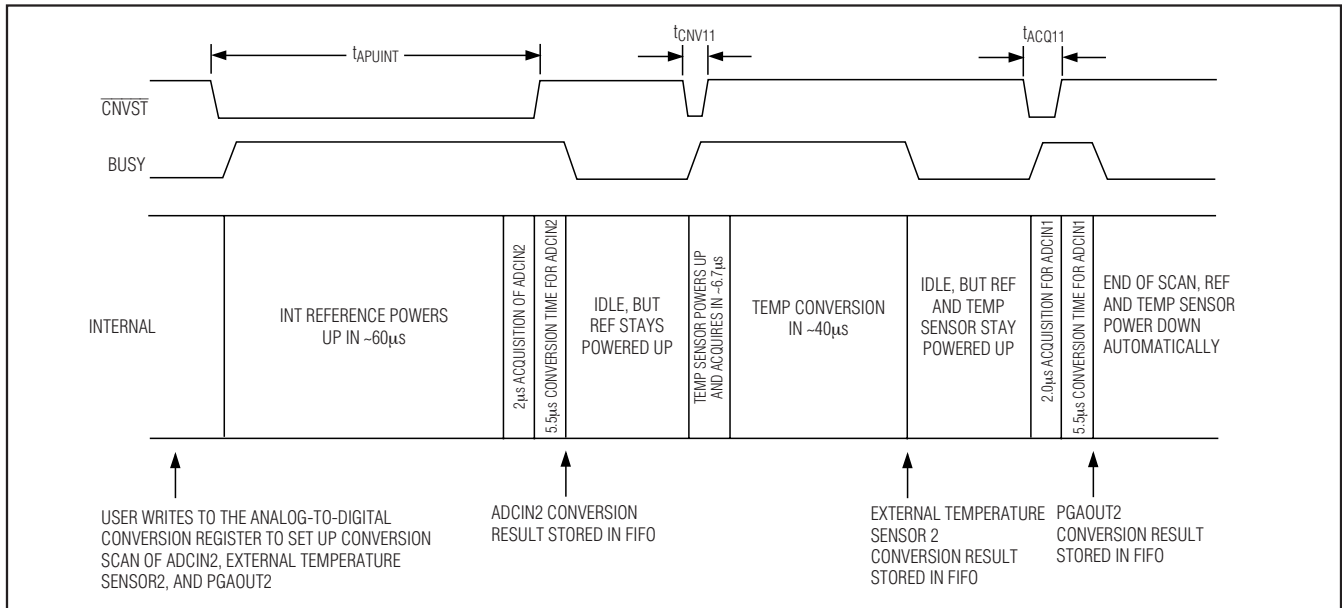

Figure 24. ADC Clock Mode 11, Example 2

- Write to the Fine DAC1/DAC2 Write-Through Input register without autocalibration (FINETHRU1/FINETHRU2). If the coarse DAC1/DAC2 low wiper is higher than the coarse DAC1/DAC2 high wiper, invert the fine DAC1/DAC input register code.

The resulting output when the high wiper is higher than the low wiper is shown below:

$$\frac{V_{DACREF}}{2^{18}} \times \text{FINECODE} + \frac{V_{DACREF}}{2^8} \times \text{LOWCODE}$$

where FINECODE is the value written to the Fine DAC1/DAC2 Input register, and LOWCODE is the value

# Dual RF LDMOS Bias Controllers with I2C/SPI Interface

MAX1385/MAX1386

**Table 27. Basic Software Initialization**

COMMAND BYTE	DATA WORD	DESCRIPTION
0x64	0x0008	Bring the device out of shutdown mode.
0x64	0x0008	Set internal reference and both DAC channels on.
0x20	0x02A8	Set the channel 1 high-temperature threshold to +85°C.
0x22	0x0EC0	Set the channel 1 low-temperature threshold to -40°C.
0x24	0x02C1	Set the channel 1 high-current threshold to 4.3A for 50mΩ R <sub>SENSE</sub> , AvPGA = 2, and V <sub>REFADC</sub> = 2.5V.
0x26	0x0106	Set the channel 1 low-current threshold to 1.6A for 50mΩ R <sub>SENSE</sub> , AvPGA = 2, and V <sub>REFADC</sub> = 2.5V.
0x28	0x02A8	Set the channel 2 high-temperature threshold to +85°C.
0x2A	0x0EC0	Set the channel 2 low-temperature threshold to -40°C.
0x2C	0x02C1	Set the channel 2 high-current threshold to 4.3A for 50mΩ R <sub>SENSE</sub> , AvPGA = 2, and V <sub>REFADC</sub> = 2.5V.
0x2E	0x0106	Set the channel 2 low-current threshold to 1.6A for 50mΩ R <sub>SENSE</sub> , AvPGA = 2, and V <sub>REFADC</sub> = 2.5V.
0x30	0x000F	Set AvPGA <sub>1</sub> and AvPGA <sub>2</sub> to 2, clock mode to 00 and ADC/DAC references to internal.
0x32	0x0000	Set ALARM, SAFE1, and SAFE2 to depend on nothing (POR).
0x60	0x0000	Set ALARM, SAFE1, and SAFE2 for push-pull/active-high (POR).
0x74	0x00CC	Set coarse DAC1 high wiper to 204.
0x76	0x0066	Set coarse DAC1 low wiper to 102 (V <sub>GATE</sub> = 1.99V for MAX1385, V <sub>GATE</sub> = 3.98V for MAX1386).
0x7A	0x00CC	Set coarse DAC2 high wiper to 204.
0x7C	0x0066	Set coarse DAC2 low wiper to 102 (V <sub>GATE</sub> = 1.99V for MAX1385, V <sub>GATE</sub> = 3.98V for MAX1386).
0x52	0x01FF	Set fine DAC1 to midscale.
0x56	0x01FF	Set fine DAC2 to midscale.

**Table 26. Temperature-Threshold Settings Examples**

TEMPERATURE SETTING	TWO'S COMPLEMENT
-40°C	1110 1100 0000
-1.625°C	1111 1111 0011
0°C	0000 0000 0000
+27.125°C	0000 1101 1001
+105°C	0011 0100 1000

written to the Coarse DAC1/DAC2 Input Low Wiper register. The resulting output when the low wiper is higher than the high wiper is:

$$-\frac{V_{DACREF}}{2^{18}} \times \text{FINECODE} + \frac{V_{DACREF}}{2^8} \times \text{LOWCODE}$$

### Basic Software Initialization

The MAX1385/MAX1386 do not power on all internal blocks when full power is first applied. Software must write to register 0x64 twice with bit D7 set to 0 during initialization to enable full operation. A basic initialization sequence is shown in Table 27.

### Regulating VGS vs. Temperature

The MAX1385/MAX1386 can be used along with a microcontroller to perform closed-loop regulation of the LDMOS FET bias current. For example, software can read the temperature and use a calibrated look-up table to determine a new value for the gate drive.

As an example, in noncontinuous conversion mode, read temperature from remote diode 1 by writing to the ADCCON register (0x62) with bit D1 set to 1. Wait for BUSY to go high and then low. Read the ADC result from the FIFO (0x80). The result bits D15–D12 = 0001 indicate the measurement source is the external temperature sensor DXP1/DXN1, and bits D11–D3 indicate two's-complement temperature in degrees Celsius. Bits D2, D1, and D0 are temperature subLSBs.

Gate voltage drive range must be previously determined during initialization by setting the coarse DAC1 high and low limits. Write a new value to FINETHRU1 to immediately change the output GATE1 between the high and low wiper limits based on the previous temperature measurement.

The regulation software may also use the alarm threshold limits to determine whether temperature and current

# Dual RF LDMOS Bias Controllers with I2C/SPI Interface

**Table 28. DAC Write Commands Without Autocalibration**

ACTION REQUIRED	RECOMMENDED COMMAND SEQUENCE	OTHER POSSIBLE COMMAND SEQUENCES
Update fine DAC_ without triggering autocalibration.	Write to FINE_. Write to LDAC to update fine DAC_.	Write to FINETHRU_ to immediately update fine DAC_.
Update high wiper coarse DAC_ without triggering autocalibration.	Write to HIWIPE_ with HCAL set to 0. Write to LDAC to update high wiper coarse DAC_.	Write to THRUHI_ to immediately update high wiper coarse DAC_.
Update low wiper coarse DAC_ without triggering autocalibration.	Write to LOWIPE_ with LCAL set to 0. Write to LDAC to update low wiper coarse DAC_.	Write to THRULO_ to immediately update low wiper coarse DAC_.
Immediately update fine DAC_ without triggering autocalibration.	Write to FINETHRU_.	None.
Immediately update high wiper coarse DAC_ without triggering autocalibration.	Write to THRUHI_.	None.
Immediately update low wiper coarse DAC_ without triggering autocalibration.	Write to THRULO_.	None.
Update the high, low, and fine components of DAC_ simultaneously without triggering autocalibration.	Write to HIWIPE_, LOWIPE, and FINE_. Write to LDAC to update DAC_.	None.

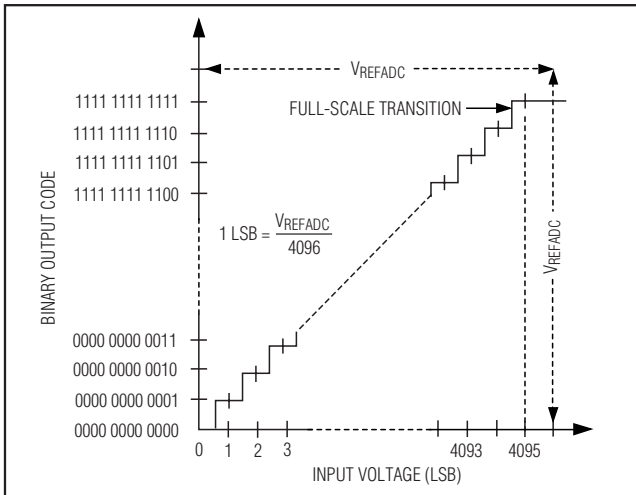

Figure 25. ADC Transfer Function

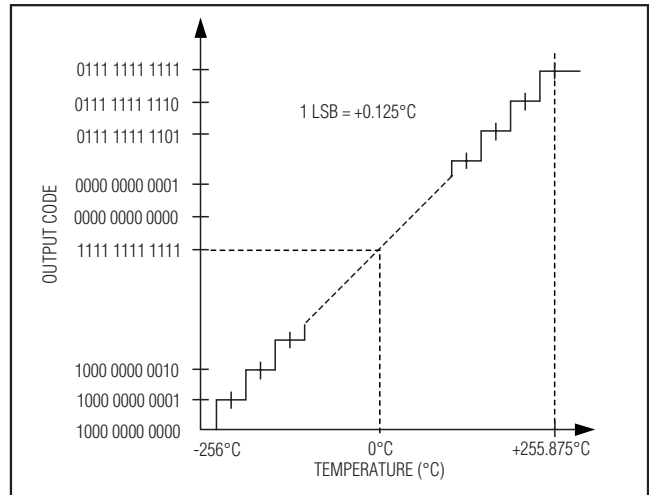

Figure 26. Temperature Transfer Function

limits are within the safe operating area. Configure the ADC for continuous conversions to allow continuous measurement and testing against configured alarm thresholds. Connect SAFE\_ to OPSAFE\_ to immediately force the gate drive to GATEGND in the event of an alarm-related condition (current or temperature).

### Triggering DAC Calibration

Performing the autocalibration routines requires use of the internal ADC, the internal ALU, and can also increase the power dissipation of the part. Tables 28 and 29 detail which commands trigger autocalibration and which commands do not.



# Dual RF LDMOS Bias Controllers with I2C/SPI Interface

MAX1385/MAX1386

**Table 29. DAC Write Commands with Autocalibration**

ACTION REQUIRED	RECOMMENDED COMMAND SEQUENCE	OTHER POSSIBLE COMMAND SEQUENCES
Update fine DAC_ and trigger autocalibration.	Write to FINECAL_. Autocalibration begins after writing to FINECAL_. Write to LDAC to update fine DAC_.	Write to FINECALTHRU_ to immediately update fine DAC_.
Update high wiper coarse DAC_ and trigger autocalibration.	Write to HIWIPE_ with HCAL set to 1. Autocalibration begins after writing to LDAC and high wiper coarse DAC_ is updated thereafter.	None.
Update low wiper coarse DAC_ and trigger autocalibration.	Write to LOWIPE_ with LCAL set to 1. Autocalibration begins after writing to LDAC and low wiper coarse DAC_ is updated thereafter.	None.
Immediately update fine DAC_ and trigger autocalibration.	Write to FINECALTHRU_.	None.
Immediately update high wiper coarse DAC_ and trigger autocalibration.	This action is not possible. See the recommended sequence above "Update high wiper coarse DAC_ and trigger autocalibration."	None.
Immediately update low wiper coarse DAC_ and trigger autocalibration.	This action is not possible. See the recommended sequence "Update low wiper coarse DAC_ and trigger autocalibration."	None.
Update the high, low, and fine components of DAC_.	Write to HIWIPE_ with HCAL set to 1. Write LOWIPE_ with LCAL set to 1. Write to LDAC to update high and low wipers with autocalibrated values. Write to FINECALTHRU_ to trigger fine DAC_ autocalibration and update DAC_.	HIWIPE_ and LOWIPE_ can be written to in any order but must be followed by LDAC and then a fine DAC_ write (to FINECALTHRU_ or FINECAL_ with another LDAC). This ensures that the fine DAC_ autocalibration is run after the coarse DAC_ autocalibration.

# Dual RF LDMOS Bias Controllers with I2C/SPI Interface

Typical Operating Circuit (I2C Mode)

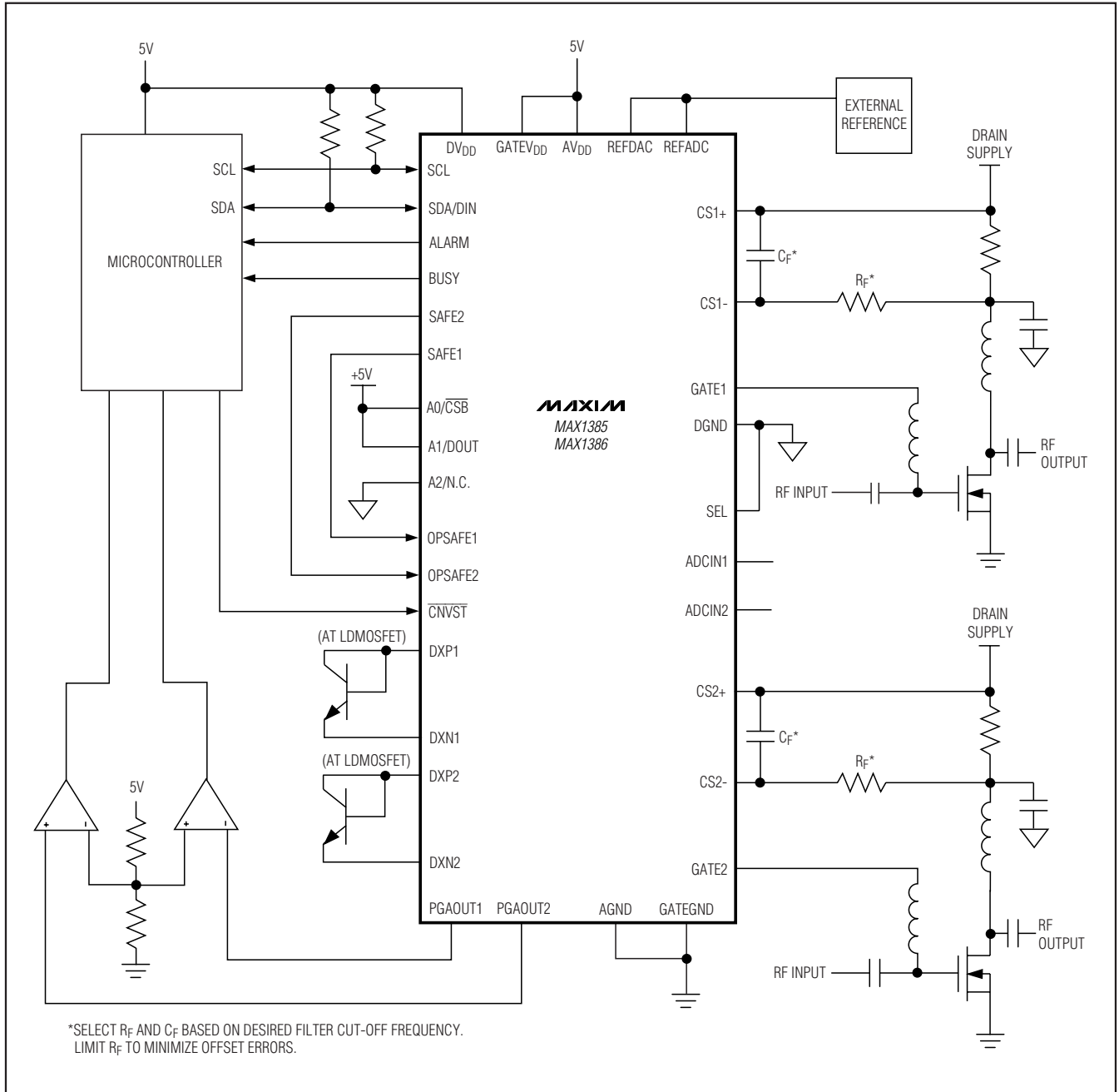

# Dual RF LDMOS Bias Controllers with I<sup>2</sup>C/SPI Interface

## Pin Configuration

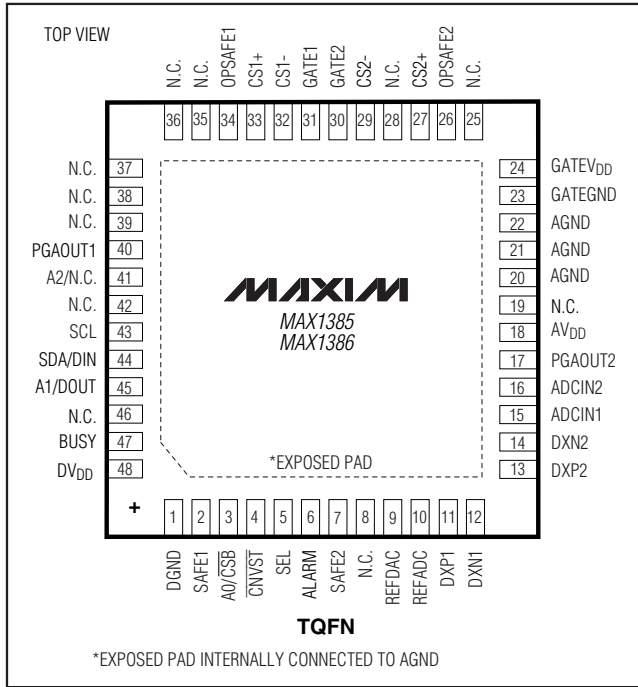

## Package Information

For the latest package outline information and land patterns, go to [www.maxim-ic.com/packages](http://www.maxim-ic.com/packages).

PACKAGE TYPE	PACKAGE CODE	DOCUMENT NO.
48 TQFN-EP	T4877-6	<a href="#">21-0044</a>

**MAX1385/MAX1386**

# Dual RF LDMOS Bias Controllers with I<sup>2</sup>C/SPI Interface

## Appendix: Recommended Power-Up Code Sequence

The following section shows the recommended startup code for the MAX1385. This code ensures clean startup

of the part, irrespective of power-supply ramp speed and starts the device regulating to 312.5mV on both channels. Change the THRUDAC writes to change the voltage across the sense resistor. Note it should be run after the power supplies have stabilized.

REGISTER MNEMONIC	REGISTER ADDRESS (hex)	CODE WRITTEN	NOTES
SHUT	0x64	0x0080	Removes the global power.
SHUT	0x64	0x0080	Powers up all parts of the MAX1385 and forces the internal reference to remain powered. The internal oscillator is required for the subsequent reset command.
SCLR	0x68	0x0100	Arms the full reset.
SCLR	0x68	0x0200	Completes the full reset.
SCLR	0x68	0x0100	Arms the full reset.*
SCLR	0x68	0x0200	Completes the full reset.*
SHUT	0x64	0x0080	Removes the global power.
SHUT	0x64	0x0080	Powers up all parts of the MAX1385 and forces the internal reference to remain powered. The internal oscillator is required for the subsequent reset command.
DCFIG	0x30	0x000A	Selects internal references for both DAC and ADC.
PGACAL	0x4E	0x0002	Runs autocalibration on both PGA channels to set the input referred offset to < 50 $\mu$ V. Busy goes low after approximately 30ms and then the V <sub>GATE</sub> DACs can be set.

\*Double reset. This ensures that the internal ROM is reset correctly after power-up and that the ROM data is latched correctly irrespective of power-supply ramp speed.

Maxim cannot assume responsibility for use of any circuitry other than circuitry entirely embodied in a Maxim product. No circuit patent licenses are implied. Maxim reserves the right to change the circuitry and specifications without notice at any time.

52 **Maxim Integrated Products, 120 San Gabriel Drive, Sunnyvale, CA 94086 408-737-7600**