



MAX1531 Evaluation Kit

Evaluates: MAX1530/MAX1531

General Description

The MAX1531 evaluation kit (EV kit) is a fully assembled and tested surface-mount circuit board that provides logic and bias power required for liquid crystal display (LCD) monitors. The EV kit contains a step-down switching regulator, a logic-supply linear regulator, a source-driver-supply linear regulator, a gamma-reference linear regulator, a two-stage positive charge pump and linear regulator for the TFT gate-on supply, and a one-stage negative charge pump and linear regulator for the TFT gate-off supply. The source-driver supply, the gamma-reference supply, the gate-on supply, and the gate-off supply can be sequenced in any power-up order. The EV kit also includes a MAX1522 step-up switching regulator to provide a higher output voltage option for the source-driver supply and the gamma reference.

The EV kit produces the output voltages listed in the features column using a +10.5V to +24V input voltage range. The input range can be reduced to +9.5V if the included MAX1522 step-up regulator circuit is used. If lower output voltages are acceptable, the input range can be further reduced to +8V.

The EV kit features undervoltage protection for the input, overcurrent protection for the step-down switching regulator, and overload protection for the source-drive linear regulator. Operation at 500kHz allows the use of small surface-mount components. The EV kit also evaluates the MAX1530.

Component List

DESIGNATION	QTY	DESCRIPTION
C1, C4	2	1 μ F \pm 10%, 25V X7R ceramic capacitors (0805) TDK C2012X7R1E105K
C2, C23	0	Not installed capacitors (0603)
C3	1	4.7 μ F \pm 10%, 25V X7R ceramic capacitor (1210) TDK C3225X7R1E475K
C5, C6, C8, C11, C14, C15, C17, C18, C20	9	0.1 μ F \pm 10%, 50V X7R ceramic capacitors (0603) TDK C1608X7R1H104K
C7	1	22 μ F \pm 20%, 6.3V X7R ceramic capacitor (1206) TDK C3216X7R0J226M

Features

- ◆ **Output Voltages (Input Range = +10.5V to +24V or +9.5V to +24V Using Included MAX1522 Circuit)**
 - +3.3V Output at 1.5A (Step-Down Switching Regulator)
 - +2.5V Output at 500mA (Logic-Supply Regulator)
 - +10V Output at 500mA (Source-Driver Supply Regulator)
 - +9.7V Output at 50mA (Gamma-Reference Regulator)
 - +25V Output at 25mA (Positive Charge Pump and Linear Regulator)
 - 9V Output at 50mA (Negative Charge Pump and Linear Regulator)
- ◆ **+8V to +24V Input Range (Reduced Output Voltages)**
- ◆ **Resistor-Adjustable Outputs**
- ◆ **92% Efficiency (Step-Down Switching Regulator)**
- ◆ **250kHz/500kHz Selectable Step-Down Switching Frequency**
- ◆ **Programmable Power-Up Sequencing**
- ◆ **Soft-Start for All Outputs**
- ◆ **Multilevel Protection**
 - Resistor-Adjustable Input Undervoltage Threshold
 - Output Undervoltage Shutdown
 - Overcurrent Protection for One Linear Regulator
 - Current Limit for the Step-Down Switching Regulator
- ◆ **External Step-Up Switching Regulator (MAX1522) Included**
- ◆ **Also Evaluates the MAX1530 (IC Replacement Required)**
- ◆ **Low-Profile, Surface-Mount Components**
- ◆ **Fully Assembled and Tested**

Ordering Information

PART	TEMP RANGE	IC PACKAGE
MAX1531EVKIT	0°C to +70°C	32 TQFN (5mm x 5mm)



For pricing, delivery, and ordering information, please contact Maxim/Dallas Direct! at 1-888-629-4642, or visit Maxim's website at www.maxim-ic.com.

MAX1531 Evaluation Kit

Evaluates: MAX1530/MAX1531

Component List (continued)

DESIGNATION	QTY	DESCRIPTION
C9	1	10 μ F \pm 20%, 6.3V X5R ceramic capacitor (1206) TDK C3216X5R0J106M
C10	1	470pF \pm 10%, 50V X7R ceramic capacitor (0603) TDK C1608X7R1H471K
C12, C19	2	0.47 μ F \pm 10%, 16V X7R ceramic capacitors (0805) TDK C2012X7R1C474K
C13, C25	2	4.7 μ F \pm 10%, 16V X7R ceramic capacitors (1206) TDK C3216X7R1C475K
C16	1	0.47 μ F \pm 20%, 50V X7R ceramic capacitor (1210) TDK C3225X7R1H474M
C21, C22	2	2.2 μ F \pm 10%, 25V X7R ceramic capacitors (1206) TDK C3216X7R1E225K
C24	1	10 μ F \pm 20%, 25V X5R ceramic capacitor (1210) TDK C3225X5R1E106M
C26	1	1 μ F \pm 10%, 10V X5R ceramic capacitor (0603) TDK C1608X5R1A105K
D1, D6	2	100mA, 30V Schottky diodes (SOD-523) Central Semiconductor CMOSH-3
D2	1	1A, 30V Schottky diode (S-flat) Toshiba CRS02
D3, D4, D5	3	250mA, 100V dual diodes (SOT23) Central Semiconductor CMPD6001S
D7	1	250mA, 75V high-speed silicon diode (SOD-523) Central Semiconductor CMOD4448
JU1, JU12–JU16	6	3-pin headers
JU2, JU3	2	2-pin headers
JU4–JU7	4	3-way jumpers (4 pins)
JU8–JU11	4	4-way jumpers (5 pins)

DESIGNATION	QTY	DESCRIPTION
L1	1	10 μ H, 2.3A _{DC} inductor Sumida CDR7D28MN-100
L2	1	22 μ H, 0.90A _{DC} inductor Sumida CDRH5D28-220
N1	1	2.5A, 30V dual n-channel MOSFET (Super SOT-6) Fairchild Semiconductor FDC6561AN
N2	1	5.2A, 30V n-channel MOSFET (Super SOT-6) Fairchild Semiconductor FDC633N
Q1, Q4	2	3A, 60V low-saturation pnp bipolar transistors (SOT-223) Fairchild Semiconductor NZT660A
Q2, Q3	2	200mA, 40V pnp bipolar transistors (SOT23) Central Semiconductor CMPT3906
Q5, Q6	2	200mA, 40V npn bipolar transistors (SOT23) Central Semiconductor CMPT3904
R1	1	17.8k Ω \pm 1% resistor (0805)
R2, R23	2	10.7k Ω \pm 1% resistors (0805)
R3	1	124k Ω \pm 1% resistor (0805)
R4	1	20.0k Ω \pm 1% resistor (0805)
R5, R6, R7, R11	4	100k Ω \pm 5% resistors (0805)
R8, R17, R24, R27	4	6.8k Ω \pm 5% resistors (0805)
R9, R10, R19, R32	4	10.0k Ω \pm 1% resistors (0805)
R12	1	301k Ω \pm 1% resistor (0805)
R13	1	221k Ω \pm 1% resistor (0805)
R14	1	121k Ω \pm 1% resistor (0805)
R15, R18	2	68.1k Ω \pm 1% resistors (0805)
R16	1	43.2k Ω \pm 1% resistor (0805)
R21	1	1.5k Ω \pm 5% resistor (0805)
R22	1	75.0k Ω \pm 1% resistor (0805)
R25	1	200k Ω \pm 1% resistor (0805)
R26	1	10.5k Ω \pm 1% resistor (0805)

MAX1531 Evaluation Kit

Evaluates: MAX1530/MAX1531

Component List (continued)

DESIGNATION	QTY	DESCRIPTION
R28	1	90.9kΩ ±1% resistor (0805)
R29	1	48.7kΩ ±1% resistor (0805)
R30	1	1Ω ±5% resistor (0805)
R31	1	110kΩ ±1% resistor (0805)
R33	1	0.050Ω ±1% resistor (1206) IRC LRC-LR 1206-01-R050-F
R34	0	Not installed resistor (0805)
R35, R36	2	1.00Ω ±1% resistors (0805)
R37, R38	2	10Ω ±5% resistors (0805)
R39-R42	4	2.0kΩ ±5% resistors (0805)
U1	1	MAX1531ETJ (32-pin TQFN)
U2	1	MAX1522EUT-T (6-pin SOT23)
None	16	Shunts (see table for jumper settings)
None	1	MAX1531 PC board

Quick Start

The MAX1531 EV kit is fully assembled and tested. Follow these steps to verify board operation. **Do not turn on the power supply until all connections are completed.**

The MAX1531 EV kit operates with up to +24V inputs. However, due to external-component voltage stress limitations, default jumper configurations must be modified for operation above +13.2V. See the *Positive Charge Pump* and *Gate-On Linear Regulator Output Voltage (GON)* sections.

Recommended Equipment

- +10.5V to +13.2V, 2A DC power supply
 - One voltmeter
- Verify that a shunt is across pins 1 and 2 of jumpers JU1, JU10, and JU12.
 - Verify that there are no shunts across jumpers JU2 and JU3.

- Verify that a shunt is across pins 1 and 3 of jumpers JU4, JU5, JU6, JU7, and JU8.
- Verify that a shunt is across pins 1 and 5 of jumper JU9.
- Verify that a shunt is across pins 1 and 4 of jumper JU11.
- Verify that a shunt is across pins 2 and 3 of jumpers JU13, JU14, JU15, and JU16.
- Connect the positive terminal of the input power supply to the PIN pad. Connect the negative terminal of the input power supply to the PGND pad.
- Turn on the power supply and verify that the step-down regulator output (VOUT) is +3.3V.
- Verify that the internal 5V linear regulator output (VL) is +5V.
- Verify that the logic-supply linear regulator output (VLOG) is +2.5V.
- Verify that the source-driver-supply linear regulator output (VSRC) is +10V.
- Verify that the gamma-reference linear regulator output (VGAM) is +9.7V.
- Verify that the gate-on linear regulator output (GON) is +25V.
- Verify that the gate-off linear regulator output (GOFF) is -9V.

For instructions on selecting the feedback resistors for other output voltages, see the *Output Voltage Selection* section.

Detailed Description

The MAX1531 EV kit contains a step-down switching regulator, a linear regulator for a low-voltage logic supply, a high-current linear regulator for a source-driver supply, a linear regulator for a gamma reference, a two-stage positive charge pump with a positive high-voltage linear regulator, and a one-stage negative charge pump with a negative linear regulator. The EV kit operates from a +10.5V and +24V DC power supply, which

Component Suppliers

SUPPLIER	PHONE	FAX	WEBSITE
Central Semiconductor	631-435-1110	631-435-1824	www.centalsemi.com
Fairchild	888-522-5372	—	www.fairchildsemi.com
IRC	361-992-7900	361-992-3377	www.irctt.com
Sumida	847-545-6700	847-545-6720	www.sumida.com
TDK	847-803-6100	847-390-4405	www.component.tdk.com
Toshiba	949-455-2000	949-859-3963	www.toshiba.com/taec

Note: Indicate you are using the MAX1530/MAX1531 when contacting these manufacturers.

MAX1531 Evaluation Kit

can provide at least 2A. The step-down switching regulator's switching frequency is jumper configurable between 250kHz and 500kHz. The adjustable input undervoltage protection (EN) protects the EV kit from undervoltage conditions. The step-up switching regulator and the source-drive regulator are protected against overloads.

The step-down switching regulator (VOUT) generates a +3.3V output and can provide at least 1.5A. The step-down switching-regulator output voltage can be adjusted as low as +1.24V using different feedback resistors (see the *Output Voltage Selection* section).

The logic voltage supply (VLOG) is set to +2.5V using a linear regulator controller and an external pnp bipolar pass transistor. This logic voltage supply can provide at least 500mA of current. The logic-voltage-supply linear regulator's output can be adjusted between +1.24V and its input supply, which is the step-down regulator's output voltage (see the *Output Voltage Selection* section).

The source-driver supply (VSRC) is set to +10V using a linear regulator controller and an external pnp bipolar pass transistor. This source-driver supply can provide at least 500mA of current. The source-drive linear regulator's output can be adjusted between +1.24V and its input voltage, which is either the EV kit input voltage (PIN) or the output of the MAX1522 step-up regulator, depending on jumper JU15 (see the *Output Voltage Selection* section).

The gamma reference (VGAM) is set to +9.7V using a linear regulator controller and an external pnp bipolar pass transistor. This gamma reference can provide at least 50mA of current. The gamma linear regulator's output can be adjusted between +1.24V and its input voltage, which is either the EV kit input voltage (PIN) or the output of the MAX1522 step-up regulator, depending on jumper JU14 (see the *Output Voltage Selection* section).

The TFT gate-on supply (GON) uses a two-stage positive charge pump to generate approximately +33V. The output is postregulated to +25V using a linear regulator controller and an external pnp bipolar pass transistor and can provide at least 25mA. The positive linear regulator's output can be adjusted between +1.24V and its input, which depends on the EV kit's input voltage and the charge-pump configuration, jumpers JU12 and JU13 (see the *Output Voltage Selection* section).

The TFT gate-off supply (GOFF) uses a negative charge pump to generate approximately -11V. The output is postregulated to -9V using a linear regulator controller and an external npn bipolar pass transistor and can provide greater than 50mA. The negative linear regulator's output can be adjusted between 0V and its input volt-

age, which is the output of the negative charge pump (see the *Output Voltage Selection* section).

The EV kit also features power-up sequencing. After EN and SEQ go high, the logic voltage supply (VLOG) soft-starts. The gamma reference, the gate-on supply, the source-driver supply, and the gate-off supply can soft-start in any sequence by setting the appropriate jumpers (see the *Power-Up Sequencing* section).

The EV kit includes a current-limit circuit for the step-down switching regulator. The current-limit threshold is set by resistor-dividers R12, R13, and the $R_{DS(on)}$ of MOSFET N1 (refer to the *MOSFET Selection and Current-Limit Setting* section in the MAX1531 data sheet for further detail). The EV kit also includes current overload protection for the source-driver supply voltage. The MAX1531 will shut down if the source-driver supply exceeds a current threshold. The output current overload threshold is set by sense resistors R35 and R36 (refer to the *Overcurrent Protection Block (CSH, CSL)* section in the MAX1531 data sheet for further detail).

Jumper Selection

Enable (EN)

The MAX1531 features an enable (EN) pin that enables or disables the MAX1531 and the EV kit's output. The EN pin can also be used with resistor-dividers R3 and R4 to set the lower limit of the input voltage range (refer to the *On/Off Control (EN)* section in the MAX1531 data sheet for further detail). The 3-pin jumper JU1 provides an option to enable, disable, or use the undervoltage threshold feature for the MAX1531 EV kit. Table 1 lists the selectable jumper options.

Table 1. Jumper JU1 Functions

SHUNT LOCATION	EN PIN	MAX1531 (U1) IC STATUS
None	Connected to GND	Disabled
1-2 (Default)	Connected to PIN through resistor-dividers R3 and R4	Enabled when $V_{PIN} > 9V$
2-3	Connected to VL	Enabled

Switching Frequency Selection (FREQ)

The MAX1531 EV kit features an option to choose the step-down switching regulator's operating frequency (JU2). Table 2 lists the selectable jumper options. The EV kit is configured for 500kHz operation. Optimum performance at 250kHz requires a larger inductor value (refer to the *Inductor Selection* section in the MAX1531 data sheet).

MAX1531 Evaluation Kit

Evaluates: MAX1530/MAX1531

Table 2. Jumper JU2 Functions

SHUNT LOCATION	FREQ PIN	MAX1531 EV KIT FREQUENCY
Installed	Connected to GND	Frequency = 250kHz
None (Default)	Connected to VL through R5	Frequency = 500kHz

Power-Up Sequencing (SEQ)

The EV kit features adjustable power-up sequencing for several of the linear regulators. After the MAX1531's EN pin goes high, the internal VL linear regulator starts up and the step-down switching regulator soft-starts. When the step-down regulator reaches regulation, the logic-voltage-supply linear regulator (VLOG) and the sequence block that controls the other four linear regulators are simultaneously enabled. The logic regulator soft-starts immediately but the sequence block starts only if SEQ is high. SEQ is controlled by JU3.

Each linear regulator soft-starts individually when it is enabled. After SEQ goes high, the ONL2 to ONL5 pins each source current into C11, which controls the overall time for startup. Resistors R14, R15, and R16 determine the startup spacing between the respective regulator and JU8 to JU11 determine the startup order. Each regulator starts after SEQ is high and its ONL_ pin

Table 3. Jumper JU3 Function

SHUNT LOCATION	SEQ PIN	MAX1531 STATE
Installed	Connected to GND	Sequence block disabled. VSRC, VGAM, GON, and GOFF disabled, regardless of ONL2 to ONL5 voltage levels.
None (Default)	Connected to VL through R6	Sequence block enabled. Each ONL_ sources 2μA. VGAM soft-starts when ONL2 reaches 1.24V. GON soft-starts when ONL3 reaches 1.24V. VSRC soft-starts when ONL4 reaches 1.24V. GOFF soft-starts when ONL5 reaches 1.24V

exceeds 1.24V. JU4 to JU7 enable immediate startup of their respective regulator after the step-down regulator reaches regulation and SEQ is high, without additional delay. (See the *Power-Up Sequencing* section.) See Tables 3 through 7 for configuring the jumpers.

Table 4. ONL2 Setting (JU4 and JU8)

JU4 SHUNT LOCATION	JU8 SHUNT LOCATION	ONL2 PIN	SEQUENCING MODE
1-2	Don't Care	Connected to VL through R39	Gamma linear regulator enabled immediately if JU3 is removed (SEQ = high) and step-down switching regulator soft-start is finished. Sequence not used.
1-4	Don't Care	Connected to GND	Gamma linear regulator disabled.
1-3 (Default)	1-2	Connected to R14	Gamma linear regulator soft-starts about 6ms after sequence block enabled.
	1-3 (Default)	Connected to R15	Gamma linear regulator soft-starts about 9ms after sequence block enabled.
	1-4	Connected to R16	Gamma linear regulator soft-starts about 12ms after sequence block enabled.
	1-5	Connected to C11	Gamma linear regulator soft-starts about 15ms after sequence block enabled.

MAX1531 Evaluation Kit

Evaluates: MAX1530/MAX1531

Table 5. ONL3 Setting (JU5 and JU9)

JU5 SHUNT LOCATION	JU9 SHUNT LOCATION	ONL3 PIN	SEQUENCING MODE
1-2	Don't Care	Connected to VL through R40	GON linear regulator enabled immediately if JU3 is removed (SEQ = high) and step-down switching regulator soft-start is finished. Sequence not used.
1-4	Don't Care	Connected to GND	GON linear regulator disabled.
1-3 (Default)	1-2	Connected to R14	GON linear regulator soft-starts about 6ms after sequence block enabled.
	1-3	Connected to R15	GON linear regulator soft-starts about 9ms after sequence block enabled.
	1-4	Connected to R16	GON linear regulator soft-starts about 12ms after sequence block enabled.
	1-5 (Default)	Connected to C11	GON linear regulator soft-starts about 15ms after sequence block enabled.

Table 6. ONL4 Setting (JU6 and JU10)

JU6 SHUNT LOCATION	JU10 SHUNT LOCATION	ONL4 PIN	SEQUENCING MODE
1-2	Don't Care	Connected to VL through R41	VSRC linear regulator enabled immediately if JU3 is removed (SEQ = high) and step-down switching regulator soft-start is finished. Sequence not used.
1-4	Don't Care	Connected to GND	VSRC linear regulator disabled.
1-3 (Default)	1-2 (Default)	Connected to R14	VSRC linear regulator soft-starts about 6ms after sequence block enabled.
	1-3	Connected to R15	VSRC linear regulator soft-starts about 9ms after sequence block enabled.
	1-4	Connected to R16	VSRC linear regulator soft-starts about 12ms after sequence block enabled.
	1-5	Connected to C11	VSRC linear regulator soft-starts about 15ms after sequence block enabled.

MAX1531 Evaluation Kit

Evaluates: MAX1530/MAX1531

Table 7. ONL5 Setting (JU7 and JU11)

JU7 SHUNT LOCATION	JU11 SHUNT LOCATION	ONL5 PIN	SEQUENCING MODE
1-2	Don't Care	Connected to VL through R42	GOFF linear regulator enabled immediately if JU3 is removed (SEQ = high) and step-down switching regulator soft-start is finished. Sequence not used.
1-4	Don't Care	Connected to GND	GOFF linear regulator disabled.
1-3 (Default)	1-2	Connected to R14	GOFF linear regulator soft-starts about 6ms after sequence block enabled.
	1-3	Connected to R15	GOFF linear regulator soft-starts about 9ms after sequence block enabled.
	1-4 (Default)	Connected to R16	GOFF linear regulator soft-starts about 12ms after sequence block enabled.
	1-5	Connected to C11	GOFF linear regulator soft-starts about 15ms after sequence block enabled.

Positive Charge Pump

The positive charge pump of the MAX1531 EV kit powers the GON linear regulator and features an option to cascade up to two charge-pump stages. The charge pump's first stage can be connected to PIN or VOUT, and the charge pump's second stage can be connected to PIN or the previous stage. Jumpers JU12 and JU13 configure the number of stages and select the voltage source for the positive charge pump on the MAX1531 EV kit. Tables 8 and 9 list the jumper options. The default configuration of the positive charge pump of the MAX1531 EV kit is a two-stage charge pump powered from PIN as indicated in Tables 8 and 9.

Since the positive charge pump powers the GON linear regulator, ensure that the combination of the charge-pump configuration and the input voltage range (PIN) does not over stress the GON linear regulator's external pass transistor. The V_{CEO} maximum rating of the MMBT3904 used on this EV kit is 40V. If the input voltage (PIN) exceeds +13.2V, either reconfigure the charge pump (using JU12 and JU13) as a two-stage charge pump from VOUT or a one-stage charge pump from PIN, as appropriate, or select a higher-voltage-rated transistor for Q3. Also, if higher charge-pump voltages are required, ensure that Q6 and C15 are not over stressed. Refer to the *Charge Pumps* section of the MAX1531 data sheet for more information on selecting a charge-pump configuration.

Table 8. Jumper JU12 Functions

SHUNT LOCATION	1ST STAGE POSITIVE CHARGE PUMP	OPERATING MODE
1-2 (Default)	Connected to PIN	First stage of a two-stage charge pump connected to PIN.
2-3	Connected to VOUT	First stage of a two-stage charge pump connected to VOUT.
None	Not used	The first stage is not used for one-stage charge pumps.

Table 9. Jumper JU13 Functions

SHUNT LOCATION	2ND STAGE POSITIVE CHARGE PUMP	OPERATING MODE
1-2	Connected to PIN	One-stage charge pump connected to PIN.
2-3 (Default)	Connected to previous stage charge-pump output	Last stage of a two-stage charge pump.
None	Not used	Charge pump not used.

MAX1531 Evaluation Kit

VGAM Power Supply

The power supply for the VGAM linear regulator can be connected to PIN or STEP_UP. PIN is the input voltage for the EV kit. STEP_UP is the output of the MAX1522 step-up switching regulator circuit on the EV kit. Jumper JU14 selects the power supply for the VGAM linear regulator on the MAX1531 EV kit. Table 10 lists the jumper options.

Table 10. Jumper JU14 Functions

SHUNT LOCATION	VGAM POWER SUPPLY	OPERATING MODE
1-2	Connected to STEP_UP	VGAM powered from the output of the MAX1522 step-up regulator.
2-3 (Default)	Connected to PIN	VGAM powered from PIN.
None	Not used	VGAM not used.

VSRC Power Supply

The power supply for the VSRC linear regulator can be connected to PIN or STEP_UP. PIN is the input voltage for the EV kit. STEP_UP is the output of the MAX1522 step-up switching regulator circuit on the EV kit. Jumper JU15 selects the power supply for the VSRC linear regulator on the MAX1531 EV kit. Table 11 lists the jumper options.

Table 11. Jumper JU15 Functions

SHUNT LOCATION	VSRC POWER SUPPLY	OPERATING MODE
1-2	Connected to STEP_UP	VSRC powered from the output of the MAX1522 step-up regulator.
2-3 (Default)	Connected to PIN	VSRC powered from PIN.
None	Not used	VSRC not used.

The MAX1522 Step-Up Circuit

The MAX1531 EV kit includes a MAX1522 step-up switching regulator. This regulator is not generally needed, but is provided as a convenience for applications where the input voltage (PIN) can be less than VSRC. If the step-up is needed, enable the MAX1522

Table 12. Jumper JU16 Functions

SHUNT LOCATION	MAX1522 SHDN PIN	MAX1522 OPERATING MODE
1-2	Connected to VOUT	Enabled
2-3 (Default)	Connected to GND	Disabled

using JU16 and set JU14 and JU15 so that VGAM and VSRC use the step-up's output.

Output Voltage Selection

Step-Down Switching-Regulator Output Voltage (VOUT)

The MAX1531 EV kit's step-down switching-regulator output (VOUT) is set to +3.3V by feedback resistors R1 and R2. To generate output voltages other than +3.3V (from +1.24V up to $0.6 \times V_{PIN}$), select different external voltage-divider resistors (R1, R2). Output capacitor C7 is rated to +6.3V. To set the output voltage greater than +6.3V, use a higher-voltage-rated capacitor. Refer to the *Main Step-Down Regulator Output Voltage Selection* section in the MAX1531 data sheet for instructions on selecting the resistors.

Logic-Voltage-Supply Linear Regulator Output Voltage (VLOG)

The MAX1531 EV kit's logic-voltage-supply linear regulator output (VLOG) is set to +2.5V by feedback resistors R9 and R10. To generate output voltages other than +2.5V (from +1.24V up to VOUT) select different external voltage-divider resistors (R9, R10). Output capacitor C9 is rated to +6.3V. To set the output voltage greater than +6.3V, use a higher-voltage-rated capacitor. Refer to the *Linear-Regulator Controllers Output Voltage Selection* section in the MAX1531 data sheet for instructions on selecting the resistors.

Gamma-Reference Linear Regulator Output Voltage (VGAM)

The MAX1531 EV kit's gamma-reference linear regulator output (VGAM) is set to +9.7V by feedback resistors R18 and R19. To generate output voltages other than +9.7V (from +1.24V up to its input voltage) select different external voltage-divider resistors (R18, R19). Output capacitor C12 is rated to +16V. To set the output voltage greater than +16V, use a higher-voltage-rated capacitor. Refer to the *Linear-Regulator Controllers Output Voltage Selection* section in the MAX1531 data sheet for instructions on selecting the resistors.

MAX1531 Evaluation Kit

Evaluates: MAX1530/MAX1531

Gate-On Linear Regulator Output Voltage (GON)

The MAX1531 EV kit's gate-on linear regulator output (GON) is set to +25V by feedback resistors R25 and R26. To generate output voltages other than +25V (from +1.24V up to the linear regulator's input, which is the output of the positive charge pump), select different external voltage-divider resistors (R25, R26). Take care not to exceed either the pnp pass transistor's V_{CEO} rating (40V) or the output capacitor's (C16) +50V rating.

Before GON is enabled, Q3 is off and the positive charge pump's full output voltage is present across Q3. If the input voltage (PIN) exceeds 13.2V, do not power the EV kit with the charge pump configured as a two-stage charge pump powered from PIN, as Q3's 40V rating will be exceeded. Configure JU12 and JU13 for a two-stage charge pump powered from VOUT or as a one-stage charge pump powered from PIN, whichever is appropriate. Alternatively, select a different transistor for Q3 and possibly Q6, which must withstand the same voltage, minus V_{PIN}. If V_{PIN} exceeds +20V, even a one-stage charge pump will exceed +40V, so either change Q3 or disable the charge pump entirely and power the linear regulator directly from PIN, whichever is appropriate.

Refer to the *Linear-Regulator Controllers Output Voltage Selection* section in the MAX1531 data sheet for instruction on selecting the voltage-divider resistors. Also, refer to the *Charge Pumps* section for more information about configuring the positive charge pump.

Source-Supply Linear Regulator Output Voltage (VSRC)

The MAX1531 EV kit's source-supply linear regulator output (VSRC) is set to +10V by feedback resistors R22 and R23. To generate output voltages other than +10V (from +1.24V up to its input voltage) select different external voltage-divider resistors (R22, R23). Output capacitor C13 is rated to +16V. To set the output voltage greater than +16V, use a higher-voltage-rated capacitor. Refer to the *Linear-Regulator Controllers Output Voltage Selection* section in the MAX1531 data sheet for instructions on selecting the resistors.

Gate-Off Linear Regulator Output Voltage (GOFF)

The MAX1531 EV kit's negative linear regulator output (GOFF) is set to -9V by feedback resistors R28 and R29. To generate output voltages other than -9V (0V down to its input voltage), select different external voltage-divider resistors (R28, R29). Output capacitor C19 is rated to -16V. To set the output voltage below -16V, use a higher-voltage-rated capacitor. Refer to the *Linear-Regulator Controllers Output Voltage Selection* and *Charge Pumps* sections in the MAX1531 data sheet for instructions on selecting the resistors.

Evaluating the MAX1530

The MAX1531 EV kit can also evaluate the MAX1530. To evaluate the MAX1530, replace U1 with the MAX1530. Refer to the MAX1530/MAX1531 data sheets for additional information.

MAX1531 Evaluation Kit

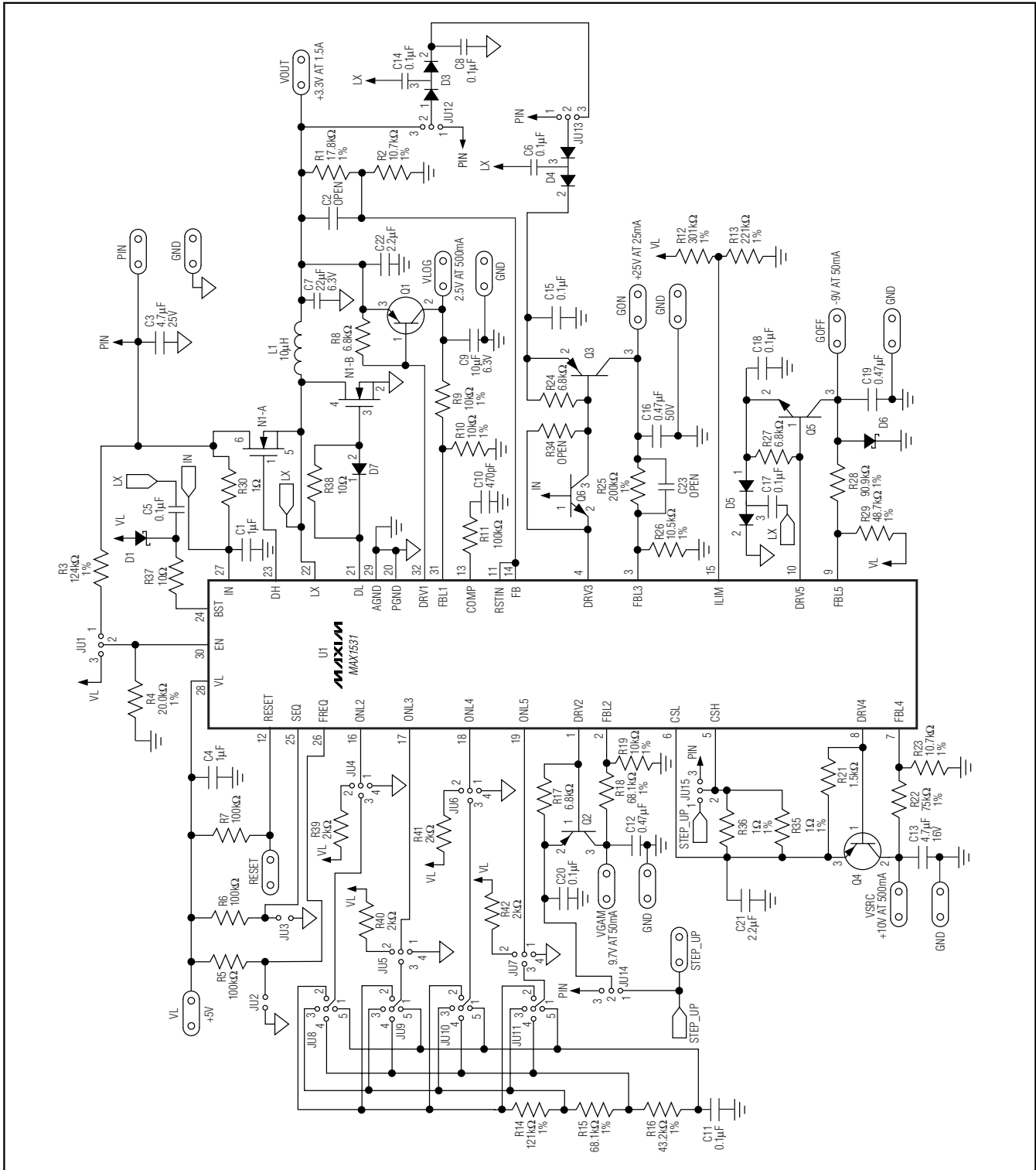

Figure 1. MAX1531 EV Kit Schematic—Sheet 1 of 2

MAX1531 Evaluation Kit

Evaluates: MAX1530/MAX1531

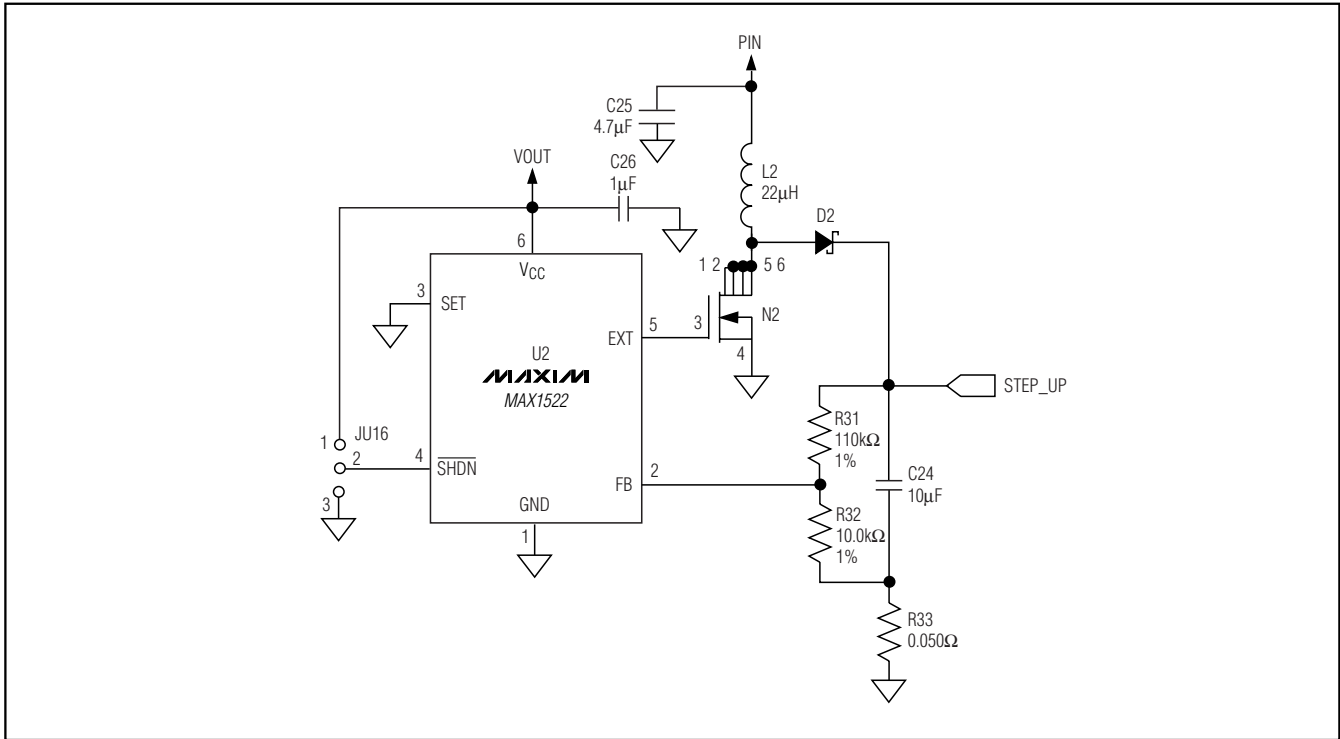

Figure 2. MAX1531 EV Kit Schematic—Sheet 2 of 2

MAX1531 Evaluation Kit

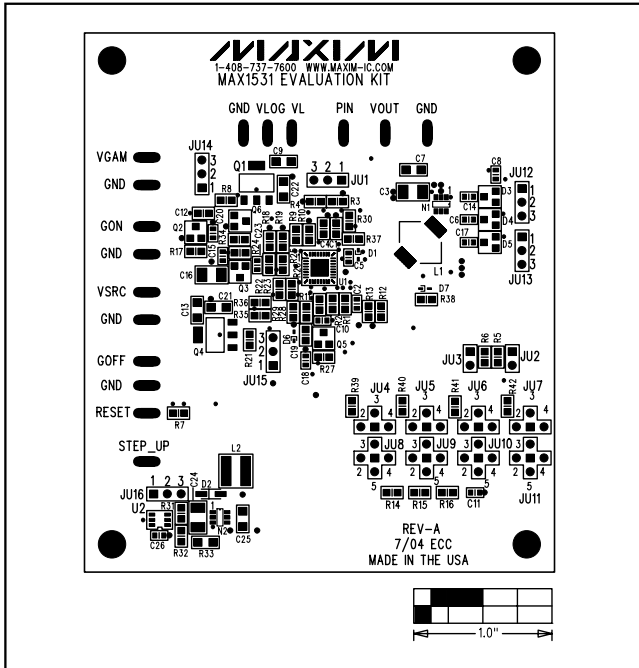

Figure 3. MAX1531 EV Kit Component Placement Guide—Component Side

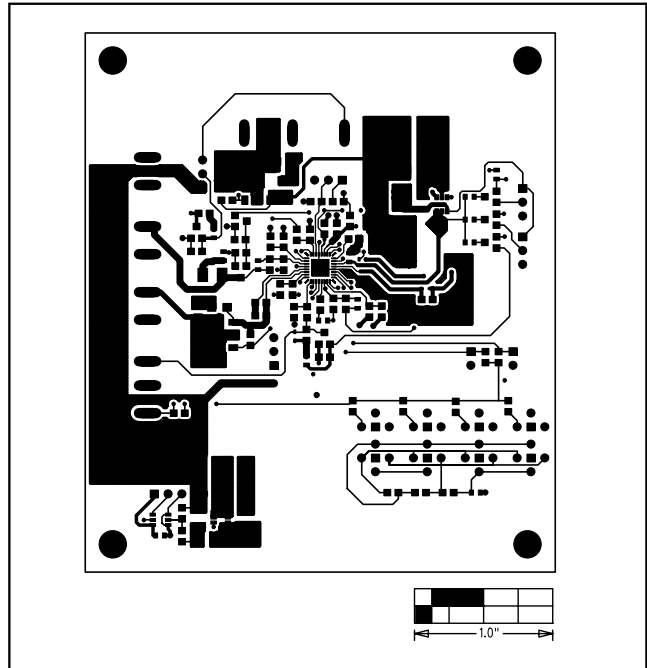

Figure 4. MAX1531 EV Kit PC Board Layout—Component Side

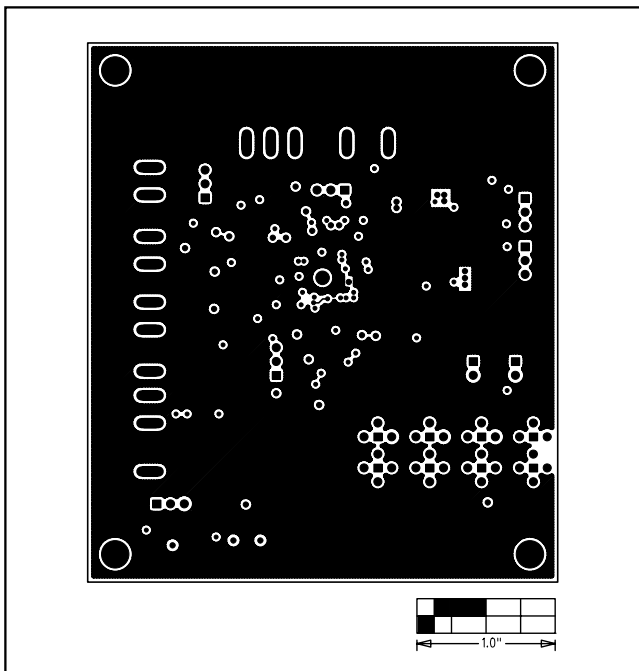

Figure 5. MAX1531 EV Kit PC Board Layout—GND Layer 2

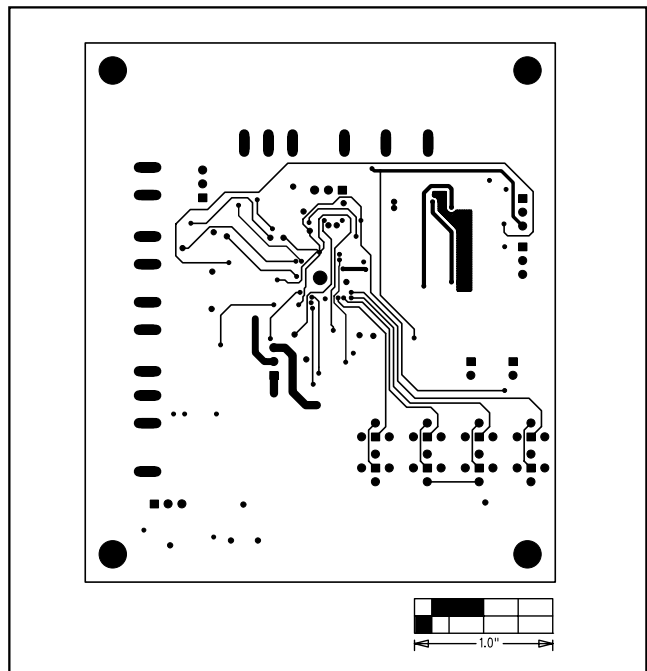

Figure 6. MAX1531 EV Kit PC Board Layout—VCC Layer 3

MAX1531 Evaluation Kit

Evaluates: MAX1530/MAX1531

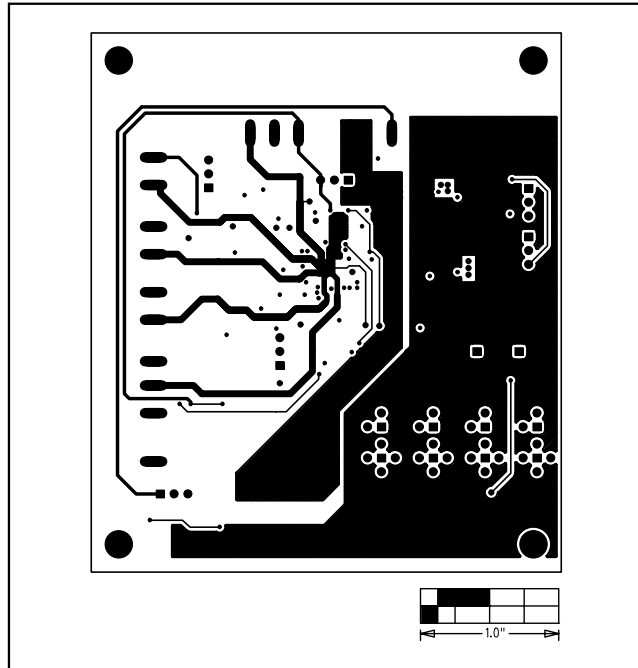

Figure 7. MAX1531 EV Kit PC Board Layout—Solder Side

Maxim cannot assume responsibility for use of any circuitry other than circuitry entirely embodied in a Maxim product. No circuit patent licenses are implied. Maxim reserves the right to change the circuitry and specifications without notice at any time.

Maxim Integrated Products, 120 San Gabriel Drive, Sunnyvale, CA 94086 408-737-7600 _____ 13

© 2004 Maxim Integrated Products

Printed USA

MAXIM is a registered trademark of Maxim Integrated Products.