

OPIA814, OPIA815, OPIA817 OPIA1210, OPIA4010 SMD, SOP and SSOP Packages



Features:

- 5,000 Vrms electrical isolation
- Choice of a Single and Dual LED
- Phototransistor or Photo Darlington Sensor
- Low-cost plastic Dual-In-Line (DIP) package

Agency Approvals:

- UL Certification No: E58730
- VDE No: 40026625 40026536, 40026654

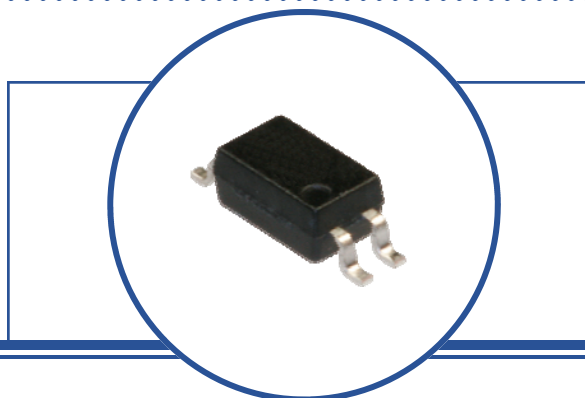

Description:

The OPIA series optocouplers are designed for applications that use an analog output (Phototransistor or Photodarlington) in a surface mount package. A wide selection of configurations are available. With typical isolation voltage of 5,000 Volts(RMS), these products meet typical power system isolation requirements.

Theory of operation: The LED transmitter is used to illuminate the Photosensor providing electrical isolation between two power systems while maintaining the ability to transmit information from one power system to the other. In many applications, analog signal levels may be required to be transmitted between two power systems while maintaining isolation between the power systems up to 5,000 Volts(RMS). A variety of LED and photosensor configurations are available depending on the system requirements.

The ratio Current Transfer Ratio (CTR) is determined using the output current and input current for analog photosensors. CTR ratios can range from as low as 5 to over 9,000 depending on the device.

$$CTR = \frac{\text{Photosensor - Current}}{\text{LED - Current}} = \frac{20mA}{10mA} * 100 = 200$$

All SMD products are shipped in a shipping tube with "TR" identified on the end of the part number.

Example: OPIA817ATRE is a 4-Pin SMD shipped in tape and reel (TR)

Applications:

- High voltage isolation: 5,000 Volts(RMS)
- PCBoard power system isolation
- Industrial equipment power isolation
- Medical equipment power isolation
- Office equipment



RoHS

OPTEK reserves the right to make changes at any time in order to improve design and to supply the best product possible.

OPIA814, OPIA815, OPIA817 OPIA1210, OPIA4010 SMD, SOP and SSOP Packages



Package Outline Dimensions and Schematics: Top-View

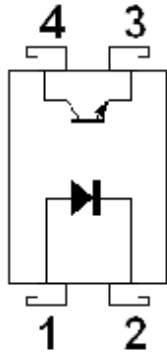

OPIA817
OPIA1210

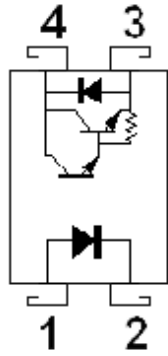

OPIA4010

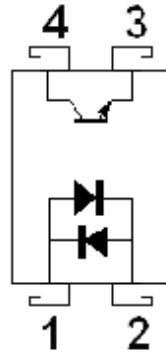

OPIA814

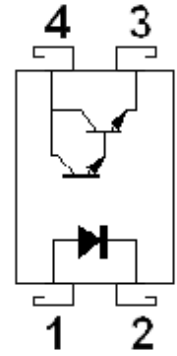

OPIA815

Package Style C (SSOP)

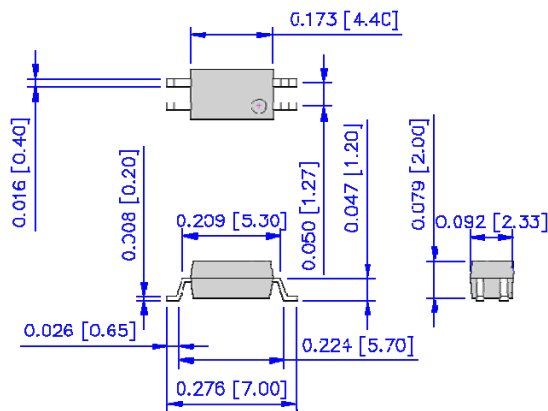

Package Style B (SOP)

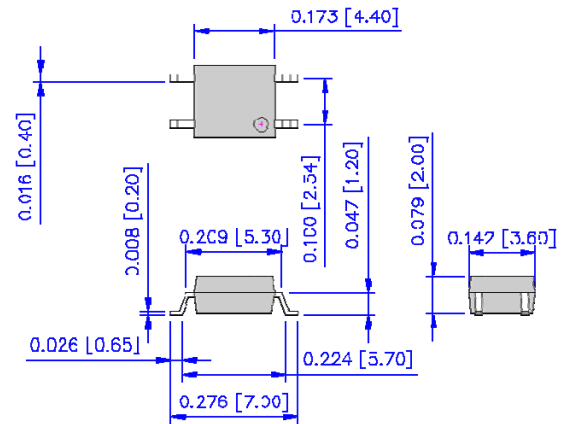

Package Style A (SMD)

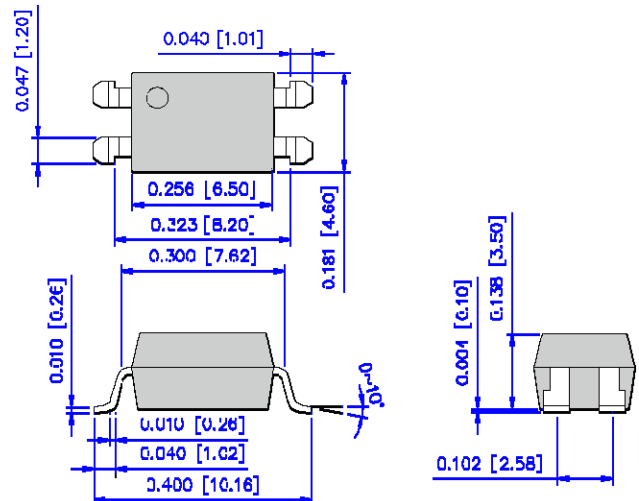

Part Number	Pin #			
	1	2	3	4
OPIA817A	A	K	E	C
OPIA814A	A-K	K-A	E	C
OPIA815A	A	K	E	C
OPIA4010A	A	K	E	C
OPIA1210A	A	K	E	C

OPTEK reserves the right to make changes at any time in order to improve design and to supply the best product possible.

OPIA814, OPIA815, OPIA817
OPIA1210, OPIA4010
SMD, SOP and SSOP Packages



Analog Output Devices Ordering Information					
Part Number	Isolation Voltage Max. (Vrms)	CTR Min/Typ/Max	Typ. Tr / Tf (µs) R _L = 100 ohms	Package	Configuration
OPIA817A	5,000	50 / - / 600	4 / 3	4-Pin SMD	A K—C E
OPIA814A	5,000	60 / - / 600	5 / 4	4-Pin SMD	A K, K A—C E
OPIA815A	5,000	70 / - / -	80 / 72	4-Pin SMD	A K—C E (Dar)
OPIA4010A	5,000	600 / - / 9,000	60 / 50	4-Pin SMD	A K—C E (Dar)
OPIA1210A	5,000	50 / - / 600	2 / 3	4-Pin SMD	A K—C E
Configuration: Definition of Terms LED Identification—Sensor Identification					
Configuration Information	LED	A = Anode	K = Cathode		
	Sensor	B = Base	C = Collector	E = Emitter	(Dar) = Photodarlington
Packaging	Part Number Suffix: TU = Shipped in Tubes			Example: OPIA817DT <u>UE</u>	

OPTEK reserves the right to make changes at any time in order to improve design and to supply the best product possible.

OPIA814, OPIA815, OPIA817 OPIA1210, OPIA4010 SMD, SOP and SSOP Packages



Absolute Maximum Ratings ($T_A = 25^\circ\text{C}$ unless otherwise noted)

Storage Temperature OPIA817, OPIA4010, OPIA1210	-55° C to +125° C
Operating Temperature All except the part numbers noted below	-30° C to +100° C
Isolation voltage (1 minute) OPIA817, OPIA814, OPIA815, OPIA4010, OPIA1210	5,000 Vrms
Total Package Power Dissipation OPIA817, OPIA814, OPIA815, OPIA4010, OPIA1210	200 mW
Lead Soldering Temperature (1/16" (1.6 mm) from case for 5 seconds with soldering iron)	260° C

Input Diode

Continuous Forward Current All except the part number noted below	50 mA
Peak Forward current (1 μs pulse width, 300 pps) All except the part number noted below	1 A
Reverse Voltage OPIA817, OPIA815, OPIA4010, OPIA1210, OPIA814, OPIA4010	6 V
Power Dissipation OPIA817, OPIA814, OPIA4010, OPIA1210, OPIA815	70 mW

Output Phototransistor

Collector-Emitter Voltage OPIA817, OPIA814 OPIA4010 OPIA815 OPIA1210	60 V 300 V 35 V 350 V
Emitter-Collector Voltage OPIA817, OPIA814, OPIA815 OPIA4010 OPIA1210	6 V 0.1 V 7 V
Collector Current OPIA817, OPIA814, OPIA1210, OPIA414 OPIA4010 OPIA815	50 mA 150 mA 80 mA
Power Dissipation All except the part numbers noted below OPIA4010	150 mW 200 mW

OPTEK reserves the right to make changes at any time in order to improve design and to supply the best product possible.

OPIA814, OPIA815, OPIA817
OPIA1210, OPIA4010
SMD, SOP and SSOP Packages



Electrical Characteristics

SYMBOL	PARAMETER	MIN	TYP	MAX	UNITS	TEST CONDITIONS
--------	-----------	-----	-----	-----	-------	-----------------

Input Diode

V_F	Forward Voltage All except those noted below OPIA1210	- 1.0	1.2 1.2	1.4 1.3	V	$I_F = 20 \text{ mA}$ $I_F = 10 \text{ mA}$
V_{FM}	Peek Forward Voltage OPIA814, OPIA4010 OPIA817, OPIA815, OPIA1210	- -	- -	3.5 3.0	V	$I_{FM} = 500 \text{ mA}$
I_R	Reverse Current All except those noted below OPIA814 OPIA1210	- - -	- - -	10 - 10	μA	$V_R = 4 \text{ V}$ - $V_R = 5 \text{ V}$
C_t	Terminal Capacitance All except those noted below OPIA815	- -	30 30	- 250	pf	$V = 0.0 \text{ V}, f = 1 \text{ K Hz}$ $V = 0.0 \text{ V}, f = 1 \text{ K Hz}$

Output Phototransistor

I_{CEO}	Collector dark Current OPIA817, OPIA814 OPIA1210	- -	- 10	100 200	nA	$I_F = 0 \text{ mA}, V_{CE} = 20 \text{ V}$ $I_F = 0 \text{ mA}, V_{CE} = 300 \text{ V}$
$V_{CE(SAT)}$	Collector-emitter Saturation Voltage OPIA817 OPIA814 OPIA1210	- - -	0.1 0.1 -	0.2 0.3 0.4	V	$I_F = 20 \text{ mA}, I_C = 1 \text{ mA}$ $I_F = 20 \text{ mA}, I_C = 1 \text{ mA}$ $I_F = 8 \text{ mA}, I_C = 2.4 \text{ mA}$
f_C	Cutt-Off frequency All except those noted below OPIA817, OPIA814, OPIA1210	- -	- 80	- -	K Hz	$V_{CC} = 5 \text{ V}, I_C = 2 \text{ mA}, R_L = 100 \Omega$
t_R	Rise Time OPIA817 OPIA814 OPIA1210	- - -	4 5 2	18 20 -	μs	$V_{CC} = 2 \text{ V}, I_C = 2 \text{ mA}, R_L = 100 \Omega$ $V_{CC} = 2 \text{ V}, I_C = 2 \text{ mA}, R_L = 100 \Omega$ $V_{CC} = 10 \text{ V}, I_C = 2 \text{ mA}, R_L = 100 \Omega$
t_F	Fall Time OPIA817D OPIA814 OPIA1210	- - -	3 4 3	18 20 -	μs	$V_{CC} = 2 \text{ V}, I_C = 2 \text{ mA}, R_L = 100 \Omega$ $V_{CC} = 2 \text{ V}, I_C = 2 \text{ mA}, R_L = 100 \Omega$ $V_{CC} = 10 \text{ V}, I_C = 2 \text{ mA}, R_L = 100 \Omega$

Continued on Next Page

OPTEK reserves the right to make changes at any time in order to improve design and to supply the best product possible.

OPIA814, OPIA815, OPIA817
OPIA1210, OPIA4010
SMD, SOP and SSOP Packages



Electrical Characteristics (OPIA817 Series) - Continued from Previous Page

SYMBOL	PARAMETER	MIN	TYP	MAX	UNITS	TEST CONDITIONS
Output PhotoDarlington						
I_{CEO}	Collector dark Current OPIA4010 OPIA815	- -	- -	1.0 1.0	μ A	$I_F = 0 \text{ mA}, V_{CE} = 200 \text{ V}$ $I_F = 0 \text{ mA}, V_{CE} = 10 \text{ V}$
$V_{CE(SAT)}$	Collector-emitter Saturation Voltage OPIA815 OPIA4010	- -	0.8 -	1.0 1.5	V	$I_F = 20 \text{ mA}, I_C = 5 \text{ mA}$ $I_F = 20 \text{ mA}, I_C = 5 \text{ mA}$
f_c	Cut-Off frequency OPIA815 OPIA4010	1.0 -	6.0 7.0	- -	K Hz	$V_{CC} = 2 \text{ V}, I_C = 20 \text{ mA}, R_L = 100 \Omega$ $V_{CC} = 5 \text{ V}, I_C = 2 \text{ mA}, R_L = 100 \Omega$
t_R	Rise Time OPIA815 OPIA4010	- -	80 60	300 300	μ s	$V_{CC} = 2 \text{ V}, I_C = 20 \text{ mA}, R_L = 100 \Omega$ $V_{CC} = 2 \text{ V}, I_C = 20 \text{ mA}, R_L = 100 \Omega$
t_F	Fall Time OPIA815 OPIA4010	- -	72 50	250 250	μ s	$V_{CC} = 2 \text{ V}, I_C = 20 \text{ mA}, R_L = 100 \Omega$ $V_{CC} = 2 \text{ V}, I_C = 20 \text{ mA}, R_L = 100 \Omega$

Coupled Characteristics

CTR	Current Transfer Ratio OPIA817, OPIA1210 OPIA814 OPIA815 OPIA4010	50 60 70 600	- - - -	600 600 - 9,000	%	$I_F = 5.00 \text{ mA}, V_{CE} = 5.0 \text{ V}$ $I_F = 1.00 \text{ mA}, V_{CE} = 2.0 \text{ V}$ $I_F = 0.05 \text{ mA}, V_{CE} = 3.3 \text{ V}$ $I_F = 1.00 \text{ mA}, V_{CE} = 2.0 \text{ V}$
C_f	Floating Capacitance	-	0.6	1.0	pF	$V = 0.0 \text{ V}, f = 1 \text{ M Hz}$
R_{ISO}	Isolation resistance	5×10^{10}	10^{11}	-	ohm	C500V, 40% to 60%RH

OPTEK reserves the right to make changes at any time in order to improve design and to supply the best product possible.

OPIA814

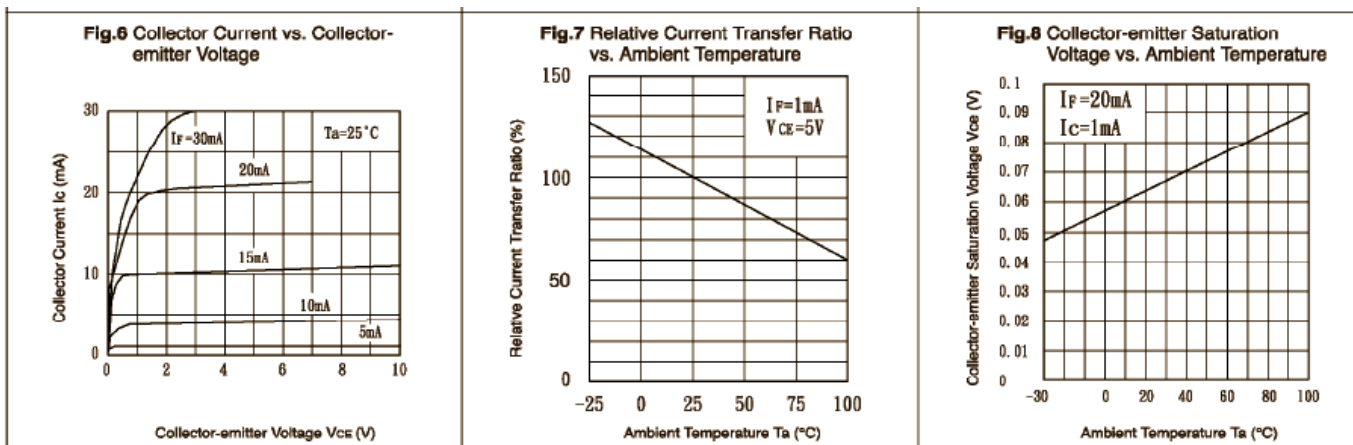
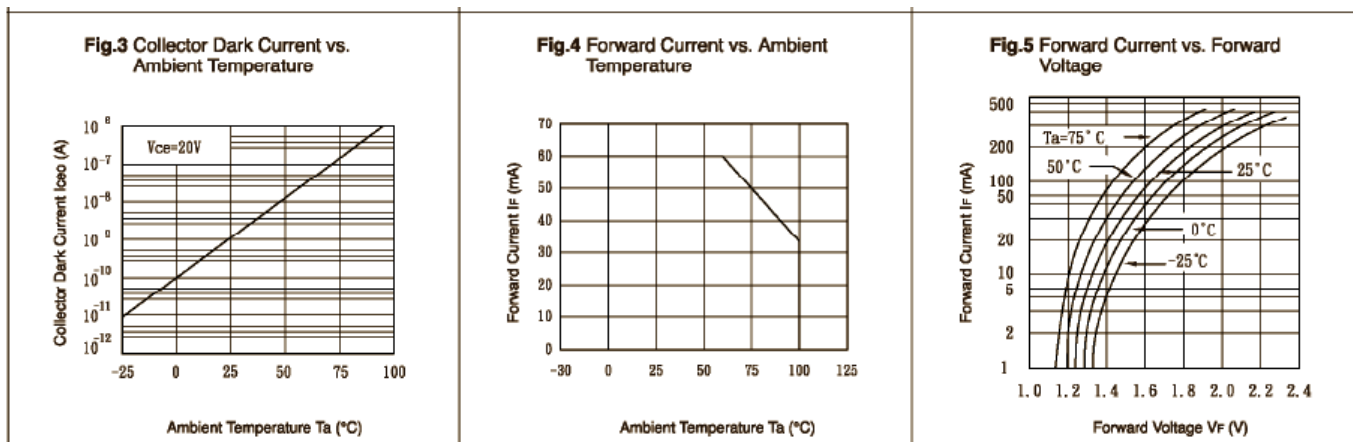
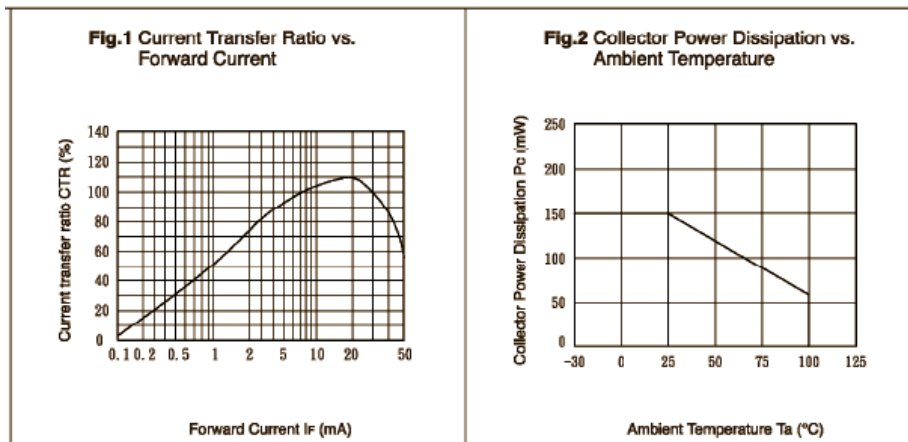

OPTeK reserves the right to make changes at any time in order to improve design and to supply the best product possible.

OPIA814

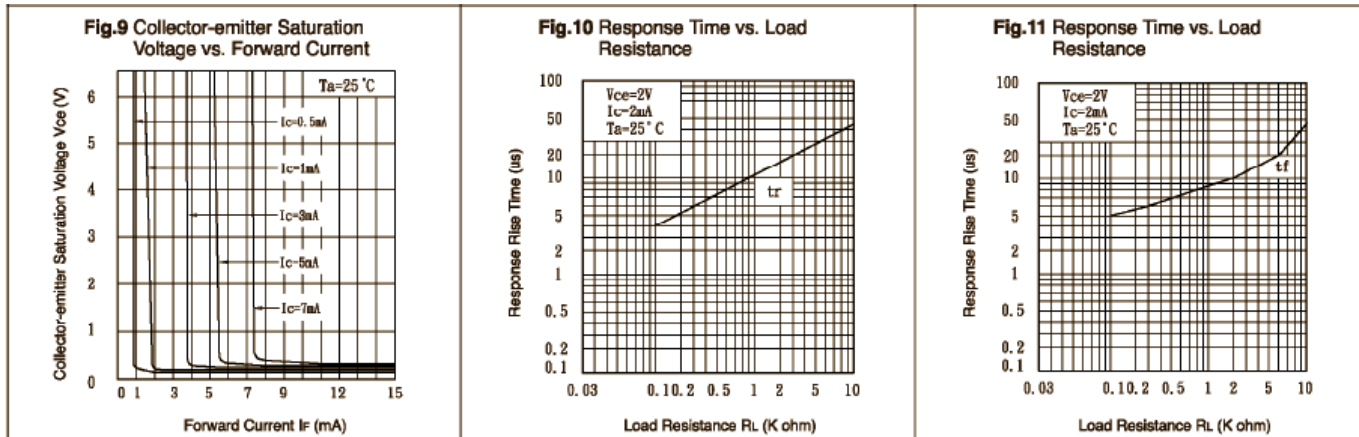

OPTEK reserves the right to make changes at any time in order to improve design and to supply the best product possible.

OPIA815

Fig. 1 Forward Current vs. Ambient Temperature

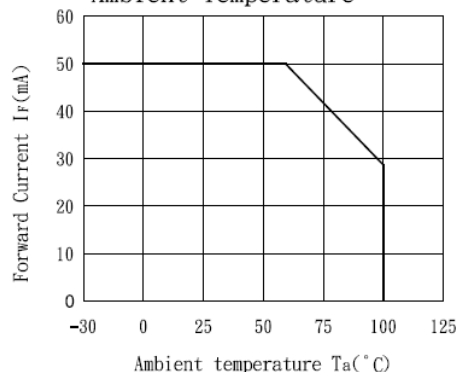

Fig. 2 Collector Power Dissipation vs. Ambient Temperature

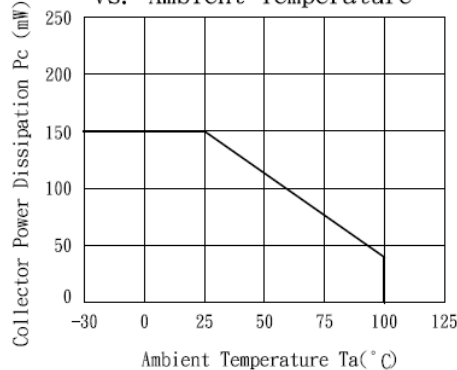

Fig. 3 Collector-emitter Saturation Voltage vs. Forward Current

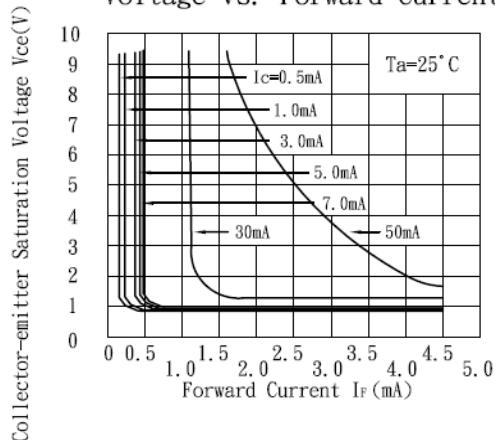

Fig. 4 Forward Current vs. Forward Voltage

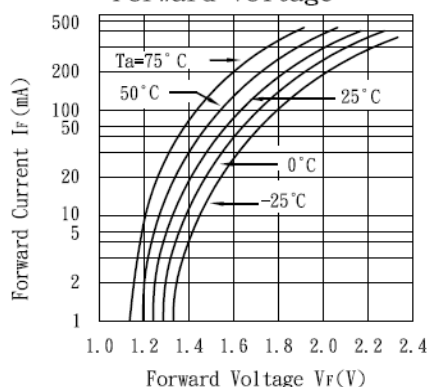

Fig. 5 Current Transfer Ratio vs. Forward Current

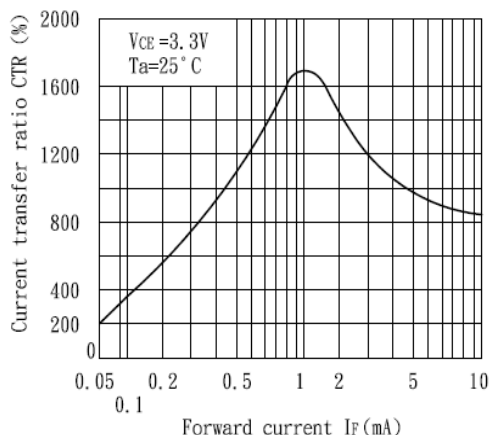
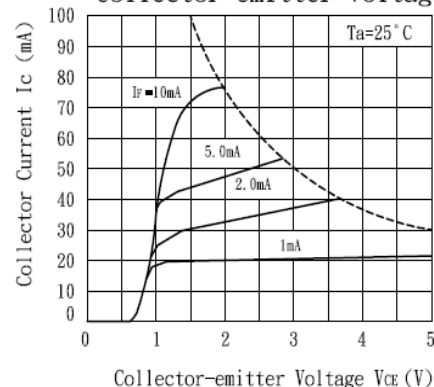

Fig. 6 Collector Current vs. Collector-emitter Voltage



OPTeK reserves the right to make changes at any time in order to improve design and to supply the best product possible.

OPIA815

Fig. 7 Relative Current Transfer Ratio vs. Ambient Temperature

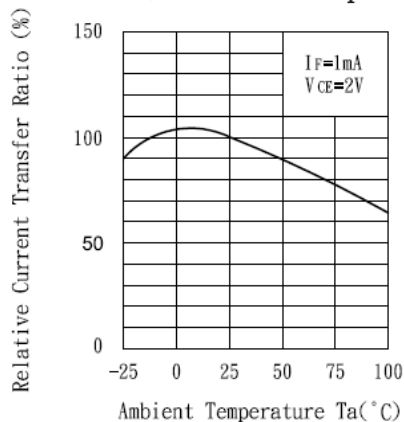

Fig. 7 Collector-emitter Saturation Voltage vs. Ambient Temperature

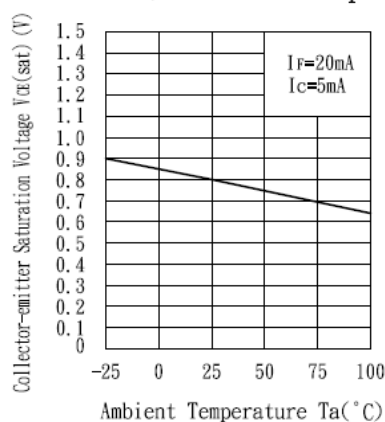

Fig. 9 Collector Dark Current vs. Ambient Temperature

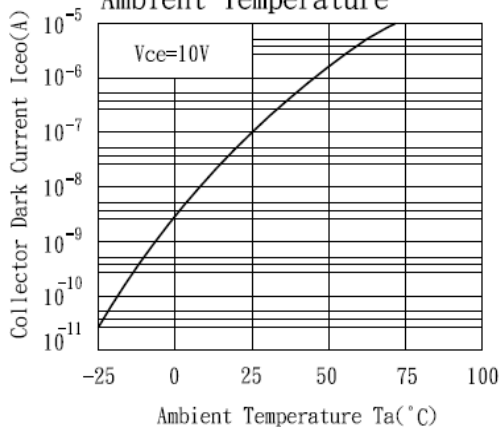
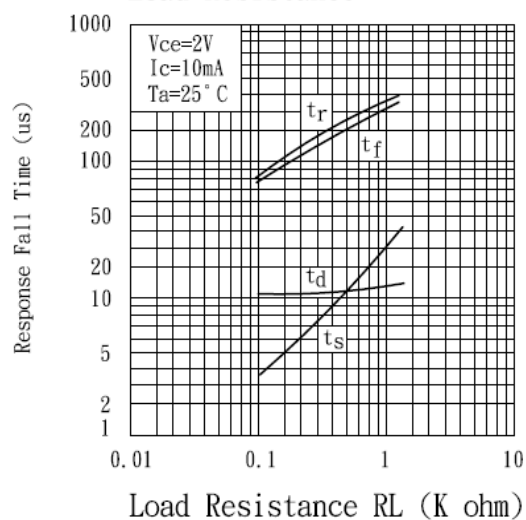

Fig. 10 Response Time vs. Load Resistance



OPTEK reserves the right to make changes at any time in order to improve design and to supply the best product possible.

OPIA817

Fig.1 Current Transfer Ratio vs. Forward Current

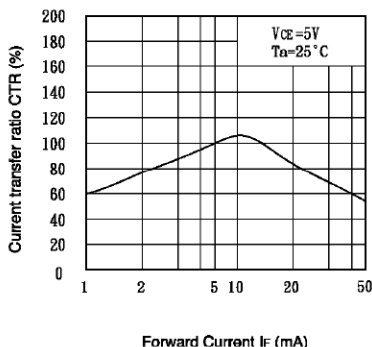

Fig.2 Collector Power Dissipation vs. Ambient Temperature

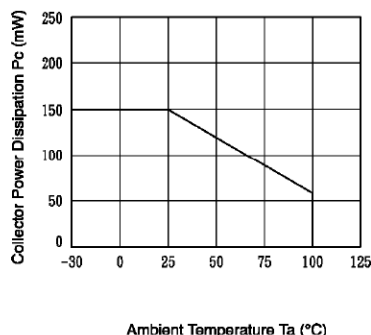

Fig.3 Collector Dark Current vs. Ambient Temperature

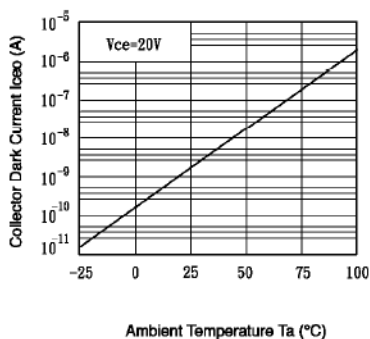

Fig.4 Forward Current vs. Ambient Temperature

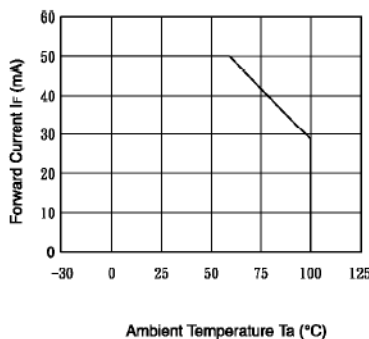

Fig.5 Forward Current vs. Forward Voltage

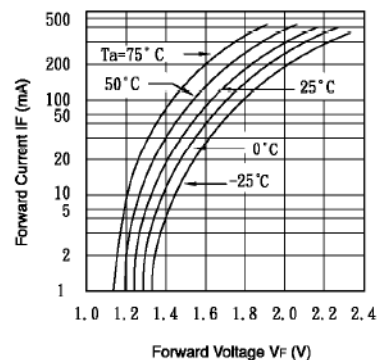

Fig.6 Collector Current vs. Collector-emitter Voltage

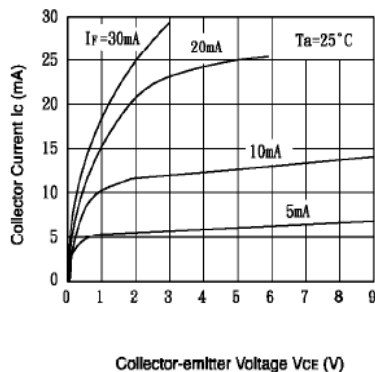

Fig.7 Relative Current Transfer Ratio vs. Ambient Temperature

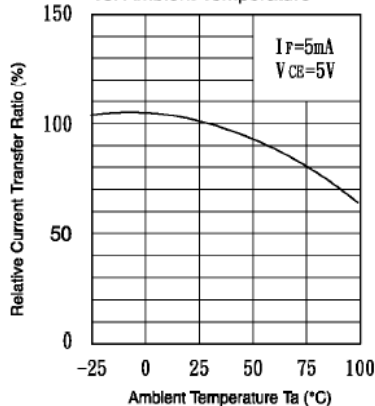
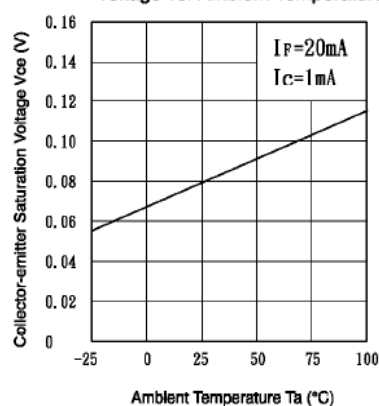

Fig.8 Collector-emitter Saturation Voltage vs. Ambient Temperature



OPTeK reserves the right to make changes at any time in order to improve design and to supply the best product possible.

OPIA817

Fig.9 Collector-emitter Saturation Voltage vs. Forward Current

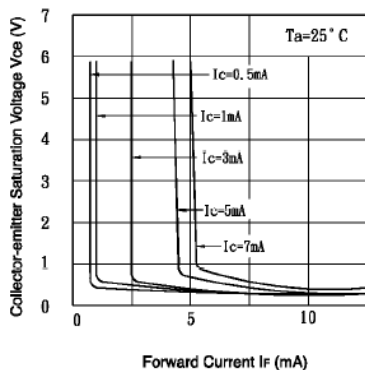

Fig.10 Response Time vs. Load Resistance

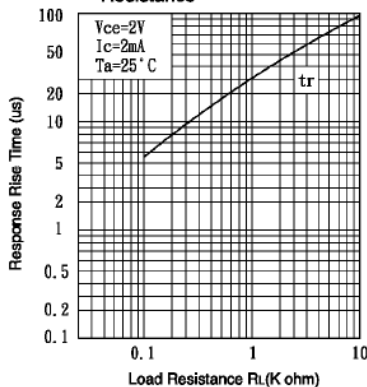
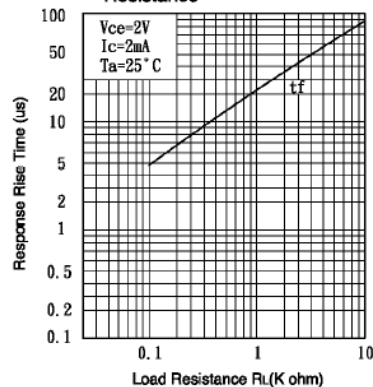

Fig.11 Response Time vs. Load Resistance



OPTEK reserves the right to make changes at any time in order to improve design and to supply the best product possible.

OPIA1210

Fig.4 Forward Current vs. Ambient Temperature

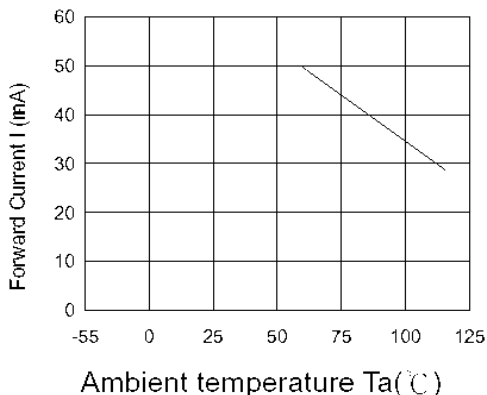

Fig.5 Forward Current vs. Forward Voltage

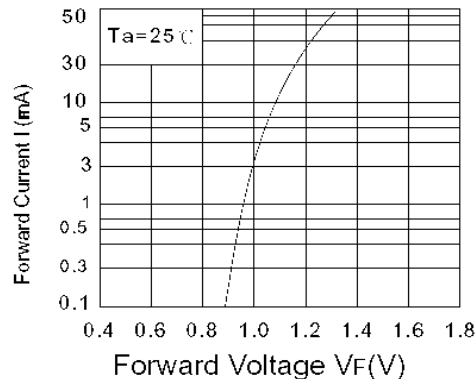

Fig.6 Collector Current vs. Collector-emitter Voltage

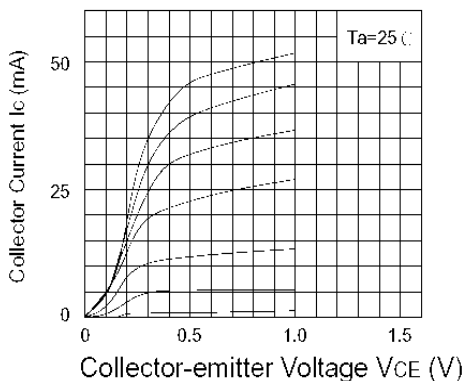

Fig.7 Relative Current Transfer Ratio vs. Ambient Temperature

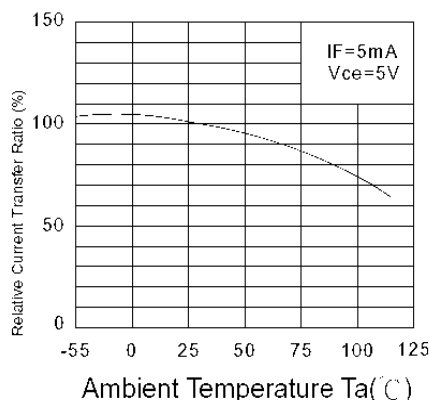

Fig.2 Collector Power Dissipation vs. Ambient Temperature

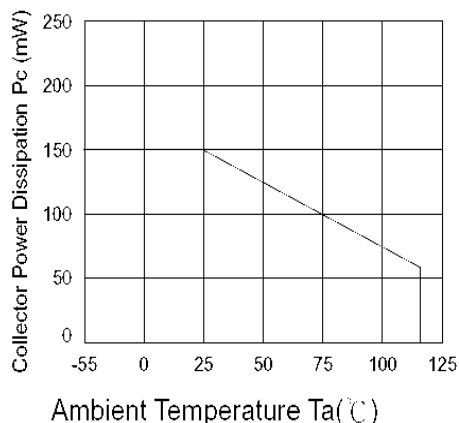
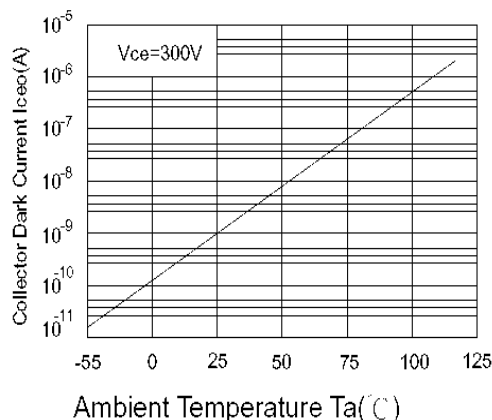

Fig.3 Collector Dark Current vs. Ambient Temperature



OPTEK reserves the right to make changes at any time in order to improve design and to supply the best product possible.

OPIA1210

Fig. 1 Current Transfer Ratio Vs. Forward Current

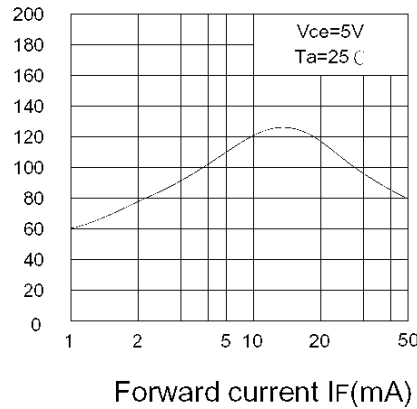

Fig.10 Response Time vs. Load Resistance

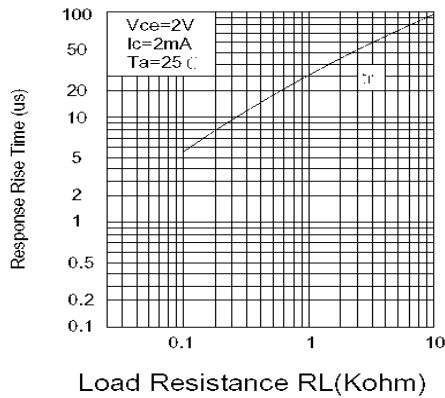

Fig.11 Response Time vs. Load Resistance

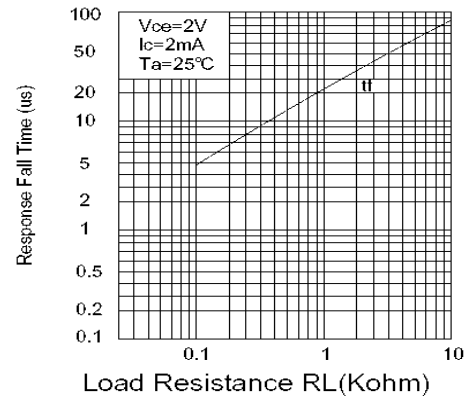

Fig.8 Collector-emitter Saturation Voltage vs. Ambient Temperature

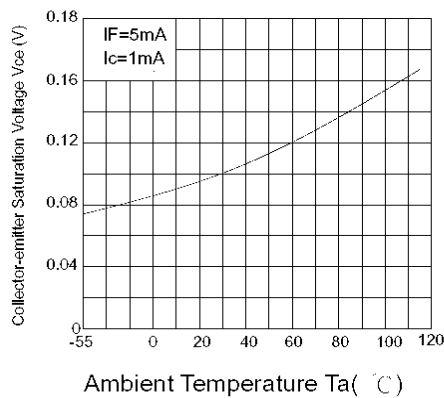
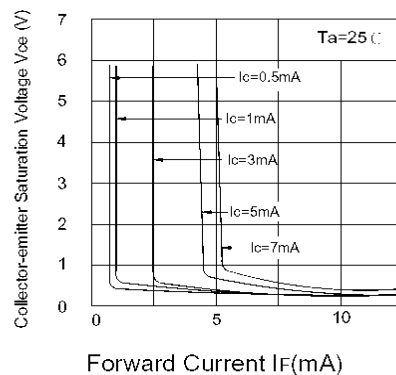

Fig.9 Collector-emitter Saturation Voltage vs. Forward Current



OPTEK reserves the right to make changes at any time in order to improve design and to supply the best product possible.

OPIA4010

Fig. 4 Forward Current vs. Ambient Temperature

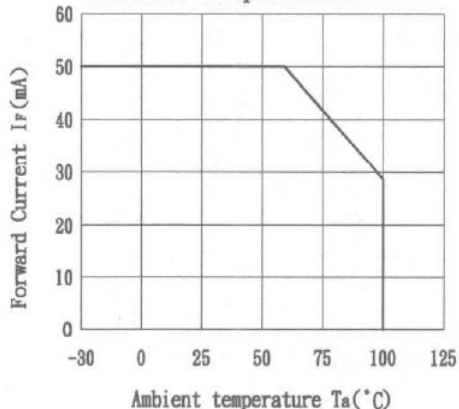

Fig. 5 Forward Current vs. Forward Voltage

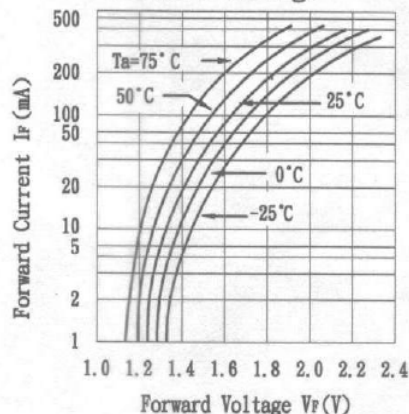

Fig. 2 Collector Power Dissipation vs. Ambient Temperature

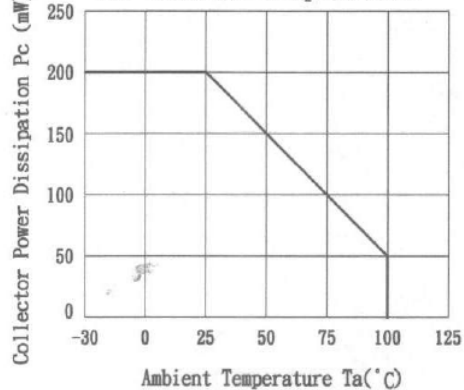

Fig. 3 Collector Dark Current vs. Ambient Temperature

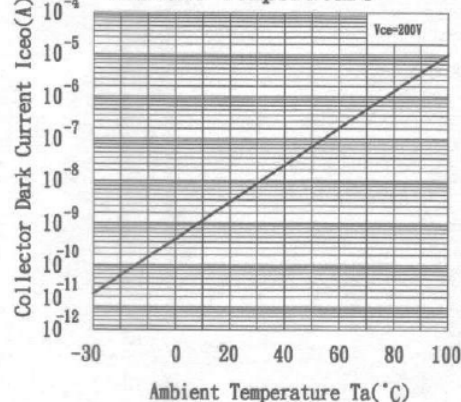

Fig. 6 Collector Current vs. Collector-emitter Voltage

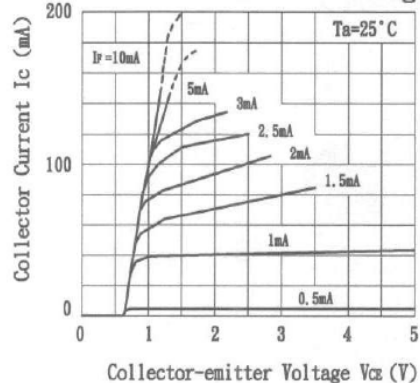
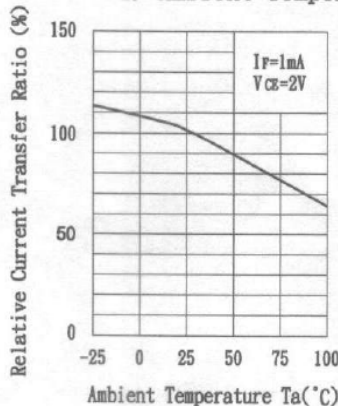

Fig. 7 Relative Current Transfer Ratio vs. Ambient Temperature



OPTeK reserves the right to make changes at any time in order to improve design and to supply the best product possible.

OPIA4010

Fig. 8 Collector-emitter Saturation Voltage vs. Forward Current

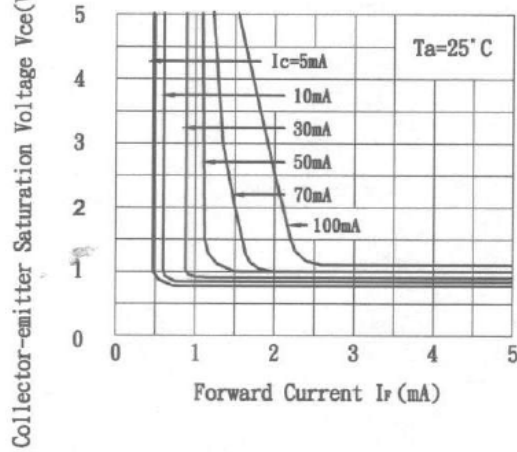
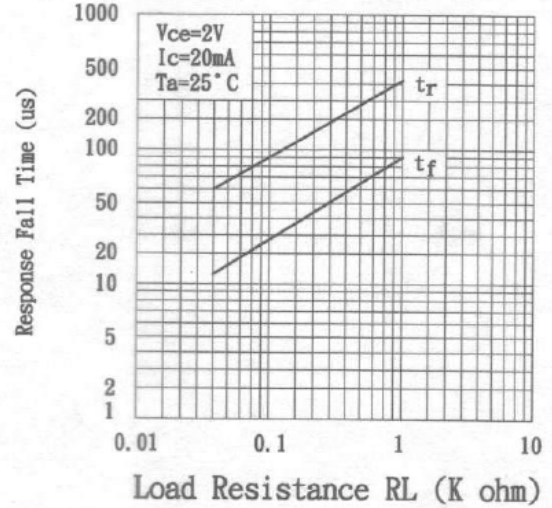

Fig. 9 Response Time vs. Load Resistance



OPTEK reserves the right to make changes at any time in order to improve design and to supply the best product possible.

**OPIA814, OPIA815, OPIA817
OPIA1210, OPIA4010
SMD, SOP and SSOP Packages**



Quality / Reliability Requirements

Parameter	Failure Criteria	Conditions
HTRB D I _{C(OFF)}	± 10%	11 samples after 500Hrs
	0 Fail	@ VCE = 5.0VDC, Ta = 70°C
HTFB D I _{C(ON)}	± 10%	50 samples after 96Hrs
	0 Fail	@ Max P _D , Ta = 25°C
MTTF @ 90% confidence	150,000 Min.	@ 25°C, 25mADC
Moisture Sensitivity Level	MSL 1	per JDEC std J-STD-020B
Lead Solderability	0 Fail	per Method 208 of MIL-STD-202.
Glass Transition of body	125°C Min.	DSC test method
Temperature Humidity-Bias	± 20%	85°C, 85%RH, 500Hrs, 80% min I _{ceo}
Temperature Cycle	± 20%	per Method 1010.7 of MIL-STD-883E
High Temperature Storage	± 20%	85°C, 500Hrs
Autoclave	0 Fail	T _A = 121°C, Pressure = 15psi, Humidity = 100%, Time = 96Hrs

Note: This is to be performed when a change occurs to form, fit or function.

Government and Industry Standard Compliance Requirements

European Union’s Reduction of Hazardous Substances (RoHS) Directive 2002/95/EC

Label Identification

DESCRIPTION:

Size: 3” (7.4 cm) X 2.2” (5.5 cm)
Lettering shall be black on white background.
Format shall be as:

Notes:

1. The DATE CODE is a 4-digit code for date of manufacture where YY is the last two digits of the year, and WW is week number of manufacture.
2. The LOT I.D. is the manufacturing location lot identification where Y is the year of manufacture, NNNN is a sequential lot identifier, and DDD is the day of the year of manufacture. – or use equivalent label format.

<p>Carrollton, TX, USA MADE IN TAIWAN</p>
OPTEK P/N <u> OPIA407C-TR </u>
QTY. <u> N/A </u>
DATE CODE <u> (Y Y W W) </u>
LOT I.D. <u> (Y - N N N N D D D) </u>

OPTEK reserves the right to make changes at any time in order to improve design and to supply the best product possible.

OPIA814, OPIA815, OPIA817
OPIA1210, OPIA4010
SMD, SOP and SSOP Packages



Tube Packaging Information:

Optek's Optocoupler Part Numbers		Packaging Quantities		Tube		Inner			Small Carton			Medium Carton			Large Carton		
				Qty	Weight	52 x 7 x 7.5 cm		53.5 x 16 x 17.5 cm			53.5 x 30.7 x 17.5 cm			53.5 x 30.7 x 25 cm			
						Qty	Weight	Qty	Weight	Gross Weight	Qty	Weight	Gross Weight	Qty	Weight	Gross Weight	
P/H and SMD	4-PIN OPIA817D/A, OPIA814D/A - OPIA1210D/A	100	44	3,000	1.40	12,000	6.0	6.5	24,000	12.0	12.5	36,000	18.0	18.5			
	6-PIN OPIA6XXD/A Series	65	44	1,950	1.50	7,800	6.5	7.0	15,600	12.0	12.5	23,400	18.5	19.0			
	8-PIN OPIA8XXD Series and OPID804D	48	44	1,440	1.44	5,760	6.0	6.5	11,520	12.0	12.5	17,290	18.0	18.5			
M/F SOP	4-PIN and 5-PIN OPIA401B - OPIA404B, OPIA414B, OPIA500B	100	24	6,000	1.60	24,000	6.5	7.0	48,000	13.0	13.5	72,000	19.5	20.0			
SSOP	4-PIN OPIA405C - OPIA409C	170	--	10,200	--												

P/H = Pin-Hole Packages (Referred as D = Dual-In-Line Package)

SMD = Standard Surface Mount Packages (Referred as A = 6.5mil SMD)

M/F or SOP = Mini-Flat Packages or Small Outside Packages (Referred as B = 4.40mil SMD w/ 2.54mil Lead-Spacing)

SSOP = Shrink SOP Packages (Referred as C = 3.60mil SMD with 1.27mil Lead-Spacing)

OPTEK reserves the right to make changes at any time in order to improve design and to supply the best product possible.

OPIA814, OPIA815, OPIA817
 OPIA1210, OPIA4010
 SMD, SOP and SSOP Packages



Tube Packaging Specifications—SMD— (TU):

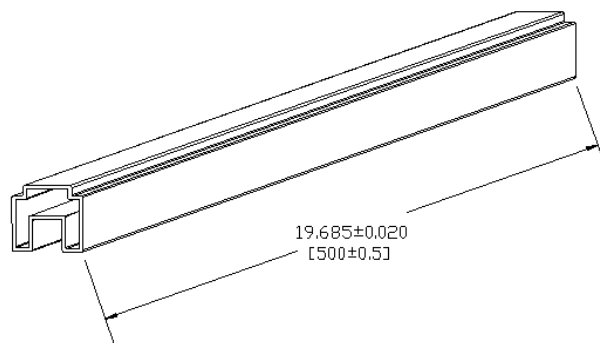
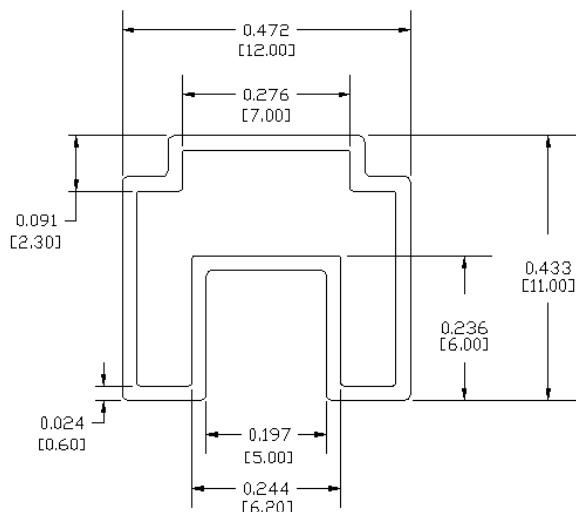

DIMENSIONS ARE IN: INCHES [MILLIMETERS]

TOLERANCE: ± 0.008 INCHES
 [± 0.2 MILLIMETERS]

Quantity: 4-pin (SMD): 100pcs/tube

Tube Packaging Specifications— SOP (Mini-flats) and SSOP— (TU):

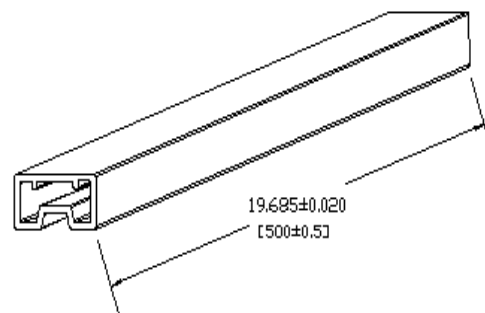
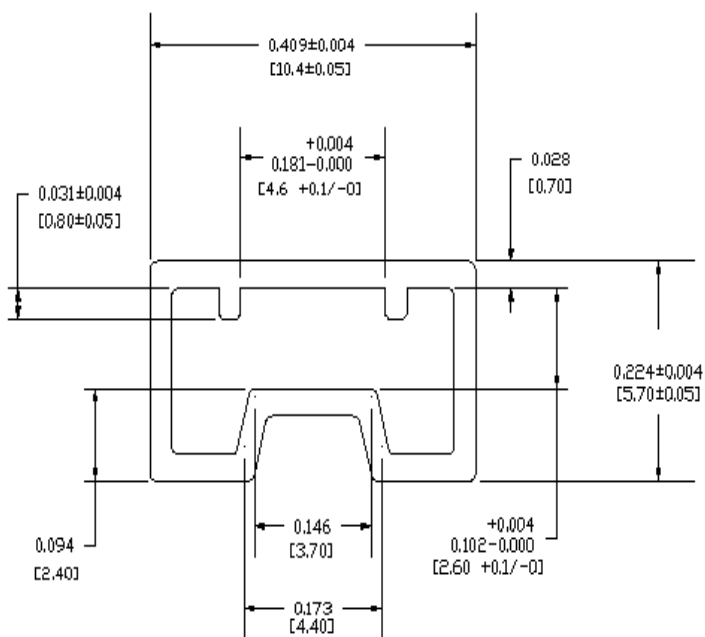

Quantity: 4-pin (SOP): 100pcs/tube
 4-pin (SSOP): 170pcs/tube

OPTEK reserves the right to make changes at any time in order to improve design and to supply the best product possible.

OPIA814, OPIA815, OPIA817
 OPIA1210, OPIA4010
 SMD, SOP and SSOP Packages



Tape and Reel Packaging Specifications— SMD and SOP—(TR):

Tape Feeder:

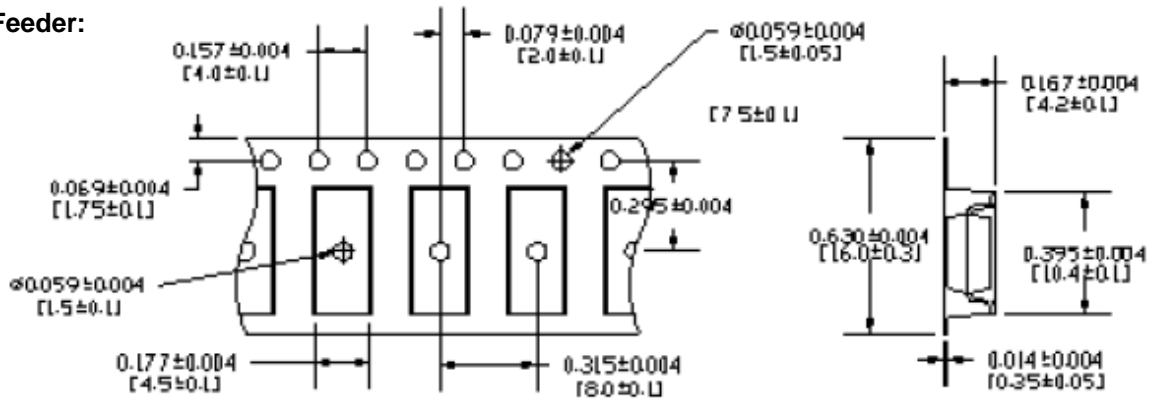

Direction:

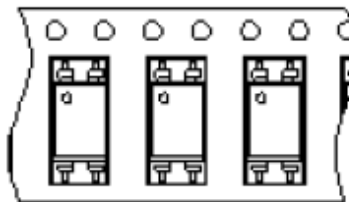

Quantity: 4-pin (SMD): 1000pcs/Reel
 4-pin (SOP): 1000pcs/Reel
 4-pin (SSOP): 3000pcs/Reel

DIMENSIONS ARE IN: INCHES [MILLIMETERS]

TOLERANCE: ± 0.008 INCHES
 [± 0.2 MILLIMETERS]

Reel:

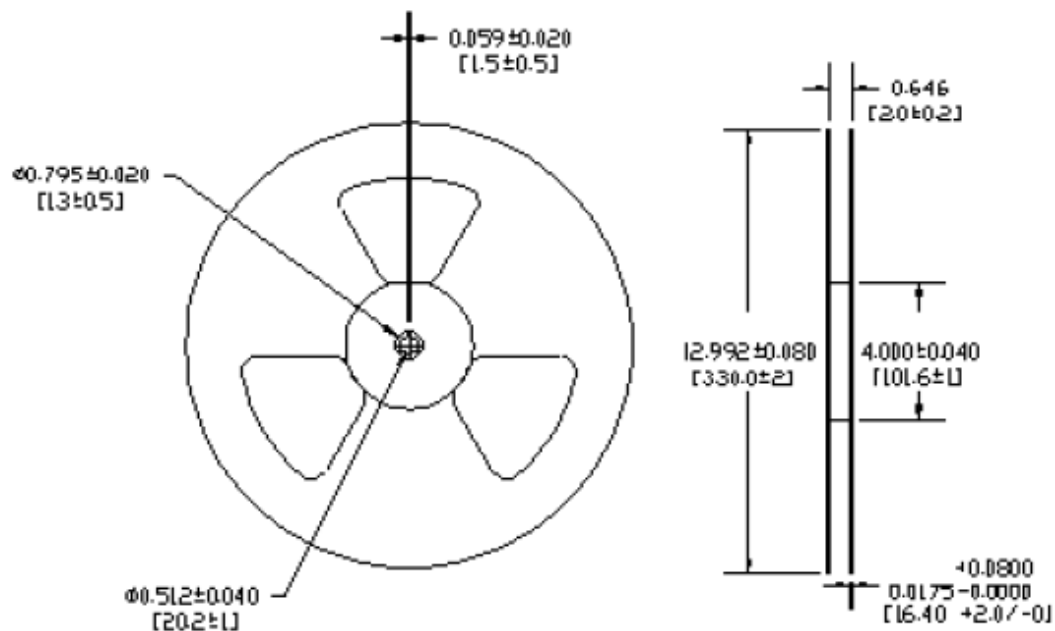

OPTEK reserves the right to make changes at any time in order to improve design and to supply the best product possible.

OPIA814, OPIA815, OPIA817
 OPIA1210, OPIA4010
 SMD, SOP and SSOP Packages



Tape and Reel Packaging Specifications— SSOP—(TR):

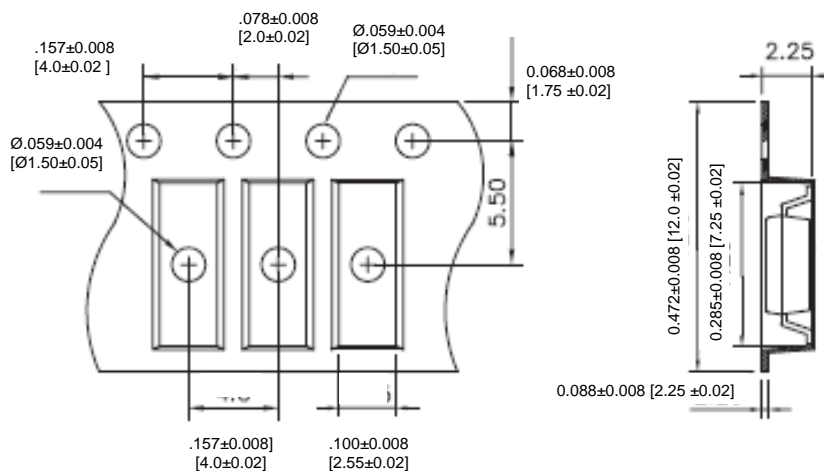

Direction:

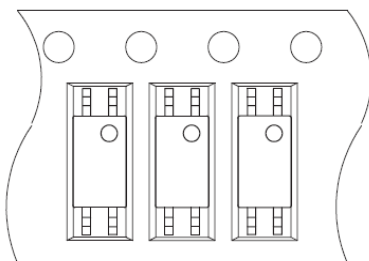

DIMENSIONS ARE IN: INCHES [MILLIMETERS]

TOLERANCE: ± 0.008 INCHES
 [± 0.2 MILLIMETERS]

Reel:

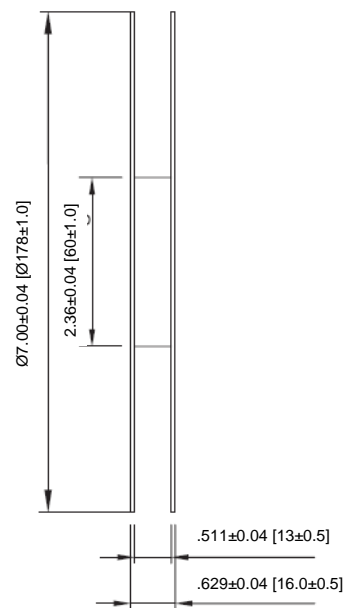
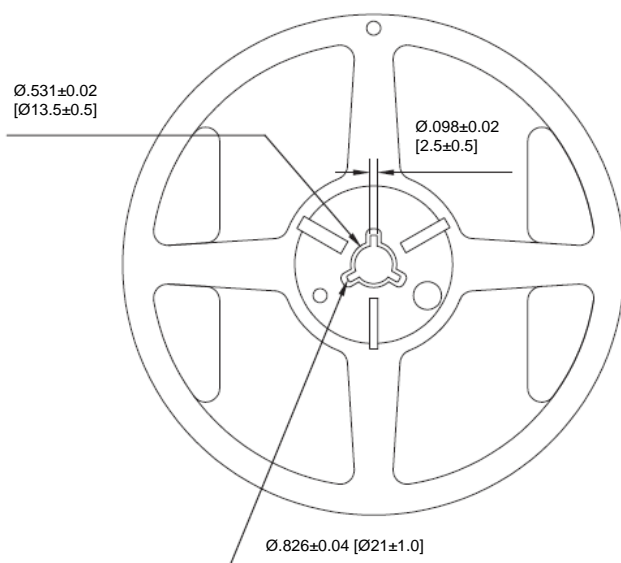

Quantity: 4-pin (SSOP): 2000pcs/Reel

OPTEK reserves the right to make changes at any time in order to improve design and to supply the best product possible.