

FEATURES

- **HIGH ISOLATION VOLTAGE**
BV: 5 k Vr.m.s. MIN
- **HIGH COLLECTOR TO EMITTER VOLTAGE**
V_{CEO} : 80 V MIN
- **HIGH SPEED SWITCHING**
tr = 3 μs, tf = 5 μs TYP
- **HIGH CURRENT TRANSFER RATIO**
CTR: 300% TYP
- **TAPE AND REEL AVAILABLE**

DESCRIPTION

PS2601, PS2602, PS2601L and PS2602L are optically coupled isolators containing a GaAs light emitting diode and an NPN silicon phototransistor. PS2601 and PS2602 are in a plastic DIP (Dual In-line Package). PS2601L and PS2602L are lead bending type (Gull-wing) for surface mount. PS2601 and PS2601L have a base pin, PS2602 and PS2602L have no base pin.

APPLICATIONS

Interface circuit for various instrumentations and control equipment.

- AC LINE / DIGITAL LOGIC
- DIGITAL LOGIC / DIGITAL LOGIC
- TWISTED PAIR LINE RECEIVER
- TELEPHONE / TELEGRAPH LINE RECEIVER
- HIGH FREQUENCY POWER SUPPLY
FEEDBACK CONTROL

ELECTRICAL CHARACTERISTICS (T_A = 25°C)

PART NUMBER			PS2601, PS2601L, PS2602, PS2602L			
SYMBOLS	PARAMETERS	UNITS	MIN	TYP	MAX	
Diode	V _F	Forward Voltage, I _F = 10 mA		1.1	1.4	
	I _R	Reverse Current, V _R = 5 V			5	
	C	Junction Capacitance, V = 0, f = 1.0 MHz	pF	30		
Transistor	I _{CEO}	Collector to Emitter Dark Current, V _{CE} = 80 V, I _F = 0	nA		100	
	BV _{CEO}	Collector to Emitter Breakdown Voltage, I _C = 1 mA, I _B = 0	V	80		
	BV _{ECO}	Emitter to Collector Breakdown Voltage, I _E = 100 μA, I _B = 0	V	7		
Coupled	CTR	Current Transfer Ratio ¹ , I _F = 5 mA, V _{CE} = 5 V	%	80	300	600
	V _{CE(sat)}	Collector Saturation Voltage, I _F = 10 mA, I _C = 2 mA	V			0.3
	R ₁₋₂	Isolation Resistance, V _{IN-OUT} = 1.0 kV	Ω	10 ¹¹		
	C ₁₋₂	Isolation Capacitance, V = 0, f = 1.0 MHz	pF		0.6	
	tr	Rise Time ² , V _{CC} = 5 V, I _C = 2 mA	μs		3	
tf	Fall Time ² , V _{CC} = 5 V, I _C = 2 mA	μs		5		

Notes:

1. KD : 300 to 600 %
LD : 200 to 400 %
MD : 80 to 240 %

2. Test Circuit for Switching Time

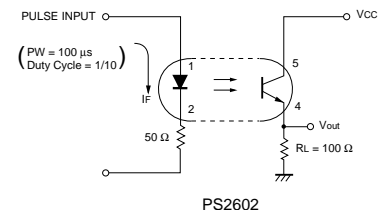
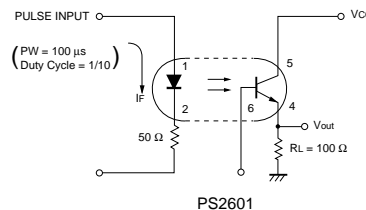
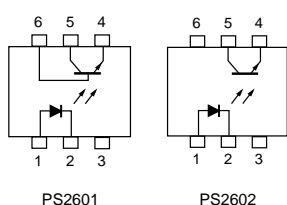

ABSOLUTE MAXIMUM RATINGS¹ (T_A = 25°C)

SYMBOLS	PARAMETERS	UNITS	RATINGS
Diode			
V _R	Reverse Voltage	V	6
I _F	Forward Current (DC)	mA	80
P _D	Power Dissipation	mW	150
I _F (PEAK)	Peak Forward Current (PW = 100 μs, Duty Cycle 1%)	A	1
Transistor			
V _{CEO}	Collector to Emitter Voltage	V	80
V _{ECO}	Emitter to Collector Voltage	V	7
I _C	Collector Current	mA	50
P _C	Power Dissipation	mW	150
Coupled			
BV	Isolation Voltage ²	V _{r.m.s.}	5000
T _{STG}	Storage Temperature	°C	-55 to +150
T _{OP}	Operating Temperature	°C	-55 to +100

Notes:

1. Operation in excess of any one of these parameters may result in permanent damage.
2. AC voltage for 1 minute at T_A = 25° C, RH = 60% between input (Pin No. 1, 2, 3 common) and output (Pin No. 4, 5, 6 common).

TYPICAL PERFORMANCE CURVES (T_A = 25°)

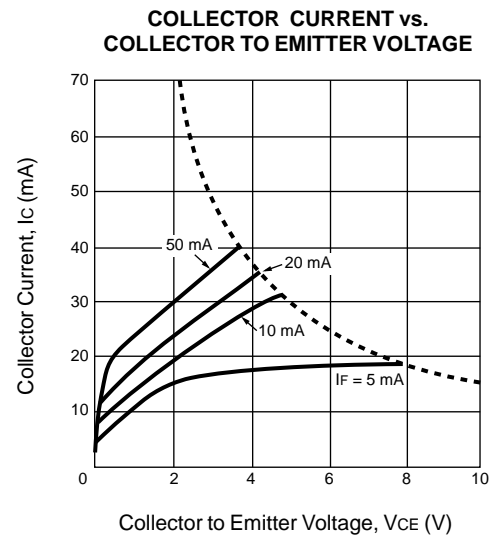
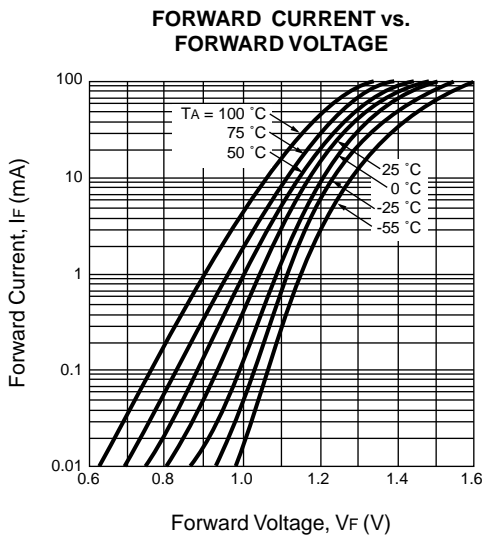
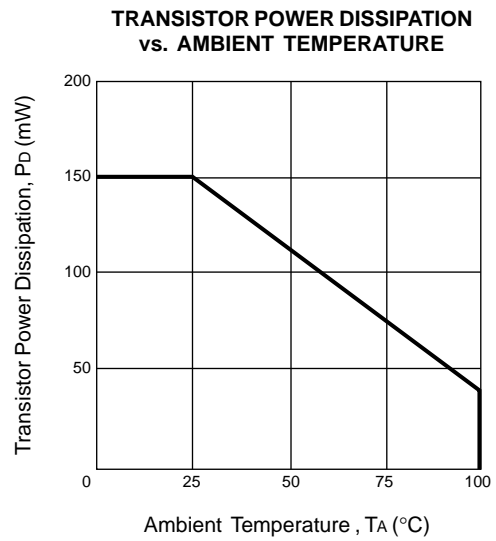
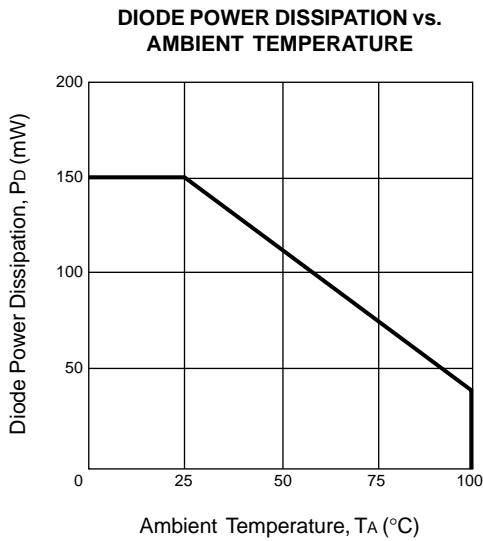

TYPICAL PERFORMANCE CURVES ($T_A = 25^\circ$)

COLLECTOR TO EMITTER DARK CURRENT vs. AMBIENT TEMPERATURE

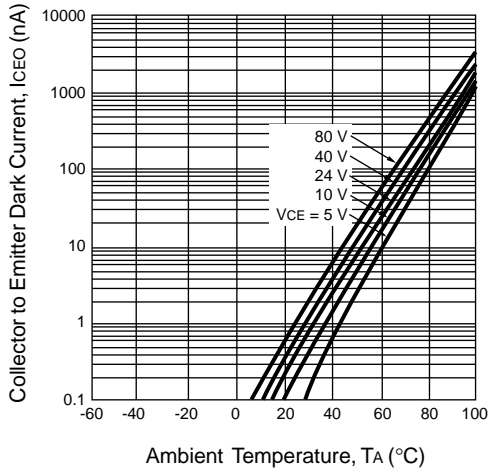

COLLECTOR CURRENT vs. COLLECTOR SATURATION VOLTAGE

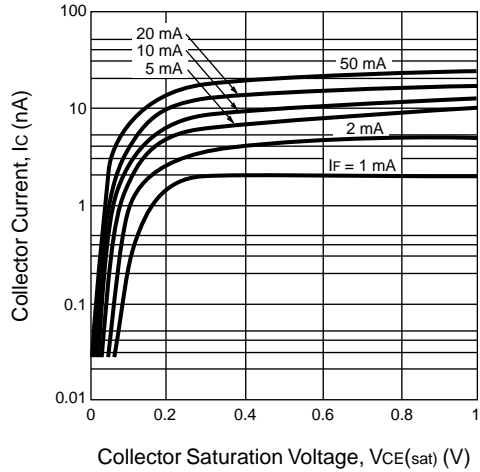

NORMALIZED OUTPUT CURRENT vs. AMBIENT TEMPERATURE

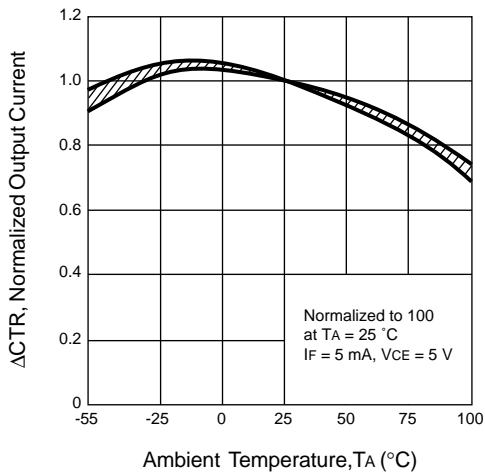

CURRENT TRANSFER RATIO (CTR) vs. FORWARD CURRENT

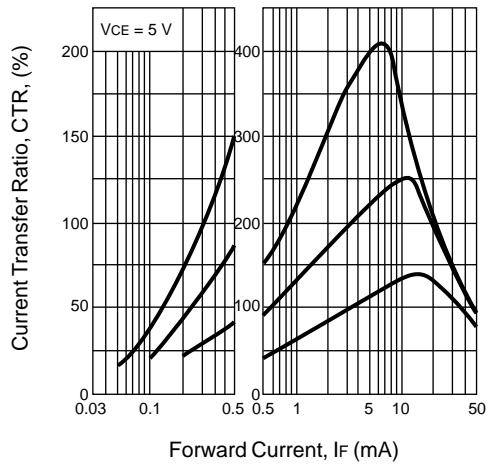

SWITCHING TIME vs. LOAD RESISTANCE

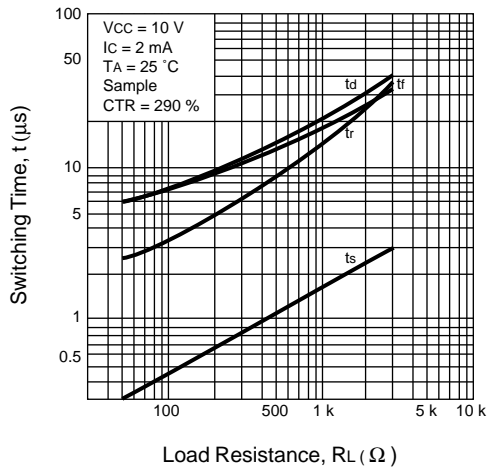

SWITCHING TIME vs. LOAD RESISTANCE

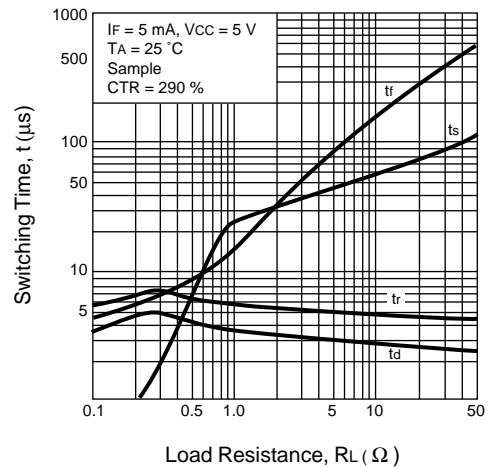

TYPICAL PERFORMANCE CURVES (TA = 25°C)

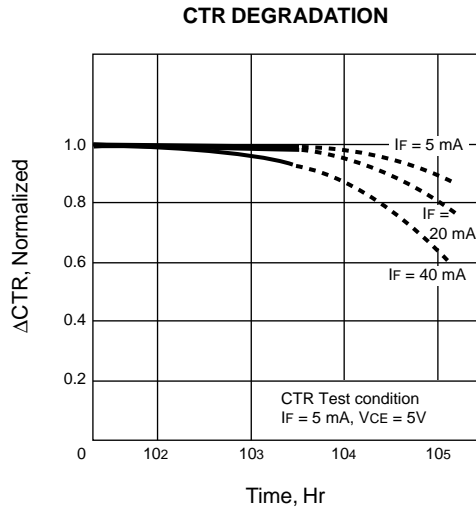
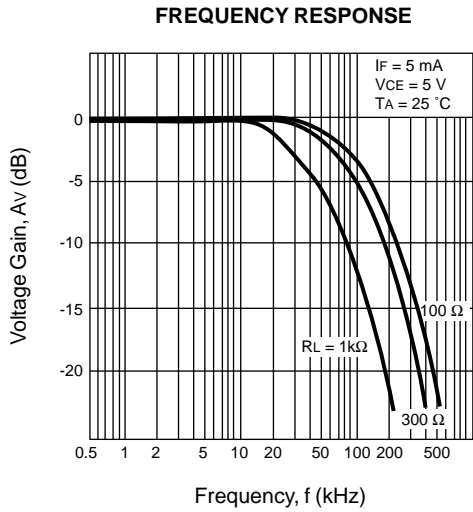

OUTLINE DIMENSIONS (Units in mm)

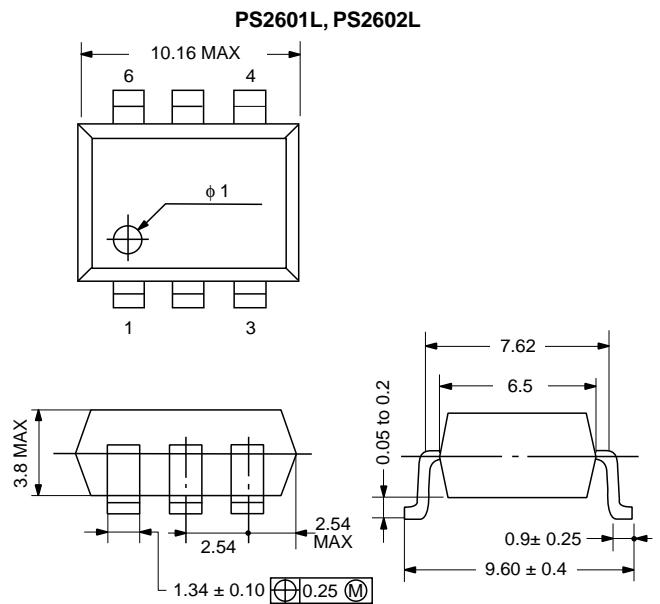
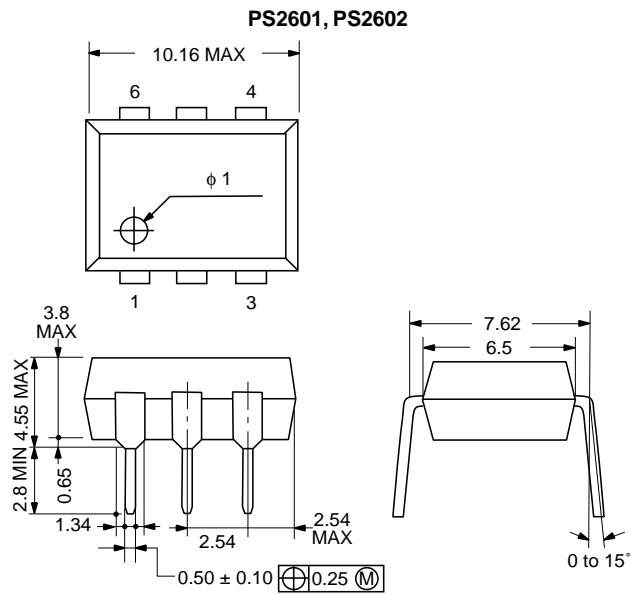

PIN CONNECTIONS (Top View)

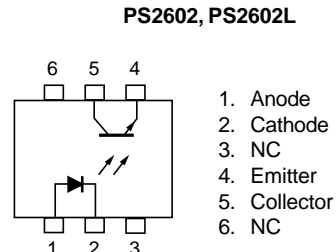
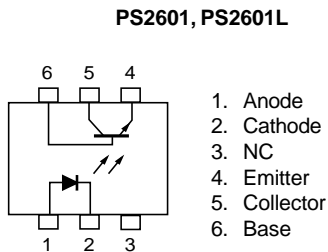

EXCLUSIVE NORTH AMERICAN AGENT FOR **NEC** RF, MICROWAVE & OPTOELECTRONIC SEMICONDUCTORS

CEL CALIFORNIA EASTERN LABORATORIES • Headquarters • 4590 Patrick Henry Drive • Santa Clara, CA 95054-1817 • (408) 988-3500 • Telex 34-6393 • FAX (408) 988-0279
24-Hour Fax-On-Demand: 800-390-3232 (U.S. and Canada only) • Internet: <http://WWW.CEL.COM>

DATA SUBJECT TO CHANGE WITHOUT NOTICE

PRINTED IN USA ON RECYCLED PAPER -3/98