

FEATURES

- **HIGH ISOLATION VOLTAGE**
BV: 5 k Vr.m.s. MIN
- **AC INPUT RESPONSE**
- **HIGH COLLECTOR TO EMITTER VOLTAGE**
V_{CEO}: 80 V MIN
- **HIGH SPEED SWITCHING**
tr = 3 μs, tf = 5 μs TYP
- **HIGH CURRENT TRANSFER RATIO**
CTR: 300% TYP

DESCRIPTION

PS2605, PS2606, PS2605L and PS2606L are optically coupled isolators containing a GaAs light emitting diode and an NPN silicon phototransistor. PS2605 and PS2606 are in a plastic DIP (Dual In-line Package). PS2605L and PS2606L are lead bending type (Gull-wing) for surface mount. PS2605 and PS2605L have a base pin, PS2606 and PS2606L have no base pin.

APPLICATIONS

Interface circuit for various instrumentations and control equipment.

- **AC LINE / DIGITAL LOGIC**
- **DIGITAL LOGIC / DIGITAL LOGIC**
- **TWISTED PAIR LINE RECEIVER**
- **TELEPHONE / TELEGRAPH LINE RECEIVER**
- **HIGH FREQUENCY POWER SUPPLY
FEEDBACK CONTROL**

ELECTRICAL CHARACTERISTICS (T_A = 25°C)

PART NUMBER			PS2605, PS2605L, PS2606, PS2606L			
SYMBOLS	PARAMETERS	UNITS	MIN	TYP	MAX	
Diode	V _F	Forward Voltage, I _F = ± 10 mA	V	1.1	1.4	
	C	Junction Capacitance, V = 0, f = 1.0 MHz	pF	60		
Transistor	I _{CEO}	Collector to Emitter Dark Current, V _{CE} = 80 V, I _F = 0	nA		100	
	BV _{CEO}	Collector to Emitter Breakdown Voltage, I _C = 1 mA, I _B = 0	V	80		
	BV _{ECO}	Emitter to Collector Breakdown Voltage, I _E = 100 μA, I _B = 0	V	7		
Coupled	CTR	Current Transfer Ratio, I _F = ± 5 mA, V _{CE} = 5 V	%	80	300	600
	CTR ₁ /CTR ₂	CTR ¹ (Ratio), I _F = ± 5 mA, V _{CE} = 5 V	%	0.3	1.0	3.0
	V _{CE(sat)}	Collector Saturation Voltage, I _F = ± 10 mA, I _C = 2 mA	V			0.3
	R ₁₋₂	Isolation Resistance, V _{IN-OUT} = 1.0 k V	Ω	10 ¹¹		
	C ₁₋₂	Isolation Capacitance, V = 0, f = 1.0 MHz	pF		0.6	
	tr	Rise Time ² , V _{CC} = 5 V, I _C = 2 mA	μs		3	
	tf	Fall Time ² , V _{CC} = 5 V, I _C = 2 mA	μs		5	

Notes:

1. $CTR_1 = \frac{I_{C1}}{I_{F1}}$ · $CTR_2 = \frac{I_{C2}}{I_{F2}}$

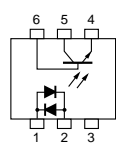
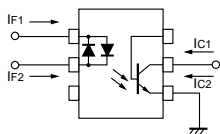

PS2605

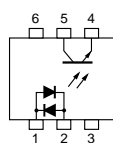

PS2606

2. Test Circuit for Switching Time

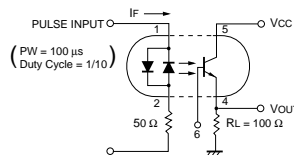

PS2605

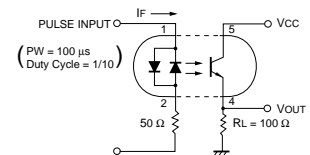

PS2606

ABSOLUTE MAXIMUM RATINGS¹ (T_A = 25°C)

SYMBOLS	PARAMETERS	UNITS	RATINGS
Diode			
I _F	Forward Current (DC)	mA	80
P _D	Power Dissipation	mW	150
I _F (PEAK)	Peak Forward Current (PW = 100 μs, Duty Cycle 1%)	A	1
Transistor			
V _{CEO}	Collector to Emitter Voltage	V	80
V _{ECO}	Emitter to Collector Voltage	V	7
I _C	Collector Current	mA	50
P _C	Power Dissipation	mW	150
Coupled			
BV	Isolation Voltage ²	V _{r.m.s.}	5000
T _{STG}	Storage Temperature	°C	-55 to +150
T _{OP}	Operating Temperature	°C	-55 to +100

Notes:

1. Operation in excess of any one of these parameters may result in permanent damage.
2. AC voltage for 1 minute at T_A = 25° C, RH = 60% between input (Pin No. 1, 2, 3 common) and output (Pin No. 4, 5, 6 common).

TYPICAL PERFORMANCE CURVES (T_A = 25°)

DIODE POWER DISSIPATION vs. AMBIENT TEMPERATURE

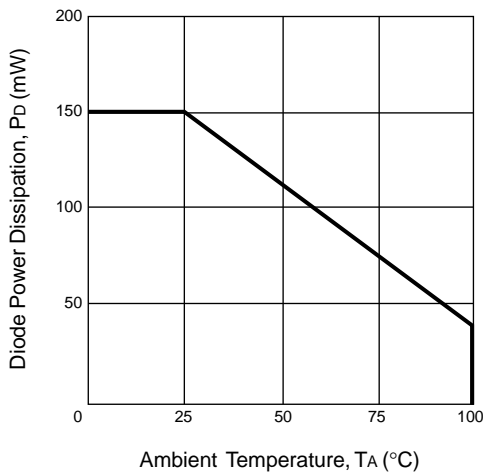

TRANSISTOR POWER DISSIPATION vs. AMBIENT TEMPERATURE

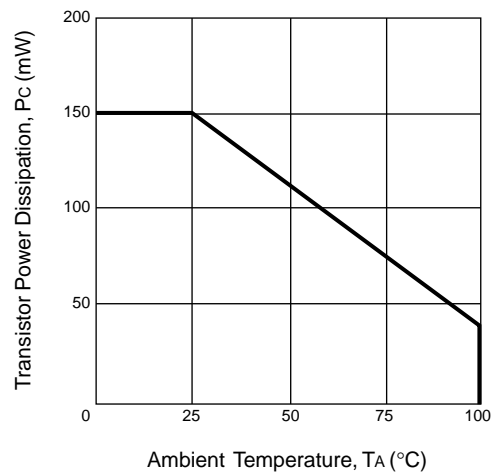

FORWARD CURRENT vs. FORWARD VOLTAGE

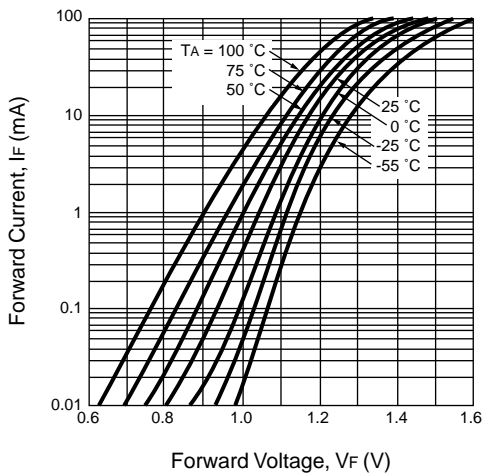

FORWARD CURRENT vs. FORWARD VOLTAGE

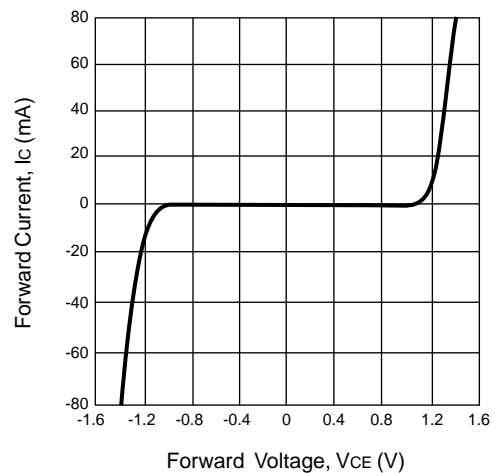

TYPICAL PERFORMANCE CURVES ($T_A = 25^\circ$)

COLLECTOR TO EMITTER DARK CURRENT vs. AMBIENT TEMPERATURE

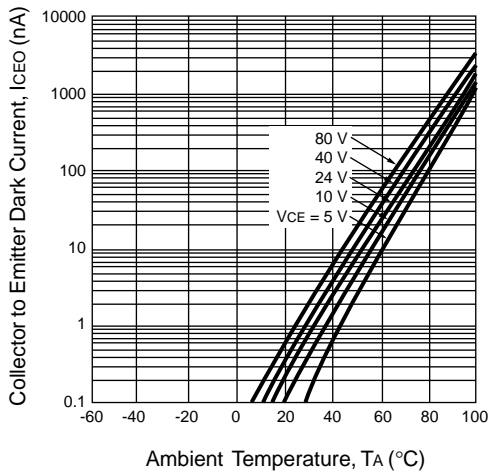

COLLECTOR CURRENT vs. COLLECTOR SATURATION VOLTAGE

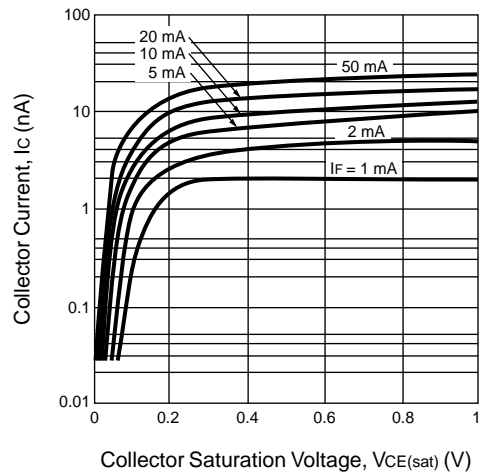

COLLECTOR CURRENT vs. COLLECTOR TO EMITTER VOLTAGE

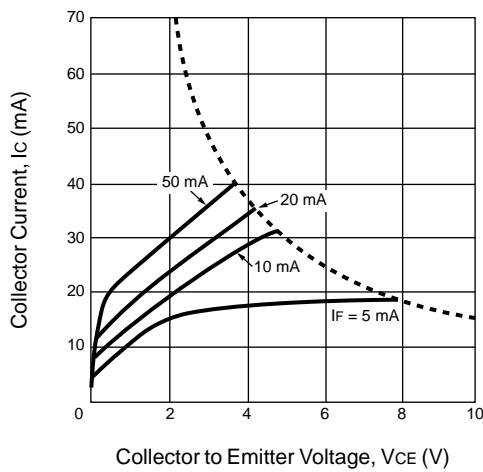

NORMALIZED OUTPUT CURRENT vs. AMBIENT TEMPERATURE

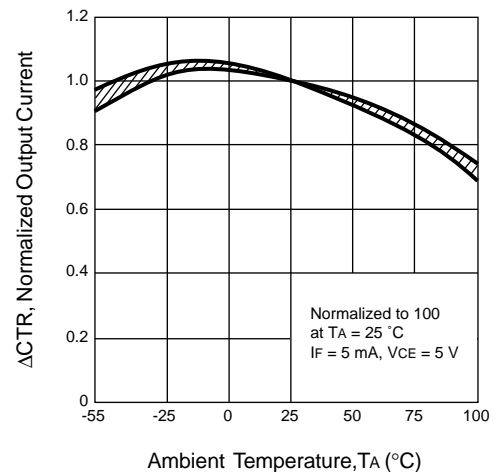

CURRENT TRANSFER RATIO (CTR) vs. FORWARD CURRENT

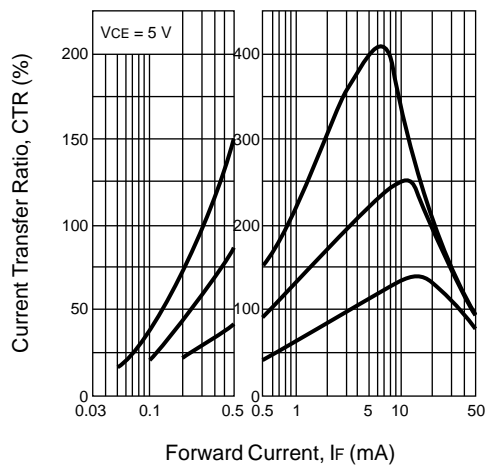

SWITCHING TIME vs. LOAD RESISTANCE

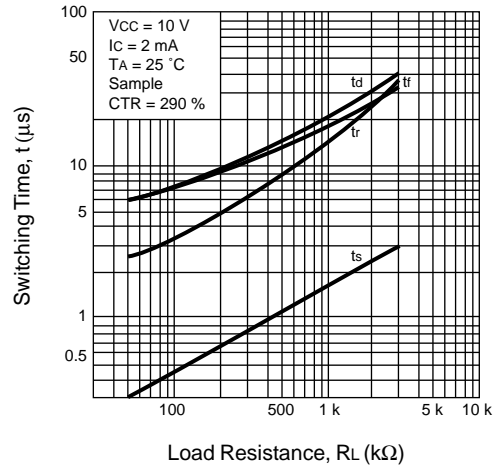

TYPICAL PERFORMANCE CURVES (TA = 25°C)

SWITCHING TIME vs. LOAD RESISTANCE

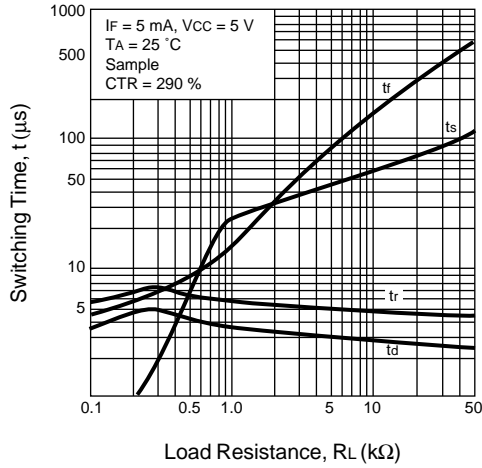

FREQUENCY RESPONSE

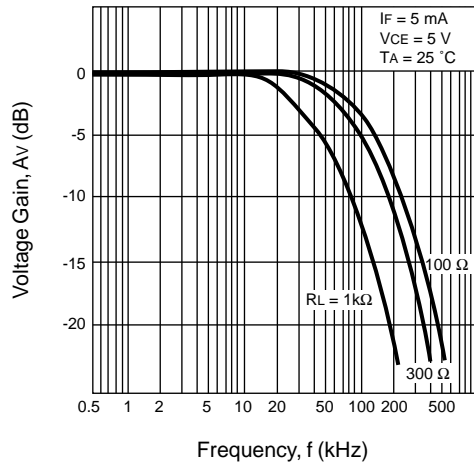

OUTLINE DIMENSIONS (Units in mm)

PS2605, PS2606

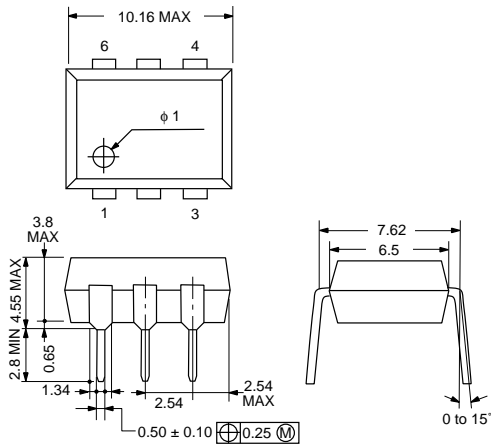

PS2605L, PS2606L

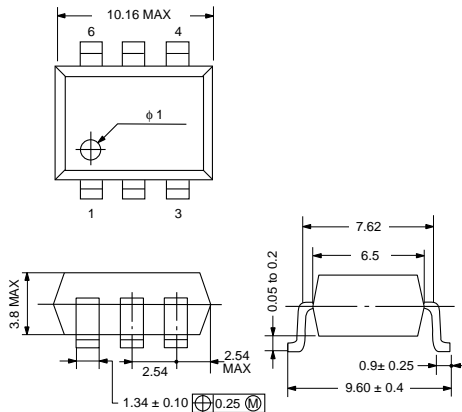

CTR DEGRADATION

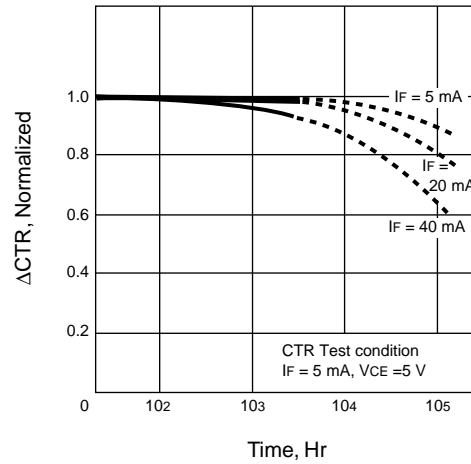

PIN CONNECTIONS (Top View)

PS2605, PS2605L

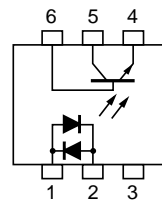

- 1. Anode, Cathode
- 2. Cathode, Anode
- 3. NC
- 4. Emitter
- 5. Collector
- 6. Base

PS2606, PS2606L

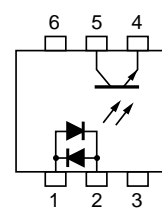

- 1. Anode, Cathode
- 2. Cathode, Anode
- 3. NC
- 4. Emitter
- 5. Collector
- 6. NC

EXCLUSIVE NORTH AMERICAN AGENT FOR **NEC** RF, MICROWAVE & OPTOELECTRONIC SEMICONDUCTORS

CEL CALIFORNIA EASTERN LABORATORIES • Headquarters • 4590 Patrick Henry Drive • Santa Clara, CA 95054-1817 • (408) 988-3500 • Telex 34-6393 • FAX (408) 988-0279
24-Hour Fax-On-Demand: 800-390-3232 (U.S. and Canada only) • Internet: <http://WWW.CEL.COM>

DATA SUBJECT TO CHANGE WITHOUT NOTICE

PRINTED IN USA ON RECYCLED PAPER -3/98