

DIPLEXERS FOR CABLE MODEMS, SET TOP BOXES & HFC EQUIPMENT

For International Applications

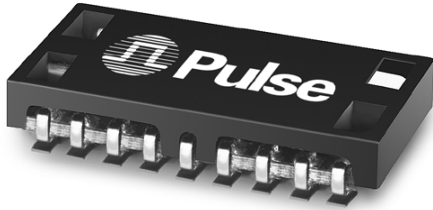

- ⊕ Small surface mount component
- ⊕ 65/85 frequency split
- ⊕ Good isolation port to port
- ⊕ No tuning required

Mechanical

CX6008

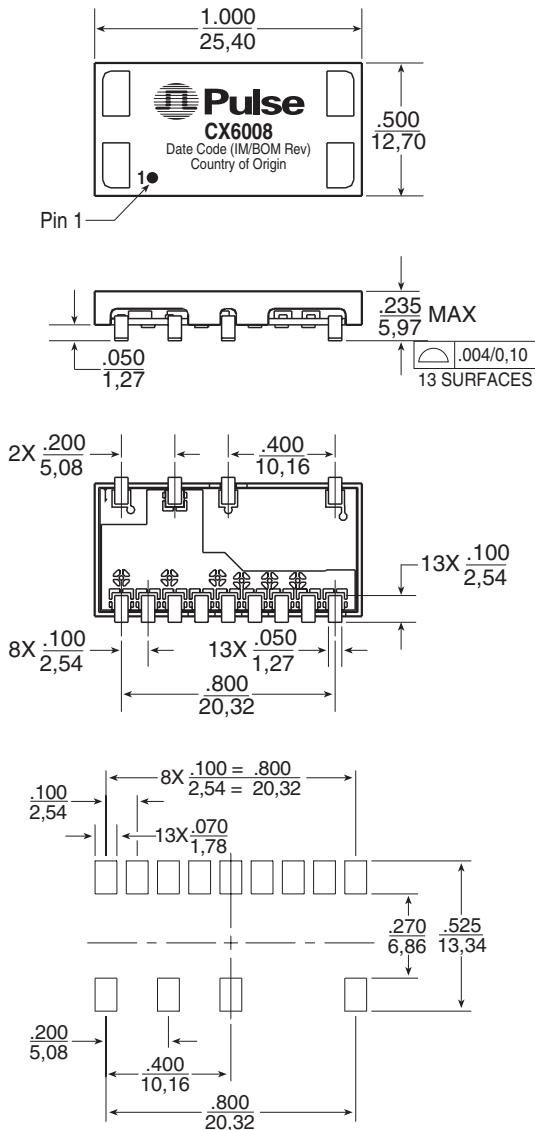

Electrical Specifications @ 25°C Operating Temperature -40°C to +85°C

CX6008

LOW PASS FILTER

Passband	5 - 65 MHz	Insertion loss <1 dB (including ripple)
Return Loss	5 - 65 MHz	18 dB typical; 14 dB minimum

HIGH PASS FILTER

Passband	at 85 MHz	Insertion loss: <2 dB
	at 88 MHz	Insertion loss: 1.5 dB
	100 - 864 MHz	Insertion loss <1 dB (including ripple)
Return Loss	85 - 200 MHz	20 dB typical; 12 dB minimum
	200 - 864 MHz	20 dB typical; 9 dB minimum
Impedance	75 Ω	All ports
Isolation (Port to Port)	5 - 65 MHz	45 dB minimum
	85 - 864 MHz	30 dB minimum.
Crossover Isolation	65 - 85 MHz	18 dB minimum

Schematic

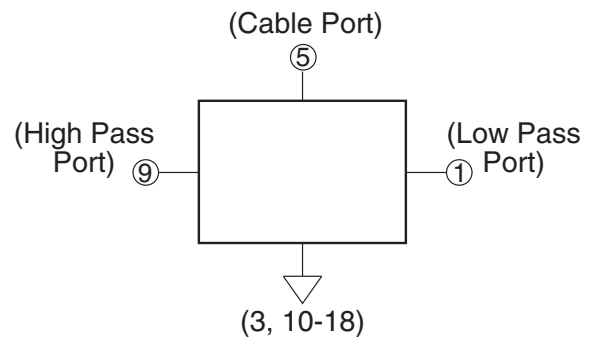

Weight3.5 grams
Tape & Reel500/reel
Tube20/tube

Dimensions: $\frac{\text{Inches}}{\text{mm}}$ Unless otherwise specified, all tolerances are $\pm \frac{.010}{0,25}$

DIPLEXERS FOR CABLE MODEMS, SET TOP BOXES & HFC EQUIPMENT

For International Applications



Typical Performance @ 25°C CX6008

Low Pass Insertion Loss (TYP)

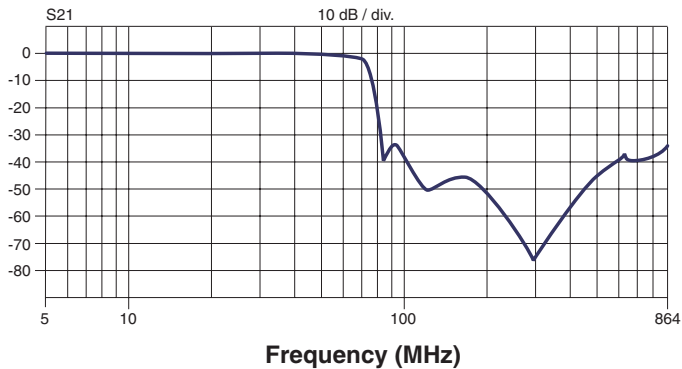

High Pass Insertion Loss (TYP)

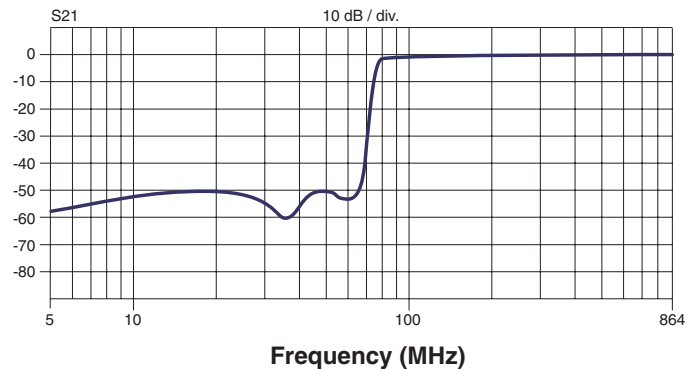

Isolation (TYP)

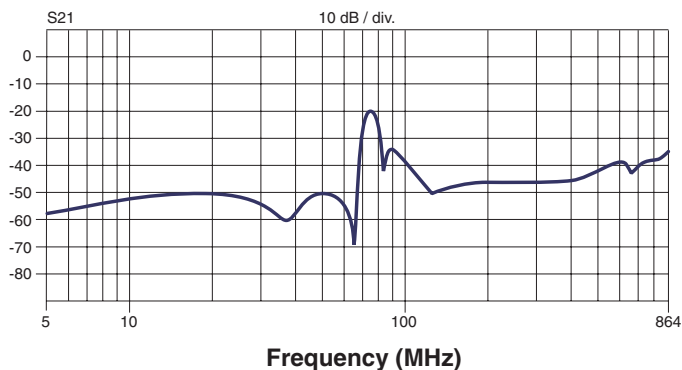

Passband Return Loss (TYP)

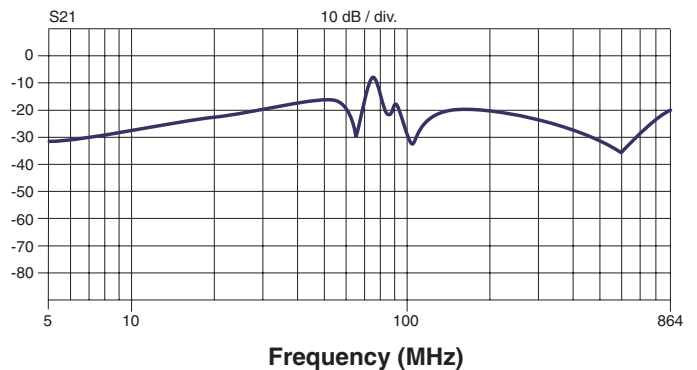

For More Information :

**UNITED STATES
(Worldwide)**

12220 World Trade Drive
San Diego, CA 92128
U.S.A.
<http://www.pulseeng.com>
TEL: 858 674 8100
FAX: 858 674 8262

**UNITED KINGDOM
(Northern Europe)**

1 & 2 Huxley Road
The Surrey Research Park
Guildford, Surrey GU2 5RE
United Kingdom
TEL: 44 1483 401700
FAX: 44 1483 401701

**FRANCE
(Southern Europe)**

Zone Industrielle
F-39270
Orgelet
France
TEL: 33 3 84 35 04 04
FAX: 33 3 84 25 46 41

**SINGAPORE
(Southern Asia)**

150 Kampong Ampat
#07-01/02
KA Centre
Singapore 368324
TEL: 65 287 8998
FAX: 65 280 0080

**TAIWAN, R.O.C.
(Northern Asia)**

3F-4, No. 81, Sec. 1
HsinTai Wu Road
Hsi-Chih, Taipei Hsien
Taiwan, R.O.C.
Tel: 886 2 2698 0228
FAX: 886 2 2698 0948

DISTRIBUTOR

Performance warranty of products offered on this data sheet is limited to the parameters specified. Data is subject to change without notice. Other brand and product names mentioned herein may be trademarks or registered trademarks of their respective owners.

Printed on recycled paper. ©2001, Pulse Engineering, Inc.

PRELIMINARY C216.P (6/01)