

# CERAFIL® (Filters/Traps/Discriminators) for Audio/Visual Equipment

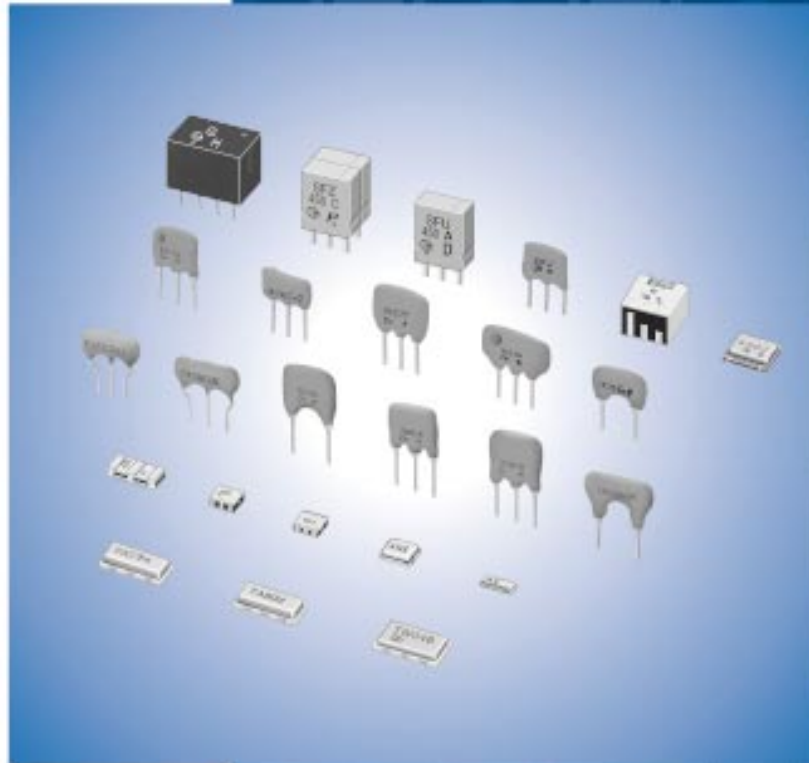

**muRata** *Innovator  
in Electronics*

Murata  
Manufacturing Co., Ltd.

Cat.No.P50E-3

**for EU RoHS Compliant**

- All the products in this catalog comply with EU RoHS.
- EU RoHS is "the European Directive 2002/95/EC on the Restriction of the Use of Certain Hazardous Substances in Electrical and Electronic Equipment".
- For more details, please refer to our website 'Murata's Approach for EU RoHS' (<http://www.murata.com/info/rohs.html>).

# CONTENTS

CERAFIL® and "CERAFIL" in this catalog are the trademarks of Murata Manufacturing Co., Ltd.

<b>Part Numbering</b>	2
<b>1 CERAFIL® 10.7MHz Small Chip Type SFECF Series</b>	7
<b>2 CERAFIL® 10.7MHz Chip Type SFECV Series</b>	13
<b>3 CERAFIL® 10.7MHz Standard Lead Type</b>	16
<b>4 CERAFIL® 10.7MHz Low Loss Type</b>	19
<b>5 CERAFIL® 10.7MHz Low Profile Type</b>	22
<b>6 CERAFIL® 10.7MHz Low Spurious Response Type</b>	25
<b>7 CERAFIL® 10.7MHz Wide Bandwidth Type</b>	28
<b>8 CERAFIL® 10.7MHz Narrow Bandwidth Type</b>	30
<b>9 CERAFIL® 10.7MHz for FM-IF Tuners</b>	33
<b>CERAFIL® 10.7MHz Related Data on Lead Type</b>	36
<b>10 CERAFIL® 4.5-6.5MHz Chip Type SFSKA Series</b>	37
<b>11 CERAFIL® 2.3-5.7MHz Chip Type SFSKB Series</b>	40
<b>12 CERAFIL® 4.5-6.5MHz Standard Lead Type SFSRA Series</b>	45
<b>13 CERAFIL® 3.5-6.5MHz for Chroma Signal SFSRA/F Series</b>	51
<b>14 CERAFIL® 455kHz Chip Type SFPKA Series</b>	52
<b>15 CERAFIL® 455kHz SFULA/SFZLA Series</b>	54
<b>16 CERAFIL® 455kHz SFPLA/CFWLA Series</b>	57
<b>17 CERAFIL® 455kHz for AM Stereo Wide Bandwidth Type SFPLA/CFWLA/CFULA Series</b>	59
<b>18 CERAFIL® 455kHz for AM Search-stop Signal Detection</b>	61
<b>CERAFIL® 455kHz SF Series Temperature Characteristics</b>	62
<b>CERAFIL® 455kHz SF/BF Series Application Circuit</b>	63
<b>19 Ceramic Trap 4.5-6.5MHz Chip Type TPSKA Series</b>	65
<b>20 Ceramic Trap 4.5-6.5MHz Chip Type Double Traps TPWKA Series</b>	67
<b>21 Ceramic Trap 4.5-6.5MHz Standard Lead Type TPSRA Series</b>	68
<b>22 Ceramic Trap 3.5-6.5MHz Two Lead Type TPSRF_J Series</b>	71
<b>23 Ceramic Trap 3.5-6.5MHz for 2ch Sound TV in Germany TPSRF_W Series</b>	74
<b>24 Ceramic Trap 3.5-6.5MHz Double Traps TPWRF Series</b>	75
<b>25 Ceramic Trap 3.5-6.5MHz Triple Traps TPTRF Series</b>	77
<b>26 Ceramic Discriminator 10.7MHz Ultra Thin Chip Type CDSCB Series</b>	78
<b>27 Ceramic Discriminator 10.7MHz Standard Lead Type CDALF Series</b>	83
<b>Ceramic Discriminator 10.7MHz Applied IC Reference Table</b>	87
<b>Notice (Soldering and Mounting)</b>	89
<b>Notice (Handling)</b>	93
<b>Packaging</b>	100

1
2
3
4
5
6
7
8
9
10
11
12
13
14
15
16
17
18
19
20
21
22
23
24
25
26
27

## ● Part Numbering

### CERAFIL® for FM

(Part Number)

SF	E	LF	10M7	F	A	A0	-B0
①	②	③	④	⑤	⑥	⑦	⑧

#### ① Product ID

Product ID	
SF	Ceramic Filters

#### ② Oscillation/Numbers of Element

Code	Oscillation/Numbers of Element
E	2 Elements Thickness Expander mode
T	3 Elements Thickness Expander mode
V	2 Elements Thickness Expander mode (2nd Harmonic)
K	2 Elements Thickness Expander mode (3rd Over Tone)

#### ③ Structure/Size

Code	Structure/Size
L□	Lead Type
C□	Chip Type

□ is expressed "A" or subsequent code, which indicates the structure/size.

#### ④ Nominal Center Frequency

Expressed by four-digit alphanumerics. The unit is in hertz (Hz). Decimal point is expressed by capital letter "M" in case of MHz.

#### ⑤ 3dB Bandwidth

Code	3dB Bandwidth
C	450kHz min
D	350kHz min
E	330kHz
F	280kHz
G	230kHz
H	180kHz
J	150kHz
K	110kHz
L	80kHz
M	50kHz
N	35kHz

#### ⑥ Center Frequency/Tolerance

Code	Center Frequency	Tolerance
A	Center Frequency mentioned by specification	±30kHz
B	-30kHz shifted from center frequency of code "A"	±30kHz
C	+30kHz shifted from center frequency of code "A"	±30kHz
D	-60kHz shifted from center frequency of code "A"	±30kHz
E	+60kHz shifted from center frequency of code "A"	±30kHz
H	Center Frequency mentioned by specification	±25kHz
V	-50kHz shifted from center frequency of code "H"	±25kHz
W	+50kHz shifted from center frequency of code "H"	±25kHz
K	Center Frequency mentioned by specification	±20kHz
Z	Combination of A, B, C, D, E	—
M	Combination of A, B, C	—
F	Nominal Center Frequency	—

3dB band width of "F" signifies the frequency difference (both + and -) from reference frequency which is nominal center frequency.

#### ⑦ Series

Code	Series
A0	Two-digit alphanumerics express series

#### ⑧ Packaging

Code	Packaging
-B0	Bulk
-R0	Embossed Taping ø180mm
-R1	Embossed Taping ø330mm
-A0	1500pcs. /Radial Taping H <sub>0</sub> =18mm
-A1	1000pcs. /Radial Taping H <sub>0</sub> =18mm

Radial taping is applied to lead type and embossed taping to chip type. With non-standard products, two-digit alphanumerics indicating "Individual Specification" is added between "⑦ Series" and "⑧ Packaging".

### CERAFIL® for TV/VCR

(Part Number) 

SF	S	RA	4M50	CF	00	-B0
①	②	③	④	⑤	⑥	⑦

#### ① Product ID

Product ID	
SF	Ceramic Filters

#### ② Oscillation/Numbers of Element

Code	Oscillation/Numbers of Element
S	2 Elements Thickness Shear mode
T	3 Elements Thickness Expander mode

#### ③ Structure/Size

Code	Structure/Size
R□	Lead Type
K□	Chip Type

□ is expressed "A" or subsequent code, which indicates the structure/size. SFT series has leaded type only.

#### ④ Nominal Center Frequency

Expressed by four-digit alphanumerics. The unit is in hertz (Hz). Decimal point is expressed by capital letter "M" in case of MHz.

#### ⑤ Product Specification Code (1)

Code	Product Specification Code (1)
AF	Standard Bandwidth Type
BF	Tight Bandwidth Type
CF	Standard Bandwidth Type
DF	Broad Bandwidth Type
EF	Ultra-broad Bandwidth Type

The code AF is not applied to SFS series but to SFT series only.

#### ⑥ Product Specification Code (2)

Code	Product Specification Code (2)
00	Standard Type

#### ⑦ Packaging

Code	Packaging
-B0	Bulk
-A0	Radial Taping H <sub>0</sub> =18mm
-R1	Embossed Taping ø=330mm

Radial taping is applied to lead type and embossed taping to chip type. With non-standard products, two-digit alphanumerics indicating "Individual Specification" is added between "⑥ Product Specification Code (2)" and "⑦ Packaging".

### CERAFIL® for AM

(Part Number) 

SF	P	KA	455K	D4A	-B0
①	②	③	④	⑤	⑥

#### ① Product ID

Product ID	
SF	Ceramic Filters
CF	Ceramic Filters

#### ② Oscillation/Numbers of Element

Code	Oscillation/Numbers of Element
U	1 Element Area Expansion mode
Z	2 Elements Area Expansion mode
P	4 Elements Area Expansion mode

#### ③ Structure/Size

Code	Structure/Size
L□	Lead Type
C□/K□	Chip Type

□ is "A" or subsequent code, which indicates the structure/size. It varies depending on vibration mode and number of elements.

#### ④ Nominal Center Frequency

Expressed by four-digit alphanumerics. The unit is in hertz (Hz). Capital letter "K" following three figures expresses the unit of "kHz".

#### ⑤ Product Specification

Code	Product Specification
D4A	Three-digit alphanumerics indicate product specification of 3dB or 6dB frequency tolerance.

□□A indicates standard type.

#### ⑥ Packaging

Code	Packaging
-B0	Bulk
-R0	Embossed Taping (ø180mm)
-R1	Embossed Taping (ø330mm)
-M0	Magazine Cassette

Radial taping is applied to lead type and embossed taping to chip type. With non-standard products, three-digit alphanumerics indicating "Individual Specification" is added between "⑤ Product Specification" and "⑥ Packaging".

### CERAFIL® for Search-stop Signal Detection

(Part Number)

**BF** **U** **LA** **450K** **C** **-B0**  
 ① ② ③ ④ ⑤ ⑥

#### ① Product ID

Product ID	
<b>BF</b>	Resonator

#### ② Oscillation/Numbers of Element

Code	Oscillation/Numbers of Element
<b>U</b>	1 Element Area Expansion mode

#### ③ Structure/Size

Code	Structure/Size
<b>LA</b>	Lead Type Standard

#### ④ Nominal Center Frequency

Code	Nominal Center Frequency
<b>450K</b>	450kHz

#### ⑤ Product Specification

Code	Product Specification
<b>C</b> <input type="checkbox"/>	Bandwidth

With standard type,  is omitted.

#### ⑥ Packaging

Code	Packaging
<b>-B0</b>	Bulk

With non-standard products, "Individual Specification (serial number)" and "Lead Shape (Lead Bend : B)" are added between "⑤ Product Specification" and "⑥ Packaging" upon specification.

## Ceramic Traps

(Part Number)

TP	S	RA	4M50	B	00	-B0
①	②	③	④	⑤	⑥	⑦

### ① Product ID

Product ID	
TP	Ceramic Traps

### ② Function

Code	Function
S	Single Traps
T	Triple Traps
W	Double Traps

### ③ Structure/Size

Code	Structure/Size
R□	Lead Type
K□	Chip Type

□ is expressed "A" or subsequent code, which indicates the structure/size.

### ④ Nominal Center Frequency

Expressed by four-digit alphanumerics. The unit is in hertz (Hz).  
 Decimal point is expressed by capital letter "M".

(Part Number)

TP	A	LF	9M80	J	00	-B0
①	②	③	④	⑤	⑥	⑦

### ① Product ID

Product ID	
TP	Ceramic Traps

### ② Function

Code	Function
A	Single Traps

### ③ Structure/Size

Code	Structure/Size
L□	Lead Type

□ is expressed "A" or subsequent code, which indicates the structure/size.

### ④ Nominal Center Frequency

Expressed by four-digit alphanumerics. The unit is in hertz (Hz).  
 Decimal point is expressed by capital letter "M" in case of MHz.

### ⑤ Product Specification Code (1)

Code	Product Specification (1)
B	Broad-bandwidth Type
C	Low-capacitance Type

### ⑥ Product Specification Code (2)

Code	Product Specification (2)
00	Standard Type

### ⑦ Packaging

Code	Packaging
-B0	Bulk
-A0	Radial Taping H <sub>0</sub> =18mm
-R1	Embossed Taping ø=330mm

Radial taping is applied to lead type and embossed taping to chip type. With non-standard products, three-digit alphanumerics indicating "Individual Specification" is added between "⑥ Product Specification Code (2)" and "⑦ Packaging".

### ⑤ Product Specification Code (1)

Code	Product Specification (1)
J	2 Terminal Type

### ⑥ Product Specification Code (2)

Code	Product Specification (2)
00	Standard Type

### ⑦ Packaging

Code	Packaging
-B0	Bulk
-A0	Radial Taping H <sub>0</sub> =18mm
-R1	Embossed Taping ø=330mm

Radial taping is applied to lead type and embossed taping to chip type. With non-standard products, three-digit alphanumerics indicating "Individual Specification" is added between "⑥ Product Specification Code (2)" and "⑦ Packaging".

## Discriminators for FM

(Part Number)

<b>CD</b>	<b>A</b>	<b>LF</b>	<b>10M7</b>	<b>G</b>	<b>A</b>	<b>001</b>	<b>-B0</b>
①	②	③	④	⑤	⑥	⑦	⑧

### ① Product ID

Product ID	
<b>CD</b>	Discriminators

### ② Oscillation

Code	Oscillation
<b>A</b>	Thickness Expander mode
<b>S</b>	Thickness Shear mode

### ③ Structure/Size

Code	Structure/Size
<b>L□</b>	Lead Type
<b>C□</b>	Chip Type

□ is expressed "A" or subsequent code, which indicates the structure/size.

### ④ Nominal Center Frequency

Expressed by four-digit alphanumerics. The unit is in hertz (Hz).  
 Decimal point is expressed by capital letter "M" in case of MHz.

### ⑤ Series

Code	Series
<b>G</b>	Two-digit alphanumerics express series

### ⑥ Center Frequency/Tolerance

Code	Center Frequency	Tolerance
<b>A</b>	Center Frequency mentioned by specification	±30kHz
<b>B</b>	-30kHz shifted from center frequency of code "A"	±30kHz
<b>C</b>	+30kHz shifted from center frequency of code "A"	±30kHz
<b>D</b>	-60kHz shifted from center frequency of code "A"	±30kHz
<b>E</b>	+60kHz shifted from center frequency of code "A"	±30kHz
<b>H</b>	Center Frequency mentioned by specification	±25kHz
<b>V</b>	-50kHz shifted from center frequency of code "H"	±25kHz
<b>W</b>	+50kHz shifted from center frequency of code "H"	±25kHz
<b>K</b>	Center Frequency mentioned by specification	±20kHz
<b>Z</b>	Combination of A, B, C, D, E	—
<b>M</b>	Combination of A, B, C	—
<b>F</b>	Nominal Center Frequency	—

3dB band width of "F" signifies the frequency difference (both + and -) from reference frequency which is nominal center frequency.

### ⑦ IC

Code	IC
<b>001</b>	Applicable IC Control Code

### ⑧ Packaging

Code	Packaging
<b>-B0</b>	Bulk
<b>-A0</b>	Radial Taping H <sub>0</sub> =18mm
<b>-R0</b>	Embossed Taping ø=180mm
<b>-R1</b>	Embossed Taping ø=330mm

Radial taping is applied to lead type and embossed taping to chip type. With non-standard products, an alphanumerics indicating "Individual Specification" is added between "⑦IC" and "⑧Packaging".



# CERAFIL® (Filters/Traps/Discriminators) for Audio/Visual Equipment



1

## CERAFIL® 10.7MHz Small Chip Type SFECF Series

SFECF10M7 series for FM-receivers are small, high performance and super thin (1.4mm max.) filters. Piezoelectric element is connected in the sandwich shape by ceramics substrate. They have 1.4mm max. thickness and small mounting area. (3.45x3.1mm)

SFECF series and CDSCB series (MHz Discriminator) enable customers to make VICS/RKE/TPMS set so thin and small sized.

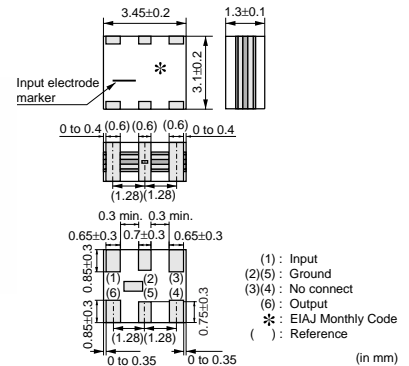

### ■ Features

1. The filters are mountable by automatic placers.
2. They are slim, at only 1.4mm max. thickness, and have a small mounting area (3.45x3.1mm) enabling flexible PCB design.
3. Various bandwidths are available. Select a suitable type in accordance with the desired selectivity.
4. Operating temperature range:
  - 20 to +80 (degrees C) (Standard Type)/
  - 40 to +85 (degrees C) (High-reliability Type)
 Storage temperature range:
  - 40 to +85 (degrees C) (Standard Type)/
  - 55 to +85 (degrees C) (High-reliability Type)

### Standard Type

Part Number	Center Frequency (fo) (MHz)	Nominal Center Frequency (fn) (MHz)	3dB Bandwidth (kHz)	Attenuation (kHz)	Insertion Loss (dB)	Ripple (dB)	Spurious Attenuation (1) (dB)	Input/Output Impedance (ohm)	Spurious Attenuation (2) (dB)
SFECF10M7HA00-R0	10.700 ±30kHz	-	180 ±40kHz	470 max.	4.0 ±2.0dB	1.0 max.	30 min.	330	-
SFECF10M7HF00-R0	-	10.700	fn±25 min.	510 max.	8.0 max. [at fn]	1.0 max.	30 min. [within 9MHz to fn]	330	25 min. [within fn to 12MHz]
SFECF10M7GA00-R0	10.700 ±30kHz	-	230 ±50kHz	510 max.	3.5 ±2.0dB	1.0 max.	30 min.	330	-
SFECF10M7GF00-R0	-	10.700	fn±45 min.	560 max.	8.0 max. [at fn]	1.0 max.	30 min. [within 9MHz to fn]	330	25 min. [within fn to 12MHz]
SFECF10M7FA00-R0	10.700 ±30kHz	-	280 ±50kHz	590 max.	3.0 ±2.0dB	1.0 max.	30 min.	330	-
SFECF10M7FF00-R0	-	10.700	fn±65 min.	620 max.	7.0 max. [at fn]	1.0 max.	30 min. [within 9MHz to fn]	330	25 min. [within fn to 12MHz]
SFECF10M7EA00-R0	10.700 ±30kHz	-	330 ±50kHz	700 max.	3.0 ±2.0dB	1.0 max.	30 min.	330	-
SFECF10M7DA0001-R0	10.700 ±30kHz	-	420 min.	950 max.	3.0 ±2.0dB	3.0 max.	35 min. [within 9MHz to fo]	330	25 min. [within fo to 12MHz]
SFECF10M7DF00-R0	-	10.700	fn±150 min.	990 max.	6.0 max. [at fn]	3.0 max.	20 min.	330	-
SFECF10M7CQ00-R0	10.700 ±30kHz	-	500 ±50kHz	950 max.	2.0 +2.0/-1.0dB	3.0 max.	30 min. [within 9MHz to fo]	470	25 min. [within fo to 12MHz]

Area of Attenuation: [within 20dB] Area of Spurious Attenuation: [within 9MHz to 12MHz]  
 Area of Insertion Loss: at minimum loss point Area of Ripple: within 3dB B.W.  
 Center frequency (fo) defined by the center of 3dB bandwidth.  
 For safety purposes, connect the output of filters to the IF amplifier through a D.C. blocking capacitor. Avoid applying a direct current to the output of ceramic filters.  
 The order quantity should be an integral multiple of the "Minimum Quantity" shown in the package page.



## High-reliability Type

Part Number	Center Frequency (fo) (MHz)	Nominal Center Frequency (fn) (MHz)	3dB Bandwidth (kHz)	Attenuation (kHz)	Insertion Loss (dB)	Ripple (dB)	Spurious Attenuation (1) (dB)	Input/Output Impedance (ohm)	Spurious Attenuation (2) (dB)
SFECF10M7HA00S0-R0	10.700 ±30kHz	-	180 ±40kHz	470 max.	4.0 ±2.0dB	1.0 max.	30 min.	330	-
SFECF10M7HF00S0-R0	-	10.700	fn±25 min.	510 max.	8.0 max. [at fn]	1.0 max.	30 min. [within 9MHz to fn]	330	25 min. [within fn to 12MHz]
SFECF10M7GA00S0-R0	10.700 ±30kHz	-	230 ±50kHz	510 max.	3.5 ±2.0dB	1.0 max.	30 min.	330	-
SFECF10M7GF00S0-R0	-	10.700	fn±45 min.	560 max.	8.0 max. [at fn]	1.0 max.	30 min. [within 9MHz to fn]	330	25 min. [within fn to 12MHz]
SFECF10M7FA00S0-R0	10.700 ±30kHz	-	280 ±50kHz	590 max.	3.0 ±2.0dB	1.0 max.	30 min.	330	-
SFECF10M7FF00S0-R0	-	10.700	fn±65 min.	630 max.	7.0 max. [at fn]	1.0 max.	30 min. [within 9MHz to fn]	330	25 min. [within fn to 12MHz]
SFECF10M7EA00S0-R0	10.700 ±30kHz	-	330 ±50kHz	700 max.	3.0 ±2.0dB	1.0 max.	30 min.	330	-
SFECF10M7DF00S0-R0	-	10.700	fn±145 min.	990 max.	6.0 max. [at fn]	3.0 max.	20 min.	330	-
SFECF10M7CQ00S0-R0	10.700 ±30kHz	-	500 ±50kHz	950 max.	2.0 +2.0/-1.0dB	3.0 max.	30 min. [within 9MHz to fo]	470	25 min. [within fo to 12MHz]

Area of Attenuation: [within 20dB] Area of Spurious Attenuation: [within 9MHz to 12MHz]

Area of Insertion Loss: at minimum loss point Area of Ripple: within 3dB B.W.

Center frequency (fo) defined by the center of 3dB bandwidth.

For safety purposes, connect the output of filters to the IF amplifier through a D.C. blocking capacitor. Avoid applying a direct current to the output of ceramic filters.

The order quantity should be an integral multiple of the "Minimum Quantity" shown in the package page.

### Standard Center Frequency Rank Code

CODE	30kHz Step	25kHz Step
D	10.64MHz±30kHz	10.650MHz±25kHz
B	10.67MHz±30kHz	10.675MHz±25kHz
A	10.70MHz±30kHz	10.700MHz±25kHz
C	10.73MHz±30kHz	10.725MHz±25kHz
E	10.76MHz±30kHz	10.750MHz±25kHz
Z	Combination A, B, C, D, E	
M	Combination A, B, C	

### Standard Land Pattern Dimensions

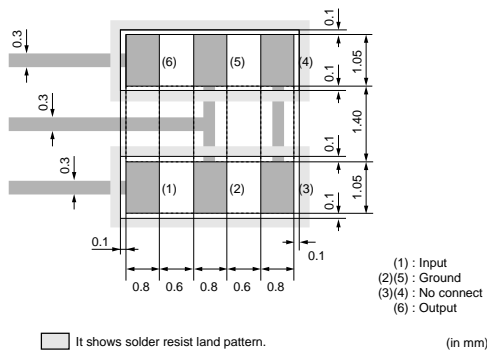

### Test Circuit

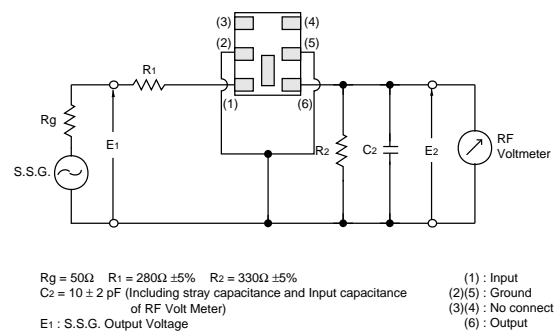

Continued on the following page. ↗

Continued from the preceding page.

## Frequency Characteristics Standard Type

1

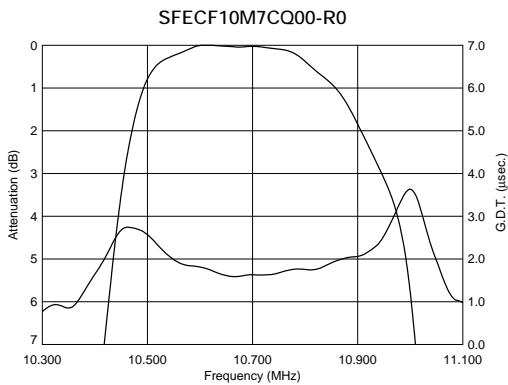
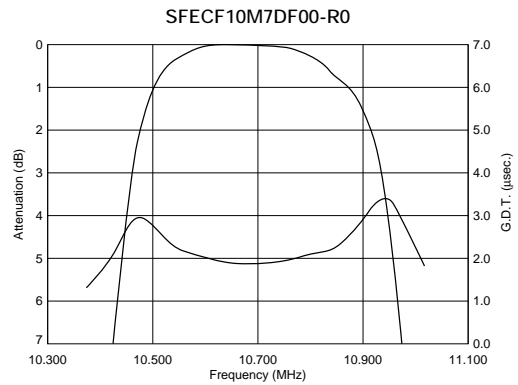
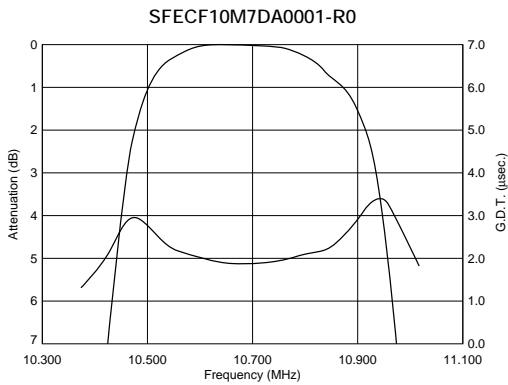
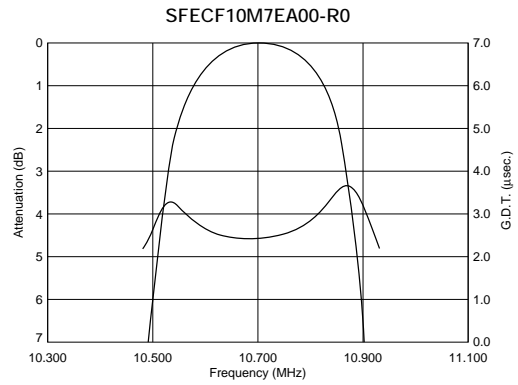
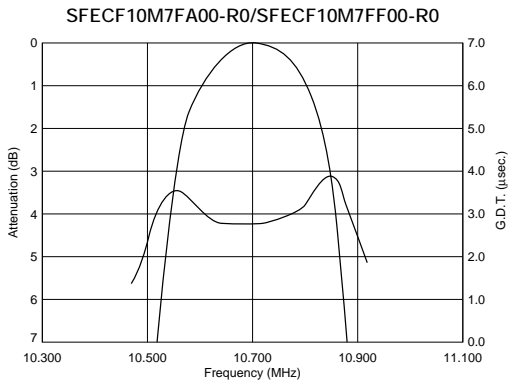
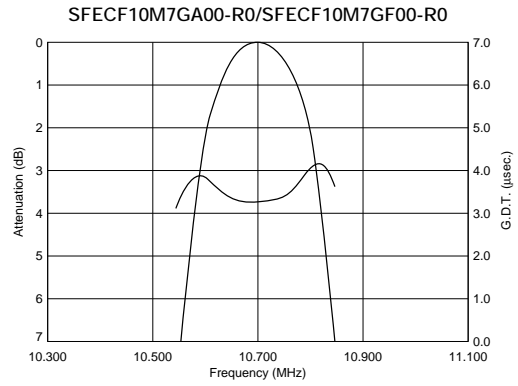
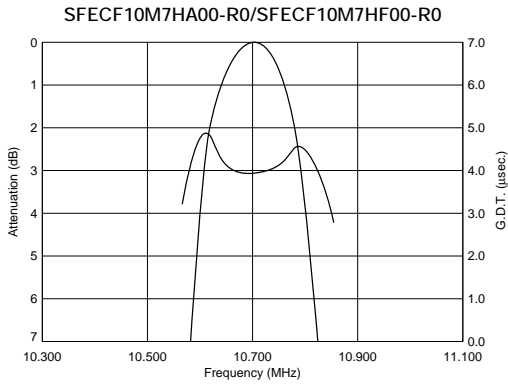

1

Frequency Characteristics High-reliability Type

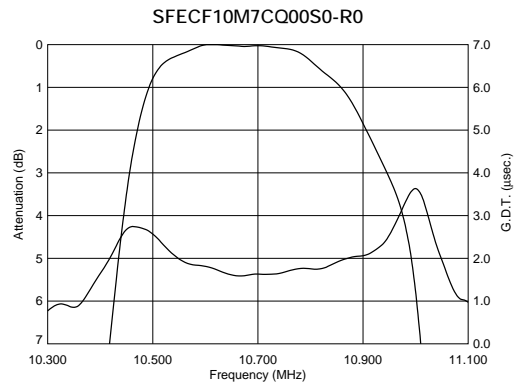
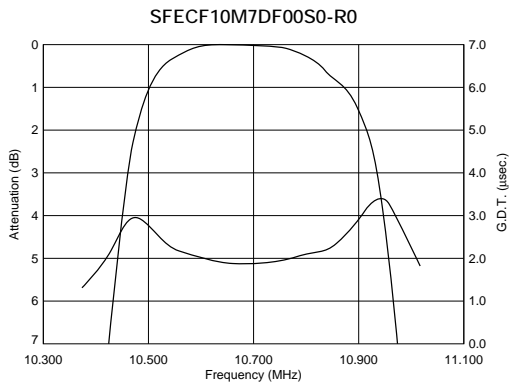
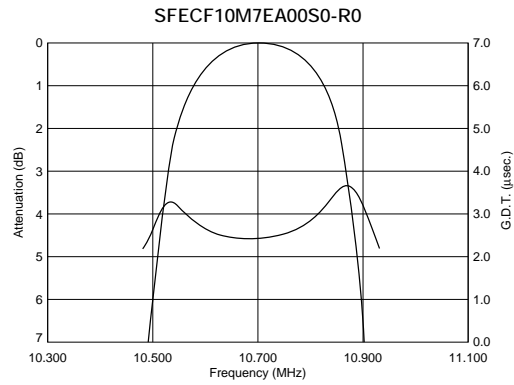
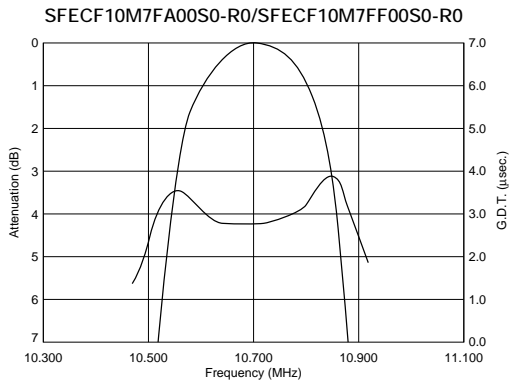
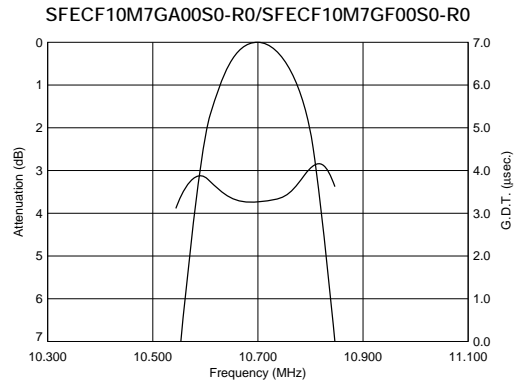
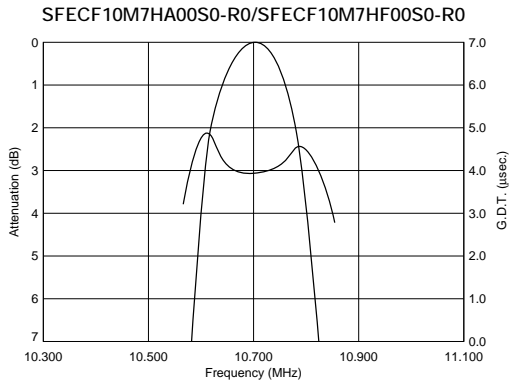

## Frequency Characteristics (Spurious) Standard Type

1

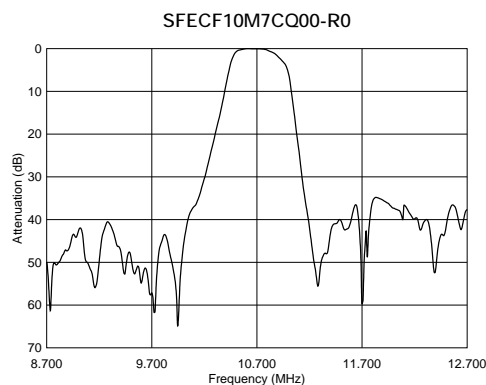
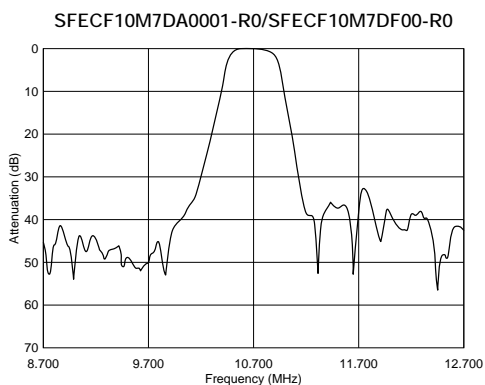
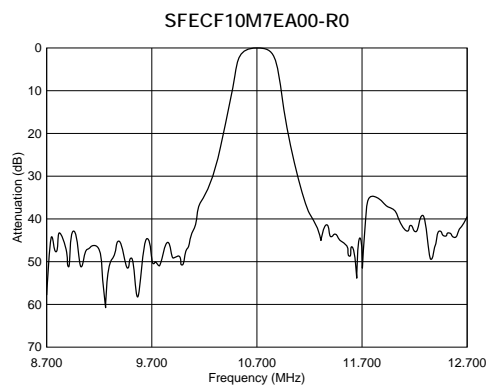
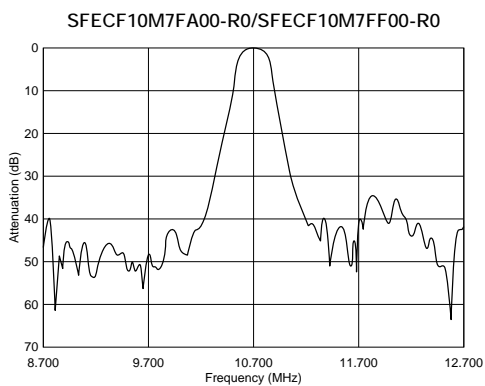
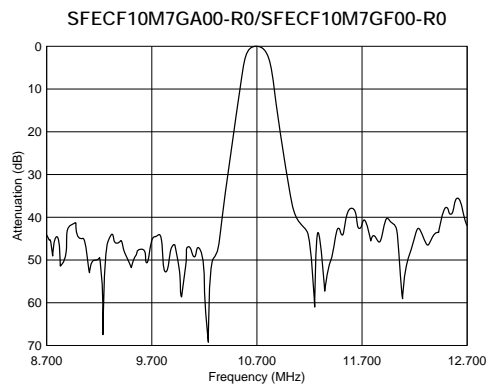
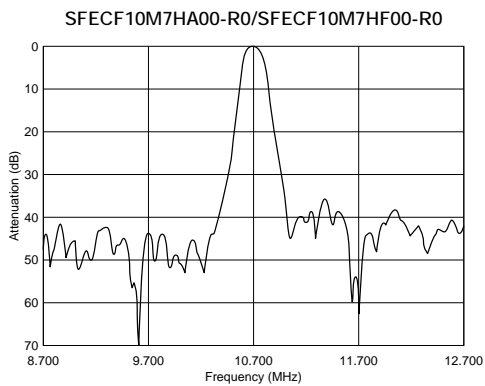

1

Frequency Characteristics (Spurious) High-reliability Type

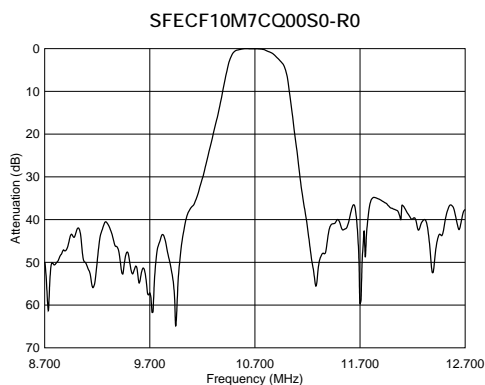
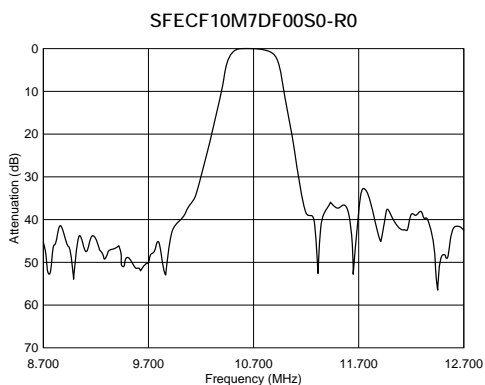
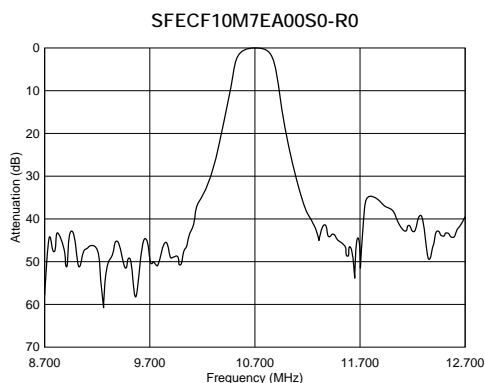
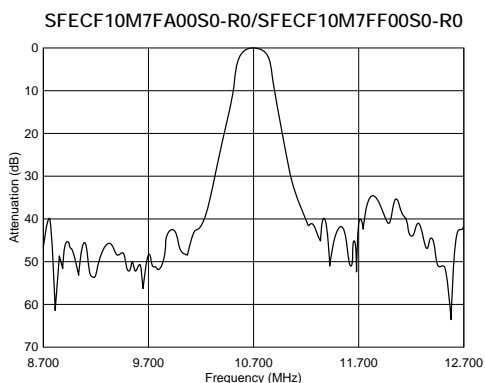
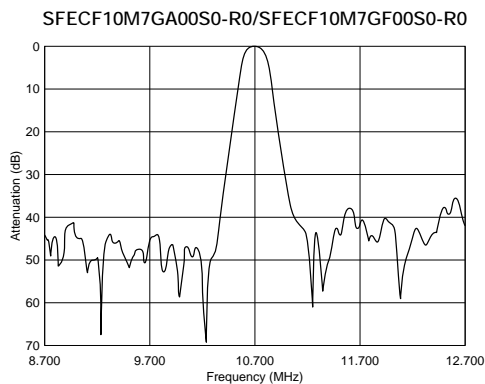
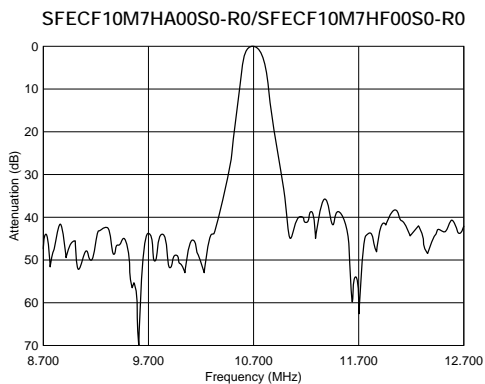

# CERAFIL® (Filters/Traps/Discriminators) for Audio/Visual Equipment



## CERAFIL® 10.7MHz Chip Type SFECV Series

SFECV10M7 series for FM-receivers are monolithic type ceramic filters which utilize the thickness expander mode of the piezoelectric ceramic. SFECV series enable customers to make AM/FM set so thin, and it can be of help to the total chip circuit.

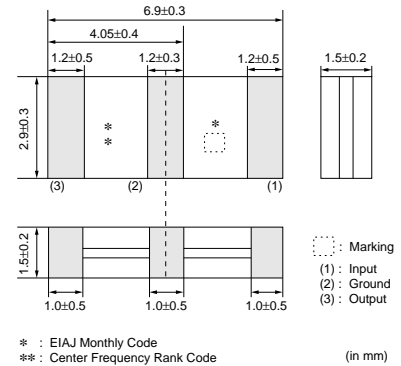

### ■ Features

1. Piezoelectric element is connected in the sandwich shape by heat resistant substrate, thus it has excellent mechanical strength, and it is suitable for automatic mounting.
2. Various bandwidths are available. Select a suitable type in accordance with the desired selectivity.

### ■ Applications

1. Small, thin radios
2. Automotive radios
3. Headphone stereos

Part Number	Center Frequency (fo) (MHz)	Nominal Center Frequency (fn)	3dB Bandwidth (kHz)	Attenuation (kHz)	Insertion Loss (dB)	Ripple (dB)	Spurious Attenuation (1) (dB)	Input/Output Impedance (ohm)	Spurious Attenuation (2) (dB)
SFECV15M0EQ0001-R0	15.000 ±50kHz	-	300 min.	750 max.	7.0 max.	1.0 max.	30 min.	330	30 min.
SFECV10M7KA00-R0	10.700 ±30kHz	-	110 ±30kHz	320 max.	6.0 ±2.0dB	1.0 max.	35 min.	330	-
SFECV10M7JA00-R0	10.700 ±30kHz	-	150 ±40kHz	380 max.	5.5 ±2.0dB	1.0 max.	35 min.	330	-

Area of Attenuation: [within 20dB]

Area of Spurious Attenuation: [within 9MHz to 12MHz], SFECV15M0EQ0001-R0: [within 14MHz to fo/fo to 16MHz]

Area of Insertion Loss: at minimum loss point

Center frequency (fo) defined by the center of 3dB bandwidth.

For safety purposes, connect the output of filters to the IF amplifier through a D.C. blocking capacitor. Avoid applying a direct current to the output of ceramic filters.

The order quantity should be an integral multiple of the "Minimum Quantity" shown in the package page.

### ■ Standard Center Frequency Rank Code

CODE	30kHz Step	25kHz Step
D	10.64MHz±30kHz	10.650MHz±25kHz
B	10.67MHz±30kHz	10.675MHz±25kHz
A	10.70MHz±30kHz	10.700MHz±25kHz
C	10.73MHz±30kHz	10.725MHz±25kHz
E	10.76MHz±30kHz	10.750MHz±25kHz
Z	Combination A, B, C, D, E	
M	Combination A, B, C	

Continued on the following page.

Continued from the preceding page.

### Standard Land Pattern Dimensions

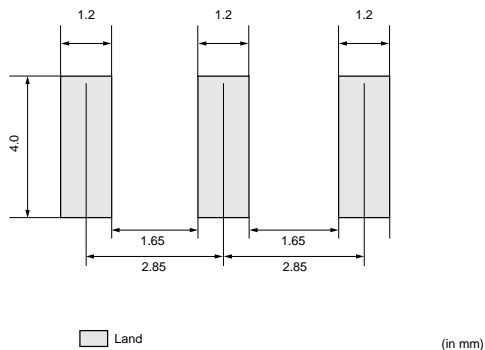

### Test Circuit

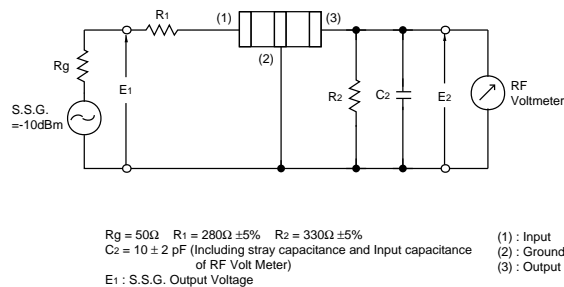

### Frequency Characteristics

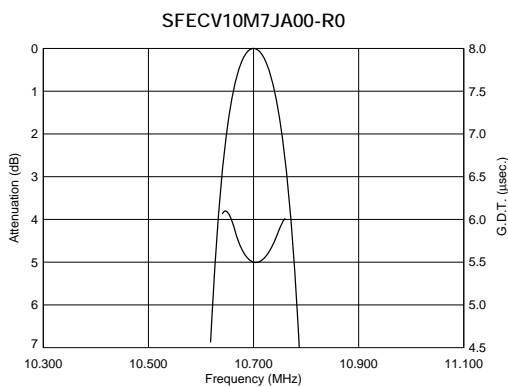
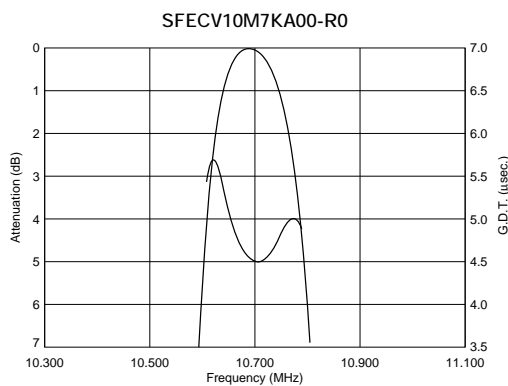
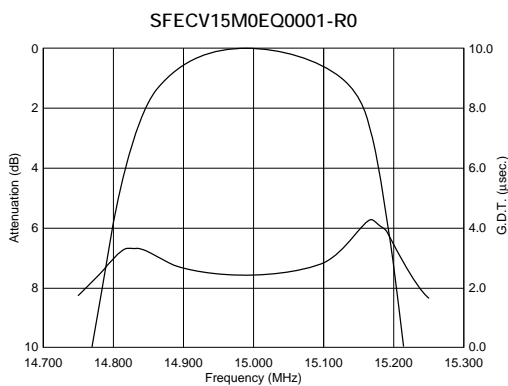



## ■ Frequency Characteristics (Spurious)

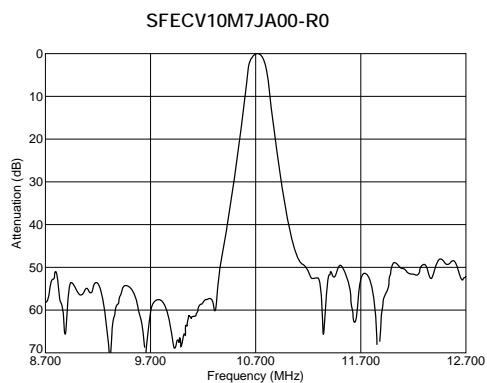
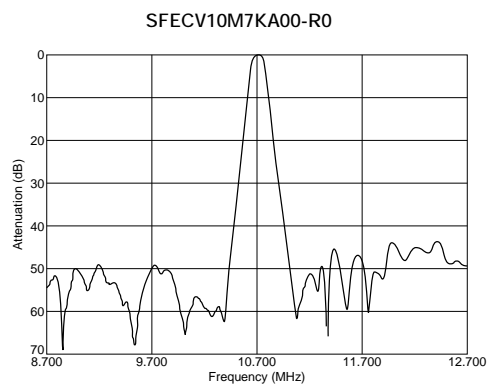
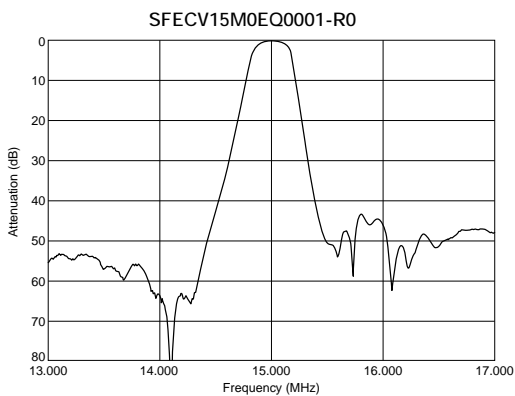

2

# CERAFIL® (Filters/Traps/Discriminators) for Audio/Visual Equipment



3

## CERAFIL® 10.7MHz Standard Lead Type

SFELF10M7 series for FM-receivers are monolithic type ceramic filters which use the thickness expander mode of the piezoelectric ceramic.

As part of the environment protection activity, solder for terminal plating and terminal-element connection inside of ceramic filter contain no lead (Pb).

### ■ Features

1. These miniature filters have high mechanical strength.
2. Low loss, favorable waveform symmetry, and high selectivity
3. Various band widths are available for applications in wide to narrow bands.
4. Small dispersion and stable characteristics
5. Change in center frequency is typically within  $\pm 30\text{ppm}/(\text{degrees C})$  at  $-20$  to  $+80$  (degrees C).
6. High reliability



SFELF10M7HA00-B0

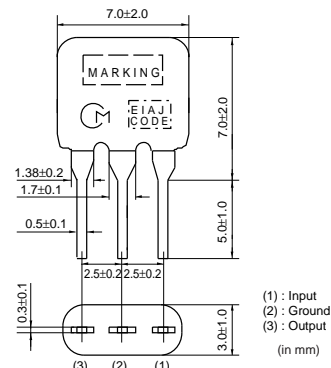

SFELF10M7GA00-B0

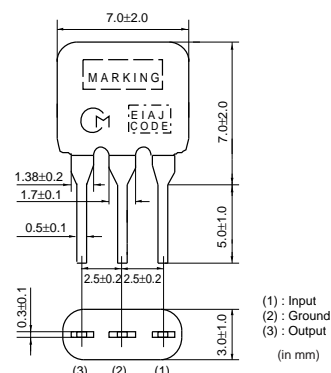

SFELF10M7FA00-B0

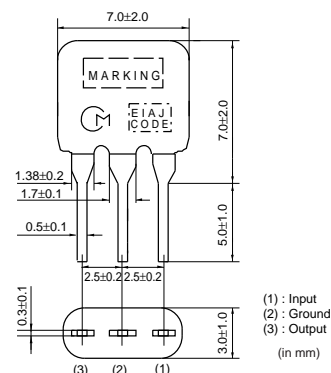

Part Number	Center Frequency (fo) (MHz)	3dB Bandwidth (kHz)	Attenuation (kHz)	Insertion Loss (dB)	Spurious Attenuation (1) (dB)	Input/Output Impedance (ohm)	Spurious Attenuation (2)
SFELF10M7HA00-B0	10.700 ±30kHz	180 ±40kHz	520 max.	7.0 max.	40 min.	330	-
SFELF10M7GA00-B0	10.700 ±30kHz	230 ±50kHz	570 max.	4.0 ±2.0dB	40 min.	330	-
SFELF10M7FA00-B0	10.700 ±30kHz	280 ±50kHz	650 max.	4.0 ±2.0dB	30 min.	330	-

Area of Attenuation: [within 20dB] Area of Spurious Attenuation: [within 9MHz to 12MHz]

Area of Insertion Loss: at minimum loss point

Center frequency (fo) defined by the center of 3dB bandwidth.

For safety purposes, connect the output of filters to the IF amplifier through a D.C. blocking capacitor. Avoid applying a direct current to the output of ceramic filters.

The order quantity should be an integral multiple of the "Minimum Quantity" shown in the package page.

### Standard Center Frequency Rank Code

CODE	30kHz Step	25kHz Step	Color Code
D	10.64MHz±30kHz	10.650MHz±25kHz	Black
B	10.67MHz±30kHz	10.675MHz±25kHz	Blue
A	10.70MHz±30kHz	10.700MHz±25kHz	Red
C	10.73MHz±30kHz	10.725MHz±25kHz	Orange
E	10.76MHz±30kHz	10.750MHz±25kHz	White
Z	Combination A, B, C, D, E		
M	Combination A, B, C		

### Test Circuit

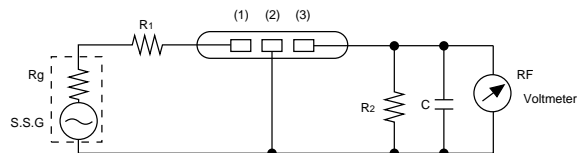

$R_g + R_1 = R_2 =$  Input and Output Impedance  
 $C = 10\text{pF}$  (Including stray capacitance and input capacitance of RF voltmeter.)

(1) : Input  
 (2) : Ground  
 (3) : Output

### Frequency Characteristics

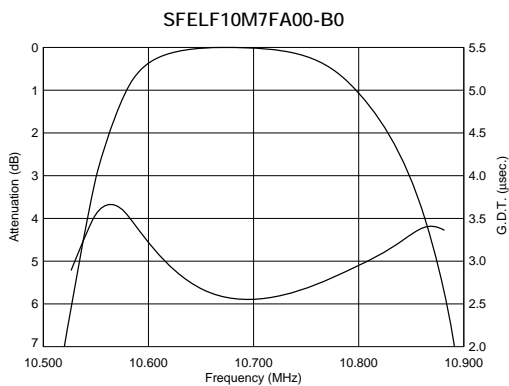
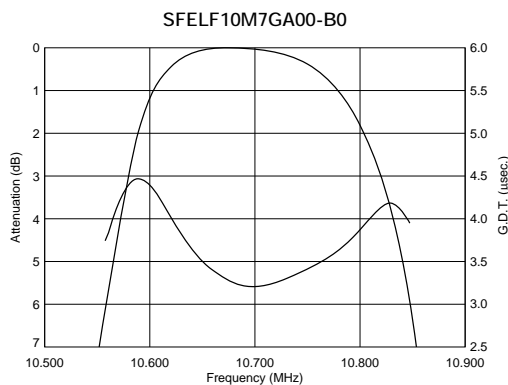
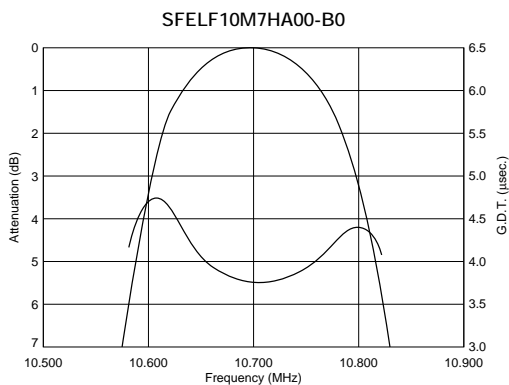

### ■ Frequency Characteristics (Spurious)

3

SFELF10M7HA00-B0

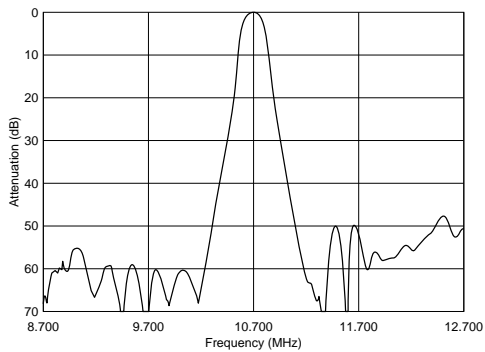

SFELF10M7GA00-B0

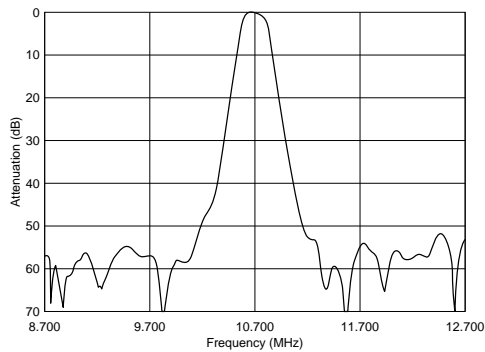

SFELF10M7FA00-B0

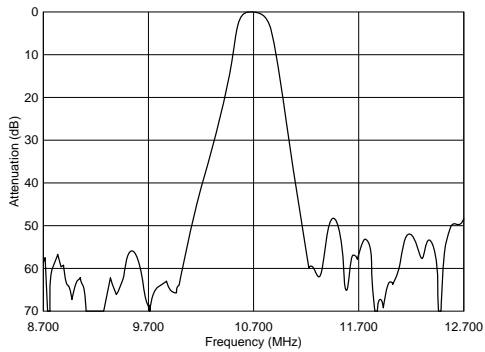

# CERAFIL® (Filters/Traps/Discriminators) for Audio/Visual Equipment



## CERAFIL® 10.7MHz Low Loss Type

SFELF10M7 series for FM-receivers are monolithic type ceramic filters which use the thickness expander mode of the piezoelectric ceramic.

As part of the environment protection activity, solder for terminal plating and terminal-element connection inside of ceramic filter contain no lead (Pb).

### ■ Features

1. Insertion loss is 1 to 1.5dB lower than conventional products. These types are useful for elevating the sensitivity of sets.
2. Small dispersion and stable characteristics
3. Excellent shape factor of frequency response
4. Good waveform symmetry



SFELF10M7JAA0-B0

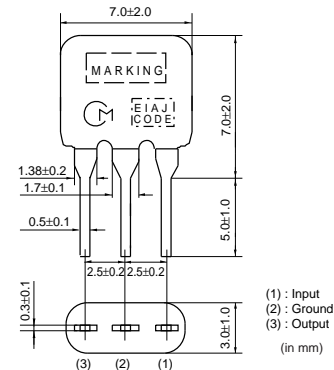

SFELF10M7HAA0-B0

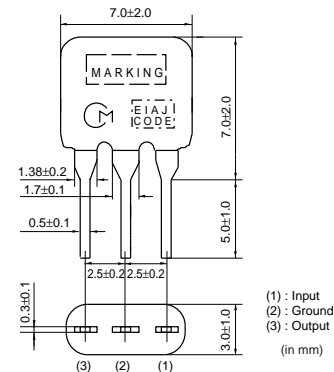

SFELF10M7GAA0-B0

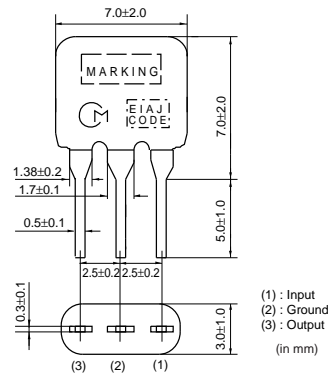

SFELF10M7FAA0-B0

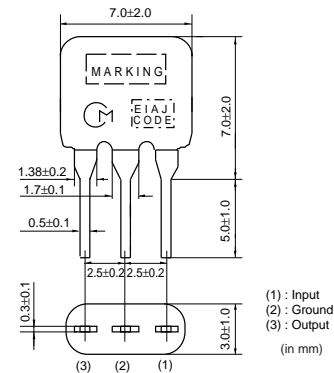

Part Number	Center Frequency (fo) (MHz)	3dB Bandwidth (kHz)	Attenuation (kHz)	Insertion Loss (dB)	Spurious Attenuation (1) (dB)	Input/Output Impedance (ohm)	Spurious Attenuation (2)
SFELF10M7JAA0-B0	10.700 ±30kHz	150 ±40kHz	360 max.	4.5 ±2.0dB	35 min.	330	-
SFELF10M7HAA0-B0	10.700 ±30kHz	180 ±40kHz	470 max.	3.5 ±1.5dB	35 min.	330	-
SFELF10M7GAA0-B0	10.700 ±30kHz	230 ±50kHz	520 max.	3.0 ±2.0dB	35 min.	330	-
SFELF10M7FAA0-B0	10.700 ±30kHz	280 ±50kHz	590 max.	2.5 ±2.0dB	30 min.	330	-

Area of Attenuation: [within 20dB] Area of Spurious Attenuation: [within 9MHz to 12MHz]

Area of Insertion Loss: at minimum loss point

Center frequency (fo) defined by the center of 3dB bandwidth.

For safety purposes, connect the output of filters to the IF amplifier through a D.C. blocking capacitor. Avoid applying a direct current to the output of ceramic filters.

The order quantity should be an integral multiple of the "Minimum Quantity" shown in the package page.

4

### Standard Center Frequency Rank Code

CODE	30kHz Step	25kHz Step	Color Code
D	10.64MHz±30kHz	10.650MHz±25kHz	Black
B	10.67MHz±30kHz	10.675MHz±25kHz	Blue
A	10.70MHz±30kHz	10.700MHz±25kHz	Red
C	10.73MHz±30kHz	10.725MHz±25kHz	Orange
E	10.76MHz±30kHz	10.750MHz±25kHz	White
Z	Combination A, B, C, D, E		
M	Combination A, B, C		

### Test Circuit

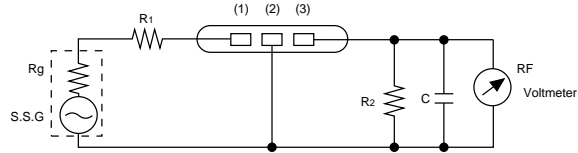

$R_g + R_1 = R_z =$  Input and Output Impedance  
 $C = 10\text{pF}$  (Including stray capacitance and input capacitance of RF voltmeter.)

(1) : Input  
 (2) : Ground  
 (3) : Output

### Frequency Characteristics

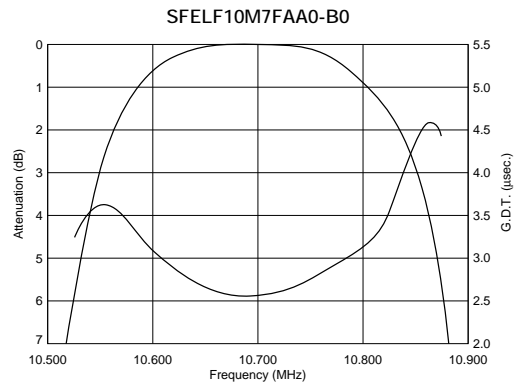
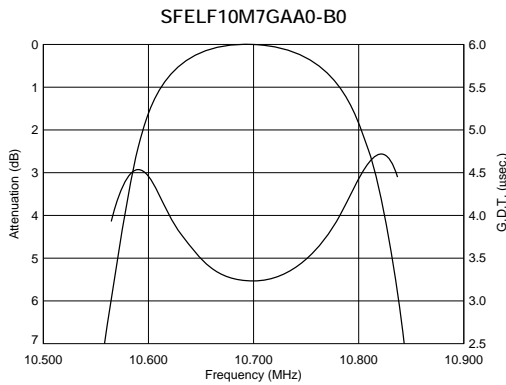
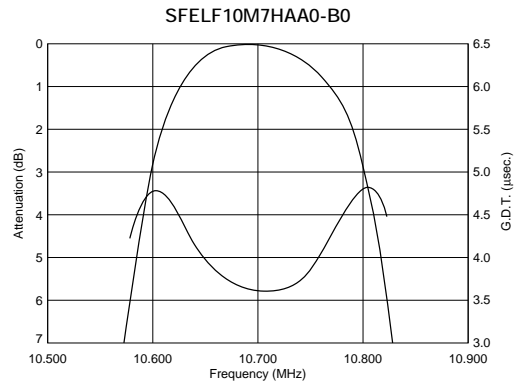
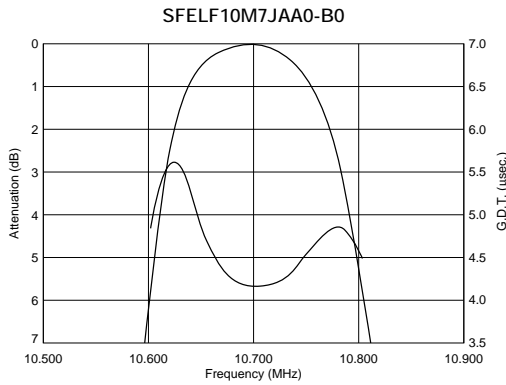

## ■ Frequency Characteristics (Spurious)

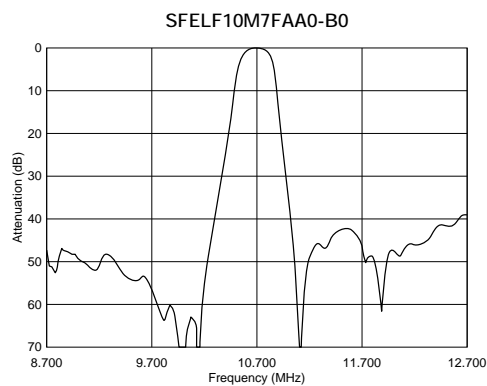
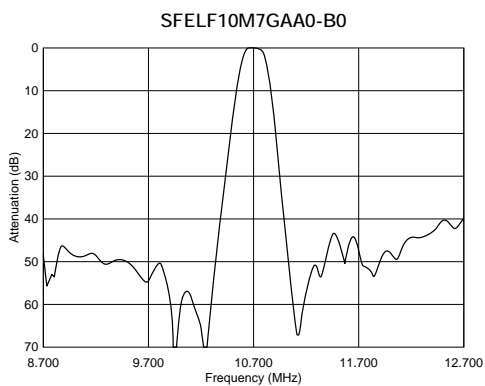
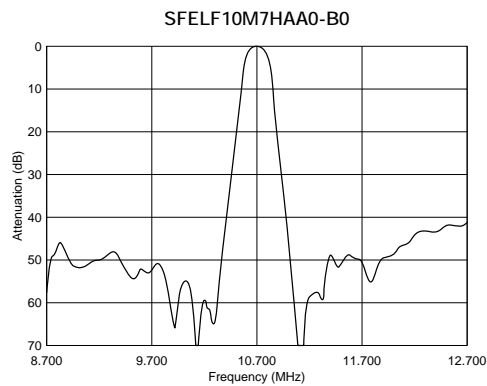
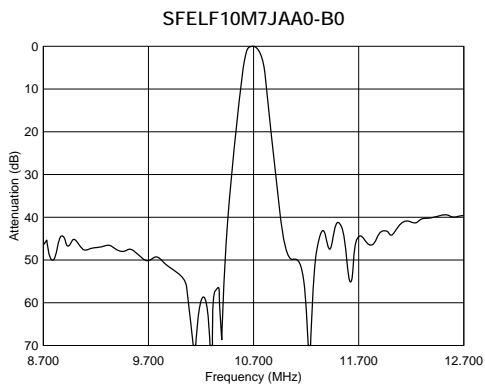

4

# CERAFIL® (Filters/Traps/Discriminators) for Audio/Visual Equipment



## CERAFIL® 10.7MHz Low Profile Type

5

SFELG10M7 series for FM-receivers are monolithic type ceramic filters which use the thickness expander mode of the piezoelectric ceramic.

As part of the environment protection activity, solder for terminal plating and terminal-element connection inside of ceramic filter contain no lead (Pb).

### ■ Features

1. Installed height is 6.0mm, making it well suited for compact, thin sets.
2. Environmental reliability is the same as those of the ceramic filter SFELF10M7 series.



SFELG10M7KA00-B0

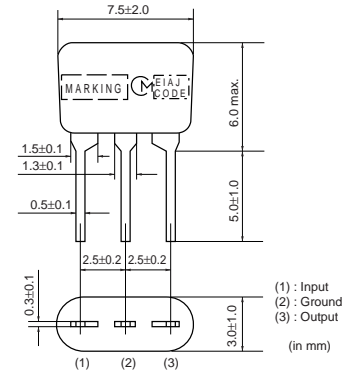

SFELG10M7JA00-B0

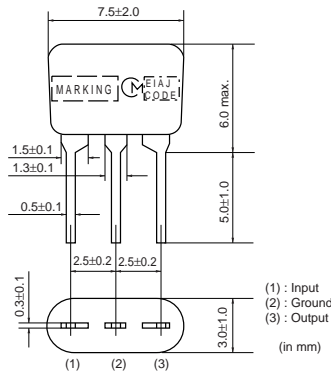

SFELG10M7HA00-B0

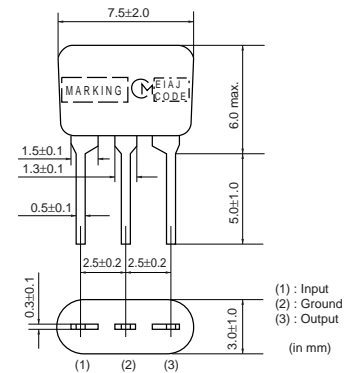

SFELG10M7GA00-B0

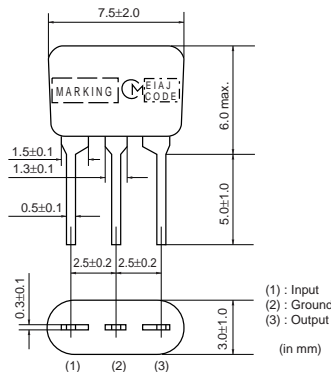

SFELG10M7FA00-B0

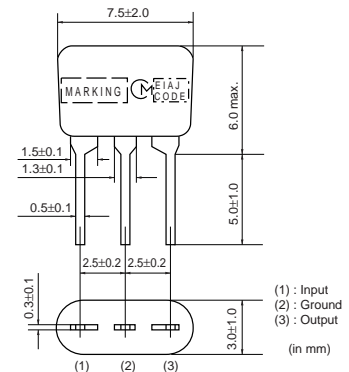

Part Number	Center Frequency (fo) (MHz)	3dB Bandwidth (kHz)	Attenuation (kHz)	Insertion Loss (dB)	Spurious Attenuation (1) (dB)	Input/Output Impedance (ohm)	Spurious Attenuation (2)
SFELG10M7KA00-B0	10.700 ±30kHz	110 ±30kHz	350 max.	7.0 ±2.0dB	30 min.	330	-
SFELG10M7JA00-B0	10.700 ±30kHz	150 ±40kHz	360 max.	4.5 ±2.0dB	35 min.	330	-
SFELG10M7HA00-B0	10.700 ±30kHz	180 ±40kHz	470 max.	3.5 ±2.0dB	35 min.	330	-
SFELG10M7GA00-B0	10.700 ±30kHz	230 ±50kHz	570 max.	3.0 ±2.0dB	40 min.	330	-

Continued on the following page.



Part Number	Center Frequency (fo) (MHz)	3dB Bandwidth (kHz)	Attenuation (kHz)	Insertion Loss (dB)	Spurious Attenuation (1) (dB)	Input/Output Impedance (ohm)	Spurious Attenuation (2)
<b>SFELG10M7FA00-B0</b>	10.700 ±30kHz	280 ±50kHz	650 max.	3.0 ±2.0dB	30 min.	330	-

Area of Attenuation: [within 20dB] Area of Spurious Attenuation: [within 9MHz to 12MHz]

Area of Insertion Loss: at minimum loss point

Center frequency (fo) defined by the center of 3dB bandwidth.

For safety purposes, connect the output of filters to the IF amplifier through a D.C. blocking capacitor. Avoid applying a direct current to the output of ceramic filters.

The order quantity should be an integral multiple of the "Minimum Quantity" shown in the package page.

### Standard Center Frequency Rank Code

CODE	30kHz Step	25kHz Step	Color Code
<b>D</b>	10.64MHz±30kHz	10.650MHz±25kHz	Black
<b>B</b>	10.67MHz±30kHz	10.675MHz±25kHz	Blue
<b>A</b>	10.70MHz±30kHz	10.700MHz±25kHz	Red
<b>C</b>	10.73MHz±30kHz	10.725MHz±25kHz	Orange
<b>E</b>	10.76MHz±30kHz	10.750MHz±25kHz	White
<b>Z</b>	Combination A, B, C, D, E		
<b>M</b>	Combination A, B, C		

### Test Circuit

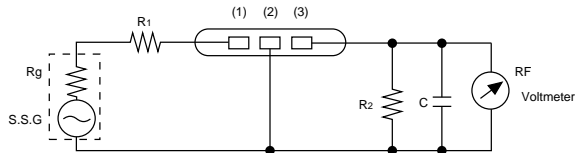

Rg + R1 = Rz = Input and Output Impedance  
 C = 10pF (Including stray capacitance and input capacitance of RF voltmeter.)

(1) : Input  
 (2) : Ground  
 (3) : Output

### Frequency Characteristics

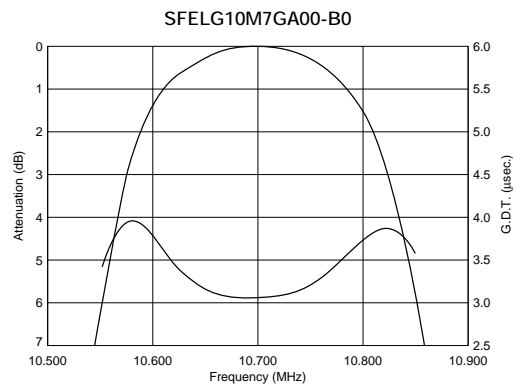
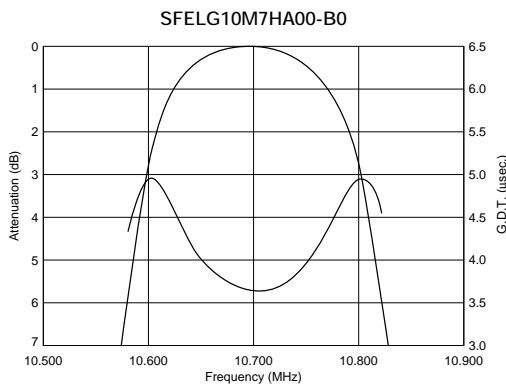
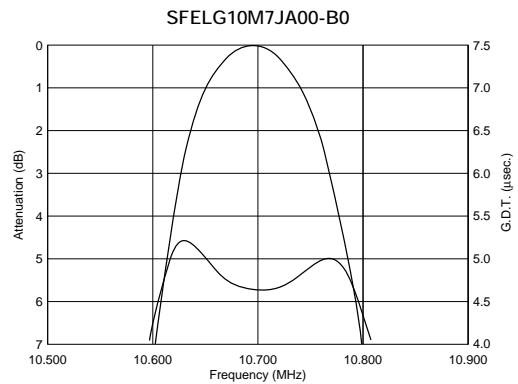
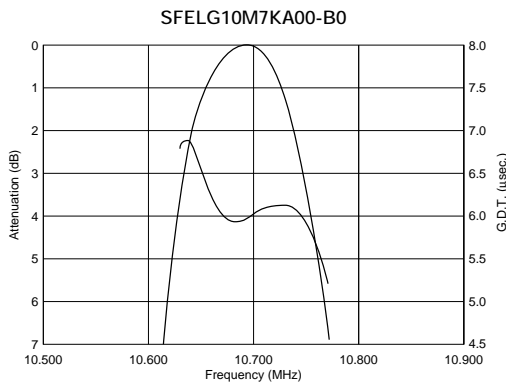

Continued on the following page. ↗

Continued from the preceding page.

## Frequency Characteristics

SFELG10M7FA00-B0

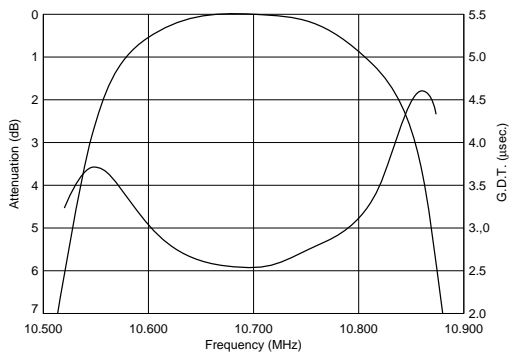

5

## Frequency Characteristics (Spurious)

SFELG10M7KA00-B0

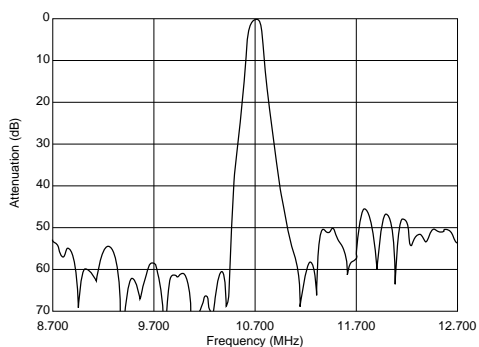

SFELG10M7JA00-B0

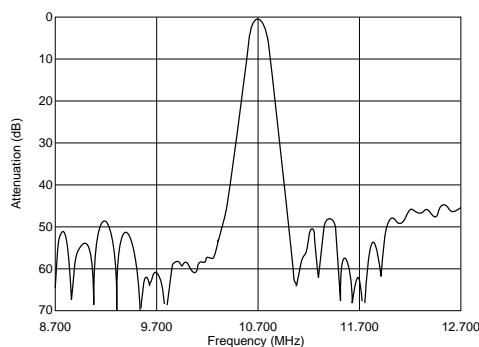

SFELG10M7HA00-B0

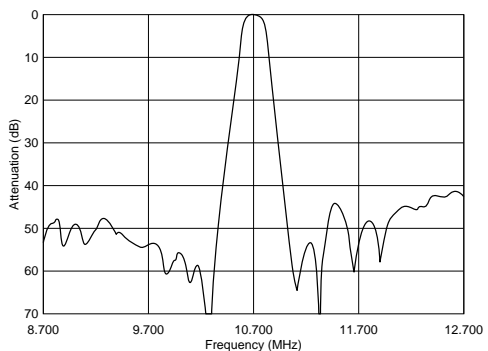

SFELG10M7GA00-B0

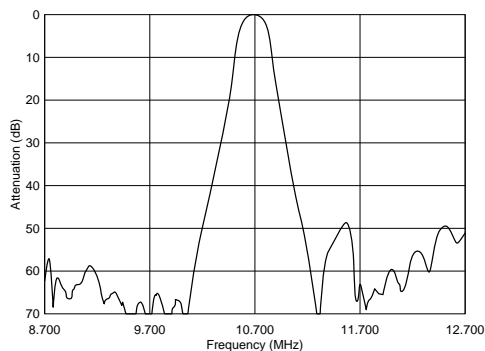

SFELG10M7FA00-B0

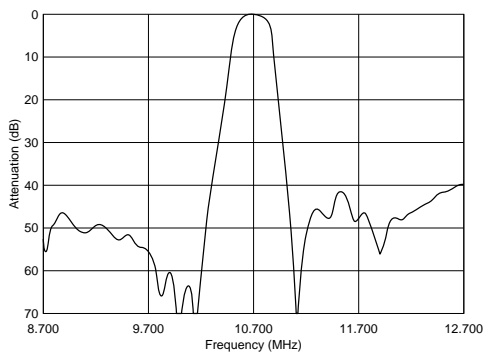

# CERAFIL® (Filters/Traps/Discriminators) for Audio/Visual Equipment



## CERAFIL® 10.7MHz Low Spurious Response Type

SFELF10M7 series for FM-receivers are monolithic type ceramic filters which use the thickness expander mode of the piezoelectric ceramic.

As part of the environment protection activity, solder for terminal plating and terminal-element connection inside of ceramic filter contain no lead (Pb).

### ■ Features

These types have lower spurious response compared to the standard filters.

6



SFELF10M7KAB0-B0

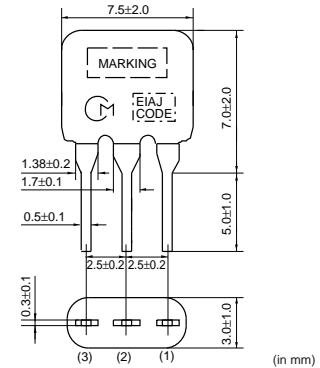

SFELF10M7JAB0-B0

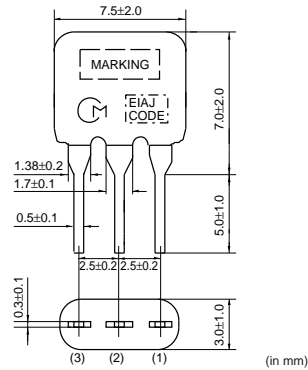

SFELF10M7HAB0-B0

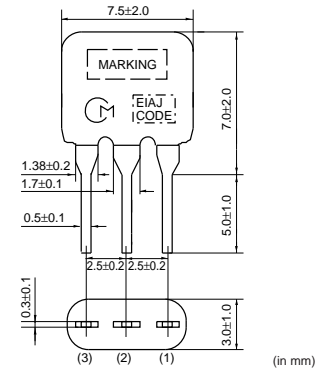

SFELF10M7GAB0-B0

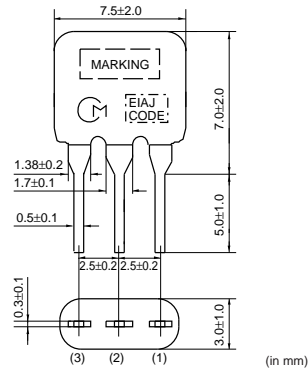

SFELF10M7FAB0-B0

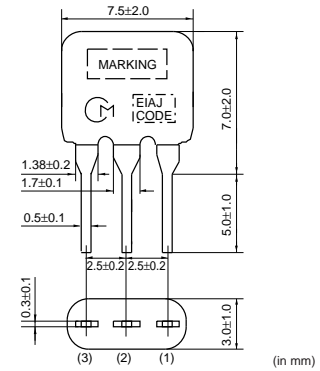

Part Number	Center Frequency (fo) (MHz)	3dB Bandwidth (kHz)	Attenuation (kHz)	Insertion Loss (dB)	Spurious Attenuation (1) (dB)	Input/Output Impedance (ohm)	Spurious Attenuation (2)
SFELF10M7KAB0-B0	10.700 ±30kHz	110 ±30kHz	350 max.	7.0 ±2.0dB	45/30 min.	330	-
SFELF10M7JAB0-B0	10.700 ±30kHz	150 ±40kHz	380 max.	5.5 ±2.0dB	45 min.	330	-
SFELF10M7HAB0-B0	10.700 ±30kHz	180 ±40kHz	520 max.	5.0 ±2.0dB	45 min.	330	-
SFELF10M7GAB0-B0	10.700 ±30kHz	230 ±50kHz	570 max.	3.0 ±2.0dB	45 min.	330	-

Continued on the following page. ↗

Continued from the preceding page.

Part Number	Center Frequency (fo) (MHz)	3dB Bandwidth (kHz)	Attenuation (kHz)	Insertion Loss (dB)	Spurious Attenuation (1) (dB)	Input/Output Impedance (ohm)	Spurious Attenuation (2)
SFELF10M7FAB0-B0	10.700 ±30kHz	280 ±50kHz	650 max.	3.0 ±2.0dB	45 min.	330	-

Area of Attenuation: [within 20dB]

Area of Spurious Attenuation: [within 9MHz to 12MHz], SFELF10M7KAB0-B0: [within 9MHz to fo/fo to 12MHz]

Area of Insertion Loss: at minimum loss point

Center frequency (fo) defined by the center of 3dB bandwidth.

For safety purposes, connect the output of filters to the IF amplifier through a D.C. blocking capacitor. Avoid applying a direct current to the output of ceramic filters.

The order quantity should be an integral multiple of the "Minimum Quantity" shown in the package page.

6

### Standard Center Frequency Rank Code

CODE	30kHz Step	25kHz Step	Color Code
D	10.64MHz±30kHz	10.650MHz±25kHz	Black
B	10.67MHz±30kHz	10.675MHz±25kHz	Blue
A	10.70MHz±30kHz	10.700MHz±25kHz	Red
C	10.73MHz±30kHz	10.725MHz±25kHz	Orange
E	10.76MHz±30kHz	10.750MHz±25kHz	White
Z	Combination A, B, C, D, E		
M	Combination A, B, C		

### Test Circuit

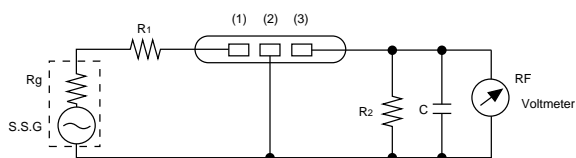

Rg + R1 = Rz = Input and Output Impedance  
C = 10pF (Including stray capacitance and input capacitance of RF voltmeter.)

(1) : Input  
(2) : Ground  
(3) : Output

### Frequency Characteristics

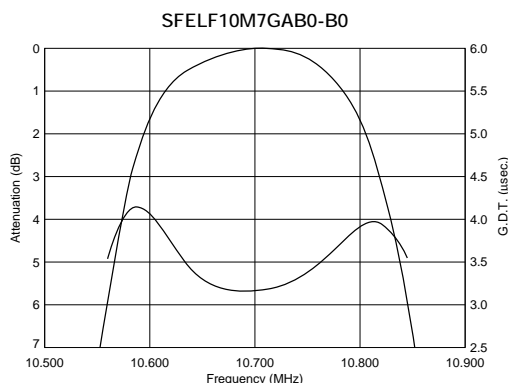
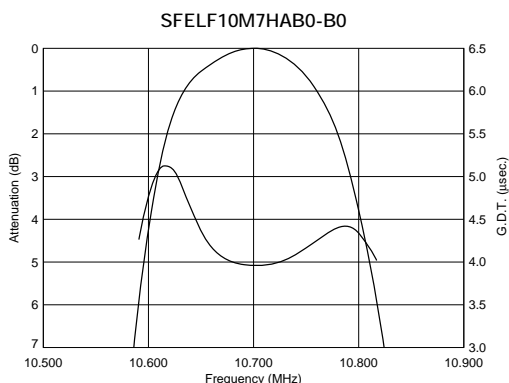
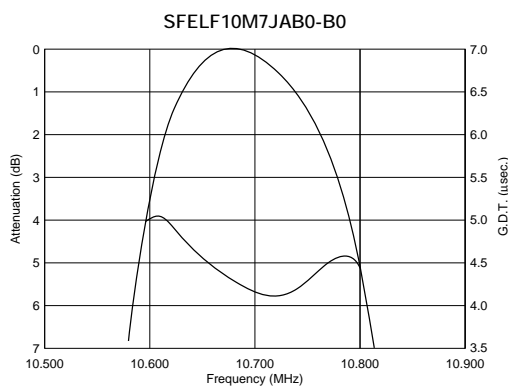
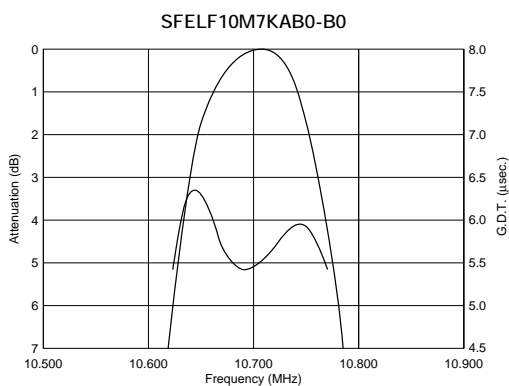

Continued on the following page. ↗

Continued from the preceding page.

### Frequency Characteristics

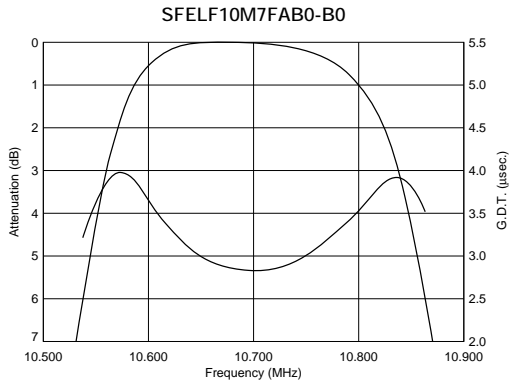

6

### Frequency Characteristics (Spurious)

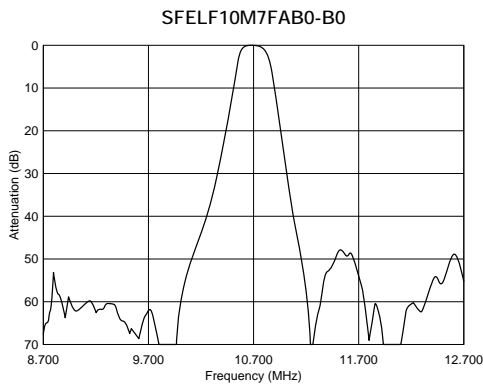
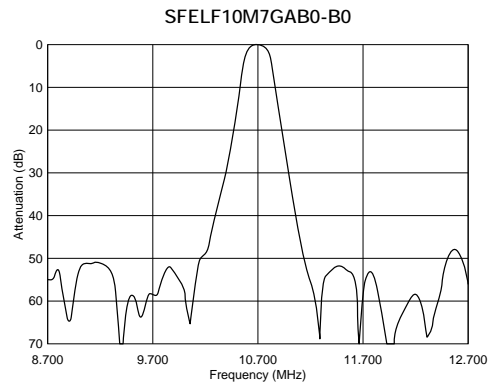
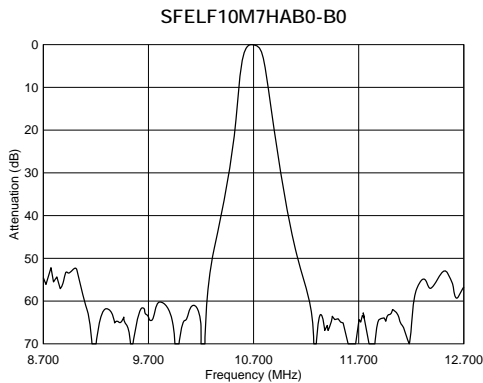
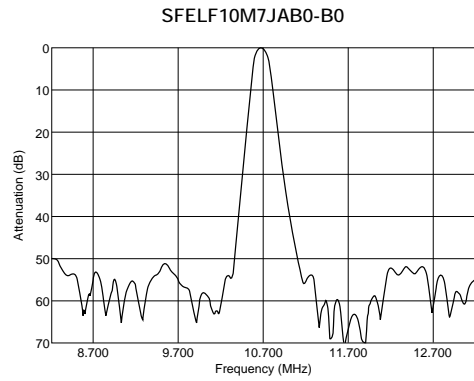
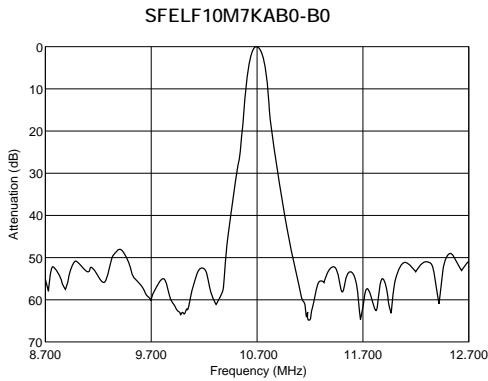

# CERAFIL® (Filters/Traps/Discriminators) for Audio/Visual Equipment



## CERAFIL® 10.7MHz Wide Bandwidth Type

7

SFELF10M7 series for FM-receivers are monolithic type ceramic filters which use the thickness expander mode of the piezoelectric ceramic.

As part of the environment protection activity, solder for terminal plating and terminal-element connection inside of ceramic filter contain no lead (Pb).

### ■ Features

Realizes wider band characteristics not obtained by conventional ceramic filters.



SFELF10M7EA00-B0

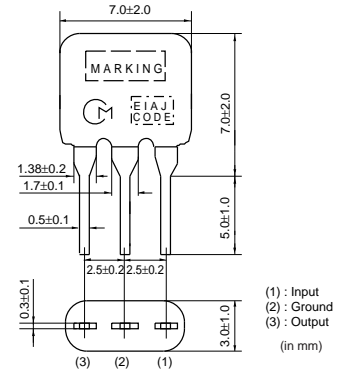

SFELF10M7DF00-B0

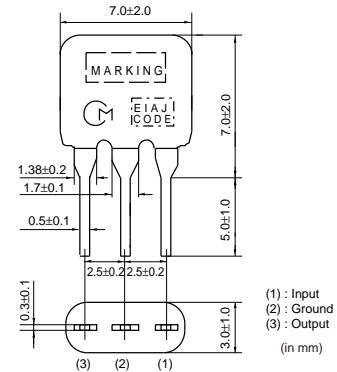

Part Number	Center Frequency (fo) (MHz)	Nominal Center Frequency (fn) (MHz)	3dB Bandwidth (kHz)	Attenuation (kHz)	Insertion Loss (dB)	Spurious Attenuation (1) (dB)	Input/Output Impedance (ohm)	Spurious Attenuation (2)
SFELF10M7EA00-B0	10.700 ±30kHz	-	330 ±50kHz	680 max.	4.0 ±2.0dB	30 min.	330	-
SFELF10M7DF00-B0	-	10.700	fn±175 min.	950 max.	3.0 ±2.0dB	20 min.	470	-

Area of Attenuation: [within 20dB]

Area of Spurious Attenuation: SFELF10M7DF00-B0: [within 5MHz to 15MHz]

Area of Insertion Loss: at minimum loss point

Center frequency (fo) defined by the center of 3dB bandwidth.

For safety purposes, connect the output of filters to the IF amplifier through a D.C. blocking capacitor. Avoid applying a direct current to the output of ceramic filters.

The order quantity should be an integral multiple of the "Minimum Quantity" shown in the package page.

### ■ Standard Center Frequency Rank Code (SFELF10M7EA00-B0)

CODE	30kHz Step	25kHz Step	Color Code
D	10.64MHz±30kHz	10.650MHz±25kHz	Black
B	10.67MHz±30kHz	10.675MHz±25kHz	Blue
A	10.70MHz±30kHz	10.700MHz±25kHz	Red
C	10.73MHz±30kHz	10.725MHz±25kHz	Orange
E	10.76MHz±30kHz	10.750MHz±25kHz	White
Z	Combination A, B, C, D, E		
M	Combination A, B, C		

## Test Circuit

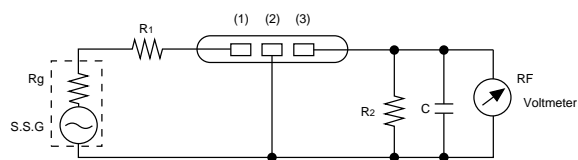

$R_g + R_1 = R_2 =$  Input and Output Impedance  
 $C = 10\text{pF}$  (Including stray capacitance and input capacitance of RF voltmeter.)

(1) : Input  
 (2) : Ground  
 (3) : Output

7

## Frequency Characteristics

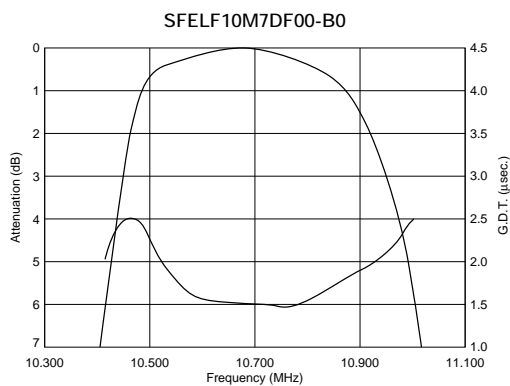
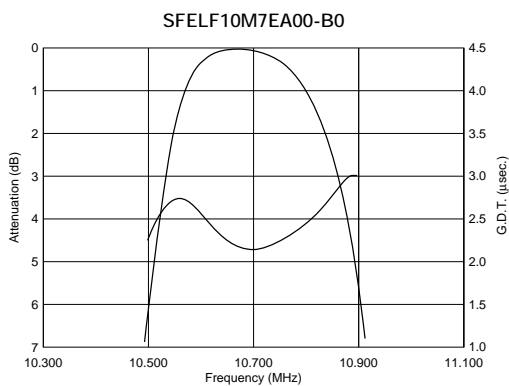

## Frequency Characteristics (Spurious)

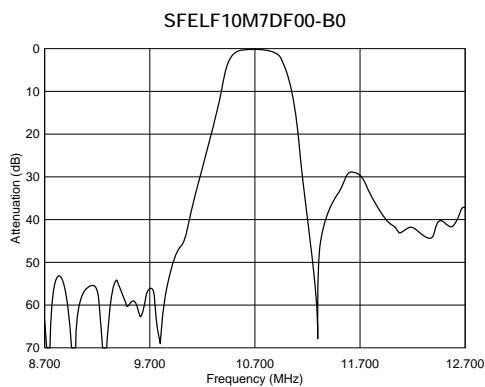
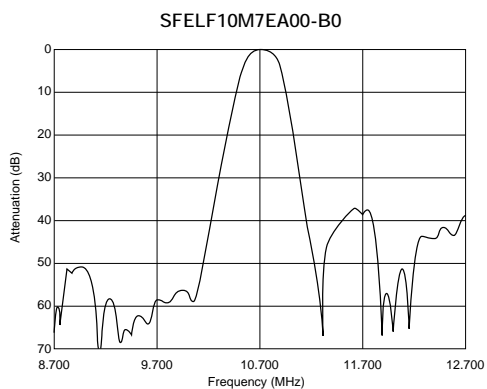

# CERAFIL® (Filters/Traps/Discriminators) for Audio/Visual Equipment



## CERAFIL® 10.7MHz Narrow Bandwidth Type

8

### ■ Features

SFELF10M7LF00/KAH0, SFVLF/SFKLF series realizes narrower band characteristics not obtained by conventional ceramic filters. Besides, low spurious and temperature characteristics is stable. This series is suitable for European car-audio or AM up conversion use that needs narrow band characteristics are stable. As part of the environment protection activity, solder for terminal plating and terminal-element connection inside of ceramic filter contain no lead (Pb).

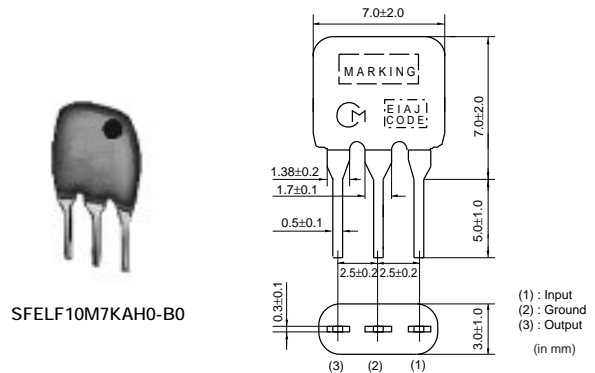
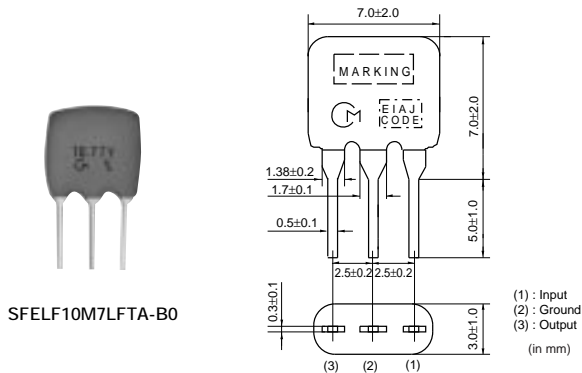
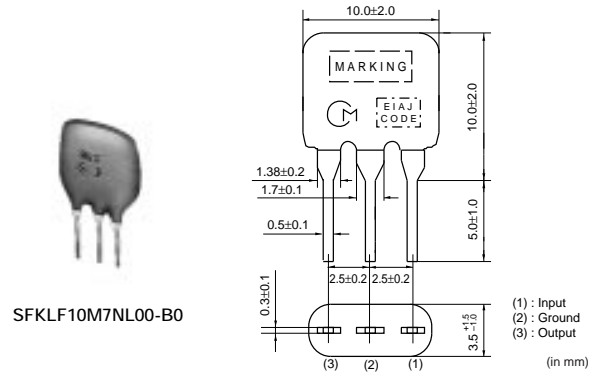
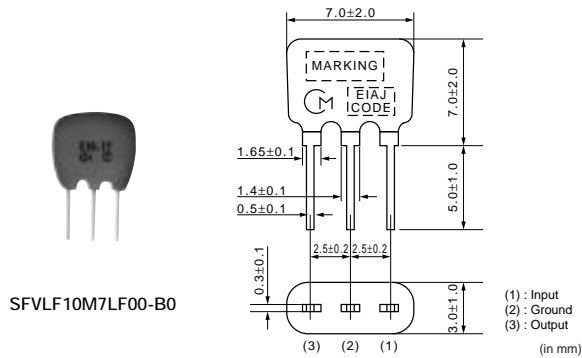
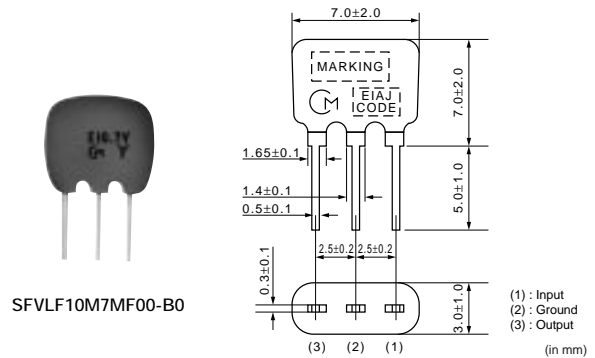

Part Number	Center Frequency (fo) (MHz)	Nominal Center Frequency (fn) (MHz)	3dB Bandwidth (kHz)	Attenuation (kHz)	Insertion Loss (dB)	Spurious Attenuation (1) (dB)	Input/Output Impedance (ohm)	Spurious Attenuation (2)
<b>SFVLF10M7MF00-B0</b>	-	10.700	fn±13 min.	135 max.	5.0 ±2.0dB	35 min.	330	-
<b>SFVLF10M7LF00-B0</b>	-	10.700	fn±25 min.	-	5.5 ±2.5dB	30 min.	330	-
<b>SFKLF10M7NL00-B0</b>	10.700 ±15kHz	-	20 min.	95 max.	6.0 max.	24 min.	600	-
<b>SFELF10M7LFTA-B0</b>	-	10.700	fn±25 min.	280 max.	7.0 ±2.0dB	30 min.	330	-

Continued on the following page. ↗



Continued from the preceding page.

Part Number	Center Frequency (fo) (MHz)	Nominal Center Frequency (fn) (MHz)	3dB Bandwidth (kHz)	Attenuation (kHz)	Insertion Loss (dB)	Spurious Attenuation (1) (dB)	Input/Output Impedance (ohm)	Spurious Attenuation (2)
<b>SFELF10M7KAH0-B0</b>	10.700 ±30kHz	-	110 ±30kHz	350 max.	7.0 ±2.0dB	30 min.	330	-

Area of Attenuation: [within 20dB]

Area of Spurious Attenuation: [within 9MHz to 12MHz], SFKLF10M7NL00-B0: [within fo-1.0MHz to fo+1.0MHz]

Area of Insertion Loss: at minimum loss point

Center frequency (fo) defined by the center of 3dB bandwidth.

For safety purposes, connect the output of filters to the IF amplifier through a D.C. blocking capacitor. Avoid applying a direct current to the output of ceramic filters.

The order quantity should be an integral multiple of the "Minimum Quantity" shown in the package page.

### Standard Center Frequency Rank Code (SFELF10M7KAH0-B0)

CODE	30kHz Step	25kHz Step	Color Code
<b>D</b>	10.64MHz±30kHz	10.650MHz±25kHz	Black
<b>B</b>	10.67MHz±30kHz	10.675MHz±25kHz	Blue
<b>A</b>	10.70MHz±30kHz	10.700MHz±25kHz	Red
<b>C</b>	10.73MHz±30kHz	10.725MHz±25kHz	Orange
<b>E</b>	10.76MHz±30kHz	10.750MHz±25kHz	White
<b>Z</b>	Combination A, B, C, D, E		
<b>M</b>	Combination A, B, C		

### Test Circuit

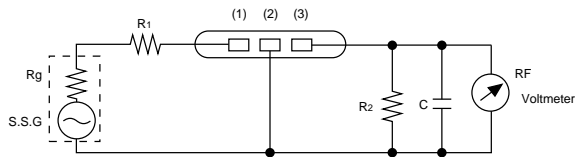

Rg + R1 = Rz = Input and Output Impedance  
 C = 10pF (Including stray capacitance and input capacitance of RF voltmeter.)

(1) : Input  
 (2) : Ground  
 (3) : Output

### Frequency Characteristics

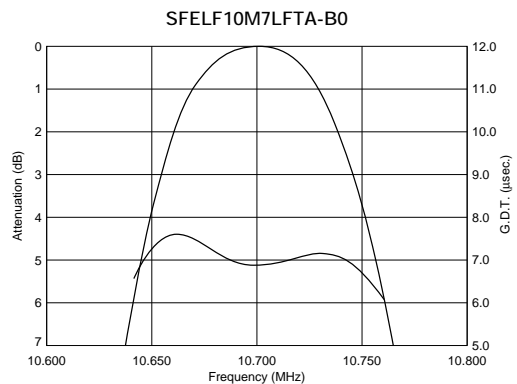
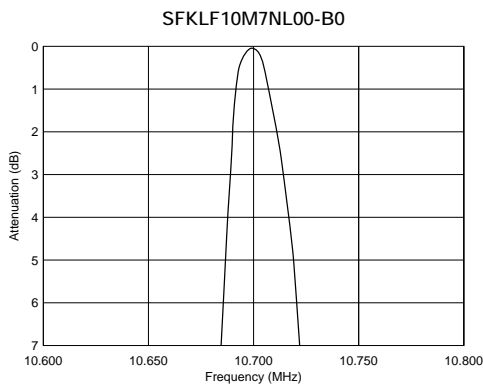
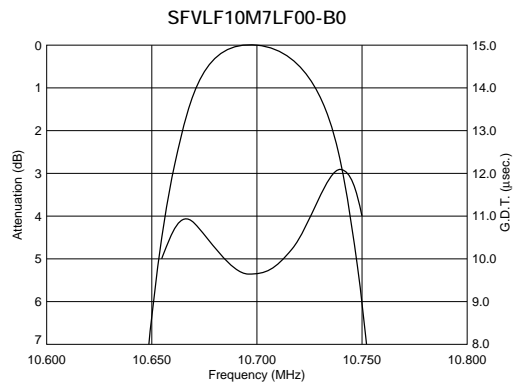
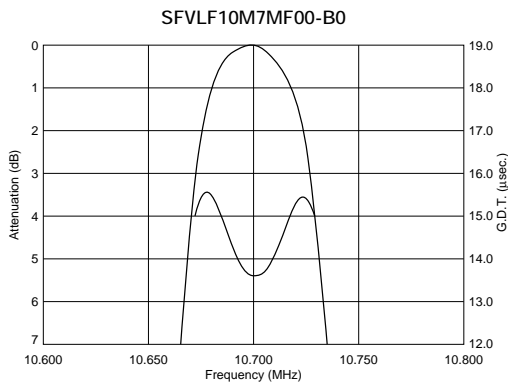

Continued on the following page. ↗

Continued from the preceding page.

## Frequency Characteristics

SFELF10M7KAH0-B0

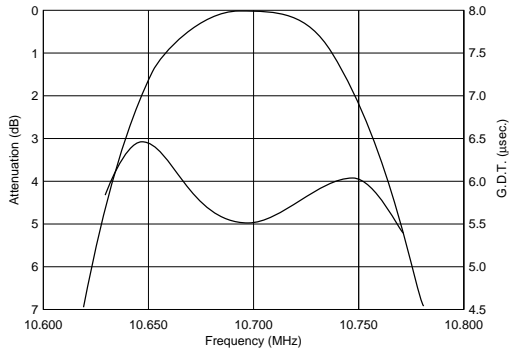

## Frequency Characteristics (Spurious)

SFVLF10M7MF00-B0

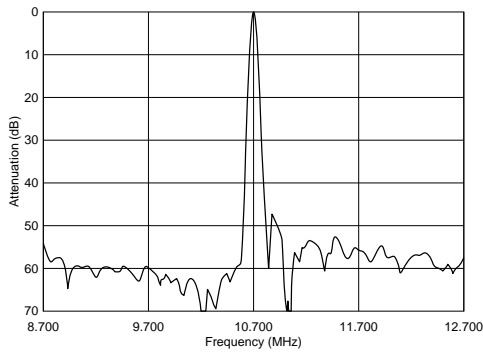

SFVLF10M7LF00-B0

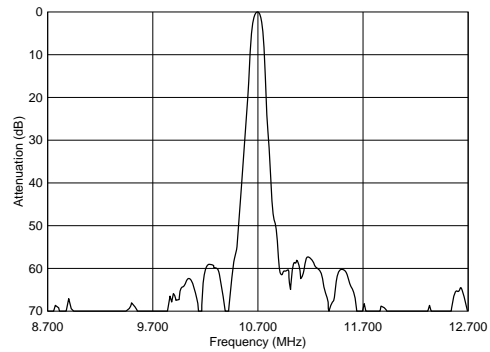

SFKLF10M7NL00-B0

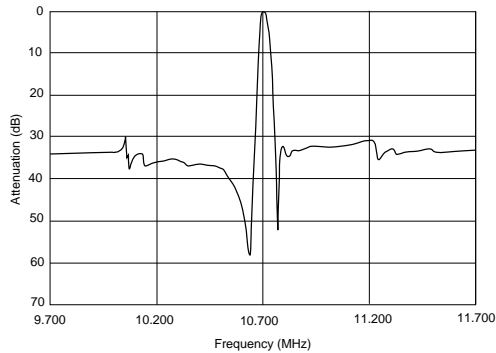

SFELF10M7LFTA-B0

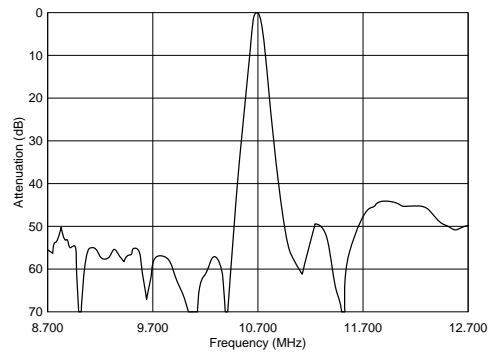

SFELF10M7KAH0-B0

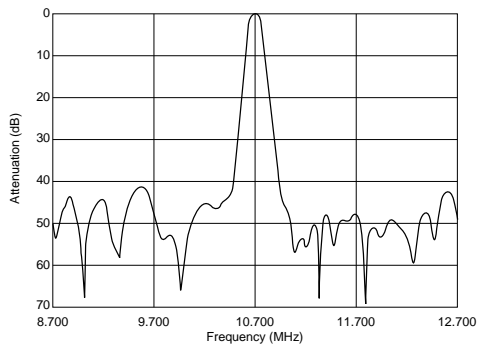

# CERAFIL® (Filters/Traps/Discriminators) for Audio/Visual Equipment



## CERAFIL® 10.7MHz for FM-IF Tuners

SFELF10M7 series for FM-receivers are monolithic type ceramic filters which use the thickness expander mode of the piezoelectric ceramic.

As part of the environment protection activity, solder for terminal plating and terminal-element connection inside of ceramic filter contain no lead (Pb).

### ■ Features

1. Little dispersion of amplitude characteristics and phase characteristics (G. D. T. characteristics)
2. The SFELF\_G series is based on SFELF\_FA00/GA00/HA00, and it obtains high selectivity with low loss. There is little dispersion of amplitude and GDT characteristics, and low distortion rate can be obtained.
3. The flatness of GDT is inspected for all products.



SFELF10M7HA0G-B0

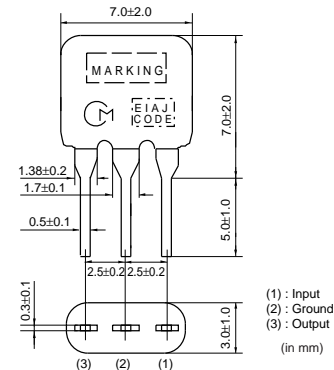

SFELF10M7GA0G-B0

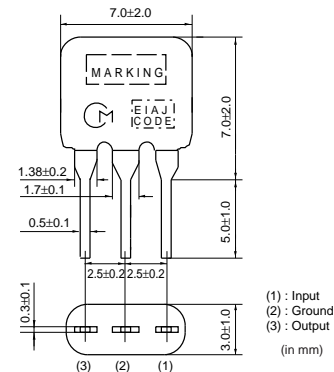

SFELF10M7FA0G-B0

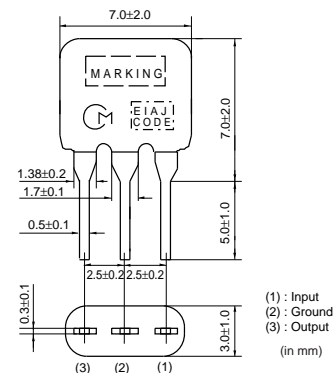

Part Number	Center Frequency (fo) (MHz)	3dB Bandwidth (kHz)	Attenuation (kHz)	Insertion Loss (dB)	Spurious Attenuation (1) (dB)	GDT Bandwidth (kHz)	Input/Output Impedance (ohm)	Spurious Attenuation (2)
SFELF10M7HA0G-B0	10.700 ±30kHz	180 ±40kHz	520 max.	7.0 max.	40 min.	fo±45 min. [within 0.5µsec.]	330	-
SFELF10M7GA0G-B0	10.700 ±30kHz	230 ±50kHz	600 max.	7.0 max.	40 min.	fo±60 min. [within 0.5µsec.]	330	-
SFELF10M7FA0G-B0	10.700 ±30kHz	280 ±50kHz	650 max.	4.0 ±2.0dB	30 min.	fo±85 min. [within 0.5µsec.]	330	-

Area of Attenuation: [within 20dB]

Area of Spurious Attenuation: [within 9MHz to 12MHz]

Area of Insertion Loss: at minimum loss point

Center frequency (fo) defined by the center of 3dB bandwidth.

For safety purposes, connect the output of filters to the IF amplifier through a D.C. blocking capacitor. Avoid applying a direct current to the output of ceramic filters.

The order quantity should be an integral multiple of the "Minimum Quantity" shown in the package page.

### Standard Center Frequency Rank Code

CODE	30kHz Step	25kHz Step	Color Code
D	10.64MHz±30kHz	10.650MHz±25kHz	Black
B	10.67MHz±30kHz	10.675MHz±25kHz	Blue
A	10.70MHz±30kHz	10.700MHz±25kHz	Red
C	10.73MHz±30kHz	10.725MHz±25kHz	Orange
E	10.76MHz±30kHz	10.750MHz±25kHz	White
Z	Combination A, B, C, D, E		
M	Combination A, B, C		

### Test Circuit

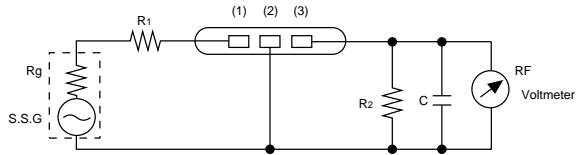

$R_g + R_1 = R_z =$  Input and Output Impedance  
 $C = 10\text{pF}$  (Including stray capacitance and input capacitance of RF voltmeter.)

(1) : Input  
 (2) : Ground  
 (3) : Output

### Frequency Characteristics

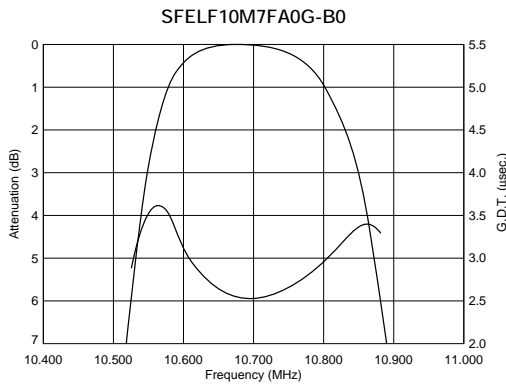
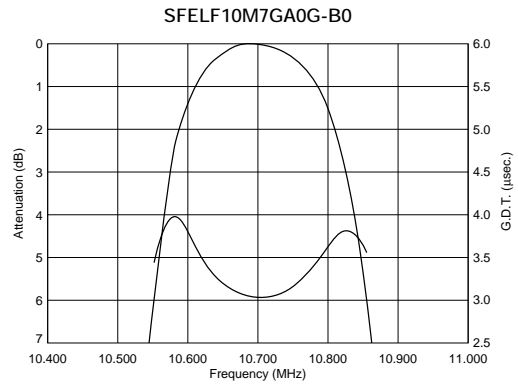
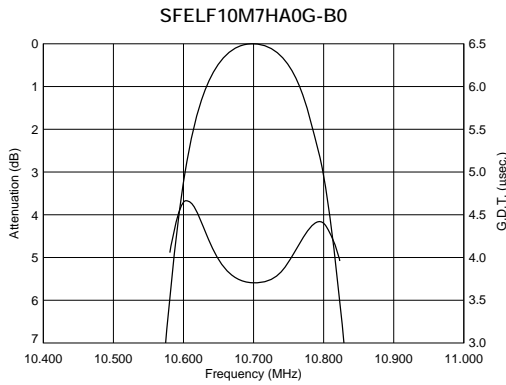

## ■ Frequency Characteristics (Spurious)

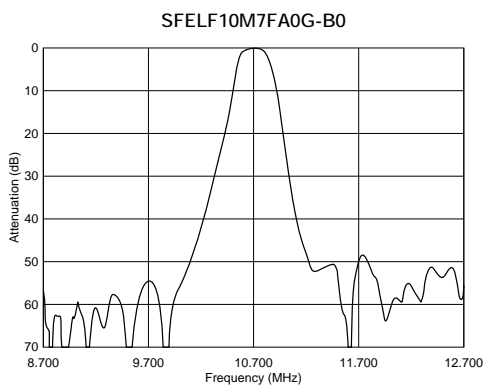
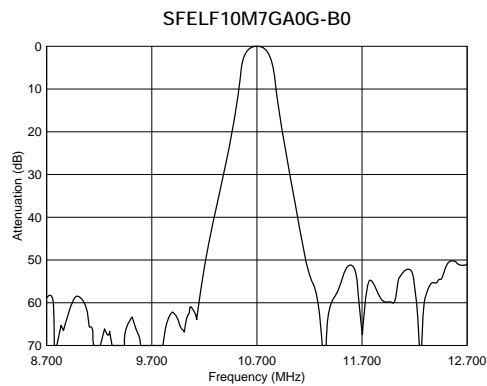
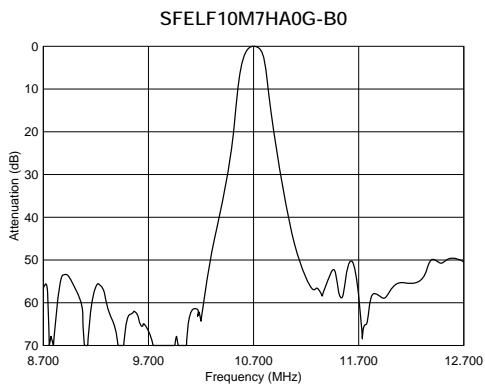

# CERAFIL® 10.7MHz Related Data on Lead Type

## Temperature Characteristics

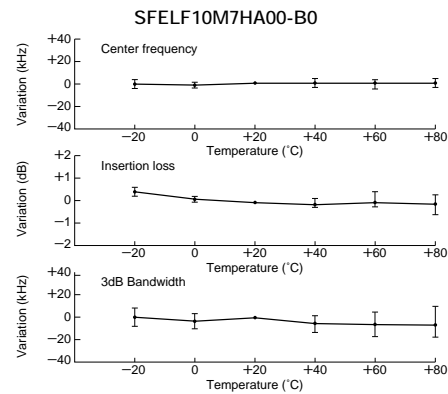
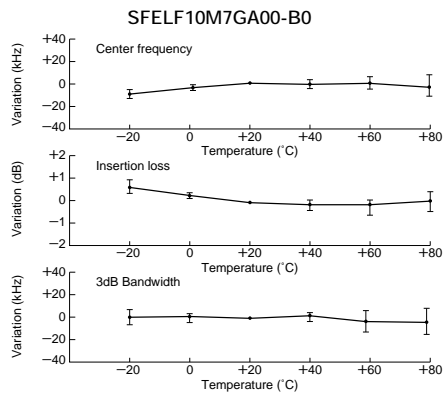

## Matching Conditions

- When using ceramic filters, it is most important to match the input/output load to impedance 330 ohm (SFELF10M7DF00-B0 is 470 ohm and SFKLF10M7NL00-B0 is 600 ohm matching). Waveform symmetry is damaged when reactance is added to the input/output load.
- Two ceramic filters directly connected can be used for high selectivity. For reducing waveform variation, it is recommended to input a buffer AMP between ceramic filters.

- The SFELF10M7 series are of input/output symmetric structure so that in theory there is no input/output directionality. Actual circuits may use different input/output loading conditions (for example, mismatched impedance) or capacitance load. In such cases, the waveform will be a little changed by the direction of the input/output of the ceramic filters.

## Loaded Resistance and Waveform ( $R_g+R_1=330\text{ ohm}$ )

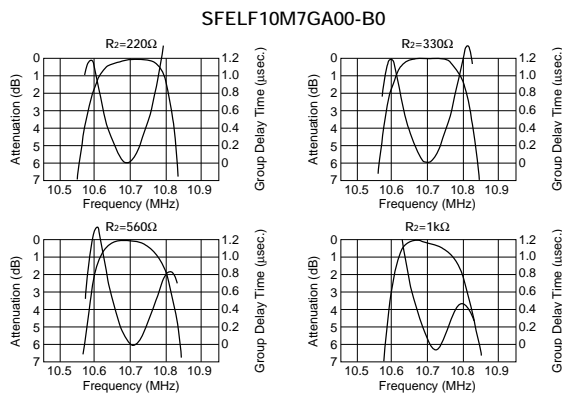

## Loaded Capacitance and Waveform ( $R_g+R_1=R_2=330\text{ ohm}$ )

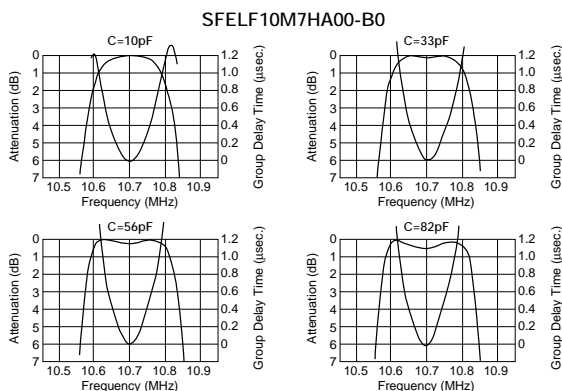

# CERAFIL® (Filters/Traps/Discriminators) for Audio/Visual Equipment



## CERAFIL® 4.5-6.5MHz Chip Type SFSKA Series

SMD ceramic filter SFSKA\_CF is a small and thin SMD filter sealed with a metal cap.  
 Recommended for LCD-TV's, and small and thin tuners.

### ■ Features

1. High attenuation outside bandwidth
2. Small and thin package
3. Reflow-solderable

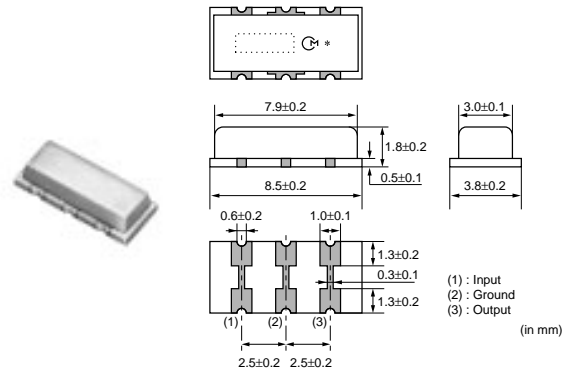

10

Part Number	Nominal Center Frequency (fn) (MHz)	3dB Bandwidth (kHz)	20dB Bandwidth (kHz)	Insertion Loss (dB)	Spurious Attenuation(1) (dB)	Spurious Attenuation(2) (dB)	Input/Output Impedance (ohm)
SFSKA4M50CF00-R1	4.500	fn±60 min.	600 max.	6.0 max.	20 min. [within 0 to fn]	15 min. [within fn to 7.0MHz]	1000
SFSKA4M50CF00-R3	4.500	fn±60 min.	600 max.	6.0 max.	20 min. [within 0 to fn]	15 min. [within fn to 7.0MHz]	1000
SFSKA5M50CF00-R1	5.500	fn±60 min.	600 max.	6.0 max.	25 min. [within 0 to fn]	15 min. [within fn to 7.0MHz]	600
SFSKA5M50CF00-R3	5.500	fn±60 min.	600 max.	6.0 max.	25 min. [within 0 to fn]	15 min. [within fn to 7.0MHz]	600
SFSKA6M00CF00-R1	6.000	fn±60 min.	600 max.	6.0 max.	25 min. [within 0 to fn]	15 min. [within fn to 7.5MHz]	470
SFSKA6M00CF00-R3	6.000	fn±60 min.	600 max.	6.0 max.	25 min. [within 0 to fn]	15 min. [within fn to 7.5MHz]	470
SFSKA6M50CF00-R1	6.500	fn±60 min.	600 max.	6.0 max.	25 min. [within 0 to fn]	15 min. [within fn to 8.5MHz]	470
SFSKA6M50CF00-R3	6.500	fn±60 min.	600 max.	6.0 max.	25 min. [within 0 to fn]	15 min. [within fn to 8.5MHz]	470

Area of Insertion Loss: at minimum loss point

For safety purposes, connect the output of filters to the IF amplifier through a D.C. blocking capacitor. Avoid applying a direct current to the output of ceramic filters.  
 The order quantity should be an integral multiple of the "Minimum Quantity" shown in the package page.

### ■ Standard Land Pattern Dimensions

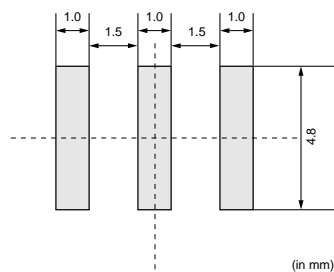

### ■ Test Circuit

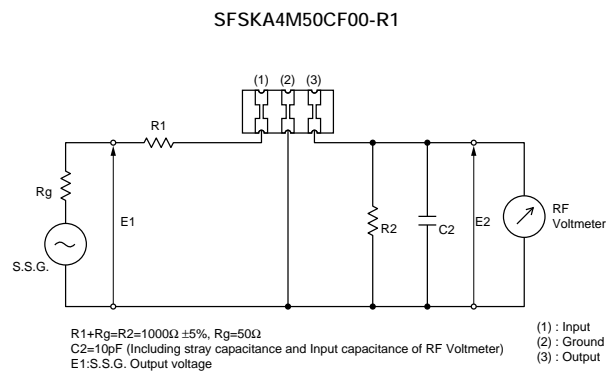

Continued on the following page. ↗

Continued from the preceding page.

Test Circuit

SFSKA5M50CF00-R1

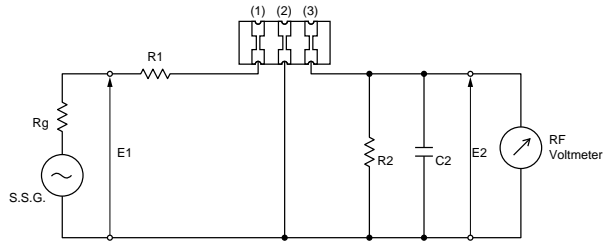

$R1+Rg=R2=600\Omega \pm 5\%$ ,  $Rg=50\Omega$   
 $C2=10pF$  (Including stray capacitance and Input capacitance of RF Voltmeter)  
 E1: S.S.G. Output voltage  
 (1) : Input  
 (2) : Ground  
 (3) : Output

SFSKA6M00CF00-R1

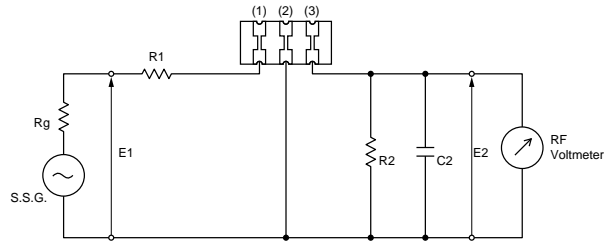

$R1+Rg=R2=470\Omega \pm 5\%$ ,  $Rg=50\Omega$   
 $C2=10pF$  (Including stray capacitance and Input capacitance of RF Voltmeter)  
 E1: S.S.G. Output voltage  
 (1) : Input  
 (2) : Ground  
 (3) : Output

SFSKA6M50CF00-R1

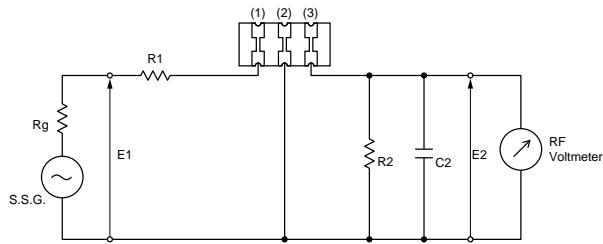

$R1+Rg=R2=470\Omega \pm 5\%$ ,  $Rg=50\Omega$   
 $C2=10pF$  (Including stray capacitance and Input capacitance of RF Voltmeter)  
 E1: S.S.G. Output voltage  
 (1) : Input  
 (2) : Ground  
 (3) : Output

Frequency Characteristics

SFSKA4M50CF00-R1

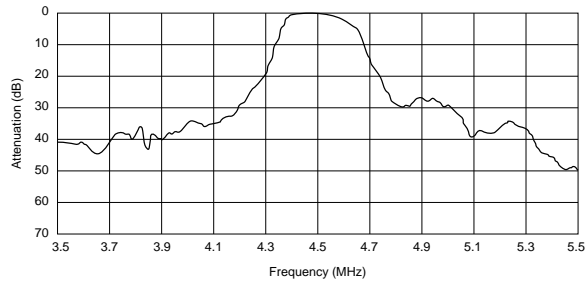

SFSKA5M50CF00-R1

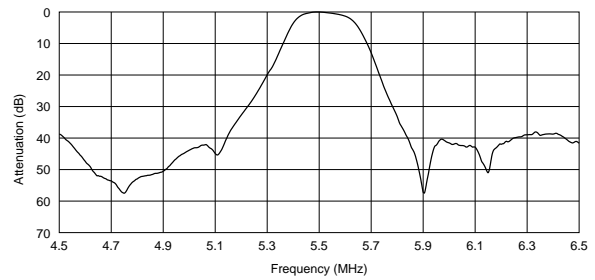

SFSKA6M00CF00-R1

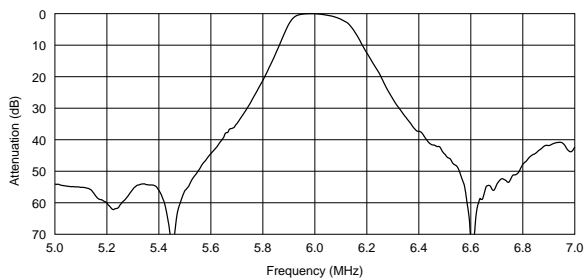

SFSKA6M50CF00-R1

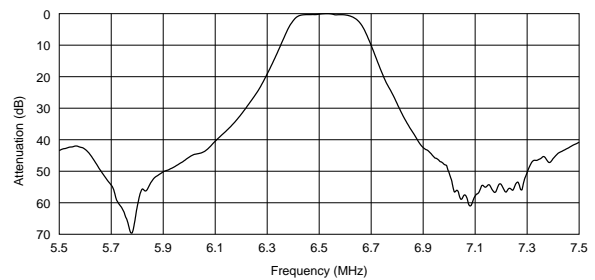



## ■ Frequency Characteristics (Spurious)

SFSKA4M50CF00-R1

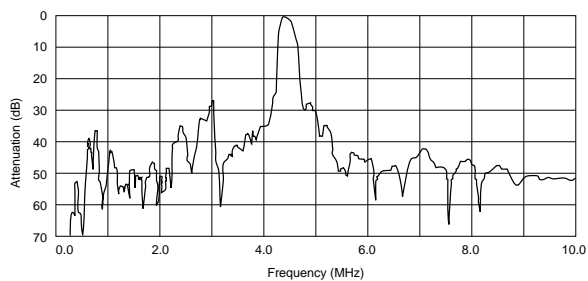

SFSKA5M50CF00-R1

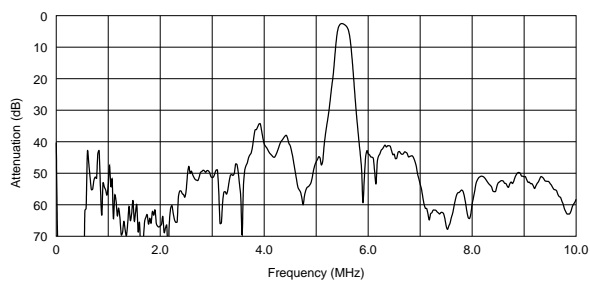

SFSKA6M00CF00-R1

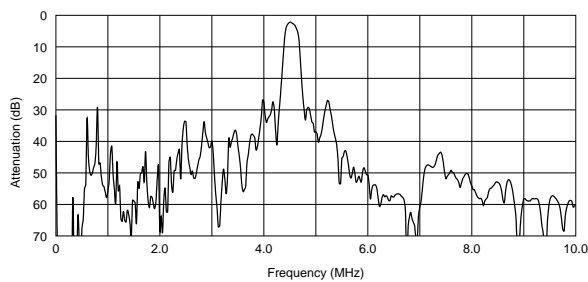

SFSKA6M50CF00-R1

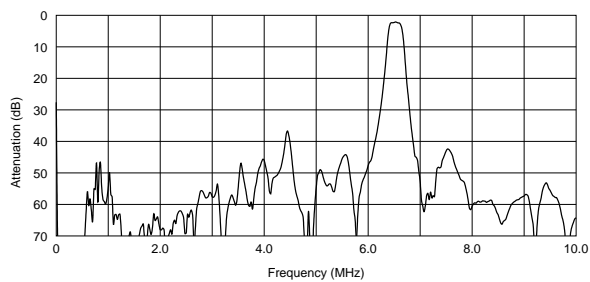

10

# CERAFIL® (Filters/Traps/Discriminators) for Audio/Visual Equipment



## CERAFIL® 2.3-5.7MHz Chip Type SFSKB Series

The SFSKB series are SMD ceramic filters which are suitable for IR head phone applications. Center frequencies of 2.3, 2.8, 3.2, 3.8, 4.3, 4.8, 5.2, 5.7 are available. Realized Small, thin and lightweight package, compared with conventional LC filters. It helps to compose multi channel circuit on one PCB. No frequency adjustment is required on PCB and it contributes reduction of production cost.

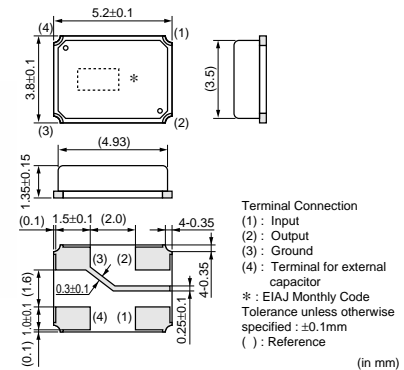

11

### ■ Features

1. SMD package in plastic emboss tape, available for automatic placing.
2. They are slim, at only 1.5mm max. thickness, and have a small mounting area (5.2x3.8mm) enabling flexible PCB design.
3. Available for lead (Pb) free re-flow soldering process.
4. Operating temperature range: 0 to +70 (degree C)  
Storage temperature range: -40 to +85 (degree C)
5. No frequency adjustment is required in production process.
6. Small, thin and lightweight package compared with conventional LC filters

### ■ Applications

1. IR head phone
2. Set Top Box for satellite broadcasting

Part Number	Nominal Center Frequency (fn) (MHz)	3dB Bandwidth (kHz)	20dB Bandwidth (kHz)	Insertion Loss (dB)	Spurious Attenuation(1) (dB)	Spurious Attenuation(2) (dB)	Input/Output Impedance (ohm)
SFSKB2M30GF00-R1	2.300	fn±75 min.	650 max.	6.0 max.	25 min. [within 1.3 to 1.8MHz]	23 min. [within 2.8 to 3.3MHz]	1000
SFSKB2M80GF00-R1	2.800	fn±75 min.	650 max.	6.0 max.	25 min. [within 1.8 to 2.3MHz]	25 min. [within 3.3 to 3.8MHz]	1000
SFSKB3M20FF00-R1	3.200	fn±75 min.	650 max.	6.0 max.	30 min. [within 2.2 to 2.8MHz]	30 min. [within 3.8 to 4.2MHz]	1000
SFSKB3M80GF00-R1	3.800	fn±75 min.	650 max.	6.0 max.	30 min. [within 2.8 to 3.2MHz]	30 min. [within 4.3 to 4.8MHz]	1000
SFSKB4M30GF00-R1	4.300	fn±75 min.	650 max.	6.0 max.	30 min. [within 3.3 to 3.8MHz]	30 min. [within 4.8 to 5.3MHz]	1000
SFSKB4M80GF00-R1	4.800	fn±75 min.	650 max.	6.0 max.	30 min. [within 3.8 to 4.3MHz]	30 min. [within 5.2 to 5.8MHz]	1000
SFSKB5M20GF00-R1	5.200	fn±75 min.	650 max.	6.0 max.	30 min. [within 4.2 to 4.8MHz]	30 min. [within 5.7 to 6.2MHz]	1000
SFSKB5M70GF00-R1	5.700	fn±75 min.	650 max.	6.0 max.	30 min. [within 4.7 to 5.2MHz]	30 min. [within 6.2 to 6.7MHz]	1000

For safety purposes, connect the output of filters to the IF amplifier through a D.C. blocking capacitor. Avoid applying a direct current to the output of ceramic filters. The order quantity should be an integral multiple of the "Minimum Quantity" shown in the package page.

### Standard Center Frequency Rank Code

CODE	30kHz Step	25kHz Step
D	10.64MHz±30kHz	10.650MHz±25kHz
B	10.67MHz±30kHz	10.675MHz±25kHz
A	10.70MHz±30kHz	10.700MHz±25kHz
C	10.73MHz±30kHz	10.725MHz±25kHz
E	10.76MHz±30kHz	10.750MHz±25kHz
Z	Combination A, B, C, D, E	
M	Combination A, B, C	

### Standard Land Pattern Dimensions

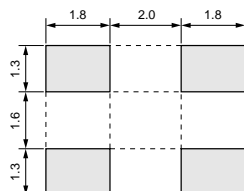

(in mm)

### Frequency Characteristics

SFSKB2M30GF00-R1/SFSKB3M20GF00-R1

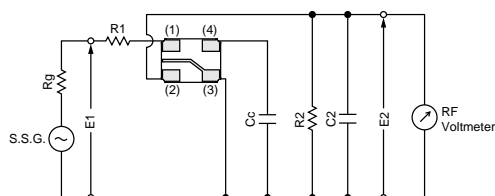

$R1+Rg=R2=1.0k\Omega$   
 $Cc=22pF\pm5\%$   
 $C2=10pF$  (Including stray capacitance and input capacitance of RF Voltmeter)  
 E1 : S.S.G. S.S.G. Output Voltage

(1) : Input  
 (2) : Output  
 (3) : Ground  
 (4) : Terminal for external capacitor

SFSKB2M80GF00-R1/SFSKB3M20FF00-R1

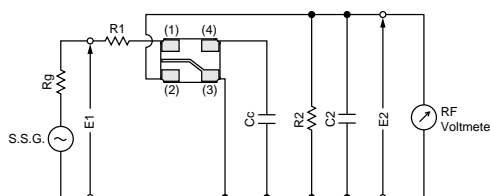

$R1+Rg=R2=1.0k\Omega$   
 $Cc=39pF\pm5\%$   
 $C2=10pF$  (Including stray capacitance and input capacitance of RF Voltmeter)  
 E1 : S.S.G. S.S.G. Output Voltage

(1) : Input  
 (2) : Output  
 (3) : Ground  
 (4) : Terminal for external capacitor

SFSKB4M30GF00-R1/SFSKB5M70GF00-R1

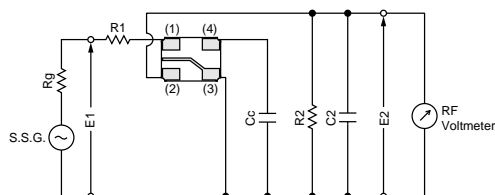

$R1+Rg=R2=1.0k\Omega$   
 $Cc=33pF\pm5\%$   
 $C2=10pF$  (Including stray capacitance and input capacitance of RF Voltmeter)  
 E1 : S.S.G. S.S.G. Output Voltage

(1) : Input  
 (2) : Output  
 (3) : Ground  
 (4) : Terminal for external capacitor

SFSKB4M80GF00-R1

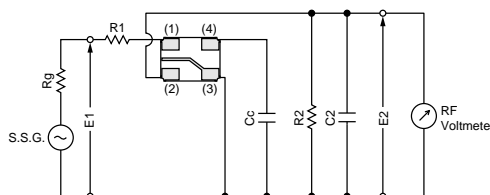

$R1+Rg=R2=1.0k\Omega$   
 $Cc=15pF\pm5\%$   
 $C2=10pF$  (Including stray capacitance and input capacitance of RF Voltmeter)  
 E1 : S.S.G. S.S.G. Output Voltage

(1) : Input  
 (2) : Output  
 (3) : Ground  
 (4) : Terminal for external capacitor

Continued on the following page. ↗

Continued from the preceding page.

## Frequency Characteristics

SFSKB5M20GF00-R1

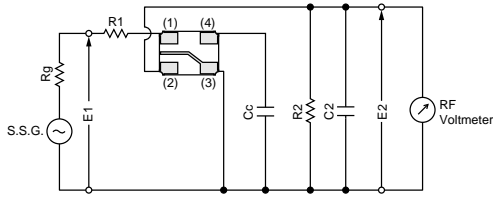

$R1+Rg=R2=1.0k\Omega$   
 $Cc=27pF\pm 5\%$   
 $C2=10pF$  (Including stray capacitance and Input capacitance of RF Voltmeter)  
 E1 : S.S.G. S.S.G. Output Voltage

(1) : Input  
 (2) : Output  
 (3) : Ground  
 (4) : Terminal for external capacitor

## Frequency Characteristics

SFSKB2M30GF00-R1

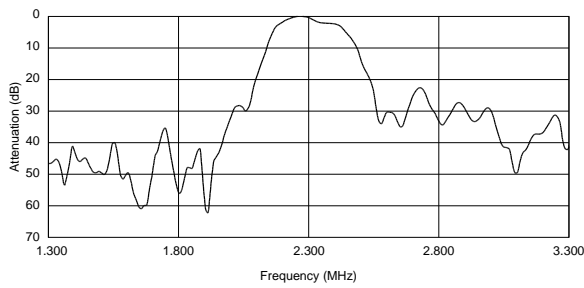

SFSKB2M80GF00-R1

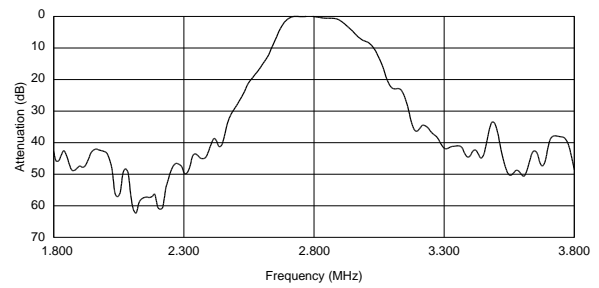

SFSKB3M20FF00-R1

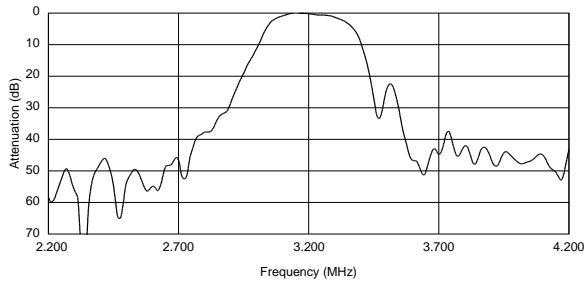

SFSKB3M80GF00-R1

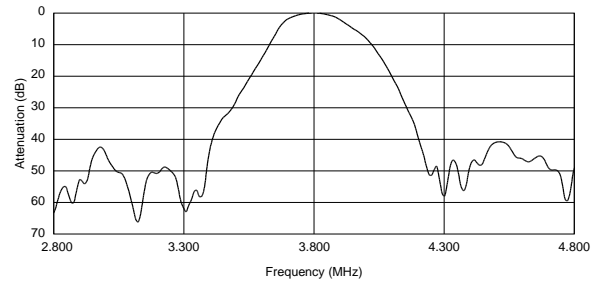

SFSKB4M30GF00-R1

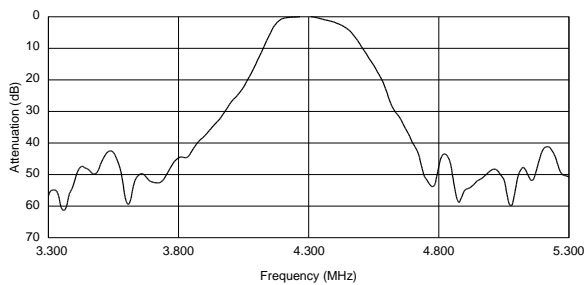

SFSKB4M80GF00-R1

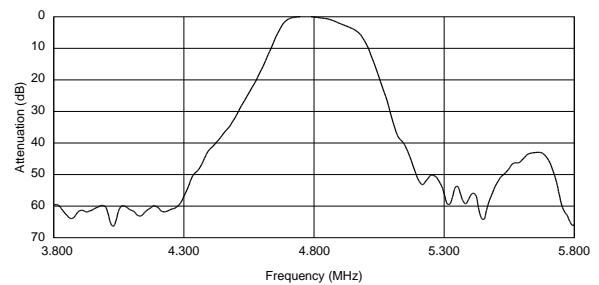

Continued on the following page. ↗

Continued from the preceding page.

## Frequency Characteristics

SFSKB5M20GF00-R1

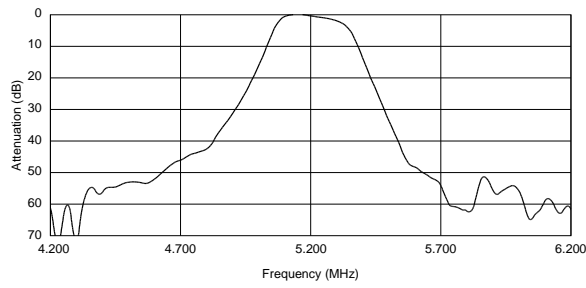

SFSKB5M70GF00-R1

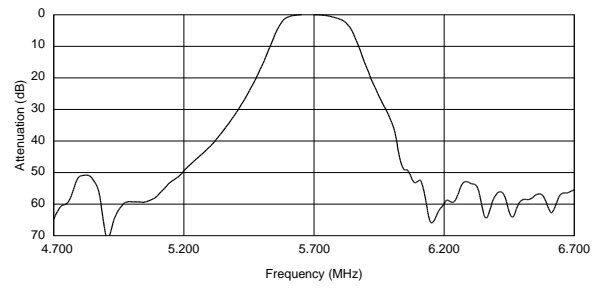

## Frequency Characteristics (Spurious)

SFSKB2M30GF00-R1

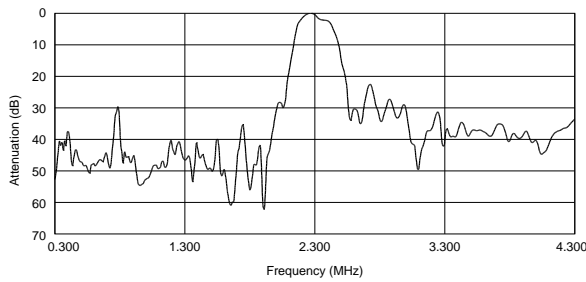

SFSKB2M80GF00-R1

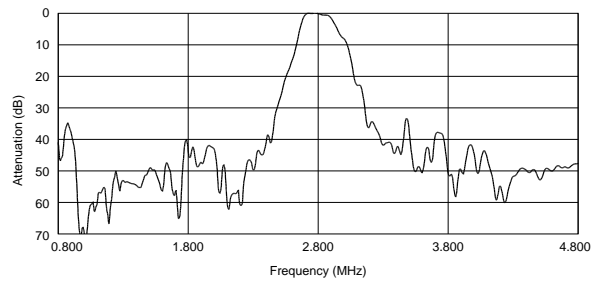

11

SFSKB3M20FF00-R1

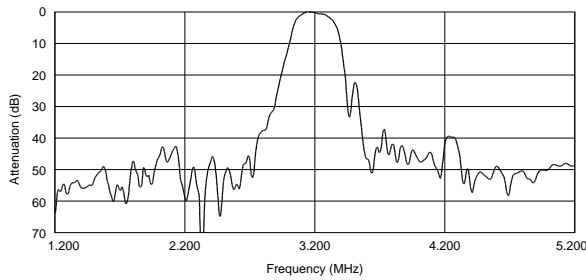

SFSKB3M80GF00-R1

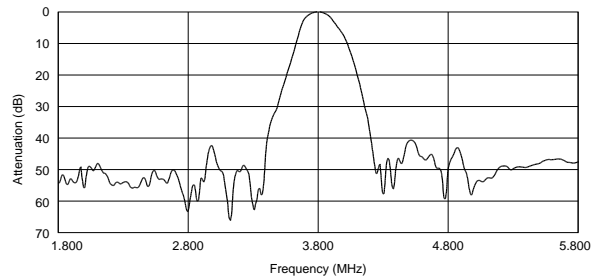

SFSKB4M30GF00-R1

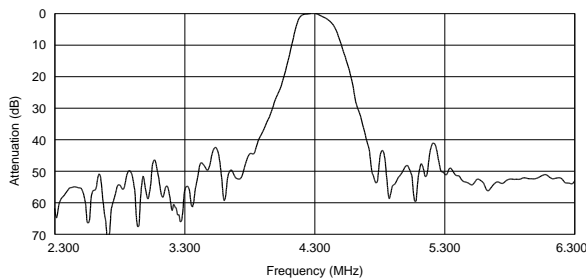

SFSKB4M80GF00-R1

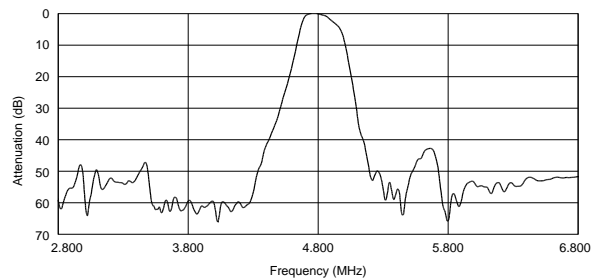

Continued on the following page. ↗

Continued from the preceding page.

### ■ Frequency Characteristics (Spurious)

SFSKB5M20GF00-R1

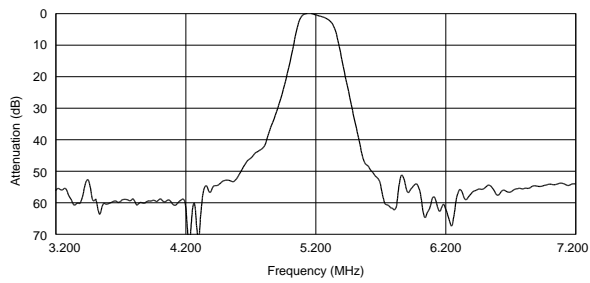

SFSKB5M70GF00-R1

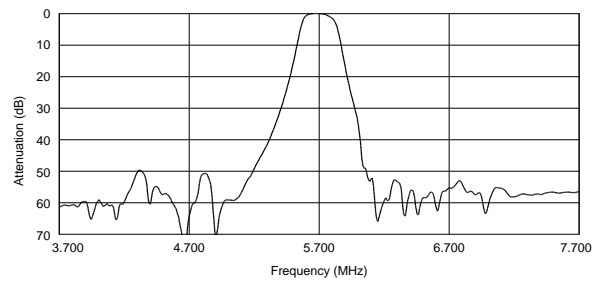

# CERAFIL® (Filters/Traps/Discriminators) for Audio/Visual Equipment



## CERAFIL® 4.5-6.5MHz Standard Lead Type SFSRA Series

As part of the environment protection activity, solder for terminal plating and terminal-element connection inside of ceramic filter SFSRA series contains no lead (Pb).

This series also features thickness shear mode which provides very low spurious response within video signal band.

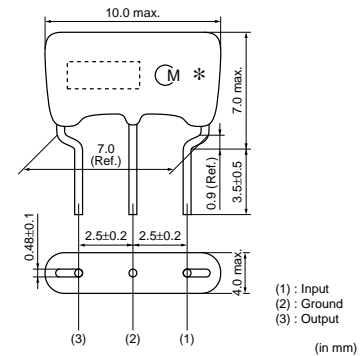

### ■ Features

1. Excellent spurious suppression characteristics within video signal band.
2. Available 4 pass bandwidth variation to meet various requests.
3. Low profile (H=7.0mm max.)
4. Lead dimension: Improved mounting reliability (cut & clinch) due to round terminal.

Part Number	Nominal Center Frequency (fn) (MHz)	3dB Bandwidth (kHz)	20dB Bandwidth (kHz)	Insertion Loss (dB)	Spurious Attenuation(1) (dB)	Spurious Attenuation(2) (dB)	Input/Output Impedance (ohm)
SFSRA4M50BF00-B0	4.500	fn±40 min.	420 max.	8.0 max.	30 min. [within 0 to fn]	20 min. [within fn to 7.0MHz]	1000
SFSRA4M50CF00-B0	4.500	fn±60 min.	600 max.	6.0 max.	30 min. [within 0 to fn]	20 min. [within fn to 7.0MHz]	1000
SFSRA4M50DF00-B0	4.500	fn±70 min.	750 max.	6.0 max.	30 min. [within 0 to fn]	20 min. [within fn to 7.0MHz]	1000
SFSRA4M50EF00-B0	4.500	fn±125 min.	850 max.	6.0 max.	25 min. [within 0 to fn]	18 min. [within fn to 7.0MHz]	1000
SFSRA5M50BF00-B0	5.500	fn±50 min.	400 max.	8.0 max.	30 min. [within 0 to fn]	20 min. [within fn to 7.5MHz]	600
SFSRA5M50CF00-B0	5.500	fn±60 min.	600 max.	6.0 max.	30 min. [within 0 to fn]	20 min. [within fn to 7.5MHz]	600
SFSRA5M50DF00-B0	5.500	fn±80 min.	750 max.	6.0 max.	30 min. [within 0 to fn]	20 min. [within fn to 7.5MHz]	600
SFSRA5M74BF00-B0	5.742	fn±50 min.	400 max.	8.0 max.	30 min. [within 0 to fn]	20 min. [within fn to 7.5MHz]	600
SFSRA5M74CF00-B0	5.742	fn±60 min.	600 max.	6.0 max.	30 min. [within 0 to fn]	20 min. [within fn to 7.5MHz]	600
SFSRA6M00BF00-B0	6.000	fn±50 min.	420 max.	8.0 max.	30 min. [within 0 to fn]	20 min. [within fn to 8.0MHz]	600
SFSRA6M00CF00-B0	6.000	fn±60 min.	600 max.	6.0 max.	30 min. [within 0 to fn]	20 min. [within fn to 8.0MHz]	470
SFSRA6M00DF00-B0	6.000	fn±80 min.	750 max.	6.0 max.	30 min. [within 0 to fn]	20 min. [within fn to 8.0MHz]	470
SFSRA6M50BF00-B0	6.500	fn±50 min.	470 max.	8.0 max.	30 min. [within 0 to fn]	20 min. [within fn to 8.5MHz]	470
SFSRA6M50CF00-B0	6.500	fn±70 min.	650 max.	6.0 max.	30 min. [within 0 to fn]	20 min. [within fn to 8.5MHz]	470
SFSRA6M50DF00-B0	6.500	fn±80 min.	800 max.	6.0 max.	30 min. [within 0 to fn]	20 min. [within fn to 8.5MHz]	470

Area of Insertion Loss: at minimum loss point

For safety purposes, connect the output of filters to the IF amplifier through a D.C. blocking capacitor. Avoid applying a direct current to the output of ceramic filters.

The order quantity should be an integral multiple of the "Minimum Quantity" shown in the package page.

## Test Circuit

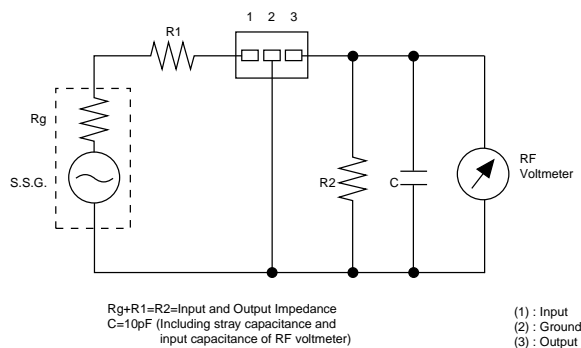

## Frequency Characteristics

SFSRA4M50BF00-B0

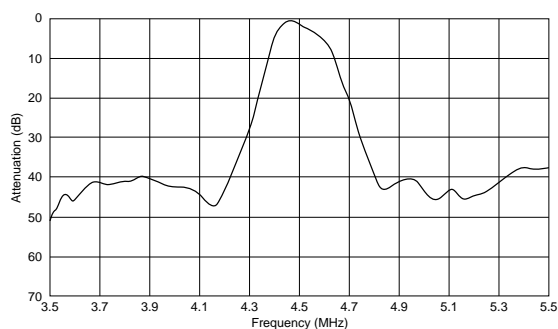

SFSRA4M50CF00-B0

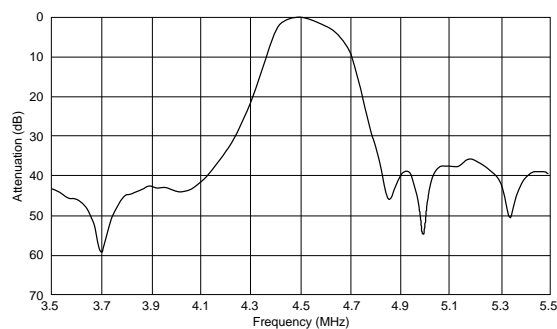

SFSRA4M50DF00-B0

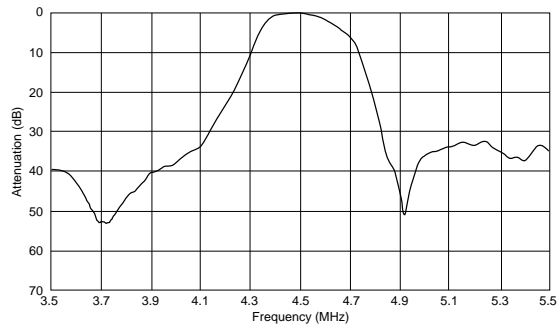

SFSRA4M50EF00-B0

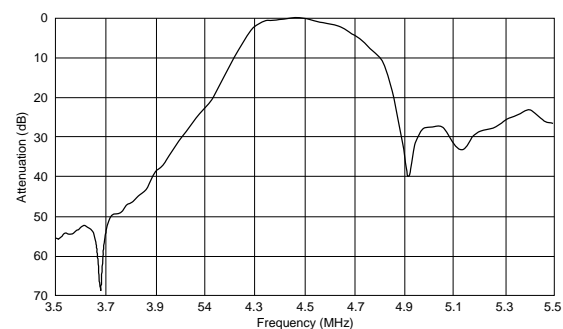

SFSRA5M50BF00-B0

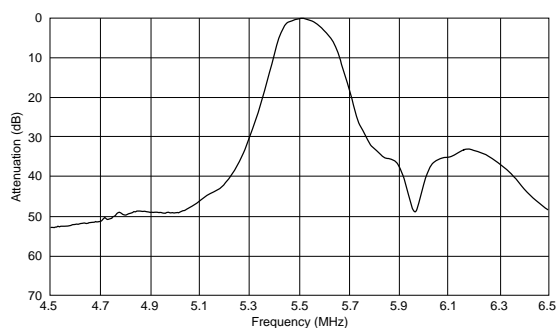

SFSRA5M50CF00-B0

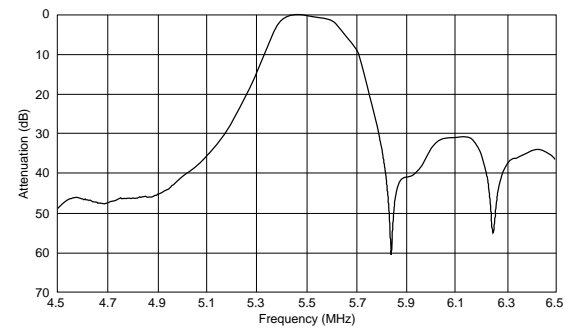

Continued on the following page. ↗



Continued from the preceding page.

## Frequency Characteristics

SFSRA5M50DF00-B0

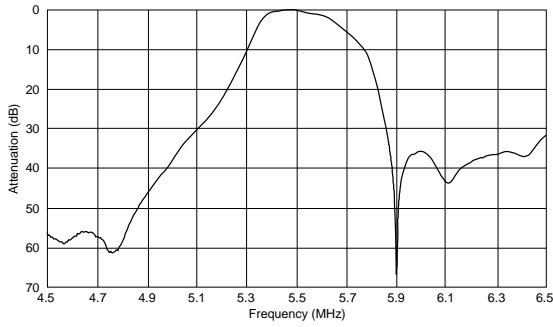

SFSRA5M74BF00-B0

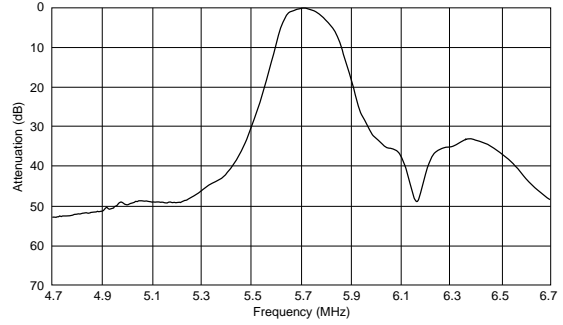

SFSRA5M74CF00-B0

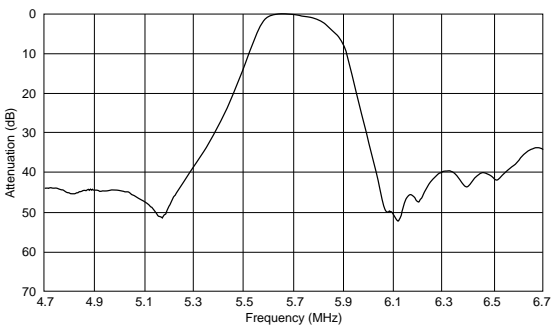

SFSRA6M00BF00-B0

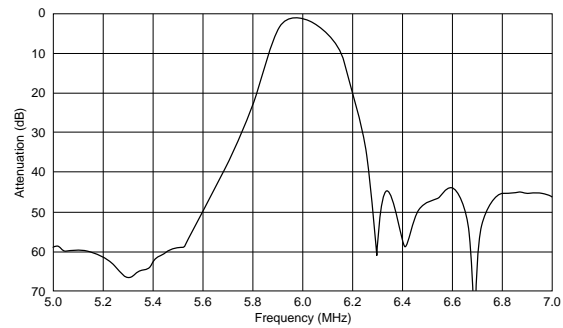

12

SFSRA6M00CF00-B0

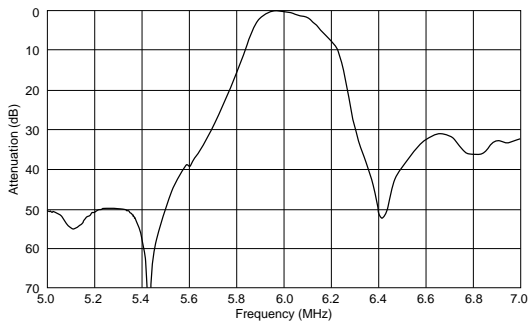

SFSRA6M00DF00-B0

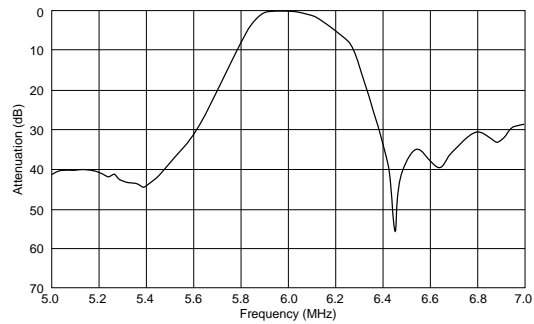

SFSRA6M50BF00-B0

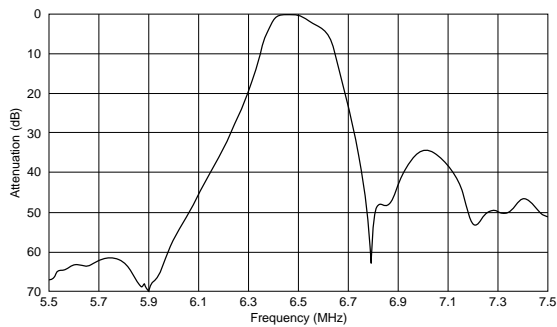

SFSRA6M50CF00-B0

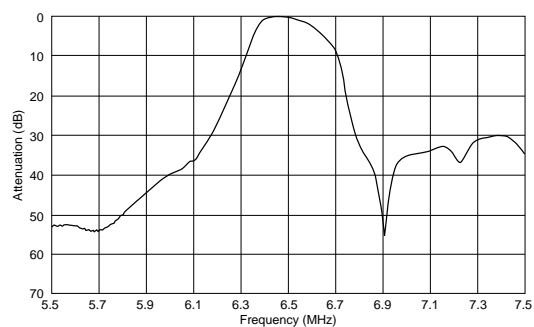

Continued on the following page. ↗

Continued from the preceding page.

## Frequency Characteristics

SFSRA6M50DF00-B0

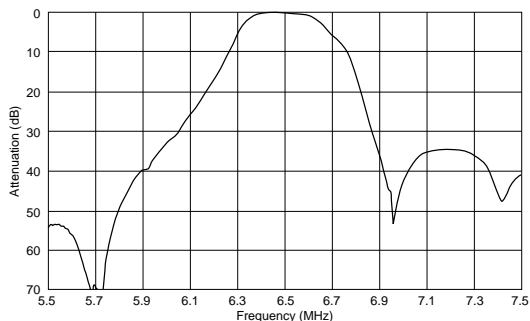

## Frequency Characteristics (Spurious)

SFSRA4M50BF00-B0

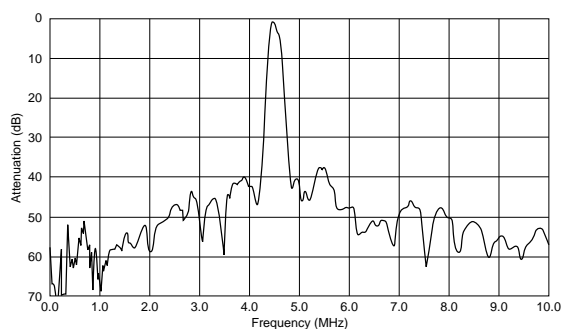

SFSRA4M50CF00-B0

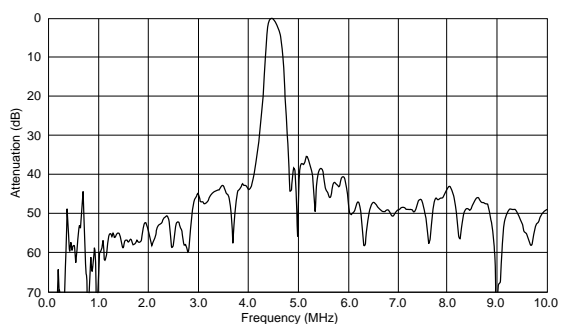

SFSRA4M50DF00-B0

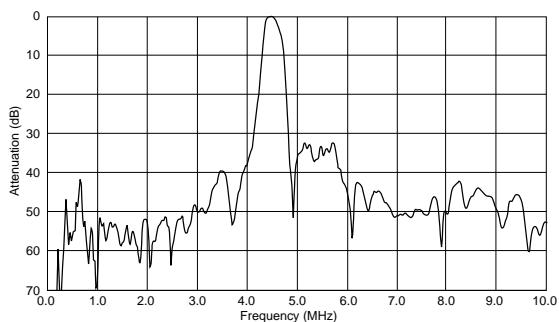

SFSRA4M50EF00-B0

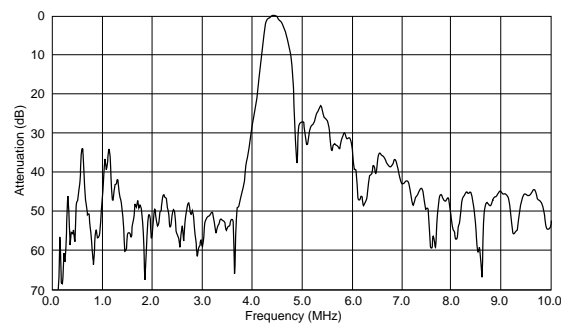

SFSRA5M50BF00-B0

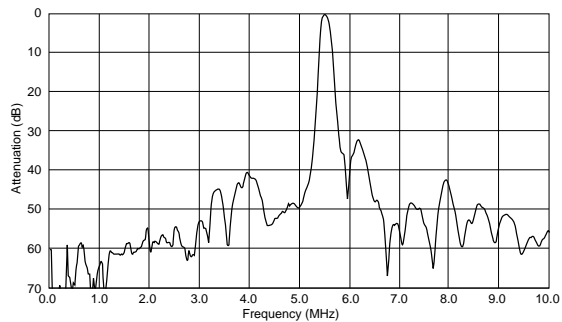

SFSRA5M50CF00-B0

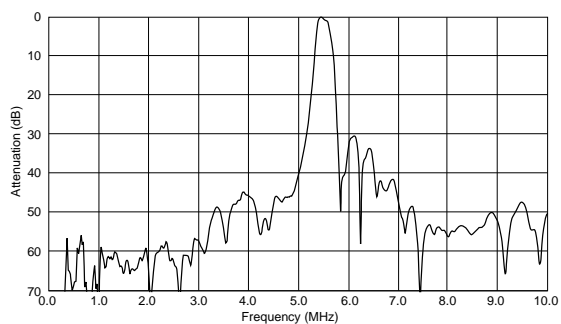

Continued from the preceding page.

### Frequency Characteristics (Spurious)

SFSRA5M50DF00-B0

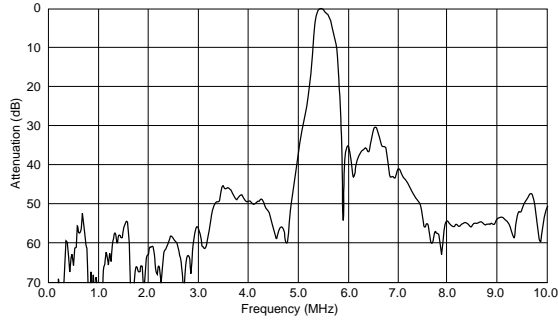

SFSRA5M74BF00-B0

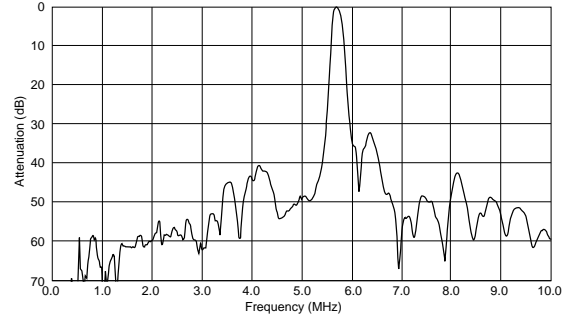

SFSRA5M74CF00-B0

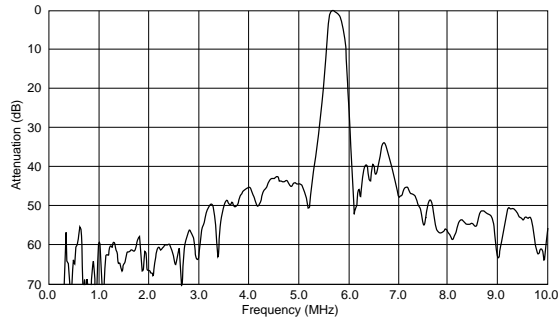

SFSRA6M00BF00-B0

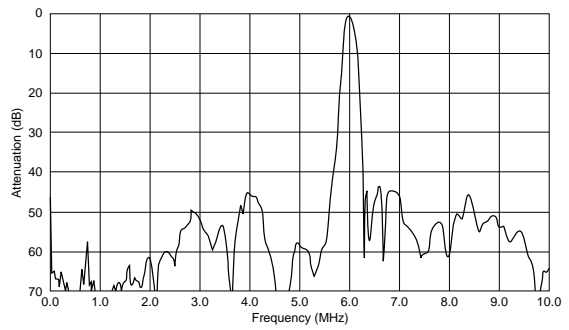

12

SFSRA6M00CF00-B0

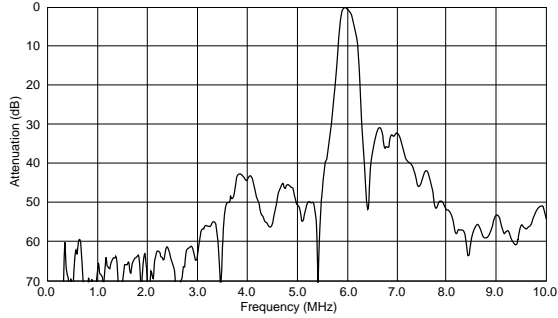

SFSRA6M00DF00-B0

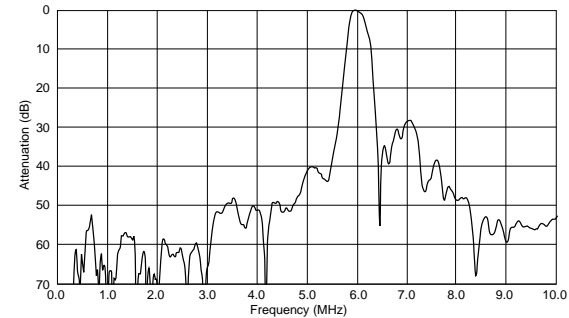

SFSRA6M50BF00-B0

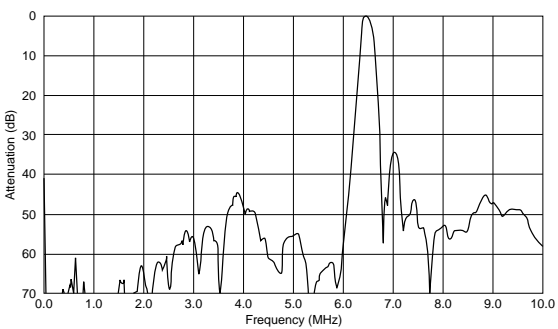

SFSRA6M50CF00-B0

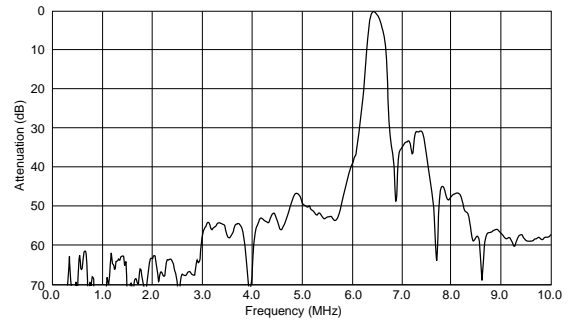

Continued on the following page. ↗

☒ Continued from the preceding page.

## ■ Frequency Characteristics (Spurious)

SFSRA6M50DF00-B0

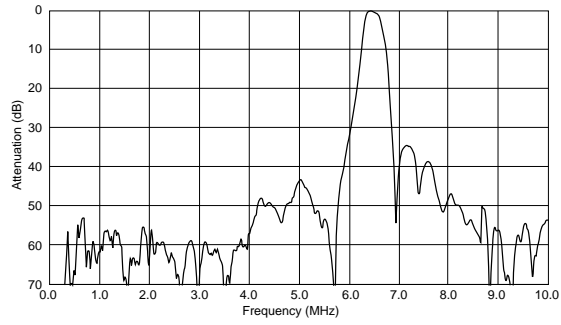

# CERAFIL® (Filters/Traps/Discriminators) for Audio/Visual Equipment



## CERAFIL® 3.5-6.5MHz for Chroma Signal SFSRA/F Series

Chroma signals frequency conversion process is performed in VCRs video signal processing circuit. These SFSRA/SFSRF series are suitable for B.P.F. in this circuit. As part of the environment protection activity, solder for terminal plating and terminal-element connection inside of ceramic filter contain no lead (Pb).

### ■ Features

1. Frequency adjustment free
2. Responsible for VHS. 8mm VCR system

SFSRA Series

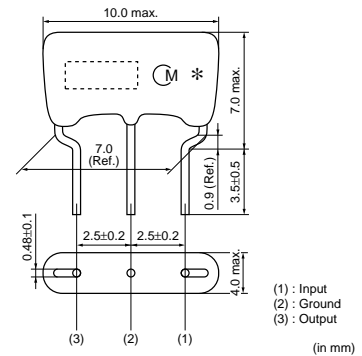

Part Number	Nominal Center Frequency (fn) (MHz)	3dB Bandwidth (kHz)	20dB Bandwidth (kHz)	Insertion Loss (dB)	Spurious Attenuation(1) (dB)	Spurious Attenuation(2) (dB)	Input/Output Impedance (ohm)
<b>SFSRA4M43CF00-B0</b>	4.430	fn±60 min.	600 max.	6.0 max.	30 min. [within 0 to fn]	20 min. [within fn to 7.0MHz]	1000
<b>SFSRF3M58CF00-B0</b>	3.580	fn±40 min.	530 max.	6.0 max.	25 min. [within 0 to fn]	15 min. [within fn to 6.0MHz]	1000

Area of Insertion Loss: at minimum loss point

For safety purposes, connect the output of filters to the IF amplifier through a D.C. blocking capacitor. Avoid applying a direct current to the output of ceramic filters. The order quantity should be an integral multiple of the "Minimum Quantity" shown in the package page.

### ■ Test Circuit

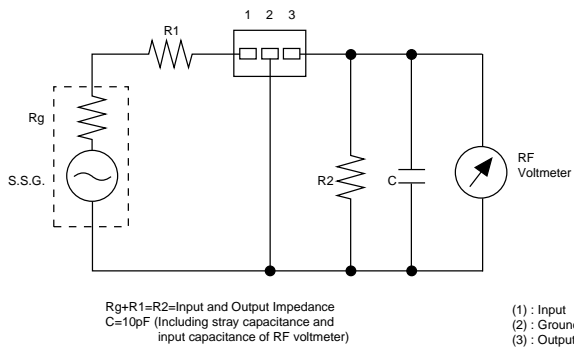

### ■ Frequency Characteristics

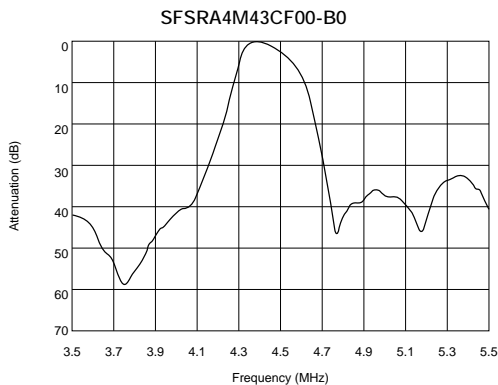

### ■ Frequency Characteristics (Spurious)

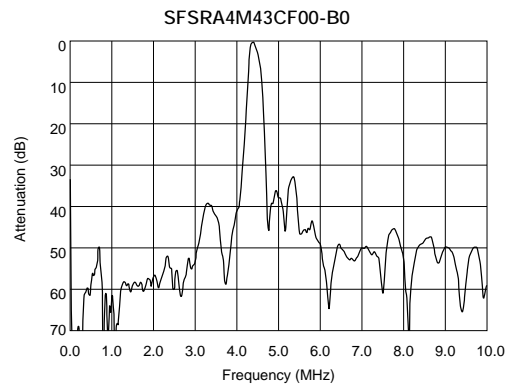

# CERAFIL® (Filters/Traps/Discriminators) for Audio/Visual Equipment



## CERAFIL® 455kHz Chip Type SFPKA Series

SFPKA series for AM use is one of the most recommendable intermediate filters, having such distinctive features as high selectivity, high stability and adjustment-free operation. Additionally its easy matching with IC helps create an easy circuit design.

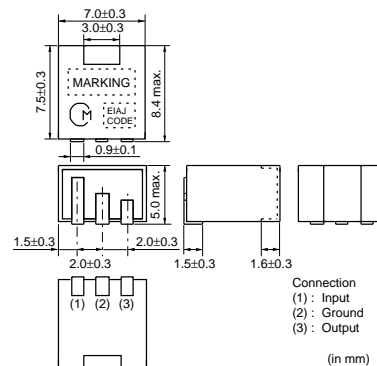

### ■ Features

1. The filters are mountable by automatic placers and can be reflow soldered and withstand washing.
2. The filters are wide bandwidth and high selectivity. So they are suitable for car radio and multi-band radio.

14

Part Number	Center Frequency (fo) (kHz)	6dB Bandwidth (kHz)	Selectivity (+) (dB)	Selectivity (-) (dB)	Insertion Loss (dB)	Input/Output Impedance (ohm)	Element
SFPKA450KH1A-R1	450.0 ±1.0kHz	fn±3.0 min.	40 min. [fn+9kHz]	40 min. [fn-9kHz]	6.0 max.	2000	4
SFPKA450KG1A-R1	450.0 ±1.0kHz	fn±4.5 min.	40 min. [fn+10kHz]	40 min. [fn-10kHz]	6.0 max.	1500	4
SFPKA450KF4A-R1	450.0 ±1.5kHz	fn±6.0 min.	40 min. [fn+12.5kHz]	40 min. [fn-12.5kHz]	6.0 max.	1500	4

Area of Insertion Loss: at minimum loss point

Center frequency (fo) is defined by the center of 6dB bandwidth.

(fn) means nominal center frequency (450kHz).

For safety purposes, connect the output of filters to the IF amplifier through a D.C. blocking capacitor. Avoid applying a direct current to the output of ceramic filters.

The order quantity should be an integral multiple of the "Minimum Quantity" shown in the package page.

### ■ Standard Land Pattern Dimensions

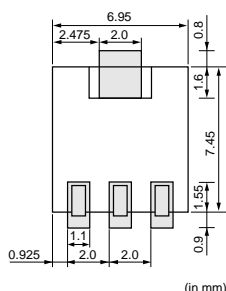

### Recommended IFT

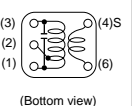
Item	Type	SFPKA		
		(1)—(2)	(2)—(3)	(4)—(6)
Winding Specification				
S(3) (2) (1)	(4)S  (Bottom view)	60T	125T	28T
No load Qu		40		
Tuning Capacitance		180pF		

• Matching of CERAFIL® SFPKA series with IFT is decided by the Qu of IFT and IFT secondary side impedance, |Z2|. Set the Qu at about 40 because a Qu value which is too high (e.g., 90) may produce ripple in the waveform. It is recommended to match the impedance of |Z2| with that of the CERAFIL®.

### Test Circuit

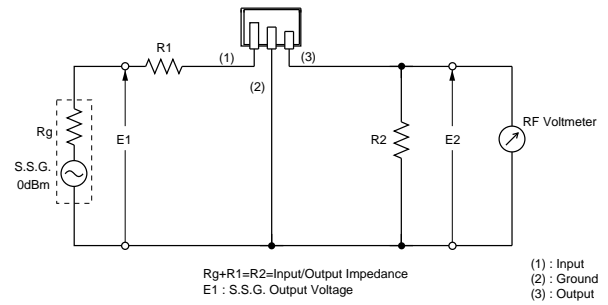

### Frequency Characteristics

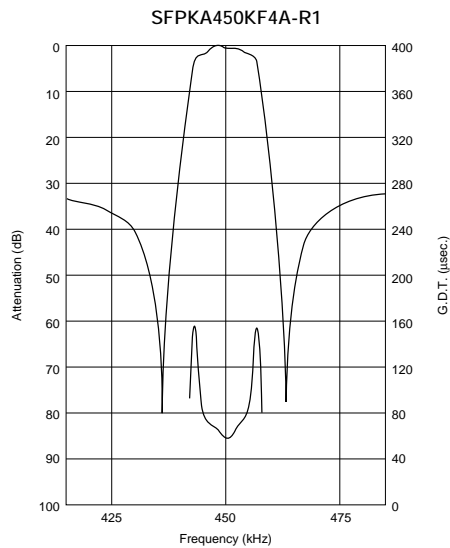
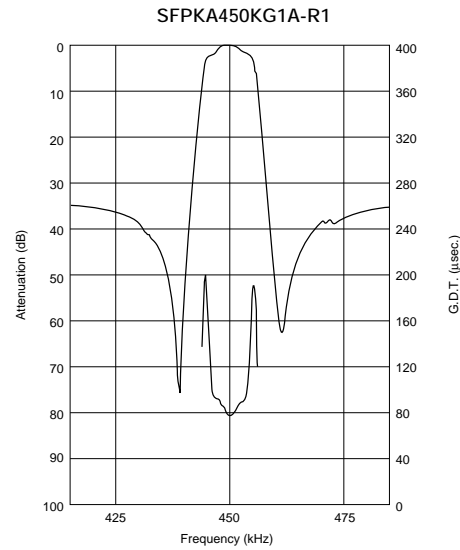
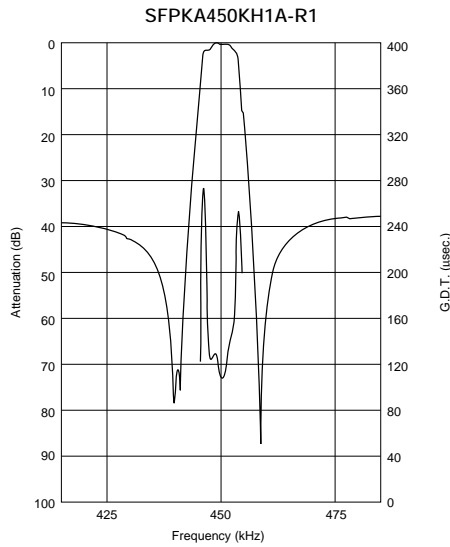

# CERAFIL® (Filters/Traps/Discriminators) for Audio/Visual Equipment



## CERAFIL® 455kHz SFULA/SFZLA Series

SFULA/SFZLA series for AM use is one of the most recommendable intermediate filters, having such distinctive features as high selectivity, high stability, and adjustment-free operation. Additionally its easy matching with IC helps create an easy circuit design.

### ■ Features

1. Center frequency range between 450 to 470kHz are available standard tolerance of  $\pm 2$ kHz.
2. For frequency synthesizers, center frequencies of 450, 459 and 468kHz are available standard tolerance of  $\pm 1$ kHz.



SFULA Series

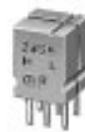
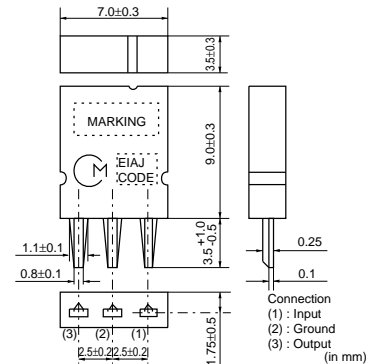

SFZLA Series

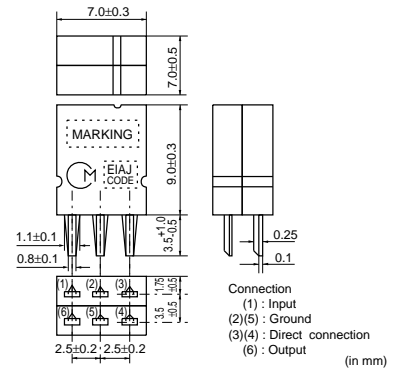

15

Part Number	Center Frequency (fo) (kHz)	3dB Bandwidth (kHz)	Selectivity (+) (dB)	Selectivity (-) (dB)	Insertion Loss (dB)	Input/Output Impedance (ohm)	Element
SFULA455KU2A-B0	455.0 $\pm 2.0$ kHz	10.0 $\pm 3.0$ kHz	4 min. [fo+10kHz]	6 min. [fo-10kHz]	5.0 max.	3000	1
SFULA455KU2B-B0	462.0 $\pm 2.0$ kHz	10.0 $\pm 3.0$ kHz	4 min. [fo+10kHz]	6 min. [fo-10kHz]	5.0 max.	3000	1
SFZLA455KN2A-B0	455.5 $\pm 2.0$ kHz	4.0 $\pm 1.0$ kHz	23 min. [fo+9kHz]	23 min. [fo-9kHz]	7.0 max.	3000	2
SFZLA455KS2A-B0	456.0 $\pm 2.0$ kHz	5.5 $\pm 1.0$ kHz	18 min. [fo+9kHz]	18 min. [fo-9kHz]	7.0 max.	3000	2
SFZLA455KT2A-B0	456.0 $\pm 2.0$ kHz	7.0 $\pm 1.0$ kHz	16 min. [fo+9kHz]	16 min. [fo-9kHz]	6.0 max.	3000	2

Area of Insertion Loss: at minimum loss point

Center frequency (fo) is defined by the center of 3dB bandwidth.

For safety purposes, connect the output of filters to the IF amplifier through a D.C. blocking capacitor. Avoid applying a direct current to the output of ceramic filters.

The order quantity should be an integral multiple of the "Minimum Quantity" shown in the package page.

### ■ Frequency Characteristics (CERAFIL® with IFT)

Part Number	6dB Band Width (kHz)	Selectivity		Input Level (at 0.6mV output) (dB)
		+9kHz off (dB)	-9kHz off (dB)	
IFT+SFULA455KU2B-B0	6.5	20	23	78
IFT+SFZLA455KN2A-B0	5.0		38	78
IFT+SFZLA455KS2A-B0	7.0		33	78
IFT+SFZLA455KT2A-B0	8.5		27	78

Typ. value

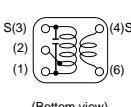

## Recommended IFT

Item	Type	SFULA□B			SFZLA□A		
		7×7mm IFT					
Winding Specification		(1)–(2)	(2)–(3)	(4)–(6)	(1)–(2)	(2)–(3)	(4)–(6)
 (Bottom view)		70T	115T	7T	68T	84T	14T
No load $Q_u$		105			90		
Tuning Capacitance		180pF			180pF		

• Matching of CERAFIL® SFULA/SFZLA series with IFT is decided by the IFT secondary side impedance, |Z<sub>2</sub>|. The design target values of |Z<sub>2</sub>| are:  
 For SFULA□B : 300Ω  
 For SFZLA□A : 1kΩ

## Test Circuit (CERAFIL® Only)

SFULA Series

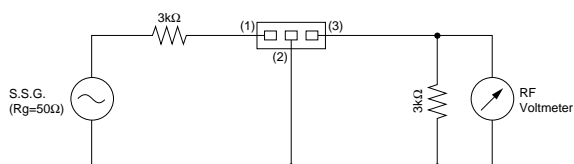

SFZLA Series

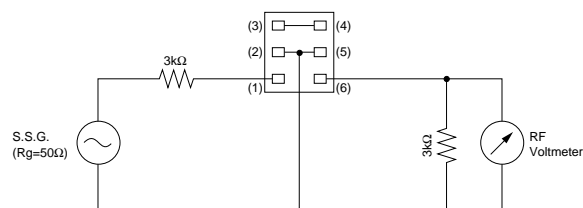

15

## Test Circuit (CERAFIL® with IFT)

SFULA Series

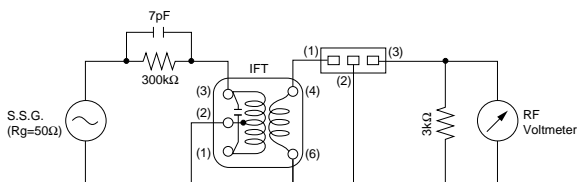

SFZLA Series

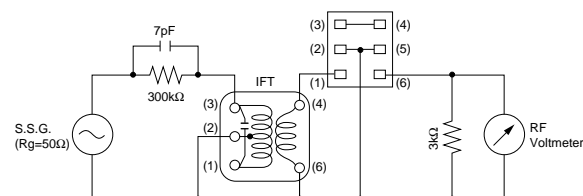

## Frequency Characteristics

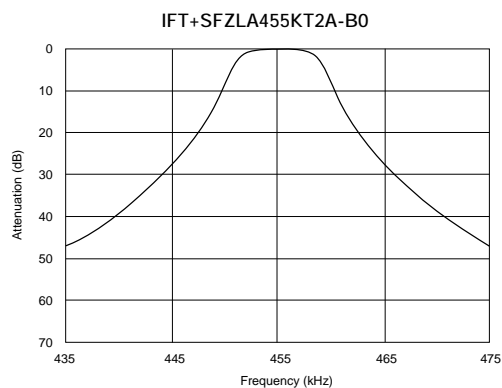
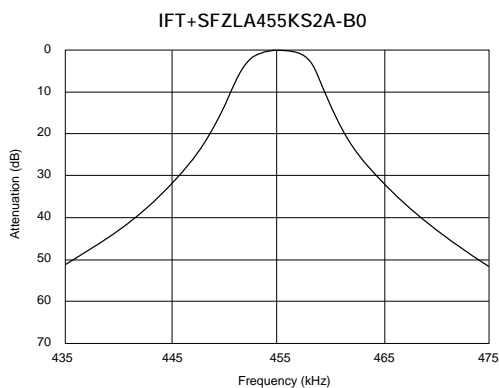
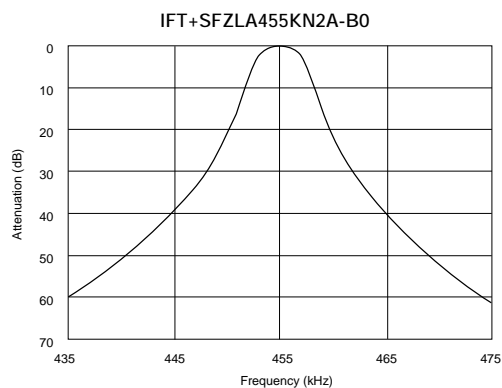
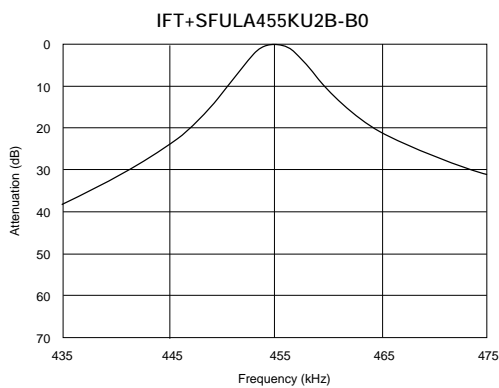

15

## Frequency Characteristics (Spurious)

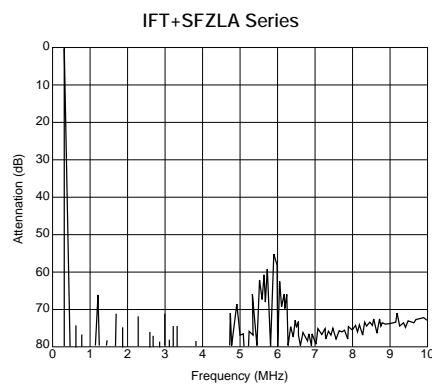
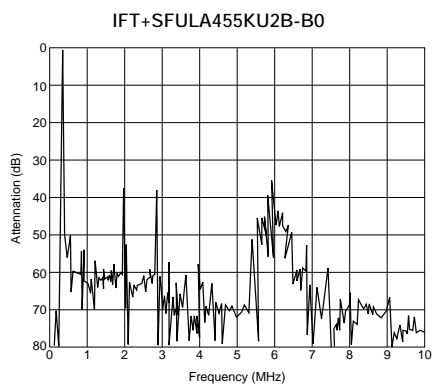

# CERAFIL® (Filters/Traps/Discriminators) for Audio/Visual Equipment



## CERAFIL® 455kHz SFPLA/CFWLA Series

SFPLA/CFWLA series for AM use is one of the most suitable intermediate filters, having such distinctive features as high selectivity, high stability, high attenuation, and adjustment-free operation. Additionally its easy matching with IC helps create an easy circuit design. This is the most suitable for car-stereo and all band radio with high attenuation.



SFPLA Series

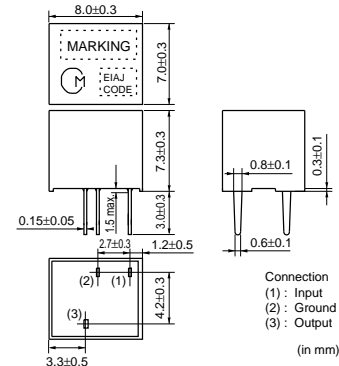

CFWLA Series

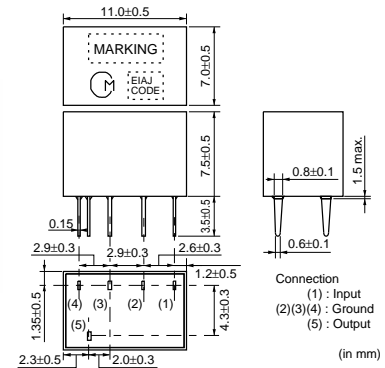

16

Part Number	Center Frequency (fo) (kHz)	6dB Bandwidth (kHz)	Selectivity (+) (dB)	Selectivity (-) (dB)	Insertion Loss (dB)	Input/Output Impedance (ohm)	Element
SFPLA450KJ1A-B0	450.0 ±1.0kHz	fn±2.0 min.	40 min.[fn+7.5kHz]	40 min.[fn-7.5kHz]	6.0 max.	2000	4
SFPLA450KH1A-B0	450.0 ±1.0kHz	fn±3.0 min.	40 min.[fn+9kHz]	40 min.[fn-9kHz]	6.0 max.	2000	4
CFWLA450KJFA-B0	450.0 (fn)	fn±2.0 min.	50 min.[fn+7.5kHz]	50 min.[fn-7.5kHz]	7.0 max.	2000	6
CFWLA450KHFA-B0	450.0 (fn)	fn±3.0 min.	50 min.[fn+9kHz]	50 min.[fn-9kHz]	6.0 max.	2000	6

Area of Insertion Loss: at minimum loss point

Center frequency (fo) is defined by the center of 6dB bandwidth.

(fn) means nominal center frequency (450kHz).

For safety purposes, connect the output of filters to the IF amplifier through a D.C. blocking capacitor. Avoid applying a direct current to the output of ceramic filters.

The order quantity should be an integral multiple of the "Minimum Quantity" shown in the package page.

### Recommended IFT

Item	Type	SFPLA/CFULA/CFWLA		
		7x7mm IFT		
Winding Specification		(1)—(2)	(2)—(3)	(4)—(6)
S(3) (2) (1)		60T	125T	28T
No load Qu		40		
Tuning Capacitance		180pF		

• Matching of CERAFIL® SFPLA/CFULA/CFWLA series with IFT is decided by the Qu of IFT and IFT secondary side impedance, |Z2|. Set the Qu at about 40 because a Qu value which is too high (e.g., 90) may produce ripple in the waveform. It is recommended to match the impedance of |Z2| with that of the CERAFIL®.

### Test Circuit

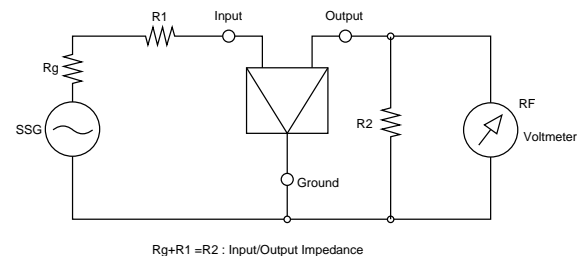

Continued on the following page. ↗

Continued from the preceding page.

### Frequency Characteristics

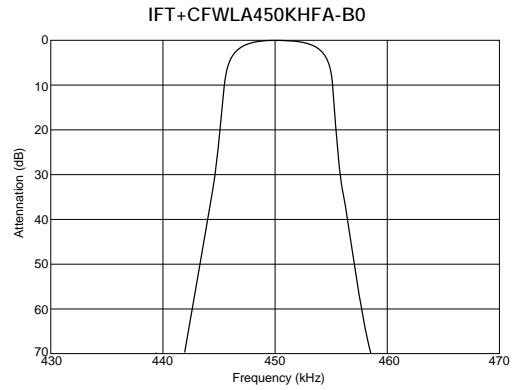
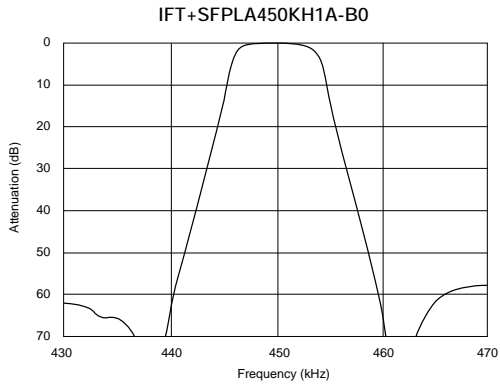

### Frequency Characteristics (Spurious)

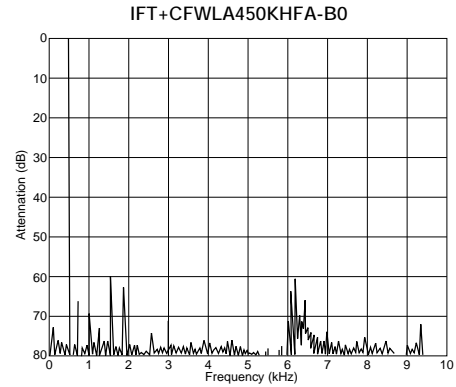
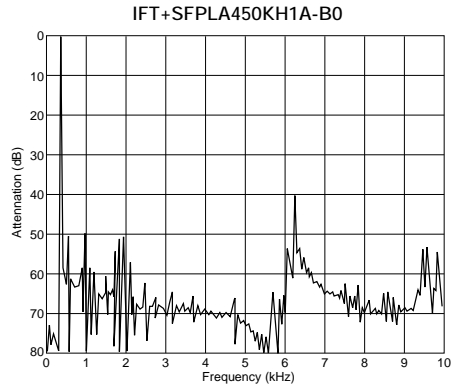

# CERAFIL® (Filters/Traps/Discriminators) for Audio/Visual Equipment



## CERAFIL® 455kHz for AM Stereo Wide Bandwidth Type SFPLA/CFWLA/CFULA Series

SFPLA/CFULA/CFWLA series for AM use is one of the most suitable intermediate filters, having such distinctive features as high selectivity, high stability, high attenuation, and adjustment-free operation. Additionally its easy matching with IC helps create an easy circuit design. Especially, CFULA/CFWLA\_Y series is the frequency fidelity in the high sound area of an AM stereo will be improved with wide band, flat group delay time characteristics.



SFPLA Series

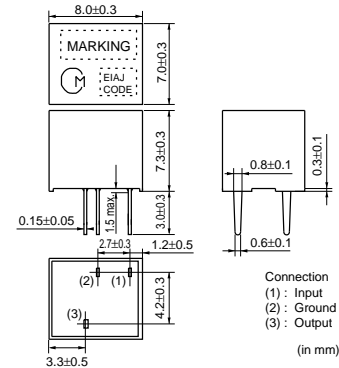

CFWLA Series

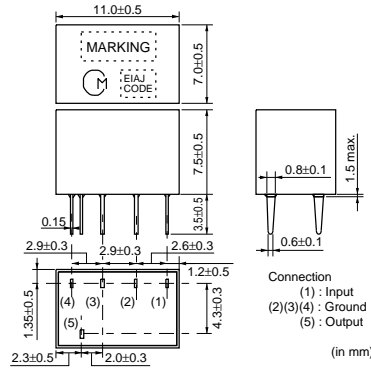

CFULA Series

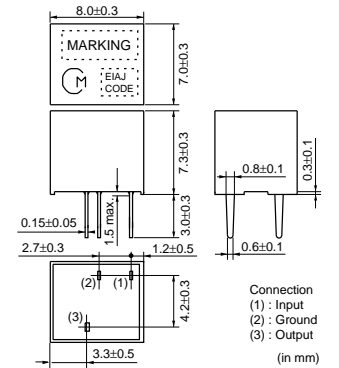

Part Number	Center Frequency (fo) (kHz)	6dB Bandwidth (kHz)	Selectivity (+) (dB)	Selectivity (-) (dB)	Insertion Loss (dB)	GDT 20μsec. Bandwidth (kHz)	Input/Output Impedance (ohm)	Element
SFPLA450KG1A-B0	450.0 ±1.0kHz	fn±4.5 min.	30 min.[fn+9kHz]	30 min.[fn-9kHz]	6.0 max.	-	2000	4
SFPLA450KF1A-B0	450.0 ±1.0kHz	fn±6.0 min.	40 min.[fn+12.5kHz]	40 min.[fn-12.5kHz]	6.0 max.	-	2000	4
SFPLA450KE1A-B0	450.0 ±1.0kHz	fn±7.5 min.	40 min.[fn+15kHz]	40 min.[fn-15kHz]	6.0 max.	-	1500	4
SFPLA450KD1A-B0	450.0 ±1.0kHz	fn±10.0 min.	40 min.[fn+20kHz]	40 min.[fn-20kHz]	4.0 max.	-	1500	4
CFULA450KG1Y-B0	450.0 ±1.0kHz	fn±4.5 min.	40 min.[fn+15kHz]	40 min.[fn-15kHz]	10.0 max.	fn±3	2000	4
CFULA450KF1Y-B0	450.0 ±1.0kHz	fn±6.0 min.	40 min.[fn+17.5kHz]	40 min.[fn-17.5kHz]	9.0 max.	fn±4	2000	4
CFULA450KD1Y-B0	450.0 ±1.0kHz	fn±10.0 min.	40 min.[fn+25kHz]	40 min.[fn-25kHz]	7.0 max.	fn±7	1500	4
CFWLA450KG1Y-B0	450.0 ±1.0kHz	fn±4.5 min.	50 min.[fn+15kHz]	50 min.[fn-15kHz]	11.0 max.	fn±4	2000	6
CFWLA450KF1Y-B0	450.0 ±1.0kHz	fn±6.0 min.	50 min.[fn+17.5kHz]	50 min.[fn-17.5kHz]	10.0 max.	fn±5	2000	6
CFWLA450KD1Y-B0	450.0 ±1.0kHz	fn±10.0 min.	50 min.[fn+25kHz]	50 min.[fn-25kHz]	8.0 max.	fn±8	1500	6
CFWLA450KGFA-B0	450.0 (fn)	fn±4.5 min.	50 min.[fn+10kHz]	50 min.[fn-10kHz]	6.0 max.	-	2000	6
CFWLA450KFFA-B0	450.0 (fn)	fn±6.0 min.	50 min.[fn+12.5kHz]	50 min.[fn-12.5kHz]	6.0 max.	-	2000	6
CFWLA450KEFA-B0	450.0 (fn)	fn±7.5 min.	50 min.[fn+15kHz]	50 min.[fn-15kHz]	6.0 max.	-	1500	6
CFWLA450KDFAB0	450.0 (fn)	fn±10.0 min.	50 min.[fn+20kHz]	50 min.[fn-20kHz]	4.0 max.	-	1500	6

Area of Insertion Loss: at minimum loss point

Center frequency (fo) is defined by the center of 6dB bandwidth.

(fn) means nominal center frequency (450kHz).

For safety purposes, connect the output of filters to the IF amplifier through a D.C. blocking capacitor. Avoid applying a direct current to the output of ceramic filters.

The order quantity should be an integral multiple of the "Minimum Quantity" shown in the package page.

## Recommended IFT

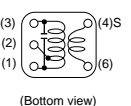
Item	Type	SFPLA/CFULA/CFWLA		
		7x7mm IFT		
Winding Specification	(1)—(2)	(2)—(3)	(4)—(6)	
	 (Bottom view)	60T	125T	28T
No load $Q_u$		40		
Tuning Capacitance		180pF		

• Matching of CERAFIL® SFPLA/CFULA/CFWLA series with IFT is decided by the  $Q_u$  of IFT and IFT secondary side impedance, [Z2]. Set the  $Q_u$  at about 40 because a  $Q_u$  value which is too high (e.g., 90) may produce ripple in the waveform. It is recommended to match the impedance of [Z2] with that of the CERAFIL®.

## Test Circuit

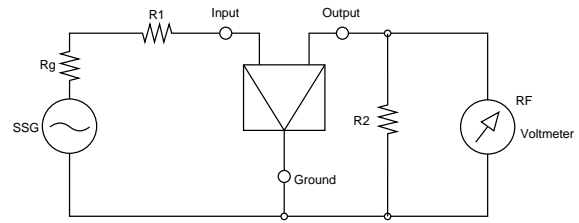

$R_g + R_1 = R_2$  : Input/Output Impedance

## Frequency Characteristics

IFT+SFPLA450KF1A-B0

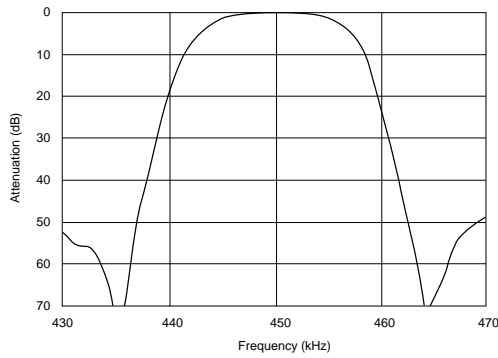

IFT+CFWLA450KFFA-B0

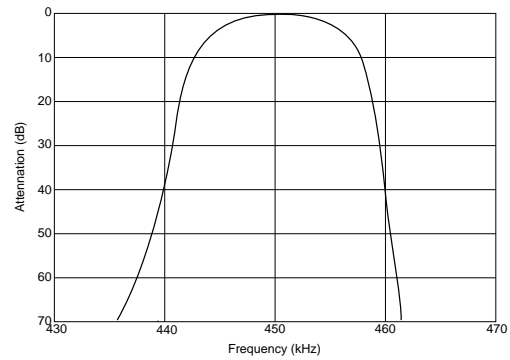

IFT+CFULA450KF1Y-B0

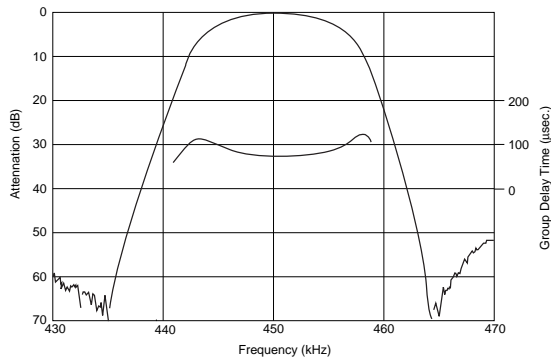

IFT+CFWLA450KF1Y-B0

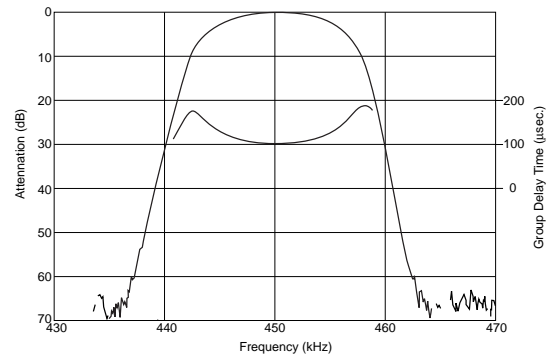

# CERAFIL® (Filters/Traps/Discriminators) for Audio/Visual Equipment



## CERAFIL® 455kHz for AM Search-stop Signal Detection

BFULA series are narrow bandwidth filters. This filter is used in the application which detects the carrier peak with a narrow bandwidth amplifier, or an electronic tuner as a stop signal detector.

### ■ Features

Most suitable for IC Station Detectors (SD)

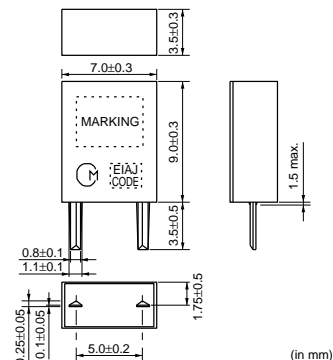

Part Number	Resonant Frequency (Fr) (kHz)	Delta F (Fa-Fr) (kHz)	Resonant Resistance (ohm)	Capacitance (pF)
<b>BFULA450KC-B0</b>	450 ±1.0kHz	14.0 ±2.0kHz	20 max.	360 ±20%
<b>BFULA450KC004-B0</b>	450 ±0.8kHz	9.0 ±2.0kHz	30 max.	360 ±20%
<b>BFULA450KK003-B0</b>	450 ±1.0kHz	27.5 ±4.5kHz	30 max.	550 ±20%

fa-fr: Difference between the anti-resonant frequency and the resonant frequency.

For safety purposes, avoid applying a direct current between the terminals.

The order quantity should be an integral multiple of the "Minimum Quantity" shown in the package page.

### ■ Impedance Characteristics

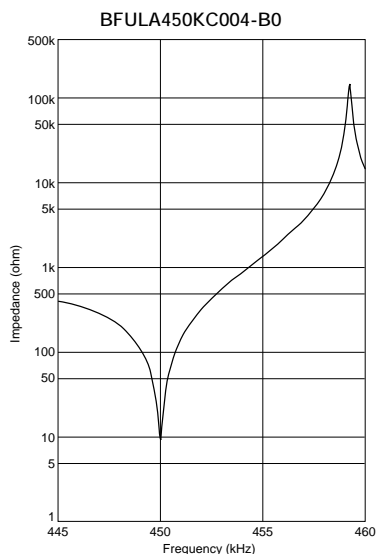

# CERAFIL<sup>®</sup> 455kHz SF Series Temperature Characteristics

## ■ SFZLA455KS2A-B0

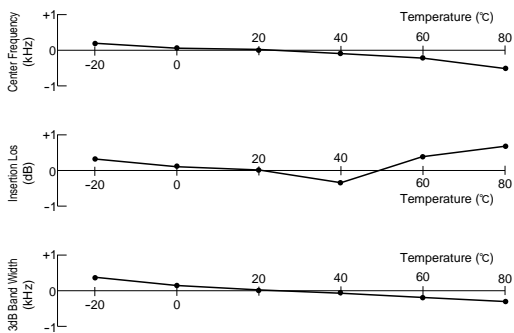

## ■ SFPLA450KH1A-B0

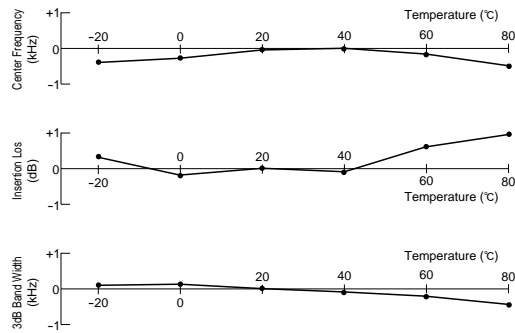



# CERAFIL® 455kHz SF/BF Series Application Circuit

## ■ Car Radio

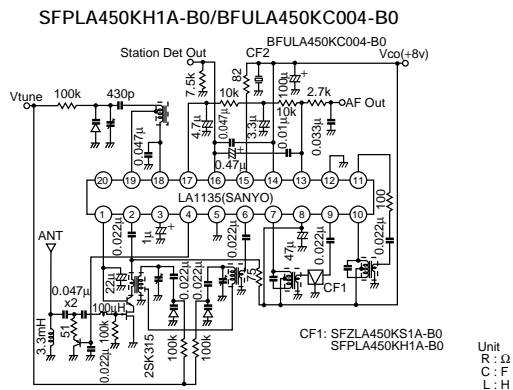

## ■ Portable Radio

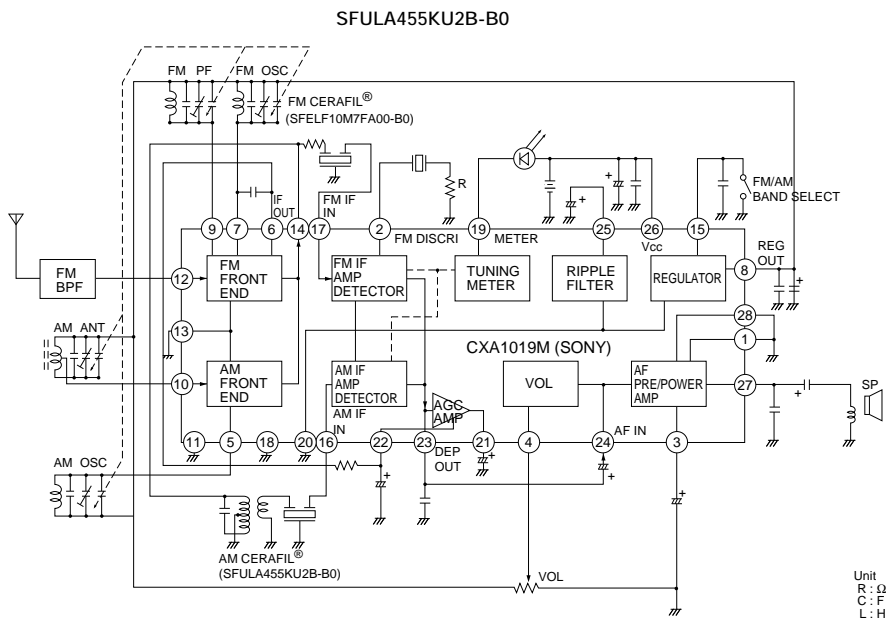

Continued on the following page.



# CERAFIL® (Filters/Traps/Discriminators) for Audio/Visual Equipment



## Ceramic Trap 4.5-6.5MHz Chip Type TPSKA Series

SMD ceramic trap TPSKA\_B is small and thin SMD trap sealed with a metal cap. Recommended for LCD-TV's, and small and thin tuners.

### ■ Features

1. High attenuation and high performance group delay time
2. Small and thin package
3. Reflow-solderable

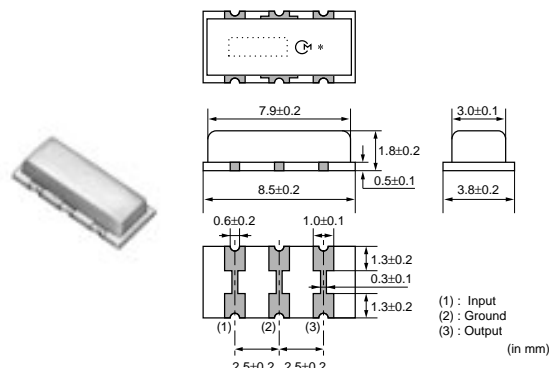

Part Number	Nominal Center Frequency (fn1) (MHz)	Attenuation (at fn1) (dB)	30dB Attenuation BW (fn1) (kHz)
TPSKA4M50B00-R1	4.500	35 min.	50 min.
TPSKA5M50B00-R1	5.500	35 min.	70 min.
TPSKA6M00B00-R1	6.000	35 min.	70 min.
TPSKA6M50B00-R1	6.500	35 min.	70 min.

For safety purposes, connect the output of filters to the IF amplifier through a D.C. blocking capacitor. Avoid applying a direct current to the output of ceramic filters. The order quantity should be an integral multiple of the "Minimum Quantity" shown in the package page.

### ■ Standard Land Pattern Dimensions

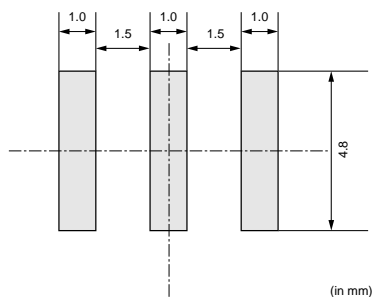

### ■ Test Circuit

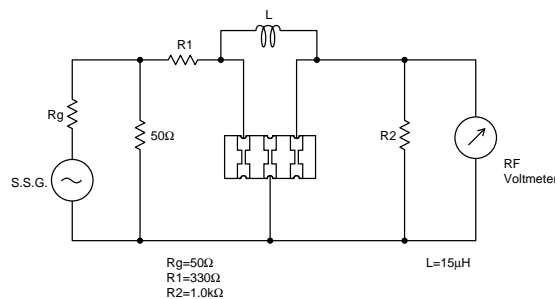

### ■ Frequency Characteristics

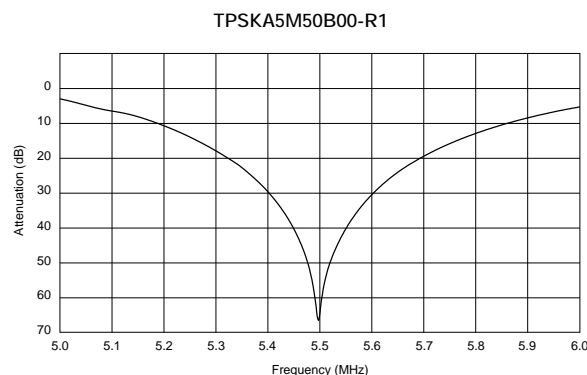
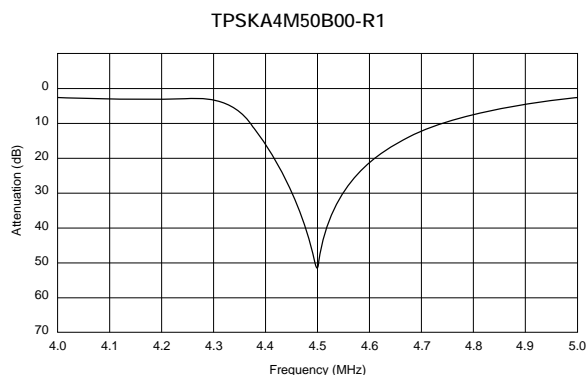

Continued on the following page. ↗

Continued from the preceding page.

### Frequency Characteristics

TPSKA6M00B00-R1

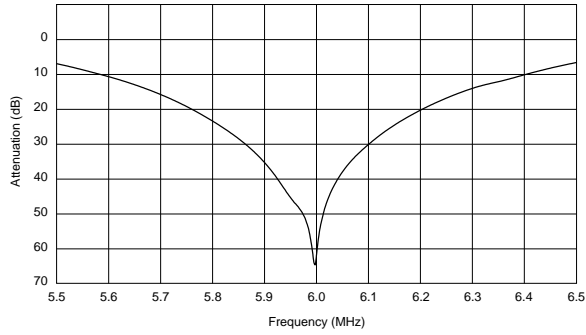

TPSKA6M50B00-R1

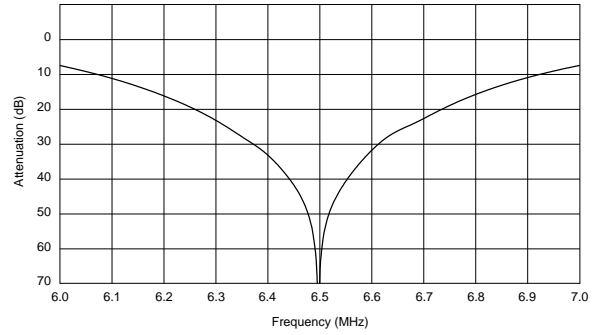

### Frequency Characteristics (Spurious)

TPSKA4M50B00-R1

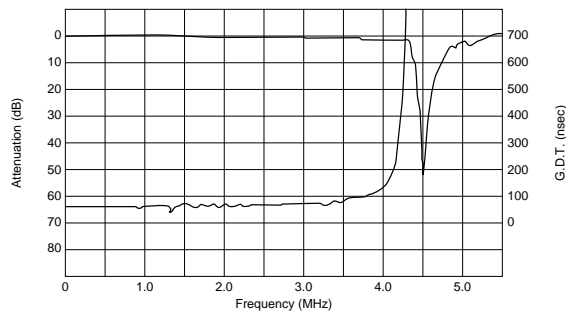

TPSKA5M50B00-R1

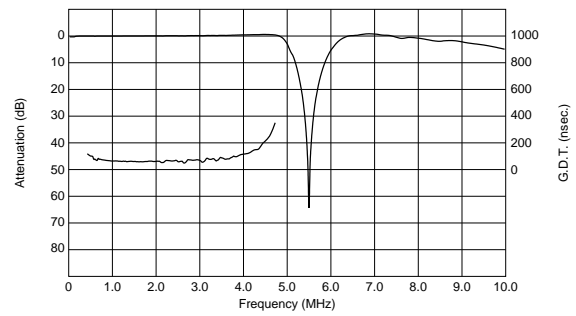

TPSKA6M00B00-R1

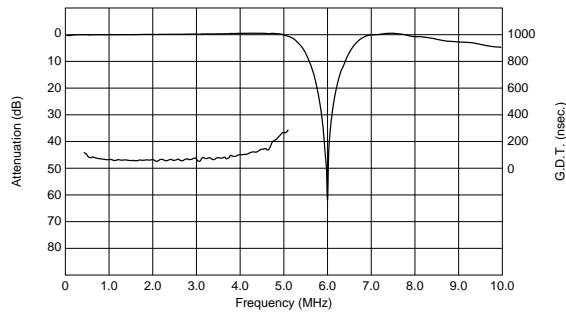

TPSKA6M50B00-R1

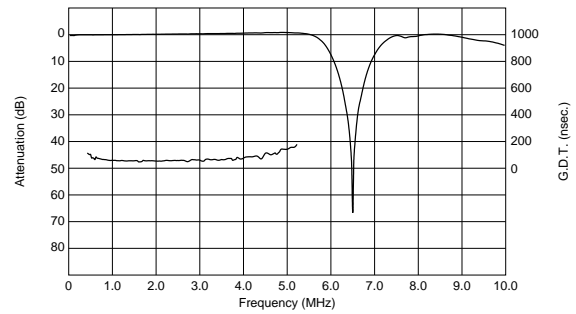

# CERAFIL® (Filters/Traps/Discriminators) for Audio/Visual Equipment



## Ceramic Trap 4.5-6.5MHz Chip Type Double Traps TPWKA Series

SMD ceramic trap TPWKA is small and thin SMD trap sealed with a metal cap. Recommended for LCD-TV's, and small and thin tuners.

This series consists of 2 wafers with 2 trap frequencies. Recommended for multi-standard set.

### ■ Features

1. Good performance of attenuation
2. Small and thin package
3. Reflow-solderable

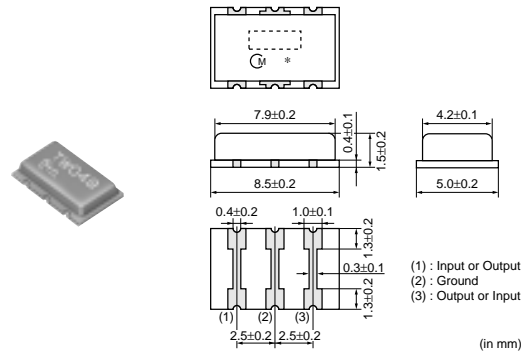

Part Number	Nominal Center Frequency (fn1) (MHz)	Nominal Center Frequency (fn2) (MHz)	Attenuation (at fn1) (dB)	Attenuation (at fn2) (dB)	30dB Attenuation BW (fn1) (kHz)
TPWKA5M50B04-R1	5.500	5.742	30 min.	30 min.	50 min.

For safety purposes, connect the output of filters to the IF amplifier through a D.C. blocking capacitor. Avoid applying a direct current to the output of ceramic filters. The order quantity should be an integral multiple of the "Minimum Quantity" shown in the package page.

### ■ Standard Land Pattern Dimensions

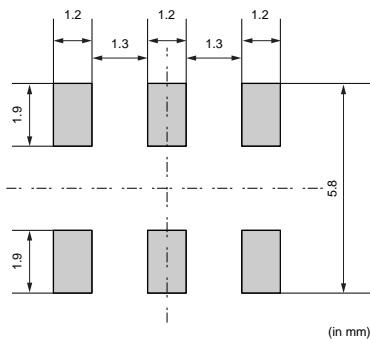

### ■ Test Circuit

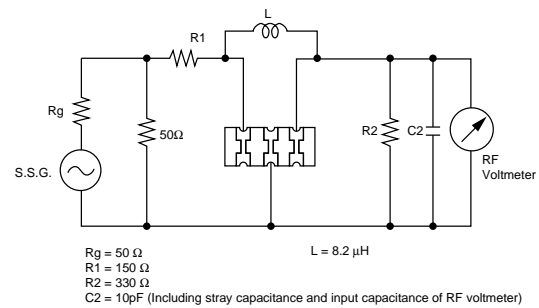

20

### ■ Frequency Characteristics

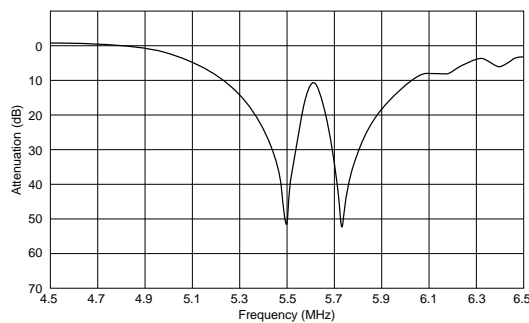

### ■ Frequency Characteristics (Spurious)

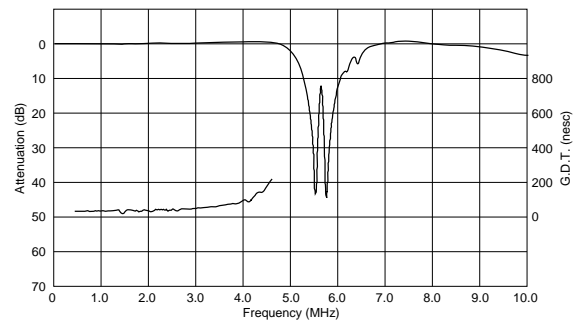

# CERAFIL® (Filters/Traps/Discriminators) for Audio/Visual Equipment



## Ceramic Trap 4.5-6.5MHz Standard Lead Type TPSRA Series

As part of the environment protection activity, solder for terminal plating and terminal-element connection inside of ceramic filter TPSRA series contain no lead (Pb).

This series consists of two trap element on one wafer. Suitable for the sound IF trap of CTV/VCR.

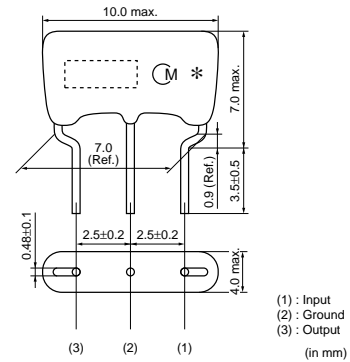

### ■ Features

1. Good performance of attenuation
2. Shape factor can be changed by the value of Inductor "L".
3. Three-terminals type
4. Low profile (H=7.0mm max.)
5. Lead dimension:  
Improved mounting reliability (cut & clinch) due to round terminal.

Part Number	Nominal Center Frequency (fn1) (MHz)	Attenuation (at fn1) (dB)	30dB Attenuation BW (fn1) (kHz)
TPSRA4M50C00-B0	4.500	30 min.	-
TPSRA4M50B00-B0	4.500	35 min.	50 min.
TPSRA5M50B00-B0	5.500	35 min.	70 min.
TPSRA5M74B00-B0	5.742	35 min.	70 min.
TPSRA6M00B00-B0	6.000	35 min.	70 min.
TPSRA6M50B00-B0	6.500	35 min.	70 min.

For safety purposes, connect the output of filters to the IF amplifier through a D.C. blocking capacitor. Avoid applying a direct current to the output of ceramic filters. The order quantity should be an integral multiple of the "Minimum Quantity" shown in the package page.

21

### ■ Test Circuit

TPSRA4M50B00-B0

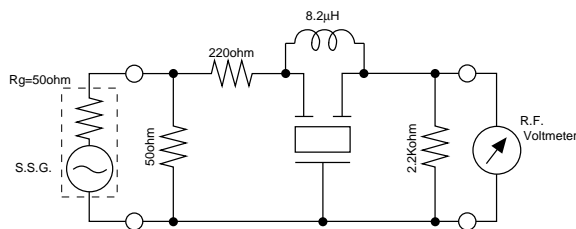

TPSRA4M50C00-B0

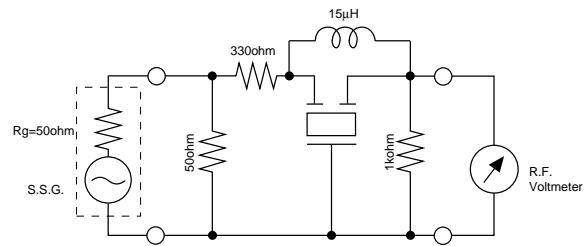

Continued on the following page. ↗

Continued from the preceding page.

■ Test Circuit

TPSRA5M50/5M74/6M00/6M50B00-B0

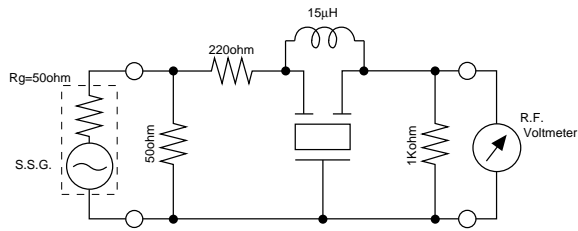

■ Frequency Characteristics

TPSRA4M50B00-B0

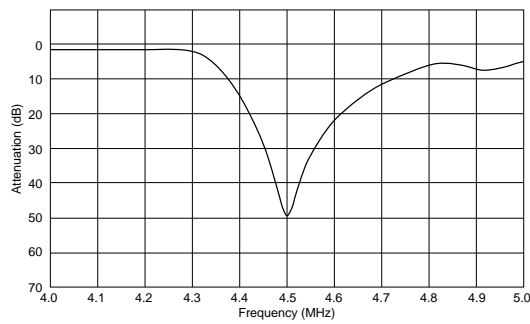

TPSRA4M50C00-B0

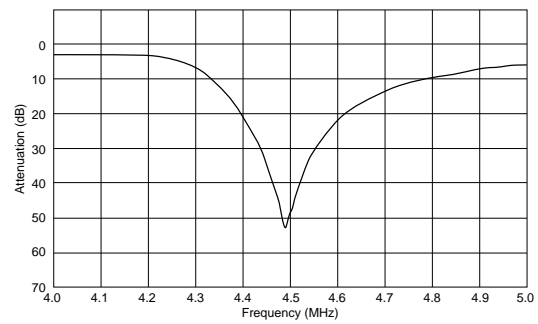

TPSRA5M50B00-B0

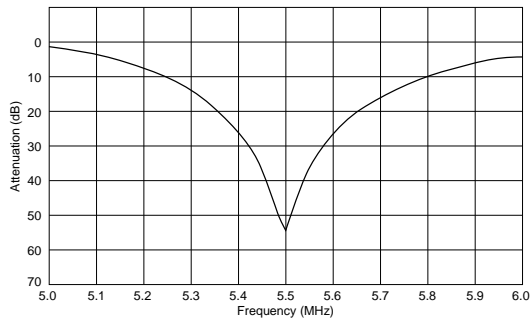

TPSRA5M74B00-B0

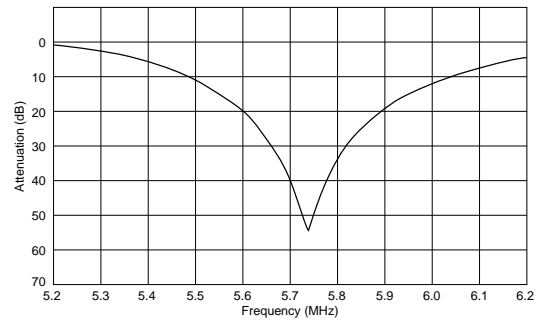

TPSRA6M00B00-B0

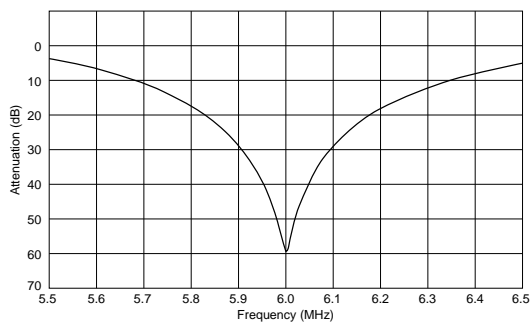

TPSRA6M50B00-B0

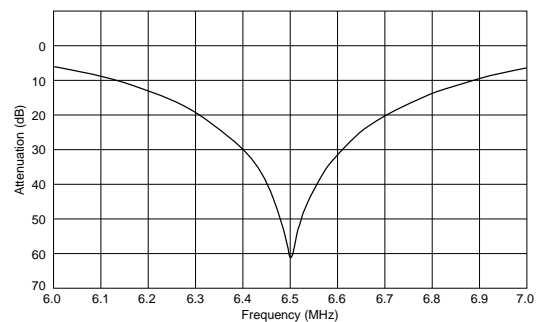

Continued from the preceding page.

## Frequency Characteristics (Spurious)

TPSRA4M50B00-B0

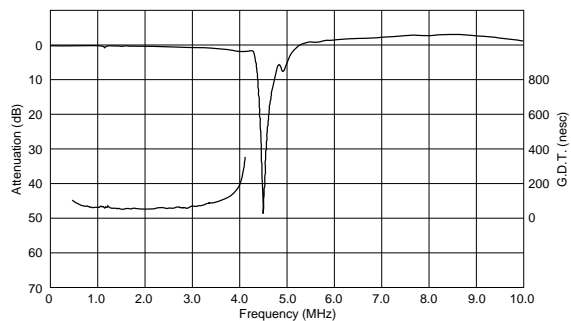

TPSRA4M50C00-B0

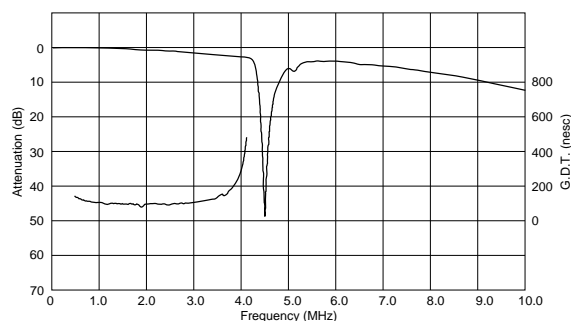

TPSRA5M50B00-B0

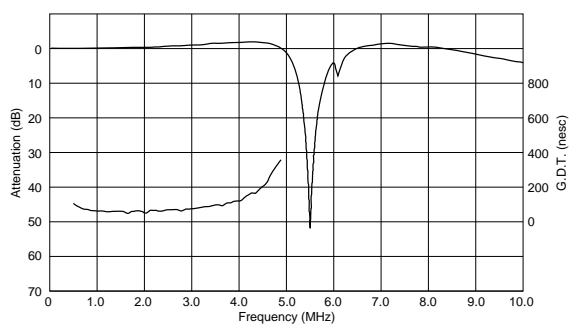

TPSRA5M74B00-B0

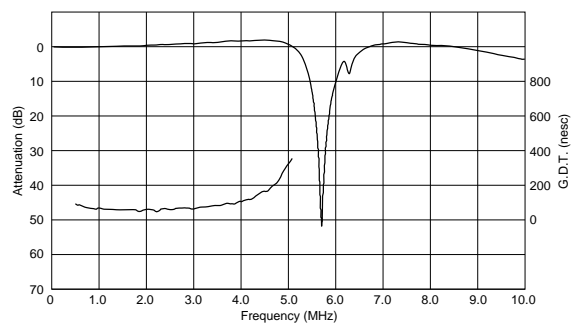

TPSRA6M00B00-B0

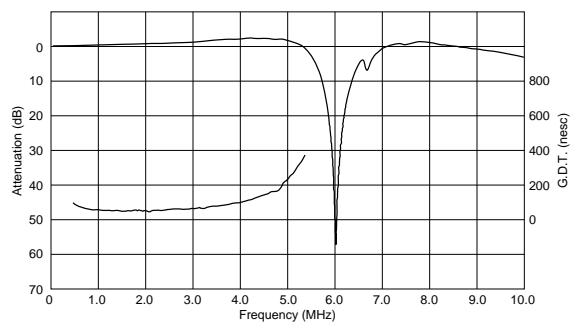

TPSRA6M50B00-B0

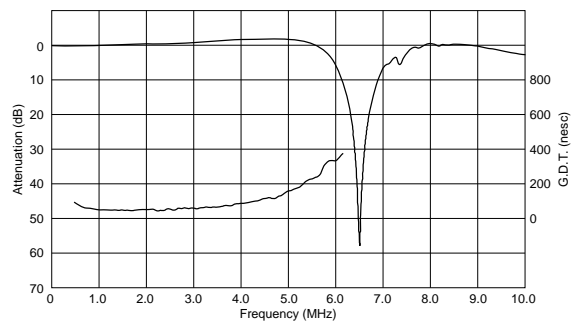



# CERAFIL® (Filters/Traps/Discriminators) for Audio/Visual Equipment



## Ceramic Trap 3.5-6.5MHz Two Lead Type TPSRF\_J Series

Ceramic Trap TPSRF\_J series is two-terminals type, recommended for the attenuation of sound IF in B/W TVs and the attenuation of chroma signal in Video Camcorders. As part of the environment protection activity, solder for terminal plating and terminal-element connection inside of ceramic filter contain no lead (Pb).

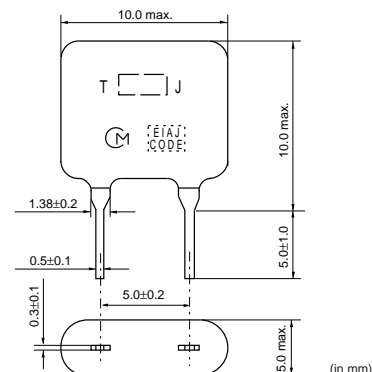

### ■ Features

1. Small-size, lightweight
2. High performance, durability
3. Easy to design due to two-terminals type

Part Number	Nominal Center Frequency (fn1) (MHz)	Attenuation (at fn1) (dB)	30dB Attenuation BW (fn1) (kHz)
TPSRF3M58J00-B0	3.580	20 min.	20 min. [20dB Att. BW]
TPSRF4M43J00-B0	4.430	20 min.	40 min. [20dB Att. BW]
TPSRF4M50J00-B0	4.500	20 min.	30 min. [20dB Att. BW]
TPSRF5M50J00-B0	5.500	20 min.	30 min. [20dB Att. BW]
TPSRF5M74J00-B0	5.742	20 min.	30 min. [20dB Att. BW]
TPSRF6M00J00-B0	6.000	20 min.	40 min. [20dB Att. BW]
TPSRF6M50J00-B0	6.500	20 min.	40 min. [20dB Att. BW]

For safety purposes, connect the output of filters to the IF amplifier through a D.C. blocking capacitor. Avoid applying a direct current to the output of ceramic filters. The order quantity should be an integral multiple of the "Minimum Quantity" shown in the package page.

### ■ Test Circuit

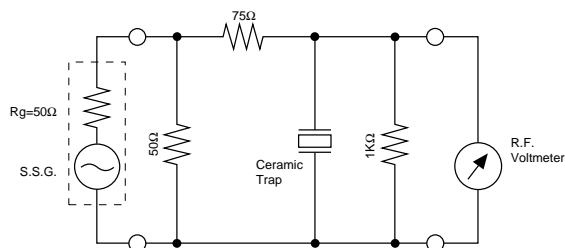

## Frequency Characteristics

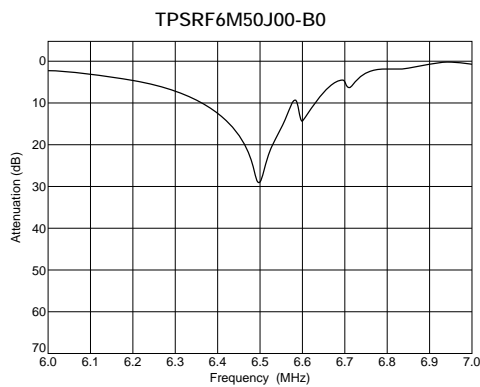
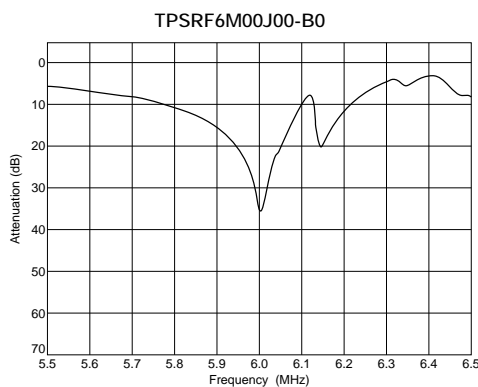
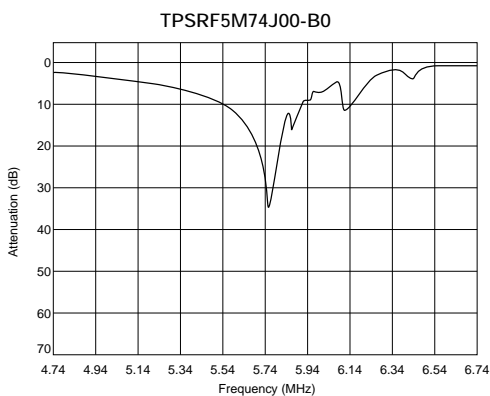
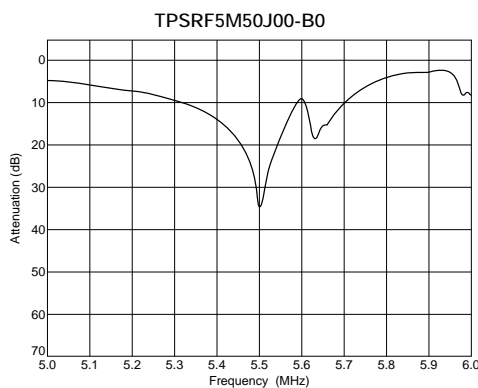
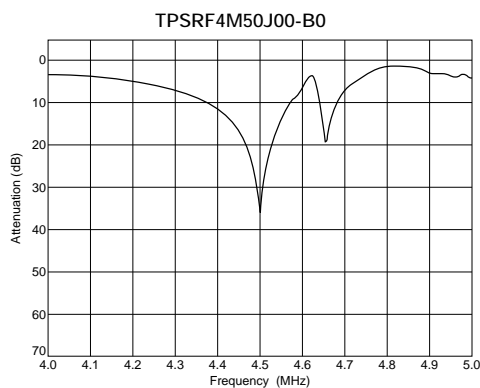
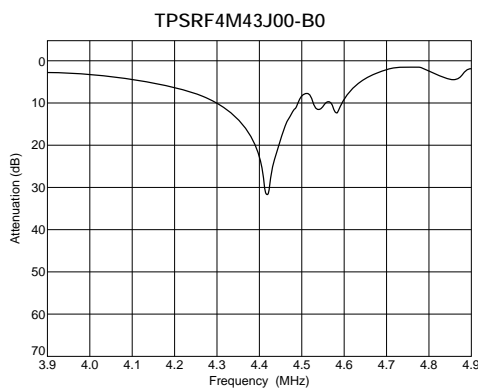
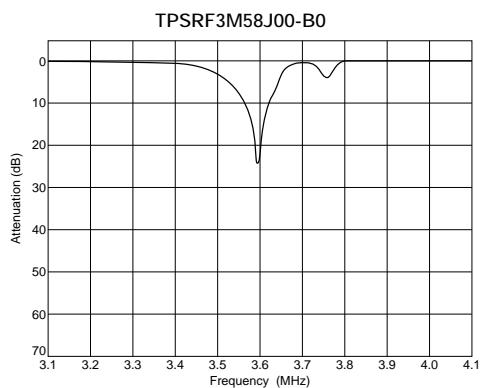

## Frequency Characteristics (Spurious)

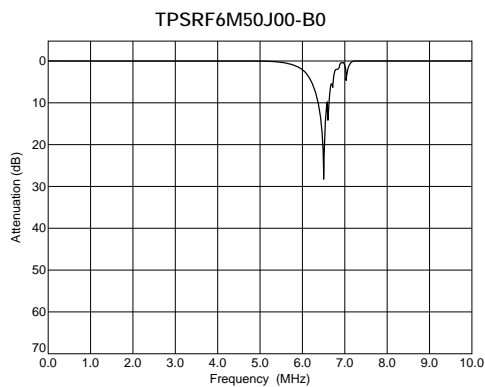
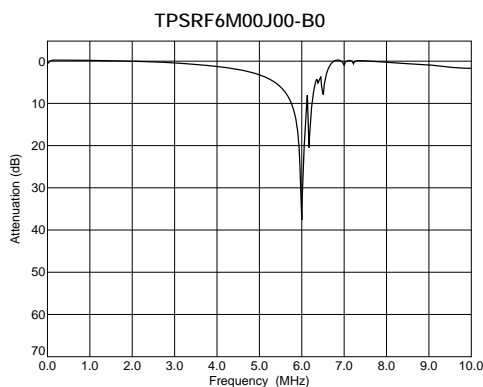
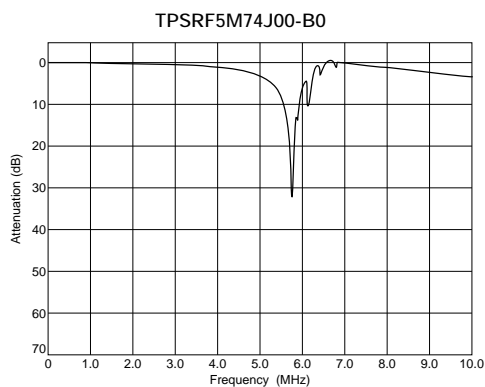
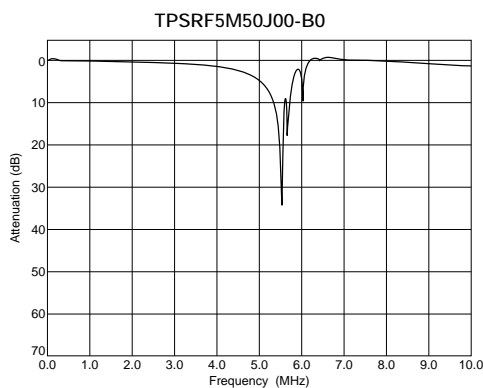
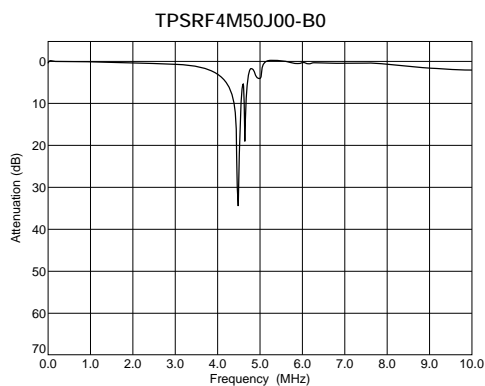
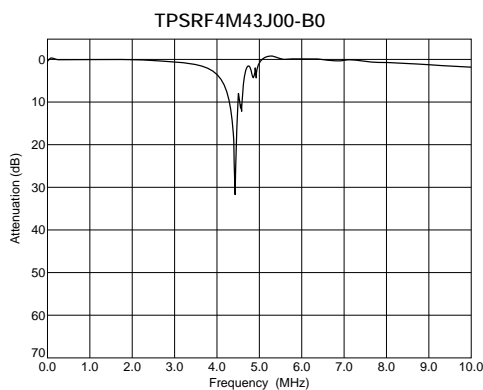
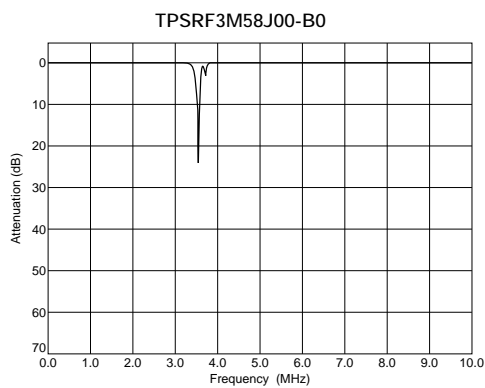

# CERAFIL® (Filters/Traps/Discriminators) for Audio/Visual Equipment



## Ceramic Trap 3.5-6.5MHz for 2ch Sound TV in Germany TPSRF\_W Series

Ceramic trap TPSRF\_W series has same structure as TPSRF\_B series. But they can trap two individual frequencies at one time. Recommended for two channel multi-sound TV systems.

As part of the environment protection activity, solder for terminal plating and terminal-element connection inside of ceramic filter contain no lead (Pb).

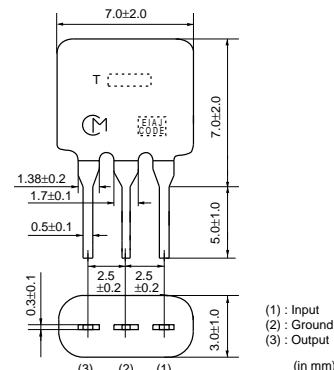

### ■ Features

1. Space saving
2. Three-terminals type

Part Number	Nominal Center Frequency (fn1) (MHz)	Nominal Center Frequency (fn2) (MHz)	Attenuation (at fn1) (dB)	Attenuation (at fn2) (dB)	30dB Attenuation BW (fn1) (kHz)
<b>TPSRF5M50W00-B0</b>	5.500	5.742	32 min.	25 min.	70 min.

For safety purposes, connect the output of filters to the IF amplifier through a D.C. blocking capacitor. Avoid applying a direct current to the output of ceramic filters. The order quantity should be an integral multiple of the "Minimum Quantity" shown in the package page.

### ■ Test Circuit

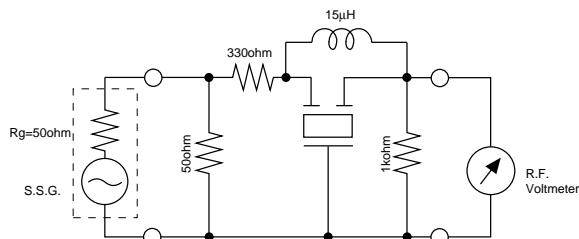

23

### ■ Frequency Characteristics

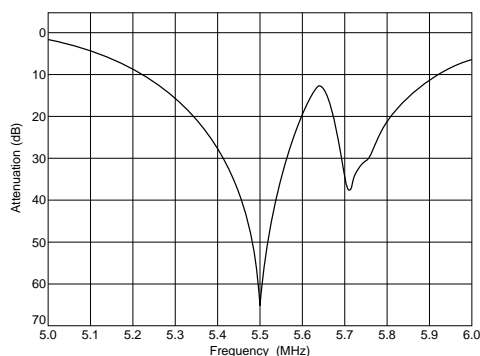

### ■ Frequency Characteristics (Spurious)

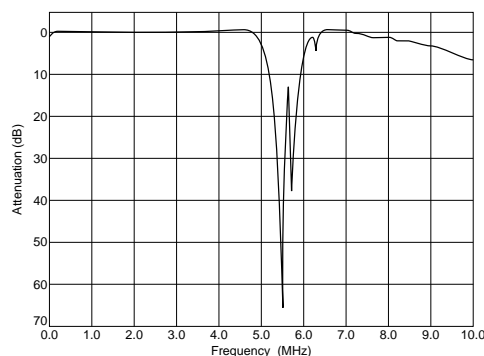

# CERAFIL® (Filters/Traps/Discriminators) for Audio/Visual Equipment



## Ceramic Trap 3.5-6.5MHz Double Traps TPWRF Series

Ceramic trap TPWRF\_B series consist of two wafers with two trap frequencies. Recommended for dual-standard sets.

As part of the environment protection activity, solder for terminal plating and terminal-element connection inside of ceramic filter contain no lead (Pb).

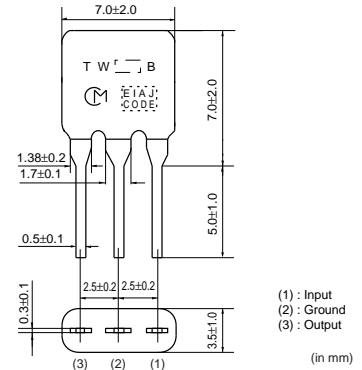

### ■ Features

1. Good performance of attenuation
2. Small and thin package
3. Three-terminals type

Part Number	Nominal Center Frequency (fn1) (MHz)	Nominal Center Frequency (fn2) (MHz)	Attenuation (at fn1) (dB)	Attenuation (at fn2) (dB)	30dB Attenuation BW (fn1) (kHz)
TPWRF4M50B05-B0	4.500	6.000	30 min.	30 min.	50 min.
TPWRF4M50B06-B0	4.500	4.850	30 min.	30 min.	50 min.
TPWRF4M50B10-B0	4.500	4.724	30 min.	30 min.	50 min.
TPWRF4M50B11-B0	4.500	5.500	30 min.	30 min.	50 min.
TPWRF5M50B02-B0	5.500	6.500	30 min.	30 min.	50 min.
TPWRF5M50B03-B0	5.500	6.000	30 min.	30 min.	50 min.
TPWRF5M50B04-B0	5.500	5.742	30 min.	30 min.	50 min.
TPWRF5M50B07-B0	5.500	5.850	30 min.	30 min.	50 min.
TPWRF6M00B01-B0	6.000	6.500	30 min.	30 min.	70 min.

For safety purposes, connect the output of filters to the IF amplifier through a D.C. blocking capacitor. Avoid applying a direct current to the output of ceramic filters. The order quantity should be an integral multiple of the "Minimum Quantity" shown in the package page.

### ■ Test Circuit

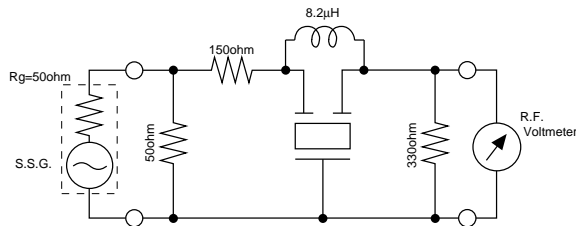

## ■ Frequency Characteristics

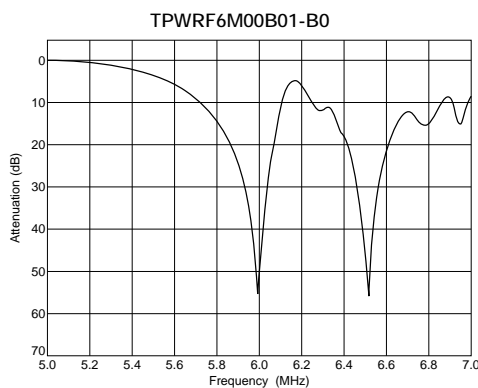
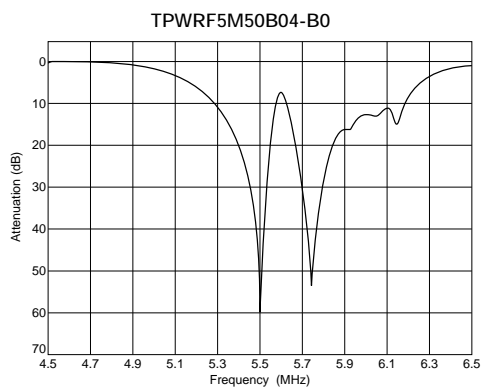
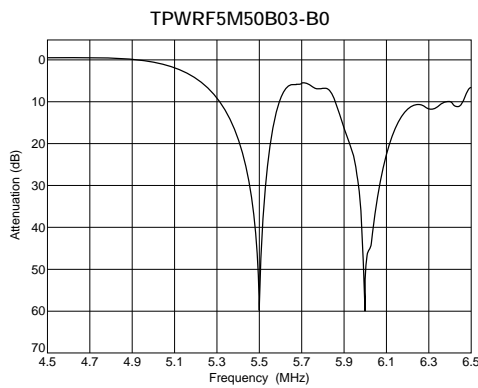
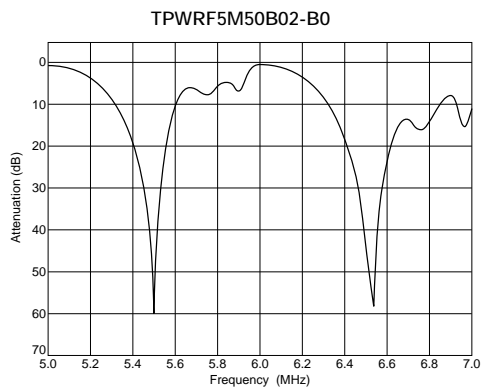

## ■ Frequency Characteristics (Spurious)

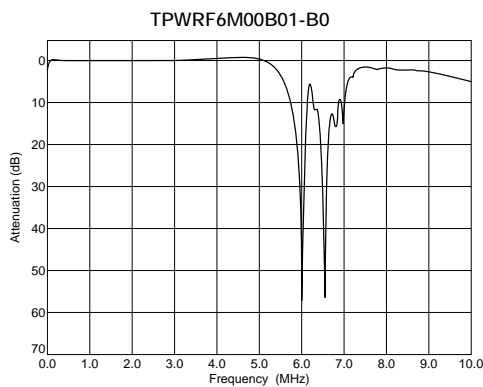
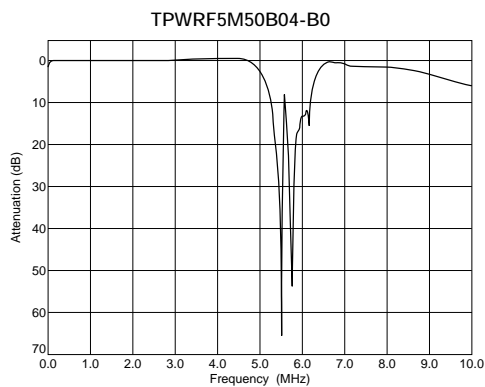
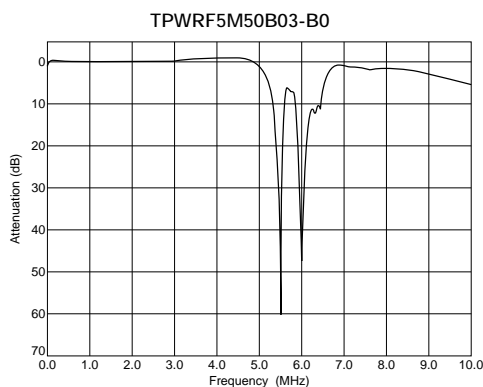
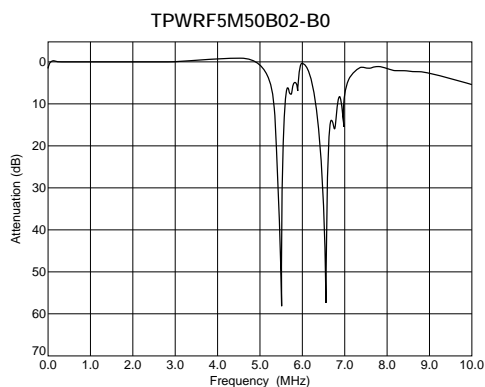

# CERAFIL® (Filters/Traps/Discriminators) for Audio/Visual Equipment



## Ceramic Trap 3.5-6.5MHz Triple Traps TPTRF Series

Ceramic trap TPTRF\_B series consist of 3 wafers with 3 trap frequencies. Recommended for multi-standard sets.

As part of the environment protection activity, solder for terminal plating and terminal-element connection inside of ceramic filter contain no lead (Pb).

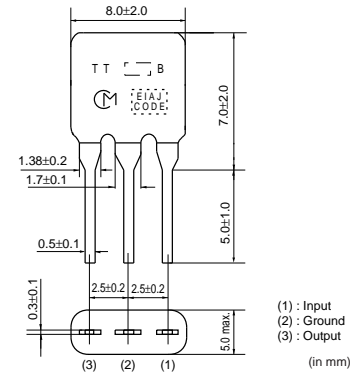

### ■ Features

1. Good performance of attenuation
2. Space saving for multi-set
3. Three-terminals type

Part Number	Nominal Center Frequency (fn1) (MHz)	Nominal Center Frequency (fn2) (MHz)	Nominal Center Frequency (fn3) (MHz)	Attenuation (at fn1) (dB)	Attenuation (at fn2) (dB)	Attenuation (at fn3) (dB)	30dB Attenuation BW (fn1) (kHz)
TPTRF5M50B01-B0	5.500	6.000	6.500	30 min.	30 min.	30 min.	50 min.
TPTRF5M50B02-B0	5.500	5.742	6.500	30 min.	30 min.	30 min.	50 min.
TPTRF5M50B04-B0	5.500	5.742	6.000	30 min.	30 min.	30 min.	50 min.

For safety purposes, connect the output of filters to the IF amplifier through a D.C. blocking capacitor. Avoid applying a direct current to the output of ceramic filters. The order quantity should be an integral multiple of the "Minimum Quantity" shown in the package page.

### ■ Test Circuit

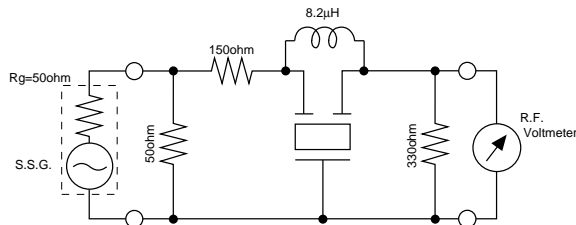

### ■ Frequency Characteristics

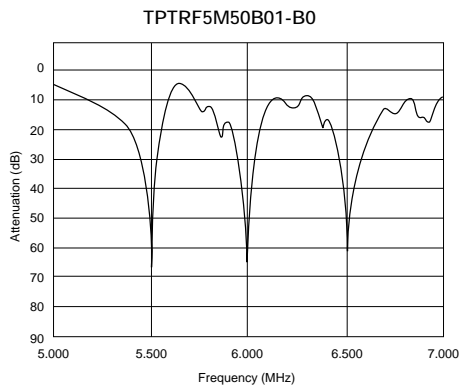

### ■ Frequency Characteristics (Spurious)

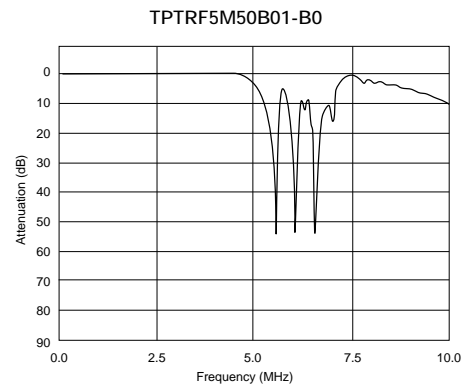

# CERAFIL® (Filters/Traps/Discriminators) for Audio/Visual Equipment



## Ceramic Discriminator 10.7MHz Ultra Thin Chip Type CDSCB Series

CDSCB10M7 series forms a resonator on a piezoelectric ceramic substrate. In combination with ICs, this type obtains stable demodulation characteristics in a wide bandwidth.  
 They have 1.0mm max. thickness and small mounting area (4.5x2.0mm).

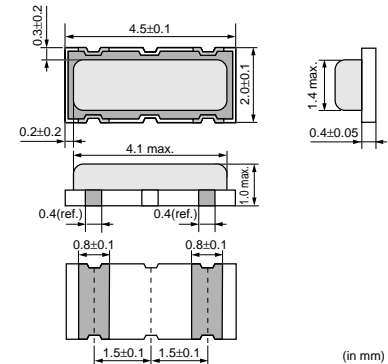

### ■ Features

1. Compact and high reliability and recommended for automotive applications.
2. Can be combined with various ICs. The IC is determined by the last number in the part number.
3. Stable demodulation characteristics can be obtained without adjustment.
4. Stable temperature characteristics
5. Available lead (Pb) free solder reflow.

Part Number	Center Frequency (fo) (MHz)	Recovered Audio 3dB BW (kHz)	Recovered Audio Output (mV)	Distortion (%)	S Curve (mV)	IC
CDSCB10M7GA105A-R0	10.700 ±30kHz	220 min.	110 min.	1.5 max.	-	TEA5757HL
CDSCB10M7GA113-R0	10.700 ±30kHz	300 min.	110 min.	1.0 max.	-	TA2154FN
CDSCB10M7GA119-R0	10.700 ±30kHz	500 min.	75 min.	1.0 max.	-	TRF6901
CDSCB10M7GA121-R0	10.700 ±30kHz	390 min.	80 min.	1.0 max.	-	LV23100V
CDSCB10M7GA135-R0	10.700 ±30kHz	155 min.	75 min.	-	-	TH71101
CDSCB10M7GA136-R0	10.700 ±30kHz	140 min.	120 min.	-	-	TH7122
CDSCB10M7GF072-R0	10.700 (fn)	fn±150 min.	130 min.	2.0 max.	-	TA31161
CDSCB10M7GF107S-R0	10.700 (fn)	fn±80 min.	52 min.	3.0 max.	-	TA31272FN
CDSCB10M7GF109-R0	10.700 (fn)	fn±100 min.	170 min.	3.0 max.	-	TK14588V
CDSCB10M7GF123-R0	10.700 (fn)	-	-	-	900 min.	TA31275FN
CDSCB10M7GF123S-R0	10.700 (fn)	-	-	-	900 min.	TA31275FN
CDSCB10M7GF126-R0	10.700 (fn)	-	-	-	400 min.	NJM2295AV

(fn) means nominal center frequency (10.700MHz).

For safety purposes, avoid applying a direct current between the terminals.

The order quantity should be an integral multiple of the "Minimum Quantity" shown in the package page.

### ■ Standard Center Frequency Rank Code

CODE	30kHz Step	25kHz Step
D	10.64MHz±30kHz	10.650MHz±25kHz
B	10.67MHz±30kHz	10.675MHz±25kHz
A	10.70MHz±30kHz	10.700MHz±25kHz
C	10.73MHz±30kHz	10.725MHz±25kHz
E	10.76MHz±30kHz	10.750MHz±25kHz
Z	Combination A, B, C, D, E	
M	Combination A, B, C	

Continued on the following page. ↗



Continued from the preceding page.

### Standard Land Pattern Dimensions

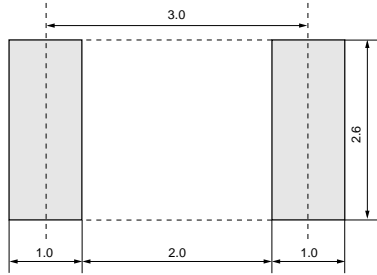

(in mm)

### Test Circuit

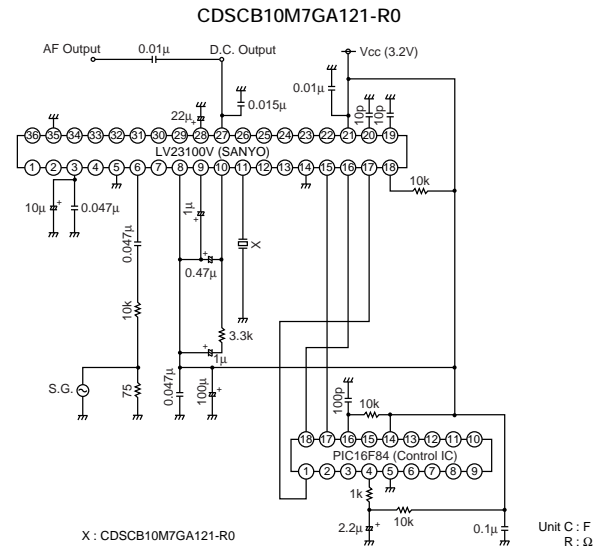
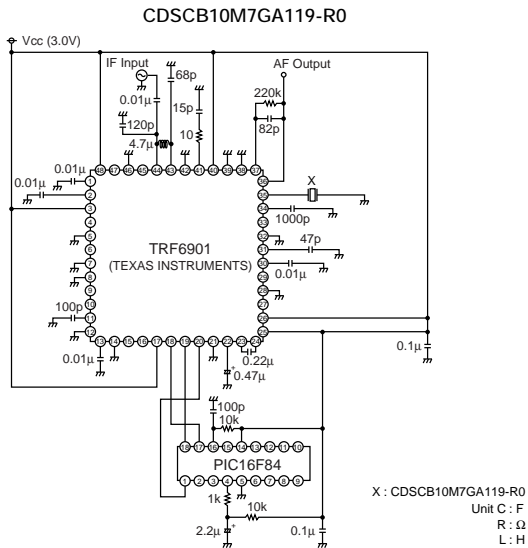
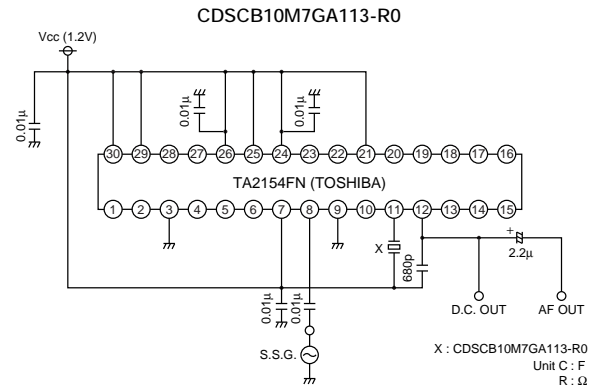
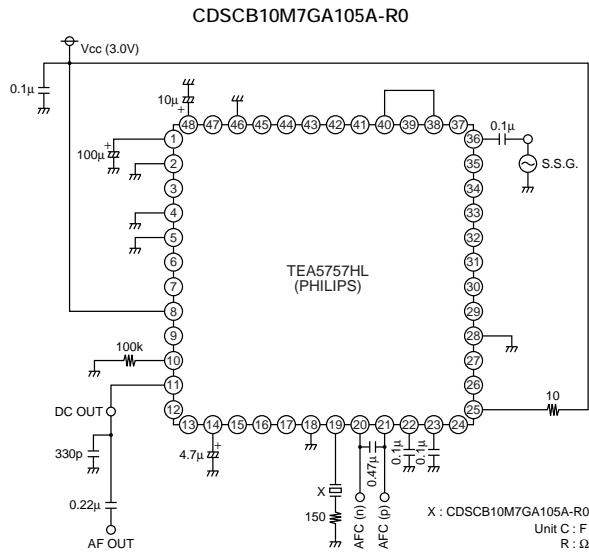

Continued on the following page. ↗



■ Recovered Audio Curve

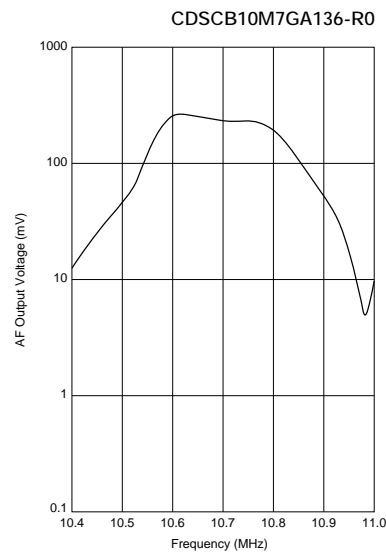
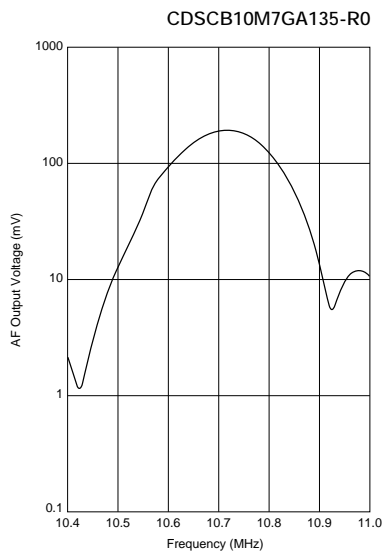
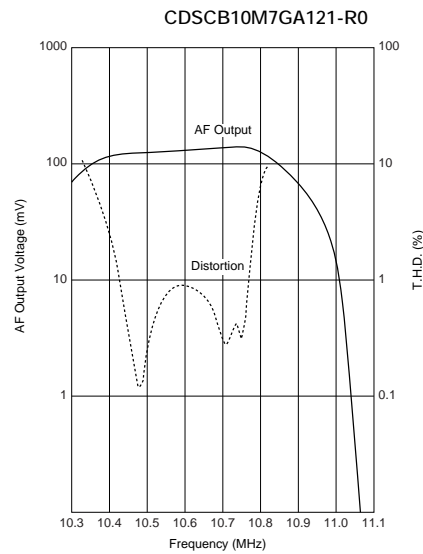
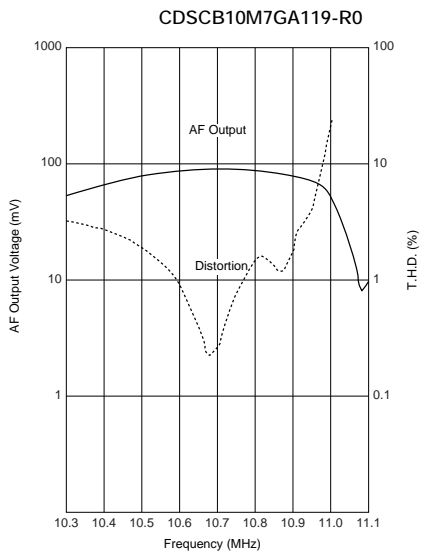
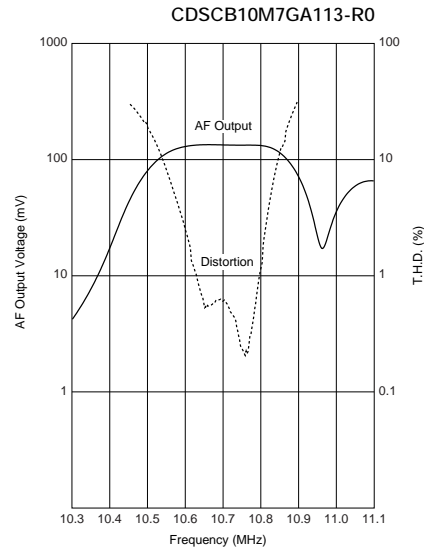
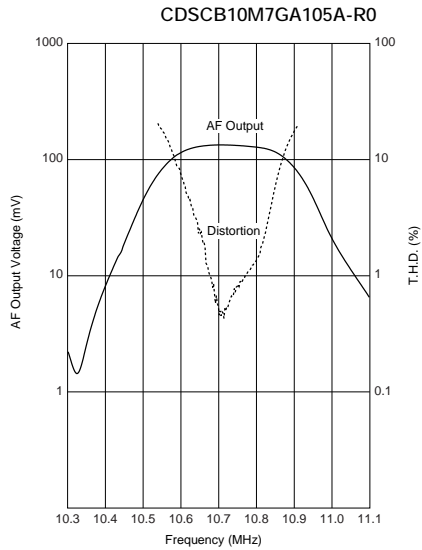

Continued from the preceding page.

■ Recovered Audio Curve

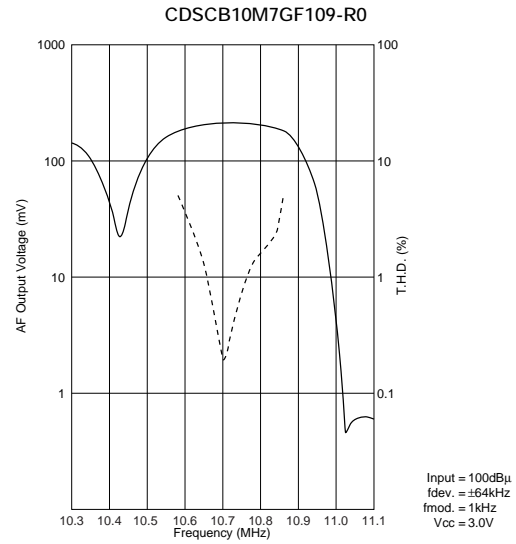
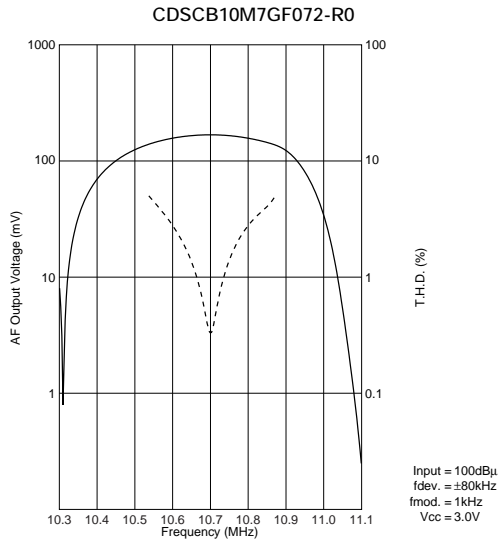

■ S Curve

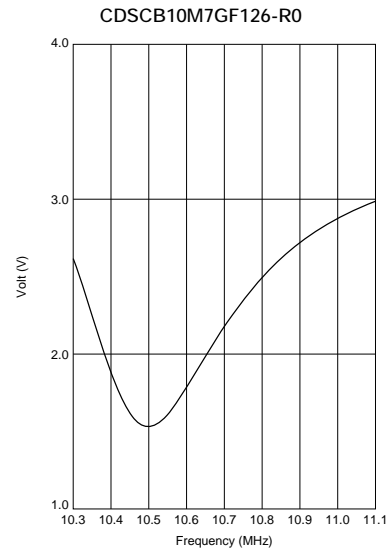
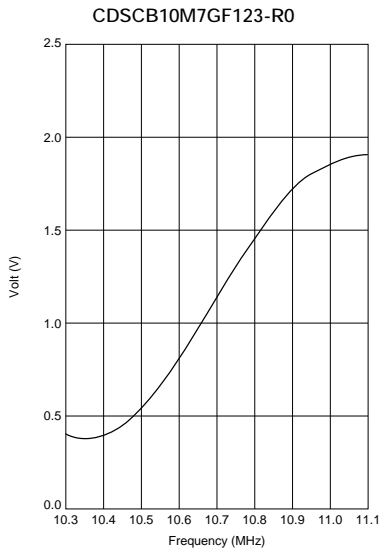

# CERAFIL® (Filters/Traps/Discriminators) for Audio/Visual Equipment



## Ceramic Discriminator 10.7MHz Standard Lead Type CDALF Series

CDALF10M7 series forms a resonator on a piezoelectric ceramic substrate. In combination with ICs, this type obtains stable demodulation characteristics in wide bandwidths.

As part of the environment protection activity, solder for terminal plating and terminal-element connection inside of ceramic filter contain no lead (Pb).

### ■ Features

1. Compact and excellent mechanical strength
2. Can be combined with various ICs. The IC is determined by the last number in the part number.
3. Stable demodulation characteristics can be obtained without adjustment.
4. Stable temperature characteristics
5. Recommended combination: ceramic discriminator CDALF10M7 series and "CERAFIL" SFELF10M7 Series of the same frequency rank.

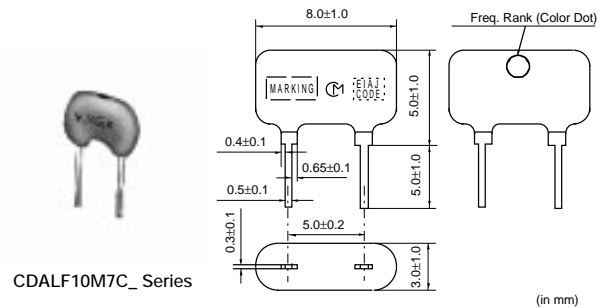
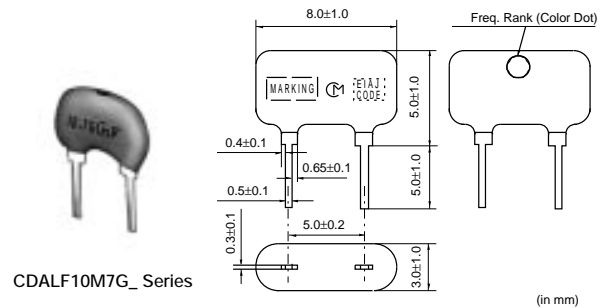

Part Number	Center Frequency (fo) (MHz)	Recovered Audio 3dB BW (kHz)	Recovered Audio Output (mV)	Distortion (%)	S Curve	IC
CDALF10M7GA016-B0	10.700 ±30kHz	300 min.	within60 to 90mV	0.9 max.	-	TA8122F
CDALF10M7GA018-B0	10.700 ±30kHz	300 min.	within60 to 90mV	0.9 max.	-	TA8132N
CDALF10M7GA046-B0	10.700 ±30kHz	330 min.	280 min.	1.0 max.	-	LA1832
CDALF10M7GA048-B0	10.700 ±30kHz	400 min.	700 min.	1.0 max.	-	LA1835
CDALF10M7GA092-B0	10.700 ±30kHz	300 min.	60 min.	1.0 max.	-	TA2132P
CDALF10M7CA005A-B0	10.700 ±30kHz	100 min.	600 min.	6.0 max.	-	LA7770
CDALF10M7CA040-B0	10.700 ±30kHz	130 min.	40 min.	0.7 max.	-	TEA5710

For safety purposes, avoid applying a direct current between the terminals.  
 The order quantity should be an integral multiple of the "Minimum Quantity" shown in the package page.  
 CDALF10M7GA018-B0: Color dot is different from standard series.

### ■ Standard Center Frequency Rank Code

CODE	30kHz Step	25kHz Step	Color Code
D	10.64MHz±30kHz	10.650MHz±25kHz	Black
B	10.67MHz±30kHz	10.675MHz±25kHz	Blue
A	10.70MHz±30kHz	10.700MHz±25kHz	Red
C	10.73MHz±30kHz	10.725MHz±25kHz	Orange
E	10.76MHz±30kHz	10.750MHz±25kHz	White
Z	Combination A, B, C, D, E		
M	Combination A, B, C		

■ Test Circuit

CDALF10M7GA016-B0

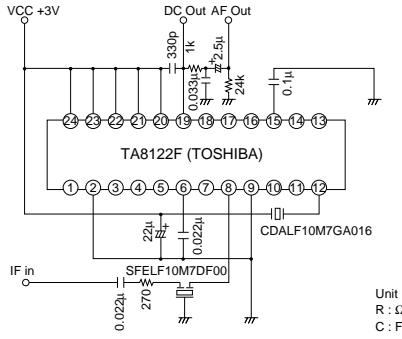

Unit  
R : Ω  
C : F

CDALF10M7GA018-B0

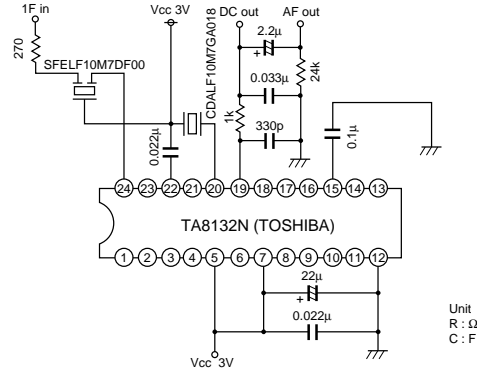

Unit  
R : Ω  
C : F

CDALF10M7GA046-B0

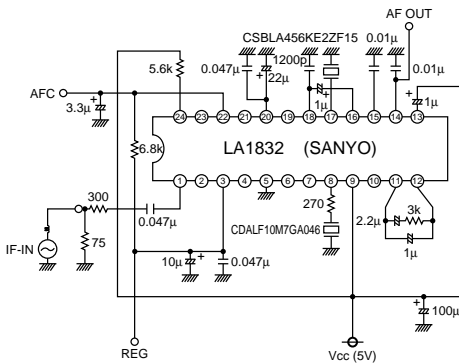

Unit  
R : Ω  
C : F

CDALF10M7GA048-B0

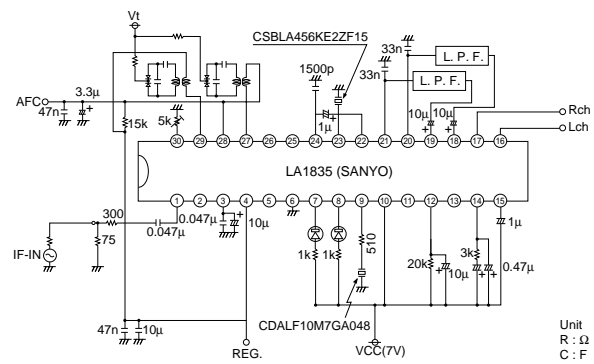

Unit  
R : Ω  
C : F

CDALF10M7GA092-B0

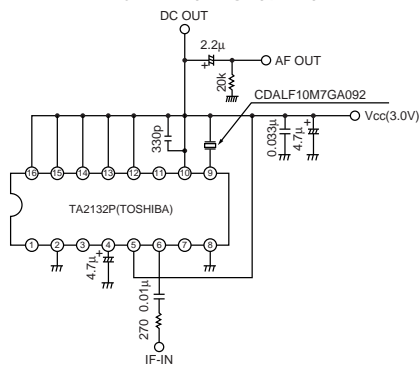

Unit  
R : Ω  
C : F

CDALF10M7CA005A-B0

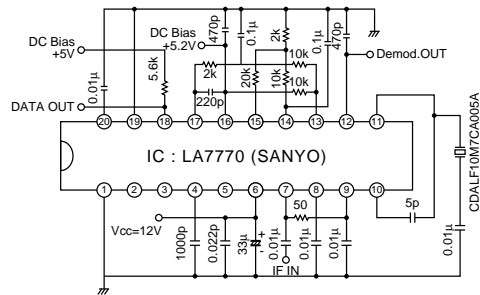

Unit  
R : Ω  
C : F

CDALF10M7CA040-B0

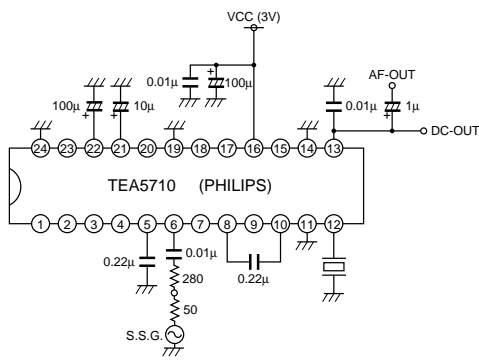

Unit  
R : Ω  
C : F

## Frequency Characteristics

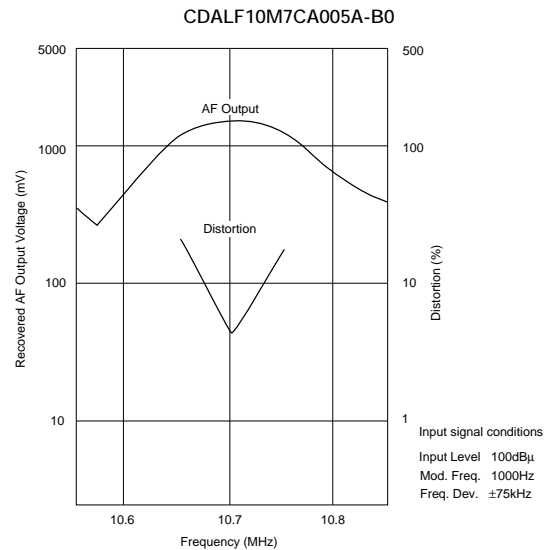
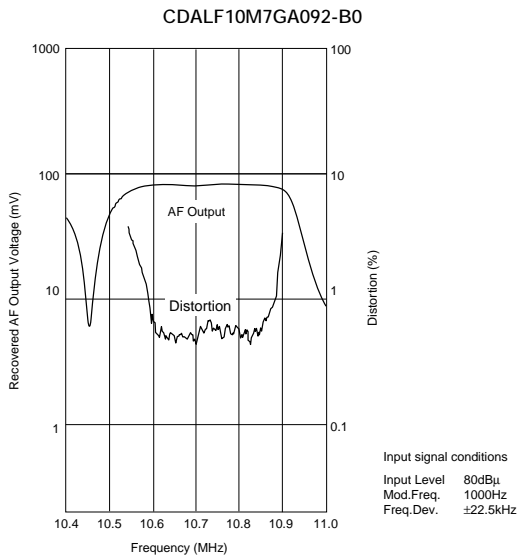
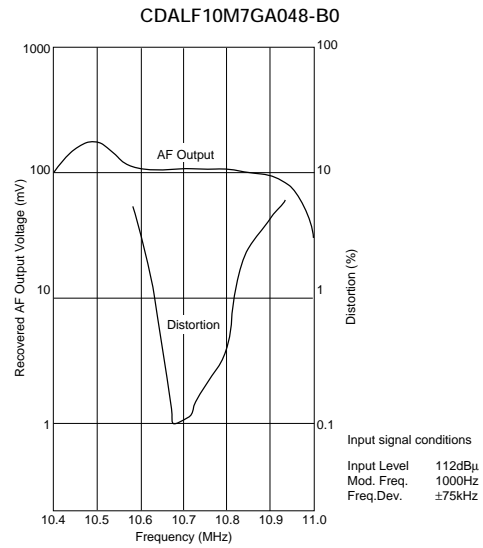
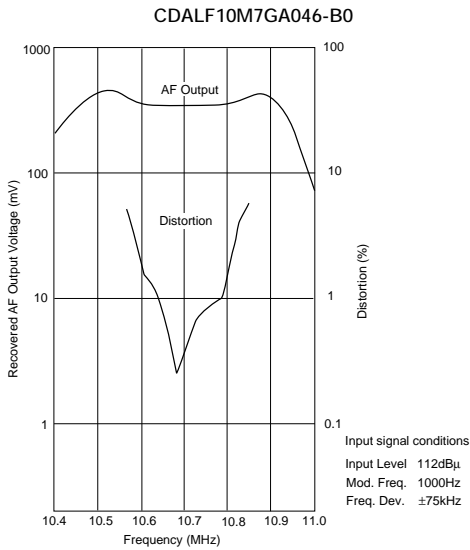
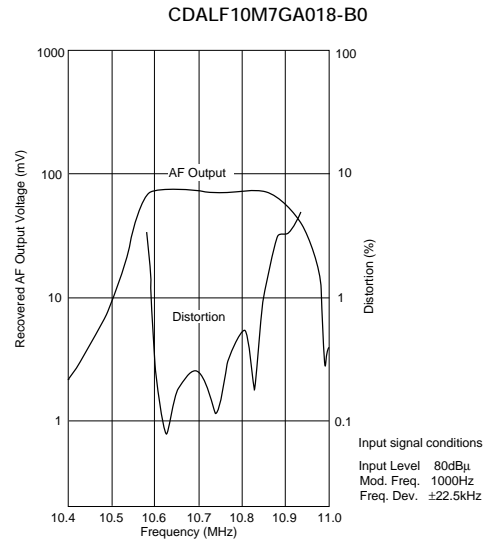
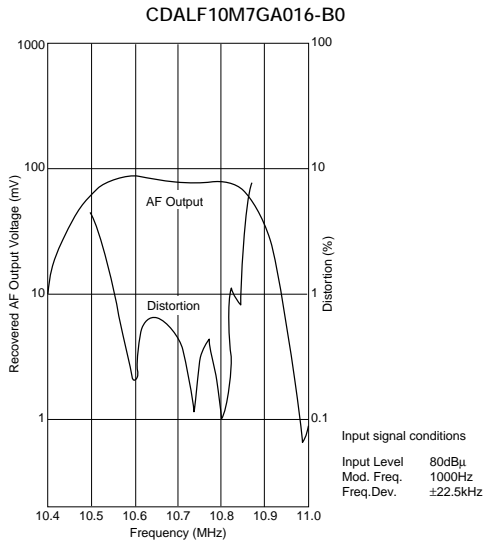

Continued from the preceding page.

## Frequency Characteristics

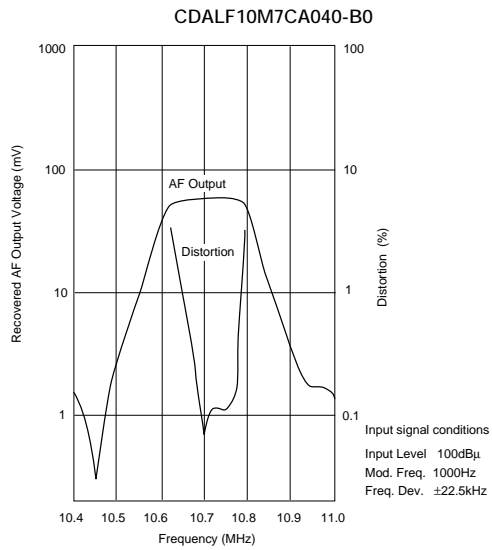



## Ceramic Discriminator 10.7MHz Applied IC Reference Table

Please see following table for reference applied IC.  
 If you cannot find IC part number you are seeking, please contact our sales representative.

ex. : CDALF10M7GA016-B0

Suffix Number

CDSCB10M7GA105A-R0

Suffix Number

IC Manufacturer	IC Part Number	Suffix Number
ATMEL	U2501B	<b>028</b>
	U2765B	<b>095</b>
	U4313B	<b>081</b>
	U4490B	<b>034V</b>
	U829B	<b>025</b>
INFINEON	TDA1576T	<b>051</b>
	TDA6160X	<b>038</b>
	TDA6160-2X	<b>044</b>
MATSUSHITA	AN6138SH	<b>097</b>
	AN7004	<b>011</b>
	AN7006S	<b>014A</b>
	AN7007SU	<b>013</b>
MOTOROLA	AN7232	<b>053</b>
	MC13156	<b>049</b>
	MC13158	<b>073</b>
	MC13173	<b>052</b>
NEC	MC3363	<b>087</b>
	μPC1391M	<b>056</b>
PHILIPS	NE604	<b>020</b>
	SA605	<b>042</b>
	SA626	<b>047</b>
	SA636DK	<b>096</b>
	SA639	<b>085</b>
	TBA120U	<b>029</b>
	TBA229-2	<b>021A</b>
	TDA1596T	<b>120</b>
	TDA2557	<b>024</b>
	TEA5591	<b>017</b>
	TEA5592	<b>030</b>
	TEA5594	<b>035</b>
	TEA5710	<b>040</b>
	TEA5712T	<b>055</b>
	TEA5757HL	<b>105A</b>
	TEA5762 / 5757	<b>061</b>
	UAA3220TS	<b>098</b>
RFMD	RF2905	<b>111</b>
	RF2925	<b>104</b>
ROHM	BA1440	<b>019</b>
	BA1448	<b>060</b>
	BA4110	<b>066</b>
	BA4220	<b>041</b>
	BA4230AF	<b>005</b>
	BA4234L	<b>004</b>
	BA4240L	<b>067</b>

IC Manufacturer	IC Part Number	Suffix Number
SAMSUNG	KA22425	<b>089</b>
	KA2244	<b>059</b>
	KA22901	<b>090</b>
	KA2292	<b>063</b>
	KA2295	<b>064</b>
	KA2297	<b>091</b>
	KA2298B	<b>065</b>
	KB22902	<b>103</b>
	S1A0903	<b>118A</b>
	SANYO	LA1150
LA1225M		<b>108A</b>
LA1260		<b>007</b>
LA1805		<b>026</b>
LA1810		<b>022</b>
LA1814M		<b>115</b>
LA1816		<b>015</b>
LA1822		<b>094</b>
LA1823		<b>101</b>
LA1827M		<b>083</b>
LA1830		<b>037</b>
LA1831		<b>043</b>
LA1832 / M		<b>046</b>
LA1833		<b>086</b>
LA1835 / M		<b>048</b>
LA1838 / M	<b>079</b>	
LA7770	<b>023</b>	
LV23000M	<b>114</b>	
LV23100V	<b>121</b>	
SONY	CX1691M	<b>078</b>
	CX-20029	<b>001</b>
	CX-20076	<b>002</b>
	CXA1030P	<b>012</b>
	CXA1111	<b>093</b>
	CXA1238	<b>027</b>
	CXA1238N	<b>027N</b>
	CX1343M	<b>032</b>
	CXA1376AM	<b>054</b>
	CXA1538M / N / S	<b>069</b>
CXA1611	<b>075</b>	
CXA1619B	<b>117</b>	
CXA1991N	<b>068</b>	
CX3067M	<b>076</b>	
T. I.	TRF6901	<b>119</b>

Continued on the following page.

## Ceramic Discriminator 10.7MHz Applied IC Reference Table

Continued from the preceding page.

IC Manufacturer	IC Part Number	Suffix Number
TOKO	TK14570L	<b>122</b>
	TK14581	<b>062</b>
	TK14583V	<b>112</b>
	TK14588V	<b>109</b>
TOSHIBA	TA2003	<b>031</b>
	TA2007	<b>033</b>
	TA2008A / AN	<b>045</b>
	TA2022	<b>050</b>
	TA2029	<b>036</b>
	TA2046	<b>058</b>
	TA2057	<b>057</b>
	TA2099N	<b>082</b>
	TA2104AFN	<b>080</b>
	TA2104F	<b>080A</b>
	TA2111N / F / FN	<b>077</b>
	TA2132	<b>092</b>
	TA2132BP	<b>092D</b>
	TA2142FN	<b>102</b>
	TA2149AN	<b>100A</b>
	TA2149N	<b>100</b>
	TA2154FN	<b>113</b>
	TA2159F	<b>116</b>
	TA31161	<b>072</b>
	TA31275FN	<b>123</b>
	TA7130P	<b>009</b>
	TA7303P	<b>008</b>
	TA7640AP	<b>006</b>
	TA7765AF	<b>071</b>
	TA8122AN / AF	<b>016</b>
	TA8132AN / AF	<b>018</b>
TA8186	<b>039</b>	
TA8721ASN	<b>088</b>	
TB2132FN	<b>128</b>	

## Notice (Soldering and Mounting)

### ■ CERAFIL® 10.7MHz Chip Type SFECF Series

#### 1. Standard Reflow Soldering Conditions

##### (1) Reflow

Filter is soldered twice within the following temperature conditions.

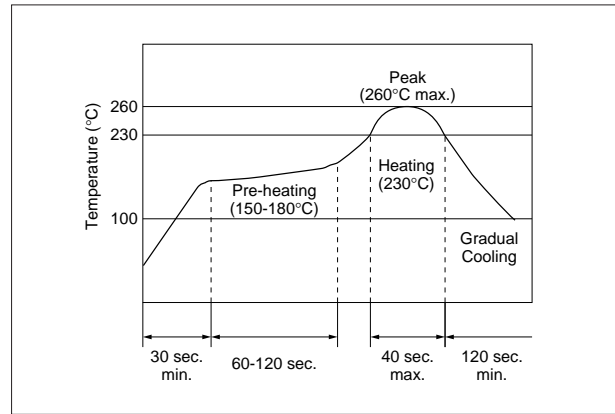

##### (2) Soldering Iron

Filter is soldered at  $+350\pm 5^{\circ}\text{C}$  for  $3.0\pm 0.5$  seconds. The soldering iron should not touch the filter while soldering.

#### 2. Wash

The component cannot withstand washing.

### ■ CERAFIL® 10.7MHz Chip Type SFECV Series

#### 1. Standard Reflow Soldering Conditions

##### (1) Reflow

Filter is soldered twice within the following temperature conditions.

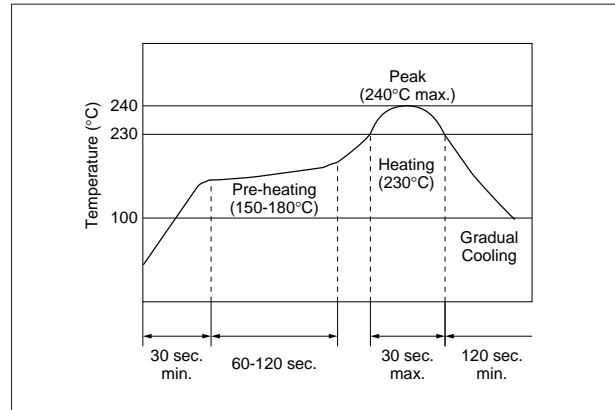

##### (2) Soldering Iron

Filter is soldered at  $+350\pm 5^{\circ}\text{C}$  for  $3.0\pm 0.5$  seconds. The soldering iron should not touch the filter while soldering.

#### 2. Wash

The component cannot withstand washing.

### ■ CERAFIL® 10.7MHz Lead Type

The component cannot withstand washing.

## Notice (Soldering and Mounting)

### ■ CERAFIL® 4.5-6.5MHz Chip Type

#### 1. Standard Reflow Soldering Conditions

##### (1) Reflow

Filter is soldered twice within the following temperature conditions.

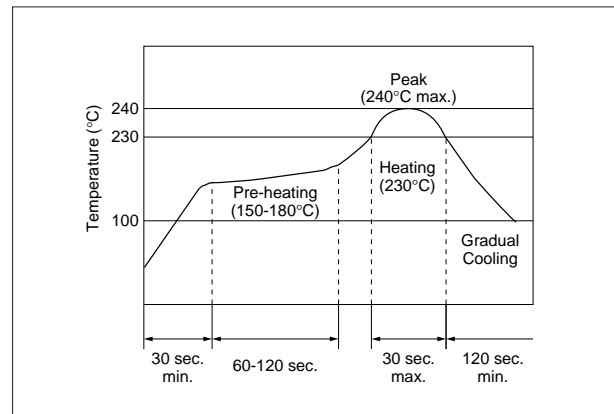

##### (2) Soldering Iron

Filter is soldered at  $+350\pm 5^{\circ}\text{C}$  for  $3.0\pm 0.5$  seconds. The soldering iron should not touch the filter while soldering.

#### 2. Wash

The component cannot withstand washing.

### ■ CERAFIL® 2.3-5.7MHz Chip Type SFSKB Series

#### 1. Standard Reflow Soldering Conditions

##### (1) Reflow

Filter is soldered twice within the following temperature conditions.

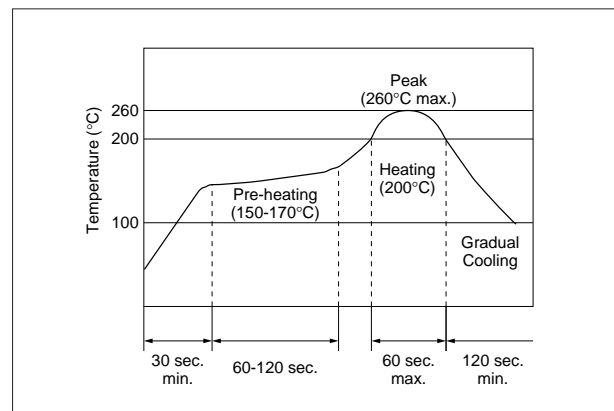

##### (2) Soldering Iron

Filter is soldered at  $+320\pm 5^{\circ}\text{C}$  for  $3.0\pm 0.5$  seconds. The soldering iron should not touch the filter while soldering.

#### 2. Wash

The component cannot withstand washing.

### ■ CERAFIL® 3.5-6.5MHz Lead Type

The component cannot withstand washing.

## Notice (Soldering and Mounting)

### ■ CERAFIL® 455kHz Chip Type SFPKA Series

#### 1. Standard Reflow Soldering Conditions

##### (1) Reflow

Filter is soldered twice within the following temperature conditions.

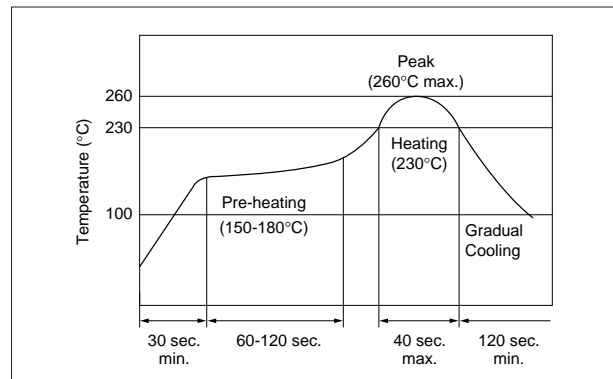

##### (2) Soldering Iron

Electrode is directly soldered with the tip of soldering iron at  $+350\pm 5^{\circ}\text{C}$  for  $3.0\pm 0.5$  seconds.

#### 2. Wash

##### (1) Cleaning Solvent

CFC alternatives (HCFC Series), Isopropyl Alcohol (IPA), Water (Demineralized Water), Cleaning Water Solution (Cleantrough-750H, Pine Alpha 100S), Silicon (Technocare FRW)

##### (2) Cleaning Conditions

- Immersion Wash  
2 minutes max. in above solvent at  $+60^{\circ}\text{C}$  max.
- Shower or Rinse Wash  
2 minutes max. in above solvent at  $+60^{\circ}\text{C}$  max.

##### (3) Notice

- When components are immersed in solvent, be sure to maintain the temperature of components below the temperature of solvent.
- Please do not use ultrasonic cleaning.
- Total washing time should be within 4 minutes.
- Please ensure the component is thoroughly evaluated in your application circuit.
- Please do not use chlorine, petroleum and alkaline cleaning solvents.
- If you plan to use any other type of solvents, please consult with Murata or Murata representative prior to using.

### ■ CERAFIL® 455kHz Lead Type

The component cannot withstand washing.

## Notice (Soldering and Mounting)

### ■ Ceramic Trap 4.5-6.5MHz Chip Type

#### 1. Standard Reflow Soldering Conditions

##### (1) Reflow

Filter is soldered twice within the following temperature conditions.

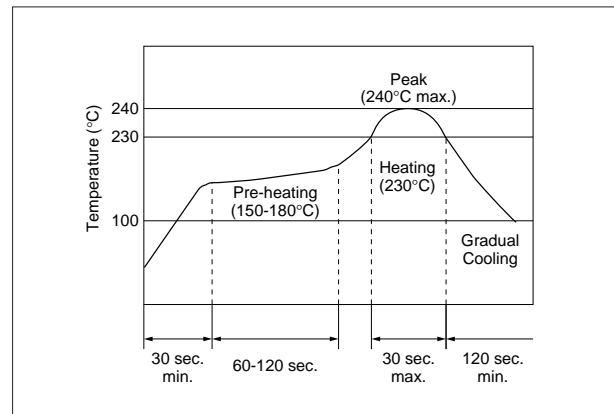

##### (2) Soldering Iron

Filter is soldered at  $+350\pm 5^{\circ}\text{C}$  for  $3.0\pm 0.5$  seconds. The soldering iron should not touch the filter while soldering.

#### 2. Wash

The component cannot withstand washing.

### ■ Ceramic Trap 3.5-6.5MHz Lead Type

The component cannot withstand washing.

### ■ Ceramic Discriminator 10.7MHz Chip Type

#### 1. Standard Reflow Soldering Conditions

##### (1) Reflow

Filter is soldered twice within the following temperature conditions.

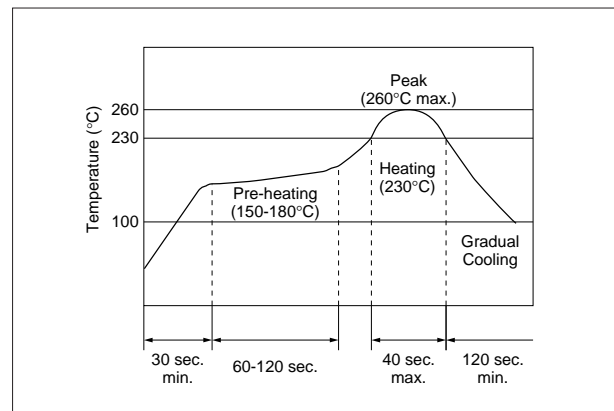

##### (2) Soldering Iron

Filter is soldered at  $+300\pm 5^{\circ}\text{C}$  for  $3.0\pm 0.5$  seconds. The soldering iron should not touch the filter while soldering.

#### 2. Wash

The component cannot withstand washing.

### ■ Ceramic Discriminator 10.7MHz Lead Type

The component cannot withstand washing.

### ■ Ceramic Discriminator 3.5-6.5MHz

The component cannot withstand washing.

## Notice (Handling)

### ■ CERAFIL® 10.7MHz Chip Type SFECF Series

1. The component will be damaged when an excessive stress is applied.
2. The component may be damaged if excess mechanical stress is applied to it mounted on the printed circuit board.
3. Design layout of components on the PC board to minimize the stress imposed on the warp or flexure of the board.
4. After installing chips, if solder is excessively applied to the circuit board, mechanical stress will cause destruction resistance characteristics to lower. To prevent this, be extremely careful in determining shape and dimension before designing the circuit board diagram.
5. The component may be damaged during mounting process if some part of mounter such as positioning claws or nozzle are worn down. The regular maintenance recommended for mounters should be done to prevent troubles.
6. The component is recommended with placement machines which employ optical placement capabilities. The component might be damaged by excessive mechanical force. Please make sure that you have evaluated by using placement machines before going into mass production. Do not use placement machines which utilize mechanical positioning. Please contact Murata for details beforehand.
7. When correcting chips with a soldering iron, the tip of the soldering iron should not directly touch the chip component. Depending on the soldering conditions, the effective area of terminations may be reduced. The use of solder containing Ag should be done to prevent the electrode erosion.
8. Do not clean or wash the component as it is not hermetically sealed.
9. In case of covering filter with over coat, conditions such as material of resin, cure temperature, and so on should be evaluated carefully.
10. Do not use strong acidity flux, more than 0.2wt% chlorine content, in re-flow soldering.
11. Accurate test circuit values are required to measure electrical characteristics.  
It may be a cause of miscorrelation if there is any deviation, especially stray capacitance, from the test circuit in the specification.
12. The components, packed in the moisture proof bag (dry pack), are sensitive to moisture. The following treatment is required before applying re-flow soldering. To avoid reliability degradation caused by thermal stress, when unpacked, store the component in an atmosphere at 30°C and below 60%R.H., and solder within 1 week.
13. For safety purposes, connect the output of filters to the IF amplifier through a D.C. blocking capacitor. Avoid applying a direct current to the output of ceramic filters.

[Component layout close to board]

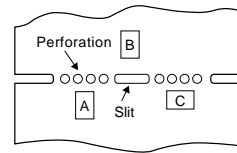

Susceptibility to stress is in the order of : A>C>B

Continued on the following page. 

## Notice (Handling)

☞ Continued from the preceding page.

### ■ CERAFIL® 10.7MHz Chip Type SFECV Series

1. The component will be damaged when an excessive stress is applied.
2. The component may be damaged if excess mechanical stress is applied to it mounted on the printed circuit board.
3. Design layout of components on the PC board to minimize the stress imposed on the warp or flexure of the board.
4. After installing chips, if solder is excessively applied to the circuit board, mechanical stress will cause destruction resistance characteristics to lower. To prevent this, be extremely careful in determining shape and dimension before designing the circuit board diagram.
5. The component may be damaged during mounting process if some part of mounter such as positioning claws or nozzle are worn down. The regular maintenance recommended for mounters should be done to prevent troubles.
6. The component is recommended with placement machines which employ optical placement capabilities. The component might be damaged by excessive mechanical force. Please make sure that you have evaluated by using placement machines before going into mass production. Do not use placement machines which utilize mechanical positioning. Please contact Murata for details beforehand.
7. When correcting chips with a soldering iron, the tip of the soldering iron should not directly touch the chip component. Depending on the soldering conditions, the effective area of terminations may be reduced. The use of solder containing Ag should be done to prevent the electrode erosion.
8. Do not clean or wash the component as it is not hermetically sealed.
9. In case of covering filter with over coat, conditions such as material of resin, cure temperature, and so on should be evaluated carefully.
10. Do not use strong acidity flux, more than 0.2wt% chlorine content, in re-flow soldering.
11. Accurate test circuit values are required to measure electrical characteristics. It may be a cause of mis-correlation if there is any deviation, especially stray capacitance, from the test circuit in the specification.
12. For safety purposes, connect the output of filters to the IF amplifier through a D.C. blocking capacitor. Avoid applying a direct current to the output of ceramic filters.

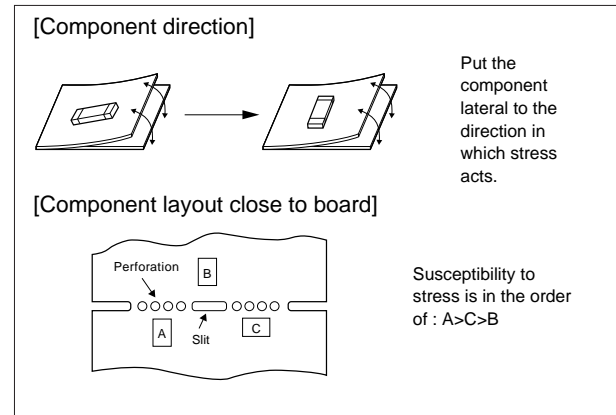



## Notice (Handling)

### ■ CERAFIL® 10.7MHz Lead Type

1. Do not use this product with bend. The component may be damaged if excess mechanical stress is applied to it mounted on the printed circuit board.
2. The component may be damaged when an excessive stress is applied.
3. All kinds of re-flow soldering must not be applied on the component.
4. Do not clean or wash the component as it is not hermetically sealed.
5. Do not use strong acidity flux, more than 0.2wt% chlorine content, in flow soldering.

### ■ CERAFIL® 4.5-6.5MHz Chip Type

1. The component may be damaged if excess mechanical stress is applied to it mounted on the printed circuit board.
2. Design layout of components on the PC board to minimize the stress imposed on the warp or flexure of the board.
3. After installing chips, if solder is excessively applied to the circuit board, mechanical stress will cause destruction resistance characteristics to lower. To prevent this, be extremely careful in determining shape and dimension before designing the circuit board diagram.
4. The component may be damaged during mounting process if some part of mounter such as positioning claws or nozzle are worn down. The regular maintenance recommended for mounters should be done to prevent troubles.
5. When correcting chips with a soldering iron, the tip of the soldering iron should not directly touch the chip component.
6. Cleaning or washing of the component is not acceptable due to non sealed construction.
7. In case of covering filter with over coat, conditions such as material of resin, cure temperature, and so on should be evaluated carefully.
8. Accurate test circuit values are required to measure electrical characteristics. It may be a cause of miscorrelation if there is any deviation, especially stray capacitance, from the test circuit in the specification.
9. For safety purposes, connect the output of filters to the IF amplifier through a D.C. blocking capacitor. Avoid applying a direct current to the output of ceramic filters.

6. In case of covering discriminator with over coat, conditions such as material of resin, cure temperature, and so on should be evaluated carefully.
7. Accurate test circuit values are required to measure electrical characteristics. It may be a cause of miscorrelation if there is any deviation, especially stray capacitance, from the test circuit in the specification.
8. For safety purposes, avoid applying a direct current between the terminals.

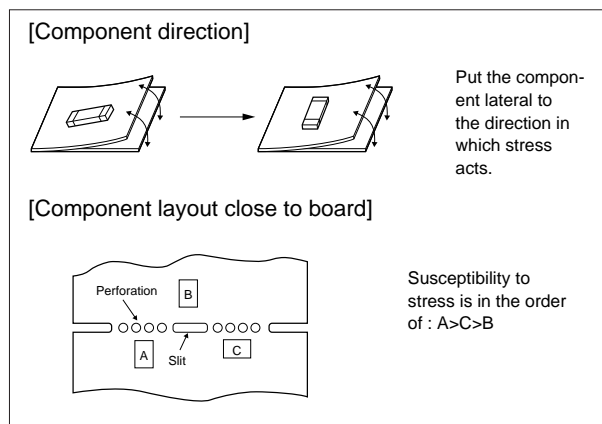

Continued on the following page. 

## Notice (Handling)

☒ Continued from the preceding page.

### ■ CERAFIL® 2.3-5.7MHz Chip Type SFSKB Series

1. The component will be damaged when an excessive stress is applied.
2. The component may be damaged if excess mechanical stress is applied to it mounted on the printed circuit board.
3. Design layout of components on the PC board to minimize the stress imposed on the warp or flexure of the board.
4. After installing chips, if solder is excessively applied to the circuit board, mechanical stress will cause destruction resistance characteristics to lower. To prevent this, be extremely careful in determining shape and dimension before designing the circuit board diagram.
5. The component may be damaged during mounting process if some part of mounter such as positioning claws, nozzle are worn down. The regular maintenance recommended for mounters should be done to prevent the troubles.
6. The component is recommended with placement machines which employ optical placement capabilities. The component might be damaged by excessive mechanical force. Please make sure that you have evaluated by using placement machines before going into mass production. Do not use placement machines which utilize mechanical positioning. Please contact Murata for details beforehand.
7. When correcting chips with a soldering iron, the tip of the soldering iron should not directly touch the chip component. Depending on the soldering conditions, the effective area of terminations may be reduced. The use of solder containing Ag should be done to prevent the electrode erosion.
8. Do not clean or wash the component as it is not hermetically sealed.
9. In case of covering filter with over coat, conditions such as material of resin, cure temperature, and so on should be evaluated carefully.
10. Do not use strong acidity flux, more than 0.2wt% chlorine content, in re-flow soldering.
11. Accurate test circuit values are required to measure electrical characteristics. It may be a cause of miscorrelation if there is any deviation, especially stray capacitance, from the test circuit in the specification.
12. For safety purposes, connect the output of filters to the IF amplifier through a D.C. blocking capacitor. Avoid applying a direct current to the output of ceramic filters.

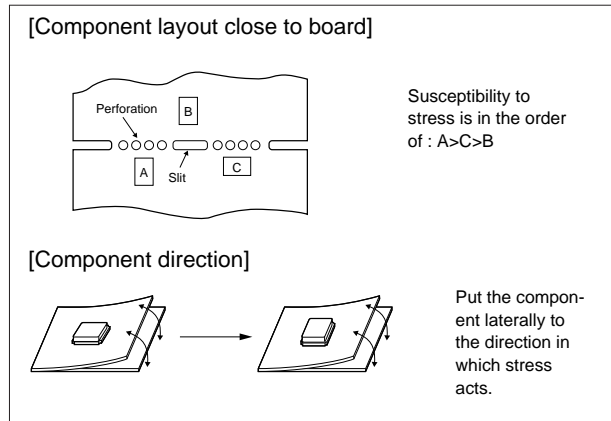

## Notice (Handling)

### ■ CERAFIL® 3.5-6.5MHz Lead Type

1. Do not use this product with bend. The component may be damaged if excess mechanical stress is applied to it mounted on the printed circuit board.
2. The component may be damaged when an excessive stress is applied.
3. All kinds of re-flow soldering must not be applied on the component.
4. Do not clean or wash the component as it is not hermetically sealed.
5. Please contact Murata or Murata representative for soldering condition, in case of using lead free solder.
6. Do not use strong acidity flux, more than 0.2wt% chlorine content, in flow soldering.
7. In case of covering filter with over coat, conditions such as material of resin, cure temperature, and so on should be evaluated carefully.
8. Accurate test circuit values are required to measure electrical characteristics. It may be a cause of miscorrelation if there is any deviation, especially stray capacitance, from the test circuit in the specification.
9. For safety purposes, connect the output of filters to the IF amplifier through a D.C. blocking capacitor. Avoid applying a direct current to the output of ceramic filters.

### ■ CERAFIL® 455kHz Chip Type SFPKA Series

1. The component will be damaged when an excessive stress is applied.
2. In the case that the component is cleaned, confirm that no reliability degradation is created.
3. In case of covering filter with over coat, conditions such as material of resin, cure temperature, and so on should be evaluated carefully.
4. Do not use strong acidity flux, more than 0.2wt% chlorine content, in re-flow soldering.
5. The product, packed in the moisture-proof bag (dry pack), is sensitive to moisture. The following treatment is required before applying re-flow soldering, to avoid package cracks or reliability degradation caused by thermal stress. When unpacked, store the component in an atmosphere of below 25 degree C and below 65%R.H., and solder within 48 hours.
6. For safety purposes, connect the output of filters to the IF amplifier through a D.C. blocking capacitor. Avoid applying a direct current to the output of ceramic filters.

### ■ CERAFIL® 455kHz Lead Type

1. Do not use this product with bend. The component may be damaged if excess mechanical stress is applied to it mounted on the printed circuit board.
2. The component will be damaged when an excessive stress is applied.
3. All kinds of re-flow soldering must not be applied on the component.
4. Do not clean or wash the component as it is not hermetically sealed.
5. Do not use strong acidity flux, more than 0.2wt% chlorine content, in flow soldering.
6. In case of covering filter with over coat, conditions such as material of resin, cure temperature, and so on should be evaluated carefully.
7. Accurate test circuit values are required to measure electrical characteristics. It may be a cause of miscorrelation if there is any deviation, especially stray capacitance, from the test circuit in the specification.
8. For safety purpose, connect the output of filters to the IF amplifier through a D.C. blocking capacitor. Avoid applying a direct current to the output of ceramic filters.

## Notice (Handling)

### ■ Ceramic Trap 4.5-6.5MHz Chip Type

1. The component may be damaged if excess mechanical stress is applied to it mounted on the printed circuit board.
2. Design layout of components on the PC board to minimize the stress imposed on the warp or flexure of the board.
3. After installing chips, if solder is excessively applied to the circuit board, mechanical stress will cause destruction resistance characteristics to lower. To prevent this, be extremely careful in determining shape and dimension before designing the circuit board diagram.
4. The component may be damaged during mounting process if some part of mounter such as positioning claws or nozzle are worn down. The regular maintenance recommended for mounters should be done to prevent troubles.
5. When correcting chips with a soldering iron, the tip of the soldering iron should not directly touch the chip component.
6. Cleaning or washing of the component is not acceptable due to non sealed construction.
7. In case of covering filter with over coat, conditions such as material of resin, cure temperature, and so on should be evaluated carefully.
8. Accurate test circuit values are required to measure electrical characteristics. It may be a cause of miscorrelation if there is any deviation, especially stray capacitance, from the test circuit in the specification.
9. For safety purposes, connect the output of filters to the IF amplifier through a D.C. blocking capacitor. Avoid applying a direct current to the output of ceramic filters.

### ■ Ceramic Trap 3.5-6.5MHz Lead Type

1. Do not use this product with bend. The component may be damaged if excess mechanical stress is applied to it mounted on the printed circuit board.
2. The component may be damaged when an excessive stress is applied.
3. All kinds of re-flow soldering must not be applied on the component.
4. Do not clean or wash the component as it is not hermetically sealed.
5. Please contact Murata or Murata representative for soldering condition, in case of using lead free solder.
6. Do not use strong acidity flux, more than 0.2wt% chlorine content, in flow soldering.

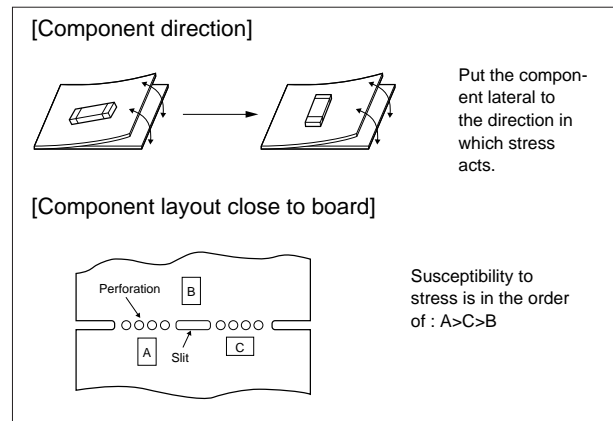

7. In case of covering filter with over coat, conditions such as material of resin, cure temperature, and so on should be evaluated carefully.
8. Accurate test circuit values are required to measure electrical characteristics. It may be a cause of miscorrelation if there is any deviation, especially stray capacitance, from the test circuit in the specification.
9. For safety purposes, connect the output of filters to the IF amplifier through a D.C. blocking capacitor. Avoid applying a direct current to the output of ceramic filters.

## Notice (Handling)

### ■ Ceramic Discriminator 10.7MHz Chip Type

1. The component mounted on the PCB may be damaged if excess mechanical stress is applied.
2. Layout the components on the PCB to minimize the stress imposed on the warp or flexure of the board.
3. After installing components, if solder is excessively applied to the circuit board, mechanical stress will cause destruction resistance characteristics to lower. To prevent this, be extremely careful in determining shape and dimension before designing the circuit board diagram.
4. The component may be damaged during mounting process if some part of mounter such as positioning claws or nozzle are worn down. The regular maintenance recommended for mounters should be done to prevent troubles.
5. When correcting component's position with a soldering iron, the tip of the soldering iron should not directly touch the chip component. Depending on the soldering conditions, the effective area of terminations may be reduced. The use of solder containing Ag should be considered to prevent the electrode erosion.
6. Do not clean or wash the component as it is not hermetically sealed.
7. In case of overcoating the part, coating conditions such as material of resin, curing temperature, and so on should be evaluated carefully.
8. Accurate test circuit values are required to measure electrical characteristics.  
It may be a cause of miscorrelation if there is any deviation, especially stray capacitance, from the test circuit in the specification.
9. For safety purposes, avoid applying a direct current between the terminals.

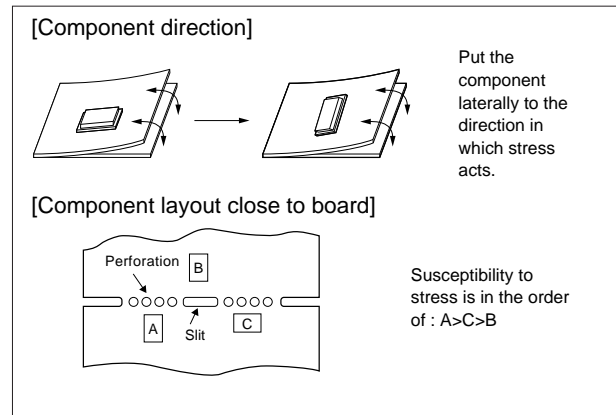

### ■ Ceramic Discriminator 10.7MHz Lead Type

1. Do not use this product with bend. The component may be damaged if excess mechanical stress is applied to it mounted on the printed circuit board.
2. The component may be damaged when an excessive stress is applied.
3. All kinds of re-flow soldering must not be applied on the component.
4. Do not clean or wash the component as it is not hermetically sealed.
5. Do not use strong acidity flux, more than 0.2wt% chlorine content, in flow soldering.
6. In case of covering discriminator with over coat, conditions such as material of resin, cure temperature, and so on should be evaluated carefully.
7. Accurate test circuit values are required to measure electrical characteristics. It may be a cause of miscorrelation if there is any deviation, especially stray capacitance, from the test circuit in the specification.
8. For safety purposes, avoid applying a direct current between the terminals.

## Packaging

### Minimum Quantity

	Taping		Ammo Pack	Bulk	Magazine	Box
	ø330mm	ø180mm				
CERAFIL®<10.7MHz>						
	SFE CF		2,000			
	SFE CV		2,000			
	SFE LF		1,500	500		
	SFE LG		1,500	500		
	SFE KF		1,500	500		
	SFE VLF		1,000	500		
CERAFIL®<2.3-6.5MHz>						
	SFS KA	3,000				
	SFS KB	3,000				
	SFS RA		2,000	500		
	SFS RF		1,500	500		
CERAFIL®<455kHz>						
	BFULA			500		
	CFULA					200
	CFWLA				50	150
	SFPKA	1,000				
	SFPLA				50	200
	SFULA			500	50	
	SFZLA			200	50	
Ceramic Traps<3.5-6.5MHz>						
	TPSKA	3,000				
	TPSRA		2,000	500		
	TPSRF		1,500	500		
	TPTRF		1,500	500		
	TPWKA	3,000				
	TPWRF		1,500	500		
Ceramic Discriminators<10.7MHz>						
	CDALF		1,500	500		
	CDSCB		2,000			

### CERAFIL® 10.7MHz Chip Type SFE CF Series

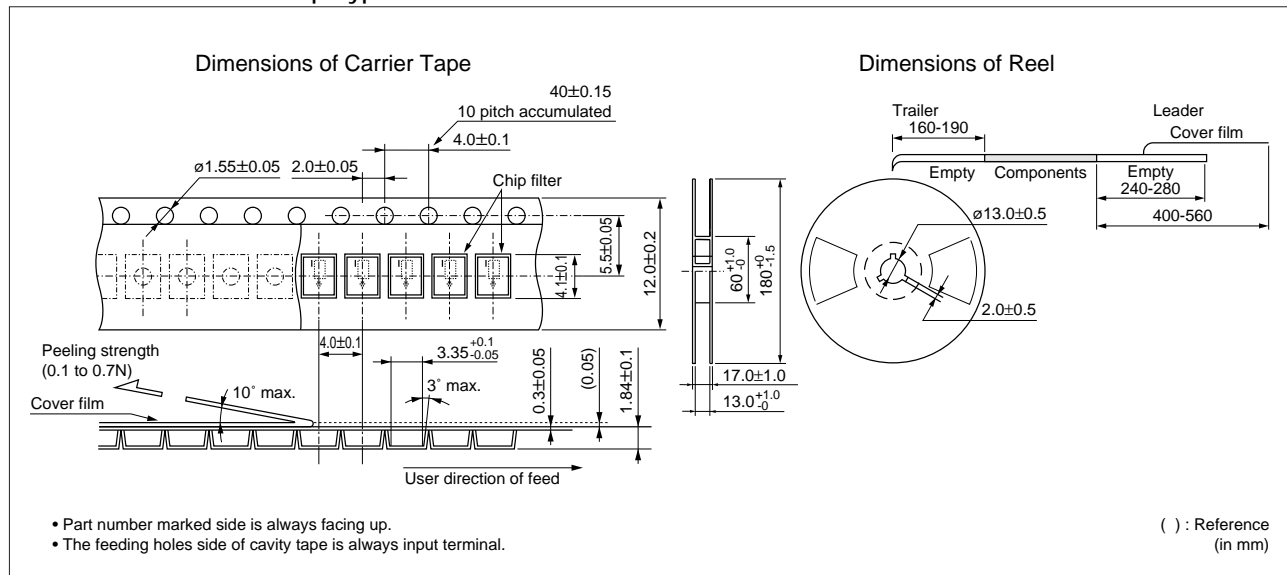

Continued on the following page.

## Packaging

☒ Continued from the preceding page.

### ■ CERAFIL® 10.7MHz Chip Type SFECV Series

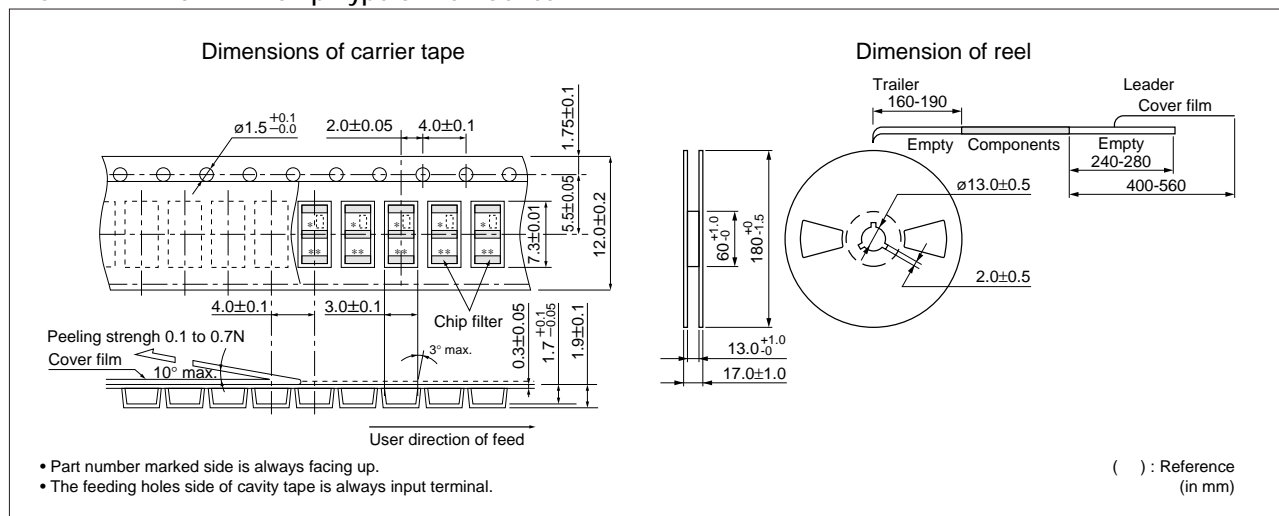

Continued on the following page. ☒

## Packaging

Continued from the preceding page.

### ■ CERAFIL® 10.7MHz Lead Type SF\_LF Series

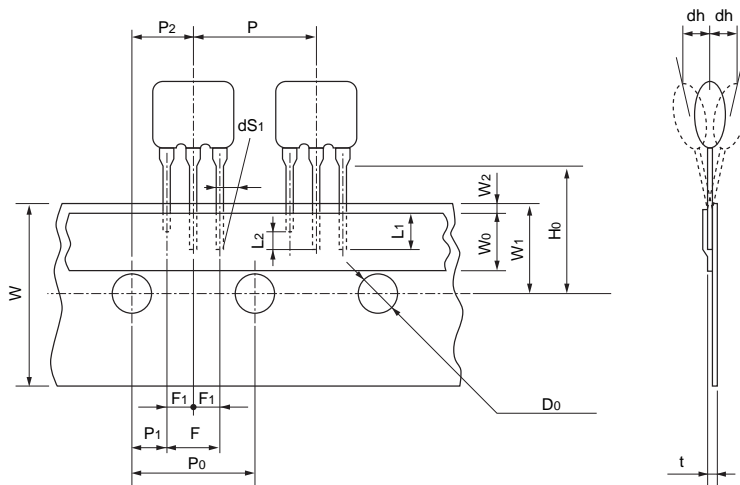

Item	Code	Dimensions	Tolerance	Remarks
Lead length under the hold down tape	L1	3.0 min.	-	
Length of cut off	L2	2.0 max.	-	To distinguish the direction
Pitch of components	P	12.7	±0.5	
Pitch of sprocket hole (1)	P0	12.7	±0.2	
Length from hole center to lead	P1	3.85	±0.5	
Length from hole center to component center	P2	6.35	±0.5	
Lead spacing (1)	F	5.0	+0.5 -0.2	
Lead spacing (2)	F1	2.5	±0.2	
Slant to the forward or backward	dh	0	±1.0	
Slant to the left or right	dS1	0	±1.0	
Width of carrier tape	W	18.0	±0.5	
Width of hold down tape	W0	6.0 min.	-	
Position of sprocket hole	W1	9.0	±0.5	
Gap of hold down tape and carrier tape	W2	0	+0.5 -0	Hold down tape doesn't exceed the carrier tape
Distance between the center of sprocket hole and lead stopper	H0	18.0	±0.5	
Diameter of sprocket hole	Do	ø4.0	±0.2	
Total tape thickness	t	0.6	±0.2	
Pitch of sprocket hole (2)	P020	254.0	±1.5	The pitch of 20 sprocket holes

(in mm)

Continued on the following page. ↗



## Packaging

Continued from the preceding page.

### ■ CERAFIL® 4.5-6.5MHz Chip Type SFSKA Series

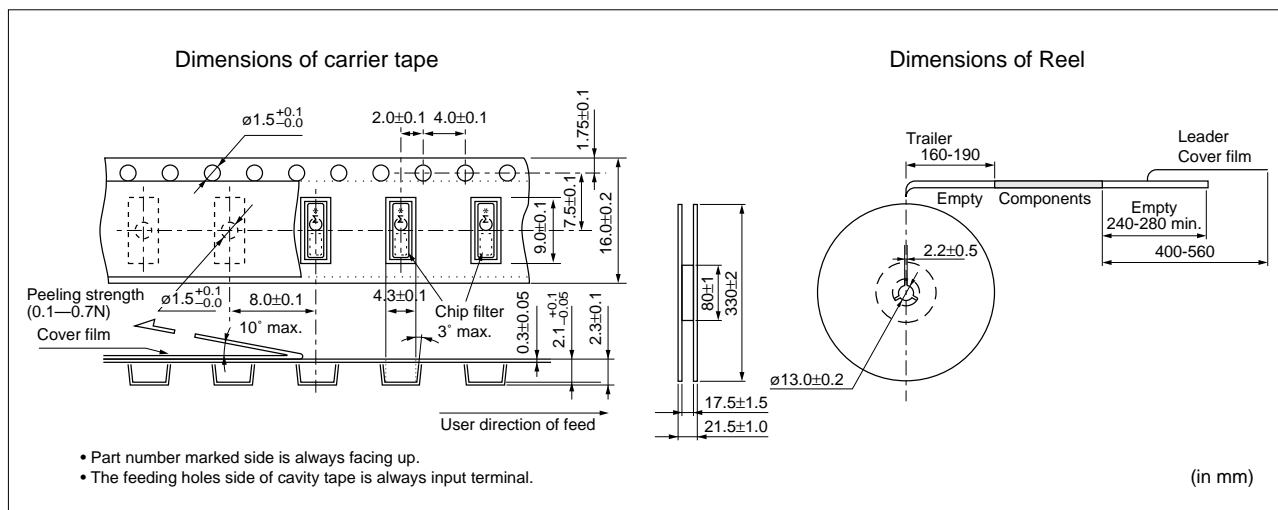

### ■ CERAFIL® 2.3-5.7MHz Chip Type SFSKB Series

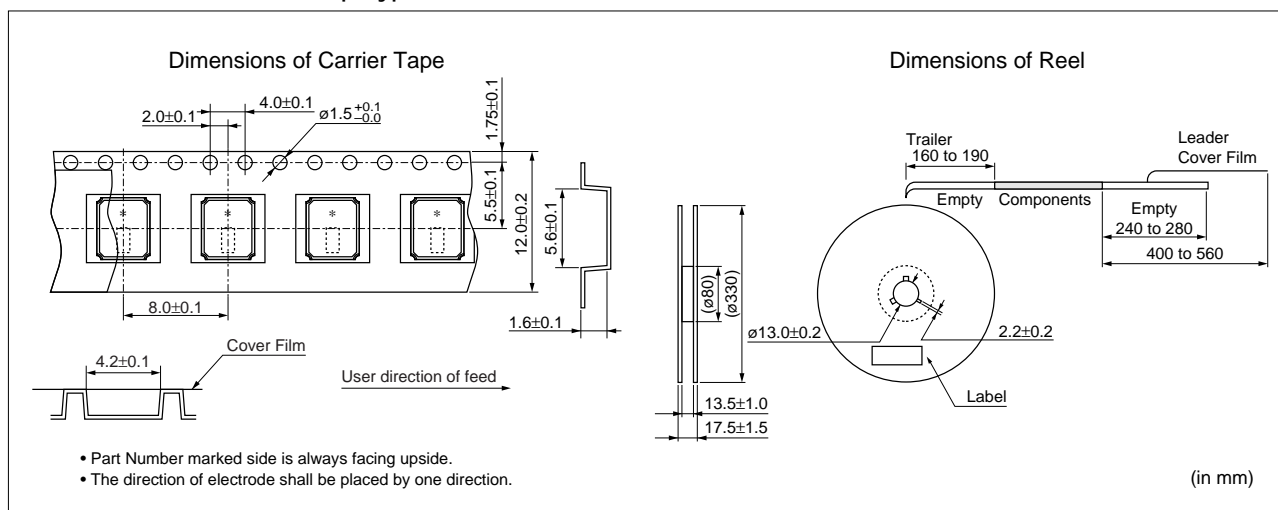

Continued on the following page. ↗

## Packaging

Continued from the preceding page.

### ■ CERAFIL® 4.5-6.5MHz Lead Type SFSRA Series

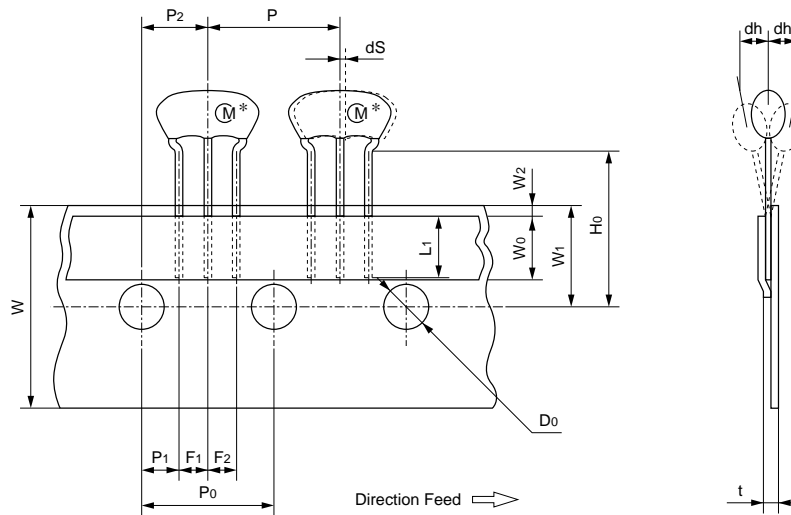

Item	Code	Dimensions	Tolerance	Remarks
Lead length under the hold down tape	L1	5.0 min.	-	
Pitch of component	P	12.7	±0.5	Tolerance for Pitches 10XP0=127±1
Pitch of sprocket hole (1)	P0	12.7	±0.2	
Length from hole center to lead	P1	3.85	±0.5	
Length from hole center to component center	P2	6.35	±0.5	
Lead spacing (1)	F1	2.5	±0.2	
Lead spacing (2)	F2	2.5	±0.2	
Slant to the forward or backward	dh	0	±1.0	
Width of carrier tape	W	18.0	±0.5	
Width of hold down tape	W0	6.0 min.	-	
Position of Sprocket hole	W1	9.0	±0.5	
Gap of hold down tape and carrier Tape	W2	0	+0.5 -0	Hold down tape doesn't exceed the carrier tape.
Distance between the center of sprocket hole and lead stopper	H0	18.0	±0.5	
Diameter of sprocket hole	D0	ø4.0	±0.2	
Total tape thickness	t	0.6	±0.2	
Pitch of sprocket hole (2)	P020	254.0	±1.5	The pitch of 20 sprocket holes
Body tilt	dS	0	±1.0	

(in mm)

Continued on the following page. ↗

## Packaging

Continued from the preceding page.

### ■ CERAFIL® 455kHz Chip Type SFPKA Series

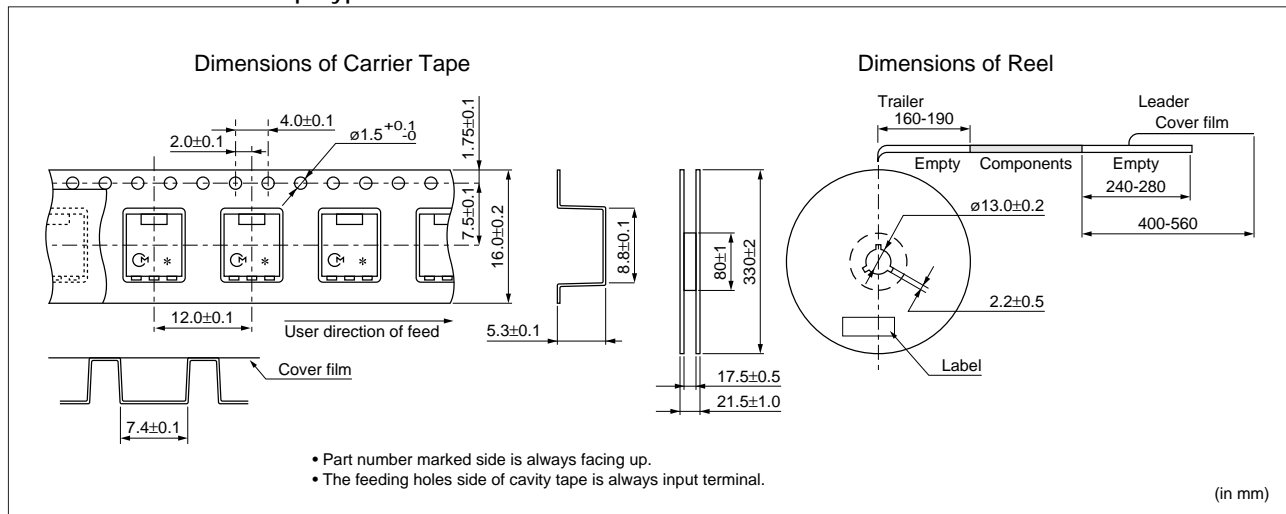

### ■ CERAFIL® 455kHz Lead Type SFULA Series

#### Standard of Magazine Cassette

##### 1. Putting CERAFIL® into Magazine

A magazine should contain 50pcs of CERAFIL®, with the marking of products all facing toward the "Murata" mark on a magazine, and be closed with exclusive stoppers at both ends. Above should be the minimum packaging unit.

##### 2. Quality of Magazine

- (1) Transparent so that input / output direction is visually recognizable.
- (2) With an angle of 35° CERAFIL® should slip down smoothly.
- (3) Antistatic finish
- (4) Recycling

Note: Magazines should be sent back for recycling.  
(Therefore, empty magazines should not be damaged.)

##### 3. Dimensions of Magazine Cassette

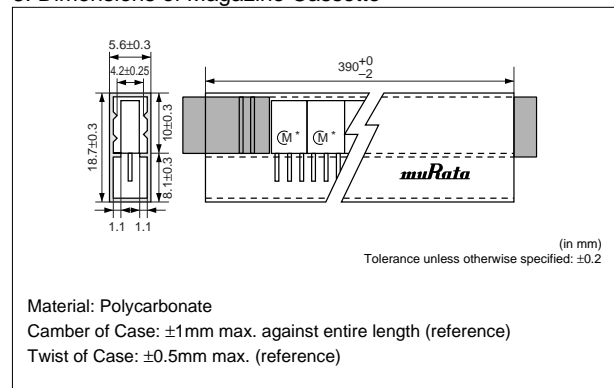

### ■ CERAFIL® 455kHz Lead Type SFZLA Series

#### Standard of Magazine Cassette

##### 1. Putting CERAFIL® into Magazine

A magazine should contain 50pcs of CERAFIL®, with the marking of products all facing toward the "Murata" mark on a magazine, and be closed with exclusive stoppers at both ends. Above should be the minimum packaging unit.

##### 2. Quality of Magazine

- (1) Transparent so that input / output direction is visually recognizable.
- (2) With an angle of 35° CERAFIL® should slip down smoothly.
- (3) Antistatic finish
- (4) Recycling

Note: Magazines should be sent back for recycling.  
(Therefore, empty magazines should not be damaged.)

##### 3. Dimensions of Magazine Cassette

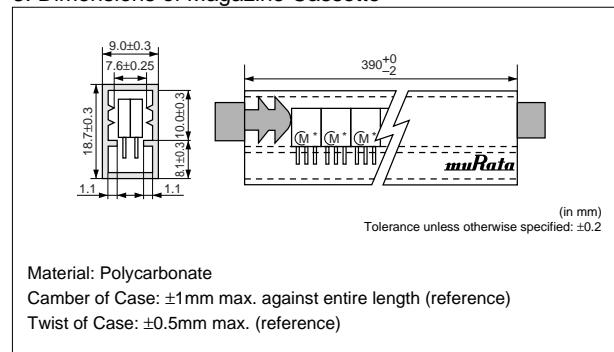

Continued on the following page. ↗

## Packaging

Continued from the preceding page.

### ■ CERAFIL® 455kHz Lead Type SFPLA Series

#### Standard of Magazine Cassette

##### 1. Putting CERAFIL® into Magazine

A magazine should contain 50pcs of CERAFIL®, which ground terminals are all facing toward the "Murata" mark on a magazine, and be closed with exclusive stoppers at both ends. Above should be the minimum packaging unit.

##### 2. Quality of Magazine

- (1) Transparent so that input / output direction is visually recognizable.
- (2) With an angle of 35° CERAFIL® should slip down smoothly.
- (3) Antistatic finish
- (4) Recycling

Note: Magazines should be sent back for recycling.  
(Therefore, empty magazines should not be damaged.)

### ■ CERAFIL® 455kHz Lead Type CFWLA Series

#### Standard of Magazine Cassette

##### 1. Putting CERAFIL® into Magazine

A magazine should contain 50pcs of CERAFIL®, with ground terminals all facing toward the "Murata" mark on a magazine, and be closed with exclusive stoppers at both ends. Above should be the minimum packaging unit.

##### 2. Quality of Magazine

- (1) Transparent so that input / output direction is visually recognizable.
- (2) With an angle of 35° CERAFIL® should slip down smoothly.
- (3) Antistatic finish
- (4) Recycling

Note: Magazines should be sent back for recycling.  
(Therefore, empty magazines should not be damaged.)

##### 3. Magazine should be packaged in a cardboard box.

MURATA model name, quantity and outgoing inspection number should be indicated on the box.

Cardboard box may contain maximum 33 magazines (1,650 pieces of filter).

#### 3. Dimensions of Magazine Cassette

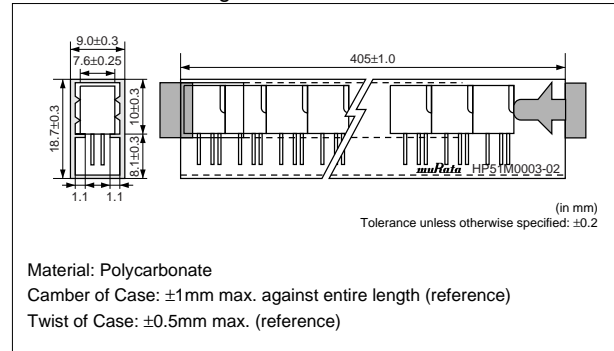

#### 4. Dimensions of Magazine Cassette

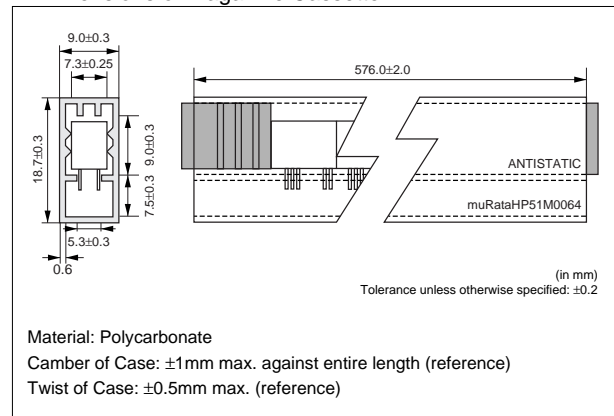

Continued on the following page. ↗

## Packaging

Continued from the preceding page.

### ■ Ceramic Trap 4.5-6.5MHz Chip Type TPSKA Series

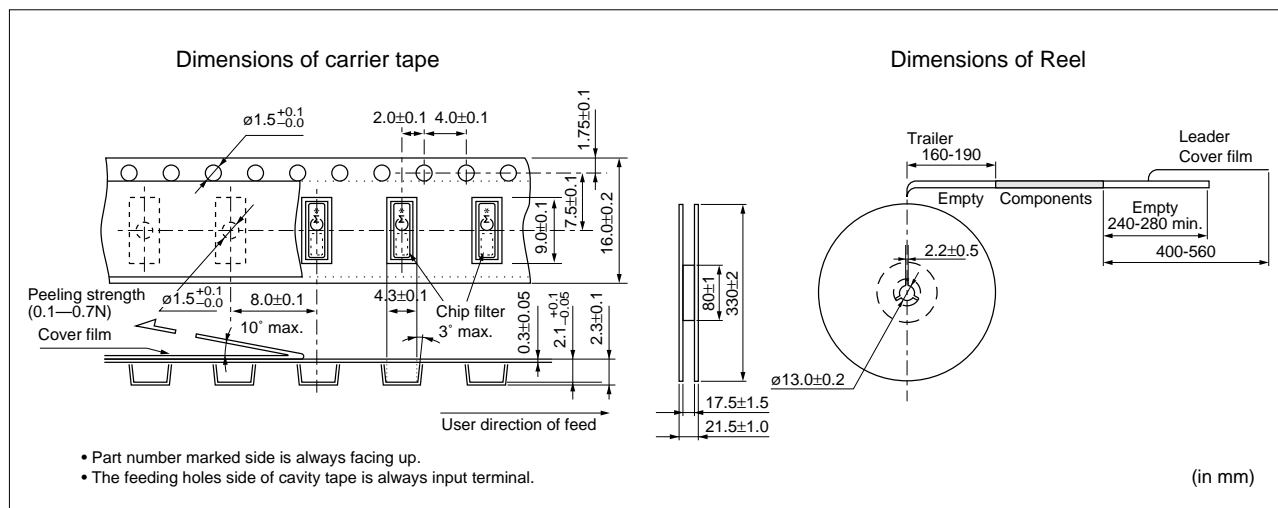

### ■ Ceramic Trap 4.5-6.5MHz Chip Type TPWKA Series

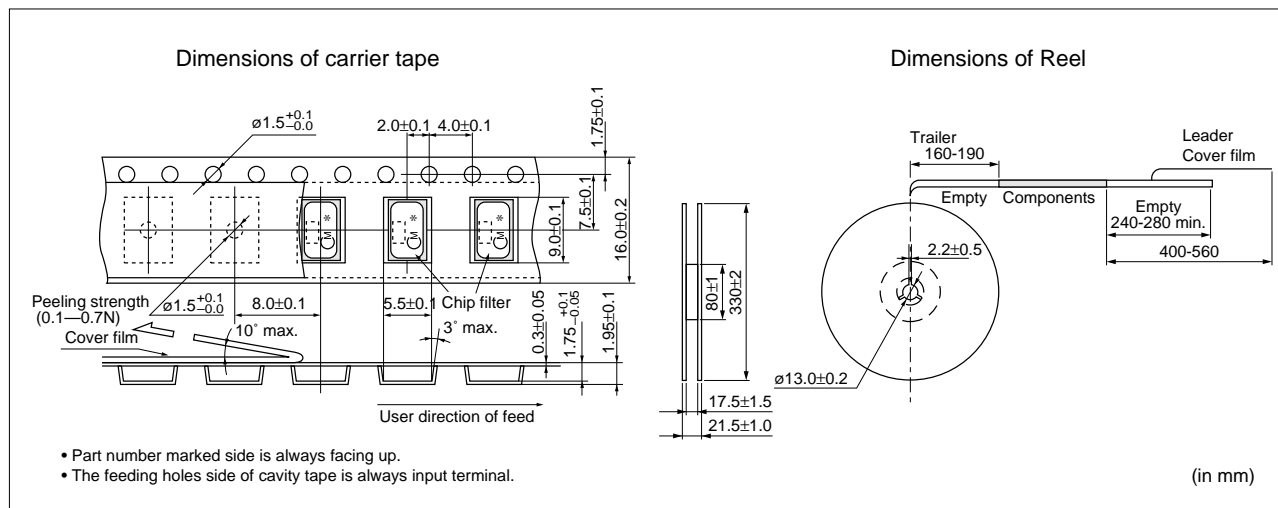

Continued on the following page. ↗

## Packaging

Continued from the preceding page.

### ■ Ceramic Trap 4.5-6.5MHz Lead Type TPSRA Series

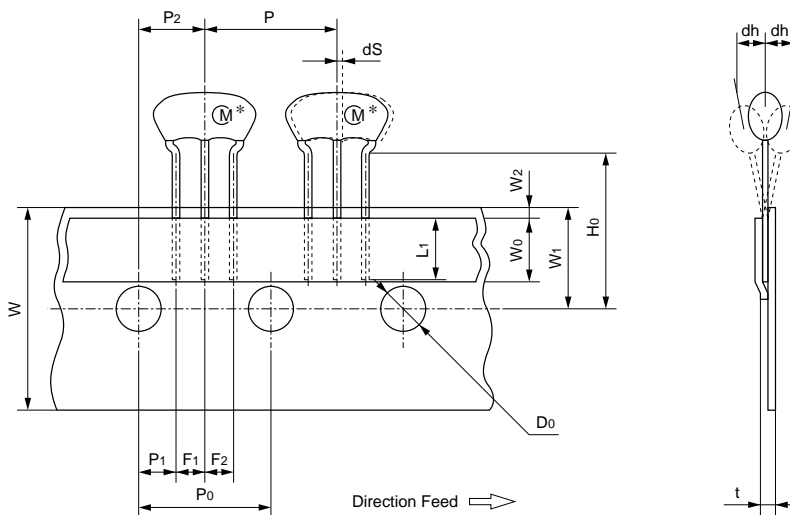

Item	Code	Dimensions	Tolerance	Remarks
Lead length under the hold down tape	L1	5.0 min.	-	
Pitch of component	P	12.7	±0.5	Tolerance for Pitches 10XP0=127±1
Pitch of sprocket hole (1)	P0	12.7	±0.2	
Length from hole center to lead	P1	3.85	±0.5	
Length from hole center to component center	P2	6.35	±0.5	
Lead spacing (1)	F1	2.5	±0.2	
Lead spacing (2)	F2	2.5	±0.2	
Slant to the forward or backward	dh	0	±1.0	
Width of carrier tape	W	18.0	±0.5	
Width of hold down tape	W0	6.0 min.	-	
Position of Sprocket hole	W1	9.0	±0.5	
Gap of hold down tape and carrier Tape	W2	0	+0.5 -0	Hold down tape doesn't exceed the carrier tape.
Distance between the center of sprocket hole and lead stopper	H0	18.0	±0.5	
Diameter of sprocket hole	D0	ø4.0	±0.2	
Total tape thickness	t	0.6	±0.2	
Pitch of sprocket hole (2)	P020	254.0	±1.5	The pitch of 20 sprocket holes
Body tilt	dS	0	±1.0	

(in mm)

Continued on the following page. ↗

## Packaging

Continued from the preceding page.

### ■ Ceramic Trap 3.5-6.5MHz Lead Type TPSRF\_J Series

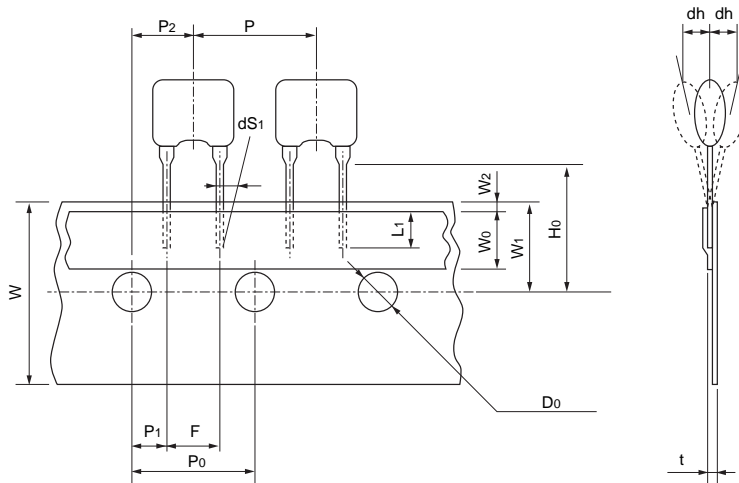

Item	Code	Dimensions	Tolerance	Remarks
Lead length under the hold down tape	L1	3.0 min.	-	
Pitch of component	P	12.7	±0.5	
Pitch of sprocket hole (1)	P0	12.7	±0.2	
Length from hole center to lead	P1	3.85	±0.5	
Length from hole center to component center	P2	6.35	±0.5	
Lead spacing	F	5.0	+0.5 -0.2	
Slant to the forward or backward	dh	0	±1.0	
Slant to the left or right	dS1	0	±1.0	
Width of carrier tape	W	18.0	±0.5	
Width of hold down tape	W0	6.0 min.	-	
Position of sprocket hole	W1	9.0	±0.5	
Gap of hold down tape and carrier tape	W2	0	+0.5 -0.0	Hold down tape doesn't exceed the carrier tape
Distance between the center of sprocket hole and lead stopper	H0	18.0	±0.5	
Diameter of sprocket hole	D0	ø4.0	±0.2	
Total tape thickness	t	0.6	±0.2	
Pitch of sprocket hole (2)	Po20	254.0	±1.5	The pitch of 20 sprocket holes

(in mm)

Continued on the following page. ↗

## Packaging

Continued from the preceding page.

### ■ Ceramic Trap 3.5-6.5MHz Lead Type TPSRF\_W/TPWRF/TPTRF Series

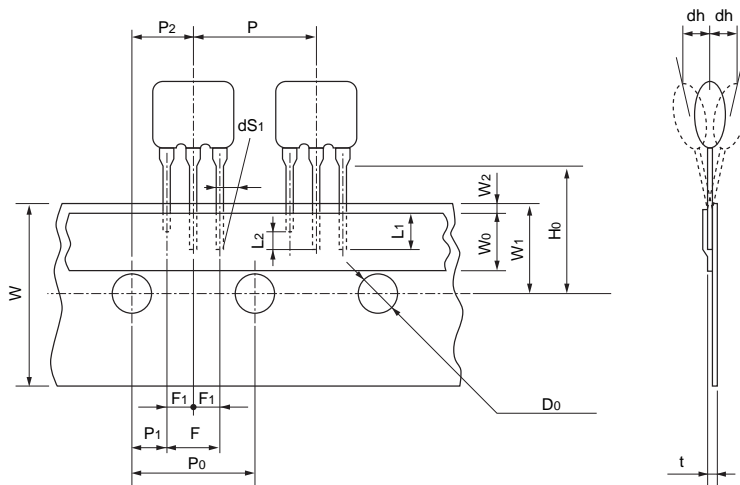

Item	Code	Dimensions	Tolerance	Remarks
Lead length under the hold down tape	L1	3.0 min.	-	
Length of cut off	L2	2.0 max.	-	To distinguish the direction
Pitch of components	P	12.7	±0.5	
Pitch of sprocket hole (1)	P0	12.7	±0.2	
Length from hole center to lead	P1	3.85	±0.5	
Length from hole center to component center	P2	6.35	±0.5	
Lead spacing (1)	F	5.0	+0.5 -0.2	
Lead spacing (2)	F1	2.5	±0.2	
Slant to the forward or backward	dh	0	±1.0	
Slant to the left or right	dS1	0	±1.0	
Width of carrier tape	W	18.0	±0.5	
Width of hold down tape	W0	6.0 min.	-	
Position of sprocket hole	W1	9.0	±0.5	
Gap of hold down tape and carrier tape	W2	0	+0.5 -0	Hold down tape doesn't exceed the carrier tape
Distance between the center of sprocket hole and lead stopper	H0	18.0	±0.5	
Diameter of sprocket hole	D0	ø4.0	±0.2	
Total tape thickness	t	0.6	±0.2	
Pitch of sprocket hole (2)	P020	254.0	±1.5	The pitch of 20 sprocket holes

(in mm)

Continued on the following page. ↗





## Packaging

Continued from the preceding page.

### ■ Ceramic Discriminator 10.7MHz Lead Type CDALF Series

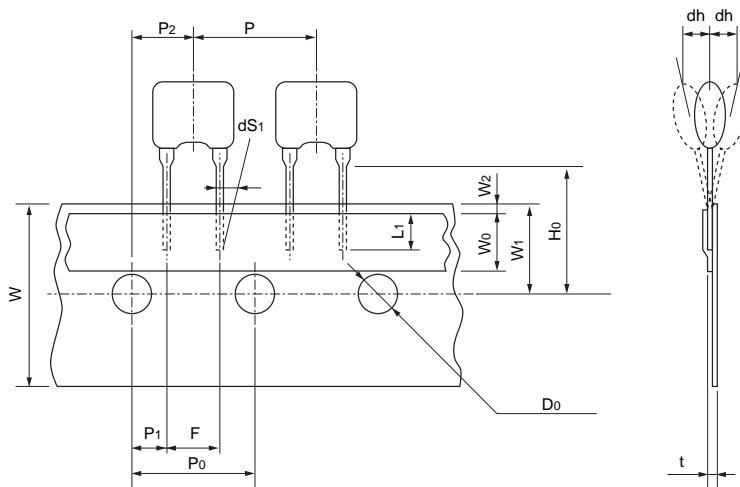

Item	Code	Dimensions	Tolerance	Remarks
Lead length under the hold down tape	L1	3.0 min.	-	
Pitch of component	P	12.7	±0.5	
Pitch of sprocket hole (1)	P0	12.7	±0.2	
Length from hole center to lead	P1	3.85	±0.5	
Length from hole center to component center	P2	6.35	±0.5	
Lead spacing	F	5.0	+0.5 -0.2	
Slant to the forward or backward	dh	0	±1.0	
Slant to the left or right	dS1	0	±1.0	
Width of carrier tape	W	18.0	±0.5	
Width of hold down tape	W0	6.0 min.	-	
Position of sprocket hole	W1	9.0	±0.5	
Gap of hold down tape and carrier tape	W2	0	+0.5 -0.0	Hold down tape doesn't exceed the carrier tape
Distance between the center of sprocket hole and lead stopper	H0	18.0	±0.5	
Diameter of sprocket hole	D0	ø4.0	±0.2	
Total tape thickness	t	0.6	±0.2	
Pitch of sprocket hole (2)	Po20	254.0	±1.5	The pitch of 20 sprocket holes

(in mm)

**⚠Note:**

1. Export Control

<For customers outside Japan>

No muRata products should be used or sold, through any channels, for use in the design, development, production, utilization, maintenance or operation of, or otherwise contribution to (1) any weapons (Weapons of Mass Destruction [nuclear, chemical or biological weapons or missiles] or conventional weapons) or (2) goods or systems specially designed or intended for military end-use or utilization by military end-users.

<For customers in Japan>

For products which are controlled items subject to the "Foreign Exchange and Foreign Trade Law" of Japan, the export license specified by the law is required for export.

2. Please contact our sales representatives or product engineers before using the products in this catalog for the applications listed below, which require especially high reliability for the prevention of defects which might directly damage a third party's life, body or property, or when one of our products is intended for use in applications other than those specified in this catalog.

- |                             |  |
|-----------------------------|--|
| ① Aircraft equipment        | ② Aerospace equipment  |
| ③ Undersea equipment        | ④ Power plant equipment  |
| ⑤ Medical equipment         | ⑥ Transportation equipment (vehicles, trains, ships, etc.)   |
| ⑦ Traffic signal equipment  | ⑧ Disaster prevention / crime prevention equipment   |
| ⑨ Data-processing equipment | ⑩ Application of similar complexity and/or reliability requirements to the applications listed above |

3. Product specifications in this catalog are as of September 2007. They are subject to change or our products in it may be discontinued without advance notice. Please check with our sales representatives or product engineers before ordering. If there are any questions, please contact our sales representatives or product engineers.

4. Please read rating and ⚠ CAUTION (for storage, operating, rating, soldering, mounting and handling) in this catalog to prevent smoking and/or burning, etc.

5. This catalog has only typical specifications because there is no space for detailed specifications. Therefore, please approve our product specifications or transact the approval sheet for product specifications before ordering.

6. Please note that unless otherwise specified, we shall assume no responsibility whatsoever for any conflict or dispute that may occur in connection with the effect of our and/or a third party's intellectual property rights and other related rights in consideration of your use of our products and/or information described or contained in our catalogs. In this connection, no representation shall be made to the effect that any third parties are authorized to use the rights mentioned above under licenses without our consent.

7. No ozone depleting substances (ODS) under the Montreal Protocol are used in our manufacturing process.



<http://www.murata.com/>

**Head Office**  
1-10-1, Higashi Kotari, Nagaokakyo-shi, Kyoto 617-8555, Japan  
Phone: 81-75-951-9111

**International Division**  
3-29-12, Shibuya, Shibuya-ku, Tokyo 150-0002, Japan  
Phone: 81-3-5469-6123 Fax: 81-3-5469-6155 E-mail: [intl@murata.co.jp](mailto:intl@murata.co.jp)