

# Ceramic Filters (CERAFIL®)/Ceramic Discriminators for Communications Equipment



1

## CERAFIL® kHz SMD Type CFXC\_ Series

CFXC\_ series are very small and high-efficiency surface mount, ladder type 450/455 kHz ceramic filters "CERAFIL" for IF section.

Compared to our previous compact surface mounted 6-element product, this ceramic filter has been significantly downsized to approximately one-third the original volume and reduced to less than 2 mm in height.

As for electrical performance, this product, which consists of 4 elements, provides stop band attenuation equivalent to that of our previous 6-element product. The input/output impedance characteristics are also equivalent to those of the previous product, and spurious responses in the vicinity of the passing band can now be eliminated. This allows mobile telecommunications equipment manufacturers to easily design the periphery of the IF section and thus greatly enhance the interference suppression capability of the equipment. In addition, this ceramic filter provides flatter group delay time characteristics than the previous product, and will effectively work as a component for data transmission in digital mobile telecommunications systems.



CFXCA Series

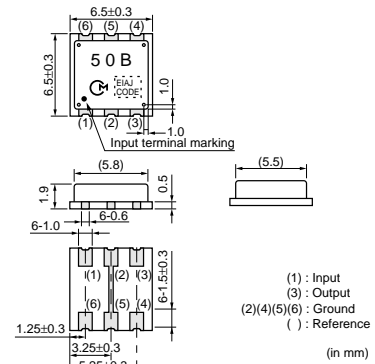

CFXCD Series

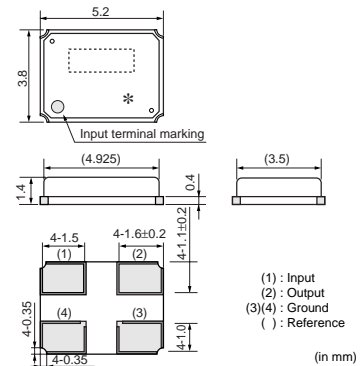

### ■ Features

1. Compact, thin, and lightweight.  
(Size : CFXCA450KBFA-R1: 6.5x6.5x1.9mm  
CFXCD450KCFA-R1: 5.2x3.8x1.4mm  
Weight: CFXCA series: 225mg  
CFXCD series: 75mg)
2. Out-of-band attenuation is increased and spurious responses are greatly decreased.
3. Group delay time characteristics are flattened.
4. Surface mountable, and reflow soldering can be used for mounting.

### ■ Applications

1. IF filters for PDCs.
2. IF filters for various types of pagers.
3. IF filters for various types of analog and digital cellular telephones.
4. IF filters for radio communication circuits applicable for PDA or PCMCIA.
5. IF filters for other general mobile wireless equipment

Part Number	Nominal Center Frequency (fn) (kHz)	3dB Bandwidth (kHz)	6dB Bandwidth (kHz)	Stop Bandwidth (kHz)	Stop Band Attenuation (dB)	Stop Band Att.(2) (dB)	Stop Band Att.(3) (dB)	Insertion Loss (dB)	Ripple (dB)	GDT Deviation (μs)
<b>CFXCA450KBFA-R1</b>	450	-	fn±15.0 min.	fn±50.0 max. [within 50dB]	47 min. [within fn±100kHz]	-	-	6.0 max. [at fn]	0.5 max. [within fn±10kHz]	15.0 max. [within fn±10kHz]
<b>CFXCD450KCFA-R1</b>	450	fn±9.0 to ±12.0kHz max.	-	fn±35.0 max. [within 50dB]	30 min. [at fn±25kHz]	55 min. [within fn±40kHz to ±50kHz]	47 min. [within fn±100kHz]	6.0 max. [at fn]	0.5 max. [within fn±10.5kHz]	27.0 max. [within fn±10.5kHz]

Spurious:40dB [within 0.1 to 1.0MHz]

Input/Output Impedance:2000 ohm

For safety purposes, connect the output of filters to the IF amplifier through a D.C. blocking capacitor. Avoid applying a direct current to the output of ceramic filters.

## Test Circuit

CFXCA Series

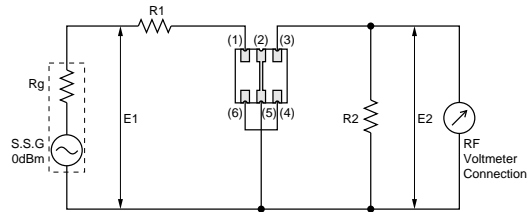

(1) : Input  
(3) : Output  
(2)(4)(5)(6) : Ground  
R1+Rg=R2=Input/Output Impedance  
E1 : S.S.G Output voltage

CFXCD Series

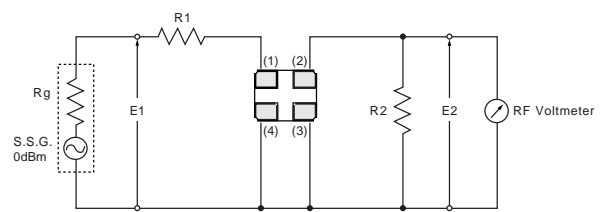

(1) Input  
(2) Output  
(3)(4) Ground  
R1 + Rg = R2 = Input/Output Impedance  
E1 : S.S.G. Output Voltage

## Frequency Characteristics

CFXCA450KBFA-R1

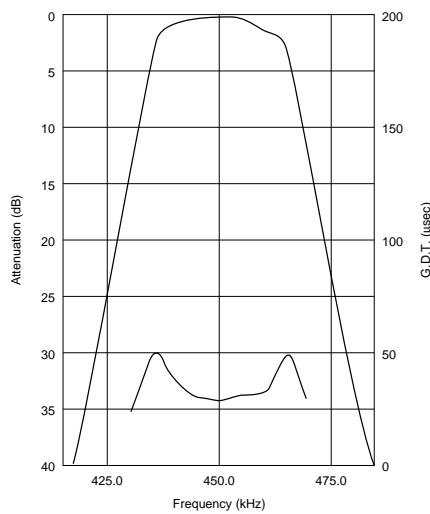

CFXCD450KCFA-R1

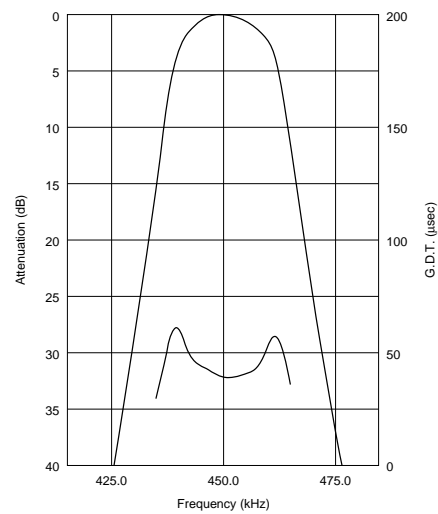

# Ceramic Filters (CERAFIL®)/Ceramic Discriminators for Communications Equipment



## CERAFIL® kHz SMD Type SFPCA Series

The SFPCA series comprises small, high performance, economical, thin (5.0mm) filters consisting of 4 ceramic elements.

Their innovative construction is perfect for shrinking mobile communication products such as cordless phones, pager and transceivers.

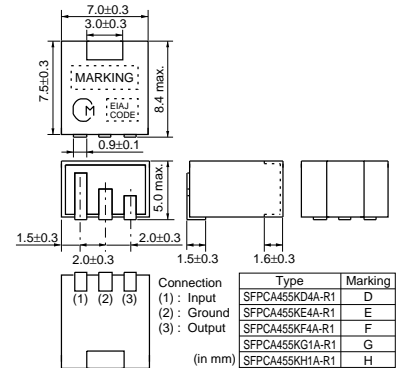

### ■ Features

1. The filters are mountable by automatic placers.
2. The filters can be reflow soldered and withstand washing.
3. They are slim, at only 5.0mm maximum thickness.
4. The bandwidth ranges from D to H.
5. Operating temperature range : -20 to +80 (degree C)  
Storage temperature range : -40 to +85 (degree C)

Part Number	Center Frequency (fo) (kHz)	6dB Bandwidth (kHz)	Stop Bandwidth (kHz)	Stop Band Attenuation (dB)	Insertion Loss (dB)	Ripple (dB)	Input/Output Impedance (ohm)
SFPCA455KD4A-R1	455.0 ±1.5kHz	fn±10.0 min.	fn±20.0 max. [within 40dB]	27 min. [within fn±100kHz]	4.0 max. [at minimum loss point]	2.0 max. [within fn±7kHz]	1500
SFPCA455KE4A-R1	455.0 ±1.5kHz	fn±7.5 min.	fn±15.0 max. [within 40dB]	27 min. [within fn±100kHz]	6.0 max. [at minimum loss point]	1.5 max. [within fn±5kHz]	1500
SFPCA455KF4A-R1	455.0 ±1.5kHz	fn±6.0 min.	fn±12.5 max. [within 40dB]	27 min. [within fn±100kHz]	6.0 max. [at minimum loss point]	1.5 max. [within fn±4kHz]	1500
SFPCA455KG1A-R1	455.0 ±1.0kHz	fn±4.5 min.	fn±10.0 max. [within 40dB]	25 min. [within fn±100kHz]	6.0 max. [at minimum loss point]	1.5 max. [within fn±3kHz]	1500
SFPCA455KH1A-R1	455.0 ±1.0kHz	fn±3.0 min.	fn±9.0 max. [within 40dB]	35 min. [within fn±100kHz]	6.0 max. [at minimum loss point]	1.5 max. [within fn±2kHz]	2000

For safety purposes, connect the output of filters to the IF amplifier through a D.C. blocking capacitor. Avoid applying a direct current to the output of ceramic filters.  
(fn) means nominal center frequency 455kHz.

### ■ Test Circuit

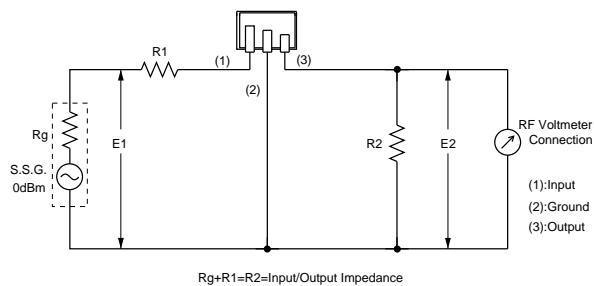

## Frequency Characteristics

SFPCA455KE4A-R1

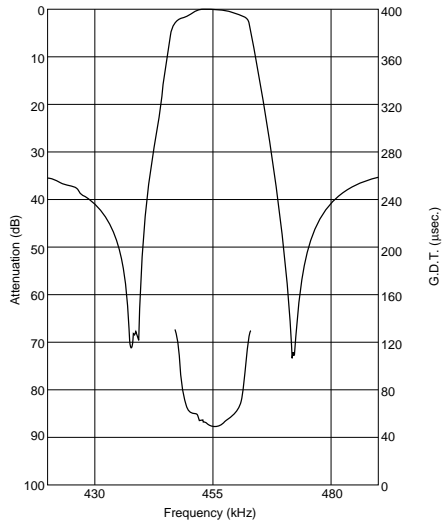

SFPCA455KE4A-R1

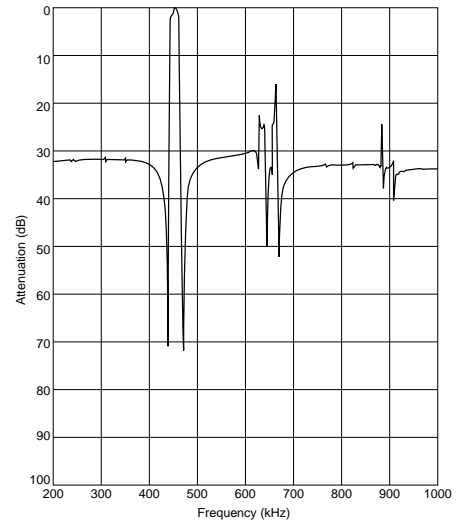

# Ceramic Filters (CERAFIL®)/Ceramic Discriminators for Communications Equipment



## CERAFIL® kHz SMD Type CFUCG Series

The CFUCG series comprises small, high performance, thin (4.0mm) filters consisting of 4 ceramic elements. Their innovative construction is perfect for shrinking mobile communication products such as pocket pagers and cellular phones.

### ■ Features

1. The filters are mountable by automatic placers.
2. The filters can be reflow soldered and withstand washing.
3. They are slim, at only 4.0mm maximum thickness, and have a small mounting area (7.5x6.0mm) enabling flexible PCB design.
4. The bandwidth ranges from D to G.
5. Operating temperature range : -20 to +80 (degree C)  
Storage temperature range : -40 to +85 (degree C)

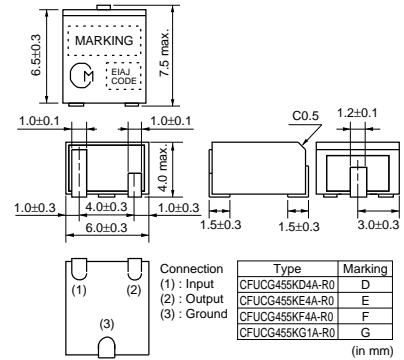

Part Number	Center Frequency (fo) (kHz)	6dB Bandwidth (kHz)	Stop Bandwidth (kHz)	Stop Band Attenuation (dB)	Insertion Loss (dB)	Ripple (dB)	Input/Output Impedance (ohm)
<b>CFUCG455KD4A-R0</b>	455.0 ±1.5kHz	fn±10.0 min.	fn±20.0 max. [within 40dB]	27 min. [within fn±100kHz]	4.0 max. [at minimum loss point]	2.0 max. [within fn±7kHz]	1500
<b>CFUCG455KE4A-R0</b>	455.0 ±1.5kHz	fn±7.5 min.	fn±15.0 max. [within 40dB]	27 min. [within fn±100kHz]	6.0 max. [at minimum loss point]	1.5 max. [within fn±5kHz]	1500
<b>CFUCG455KF4A-R0</b>	455.0 ±1.5kHz	fn±6.0 min.	fn±12.5 max. [within 40dB]	27 min. [within fn±100kHz]	6.0 max. [at minimum loss point]	1.5 max. [within fn±4kHz]	1500
<b>CFUCG455KG1A-R0</b>	455.0 ±1.0kHz	fn±4.5 min.	fn±10.0 max. [within 40dB]	25 min. [within fn±100kHz]	6.0 max. [at minimum loss point]	1.5 max. [within fn±3kHz]	1500

For safety purposes, connect the output of filters to the IF amplifier through a D.C. blocking capacitor. Avoid applying a direct current to the output of ceramic filters.  
(fn) means nominal center frequency 455kHz.

### ■ Test Circuit

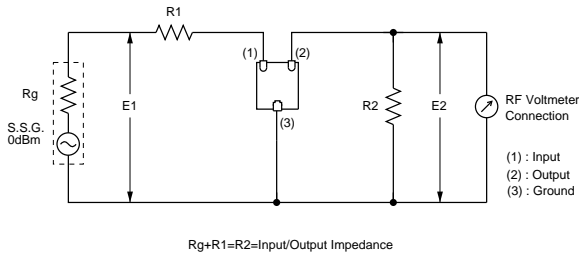

### Frequency Characteristics

CFUCG455KE4A-R0

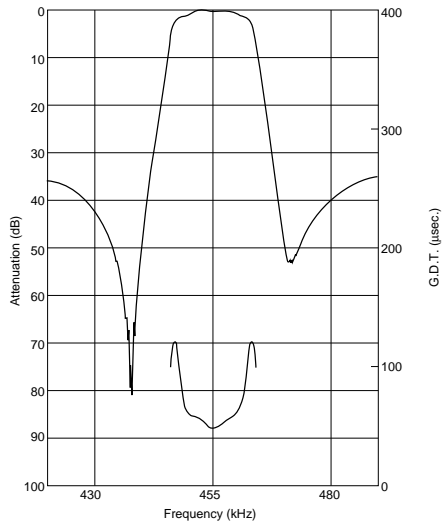

CFUCG455KE4A-R0

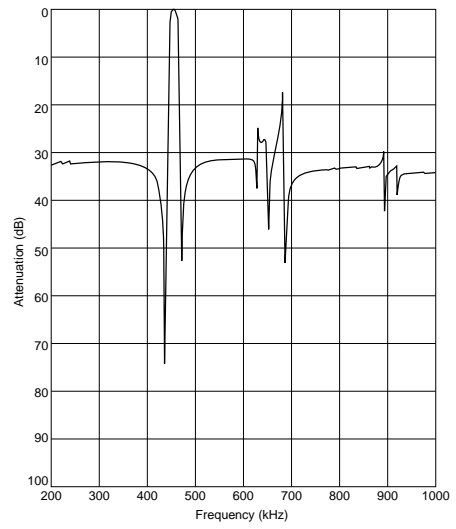

3

# Ceramic Filters (CERAFIL<sup>®</sup>)/Ceramic Discriminators for Communications Equipment



## CERAFIL<sup>®</sup> kHz SMD Type CFUCG\_X Series

The CFUCG\_X series comprises small, high performance, thin (4.0mm) filters consisting of 4 ceramic elements. The filters exhibit an extremely flat GDT characteristic combined with a narrow bandwidth. The filters are recommended for narrow band digital communication applications.

### ■ Features

1. The filters are mountable by automatic placers.
2. The filters can be reflow soldered and withstand washing.
3. They are slim, at only 4.0mm maximum thickness, and have a small mounting area (7.5x6.0mm) enabling flexible PCB design.
4. The bandwidth ranges from E to H.
5. Operating temperature range : -20 to +80 (degree C)  
Storage temperature range : -40 to +85 (degree C)

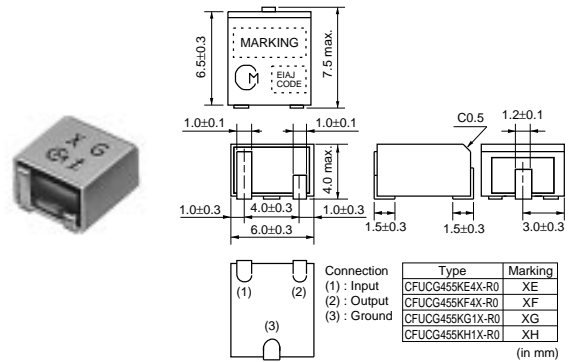

4

Part Number	Center Frequency (fo) (kHz)	6dB Bandwidth (kHz)	Stop Bandwidth (kHz)	Stop Band Attenuation (dB)	Insertion Loss (dB)	Ripple (dB)	GDT Deviation (μs)	Input/Output Impedance (ohm)
<b>CFUCG455KE4X-R0</b>	455.0 ±1.5kHz	fn±7.5 min.	fn±17.5 max. [within 40dB]	27 min. [within fn±100kHz]	6.0 max. [at minimum loss point]	1.0 max. [within fn±5kHz]	25.0 max. [within fn±5kHz]	1500
<b>CFUCG455KF4X-R0</b>	455.0 ±1.5kHz	fn±6.0 min.	fn±15.0 max. [within 40dB]	27 min. [within fn±100kHz]	6.0 max. [at minimum loss point]	1.0 max. [within fn±4kHz]	25.0 max. [within fn±4kHz]	1500
<b>CFUCG455KG1X-R0</b>	455.0 ±1.0kHz	fn±4.5 min.	fn±12.5 max. [within 40dB]	25 min. [within fn±100kHz]	6.0 max. [at minimum loss point]	1.0 max. [within fn±3kHz]	25.0 max. [within fn±3kHz]	1500
<b>CFUCG455KH1X-R0</b>	455.0 ±1.0kHz	fn±3.0 min.	fn±10.0 max. [within 40dB]	25 min. [within fn±100kHz]	7.0 max. [at minimum loss point]	1.0 max. [within fn±2kHz]	25.0 max. [within fn±2kHz]	1500

For safety purposes, connect the output of filters to the IF amplifier through a D.C. blocking capacitor. Avoid applying a direct current to the output of ceramic filters.  
(fn) means nominal center frequency 455kHz.

### ■ Test Circuit

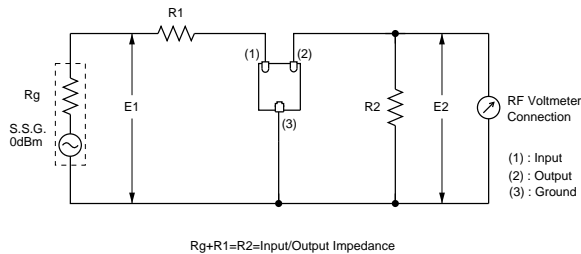

## Frequency Characteristics

CFUCG455KE4X-R0

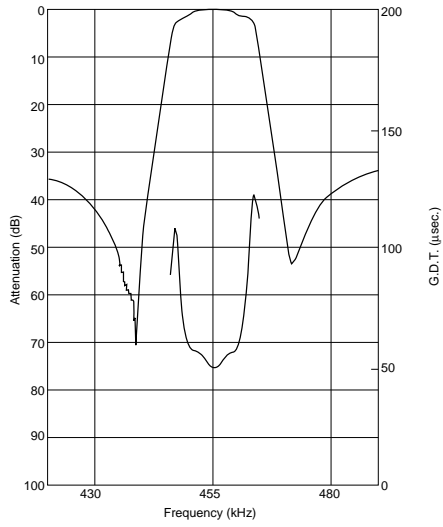

CFUCG455KE4X-R0

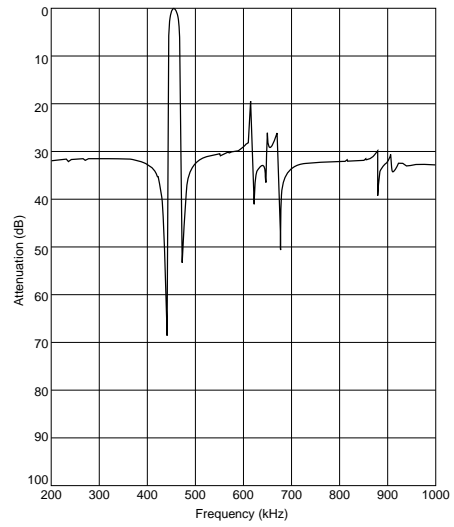

4



# Ceramic Filters (CERAFIL®)/Ceramic Discriminators for Communications Equipment



## CERAFIL® kHz SMD Type CFUCF Series

The CFUCF series comprises small, high performance, thin (4.0mm) filters consisting of 4 ceramic elements. The filters exhibit an extremely flat GDT characteristic. The filters are recommended for digital communication applications and are perfect in hand held cellular phones, etc.

### ■ Features

1. The filters are mountable by automatic placers.
2. The filters can be reflow soldered and withstand washing.
3. They are slim, at only 4.0mm maximum thickness, and have a small mounting area (7.5x6.0mm) enabling flexible PCB design.
4. The bandwidth ranges from A to E.
5. Operating temperature range : -20 to +80 (degree C)  
Storage temperature range : -40 to +85 (degree C)

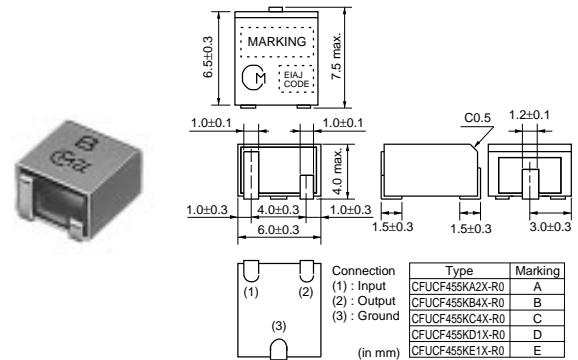

5

Part Number	Center Frequency (fo) (kHz)	6dB Bandwidth (kHz)	Stop Bandwidth (kHz)	Stop Band Attenuation (dB)	Insertion Loss (dB)	Ripple (dB)	GDT Deviation (μs)	Input/Output Impedance (ohm)
<b>CFUCF455KA2X-R0</b>	455.0 ±2.0kHz	fn±17.5 min.	fn±40.0 max. [within 40dB]	25 min. [within fn±100kHz]	4.0 max. [at minimum loss point]	1.0 max. [within fn±12kHz]	15.0 max. [within fn±12kHz]	1000
<b>CFUCF455KB4X-R0</b>	455.0 ±1.5kHz	fn±15.0 min.	fn±35.0 max. [within 40dB]	25 min. [within fn±100kHz]	5.0 max. [at minimum loss point]	1.0 max. [within fn±10kHz]	15.0 max. [within fn±10kHz]	1000
<b>CFUCF455KC4X-R0</b>	455.0 ±1.5kHz	fn±12.5 min.	fn±30.0 max. [within 40dB]	25 min. [within fn±100kHz]	6.0 max. [at minimum loss point]	1.0 max. [within fn±8kHz]	15.0 max. [within fn±8kHz]	1000
<b>CFUCF455KD1X-R0</b>	455.0 ±1.0kHz	fn±10.0 min.	fn±25.0 max. [within 40dB]	23 min. [within fn±100kHz]	7.0 max. [at minimum loss point]	1.0 max. [within fn±7kHz]	20.0 max. [within fn±7kHz]	1500
<b>CFUCF455KE1X-R0</b>	455.0 ±1.0kHz	fn±7.5 min.	fn±20.0 max. [within 40dB]	23 min. [within fn±100kHz]	8.0 max. [at minimum loss point]	1.0 max. [within fn±5kHz]	20.0 max. [within fn±5kHz]	1500

For safety purposes, connect the output of filters to the IF amplifier through a D.C. blocking capacitor. Avoid applying a direct current to the output of ceramic filters.  
(fn) means nominal center frequency 455kHz.

### ■ Test Circuit

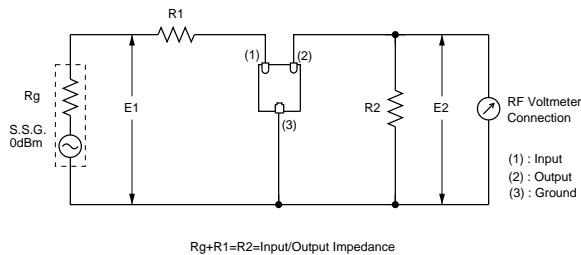

## Frequency Characteristics

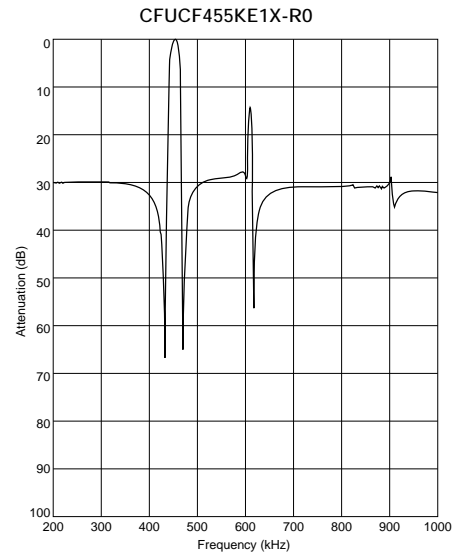
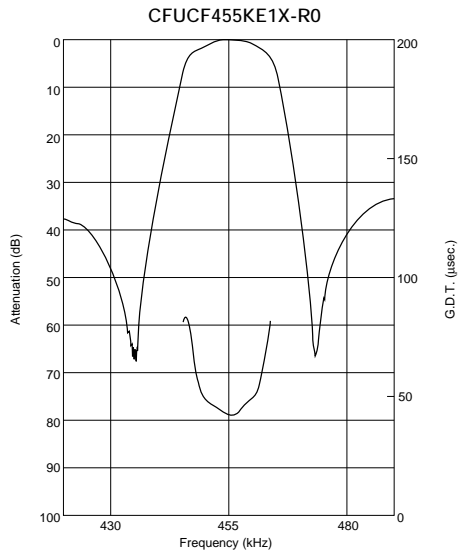

5

# Ceramic Filters (CERAFIL<sup>®</sup>)/Ceramic Discriminators for Communications Equipment



## CERAFIL<sup>®</sup> kHz SMD Type CFWCA Series

The CFWCA series comprises small, high performance, thin (3.0mm) filters consisting of 6 ceramic elements. The filters are recommend for pager or hand held cellular phones.

### ■ Features

1. The filters are mountable by automatic placers.
2. The filters can be reflow soldered and withstand washing.
3. They are slim, at only 3.0mm maximum thickness.
4. The filters are wide bandwidth, flat GDT within pass band.
5. Operating temperature range : -20 to +80 (degree C)  
Storage temperature range : -40 to +85 (degree C)

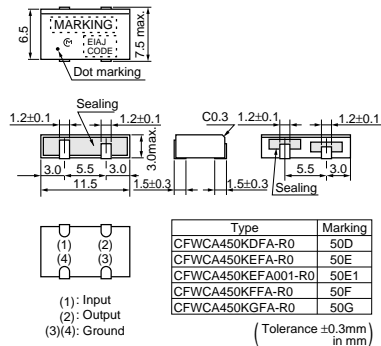

Part Number	Nominal Center Frequency (fn) (kHz)	3dB Bandwidth (kHz)	6dB Bandwidth (kHz)	Stop Bandwidth (kHz)	Stop Band Attenuation (dB)	Stop Band Att.(2) (dB)	Insertion Loss (dB)	Ripple (dB)	Input/Output Impedance (ohm)
<b>CFWCA450K DFA-R0</b>	450	-	fn±10.0 min.	fn±20.0 max. [within 50dB]	50 min. [within fn±100kHz]	-	4.0 max. [at minimum loss point]	3.0 max. [within fn±7kHz]	1500
<b>CFWCA450KEFA-R0</b>	450	-	fn±7.5 min.	fn±15.0 max. [within 50dB]	50 min. [within fn±100kHz]	-	6.0 max. [at minimum loss point]	3.0 max. [within fn±5kHz]	1500
<b>CFWCA450KEFA001-R0</b>	450	fn±6.5 min.	-	fn±15.0 max. [within 50dB]	55 min. [fn±18 to ±33kHz]	50 min. [within fn±100kHz]	4.0 max. [at fn]	3.0 max. [within fn±6.5kHz]	1500
<b>CFWCA450KFFA-R0</b>	450	-	fn±6.0 min.	fn±12.5 min. [within 50dB]	50 min. [within fn±100kHz]	-	6.0 max. [at minimum loss point]	3.0 max. [within fn±4kHz]	1500
<b>CFWCA450KGFA-R0</b>	450	-	fn±4.5 min.	fn±11.0 max. [within 50dB]	50 min. [within fn±100kHz]	-	6.0 max. [at minimum loss point]	2.0 max. [within fn±3kHz]	1500

For safety purposes, connect the output of filters to the IF amplifier through a D.C. blocking capacitor. Avoid applying a direct current to the output of ceramic filters.

### ■ Test Circuit

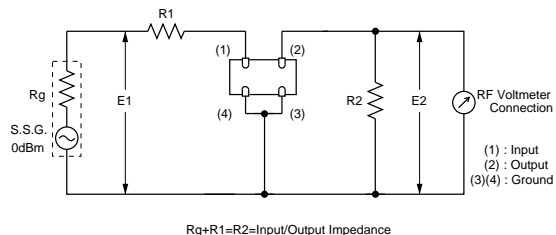

## Frequency Characteristics

CFWCA450KEFA001-R0

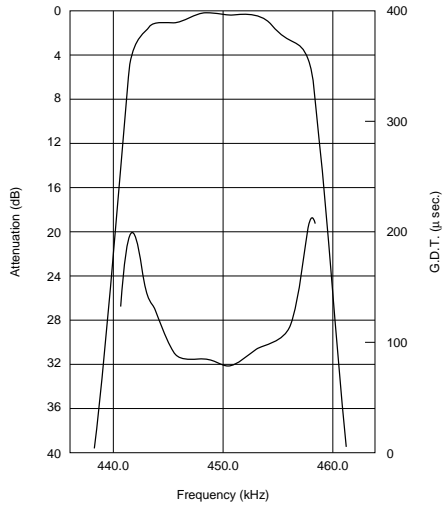

CFWCA450KEFA001-R0

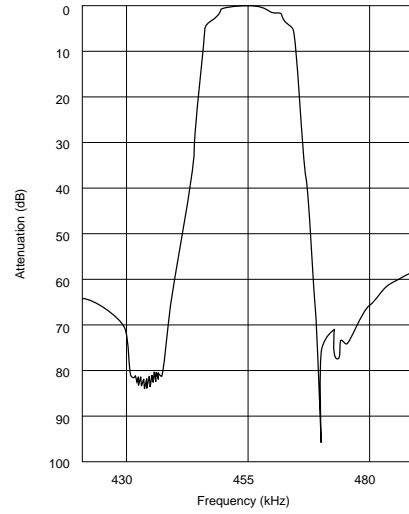

CFWCA450KEFA001-R0

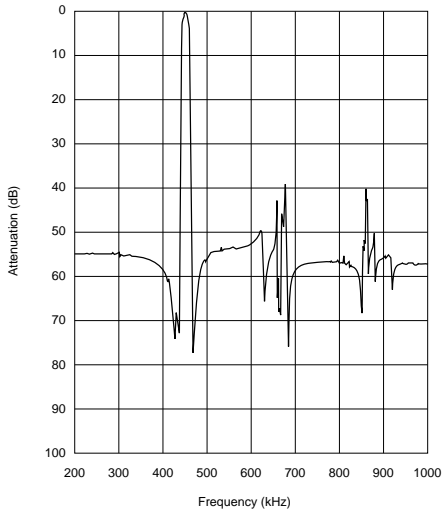

# Ceramic Filters (CERAFIL®)/Ceramic Discriminators for Communications Equipment



## CERAFIL® kHz SMD Type CFWCA\_Y Series

The CFWCA\_Y series comprises small, high performance, thin (3.0mm) filters consisting of 6 ceramic elements. The filters are recommend for digital communication applications and are perfect in hand held cellular phones.

### ■ Features

1. The filters are mountable by automatic placers, and can be reflow soldered, and withstand washing.
2. They are slim, at only 3.0mm maximum thickness.
3. The filters are wide bandwidth, flat GDT within pass band.
4. Operating temperature range : -20 to +80 (degree C)  
Storage temperature range : -40 to +85 (degree C)

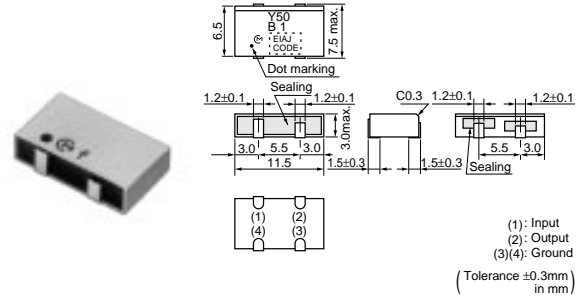

Part Number	Nominal Center Frequency (fn) (kHz)	3dB Bandwidth (kHz)	6dB Bandwidth (kHz)	Stop Bandwidth (kHz)	Stop Band Attenuation (dB)	Insertion Loss (dB)	Spurious Response (dB)	GDT Deviation (μs)	Input/Output Impedance (ohm)
<b>CFWCA450KBFY001-R0</b>	450	fn±11.5 min.	fn±13.0 min.	fn±30.0 max. [within 50dB]	45 min. [within fn±100kHz]	4.0 max. [at minimum loss point]	20 min. [within 0.1 to 1.0MHz]	30.0 max. [within fn±10kHz]	1000

For safety purposes, connect the output of filters to the IF amplifier through a D.C. blocking capacitor. Avoid applying a direct current to the output of ceramic filters.

### ■ Test Circuit

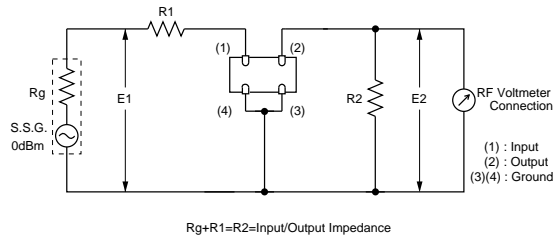

## Frequency Characteristics

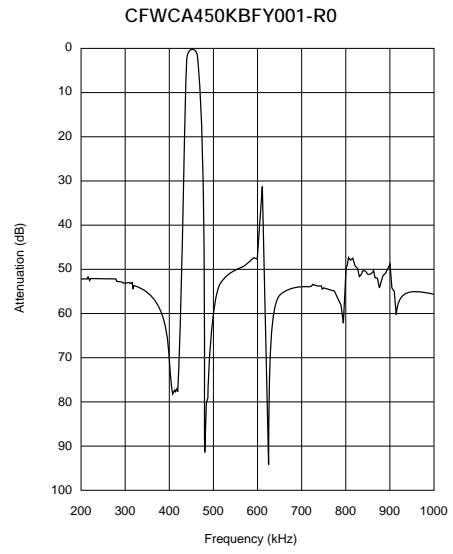
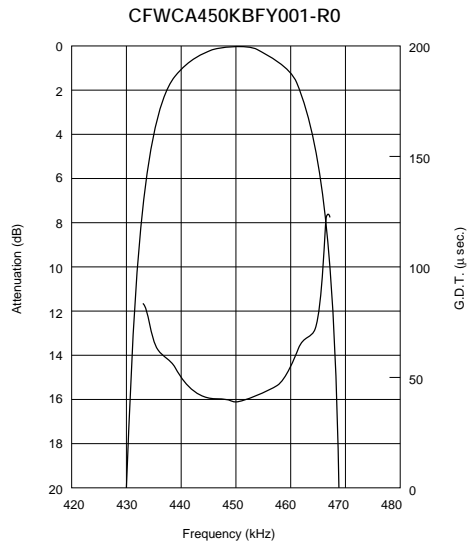

## kHz SMD Type CERAFIL® Notice

### ■ CFXC\_ Series Notice (Soldering and Mounting)

#### 1. Standard Reflow Soldering Condition

##### (1) Reflow

Filter is soldered twice within the following temperature condition and then being placed in natural condition for 24 hours.

##### (2) Soldering Iron

Electrode is directly contacted with the tip of soldering iron of  $+350\pm 5^{\circ}\text{C}$  for  $3\pm 1$  seconds, and then being placed in natural condition for 24 hours.

#### 2. Wash

The component cannot be withstand washing.

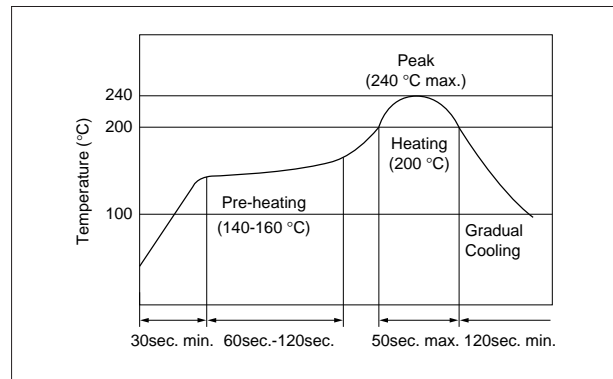

### ■ SFPCA/CFUCG/CFUCF Series Notice (Soldering and Mounting)

#### 1. Standard Reflow Soldering Condition

##### (1) Reflow

Filter is soldered one time within the following temperature condition and then being placed in natural condition for 24 hours.

##### (2) Soldering Iron

Electrode is directly with the tip of soldering iron of  $+350\pm 5^{\circ}\text{C}$  for  $3\pm 1$  seconds, and then being placed in natural condition for 24hours.

#### 2. Wash

##### (1) Cleaning Solvent

CFC alternatives(HCFC Series), Isopropyl Alcohol(IPA), Water(Demineralized Water), Cleaning Water Solution(Cleanthrough-750H, Pine Alha 100S), Silicon(Technocare FRW)

##### (2) Cleaning Conditions

- Immersion Wash  
2 minutes max. in above solvent at  $+60^{\circ}\text{C}$  max.
- Shower or Rinse Wash  
2 minutes max. in above solvent at  $+60^{\circ}\text{C}$  max.

##### (3) Notice

- When components are immersed in solvent, be sure to maintain the temperature of components below the temperature of solvent.
- Please do not use ultrasonic cleaning.
- Total washing time should be within 4minutes.
- Please ensure the component is thoroughly evaluated in your application circuit.
- Please do not use chlorine, petroleum and alkali cleaning solvent.
- If you plan to use any other type of solvents, please consult with Murata or MURata representative prior to using.

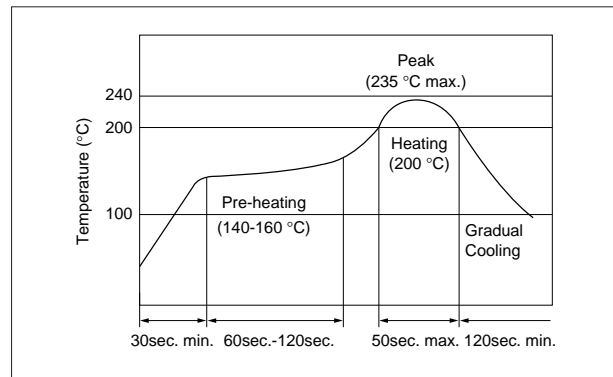

Continued on the following page.

## kHz SMD Type CERAFIL® Notice

☒ Continued from the preceding page.

### ■ CFWCA Series Notice (Soldering and Mounting)

#### 1. Standard Reflow Soldering Condition

##### (1) Reflow

Filter is soldered once within the following temperature condition and then being placed in natural condition for 24 hours.

##### (2) Soldering Iron

Electrode is directly contacted with the tip of soldering iron of  $+350\pm 5^{\circ}\text{C}$  for  $3\pm 1$  seconds, and then being placed in natural condition for 24 hours.

#### 2. Wash

The component cannot be withstand washing.

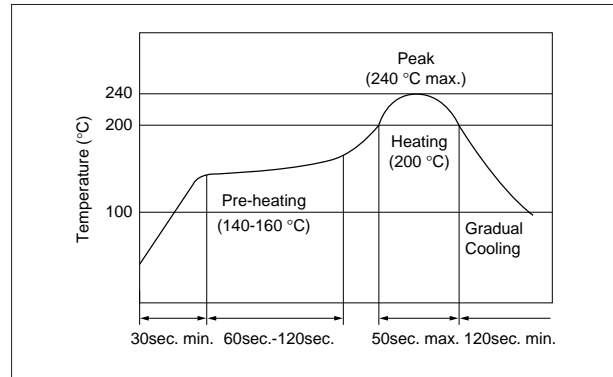

### ■ CFXC\_/CFWCA Series Notice (Handling)

1. The component will be damaged when an excessive stress is applied.
2. Use coupling capacitors to prevent applying D.C. voltage between input-ground, output-ground of "CERAFIL" as D.C. current may harm the component.
3. Do not clean or wash the component as it's not hermetically sealed.
4. Do not apply conformal coating onto the component as it's not hermetically sealed.
5. Do not use strong acidity flux, more than 0.2wt% chlorine content, in re-flow soldering.

### ■ SFPCA/CFUCG/CFUCF Series Notice (Handling)

1. The component will be damaged when an excessive stress is applied.
2. Use coupling capacitors to prevent applying D.C. voltage between input-ground, output-ground of "CERAFIL" as D.C. current may harm the component.
3. In the case that the component is cleaned, confirm no reliability degradation is created.
4. In case of covering filter with over coat, conditions such as material of resin, cure temperature, and so on should be evaluated well.
5. Do not use strong acidity flux, more than 0.2wt% chlorine content, in re-flow soldering.
6. The product, packed in the moisture-proof bag (dry pack), is sensitive to moisture. The following treatment is required before applying re-flow soldering, to avoid package cracks or reliability degradation caused by thermal stress. When unpacked, store the component in an atmosphere of below 25 C. and below 65% R.H., and solder within 48 hours.



# SMD Type CERAFIL® Standard Land Pattern Dimensions

## ■ CFXCD Series

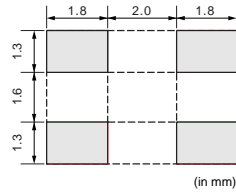

## ■ SFPCA Series

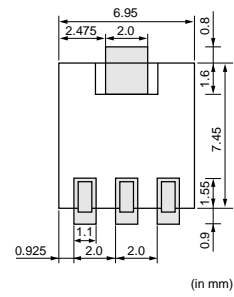

## ■ CFUCG/CFUCF Series

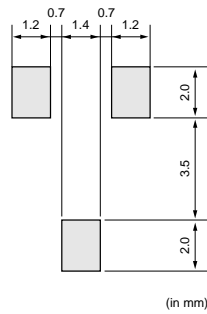

## ■ CFWCA Series

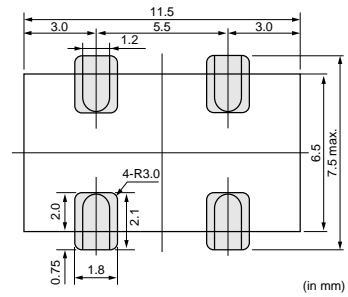

## ■ CFXCA Series

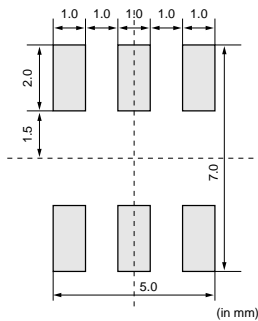

## ■ SF ECS Series

