

Dielectric Filters (GIGAFIL®)



muRata *Innovator
in Electronics*

Murata
Manufacturing Co., Ltd.

Cat.No.O81E-2

for EU RoHS Compliant

- All the products on this catalog are complied with EU RoHS.
- EU RoHS is "the European Directive 2002/95/EC on the Restriction of the Use of Certain Hazardous Substances in Electrical and Electronic Equipment".
- For more details, please refer to our website 'Murata's Approach for EU RoHS' (<http://www.murata.com/info/rohs.html>).

CONTENTS

1

GIGAFIL® in this catalog is the trademark of Murata Manufacturing Co., Ltd.

Part Numbering	2
1 Band Pass Filters	3
DFCB Series 800/900MHz	3
DFCB/DFCL Series 1.5-5GHz	4
DFCH Series 800/900MHz	7
DFCH Series 1.5-2.5GHz	8
2 Duplexers	10
AMPS/CDMA800: DFYH Series	10
EGSM: DFYH Series	11
DCS1800: DFYH Series	13
PCS1.9: DFYH Series	15
W-DCMA: DFYH Series	16
LMR: DFYH Series	17
MSAT: DFYF Series	18
Notice/Packaging/Soldering and Mounting	19

2

● Part Numbering

Antenna/Duplexer Dielectric Filters (GIGAFIL®)
 for RF/Local Dielectric Band Pass Filters (GIGAFIL®)

(Part Number)

DF	YK6	1G95	LBNBB-	TT1
----	-----	------	--------	-----

① ② ③ ④ ⑤

① Product ID

Product ID	
DF	Microwave Filters (GIGAFIL®)

② Series

Two capital letters and a number express the series name.

③ Nominal Center Frequency

Expressed by four-digit alphanumerics. If the unit is "MHz", it is expressed by three figures plus "M". If the unit is "GHz", a decimal point is expressed by capital letter "G".

④ Individual Specification Code

Expressed by five letters plus a hyphen.

⑤ Packaging

Code	Packaging
T**	Tray
R**	Reel

Packaging varies on each product type. Please contact us for details.

Dielectric Filters (GIGAFIL®)



Band Pass Filters

DFCB Series 800/900MHz

■ Features

1. Low insertion loss for using high Q-value dielectric resonators.
2. Small and light for using high dielectric constant ceramics.
3. Excellent temperature stability for temperature compensated dielectric constant ($0 \pm 5 \text{ppm}/(\text{degree C})$ max).
4. Excellent mechanical stability without vibratile structure.
5. SMD and reflow soldering is available.
6. Mountable by automatic placing machine.

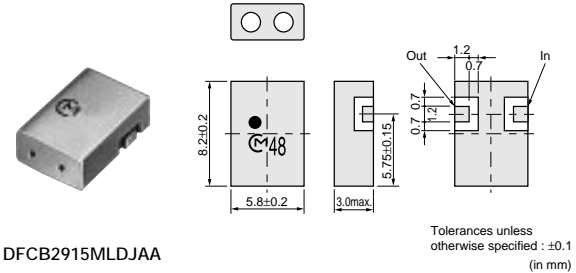

DFCB2915MLDJAA

■ Characteristics

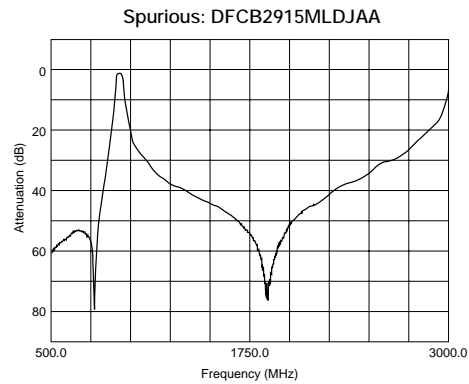
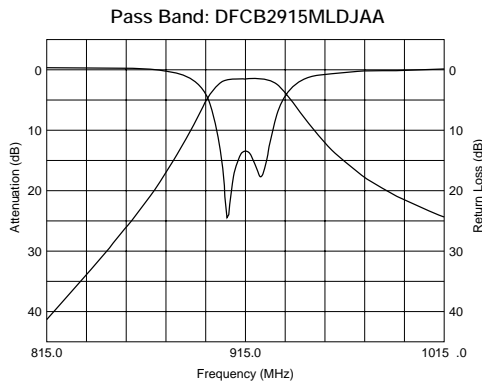

Application	Part Number	fo (MHz)	Bandwidth (MHz)	IL at BW (dB max.)	Attenuation (dB min.)	Operation Temperature Range (°C)
AMPS	DFCB2836MLDJAA	836.5	25	2.6	6.5 (869 to 894MHz)	-35 to +85
AMPS	DFCB2881MLDJAA	881.5	25	2.6	9 (824 to 849MHz)	-35 to +85
GSM	DFCB2902MLDJAA	902.5	25	2.6	27 (Fo-77.5MHz)	-35 to +85
WLAN915	DFCB2915MLDJAA	915	26	2.5	27 (837.5MHz)	-35 to +85
GSM	DFCB2947MLDJAA	947.5	25	2.6	27 (Fo-77.5MHz)	-35 to +85
LMR	DFCB3815MLDJAA	815.5	19	2.5	12 (Fo±35.5MHz)	-35 to +85
AMPS	DFCB3836MLDJAA	836.5	25	3.0	12 (869 to 894MHz)	-35 to +85
LMR	DFCB3860MLDJAA	860.5	19	2.5	13 (Fo+35.5MHz)	-35 to +85
AMPS	DFCB3881MLDJAA	881.5	25	3.0	15 (824 to 849MHz)	-35 to +85
GSM	DFCB3902MLDJAA	902.5	25	3.0	45 (Fo-77.5MHz)	-35 to +85
WLAN915	DFCB3915MLDJAA	915	26	3.0	15 (Fo-32.5MHz)	-35 to +85
GSM	DFCB3947MLDJAA	947.5	25	3.0	45 (Fo-77.5MHz)	-35 to +85

DFCB/DFCL Series 1.5-5GHz

■ Features

1. Low insertion loss for using high Q-value dielectric resonators.
2. Small and light for using high dielectric constant ceramics.
3. Excellent temperature stability for temperature compensated dielectric constant ($0 \pm 5 \text{ ppm}/(\text{degree C}) \text{ max}$).
4. Excellent mechanical stability without vibratile structure.
5. SMD and reflow soldering is available.
6. Mountable by automatic placing machine.

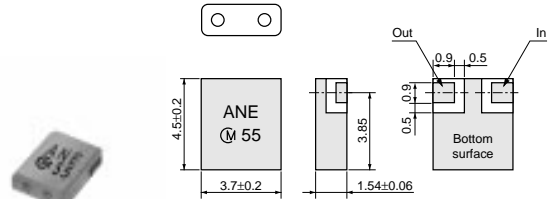

DFCL22G33LANAC

Tolerances unless otherwise specified: ± 0.1 (in mm)

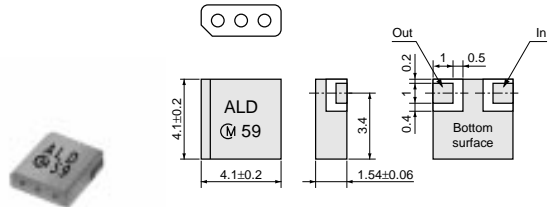

DFCL32G33LANAA

Tolerances unless otherwise specified: ± 0.1 (in mm)

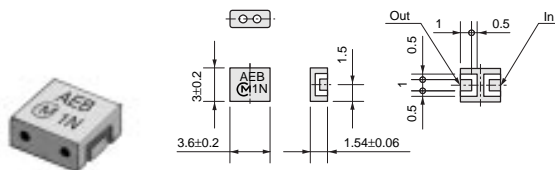

DFCB25G25LAHAA

Tolerances unless otherwise specified: ± 0.1 (in mm)

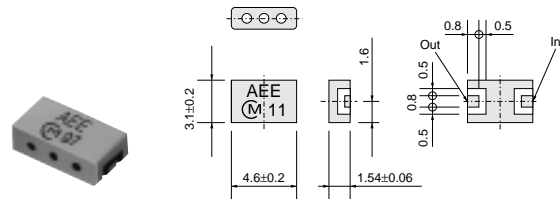

DFCB35G25LAHAA

Tolerances unless otherwise specified: ± 0.1 (in mm)

■ Characteristics

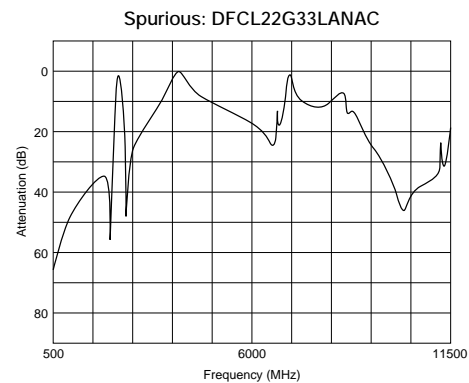
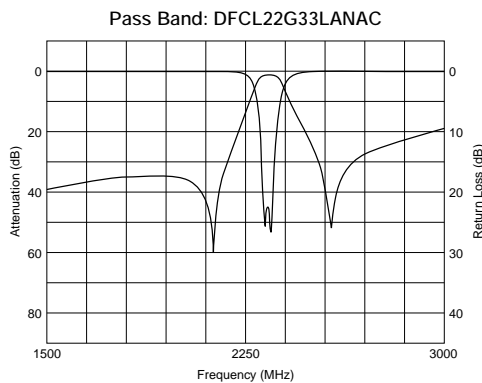

Continued on the following page. ↗

Continued from the preceding page.

Characteristics

1

Pass Band: DFCL32G33LANAA

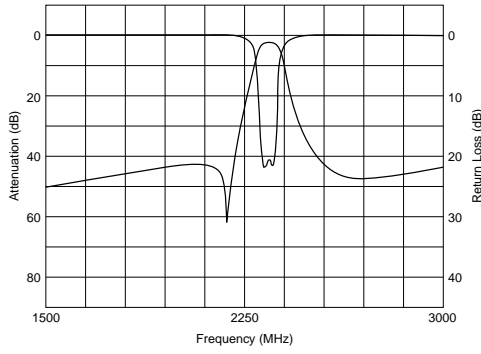

Spurious: DFCL32G33LANAA

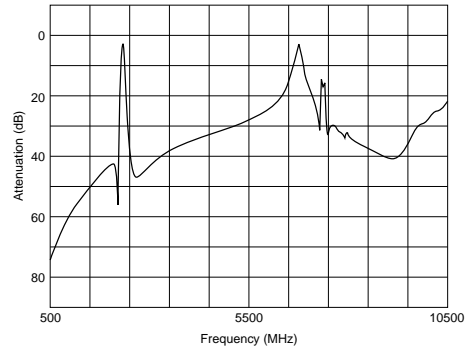

Pass Band: DFCB25G25LAHAA

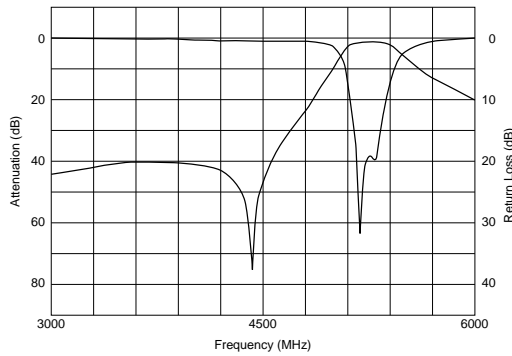

Spurious: DFCB25G25LAHAA

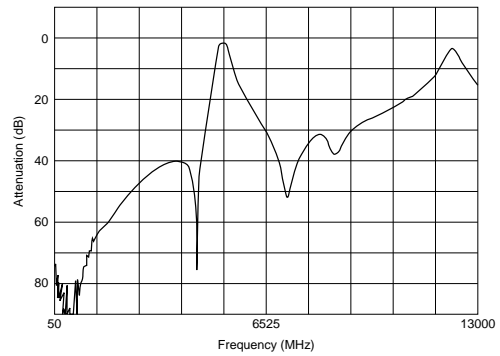

Pass Band: DFCB35G25LAHAA

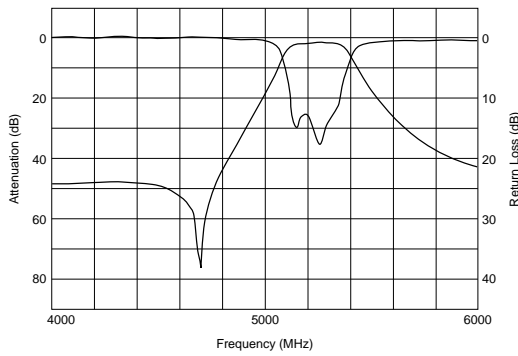

Spurious: DFCB35G25LAHAA

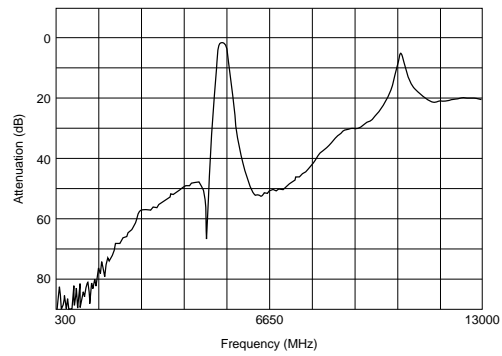

Application	Part Number	fo (MHz)	Bandwidth (MHz)	IL at BW (dB max.)	Attenuation (dB min.)	Operation Temperature Range (°C)
DAB	DFCB21G47LBJAA	1472	40	2.0	38 (1122MHz)	-40 to +85
GPS	DFCB21G57LBJAB	1575.42	3	1.3	37 (1850 to 1910MHz)	-35 to +85
GPS	DFCL21G57LBJAE	1575.42	2.046	3.9	30 (1475.42MHz)	-35 to +85
GPS	DFCB21G57LCJAA	1575.42	2	3.5	15 (Fo±50MHz)	-40 to +85
GPS	DFCB21G57LDJAB	1575.42	2	3.15	18 (Fo±50MHz)	-35 to +85
DCS1800	DFCB21G84LDJAA	1842.5	75	2.0	20 (Fo-160MHz)	-35 to +85
DECT	DFCB21G89LBJAA	1890	20	2.0	40 (1660 to 1680MHz)	-35 to +85
DECT	DFCB21G89LDJAA	1890	20	2.0	45 (1660 to 1680MHz)	-40 to +85
CDMA1.9	DFCB21G92LDJAA	1920	20	1.9	16 (1800 to 1820MHz)	-40 to +85
PCS1.9	DFCB21G96LDJAA	1960	60	1.5	17 (2360MHz)	-35 to +85
Sirius Radio	DFCB22G32LBJAA	2326	14	1.8	8.5 (2227MHz)	-35 to +85
XM Satellite	DFCL22G33LANAC	2339	14	2.0	22 (0.3 to 2188MHz)	-40 to +125

Continued on the following page.

Continued from the preceding page.

1

Application	Part Number	fo (MHz)	Bandwidth (MHz)	IL at BW (dB max.)	Attenuation (dB min.)	Operation Temperature Range (°C)
Wibro	DFCB22G34LBJAA	2345	80	2.5	20 (350 to 1200MHz)	-35 to +85
WLAN2.4	DFCB22G44LBJAA	2442	84	2.0	16 (Fo-250MHz)	-40 to +85
WLAN2.4	DFCB22G45LBJAA	2450	100	2.0	15 (Fo-250MHz)	-40 to +85
WLAN5G	DFCB25G25LAHAA	5250	200	1.5	38 (4370 to 4510MHz)	-35 to +85
WLAN5G	DFCB25G59LAHAA	5597.5	255	1.5	11 (Fo-375MHz)	-35 to +85
WLAN5G	DFCB25G77LAHAA	5775	100	1.5	12 (Fo-375MHz)	-35 to +85
DAB	DFCB31G47LBJAA	1472	40	3.0	45 (1100MHz)	-35 to +85
DCS1800	DFCB31G74LBJAA	1747.5	75	3.5	45 (1464 to 1539MHz)	-35 to +85
DCS1800	DFCB31G84LBJAA	1842.5	75	3.5	45 (1559 to 1634MHz)	-35 to +85
DCS1800	DFCB31G84LBJAB	1842.5	75	2.75	45 (0.3 to 1500MHz)	-35 to +85
PCS1.9	DFCB31G88LBJAA	1880	60	3.7	43 (1640 to 1664MHz)	-35 to +85
PCS1.9	DFCB31G88LBJAB	1880	60	4.0	41 (2043 to 2103MHz)	-35 to +85
W-CDMA	DFCB31G95LBJAA	1950	60	3.5	35 (2110 to 2170MHz)	-35 to +85
PCS1.9	DFCB31G96LBJAA	1960	60	3.7	5 (1910MHz)	-35 to +85
PCS1.9	DFCB31G96LBJAB	1960	60	3.0	10 (1498 to 1860MHz)	-35 to +85
W-CDMA	DFCB32G14LBJAA	2140	60	3.7	30 (1920 to 1980MHz)	-35 to +85
Sirius Radio	DFCB32G32LBJAA	2326	14	3.0	24 (2227MHz)	-35 to +85
XM Satellite	DFCL32G33LANAA	2339	14	3.0	39 (0.3 to 2188MHz)	-40 to +125
WLAN2.4	DFCB32G44LBJAA	2442	84	3.2	30 (Fo-250MHz)	-40 to +85
WLAN2.4	DFCB32G45LBJAA	2450	100	3.2	30 (Fo-250MHz)	-40 to +85
MMDS/WiMax	DFCB32G59LBHAA	2595	190	2.0	40 (1930 to 2170MHz)	-35 to +85
MMDS/WiMax	DFCB32G59LBHAB	2595	190	1.5	35 (1930 to 2170MHz)	-35 to +85
FWA	DFCL33G40LCHAA	3400	200	2.0	38 (3050MHz)	-35 to +85
FWA	DFCL33G40LCHAB	3400	200	1.3	30 (3050MHz)	-35 to +85
WiMAX	DFCL33G50LCHAA	3500	200	2.0	38 (3150MHz)	-35 to +85
WiMAX	DFCL33G50LCHAB	3500	200	1.3	30 (3150MHz)	-35 to +85
WiMAX	DFCL33G55LCHAB	3550	300	3.0	40 (450MHz)	-35 to +85
FWA	DFCL33G60LCHAA	3600	200	2.0	38 (3250MHz)	-35 to +85
FWA	DFCL33G60LCHAB	3600	200	1.3	30 (3250MHz)	-35 to +85
FWA	DFCL33G70LCHAA	3700	200	2.0	38 (3350MHz)	-35 to +85
FWA	DFCL33G70LCHAB	3700	200	1.3	30 (3350MHz)	-35 to +85
WLAN5G	DFCB35G25LAHAA	5250	200	3.3	45 (4450 to 4650MHz)	-35 to +85
WLAN5G	DFCB35G59LAHAA	5597.5	255	3.6	45 (4750 to 5000MHz)	-35 to +85
WLAN5G	DFCB35G77LAHAA	5775	100	3.0	30 (Fo-375MHz)	-35 to +85

DFCH Series 800/900MHz

■ Features

1. Low insertion loss for using high Q-value dielectric resonators.
2. Small and light for using high dielectric constant ceramics.
3. Excellent temperature stability for temperature compensated dielectric constant ($0 \pm 5 \text{ ppm}/(\text{degree C})$ max).
4. Excellent mechanical stability without vibratile structure.
5. SMD and reflow soldering is available.
6. Mountable by automatic placing machine.

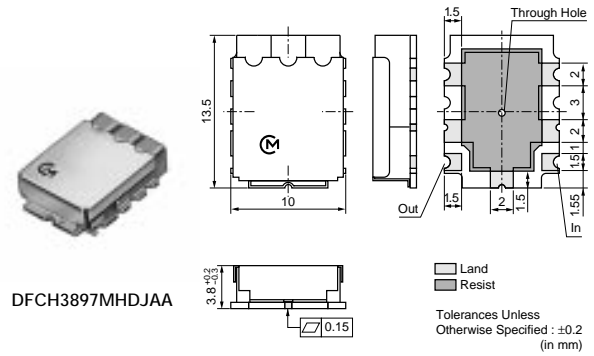

■ Characteristics

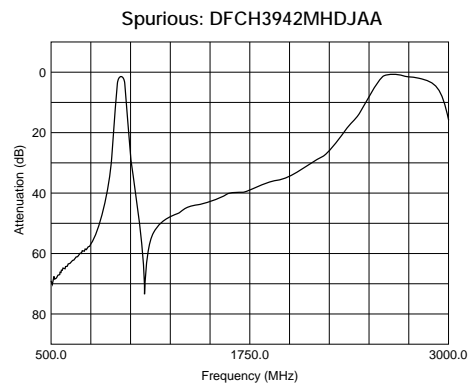
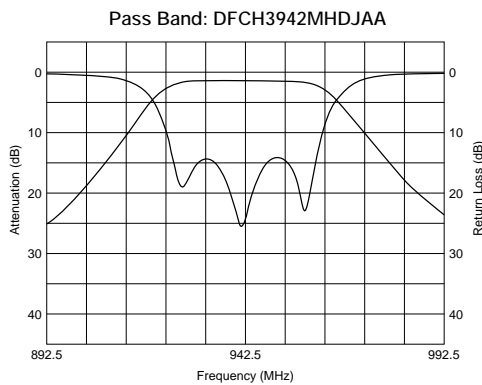
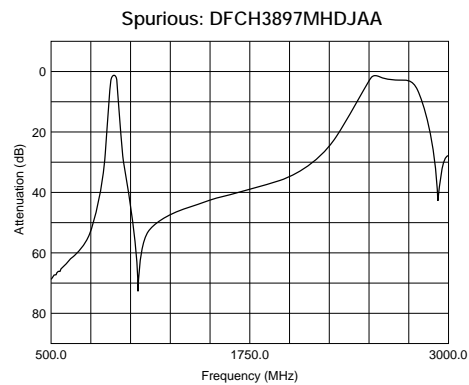
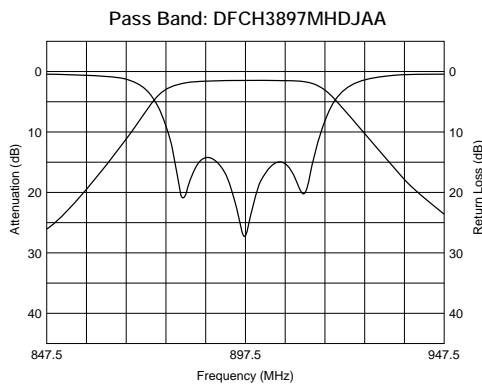

Application	Part Number	fo (MHz)	Bandwidth (MHz)	IL at BW (dB max.)	Attenuation (dB min.)	Operation Temperature Range (°C)
LMR	DFCH3815MHDJAA	815	20	2.8	36 (Fo±80MHz)	-35 to +85
AMPS	DFCH3836MHDJAA	836.5	25	2.6	12 (Fo±32.5MHz)	-35 to +85
LMR	DFCH3860MHDJAA	860	20	2.8	36 (Fo±80MHz)	-35 to +85
AMPS	DFCH3881MHDJAA	881.5	25	2.6	12 (Fo±32.5MHz)	-35 to +85
EGSM	DFCH3897MHDJAA	897.5	35	3.0	6 (Fo±27.5MHz)	-35 to +85
GSM	DFCH3902MHDJAA	902.5	25	2.6	12 (Fo±32.5MHz)	-35 to +85
EGSM	DFCH3942MHDJAA	942.5	35	3.0	6 (Fo±27.5MHz)	-35 to +85
GSM	DFCH3947MHDJAA	947.5	25	2.6	12 (Fo±32.5MHz)	-35 to +85
EGSM	DFCH4897MHDJAA	897.5	35	4.6	13 (Fo±27.5MHz)	-35 to +85
EGSM	DFCH4942MHDJAA	942.5	35	4.6	13 (Fo±27.5MHz)	-35 to +85

DFCH Series 1.5-2.5GHz

■ Features

1. Low insertion loss for using high Q-value dielectric resonators.
2. Small and light for using high dielectric constant ceramics.
3. Excellent temperature stability for temperature compensated dielectric constant ($0 \pm 5 \text{ ppm}/(\text{degree C})$ max).
4. Excellent mechanical stability without vibratile structure.
5. SMD and reflow soldering is available.
6. Mountable by automatic placing machine.

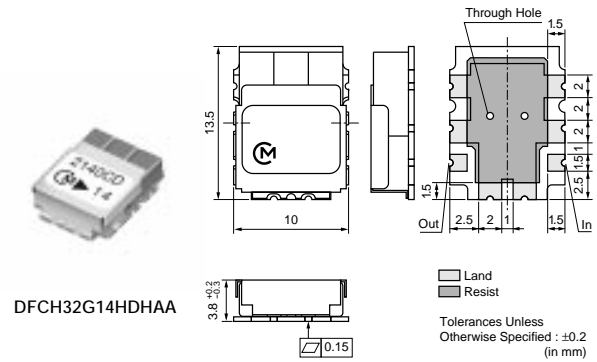
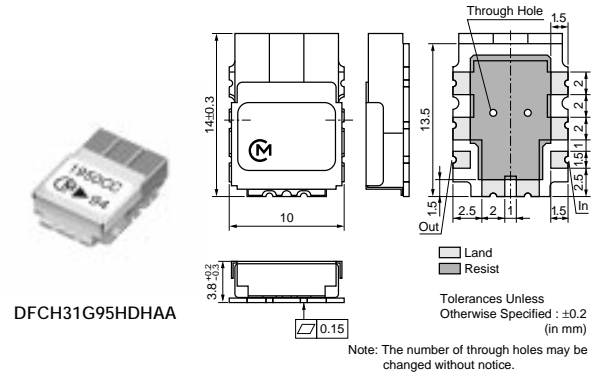

■ Characteristics

Pass Band: DFCH31G95HDHAA

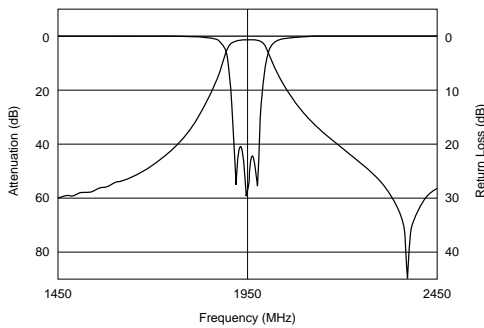

Spurious: DFCH31G95HDHAA

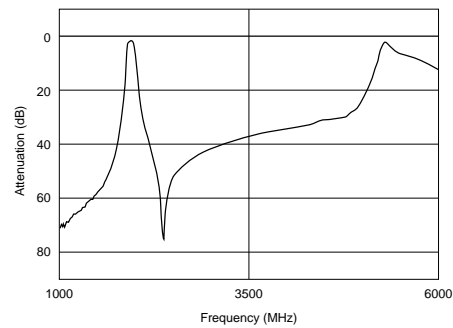

Pass Band: DFCH32G14HDHAA

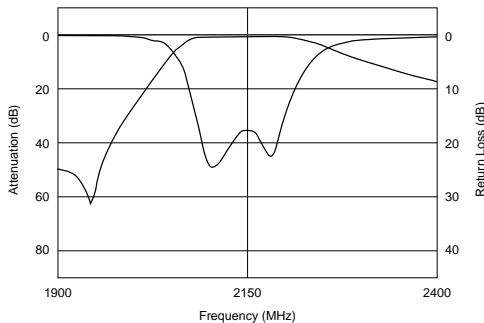

Spurious: DFCH32G14HDHAA

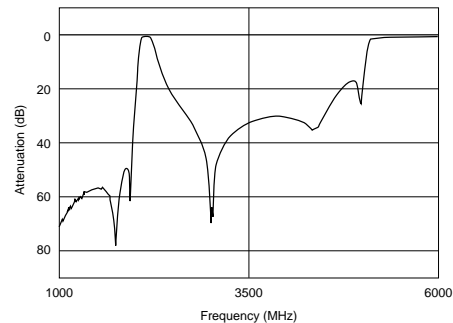

1

Application	Part Number	fo (MHz)	Bandwidth (MHz)	IL at BW (dB max.)	Attenuation (dB min.)	Operation Temperature Range (°C)
GPS	DFCH21G57HDHAA	1575.5	2	0.9	16 (Fo-140MHz)	-35 to +85
TD-SCDMA	DFCH22G01HDJAA	2017.5	15	1.8	22 (1899 to 1915MHz)	-40 to +85
WLAN2.4	DFCH22G44HDHAA	2442	84	1.2	15 (Fo±250MHz)	-35 to +85
WLAN2.4	DFCH22G45HDHAA	2450	100	1.0	16 (Fo-250MHz)	-35 to +85
MSAT	DFCH31G54HDJAA	1542	34	3.0	30 (1626.5 to 1660.5MHz)	-35 to +85
MSAT	DFCH31G64HDJAA	1643.5	34	3.0	30 (1525 to 1559MHz)	-35 to +85
DCS1800	DFCH31G74HDJAA	1747.5	75	2.0	8 (Fo±80MHz)	-35 to +85
DCS1800	DFCH31G84HDJAA	1842.5	75	2.0	8 (Fo±80MHz)	-35 to +85
PCS1.9	DFCH31G88HDJAA	1880	60	2.2	15 (Fo±100MHz)	-35 to +85
W-CDMA	DFCH31G95HDHAA	1950	60	1.8	45 (1550MHz)	-35 to +85
PCS1.9	DFCH31G96HDJAA	1960	60	2.2	15 (Fo±100MHz)	-35 to +85
TD-SCDMA	DFCH32G01HDNAA	2017.5	15	3.0	38 (1920MHz)	-35 to +85
W-CDMA	DFCH32G14HDHAA	2140	60	1.3	52 (1325 to 1385MHz)	-35 to +85
WLAN2.4	DFCH32G44HDHAA	2442	84	2.4	36 (Fo-250MHz)	-35 to +85
WLAN2.4	DFCH32G45HDHAA	2450	100	2.3	36 (Fo-250MHz)	-35 to +85
MMDS/WiMax	DFCH32G59HDHBA	2593	186	1.0	30 (1930 to 1990MHz)	-35 to +85
DCS1800	DFCH41G74HDJAA	1747.5	75	3.6	10 (Fo±57.5MHz)	-35 to +85
DCS1800	DFCH41G84HDJAA	1842.5	75	3.6	10 (Fo±57.5MHz)	-35 to +85
PCS1.9	DFCH41G88HDJAA	1880	60	4.5	12 (Fo±50MHz)	-35 to +85
PCS1.9	DFCH41G96HDJAA	1960	60	4.5	12 (Fo±50MHz)	-35 to +85

Dielectric Filters (GIGAFIL®)



Duplexers

2

AMPS/CDMA800: DFYH Series

■ Features

1. Low insertion loss for using high Q-value dielectric resonators.
2. Small and light for using high dielectric constant ceramics.
3. Excellent temperature stability for temperature compensated dielectric constant ($0 \pm 5 \text{ ppm}/(\text{degree C})$ max).
4. Excellent mechanical stability without vibratile structure.
5. SMD and reflow soldering is available.
6. Mountable by automatic placing machine.

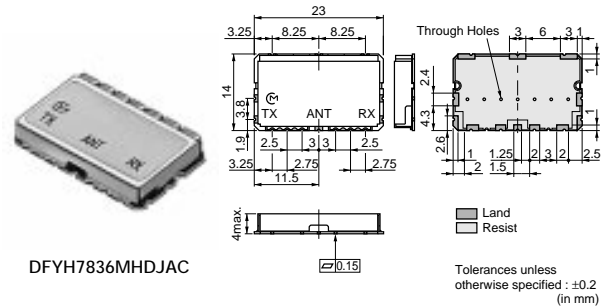

DFYH7836MHDJAC

■ Characteristics

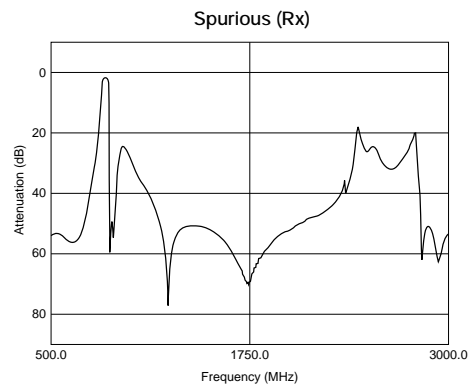
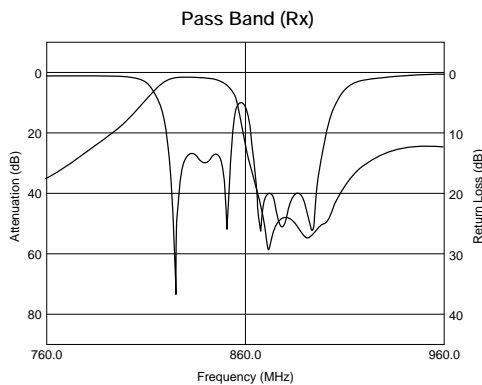
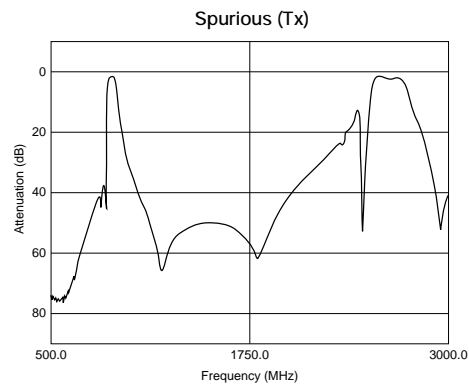
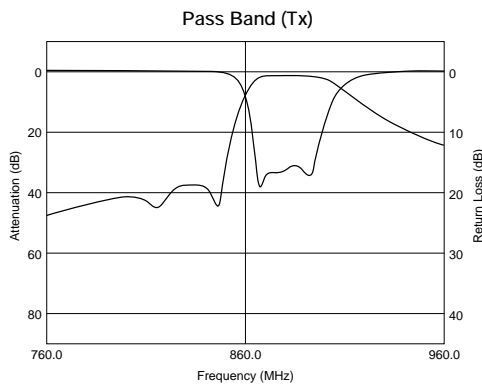

Part Number	fo (Tx) (MHz)	Bandwidth (Tx) (MHz)	IL at BW (dB max.)	Attenuation (dB min.)	fo (Rx) (MHz)	Bandwidth (Rx) (MHz)	IL at BW (dB max.)	Attenuation (dB min.)	Operation Temperature Range (°C)
DFYH7836MHDJAC	881.5	25	3.0	35 (824 to 849MHz)	836.5	25	4.0	45 (869 to 894MHz)	-30 to +85

EGSM: DFYH Series

Features

1. Low insertion loss for using high Q-value dielectric resonators.
2. Small and light for using high dielectric constant ceramics.
3. Excellent temperature stability for temperature compensated dielectric constant ($0 \pm 5 \text{ppm}/(\text{degree C})$ max).
4. Excellent mechanical stability without vibratile structure.
5. SMD and reflow soldering is available.
6. Mountable by automatic placing machine.

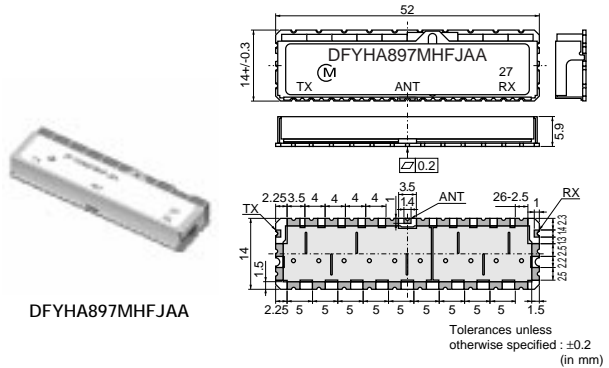
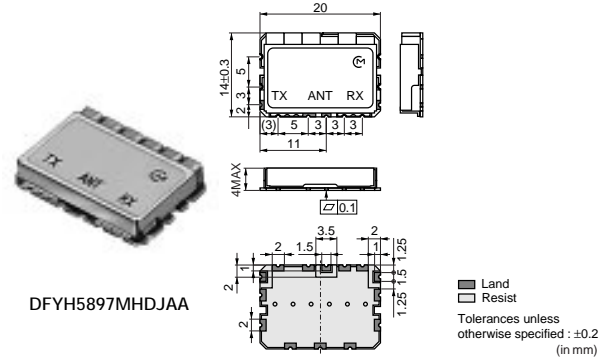

Characteristics

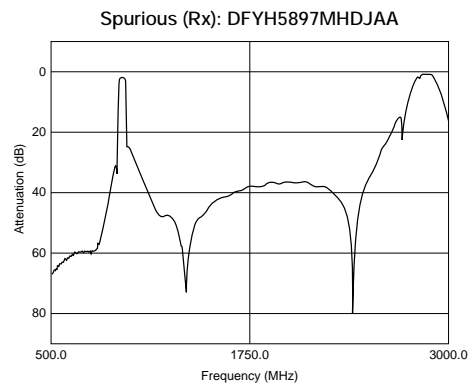
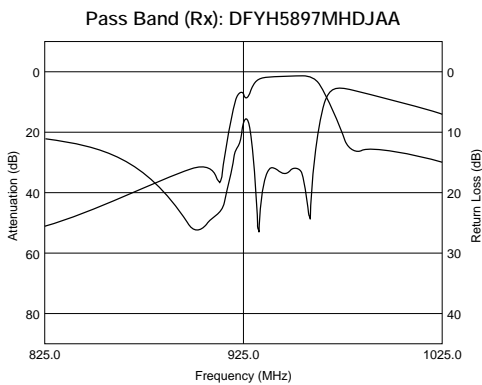
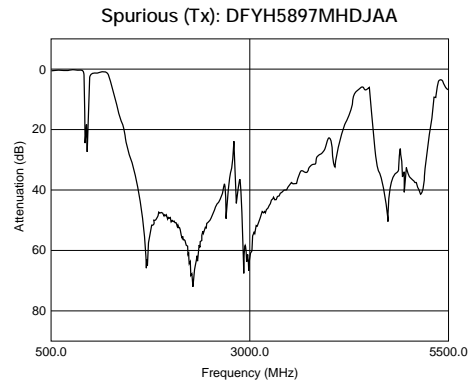
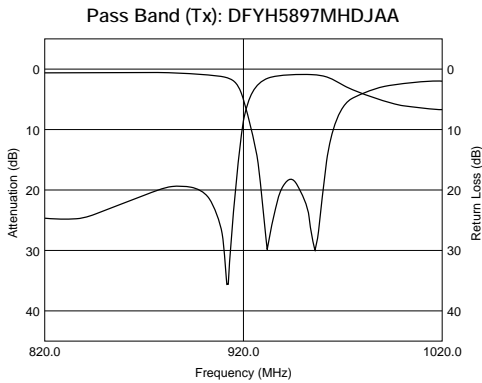

Continued on the following page. ↗

Continued from the preceding page.

Characteristics

2

Pass Band (Tx): DFYHA897MHFJAA

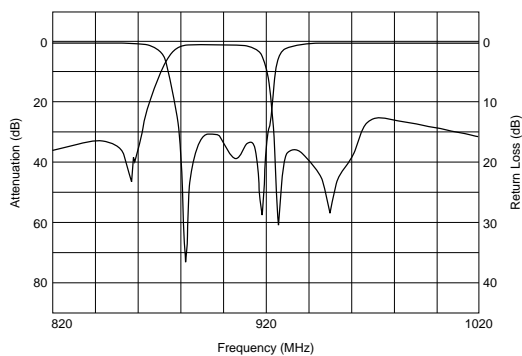

Spurious (Tx): DFYHA897MHFJAA

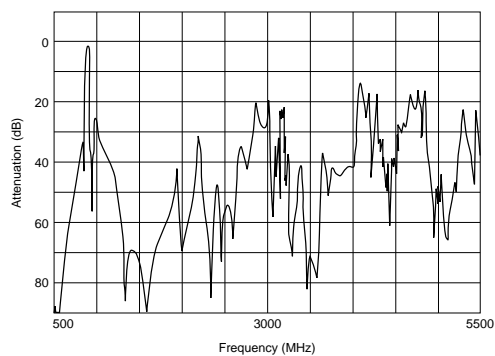

Pass Band (Rx): DFYHA897MHFJAA

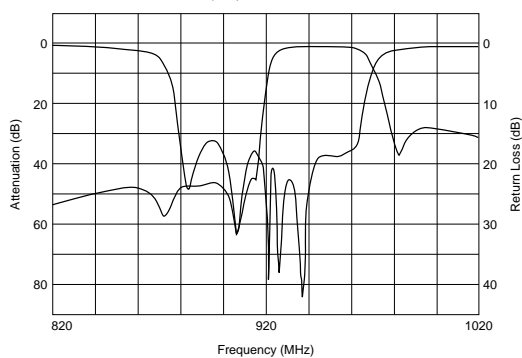

Spurious (Rx): DFYHA897MHFJAA

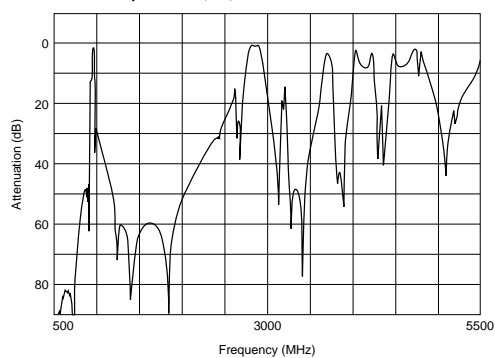

Part Number	fo (Tx) (MHz)	Bandwidth (Tx) (MHz)	IL at BW (dB max.)	Attenuation (dB min.)	fo (Rx) (MHz)	Bandwidth (Rx) (MHz)	IL at BW (dB max.)	Attenuation (dB min.)	Operation Temperature Range (°C)
DFYH5897MHDJAA	897.5	35	2.0	15 (935 to 960MHz)	942.5	35	4.3	20 (905 to 915MHz)	-30 to +85
DFYHA897MHFJAA	897.5	35	3.7	30 (925 to 960MHz)	942.5	35	4.4	40 (880 to 915MHz)	-35 to +85

DCS1800: DFYH Series

■ Features

1. Low insertion loss for using high Q-value dielectric resonators.
2. Small and light for using high dielectric constant ceramics.
3. Excellent temperature stability for temperature compensated dielectric constant ($0 \pm 5 \text{ppm}/(\text{degree C}) \text{ max}$).
4. Excellent mechanical stability without vibratile structure.
5. SMD and reflow soldering is available.
6. Mountable by automatic placing machine.

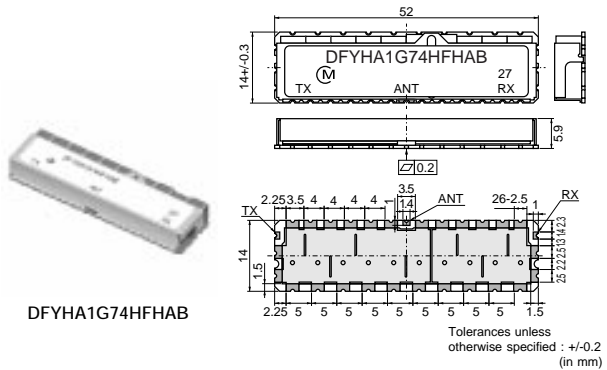
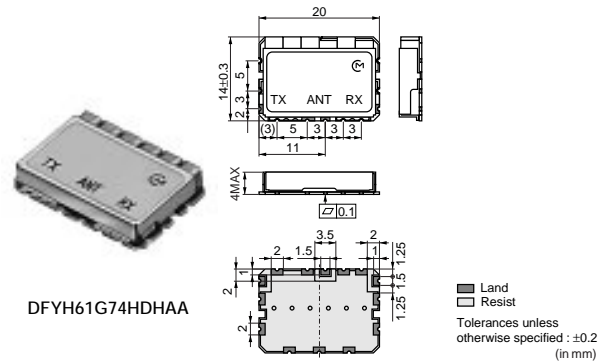

■ Characteristics

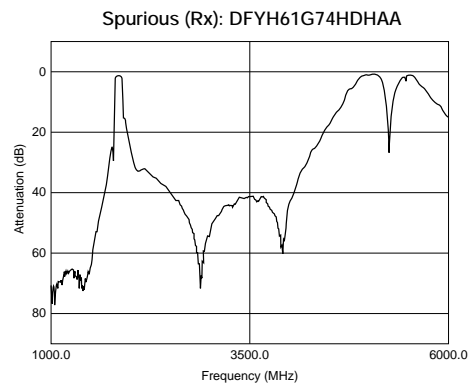
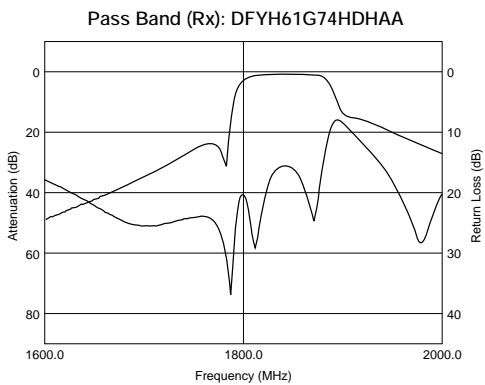
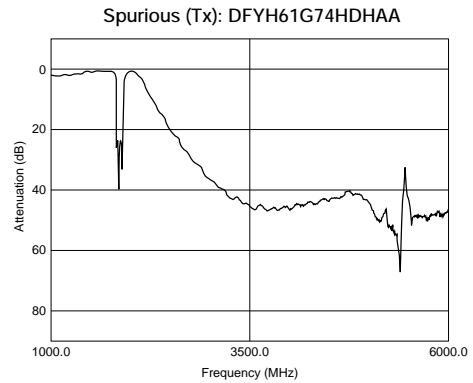
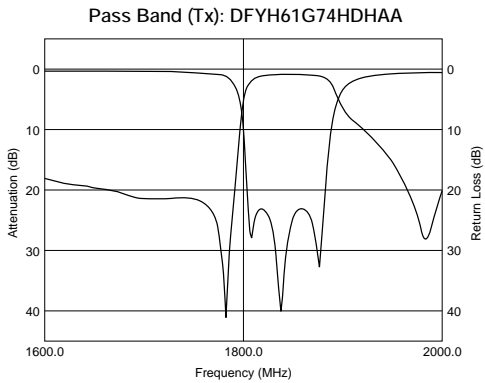

Continued on the following page. ↗

Continued from the preceding page.

Characteristics

2

Pass Band (Tx): DFYHA1G74HFHAB

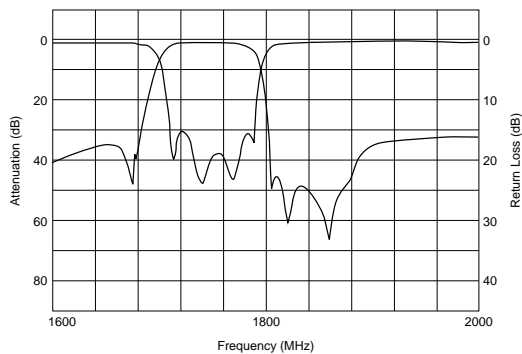

Spurious (Tx): DFYHA1G74HFHAB

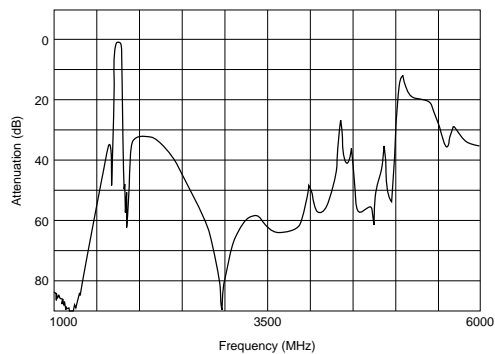

Pass Band (Rx): DFYHA1G74HFHAB

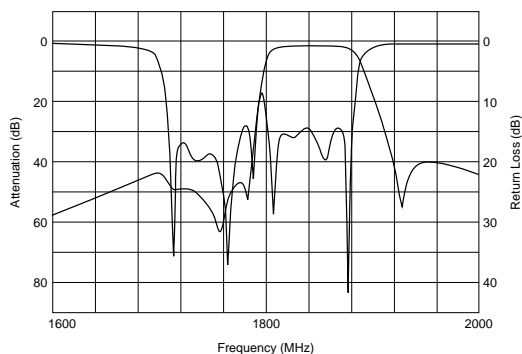

Spurious (Rx): DFYHA1G74HFHAB

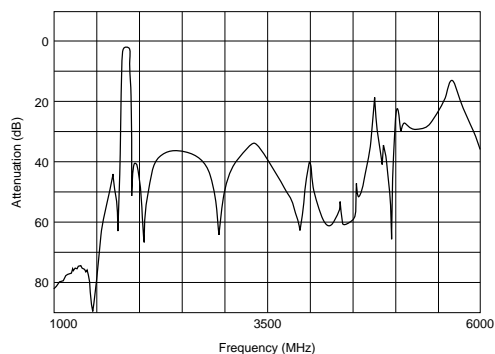

Part Number	fo (Tx) (MHz)	Bandwidth (Tx) (MHz)	IL at BW (dB max.)	Attenuation (dB min.)	fo (Rx) (MHz)	Bandwidth (Rx) (MHz)	IL at BW (dB max.)	Attenuation (dB min.)	Operation Temperature Range (°C)
DFYH61G74HDHAA	1747.5	75	2.3	20 (1805 to 1880MHz)	1842.5	75	2.7	20 (1710 to 1785MHz)	-30 to +85
DFYH61G74HDHAB	1747.5	75	2.0	15 (1805 to 1880MHz)	1842.5	75	3.0	20 (1710 to 1785MHz)	-30 to +85
DFYHA1G74HFHAB	1747.5	75	3.8	42 (1805 to 1880MHz)	1842.5	75	4.3	42 (1710 to 1785MHz)	-35 to +85

PCS1.9: DFYH Series

■ Features

1. Low insertion loss for using high Q-value dielectric resonators.
2. Small and light for using high dielectric constant ceramics.
3. Excellent temperature stability for temperature compensated dielectric constant ($0 \pm 5 \text{ ppm}/(\text{degree C}) \text{ max}$).
4. Excellent mechanical stability without vibratile structure.
5. SMD and reflow soldering is available.
6. Mountable by automatic placing machine.

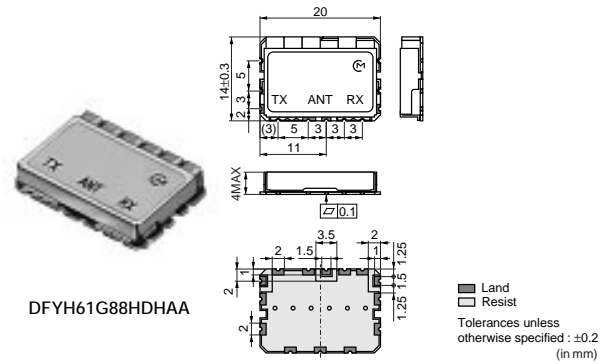

2

■ Characteristics

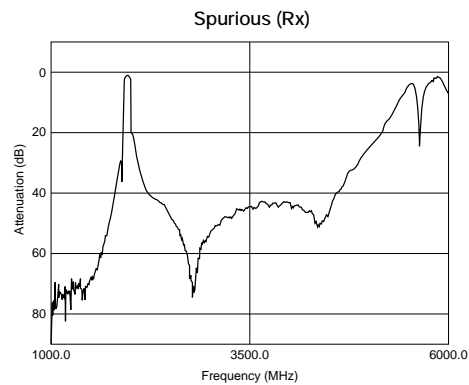
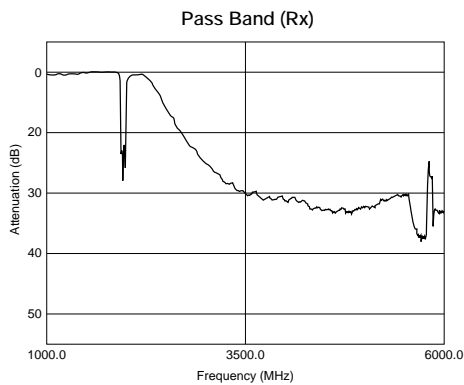
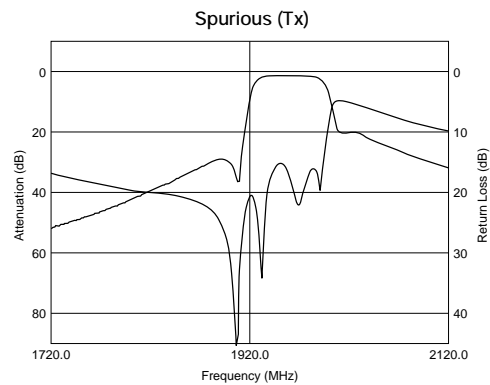
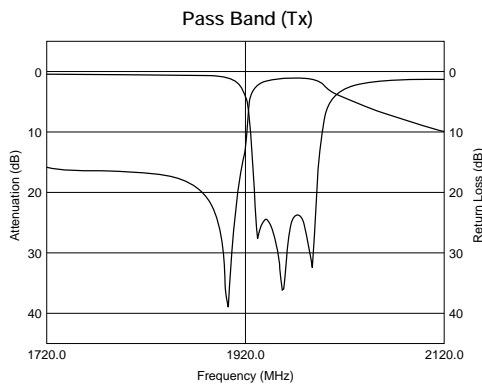

Part Number	fo (Tx) (MHz)	Bandwidth (Tx) (MHz)	IL at BW (dB max.)	Attenuation (dB min.)	fo (Rx) (MHz)	Bandwidth (Rx) (MHz)	IL at BW (dB max.)	Attenuation (dB min.)	Operation Temperature Range (°C)
DFYH61G88HDHAA	1880	60	2.0	17 (1930 to 1990MHz)	1960	60	3.0	20 (1850 to 1910MHz)	-30 to +85
DFYH61G88HDHAB	1880	60	2.3	20 (1930 to 1990MHz)	1960	60	3.2	25 (1850 to 1910MHz)	-30 to +85

W-CDMA: DFYH Series

■ Features

1. Low insertion loss for using high Q-value dielectric resonators.
2. Small and light for using high dielectric constant ceramics.
3. Excellent temperature stability for temperature compensated dielectric constant ($0 \pm 5 \text{ ppm}/(\text{degree C})$ max).
4. Excellent mechanical stability without vibratile structure.
5. SMD and reflow soldering is available.
6. Mountable by automatic placing machine.



DFYHA1G95HFHAA

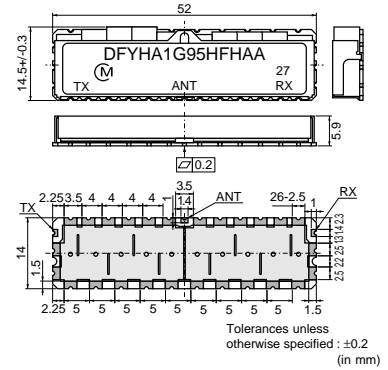

■ Characteristics

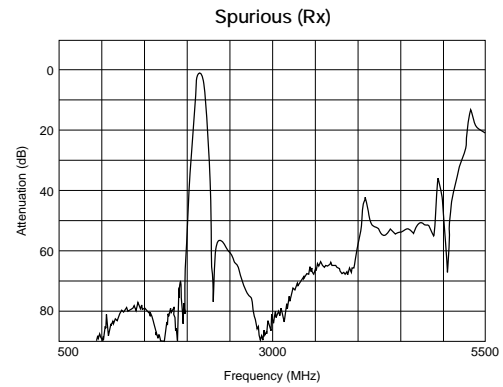
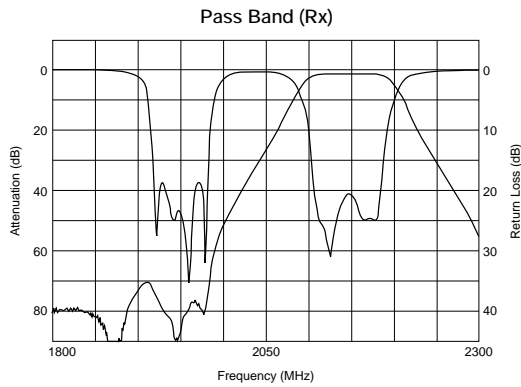
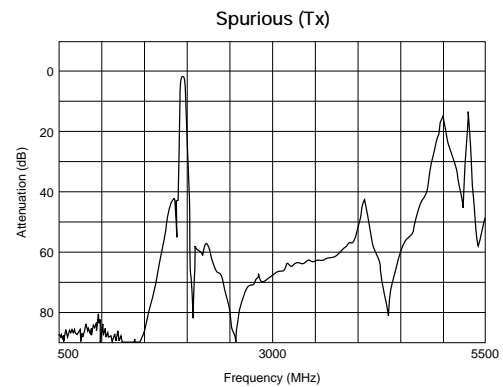
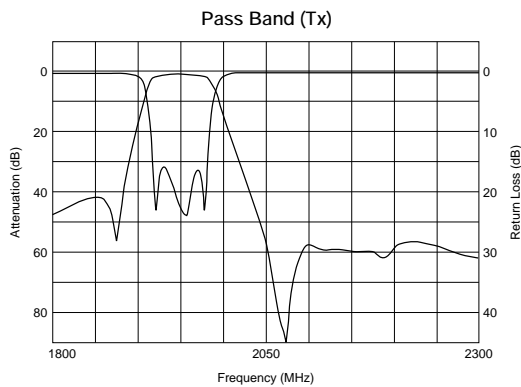

Part Number	fo (Tx) (MHz)	Bandwidth (Tx) (MHz)	IL at BW (dB max.)	Attenuation (dB min.)	fo (Rx) (MHz)	Bandwidth (Rx) (MHz)	IL at BW (dB max.)	Attenuation (dB min.)	Operation Temperature Range (°C)
DFYHA1G95HFHAA	1950	60	2.5	55 (2110 to 2170MHz)	2140	60	2.0	70 (1920 to 1980MHz)	-35 to +85

LMR: DFYH Series

■ Features

1. Low insertion loss for using high Q-value dielectric resonators.
2. Small and light for using high dielectric constant ceramics.
3. Excellent temperature stability for temperature compensated dielectric constant ($0 \pm 5 \text{ ppm}/(\text{degree C}) \text{ max}$).
4. Excellent mechanical stability without vibratile structure.
5. SMD and reflow soldering is available.
6. Mountable by automatic placing machine.

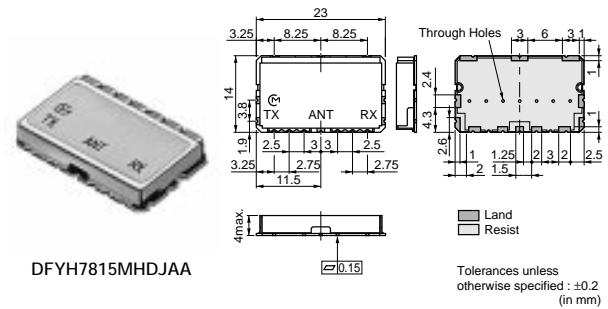

2

■ Characteristics

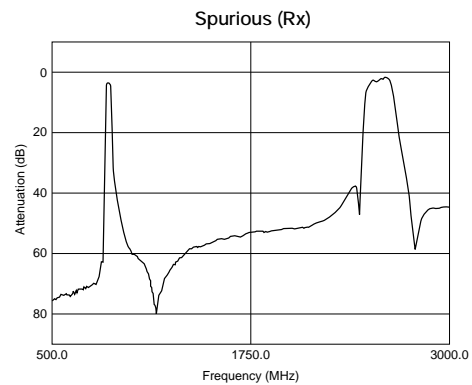
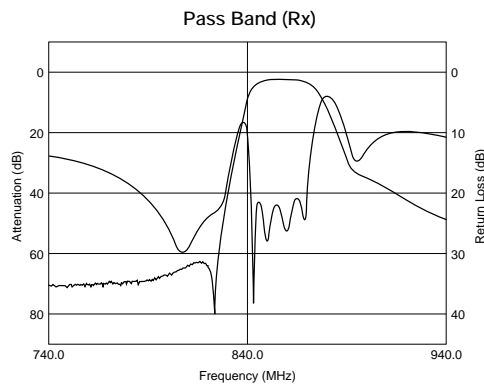
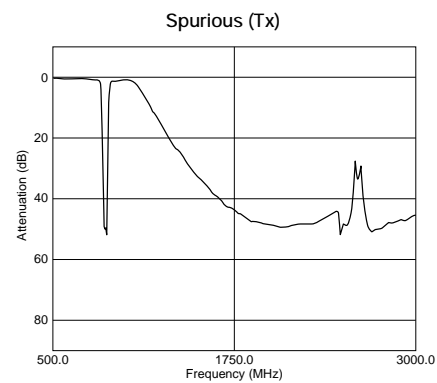
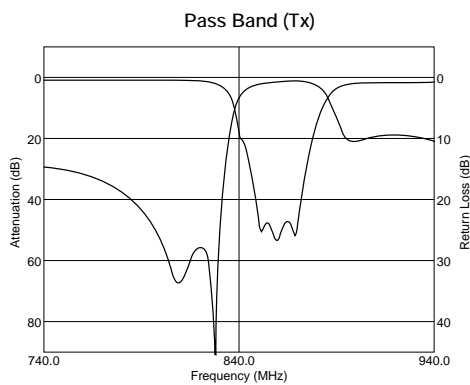

Part Number	fo (Tx) (MHz)	Bandwidth (Tx) (MHz)	IL at BW (dB max.)	Attenuation (dB min.)	fo (Rx) (MHz)	Bandwidth (Rx) (MHz)	IL at BW (dB max.)	Attenuation (dB min.)	Operation Temperature Range (°C)
DFYH7815MHDJAA	815	20	2.0	40 (850 to 870MHz)	860	20	4.0	57 (805 to 825MHz)	-30 to +85

MSAT: DFYF Series

■ Features

1. Low insertion loss for using high Q-value dielectric resonators
2. Small and light for using high dielectric constant ceramics
3. Excellent temperature stability for temperature compensated dielectric constant (0+5ppm/degree C max.)
4. Excellent mechanical stability without vibratile struture

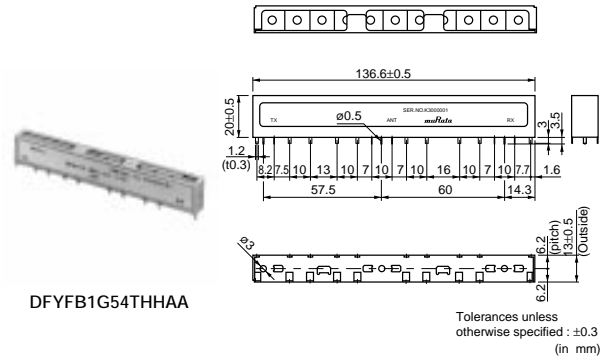

■ Characteristics

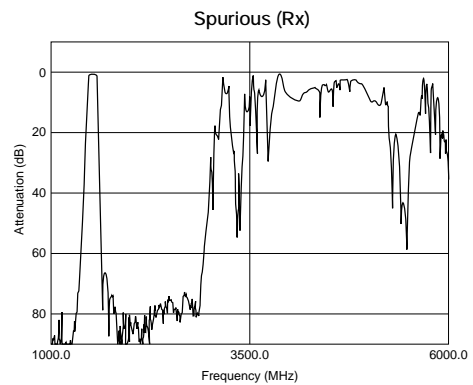
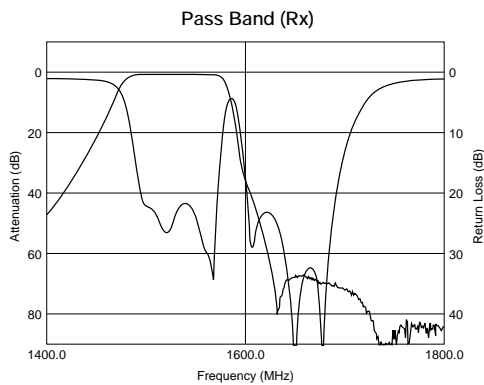
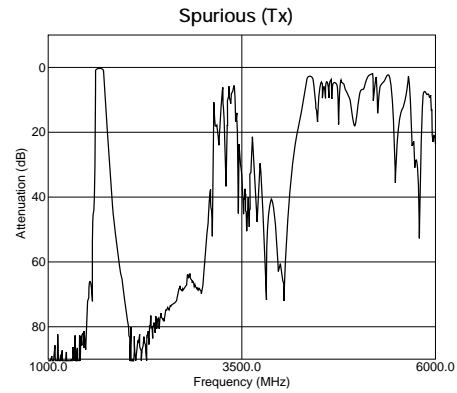
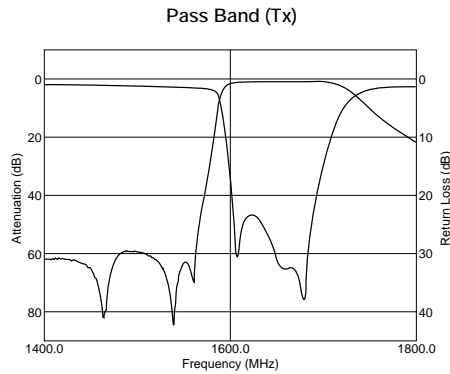

Part Number	fo (Tx) (MHz)	Bandwidth (Tx) (MHz)	IL at BW (dB max.)	Attenuation (dB min.)	fo (Rx) (MHz)	Bandwidth (Rx) (MHz)	IL at BW (dB max.)	Attenuation (dB min.)	Operation Temperature Range (°C)
DFYFB1G54THHAA	1643.5	34	1.0	60 (1525 to 1559MHz)	1542	34	1.2	65 (1626.5 to 1660.5MHz)	-30 to +85

Notice/Packaging/Soldering and Mounting

■ Notice

1. When handling products, be careful not to flaw outer-electrode. If you flaw outer-electrode, the device don't satisfy the specifications.
2. When handling products, be careful not to touch outer-electrode with bare hand. If you touch outer-electrode with bare hand, the soldering performance of device is reduced.
3. Do not apply excessive pressure or shock to product in handling or transportation because the ceramic material which is used inside might be destructed.

■ Reel

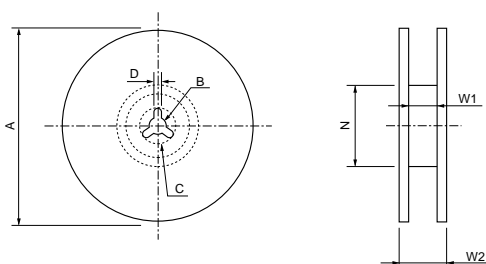

Wide	A±2.0	B±0.5	C±0.8	D±0.5	N min.	W1±1.5	W2 max.
12	ø178	ø13	ø21	2	ø50	13.5	18.5
	ø330	ø13	ø21	2	ø50	13.5	18.5
16	ø178	ø13	ø21	2	ø50	17.5	23
	ø330	ø13	ø21	2	ø50	17.5	23
24	ø330	ø13	ø21	2	ø50	25.5	31
32	ø330	ø13	ø21	2	ø50	33.5	39
44	ø330	ø13	ø21	2	ø50	45.5	51

(in mm)

■ Reflow Soldering Conditions

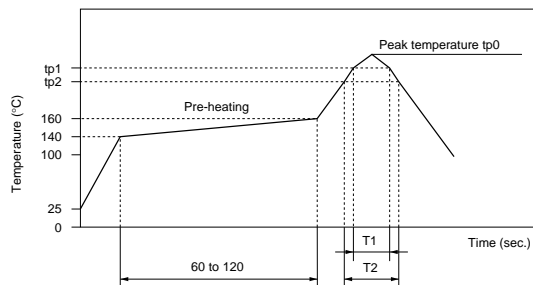

Measuring point of temperature : IN-OUT Terminals of The Device
 Reflow Soldering : Both Convection and Infrared Rays, Hot Air and Hot Plate

	tp0 (°C)	tp1 (°C)	T1 (sec.)	tp2 (°C)	T2 (sec.)
Reflow standard condition	245±5	220	30 to 60	—	—
Test condition of reflow heat resistance	260+5/-0	240	20	220	70

■ Allowable Reflow Soldering Temperature and Time

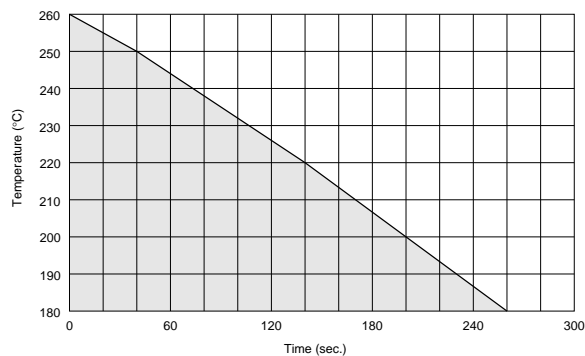

△Note:

1. Export Control

〈For customers outside Japan〉

No muRata products should be used or sold, through any channels, for use in the design, development, production, utilization, maintenance or operation of, or otherwise contribution to (1) any weapons (Weapons of Mass Destruction (nuclear, chemical or biological weapons or missiles) or conventional weapons) or (2) goods or systems specially designed or intended for military end-use or utilization by military end-users.

〈For customers in Japan〉

For products which are controlled items subject to the "Foreign Exchange and Foreign Trade Law" of Japan, the export license specified by the law is required for export.

2. Please contact our sales representatives or product engineers before using the products in this catalog for the applications listed below, which require especially high reliability for the prevention of defects which might directly damage a third party's life, body or property, or when one of our products is intended for use in applications other than those specified in this catalog.

- | | |
|-----------------------------|--|
| ① Aircraft equipment | ② Aerospace equipment |
| ③ Undersea equipment | ④ Power plant equipment |
| ⑤ Medical equipment | ⑥ Transportation equipment (vehicles, trains, ships, etc.) |
| ⑦ Traffic signal equipment | ⑧ Disaster prevention / crime prevention equipment |
| ⑨ Data-processing equipment | ⑩ Application of similar complexity and/or reliability requirements to the applications listed above |

3. Product specifications in this catalog are as of May 2007. They are subject to change or our products in it may be discontinued without advance notice. Please check with our sales representatives or product engineers before ordering. If there are any questions, please contact our sales representatives or product engineers.

4. Please read rating and △CAUTION (for storage, operating, rating, soldering, mounting and handling) in this catalog to prevent smoking and/or burning, etc.

5. This catalog has only typical specifications because there is no space for detailed specifications. Therefore, please approve our product specifications or transact the approval sheet for product specifications before ordering.

6. Please note that unless otherwise specified, we shall assume no responsibility whatsoever for any conflict or dispute that may occur in connection with the effect of our and/or a third party's intellectual property rights and other related rights in consideration of your use of our products and/or information described or contained in our catalogs. In this connection, no representation shall be made to the effect that any third parties are authorized to use the rights mentioned above under licenses without our consent.

7. No ozone depleting substances (ODS) under the Montreal Protocol are used in our manufacturing process.



Murata Manufacturing Co., Ltd.

<http://www.murata.com/>

Head Office
1-10-1, Higashi Kotari, Nagaokakyo-shi, Kyoto 617-8555, Japan
Phone: 81-75-951-9111

International Division
3-29-12, Shibuya, Shibuya-ku, Tokyo 150-0002, Japan
Phone: 81-3-5469-6123 Fax: 81-3-5469-6155 E-mail: intl@murata.co.jp