

# Dielectric Filters (GIGAFIL®)



## Band Pass Filters

### DFCB Series 800/900MHz

#### Features

1. Low insertion loss for using high Q-value dielectric resonators
2. Small and light for using high dielectric constant ceramics
3. Excellent temperature stability for temperature compensated dielectric constant (0+-5 ppm/degree C max.)
4. Excellent mechanical stability without vibratile structure
5. SMD and reflow soldering available
6. Mountable by automatic placement machine

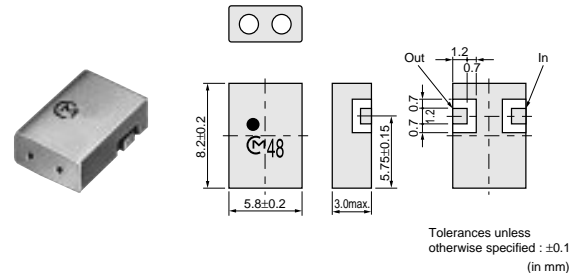

#### Characteristics

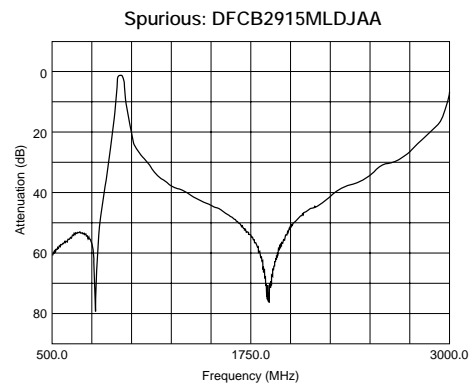
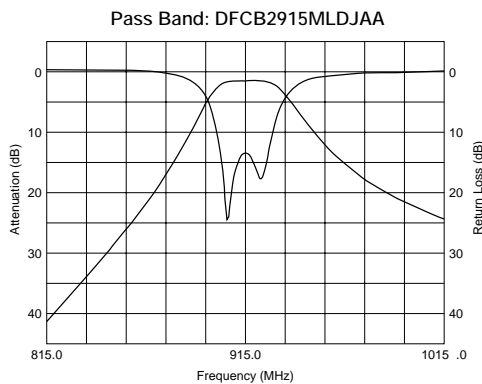

Application	Part Number	fo (MHz)	Bandwidth (MHz)	IL at BW (dB max.)	Attenuation (dB min.)	Operation Temp. (°C)
AMPS	DFCB2836MLDJAA	836.5	25	2.6	6.5 (869 to 894MHz)	-30 to +85
CT2	DFCB2841MLEJAA	841	4	3.0	38 (Fo-150MHz)	-30 to +85
CT2	DFCB2866MLEJAA	866	4	3.0	38 (Fo-150MHz)	-30 to +85
AMPS	DFCB2881MLDJAA	881.5	25	2.6	9 (824 to 849MHz)	-30 to +85
CT1+	DFCB2886MLEJAA	886	2	3.0	24 (Fo-44MHz)	-30 to +85
GSM	DFCB2902MLDJAA	902.5	25	2.6	27 (Fo-77.5MHz)	-30 to +85
WLAN915	DFCB2903MLEJAA	903	2	3.0	20 (Fo+22MHz)	-30 to +85
CT2	DFCB2912MLDJAA	912	4	2.0	50 (Fo-150MHz)	-30 to +85
CT2	DFCB2912MLEJAA	912	4	3.0	38 (Fo-150MHz)	-30 to +85
CT1	DFCB2914MLEJAA	914.5	1	3.0	24 (Fo-44MHz)	-30 to +85
WLAN915	DFCB2915MLDJAA	915	26	2.5	27 (837.5MHz)	-35 to +85
WLAN915	DFCB2926MLEJAA	926.25	2.7	2.8	21 (902.4 to 905.1MHz)	-30 to +85
WLAN915	DFCB2927MLEJAA	927	2	3.0	15 (Fo-22MHz)	-30 to +85
CT1+	DFCB2931MLEJAA	931	2	3.0	24 (Fo-44MHz)	-30 to +85
GSM	DFCB2947MLDJAA	947.5	25	2.6	27 (Fo-77.5MHz)	-30 to +85
CT1	DFCB2959MLEJAA	959.5	1	3.0	30 (Fo+44MHz)	-30 to +85
LMR	DFCB3815MLDJAA	815.5	19	2.5	12 (Fo±35.5MHz)	-30 to +85
AMPS	DFCB3836MLDJAA	836.5	25	3.0	12 (869 to 894MHz)	-30 to +85
CT2	DFCB3841MLEJAA	841	4	5.3	60 (Fo-150MHz)	-30 to +85
LMR	DFCB3860MLDJAA	860.5	19	2.5	13 (Fo-35.5MHz)	-30 to +85

Continued on the following page.

Continued from the preceding page.

1

Application	Part Number	fo (MHz)	Bandwidth (MHz)	IL at BW (dB max.)	Attenuation (dB min.)	Operation Temp. (°C)
CT2	<b>DFCB3866MLEJAA</b>	866	4	5.3	60 (Fo-150MHz)	-30 to +85
AMPS	<b>DFCB3881MLDJAA</b>	881.5	25	3.0	15 (824 to 849MHz)	-30 to +85
CT1+	<b>DFCB3886MLEJAA</b>	886	2	5.3	45 (Fo-44MHz)	-30 to +85
GSM	<b>DFCB3902MLDJAA</b>	902.5	25	3.0	45 (Fo-77.5MHz)	-30 to +85
WLAN915	<b>DFCB3903MLEJAA</b>	903	2	5.3	29 (Fo-22MHz)	-30 to +85
CT2	<b>DFCB3912MLEJAA</b>	912	4	5.3	60 (Fo-150MHz)	-30 to +85
CT1	<b>DFCB3914MLEJAA</b>	914.5	1	5.3	45 (Fo-44MHz)	-30 to +85
WLAN915	<b>DFCB3915MLDJAA</b>	915	26	3.0	15 (Fo-32.5MHz)	-30 to +85
WLAN915	<b>DFCB3927MLEJAA</b>	927	2	5.3	29 (Fo-22MHz)	-30 to +85
CT1+	<b>DFCB3931MLEJAA</b>	931	2	5.3	45 (Fo-44MHz)	-30 to +85
GSM	<b>DFCB3947MLDJAA</b>	947.5	25	3.0	45 (Fo-77.5MHz)	-30 to +85
CT1	<b>DFCB3959MLEJAA</b>	959.5	1	5.3	45 (Fo-44MHz)	-30 to +85

## DFCB Series 1.5-5GHz

### ■ Features

1. Low insertion loss for using high Q-value dielectric resonators
2. Small and light for using high dielectric constant ceramics
3. Excellent temperature stability for temperature compensated dielectric constant (0+-5 ppm/degree C max.)
4. Excellent mechanical stability without vibratile structure
5. SMD and reflow soldering available
6. Mountable by automatic placement machine

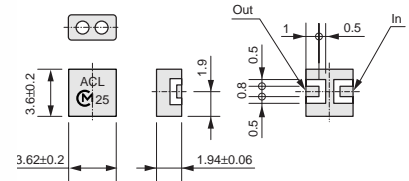

DFCB22G33LBJAA

Tolerances unless otherwise specified : ±0.1 (in mm)

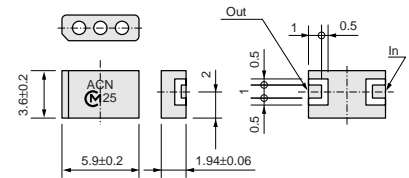

DFCB32G33LBJAA

Tolerances unless otherwise specified : ±0.1 (in mm)

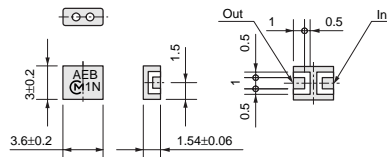

DFCB25G25LAHAA

Tolerances unless otherwise specified : ±0.1 (in mm)

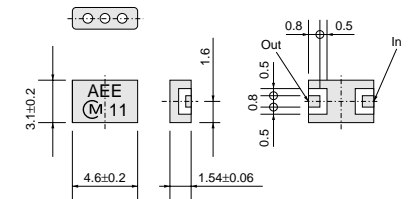

DFCB35G25LAHAA

Tolerances unless otherwise specified : ±0.1 (in mm)

### ■ Characteristics

Pass Band: DFCB22G33LBJAA

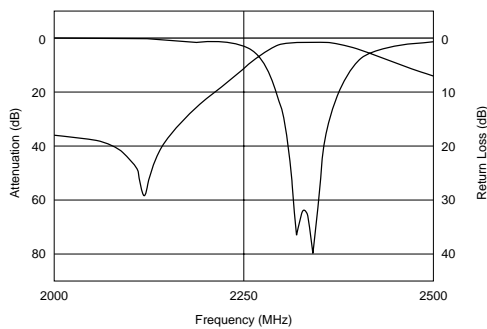

Spurious: DFCB22G33LBJAA

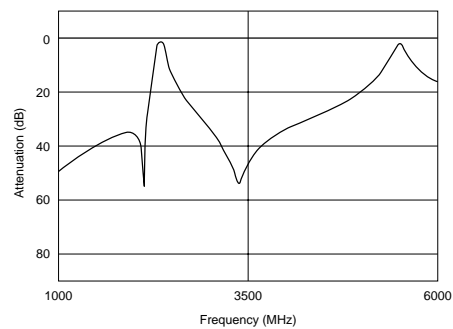

Continued on the following page. ↗

Continued from the preceding page.

1

Characteristics

Pass Band: DFCEB32G33LBJAA

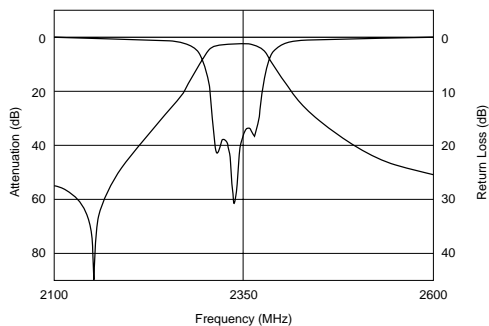

Spurious: DFCEB32G33LBJAA

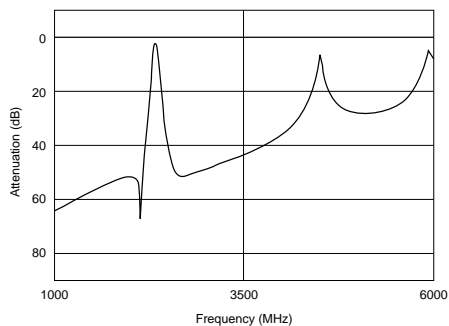

Pass Band: DFCEB25G25LAHAA

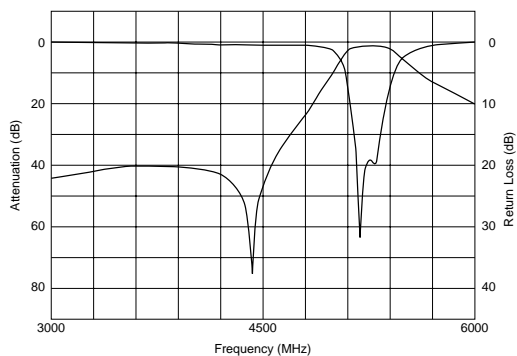

Spurious: DFCEB25G25LAHAA

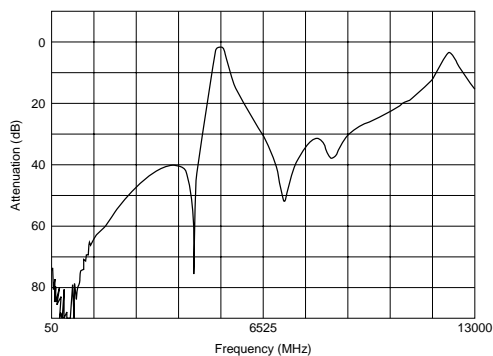

Pass Band: DFCEB35G25LAHAA

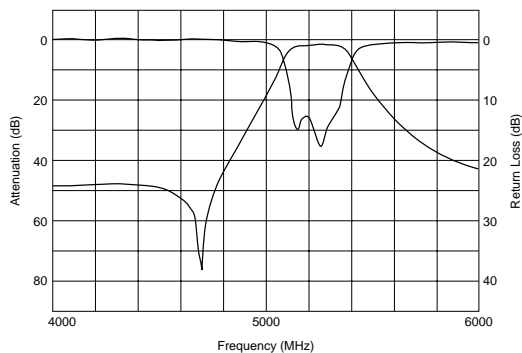

Spurious: DFCEB35G25LAHAA

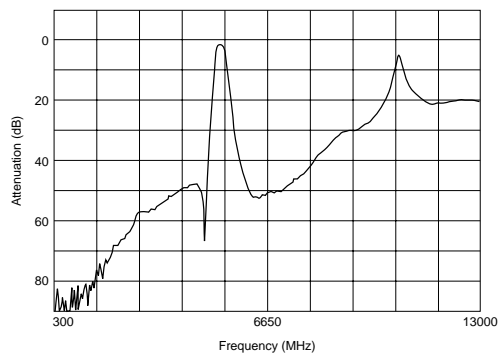

Application	Part Number	fo (MHz)	Bandwidth (MHz)	IL at BW (dB max.)	Attenuation (dB min.)	Operation Temp. (°C)
DAB	DFCEB21G47LBJAA	1472	40	2.0	38 (1122MHz)	-30 to +85
PDC1.5	DFCEB21G48LBJAA	1489	24	1.4	10 (1607 to 1631MHz)	-30 to +85
GPS	DFCEB21G57LBJAB	1575.42	3	1.3	37 (1850 to 1910MHz)	-35 to +85
GPS	DFCEB21G57LCJAA	1575.42	2	3.5	15 (Fo±50MHz)	-30 to +85
GPS	DFCEB21G57LDJAB	1575.42	2	3.15	18 (Fo±50MHz)	-30 to +85
DCS1800	DFCEB21G84LDJAA	1842.5	75	2.0	20 (Fo-160MHz)	-35 to +85
PCS1.9	DFCEB21G88LDJAA	1880	60	1.5	17 (2280MHz)	-30 to +85
DECT	DFCEB21G89LBJAA	1890	20	2.0	40 (1660 to 1680MHz)	-30 to +85
DECT	DFCEB21G89LBJAB	1890	20	1.7	35 (1660 to 1680MHz)	-30 to +85
DECT	DFCEB21G89LDHAA	1890	20	0.9	27 (1655 to 1679MHz)	-10 to +55
DECT	DFCEB21G89LDJAA	1890	20	2.0	45 (1660 to 1680MHz)	-30 to +85
PHS	DFCEB21G90LBJAA	1907.5	25	1.0	20 (1655 to 1680MHz)	-15 to +55

Continued on the following page.

Continued from the preceding page.

Application	Part Number	fo (MHz)	Bandwidth (MHz)	IL at BW (dB max.)	Attenuation (dB min.)	Operation Temp. (°C)
PHS	<b>DFCB21G90LBJAB</b>	1907.5	25	1.6	35 (1655 to 1680MHz)	-15 to +55
PHS	<b>DFCB21G90LBJAC</b>	1907.5	25	1.9	45 (1655 to 1680MHz)	-15 to +55
DECT (CHINA)	<b>DFCB21G91LBJAA</b>	1910	20	1.7	34 (1675 to 1700MHz)	-30 to +85
DECT (CHINA)	<b>DFCB21G91LDJAA</b>	1910	20	1.8	40 (1675 to 1700MHz)	-30 to +85
CDMA1.9	<b>DFCB21G92LBJAA</b>	1920	20	1.2	20 (1655 to 1694MHz)	-30 to +85
CDMA1.9	<b>DFCB21G92LDJAA</b>	1920	20	1.9	16 (1800 to 1820MHz)	-30 to +85
PCS1.9	<b>DFCB21G96LDJAA</b>	1960	60	1.5	17 (2360MHz)	-30 to +85
TD-SCDMA	<b>DFCB22G01LBJAA</b>	2017.5	15	1.5	35 (1270MHz)	-35 to +85
W-CDMA	<b>DFCB22G14LBJAA</b>	2140	60	2.7	26 (1920 to 1980MHz)	-30 to +85
Sirius Radio	<b>DFCB22G32LBJAA</b>	2326	14	1.8	8.5 (2227MHz)	-35 to +85
XM Satellite	<b>DFCB22G33LBJAA</b>	2339	14	1.8	8.5 (2240MHz)	-35 to +85
WLAN2.4	<b>DFCB22G44LANAA</b>	2441.5	83	1.5	35 (2000MHz)	-35 to +85
WLAN2.4	<b>DFCB22G44LBJAA</b>	2442	84	2.0	16 (Fo-250MHz)	-30 to +85
WLAN2.4	<b>DFCB22G45LBJAA</b>	2450	100	2.0	15 (Fo-250MHz)	-30 to +85
WLAN2.4	<b>DFCB22G48LBJAA</b>	2484	26	2.0	27.5 (Fo-204MHz)	-30 to +85
VICS	<b>DFCB22G50LBJAA</b>	2500	4	4.5	20 (2440MHz)	-30 to +85
WLAN5G	<b>DFCB25G25LAHAA</b>	5250	200	1.5	38 (4370 to 4510MHz)	-35 to +85
WLAN5G	<b>DFCB25G59LAHAA</b>	5597.5	255	1.5	11 (Fo-375MHz)	-35 to +85
WLAN5G	<b>DFCB25G77LAHAA</b>	5775	100	1.5	12 (Fo-375MHz)	-35 to +85
ETC	<b>DFCB25G80LBHAA</b>	5800	100	2.0	25 (Fo-375MHz)	-30 to +85
DAB	<b>DFCB31G47LBJAA</b>	1472	40	3.0	45 (1100MHz)	-35 to +85
DCS1800	<b>DFCB31G74LBJAA</b>	1747.5	75	3.5	45 (1464 to 1539MHz)	-30 to +85
DCS1800	<b>DFCB31G84LBJAA</b>	1842.5	75	3.5	45 (1559 to 1634MHz)	-30 to +85
DCS1800	<b>DFCB31G84LBJAB</b>	1842.5	75	2.75	45 (0.3 to 1388MHz)	-30 to +85
PCS1.9	<b>DFCB31G88LBJAA</b>	1880	60	3.7	5 (1930MHz)	-30 to +85
PCS1.9	<b>DFCB31G88LBJAB</b>	1880	60	4.0	41 (2043 to 2103MHz)	-30 to +85
W-CDMA	<b>DFCB31G95LBJAA</b>	1950	60	3.5	35 (2110 to 2170MHz)	-30 to +85
PCS1.9	<b>DFCB31G96LBJAA</b>	1960	60	3.7	5 (1910MHz)	-30 to +85
PCS1.9	<b>DFCB31G96LBJAB</b>	1960	60	3.0	10 (1498 to 1860MHz)	-30 to +85
PCS1.9	<b>DFCB31G96LBJAC</b>	1960	60	2.8	10 (1860MHz)	-30 to +85
PCS1.9	<b>DFCB31G96LBJAE</b>	1960	60	3.7	20 (2065 to 2125MHz)	-35 to +85
W-CDMA	<b>DFCB32G14LBJAA</b>	2140	60	3.7	30 (1920 to 1980MHz)	-30 to +85
Sirius Radio	<b>DFCB32G32LBJAA</b>	2326	14	3.0	24 (2227MHz)	-35 to +85
XM Satellite	<b>DFCB32G33LBJAA</b>	2339	14	3.0	24 (2240MHz)	-35 to +85
WLAN2.4	<b>DFCB32G44LBJAA</b>	2442	84	3.2	30 (Fo-250MHz)	-30 to +85
WLAN2.4	<b>DFCB32G45LBJAA</b>	2450	100	3.2	30 (Fo-250MHz)	-30 to +85
WLAN5G	<b>DFCB35G25LAHAA</b>	5250	200	3.3	45 (4450 to 4650MHz)	-35 to +85
WLAN5G	<b>DFCB35G59LAHAA</b>	5597.5	255	3.6	45 (4750 to 5000MHz)	-35 to +85
WLAN5G	<b>DFCB35G77LAHAA</b>	5775	100	3.0	30 (Fo-375MHz)	-35 to +85
WLAN5G	<b>DFCB35G80LBHAA</b>	5800	150	3.4	10 (Fo-175MHz)	-35 to +85

## DFCH Series 800/900MHz

### ■ Features

1. Low insertion loss for using high Q-value dielectric resonators
2. Small and light for using high dielectric constant ceramics
3. Excellent temperature stability for temperature compensated dielectric constant (0+/-5 ppm/degree C max.)
4. Excellent mechanical stability without vibratile structure
5. SMD and reflow soldering available
6. Mountable by automatic placement machine

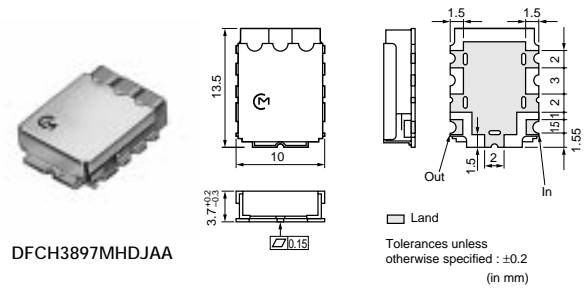

DFCH3897MHDJAA

### ■ Characteristics

Pass Band: DFCH3897MHDJAA

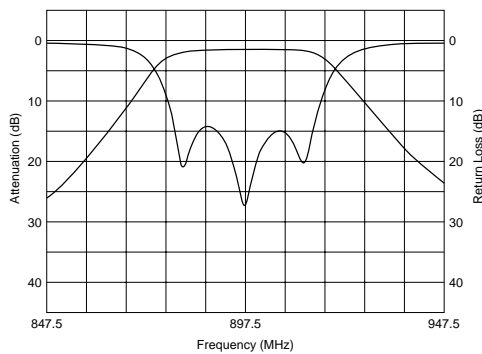

Spurious: DFCH3897MHDJAA

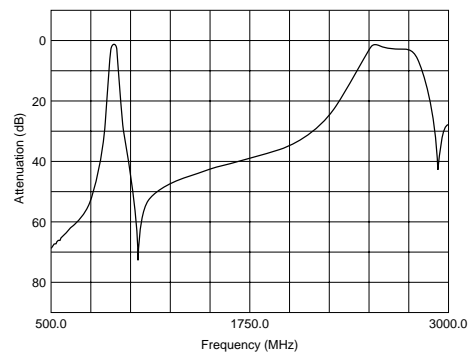

Pass Band: DFCH3942MHDJAA

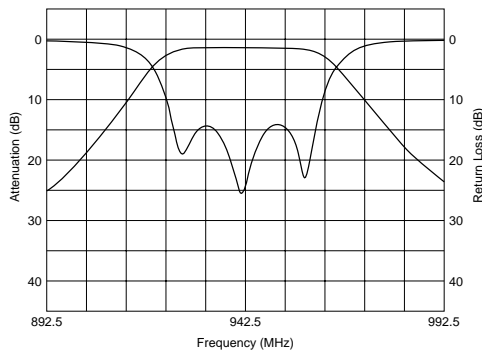

Spurious: DFCH3942MHDJAA

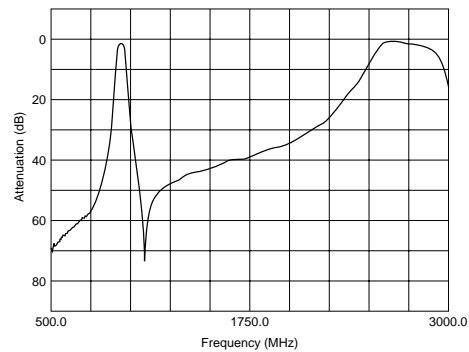

Application	Part Number	fo (MHz)	Bandwidth (MHz)	IL at BW (dB max.)	Attenuation (dB min.)	Operation Temp. (°C)
LMR	DFCH3815MHDJAA	815	20	2.8	36 (Fo±80MHz)	-30 to +85
AMPS	DFCH3836MHDJAA	836.5	25	2.6	12 (Fo±32.5MHz)	-30 to +85
LMR	DFCH3860MHDJAA	860	20	2.8	36 (Fo±80MHz)	-30 to +85
AMPS	DFCH3881MHDJAA	881.5	25	2.6	12 (Fo±32.5MHz)	-30 to +85
ETACS	DFCH3888MHDJAA	888.5	33	3.0	7 (Fo±28.5MHz)	-30 to +85
EGSM	DFCH3897MHDJAA	897.5	35	3.0	6 (Fo±27.5MHz)	-30 to +85
GSM	DFCH3902MHDJAA	902.5	25	2.6	12 (Fo±32.5MHz)	-30 to +85
ETACS	DFCH3933MHDJAA	933.5	33	3.0	7 (Fo±28.5MHz)	-30 to +85
EGSM	DFCH3942MHDJAA	942.5	35	3.0	6 (Fo±27.5MHz)	-30 to +85
GSM	DFCH3947MHDJAA	947.5	25	2.6	12 (Fo±32.5MHz)	-30 to +85
ETACS	DFCH4888MHDJAA	888.5	33	4.6	15 (Fo±28.5MHz)	-30 to +85

Continued on the following page.

☒ Continued from the preceding page.

Application	Part Number	fo (MHz)	Bandwidth (MHz)	IL at BW (dB max.)	Attenuation (dB min.)	Operation Temp. (°C)
EGSM	<b>DFCH4897MHDJAA</b>	897.5	35	4.6	13 (Fo±27.5MHz)	-30 to +85
ETACS	<b>DFCH4933MHDJAA</b>	933.5	33	4.6	15 (Fo±28.5MHz)	-30 to +85
EGSM	<b>DFCH4942MHDJAA</b>	942.5	35	4.6	13 (Fo±27.5MHz)	-30 to +85

1

## DFCH Series 1.5-2.5GHz

### Features

1. Low insertion loss for using high Q-value dielectric resonators
2. Small and light for using high dielectric constant ceramics
3. Excellent temperature stability for temperature compensated dielectric constant (0+/-5 ppm/degree C max.)
4. Excellent mechanical stability without vibratile structure
5. SMD and reflow soldering available
6. Mountable by automatic placement machine

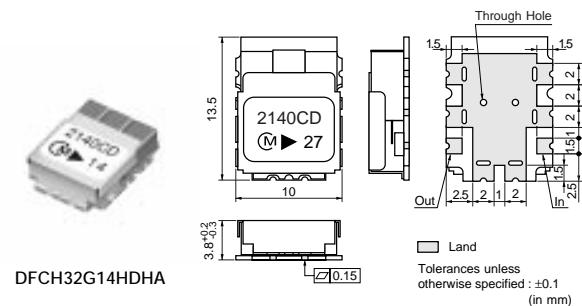
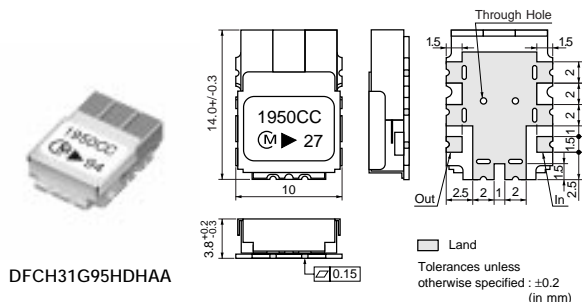

### Characteristics

Pass Band: DFCH31G95HDHAA

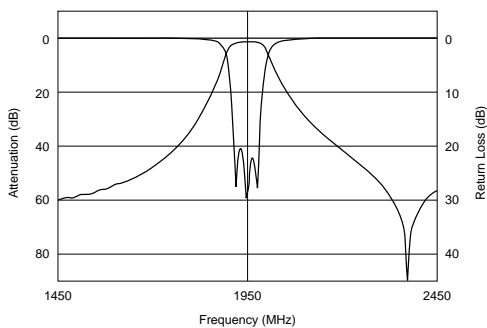

Spurious: DFCH31G95HDHAA

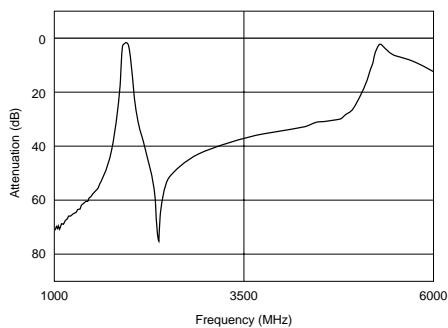

Pass Band: DFCH32G14HDHA

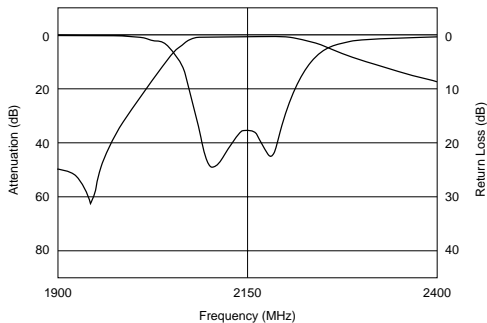

Spurious: DFCH32G14HDHA

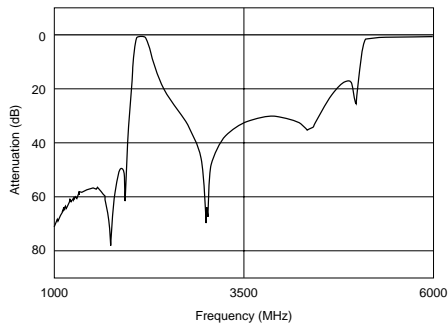



Application	Part Number	fo (MHz)	Bandwidth (MHz)	IL at BW (dB max.)	Attenuation (dB min.)	Operation Temp. (°C)
GPS	<b>DFCH21G57HDHAA</b>	1575.5	2	0.9	16 (Fo-140MHz)	-30 to +85
PHS	<b>DFCH21G90HDJAA</b>	1907.5	25	0.7	35 (Fo-227.5MHz)	-30 to +85
WLAN2.4	<b>DFCH22G44HDHAA</b>	2442	84	1.2	15 (Fo±250MHz)	-30 to +85
WLAN2.4	<b>DFCH22G45HDHAA</b>	2450	100	1.0	16 (Fo-250MHz)	-30 to +85
WLAN2.4	<b>DFCH22G48HDHAA</b>	2484	26	2.5	47 (Fo-270MHz)	-30 to +85
VICS	<b>DFCH22G50HDHAA</b>	2500	4	2.4	10 (Fo±60MHz)	-30 to +85
MSAT	<b>DFCH31G54HDJAA</b>	1542	34	3.0	30 (1626.5 to 1660.5MHz)	-30 to +85
MSAT	<b>DFCH31G64HDJAA</b>	1643.5	34	3.0	30 (1525 to 1559MHz)	-30 to +85
DCS1800	<b>DFCH31G74HDJAA</b>	1747.5	75	2.0	8 (Fo±80MHz)	-30 to +85
DCS1800	<b>DFCH31G84HDJAA</b>	1842.5	75	2.0	8 (Fo±80MHz)	-30 to +85
PCS1.9	<b>DFCH31G88HDJAA</b>	1880	60	2.2	15 (Fo±100MHz)	-30 to +85
W-CDMA	<b>DFCH31G95HDHAA</b>	1950	60	1.8	45 (1550MHz)	-30 to +85
PCS1.9	<b>DFCH31G96HDJAA</b>	1960	60	2.2	15 (Fo±100MHz)	-30 to +85
W-CDMA	<b>DFCH32G14HDHAA</b>	2140	60	1.3	52 (1325 to 1385MHz)	-30 to +85
MMDS	<b>DFCH32G15HDHAB</b>	2156	20	3.0	36 (2050MHz)	-35 to +85
WLAN2.4	<b>DFCH32G44HDHAA</b>	2442	84	2.4	36 (Fo-250MHz)	-30 to +85
WLAN2.4	<b>DFCH32G45HDHAA</b>	2450	100	2.3	36 (Fo-250MHz)	-30 to +85
WLAN2.4	<b>DFCH32G48HDHAA</b>	2484	26	3.0	45 (Fo-270MHz)	-30 to +85
DCS1800	<b>DFCH41G74HDJAA</b>	1747.5	75	3.6	10 (Fo±57.5MHz)	-30 to +85
DCS1800	<b>DFCH41G84HDJAA</b>	1842.5	75	3.6	10 (Fo±57.5MHz)	-30 to +85
PCS1.9	<b>DFCH41G88HDJAA</b>	1880	60	4.5	12 (Fo±50MHz)	-30 to +85
PCS1.9	<b>DFCH41G96HDJAA</b>	1960	60	4.5	12 (Fo±50MHz)	-30 to +85
MMDS	<b>DFCH42G59HDHAB</b>	2593	186	1.8	50 (Fo-400MHz)	-35 to +85

# for RF/Local

## Chip Multilayer LC Filters (BPF)

### ● LFB18/21/2H/31\_SG Series



LFB18\_SG Series

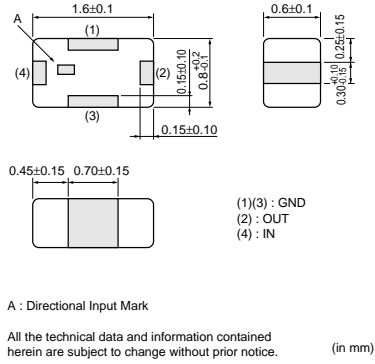

Frequency Characteristics

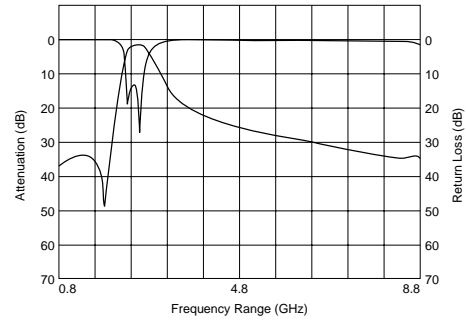

LFB21\_SG Series

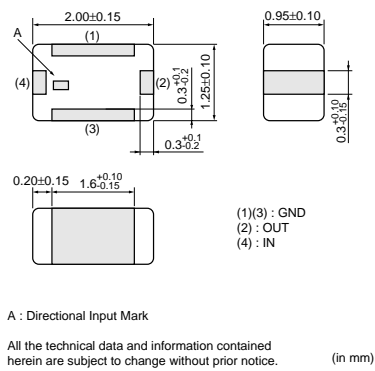

Frequency Characteristics

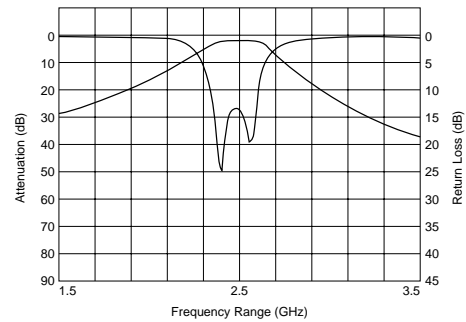

LFB2H\_SG Series

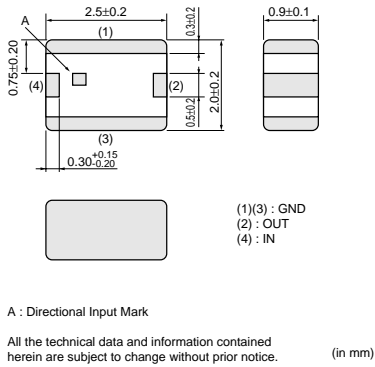

Frequency Characteristics

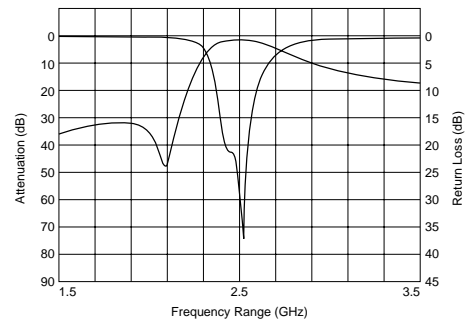

LFB31\_SG Series

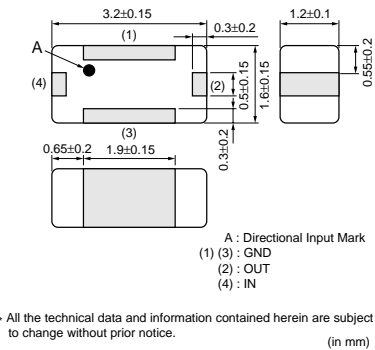

Frequency Characteristics

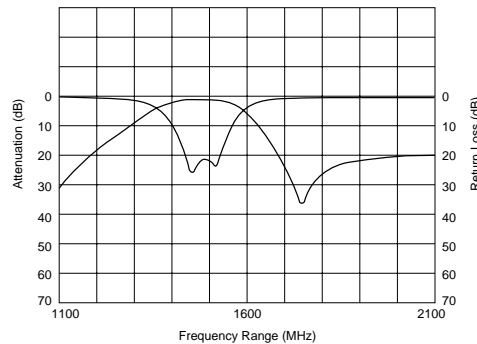

△Note • This catalog has only typical specifications because there is no space for detailed specifications. Therefore, please approve our product specifications or transact the approval sheet for product specifications before ordering. Especially, please read rating and △CAUTION (for storage, operating, rating, soldering, mounting and handling) in them to prevent smoking and/or burning, etc.  
• You are able to read a detailed specifications in the website (<http://search.murata.co.jp/>) before to require our product specifications or to transact the approval sheet for product specifications.

Part Number	Nominal Center Frequency (fo) (MHz)	Bandwidth (BW) (MHz)	Insertion Loss in BW (dB)	Attenuation (Absolute Value) I) (dB)	Attenuation (Absolute Value) II) (dB)
LFB182G45SG9A246	2450	fo±50	2.2 max. (at 25°C)	24.5 min. at 880~960MHz	12.5 min. at 1710~1990MHz
LFB212G45SG8A127	2450	fo±50	1.5 max. (at 25°C)	25 min. at 1200~1300MHz	10.0 min. at 2000MHz
LFB212G45SG8A166	2450	fo±50	1.4 max. (at 25°C)	30 min. at 880~915MHz	30 min. at 1710~1910MHz
LFB212G45SG8A192	2450	fo±50	2.6 max. (at 25°C)	40 min. at 880~960MHz	38 min. at 1710~1990MHz
LFB215G12SG8A178	5125	fo±225	1.5 max. (at 25°C)	25 min. at 4200MHz	17 min. at 2x(fo±225)MHz
LFB215G12SG8A183	5125	fo±225	1.5 max. (at 25°C)	10.0 min. at 4250MHz	10.0 min. at 5900MHz
LFB215G25SG8A144	5250	fo±100.0	1.5 max. (at 25°C)	30 min. at 3450MHz	-
LFB215G37SG8A180	5375	fo±475	1.8 max. (at 25°C)	29.5 min. at 500~4000MHz	34.5 min. at 3450MHz
LFB215G37SG8A185	5375	fo±475	2.2 max. (at 25°C)	40 min. at 340~1195MHz	21 min. at 2140~3580MHz
LFB215G51SG8A132	5512	fo±363	1.9 max. (at 25°C)	30 min. at 500~4000MHz	20 min. at 4600MHz
LFB215G51SG8A154	5512	fo±363	1.5 max. (at 25°C)	30 min. at 500~4000MHz	20 min. at 4600MHz
LFB215G78SG8A170	5787.5	fo±62.5	2.2 max. (at 25°C)	35 min. at 3275~3400MHz	37 min. at 2x(fo±62.5)MHz
LFB2H2G45SG7A134	2450	fo±50	1.7 max. (at 25°C)	25 min. at 1750MHz	25 min. at 2100MHz
LFB2H2G45SG7A135	2450	fo±50	2.7 max. (at 25°C)	40 min. at 880~915MHz	40 min. at 1710~1950MHz
LFB2H2G45SG7A158	2450	fo±50	1.2 max. (at 25°C)	30 min. at 880~915MHz	30 min. at 1710~1785MHz
LFB2H2G45SG7A159	2450	fo±50	2.1 max. (at 25°C)	45 min. at 880~915MHz	48 min. at 1710~1990MHz
LFB2H2G45SG7A204	2450	fo±50	3 max. (at 25°C)	45 min. at 880~915MHz	27 min. at 1710~1990MHz
LFB2H5G78SG7A175	5787.5	fo±62.5	2.5 max. (at 25°C)	51.5 min. at 902~928MHz	41 min. at 3919~4044MHz
LFB311G48SG1-985	1489	fo±12.0	1.5 max. (at 25°C)	25 min. at (fo±12.0)+260MHz	28 min. at 1749MHz
LFB311G90SG1-799	1906.5	fo +24.5/-13.5MHz	2.5 max. (at 25°C)	40 min. at 1397.05~1422.85MHz	35 min. at 1645.5~1671.3MHz
LFB311G90SG2-797	1906.5	fo±13.5	2.7 max. (at 25°C)	40 min. at 1427~1454MHz	35 min. at 1660~1687MHz
LFB311G95SG3A564	1950	fo±30	3.5 max. (at 25°C)	20 min. at 2110~2170MHz	25 min. at 2490~2550MHz
LFB312G45SG2A509	2450	fo±50	2 max. (at 25°C)	38 min. at 902~928MHz	15 min. at 2100~2200MHz
LFB312G45SG7A572	2450	fo±50	2.5 max. (at 25°C)	37 min. at 902~928MHz	20 min. at 2100~2200MHz

● LFB31\_SL Series (1206)

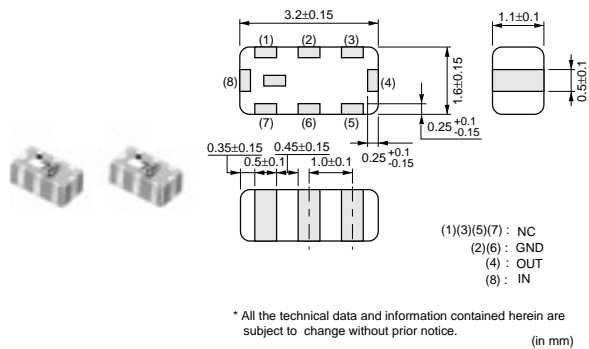

Frequency Characteristics

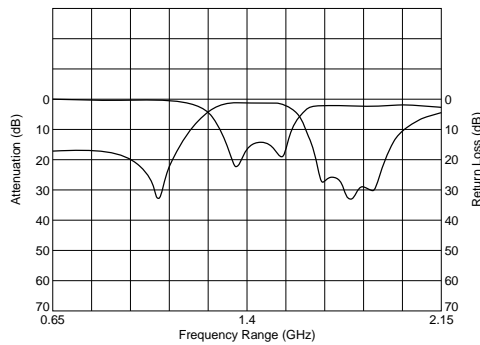

Part Number	Nominal Center Frequency (fo) (MHz)	Bandwidth (BW) (MHz)	Insertion Loss in BW (dB)	Attenuation (Absolute Value) I) (dB)	Attenuation (Absolute Value) II) (dB)
LFB311G40SL1A562	1402.5	fo±77.5	3 max. (at 25°C)	20 min. at 1005~1080MHz	20 min. at 1725~1760MHz

● LFB31\_SN Series (1206)

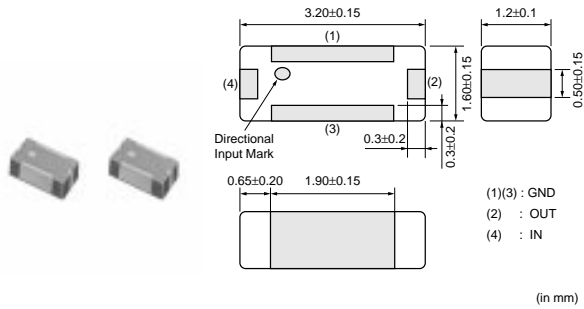

All the technical data and information contained herein are subject to change without prior notice.

Frequency Characteristics

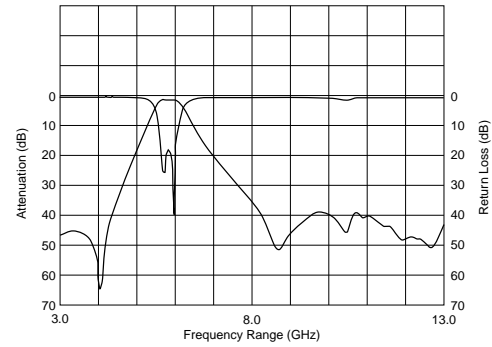

Part Number	Nominal Center Frequency (fo) (MHz)	Bandwidth (BW) (MHz)	Insertion Loss in BW (dB)	Attenuation (Absolute Value) I) (dB)	Attenuation (Absolute Value) II) (dB)
LFB315G82SN5-996	5820	fo±30	2 max. (at 25°C)	35 min. at 2000MHz	30 min. at 3000MHz

● LFB31\_SP Series (1206)

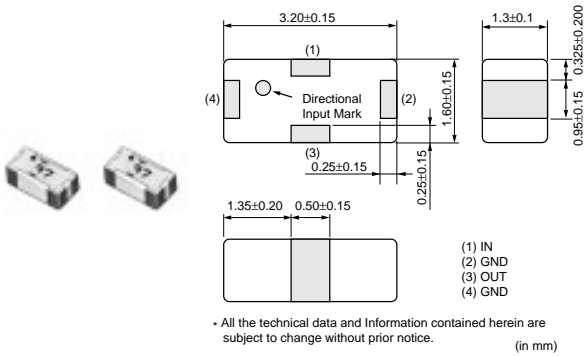

All the technical data and information contained herein are subject to change without prior notice.

Frequency Characteristics

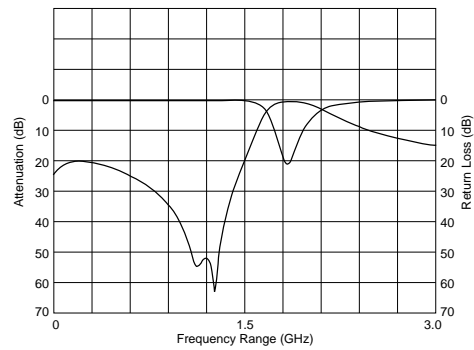

Part Number	Nominal Center Frequency (fo) (MHz)	Bandwidth (BW) (MHz)	Insertion Loss in BW (dB)	Attenuation (Absolute Value) I) (dB)	Attenuation (Absolute Value) II) (dB)
LFB311G89SP1A542	1890	fo±10.0	0.85 max. (at 25°C)	29 min. at 1416.9~1436.9Hz	22 min. at 900MHz
LFB311G90SP1-798	1906.5	fo±13.5	1.0 max. (at 25°C)	38 min. at 1405~1440MHz	12.0 min. at 1649~1680MHz
LFB312G45SP1A502	2450	fo±50	1.4 max. (at 25°C)	20 min. at 902~928MHz	35 min. at 1500~1550MHz

Note • This catalog has only typical specifications because there is no space for detailed specifications. Therefore, please approve our product specifications or transact the approval sheet for product specifications before ordering. Especially, please read rating and CAUTION (for storage, operating, rating, soldering, mounting and handling) in them to prevent smoking and/or burning, etc.  
 • You are able to read a detailed specifications in the website (<http://search.murata.co.jp/>) before to require our product specifications or to transact the approval sheet for product specifications.

● LFB32\_SA Series (1210)

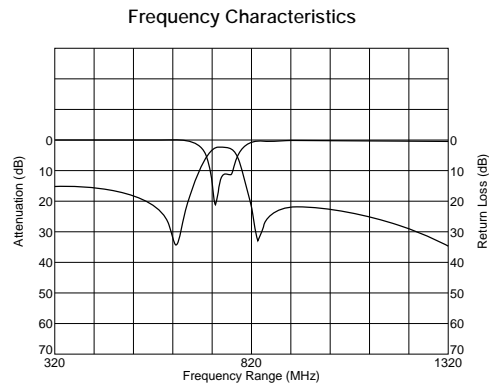
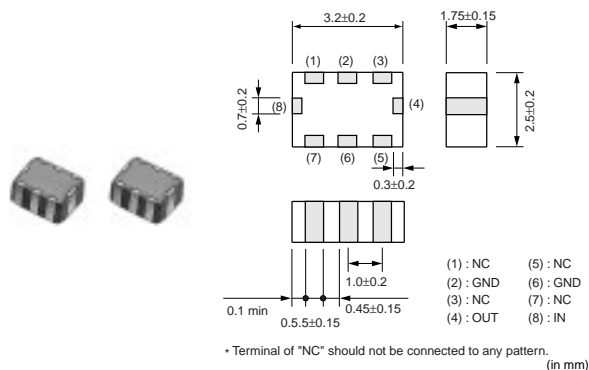

Part Number	Nominal Center Frequency (fo) (MHz)	Bandwidth (BW) (MHz)	Insertion Loss in BW (dB)	Attenuation (Absolute Value) I) (dB)	Attenuation (Absolute Value) II) (dB)
LFB32741MSA1-744	741.5	fo±19.5	3.5 max. (at 25°C)	20 min. at 612~650MHz	20 min. at 832~870MHz
LFB32836MSA1-747	836.5	fo±12.5	3 max. (at 25°C)	19.5 min. at fo±77.5MHz	-
LFB32851MSA1A540	851	fo±19	3.5 max. (at 25°C)	20 min. at fo-90.0MHz	18 min. at fo+90.0MHz
LFB32881MSA1-781	881.5	fo±12.5	4.8 max. (at 25°C)	11.0 min. at 824~837MHz	5 min. at 846~849MHz
LFB32881MSA1A556	881.5	fo±12.5	3.2 max. (at 25°C)	20 min. at fo±77.5MHz	-
LFB32902MSA1A536	902.5	fo±12.5	3 max. (at 25°C)	15 min. at 802~827MHz	15 min. at 978~1003MHz
LFB32906MSA1A539	906	fo±19	3.5 max. (at 25°C)	20 min. at fo-90.0MHz	18 min. at fo+90.0MHz
LFB32947MSA1A537	947	fo±12.5	3 max. (at 25°C)	9 min. at D.C.~835MHz	6 min. at 1000~1394MHz
LFB32991MSA1-762	991.15	fo±12.5	3 max. (at 25°C)	20 min. at 869~894MHz	20 min. at 1088.3~1113.3MHz
LFB321G44SA1A538	1441.0	fo±12.0	3 max. (at 25°C)	25 min. at 1607~1631MHz	-
LFB321G61SA1A555	1619	fo±12.0	2.8 max. (at 25°C)	20 min. at 1477~1501MHz	16 min. at 1429~1453MHz

7 Filters for Communication Equipment

● LFB32\_SB Series (1210)

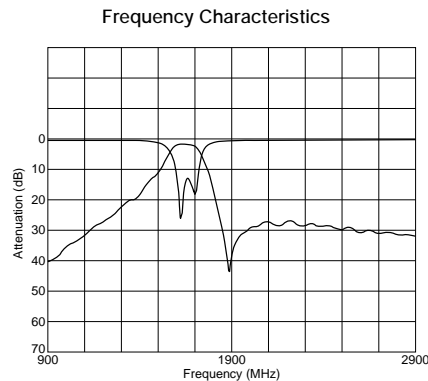
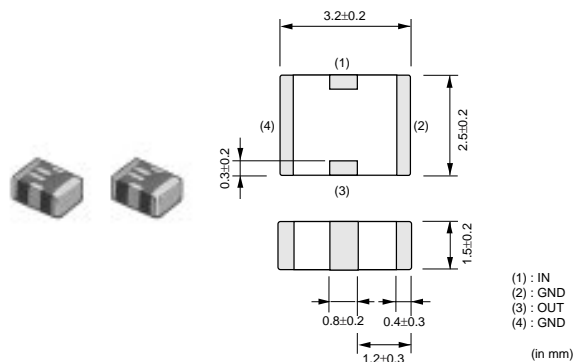

Part Number	Nominal Center Frequency (fo) (MHz)	Bandwidth (BW) (MHz)	Insertion Loss in BW (dB)	Attenuation (Absolute Value) I) (dB)	Attenuation (Absolute Value) II) (dB)
LFB321G66SB1-560	1662	fo±12.5	2 max. (at 25°C)	27 min. at 1895~1918MHz	20 min. at 2xfo MHz
LFB321G89SB1-591	1890	fo±10.0	1.2 max. (at 25°C)	21 min. at 1655~1675MHz	15 min. at 2xfo MHz
LFB321G90SB1-559	1907.5	fo±12.5	1.0 max. (at 25°C)	35 min. at 1397.5~1440MHz	20 min. at 1646~1680MHz

● LFB32\_SC Series (1210)

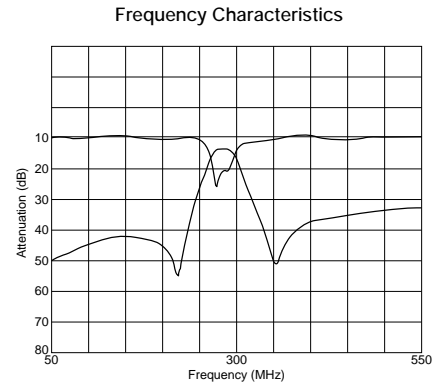
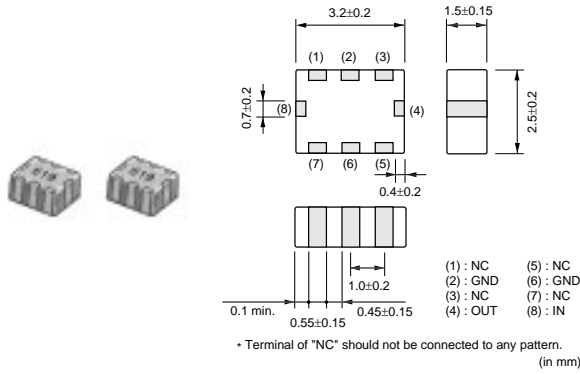

Part Number	Nominal Center Frequency (fo) (MHz)	Bandwidth (BW) (MHz)	Insertion Loss in BW (dB)	Attenuation (Absolute Value) I) (dB)	Attenuation (Absolute Value) II) (dB)
LFB32284MSC1-596	284	fo±4	3.8 max. (at 25°C)	31 min. at 220~228MHz	23 min. at 340~348MHz
LFB32312MSC1-597	312.25	fo±1.0	3.5 max. (at 25°C)	26 min. at 249.8MHz	26 min. at 374.7MHz
LFB32315MSC1-604	315	fo±0.5	3.5 max. (at 25°C)	45 min. at 180MHz	29 min. at 470MHz
LFB32315MSC1-619	315	fo±0	3.5 max. (at 25°C)	30 min. at 235MHz	30 min. at 395MHz
LFB32426MSC1-603	426.5	fo±0.5	3.6 max. (at 25°C)	25 min. at 366.5MHz	20 min. at 486.5MHz
LFB32820MSC2-749	820	fo±10.0	1.3 max. (at 25°C)	22 min. at 1070~1090MHz	-
LFB32847MSC2-766	847.5	fo±37.5	1.5 max. (at 25°C)	16 min. at 550~625MHz	15 min. at 1070~1145MHz

● LFB32\_SJ Series (1210)

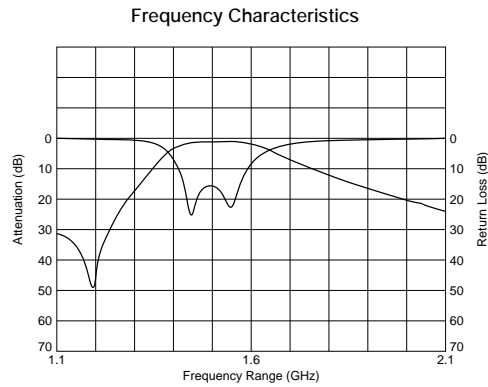
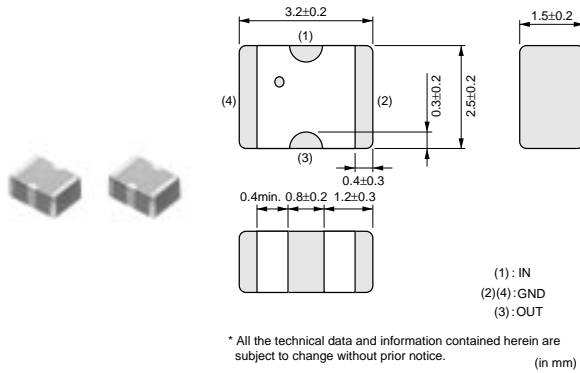

Part Number	Nominal Center Frequency (fo) (MHz)	Bandwidth (BW) (MHz)	Insertion Loss in BW (dB)	Attenuation (Absolute Value) I) (dB)	Attenuation (Absolute Value) II) (dB)
LFB321G47SJ1-794	1472	fo±20	1.3 max. (at 25°C)	30 min. at 1172MHz	-

● LFB32\_SK Series (1210)

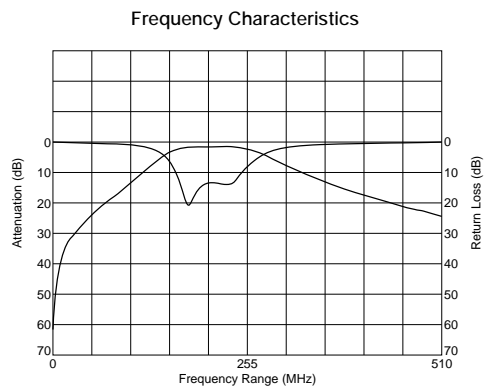
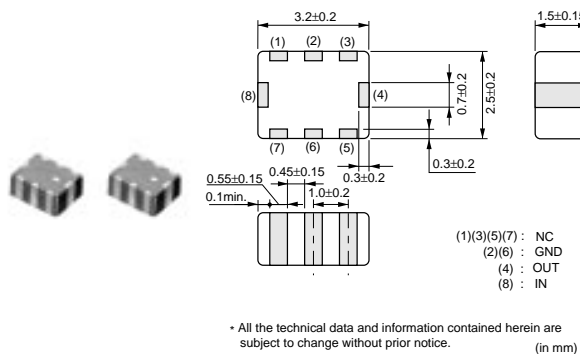

△Note • This catalog has only typical specifications because there is no space for detailed specifications. Therefore, please approve our product specifications or transact the approval sheet for product specifications before ordering. Especially, please read rating and △CAUTION (for storage, operating, rating, soldering, mounting and handling) in them to prevent smoking and/or burning, etc.  
• You are able to read a detailed specifications in the website (<http://search.murata.co.jp/>) before to require our product specifications or to transact the approval sheet for product specifications.

Part Number	Nominal Center Frequency (fo) (MHz)	Bandwidth (BW) (MHz)	Insertion Loss in BW (dB)	Attenuation (Absolute Value) I (dB)	Attenuation (Absolute Value) II (dB)
LFB32205MSK1-948	205.5	fo±31.5	1.5 max. (at 25°C)	10.0 min. at 100MHz	20 min. at 500MHz

● LFB32\_SN Series (1210)

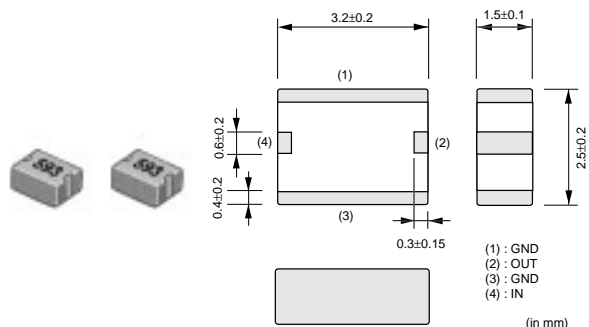

Frequency Characteristics

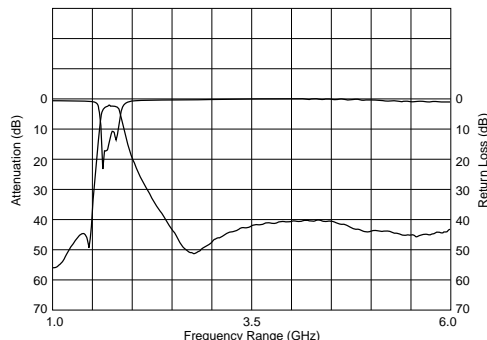

Part Number	Nominal Center Frequency (fo) (MHz)	Bandwidth (BW) (MHz)	Insertion Loss in BW (dB)	Attenuation (Absolute Value) I (dB)	Attenuation (Absolute Value) II (dB)
LFB321G74SN1-770	1747.5	fo±37.5	2.5 max. (at 25°C)	20 min. at D.C.~1350MHz	30 min. at 1350~1425MHz
LFB321G84SN1-796	1842.5	fo±37.5	2.5 max. (at 25°C)	48 min. at 500~1450MHz	40 min. at 1450~1480MHz
LFB321G90SN1-593	1907.5	fo±12.5	2.5 max. (at 25°C)	40 min. at 1406.5~1440MHz	35 min. at 1655~1680MHz
LFB322G45SN1-947	2450	fo±50	2.5 max. (at 25°C)	40 min. at 1950MHz	16 min. at 2200MHz
LFB322G45SN1A504	2450	fo±50	1.8 max. (at 25°C)	48 min. at 902~928MHz	50 min. at 1500~1550MHz
LFB322G45SN5A515	2450	fo±50	2.5 max. (at 25°C)	40 min. at 880~1250MHz	20 min. at 1250~1710MHz

7

Filters for Communication Equipment

for RF/Local

Chip Multilayer LC Filters (LPF)

● LFL15\_TC (0402) /LFL18\_TC (0603) /LFL21\_TC (0805) Series

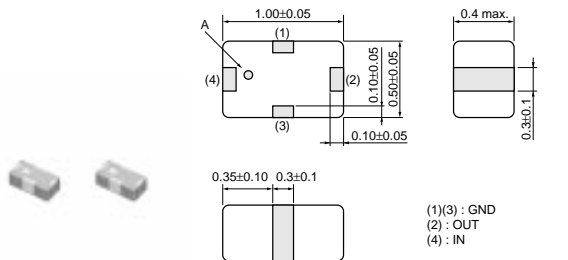

LFL15\_TC Series

A : Directional Input Mark

All the technical data and information contained herein are subject to change without prior notice.

(in mm)

Frequency Characteristics

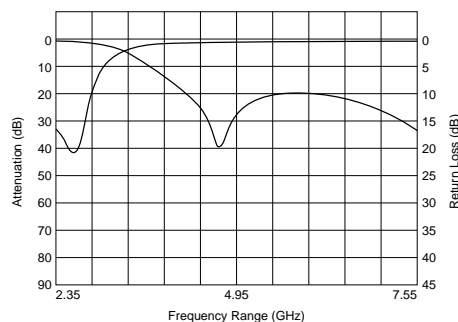

Continued on the following page. ↗

Continued from the preceding page.



LFL18\_TC Series

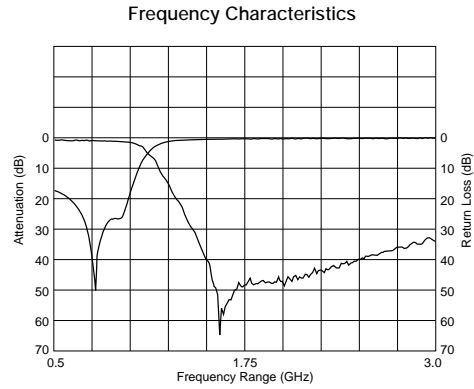
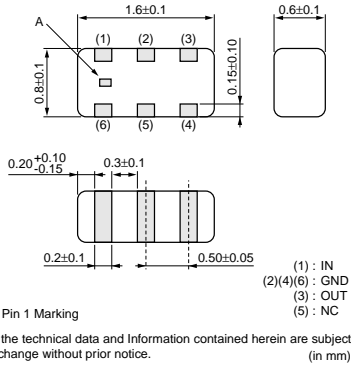

LFL21\_TC Series

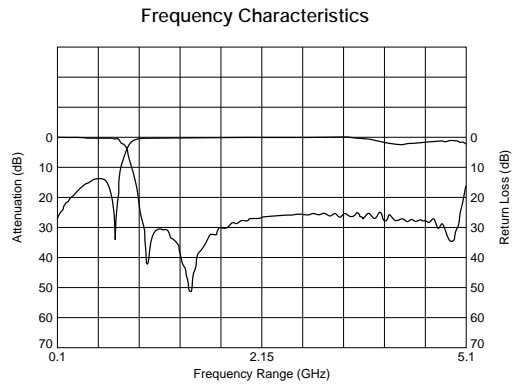
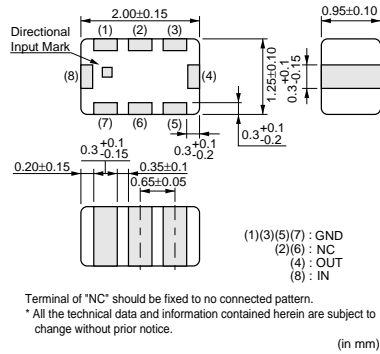

Part Number	Nominal Center Frequency (fo) (MHz)	Bandwidth (BW) (MHz)	Insertion Loss in BW (dB)	Attenuation (Absolute Value) I) (dB)	Attenuation (Absolute Value) II) (dB)
LFL152G45TC1A219	2450	fo±50	0.45 max. (at 25°C)	21 min. at 2x(fo±50.0)MHz	21 min. at 3x(fo±50.0)MHz
LFL18815MTC2A072	815.5	fo±9.5	0.80 max. (at 25°C)	35 min. at 2x(fo±9.5)MHz	30 min. at 3x(fo±9.5)MHz
LFL18924MTC1A052	924.5	fo±35	0.40 max. (at 25°C)	20 min. at 2x(fo±35.0)MHz	15 min. at 3x(fo±35.0)MHz
LFL182G45TC1A108	2450	fo±50	0.37 max. (at 25°C)	27 min. at 4800~5000MHz	25 min. at 7200~7500MHz
LFL182G45TC1A202	2450	fo±50	0.40 max. (at 25°C)	27 min. at 4800~5000MHz	30 min. at 7200~7500MHz
LFL21600MTC1A002	600	fo±250	1.37 max. (at 25°C)	20 min. at 1550~4250MHz	9 min. at 1100MHz
LFL21847MTC1A006	847.5	fo±37.5	0.75 max. (at 25°C)	30 min. at 2x(fo±37.5)MHz	30 min. at 3x(fo±37.5)MHz
LFL21902MTC1A018	902.5	fo±12.5	0.6 max. (at 25°C)	30 min. at 2x(fo±12.5)MHz	30 min. at 3x(fo±12.5)MHz
LFL211G35TC1A001	1350.0	fo±250	0.92 max. (at 25°C)	25 min. at 2300~5000MHz	-
LFL211G44TC1A014	1441.0	fo±12.0	0.47 max. (at 25°C)	31 min. at 2xfoMHz	26 min. at 3xfoMHz
LFL211G79TC1A011	1795	fo±85	0.47 max. (at 25°C)	30 min. at 2x(1747.5±37.5)MHz	25 min. at 2x(1842.5±37.5)MHz
LFL211G89TC1A015	1890	fo±10.0	0.47 max. (at 25°C)	30 min. at 2x(fo±10.0)MHz	26 min. at 3x(fo±10.0)MHz
LFL211G90TC1A008	1907.5	fo±12.5	0.47 max. (at 25°C)	30 min. at 2x(fo±12.5)MHz	25 min. at 3x(fo±12.5)MHz
LFL211G92TC1A060	1920	fo±70	0.6 max. (at 25°C)	24 min. at 3335~3700MHz	30 min. at 3700~3820MHz
LFL212G45TC1A007	2450	fo±50	0.50 max. (at 25°C)	27 min. at 2x(fo±50.0)MHz	30 min. at 3x(fo±50.0)MHz
LFL215G25TC1A156	5250	fo±100.0	0.70 max. (at 25°C)	24 min. at 2x(fo±100)MHz	19 min. at 3x(fo±100)MHz
LFL215G37TC1A210	5375	fo±475	0.70 max. (at 25°C)	30 min. at 2x(fo±475)MHz	20 min. at 3x(fo±475)MHz
LFL215G51TC1A149	5512	fo±363	0.70 max. (at 25°C)	30 min. at 2x(fo±363)MHz	20 min. at 3x(fo±363)MHz
LFL215G78TC1A155	5787.5	fo±62.5	0.70 max. (at 25°C)	30 min. at 2x(fo±62.5)MHz	20 min. at 3x(fo±62.5)MHz

△Note • This catalog has only typical specifications because there is no space for detailed specifications. Therefore, please approve our product specifications or transact the approval sheet for product specifications before ordering. Especially, please read rating and △CAUTION (for storage, operating, rating, soldering, mounting and handling) in them to prevent smoking and/or burning, etc.  
• You are able to read a detailed specifications in the website (<http://search.murata.co.jp/>) before to require our product specifications or to transact the approval sheet for product specifications.



# for RF/Local

## Chip Multilayer LC Filters (HPF)

● LFH32\_RA Series (1210)

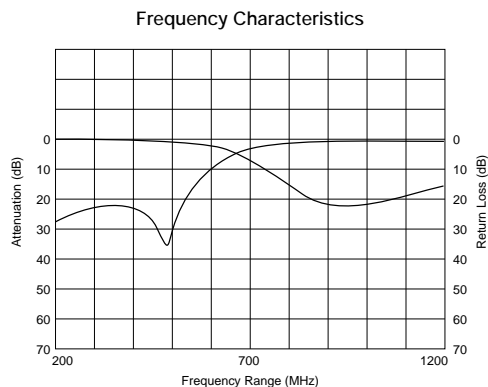
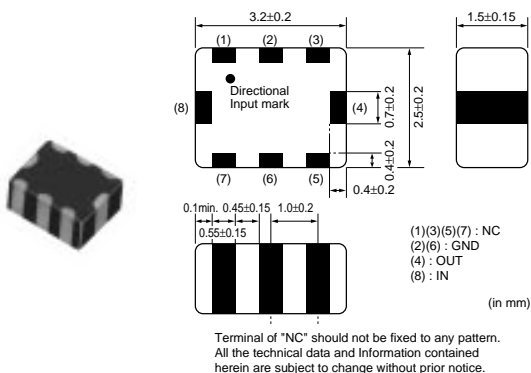

Part Number	Nominal Center Frequency (fo) (MHz)	Bandwidth (BW) (MHz)	Insertion Loss in BW (dB)	Attenuation (Absolute Value) I (dB)	Attenuation (Absolute Value) II (dB)
LFH32942MRA1A517	942.5	fo±17.5	0.5 max. (at 25°C)	4.5 min. at 480~600MHz	25 min. at 480MHz

# for RF/Local

## Chip Multilayer Diplexers

7

Filters for Communication Equipment

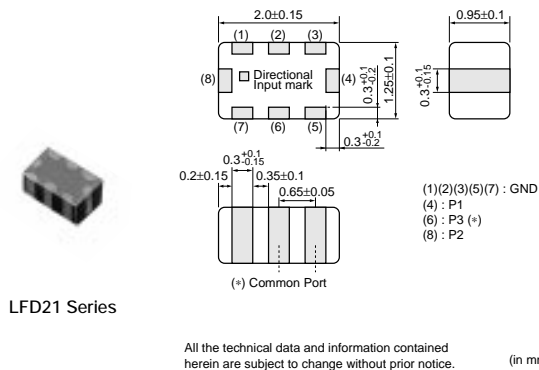

LFD21 Series

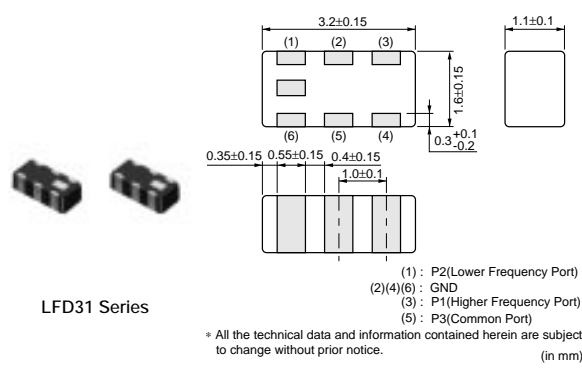

LFD31 Series

All the technical data and information contained herein are subject to change without prior notice. (in mm)

\* All the technical data and information contained herein are subject to change without prior notice. (in mm)

Part Number	Frequency Range[P1](f1) (MHz)	Frequency Range[P2](f2) (MHz)	Insertion Loss [P1-P3](in f1) (dB)	Insertion Loss [P2-P3](in f2) (dB)	Attenuation [P1-P3](in f2) (dB)	Attenuation [P2-P3](in f1) (dB)
LFD212G45DP3A140	5250 ±100.0MHz	2450 ±50.0MHz	0.65 max. (at 25°C)	0.50 max. (at 25°C)	20 min.	20 min.
LFD212G45DP3A151	5487.5 ±337.5MHz	2450 ±50.0MHz	0.75 max. (at 25°C)	0.50 max. (at 25°C)	20 min.	16 min.
LFD212G45DP3A188	5375 ±475.0MHz	2450 ±50.0MHz	0.75 max. (at 25°C)	0.50 max. (at 25°C)	21 min.	17 min.
LFD212G45DP4A189	2450 ±50.0MHz	5375 ±475.0MHz	0.5 max. (at 25°C)	0.75 max. (at 25°C)	17 min.	21 min.
LFD21859MDP1A049	1920 ±70.0MHz	859 ±35.0MHz	0.45 max. (at 25°C)	0.40 max. (at 25°C)	19 min.	20 min.
LFD21884MDP1A062	1906.5 ±13.0MHz	884 ±74.0MHz	0.45 max. (at 25°C)	0.50 max. (at 25°C)	20 min.	20 min.
LFD21920MDP1A048	1795 ±85.0MHz	920 ±40.0MHz	0.55 max. (at 25°C)	0.50 max. (at 25°C)	20 min.	16 min.
LFD31859MDP1A009	1920 ±70.0MHz	859 ±35.0MHz	0.45 max. (at 25°C)	0.40 max. (at 25°C)	20 min.	20 min.
LFD31884MDP1A030	1906.5 ±13.0MHz	884 ±74.0MHz	0.45 max. (at 25°C)	0.50 max. (at 25°C)	19 min.	19 min.
LFD31897MDP1A010	1810 ±100.0MHz	897.5 ±17.5MHz	0.6 max. (at 25°C)	0.5 max. (at 25°C)	20 min.	17 min.
LFD31920MDP1A003	1795 ±85.0MHz	920 ±40.0MHz	0.55 max. (at 25°C)	0.50 max. (at 25°C)	20 min.	16 min.
LFD31920MDP1A040	1850 ±140.0MHz	920 ±40.0MHz	0.65 max. (at 25°C)	0.50 max. (at 25°C)	20 min.	15 min.
LFD31993MDP1A032	2072.34 ±30.0MHz	993.84 ±12.5MHz	0.4 max. (at 25°C)	0.4 max. (at 25°C)	20 min.	20 min.

△Note • This catalog has only typical specifications because there is no space for detailed specifications. Therefore, please approve our product specifications or transact the approval sheet for product specifications before ordering. Especially, please read rating and △CAUTION (for storage, operating, rating, soldering, mounting and handling) in them to prevent smoking and/or burning, etc.  
 • You are able to read a detailed specifications in the website (<http://search.murata.co.jp/>) before to require our product specifications or to transact the approval sheet for product specifications.

# for RF/Local

## Chip Multilayer LC Filters (Trap)

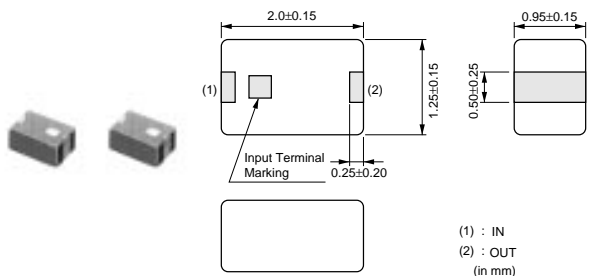

Part Number	Center Frequency of Rejection Band (MHz)	Pass Bandwidth (BW) (MHz)	Insertion Loss in BW (dB)	Attenuation (Absolute Value) (dB)
LFE21560MFA1A004	560	810-885	0.7 max. (at 25°C)	10.0 min. at 550-570MHz

# for RF/Local

## SAW Filters

● GPS

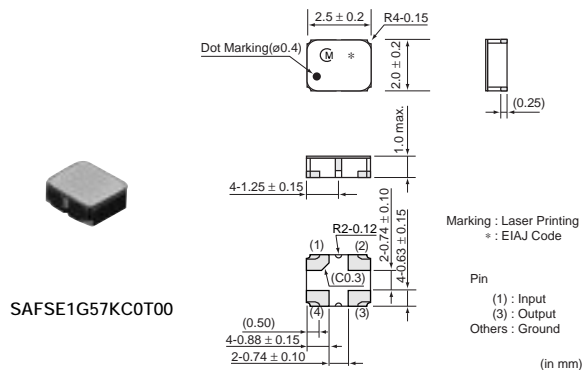

SAFSE1G57KC0T00

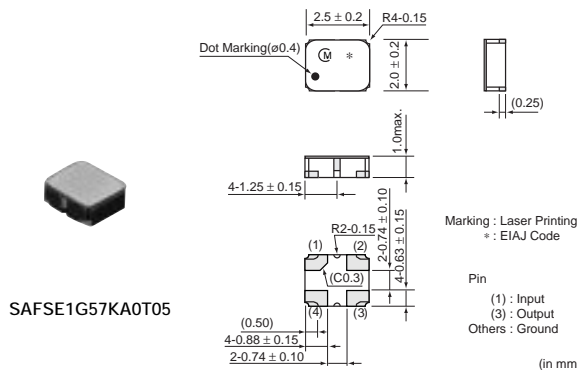

SAFSE1G57KA0T05

Part Number	Center Frequency (MHz)	Insertion Loss (dB)	Ripple (dB max.)	VSWR	Input Impedance	Output Impedance
SAFSE1G57KC0T00	1575.5	2.5 max. (1574MHz-1577MHz)	0.7 (1574MHz-1577MHz)	1.6max (1574MHz-1577MHz)	50ohm	50ohm
SAFSD1G57FA0T00	1575.5	1.6 max. (1574MHz-1577MHz)	0.5 (1574MHz-1577MHz)	1.6max. (1574MHz-1577MHz)	50ohm	100ohm
SAFSE1G57KA0T05	1575.5	1.6 max. (1574MHz-1577MHz)	0.7 (1574MHz-1577MHz)	1.6max. (1574MHz-1577MHz)	50ohm	50ohm
SAFSE1G57KA0T09	1575.42	2.0 max. (1574.42MHz-1576.42MHz)	1.5 (1574.42MHz-1576.42MHz)	1.8max. (1574.42MHz-1576.42MHz)	50ohm	50ohm

△Note • This catalog has only typical specifications because there is no space for detailed specifications. Therefore, please approve our product specifications or transact the approval sheet for product specifications before ordering. Especially, please read rating and △CAUTION (for storage, operating, rating, soldering, mounting and handling) in them to prevent smoking and/or burning, etc.  
 • You are able to read a detailed specifications in the website (<http://search.murata.co.jp/>) before to require our product specifications or to transact the approval sheet for product specifications.

● GSM850

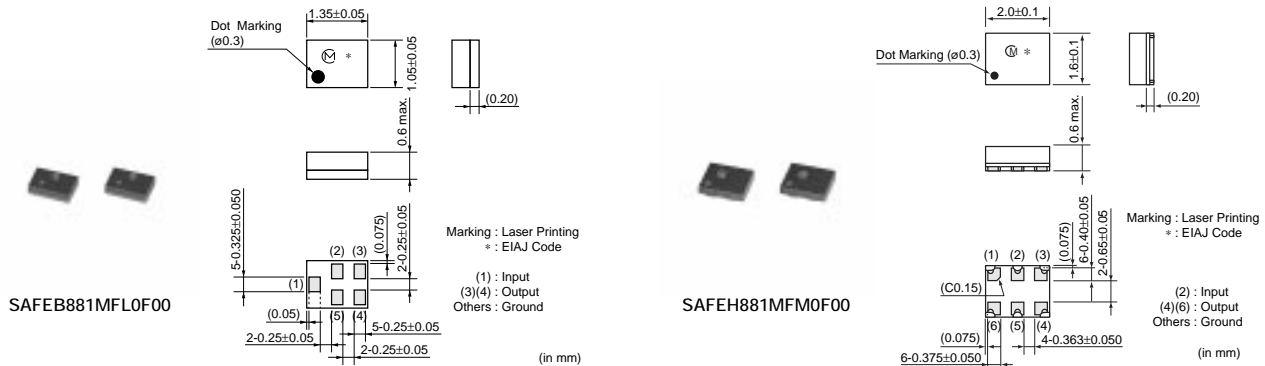

Part Number	Center Frequency (MHz)	Insertion Loss (dB)	Ripple (dB max.)	VSWR	Input Impedance	Output Impedance
SAFEB881MFL0F00	881.5	2.3 max. (869MHz-894MHz)	1.2 (869MHz-894MHz)	1.8max. (869MHz-894MHz)	50ohm	150ohm//82nH
SAFEH881MFM0F00	881.5	2.4 max. (869MHz-894MHz)	1.5 (869MHz-894MHz)	1.9max. (869MHz-894MHz)	50ohm	150ohm//82nH
SAFEB881MAL0F00	881.5	2.6 max. (869MHz-894MHz)	1.4 (869MHz-894MHz)	1.7max. (869MHz-894MHz)	50ohm	50ohm
SAFED881MFL0F05	881.5	1.9 max. (869MHz-894MHz)	1.0 (869MHz-894MHz)	1.8max. (869MHz-894MHz)	50ohm	150ohm//68nH
SAFSD881MFL0T50	881.5	3.0 max. (869MHz-894MHz)	1.4 (869MHz-894MHz)	2.0max. (869MHz-894MHz)	50ohm	200ohm//82nH

Filters for Communication Equipment

7

● GSM850/GSM900 Dual Band

Part Number	Center Frequency (MHz)	Insertion Loss (dB)	Ripple (dB max.)	VSWR	Input Impedance	Output Impedance
SAWES881MCQ0F00(942.5)	942.5	2.9 max. (925MHz-960MHz)	1.7 (925MHz-960MHz)	2.2max. (925MHz-960MHz)	50ohm	150ohm//56nH
SAWES881MCQ0F00(881.5)	881.5	2.1 max. (869MHz-894MHz)	1.0 (869MHz-894MHz)	1.9max. (869MHz-894MHz)	50ohm	150ohm//68nH

● GSM850/GSM1900 Dual Band

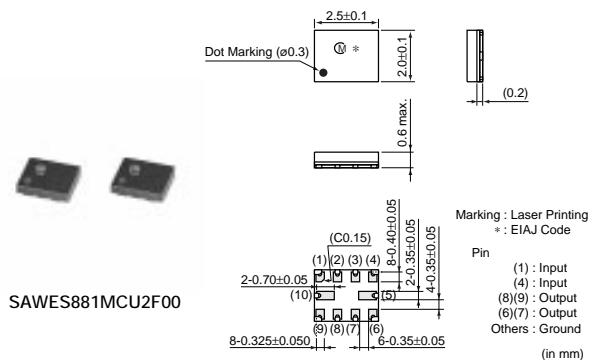

Part Number	Center Frequency (MHz)	Insertion Loss (dB)	Ripple (dB max.)	VSWR	Input Impedance	Output Impedance
SAWES881MCU2F00(881.5)	881.5	2.1 max. (869MHz-894MHz)	1.0 (869MHz-894MHz)	1.9max. (869MHz-894MHz)	50ohm	150ohm//68nH
SAWES881MCU2F00(1960)	1960	3.0 max. (1930MHz-1990MHz)	1.9 (1930MHz-1990MHz)	2.4max. (1930MHz-1990MHz)	50ohm	150ohm//22nH

Continued on the following page.

△Note • This catalog has only typical specifications because there is no space for detailed specifications. Therefore, please approve our product specifications or transact the approval sheet for product specifications before ordering. Especially, please read rating and △CAUTION (for storage, operating, rating, soldering, mounting and handling) in them to prevent smoking and/or burning, etc.  
 • You are able to read a detailed specifications in the website (<http://search.murata.co.jp/>) before to require our product specifications or to transact the approval sheet for product specifications.

Continued from the preceding page.

Part Number	Center Frequency (MHz)	Insertion Loss (dB)	Ripple (dB max.)	VSWR	Input Impedance	Output Impedance
<b>SAWSP881MGA0T00(881.5)</b>	881.5	2.9 max. (869MHz-894MHz)	1.5 (869MHz-894MHz)	2.0max. (869MHz-894MHz)	50ohm	50ohm
<b>SAWSP881MGA0T00(1960)</b>	1960	3.2 max. (1930MHz-1990MHz)	2.0 (1930MHz-1990MHz)	2.4max. (1930MHz-1990MHz)	50ohm	50ohm
<b>SAWSU881MCQ0T01(881.5)</b>	881.5	3.0 max. (869MHz-894MHz)	1.8 (869MHz-894MHz)	2.0max. (869MHz-894MHz)	50ohm	200ohm//56nH
<b>SAWSU881MCQ0T01(1960)</b>	1960	3.0 max. (1930MHz-1990MHz)	2.4 (1930MHz-1990MHz)	2.2max. (1930MHz-1990MHz)	50ohm	200ohm//15nH

● GSM900

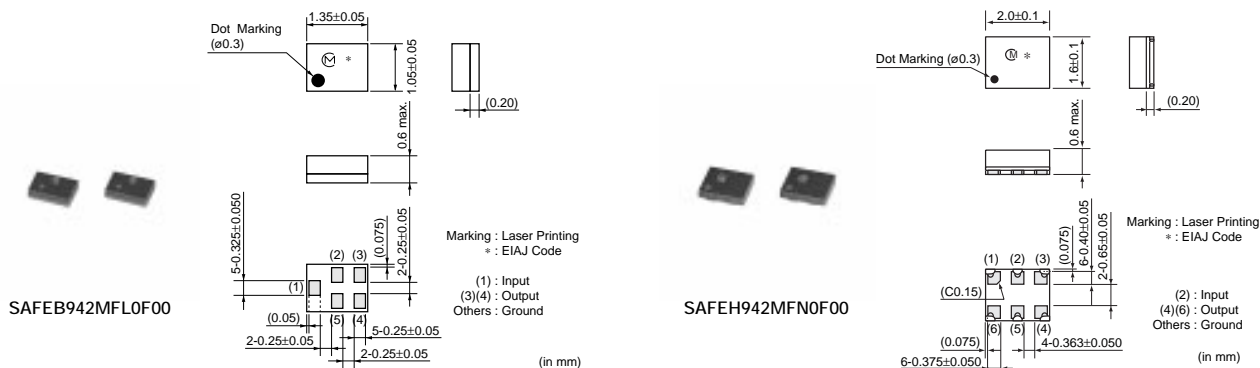

Part Number	Center Frequency (MHz)	Insertion Loss (dB)	Ripple (dB max.)	VSWR	Input Impedance	Output Impedance
<b>SAFEB942MFL0F00</b>	942.5	2.7 max. (925MHz-960MHz)	1.7 (925MHz-960MHz)	2.0max. (925MHz-960MHz)	50ohm	150ohm//82nH
<b>SAFED942MFM0F00</b>	942.5	2.2 max. (925MHz-960MHz)	1.3 (925MHz-960MHz)	2.1max. (925MHz-960MHz)	50ohm	150ohm//82nH
<b>SAFEH942MFN0F00</b>	942.5	2.7 max. (925MHz-960MHz)	1.8 (925MHz-960MHz)	2.0max. (925MHz-960MHz)	50ohm	150ohm//82nH
<b>SAFEB942MAL0F00</b>	942.5	3.0 max. (925MHz-960MHz)	1.7 (925MHz-960MHz)	2.1max. (925MHz-960MHz)	50ohm	50ohm
<b>SAFSD942MFM0T00</b>	942.5	3.2 max. (925MHz-960MHz)	2.2 (925MHz-960MHz)	2.3max. (925MHz-960MHz)	50ohm	200ohm//82nH
<b>SAFSD942MCL0T00</b>	942.5	3.3 max. (925MHz-960MHz)	1.8 (925MHz-960MHz)	2.0max. (925MHz-960MHz)	50ohm	50ohm
<b>SAFSE942MAL0T05</b>	942.5	3.2 max. (925MHz-960MHz)	2.0 (925MHz-960MHz)	2.2max. (925MHz-960MHz)	50ohm	50ohm

● GSM900/GSM1800 Dual Band J-CDMA

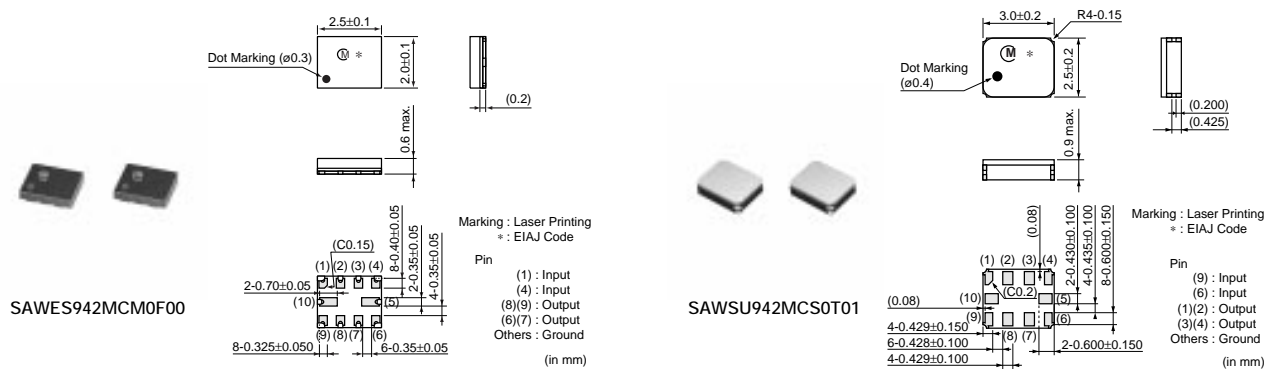

△Note • This catalog has only typical specifications because there is no space for detailed specifications. Therefore, please approve our product specifications or transact the approval sheet for product specifications before ordering. Especially, please read rating and △CAUTION (for storage, operating, rating, soldering, mounting and handling) in them to prevent smoking and/or burning, etc.  
 • You are able to read a detailed specifications in the website (<http://search.murata.co.jp/>) before to require our product specifications or to transact the approval sheet for product specifications.

Part Number	Center Frequency (MHz)	Insertion Loss (dB)	Ripple (dB max.)	VSWR	Input Impedance	Output Impedance
SAWES942MCQ0F00(942.5)	942.5	2.9 max. (925MHz-960MHz)	1.7 (925MHz-960MHz)	2.2max. (925MHz-960MHz)	50ohm	150ohm//56nH
SAWES942MCQ0F00(1842.5)	1842.5	2.6 max. (1805MHz-1880MHz)	1.7 (1805MHz-1880MHz)	2.4max. (1805MHz-1880MHz)	50ohm	150ohm//15nH
SAWES942MCM0F00(942.5)	942.5	2.8 max. (925MHz-960MHz)	1.5 (925MHz-960MHz)	2.0max. (925MHz-960MHz)	50ohm	150ohm//56nH
SAWES942MCM0F00(1842.5)	1842.5	3.0 max. (1805MHz-1880MHz)	1.8 (1805MHz-1880MHz)	2.2max. (1805MHz-1880MHz)	50ohm	150ohm//18nH
SAWES942MCQ0F05(942.5)	942.5	2.9 max. (925MHz-960MHz)	1.7 (925MHz-960MHz)	2.2max. (925MHz-960MHz)	50ohm	150ohm//56nH
SAWES942MCQ0F05(1842.5)	1842.5	2.6 max. (1805MHz-1880MHz)	1.7 (1805MHz-1880MHz)	2.4max. (1805MHz-1880MHz)	50ohm	150ohm//15nH
SAWSP942MLD0T00(942.5)	942.5	3.0 max. (925MHz-960MHz)	2.0 (925MHz-960MHz)	2.5max. (925MHz-960MHz)	50ohm	50ohm
SAWSP942MLD0T00(1842.5)	1842.5	3.2 max. (1805MHz-1880MHz)	2.0 (1805MHz-1880MHz)	2.5max. (1805MHz-1880MHz)	50ohm	50ohm
SAWSU942MCS0T01(942.5)	942.5	3.2 max. (925MHz-960MHz)	2.2 (925MHz-960MHz)	2.4max. (925MHz-960MHz)	50ohm	200ohm//47nH
SAWSU942MCS0T01(1842.5)	1842.5	3.2 max. (1805MHz-1880MHz)	2.2 (1805MHz-1880MHz)	2.5max. (1805MHz-1880MHz)	50ohm	200ohm//16nH

● GSM1800

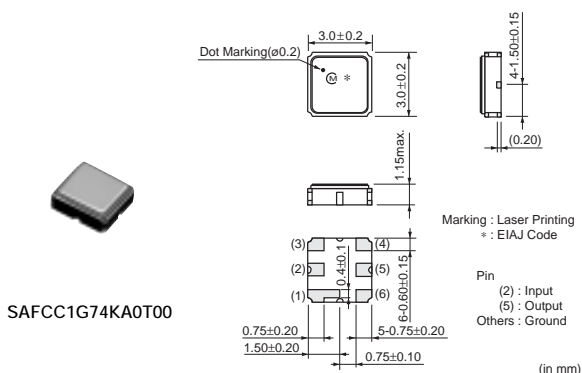
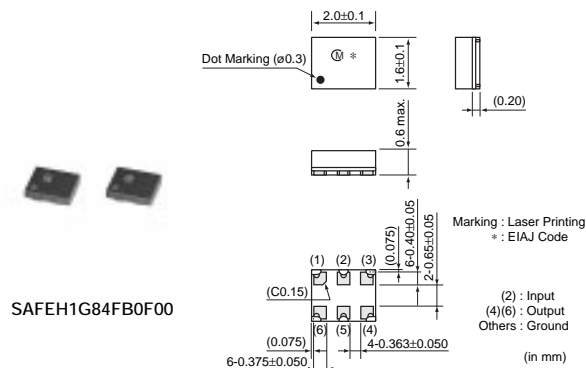
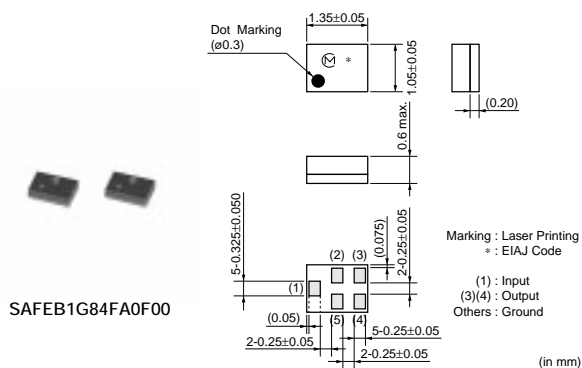

Part Number	Center Frequency (MHz)	Insertion Loss (dB)	Ripple (dB max.)	VSWR	Input Impedance	Output Impedance
SAFEB1G84FA0F00	1842.5	2.5 max. (1805-1880MHz)	1.5 (1805MHz-1880MHz)	2.2max. (1805MHz-1880MHz)	50ohm	150ohm//18nH
SAFED1G84FB0F00	1842.5	2.0 max. (1805-1880MHz)	1.3 (1805MHz-1880MHz)	2.5max. (1805MHz-1880MHz)	50ohm	150ohm//18nH

Continued on the following page.

△Note • This catalog has only typical specifications because there is no space for detailed specifications. Therefore, please approve our product specifications or transact the approval sheet for product specifications before ordering. Especially, please read rating and △CAUTION (for storage, operating, rating, soldering, mounting and handling) in them to prevent smoking and/or burning, etc.  
• You are able to read a detailed specifications in the website (<http://search.murata.co.jp/>) before to require our product specifications or to transact the approval sheet for product specifications.

Continued from the preceding page.

Part Number	Center Frequency (MHz)	Insertion Loss (dB)	Ripple (dB max.)	VSWR	Input Impedance	Output Impedance
<b>SAFEH1G84FB0F00</b>	1842.5	2.5 max. (1805-1880MHz)	1.5 (1805MHz-1880MHz)	2.2max. (1805MHz-1880MHz)	50ohm	150ohm//18nH
<b>SAFEF1G84AA0F00</b>	1842.5	2.8 max. (1805-1880MHz)	1.7 (1805MHz-1880MHz)	2.2max. (1805MHz-1880MHz)	50ohm	50ohm
<b>SAFSE1G84KA0T00</b>	1842.5	3.2 max. (1805-1880MHz)	2.2 (1805MHz-1880MHz)	2.8max. (1805MHz-1880MHz)	50ohm	50ohm
<b>SAFSD1G84FA0T00</b>	1842.5	3.0 max. (1805-1880MHz)	2.0 (1805MHz-1880MHz)	2.7max. (1805MHz-1880MHz)	50ohm	200ohm//27nH
<b>SAFSD1G84CB0T00</b>	1842.5	3.8 max. (1805-1880MHz)	2.0 (1805MHz-1880MHz)	2.7max. (1805MHz-1880MHz)	50ohm	50ohm
<b>SAFCC1G74KA0T00</b>	1747.5	4.2 max. (1710MHz-1785MHz)	2.6 (1710MHz-1785MHz)	2.5max. (1710MHz-1785MHz)	50ohm	50ohm

● GSM1800/GSM1900 Dual Band

Part Number	Center Frequency (MHz)	Insertion Loss (dB)	Ripple (dB max.)	VSWR	Input Impedance	Output Impedance
<b>SAWES1G84CQ0F00(1960)</b>	1960	3.0 max. (1930MHz-1990MHz)	1.9 (1930MHz-1990MHz)	2.4max. (1930MHz-1990MHz)	50ohm	150ohm//22nH
<b>SAWES1G84CQ0F00(1842.5)</b>	1842.5	2.6 max. (1805MHz-1880MHz)	1.7 (1805MHz-1880MHz)	2.4max. (1805MHz-1880MHz)	50ohm	150ohm//15nH

● GSM1900

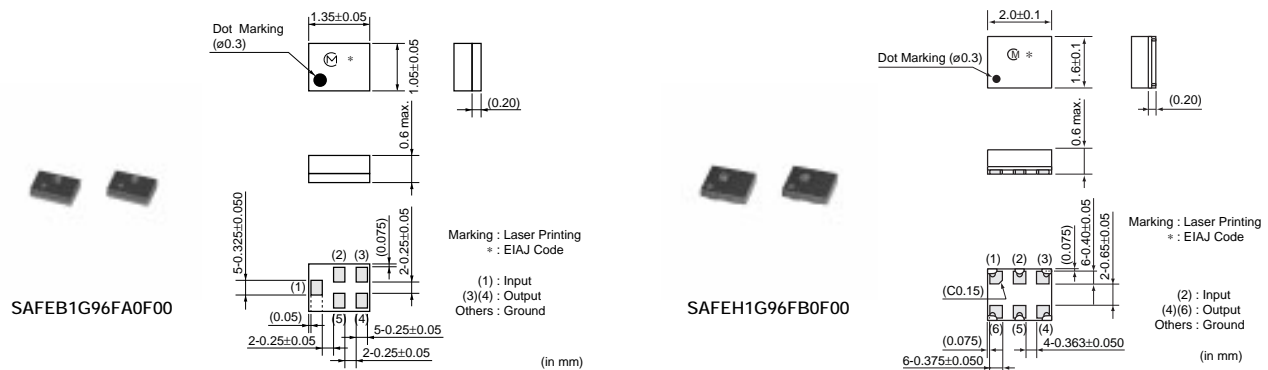

Part Number	Center Frequency (MHz)	Insertion Loss (dB)	Ripple (dB max.)	VSWR	Input Impedance	Output Impedance
<b>SAFEB1G96FA0F00</b>	1960	2.6 max. (1930-1990MHz)	1.8 (1930MHz-1990MHz)	2.2max. (1930MHz-1990MHz)	50ohm	150ohm//27nH
<b>SAFED1G96FA0F00</b>	1960	2.6 max. (1930-1990MHz)	1.4 (1930MHz-1990MHz)	2.2max. (1930MHz-1990MHz)	50ohm	150ohm//18nH
<b>SAFEH1G96FB0F00</b>	1960	2.6 max. (1930-1990MHz)	1.8 (1930MHz-1990MHz)	2.2max. (1930MHz-1990MHz)	50ohm	150ohm//22nH
<b>SAFEF1G96AA0F00</b>	1960	2.8 max. (1930-1990MHz)	1.7 (1930MHz-1990MHz)	2.4max. (1930MHz-1990MHz)	50ohm	50ohm
<b>SAFSE1G96KD0T00</b>	1960	3.0 max. (1930-1990MHz)	2.0 (1930MHz-1990MHz)	2.5max. (1930MHz-1990MHz)	50ohm	50ohm
<b>SAFSD1G96FB0T00</b>	1960	3.0 max. (1930-1990MHz)	2.4 (1930MHz-1990MHz)	2.4max. (1930MHz-1990MHz)	50ohm	200ohm//22nH

Note • This catalog has only typical specifications because there is no space for detailed specifications. Therefore, please approve our product specifications or transact the approval sheet for product specifications before ordering. Especially, please read rating and CAUTION (for storage, operating, rating, soldering, mounting and handling) in them to prevent smoking and/or burning, etc.  
 • You are able to read a detailed specifications in the website (<http://search.murata.co.jp/>) before to require our product specifications or to transact the approval sheet for product specifications.

● J-CDMA

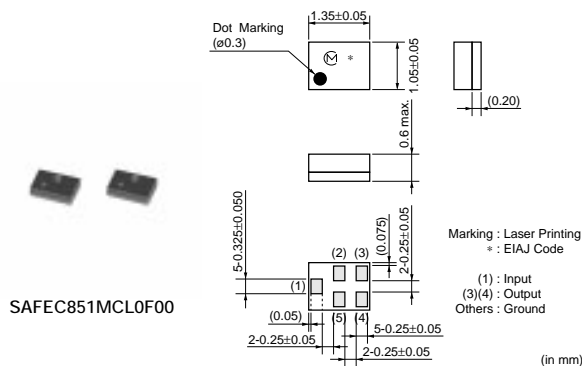

Part Number	Center Frequency (MHz)	Insertion Loss (dB)	Ripple (dB max.)	VSWR	Input Impedance	Output Impedance
<b>SAFEC851MCL0F00</b>	851	2.8 max. (832MHz-870MHz)	1.7 (832MHz-870MHz)	2.5max. (832MHz-870MHz)	50ohm	100ohm//56nH
<b>SAFEF906MAM0F00</b>	906	3.2 max. (887MHz-925MHz)	1.5 (887MHz-925MHz)	2.4max. (887MHz-925MHz)	50ohm	50ohm
<b>SAFSE906MAM0T00</b>	906	4.0 max. (887MHz-925MHz)	2.5 (887MHz-925MHz)	2.4max. (887MHz-925MHz)	50ohm	50ohm
<b>SAFSE851MKB0T00</b>	851	3.4 max. (832MHz-870MHz)	2.5 (832MHz-870MHz)	2.2max. (832MHz-870MHz)	50ohm	50ohm
<b>SAFSD906MCL0T00</b>	906	4.2 max. (887MHz-925MHz)	2.5 (887MHz-925MHz)	2.8max. (887MHz-925MHz)	50ohm	50ohm
<b>SAFSD851MXA0T00</b>	851	2.6 max. (832MHz-870MHz)	1.9 (832MHz-870MHz)	2.7max. (832MHz-870MHz)	50ohm	100ohm//56nH

7 Filters for Communication Equipment

● PCS(CDMA)

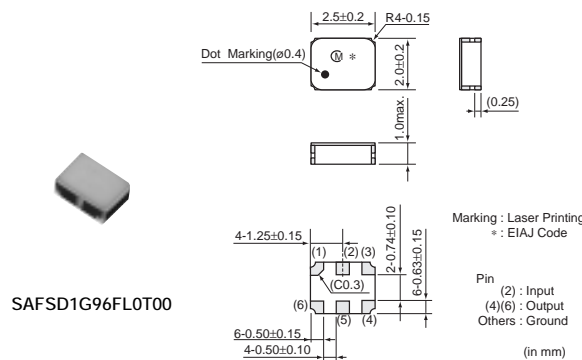

Part Number	Center Frequency (MHz)	Insertion Loss (dB)	Ripple (dB max.)	VSWR	Input Impedance	Output Impedance
<b>SAFSE1G88KC0T00</b>	1880	5.0 max. (1850MHz-1910MHz)	3.5 (1850MHz-1910MHz)	2.2max. (1850MHz-1910MHz)	50ohm	50ohm
<b>SAFSD1G96FL0T00</b>	1960	4.0 max. (1930MHz-1990MHz)	2.0 (1930MHz-1990MHz)	2.1max. (1930MHz-1990MHz)	50ohm	100ohm

△Note • This catalog has only typical specifications because there is no space for detailed specifications. Therefore, please approve our product specifications or transact the approval sheet for product specifications before ordering. Especially, please read rating and △CAUTION (for storage, operating, rating, soldering, mounting and handling) in them to prevent smoking and/or burning, etc.  
 • You are able to read a detailed specifications in the website (<http://search.murata.co.jp/>) before to require our product specifications or to transact the approval sheet for product specifications.

● W-CDMA

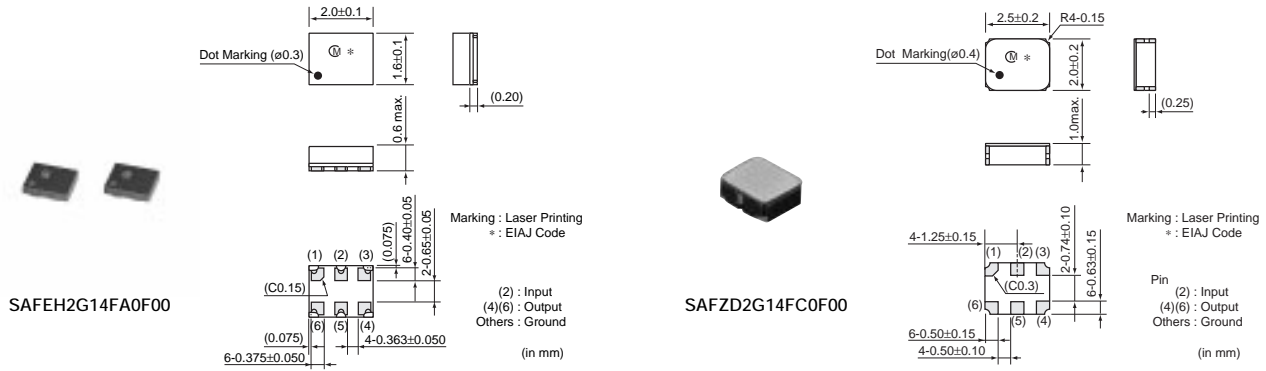

Part Number	Center Frequency (MHz)	Insertion Loss (dB)	Ripple (dB max.)	VSWR	Input Impedance	Output Impedance
<b>SAFEH2G14FA0F00</b>	2140	2.3 max. (2110-2170MHz)	1.2 (2110MHz-2170MHz)	1.8max. (2110MHz-2170MHz)	50ohm	200ohm//27nH
<b>SAFEH1G95FL0F00</b>	1950	2.8 max. (1920-1980MHz)	1.5 (1920MHz-1980MHz)	2.0max. (1920MHz-1980MHz)	200ohm//33nH	50ohm
<b>SAFEF1G95KA0F00</b>	1950	3.0 max. (1920-1980MHz)	1.7 (1920MHz-1980MHz)	2.0max. (1920MHz-1980MHz)	50ohm	50ohm
<b>SAFZE1G95KD0F00</b>	1950	3.2 max. (1920-1980MHz)	1.5 (1920MHz-1980MHz)	2.6max. (1920MHz-1980MHz)	50ohm	50ohm
<b>SAFZD2G14FC0F00</b>	2140	2.7 max. (2110-2170MHz)	1.3 (2110MHz-2170MHz)	2.3max. (2110MHz-2170MHz)	50ohm	100ohm
<b>SAFSE1G95KD0F00</b>	1950	3.2 max. (1920-1980MHz)	1.5 (1920MHz-1980MHz)	2.6max. (1920MHz-1980MHz)	50ohm	50ohm
<b>SAFSE2G14KB0T00</b>	2140	2.7 max. (2110-2170MHz)	1.3 (2110MHz-2170MHz)	2.0max. (2110MHz-2170MHz)	50ohm	50ohm
<b>SAFSE1G95KC0T00</b>	1950	3.0 max. (1920-1980MHz)	1.5 (1920MHz-1980MHz)	2.0max. (1920MHz-1980MHz)	50ohm	50ohm
<b>SAFSD2G14FA0T00</b>	2140	2.7 max. (2110MHz-2170MHz)	1.5 (2110MHz-2170MHz)	2.2max. (2110MHz-2170MHz)	50ohm	200ohm//22nH
<b>SAFSD1G95FA0T00</b>	1950	3.2 max. (1920-1980MHz)	1.6 (1920MHz-1980MHz)	2.1max. (1920MHz-1980MHz)	200ohm//22nH	50ohm

● CDMA800/TDMA800/E-AMPS/GSM850

Part Number	Center Frequency (MHz)	Insertion Loss (dB)	Ripple (dB max.)	VSWR	Input Impedance	Output Impedance
<b>SAFEF836MAL0F00</b>	836.5	2.8 max. (824MHz-849MHz)	1.4 (824MHz-849MHz)	1.9max. (824MHz-849MHz)	50ohm	50ohm

△Note • This catalog has only typical specifications because there is no space for detailed specifications. Therefore, please approve our product specifications or transact the approval sheet for product specifications before ordering. Especially, please read rating and △CAUTION (for storage, operating, rating, soldering, mounting and handling) in them to prevent smoking and/or burning, etc.  
• You are able to read a detailed specifications in the website (<http://search.murata.co.jp/>) before to require our product specifications or to transact the approval sheet for product specifications.