

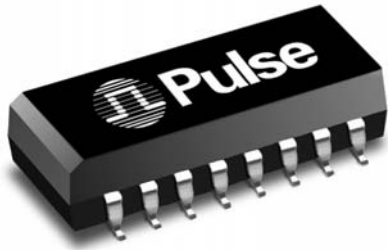



HOME PHONE NETWORKING BANDPASS FILTER



-  Supports HomePNA™ 1M8 Technology
-  Includes protection circuitry, isolation and EMI filtering
-  Designed to withstand 235°C peak infrared reflow temperature

Electrical Specifications @ 25°C — Operating Temperature -40°C to 85°C

PARAMETER	TEST CONDITION	MIN.	NOM.	MAX.	UNITS
HPN 1M8 Insertion Loss	6.0 MHz		3.2	4	dB
	7.5 MHz	Input (1-2), Output (10-9) HP-8751A S21 100 Ω	2.8	3.5	dB
	9.0 MHz		3.4	4	dB
HPN 1M8 Attenuation	1.0 MHz	Input (1-2), Output (10-9) HP-8751A S21 100 Ω	50	60	dB
	27 MHz		60	70	dB
HPN 1M8 Return Loss (6.0 MHz to 9.0 MHz)	Input (10-9), 100 Ω (1-2) HP-8751A S11 100 Ω	14 avg.			dB
Isolation	Pins (1-2) short to (10-9) shorted	2000			Vrms

NOTE: Filters are shipped in tubes unless Tape & Reel is specified. Please add the suffix "T" (i.e.B6003T) for Tape & Reel orders.

Mechanical

Schematic

B6003

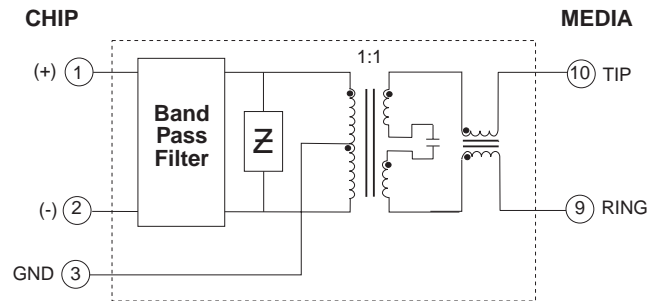
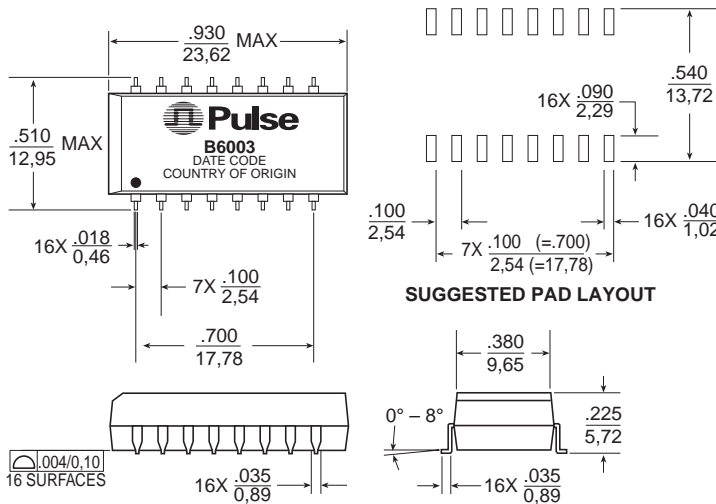

Weight 2.5 grams
Tape & Reel250/reel
Tube20/tube

Dimensions: $\frac{\text{Inches}}{\text{mm}}$
Unless otherwise specified, all tolerances are $\pm \frac{.010}{0.25}$

For More Information :

UNITED STATES (Worldwide)	UNITED KINGDOM (Northern Europe)	FRANCE (Southern Europe)	SINGAPORE (Southern Asia)	TAIWAN, R.O.C. (Northern Asia)	HONG KONG (China/Hong Kong)	DISTRIBUTOR
12220 World Trade Drive San Diego, CA 92128 U.S.A. http://www.pulseeng.com TEL: 858 674 8100 FAX: 858 674 8262	1 & 2 Huxley Road The Surrey Research Park Guildford, Surrey GU2 5RE United Kingdom TEL: 44 1483 401700 FAX: 44 1483 401701	Zone Industrielle F-39270 Orgelet France TEL: 33 3 84 35 04 04 FAX: 33 3 84 25 46 41	150 Kampong Ampat #07-01/02 KA Centre Singapore 368324 TEL: 65 6287 8998 FAX: 65 6280 0080	3F-4, No. 81, Sec. 1 HsinTai Wu Road Hsi-Chih, Taipei Hsien Taiwan, R.O.C. Tel: 886 2 2698 0228 FAX: 886 2 2698 0948	9/F, Phase 2, Tai Sang Shatin Warehouse Centre 6 Wong Chuk Yeung Street Fotan, Shatin, Hong Kong TEL: 852 2788 6588 FAX: 852 2776 1055	

Performance warranty of products offered on this data sheet is limited to the parameters specified. Data is subject to change without notice. Other brand and product names mentioned herein may be trademarks or registered trademarks of their respective owners.

 Printed on recycled paper. ©2003, Pulse Engineering, Inc.

B916.A (12/03)