





VDSL FILTER MODULES

For Infineon VDSL 10Base-S Chipsets



-  Matched to Infineon PEF22822/22811 VDSL 10Base-S chipsets
-  Single Port Filter modules for VDSL NT modem applications
-  Multi-function model includes: HPF Splitter, Hybrid Transformer, TX and RX Separation Filters and Common Mode Choke
-  Designed to meet IEC950 supplementary insulation requirements
-  Most compact footprint module available in the industry

Electrical Specifications @ 25°C — Operating Temperature -40°C to +85°C

Part Number	TX to Line Specifications			Line to RX Specifications		
	Insertion Loss (dB MAX) (4.1 MHz - 7.9 MHz)	Stopband Frequency	Attenuation (MIN) (dB)	Insertion Loss (dB MAX) (1 MHz - 3.4 MHz)	Stopband Frequency	Attenuation (dB MIN)
BX4039	1	10 kHz - 100 kHz	65	1.5	10 kHz - 300 kHz	30
		100 kHz - 300 kHz	20		4.1 MHz - 5.5 MHz	15
		17 MHz - 40 MHz	15		5.5 MHz - 40 MHz	30
BX4040	1	10 kHz - 100 kHz	65	1.5	10 kHz - 500 kHz	30
		100 kHz - 500 kHz	20		4.1 MHz - 5.5 MHz	15
		17 MHz - 40 MHz	15		5.5 MHz - 40 MHz	30

Additional Specifications

Part Number	Line Return Loss (dB MIN) 4.1 MHz - 7.9 MHz	Transhybrid Loss (dB MIN)		Isolation Voltage (Vrms)	Line Impedance (Ω)	TX Impedance (Ω)	RX Impedance (Ω)
		1 MHz - 3.4 MHz	4.1 MHz - 7.9 MHz				
BX4039	12	16	45	1500	120	40	270
BX4040	12	16	45	1500	120	40	270

NOTE: BX4039 is for ISDN/POTS applications. BX4040 is for Smartphone applications.

Mechanical

Schematic

BX4039/BX4040

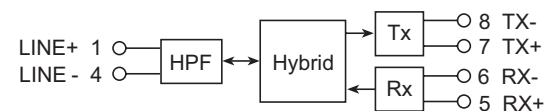
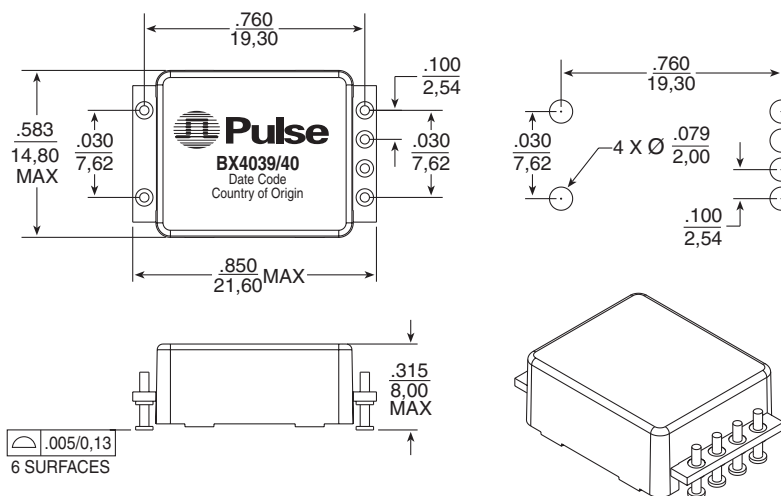

Weight 2.075 grams
Tape & Reel 650/reel
Tube 30/tube

Dimensions: $\frac{\text{Inches}}{\text{mm}}$
Unless otherwise specified, all tolerances are $\pm \frac{.010}{0.25}$

VDSL FILTER MODULES

For Infineon VDSL 10Base-S Chipsets



Typical Performance @ 25°C BX4039 & BX4040

RX Insertion Loss

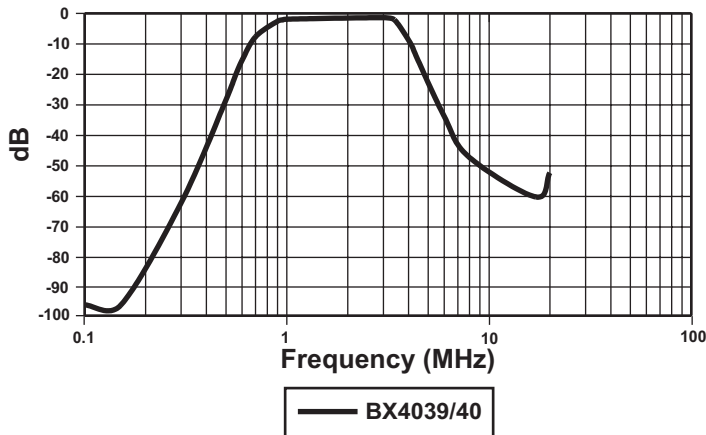

TX Insertion Loss

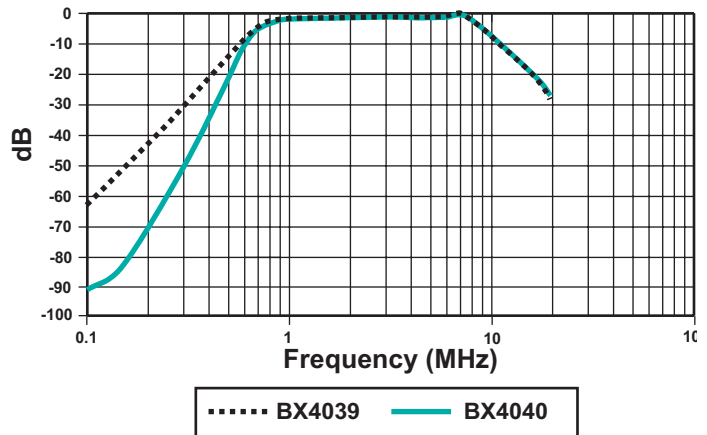

Transhybrid Loss

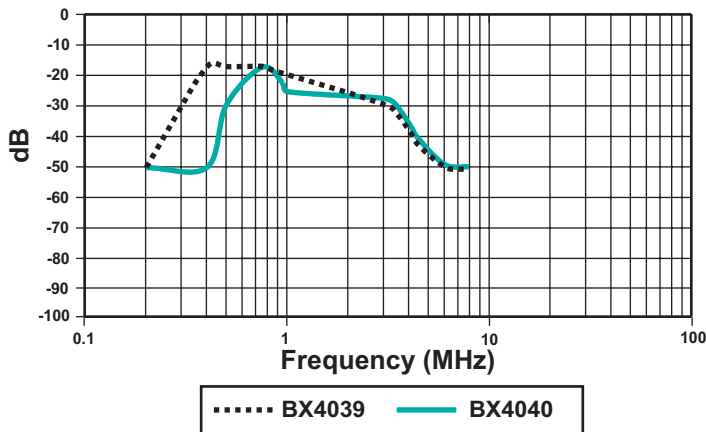

Return Loss

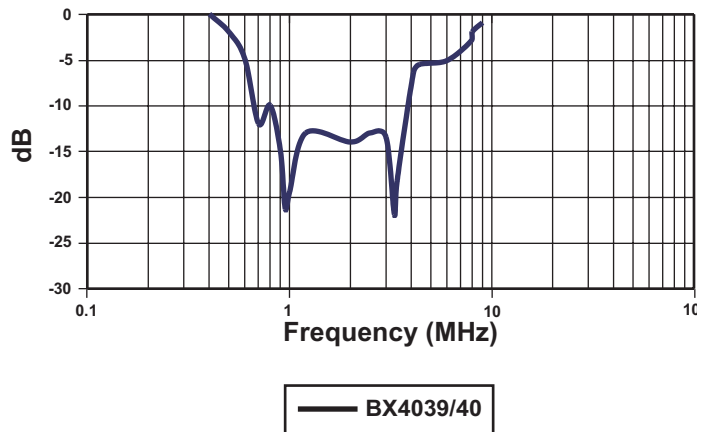

For More Information :

UNITED STATES (Worldwide)	UNITED KINGDOM (Northern Europe)	FRANCE (Southern Europe)	SINGAPORE (Southern Asia)	TAIWAN, R.O.C. (Northern Asia)	HONG KONG (China/Hong Kong)	DISTRIBUTOR
12220 World Trade Drive San Diego, CA 92128 U.S.A. http://www.pulseeng.com TEL: 858 674 8100 FAX: 858 674 8262	1 & 2 Huxley Road The Surrey Research Park Guildford, Surrey GU2 5RE United Kingdom TEL: 44 1483 401700 FAX: 44 1483 401701	Zone Industrielle F-39270 Orgelet France TEL: 33 3 84 35 04 04 FAX: 33 3 84 25 46 41	150 Kampong Ampat #07-01/02 KA Centre Singapore 368324 TEL: 65 6287 8998 FAX: 65 6280 0080	3F-4, No. 81, Sec. 1 HsinTai Wu Road Hsi-Chih, Taipei Hsien Taiwan, R.O.C. Tel: 886 2 2698 0228 FAX: 886 2 2698 0948	19/F, China United Plaza 1008 Tai Nan West Street Cheung Sha Wan, Kowloon Hong Kong, China TEL: 852 2788 6588 FAX: 852 2776 1055	

Performance warranty of products offered on this data sheet is limited to the parameters specified. Data is subject to change without notice. Other brand and product names mentioned herein may be trademarks or registered trademarks of their respective owners.

♻️ Printed on recycled paper. ©2002, Pulse Engineering, Inc.

B819.A (12/02)