

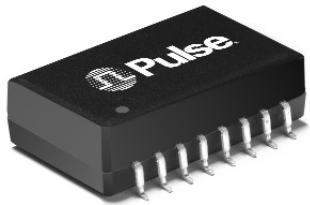





HOME PHONE NETWORKING BANDPASS AND 10BASE-T FILTER MODULE



-  For use with AMD's 79C978 Phonerline/Ethernet LAN Controller
-  Supports HomePNA™ 1M8 Specifications
-  Includes protection circuitry, isolation and EMI filtering
-  Contains 10BASE-T transmit/receive isolation and EMI filtering
-  HPN Channel is designed to meet UL 1950 requirements for supplementary insulation at a 250 V working voltage

Electrical Specifications @ 25°C — Operating Temperature 0°C to 70°C

PARAMETER	TEST CONDITION	MIN.	NOM.	MAX.	UNITS
HPN 1M8 Insertion Loss 6.0 MHz to 9.0 MHz	Input (7-8), Output (9-10) HP-8751A S21 100 Ω	1.2	1.7	2.2	dB
HPN 1M8 Attenuation 1.0 MHz 27 MHz	Input (7-8), Output (9-10) HP-8751A S21 100 Ω	60 54			dB dB
HPN 1M8 Return Loss (6.0 MHz to 9.0 MHz)	Input (14-13), 100 Ω (1-2) HP-8751A S11 100 Ω	12	14		dB
10BASE-T Turns Ratio	Transmit (4-5):(13-12) Receive (1-2):(16-15)	1.38 0.98	1.41 1.0	1.44 1.02	
10BASE-T Inductance	Transmit (4-5) 10 KHz, 0.02 Vrms Receive (1-2) 10 KHz, 0.02 Vrms	140 140	180 180		μH μH
10BASE-T Leakage Inductance	(1-2) with (16-15) shorted (4-5) with (13-12) shorted		0.7 0.3	1.2 0.7	μH μH
10BASE-T Interwinding Capacitance	(1-2) short to (16-15) shorted (4-5) short to (13-12) shorted		10 10	12 12	pF pF
10BASE-T DC Resistance	(1-2) = (4-5) (3-5) (16-15) = (13-12)		0.20 0.15 0.60	0.30 0.20 0.80	Ω Ω Ω
10BASE-T Return Loss	(13-12) to (4-5) 50 Ω (16-15) to (1-2) 100 Ω	18 18	23 23		dB dB
Isolation	Pins (1-8) shorted to (9-16) shorted	2000			Vrms

NOTE: Filters are shipped in tubes unless tape and reel is specified. Please add the suffix "T" (i.e. B6006LT) for tape and reel orders.

Mechanical

Schematic

B6006L

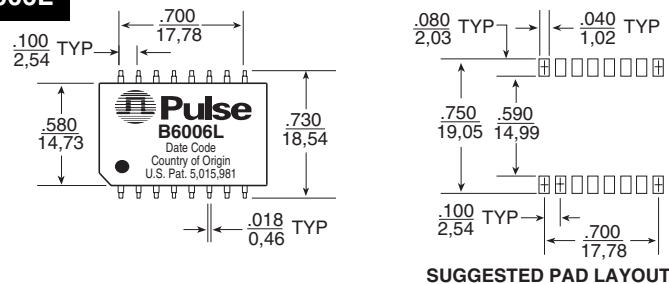

SUGGESTED PAD LAYOUT

Weight6.0 grams
Tape & Reel200/reel
Tube20/tube

Dimensions: Inches
mm
Unless otherwise specified, all tolerances are ± .010
0,25

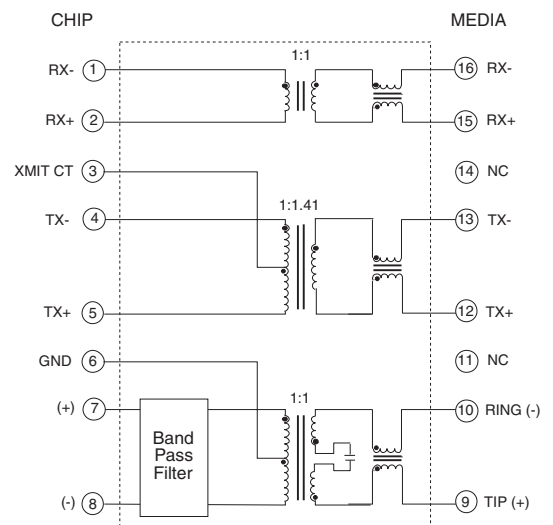

For More Information :

UNITED STATES (Worldwide)

12220 World Trade Drive
San Diego, CA 92128
U.S.A.
http://www.pulseeng.com
TEL: 858 674 8100
FAX: 858 674 8262

UNITED KINGDOM (Northern Europe)

1 & 2 Huxley Road
The Surrey Research Park
Guildford, Surrey GU2 5RE
United Kingdom
TEL: 44 1483 401700
FAX: 44 1483 401701

FRANCE (Southern Europe)

Zone Industrielle
F-39270
Orgelet
France
TEL: 33 3 84 35 04 04
FAX: 33 3 84 25 46 41

SINGAPORE (Southern Asia)

150 Kampong Ampat
#07-01/02
KA Centre
Singapore 368324
TEL: 65 6287 8998
FAX: 65 6280 0080

TAIWAN, R.O.C. (Northern Asia)

3F-4, No. 81, Sec. 1
HsinTai Wu Road
Hsi-Chih, Taipei Hsien
Taiwan, R.O.C.
Tel: 886 2 2698 0228
FAX: 886 2 2698 0948

HONG KONG (China/Hong Kong)

9/F, Phase 2, Tai Sang
Shatin Warehouse Centre
6 Wong Chuk Yeung Street
Fotan, Shatin, Hong Kong
TEL: 852 2788 6588
FAX: 852 2776 1055

DISTRIBUTOR

Performance warranty of products offered on this data sheet is limited to the parameters specified. Data is subject to change without notice. Other brand and product names mentioned herein may be products and/or registered trademarks of their respective owners.

 Printed on recycled paper. ©2003, Pulse Engineering, Inc.

B961.A (10/03)