

CERAFIL® (Filters/Traps/Discriminators) for Audio/Visual Equipment



muRata *Innovator
in Electronics*
Murata
Manufacturing Co., Ltd.

Cat.No.P50E-4

for EU RoHS Compliant

- All the products in this catalog comply with EU RoHS.
- EU RoHS is "the European Directive 2002/95/EC on the Restriction of the Use of Certain Hazardous Substances in Electrical and Electronic Equipment".
- For more details, please refer to our website 'Murata's Approach for EU RoHS' (<http://www.murata.com/info/rohs.html>).

CONTENTS

CERAFIL® and "CERAFIL" in this catalog are the trademarks of Murata Manufacturing Co., Ltd.

Part Numbering	2
1 CERAFIL® 10.7MHz Small Chip Type SFECF Series	5
2 CERAFIL® 10.7MHz Chip Type SFECV/SFECK Series	11
3 CERAFIL® 10.7MHz Standard Lead Type	14
4 CERAFIL® 10.7MHz Low Loss Type	17
5 CERAFIL® 10.7MHz Low Profile Type	20
6 CERAFIL® 10.7MHz Low Spurious Response Type	23
7 CERAFIL® 10.7MHz Wide Bandwidth Type	26
8 CERAFIL® 10.7MHz Narrow Bandwidth Type	28
9 CERAFIL® 10.7MHz for FM-IF Tuners	31
CERAFIL® 10.7MHz Related Data on Lead Type	34
10 CERAFIL® 4.5-6.5MHz Chip Type SFSKA Series	35
11 CERAFIL® 2.3-5.7MHz Chip Type SFSKB Series	38
12 CERAFIL® 455kHz Chip Type SFPKA Series	43
13 CERAFIL® 455kHz SFULA/SFZLA Series	45
14 CERAFIL® 455kHz SFPLA/CFWLA Series	48
15 CERAFIL® 455kHz for AM Stereo Wide Bandwidth Type SFPLA/CFWLA/CFULA Series	50
CERAFIL® 455kHz SF□ Series Temperature Characteristics	52
CERAFIL® 455kHz SF□ Series Application Circuit	53
16 Ceramic Trap 4.5-6.5MHz Chip Type TPSKA Series	54
17 Ceramic Trap 4.5-6.5MHz Chip Type Double Traps TPWKA Series	56
18 Ceramic Discriminator 10.7MHz Ultra Thin Chip Type CDSCB Series	57
19 Ceramic Discriminator 10.7MHz Standard Lead Type CDALF Series	62
Ceramic Discriminator 10.7MHz Applied IC Reference Table	66
Notice (Soldering and Mounting)	68
Notice (Handling)	72
Packaging	79
Part Number Index	87

1

2

3

4

5

6

7

8

9

10

11

12

13

14

15

16

17

18

19

● Part Numbering

CERAFIL® for FM

(Part Number)

SF	E	LF	10M7	F	A	A0	-B0
①	②	③	④	⑤	⑥	⑦	⑧

① Product ID

Product ID	
SF	Ceramic Filters

② Oscillation/Numbers of Element

Code	Oscillation/Numbers of Element
E	2 Elements Thickness Expander mode
T	3 Elements Thickness Expander mode
V	2 Elements Thickness Expander mode (2nd Harmonic)
K	2 Elements Thickness Expander mode (3rd Over Tone)

③ Structure/Size

Code	Structure/Size
L□	Lead Type
C□	Chip Type

□ is expressed "A" or subsequent code, which indicates the structure/size.

④ Nominal Center Frequency

Expressed by four-digit alphanumerics. The unit is in hertz (Hz). Decimal point is expressed by capital letter "M" in case of MHz.

⑤ 3dB Bandwidth

Code	3dB Bandwidth
C	450kHz min
D	350kHz min
E	330kHz
F	280kHz
G	230kHz
H	180kHz
J	150kHz
K	110kHz
L	80kHz
M	50kHz
N	35kHz

⑥ Center Frequency/Tolerance

Code	Center Frequency	Tolerance
A	Center Frequency mentioned by specification	±30kHz
B	-30kHz shifted from center frequency of code "A"	±30kHz
C	+30kHz shifted from center frequency of code "A"	±30kHz
D	-60kHz shifted from center frequency of code "A"	±30kHz
E	+60kHz shifted from center frequency of code "A"	±30kHz
H	Center Frequency mentioned by specification	±25kHz
V	-50kHz shifted from center frequency of code "H"	±25kHz
W	+50kHz shifted from center frequency of code "H"	±25kHz
K	Center Frequency mentioned by specification	±20kHz
Z	Combination of A, B, C, D, E	—
M	Combination of A, B, C	—
F	Nominal Center Frequency	—

3dB band width of "F" signifies the frequency difference (both + and -) from reference frequency which is nominal center frequency.

⑦ Series

Code	Series
A0	Two-digit alphanumerics express series

⑧ Packaging

Code	Packaging
-B0	Bulk
-R0	Embossed Taping ø180mm
-R1	Embossed Taping ø330mm
-A0	1500pcs. /Radial Taping H ₀ =18mm
-A1	1000pcs. /Radial Taping H ₀ =18mm

Radial taping is applied to lead type and embossed taping to chip type. With non-standard products, two-digit alphanumerics indicating "Individual Specification" is added between "⑦ Series" and "⑧ Packaging".

CERAFIL®

(Part Number)

SF	S	KA	4M50	CF	00	-R1
①	②	③	④	⑤	⑥	⑦

① Product ID

Product ID	
SF	Ceramic Filters

② Oscillation/Numbers of Element

Code	Oscillation/Numbers of Element
S	2 Elements Thickness Shear mode
T	3 Elements Thickness Expander mode

③ Structure/Size

Code	Structure/Size
R□	Lead Type
K□	Chip Type

□ is expressed "A" or subsequent code, which indicates the structure/size. **SFT** series has leaded type only.

④ Nominal Center Frequency

Expressed by four-digit alphanumerics. The unit is in hertz (Hz).
 Decimal point is expressed by capital letter "M" in case of MHz.

⑤ Product Specification Code (1)

Code	Product Specification Code (1)
AF	Standard Bandwidth Type
BF	Tight Bandwidth Type
CF	Standard Bandwidth Type
DF	Broad Bandwidth Type
EF	Ultra-broad Bandwidth Type

The code **AF** is not applied to **SFS** series but to **SFT** series only.

⑥ Product Specification Code (2)

Code	Product Specification Code (2)
00	Standard Type

⑦ Packaging

Code	Packaging
-B0	Bulk
-A0	Radial Taping H ₀ =18mm
-R1	Embossed Taping ø=330mm

Radial taping is applied to lead type and embossed taping to chip type. With non-standard products, two-digit alphanumerics indicating "Individual Specification" is added between "⑥ Product Specification Code (2)" and "⑦ Packaging".

CERAFIL® for AM

(Part Number)

SF	P	KA	455K	D4A	-B0
①	②	③	④	⑤	⑥

① Product ID

Product ID	
SF	Ceramic Filters
CF	Ceramic Filters

② Oscillation/Numbers of Element

Code	Oscillation/Numbers of Element
U	1 Element Area Expansion mode
Z	2 Elements Area Expansion mode
P	4 Elements Area Expansion mode

③ Structure/Size

Code	Structure/Size
L□	Lead Type
C□/K□	Chip Type

□ is "A" or subsequent code, which indicates the structure/size. It varies depending on vibration mode and number of elements.

④ Nominal Center Frequency

Expressed by four-digit alphanumerics. The unit is in hertz (Hz).
 Capital letter "K" following three figures expresses the unit of "kHz".

⑤ Product Specification

Code	Product Specification
D4A	Three-digit alphanumerics indicate product specification of 3dB or 6dB frequency tolerance.

□□A indicates standard type.

⑥ Packaging

Code	Packaging
-B0	Bulk
-R0	Embossed Taping (ø180mm)
-R1	Embossed Taping (ø330mm)
-M0	Magazine Cassette

Radial taping is applied to lead type and embossed taping to chip type. With non-standard products, three-digit alphanumerics indicating "Individual Specification" is added between "⑤ Product Specification" and "⑥ Packaging".

Ceramic Traps

(Part Number)

TP	S	KA	4M00	B	00	-R0
①	②	③	④	⑤	⑥	⑦

① Product ID

Product ID	
TP	Ceramic Traps

② Function

Code	Function
S	Single Traps
W	Double Traps

③ Structure/Size

Code	Structure/Size
R□	Lead Type
K□	Chip Type

□ is expressed "A" or subsequent code, which indicates the structure/size.

④ Nominal Center Frequency

Expressed by four-digit alphanumerics. The unit is in hertz (Hz). Decimal point is expressed by capital letter "M".

Discriminators for FM

(Part Number)

CD	A	LF	10M7	G	A	001	-B0
①	②	③	④	⑤	⑥	⑦	⑧

① Product ID

Product ID	
CD	Discriminators

② Oscillation

Code	Oscillation
A	Thickness Expander mode
S	Thickness Shear mode

③ Structure/Size

Code	Structure/Size
L□	Lead Type
C□	Chip Type

□ is expressed "A" or subsequent code, which indicates the structure/size.

④ Nominal Center Frequency

Expressed by four-digit alphanumerics. The unit is in hertz (Hz). Decimal point is expressed by capital letter "M" in case of MHz.

⑤ Series

Code	Series
G	Two-digit alphanumerics express series

⑤ Product Specification Code (1)

Code	Product Specification (1)
B	Broad-bandwidth Type
C	Low-capacitance Type

⑥ Product Specification Code (2)

Code	Product Specification (2)
00	Standard Type

⑦ Packaging

Code	Packaging
-B0	Bulk
-A0	Radial Taping H ₀ =18mm
-R1	Embossed Taping ø=330mm

Radial taping is applied to lead type and embossed taping to chip type. With non-standard products, three-digit alphanumerics indicating "Individual Specification" is added between "⑥ Product Specification Code (2)" and "⑦ Packaging".

⑥ Center Frequency/Tolerance

Code	Center Frequency	Tolerance
A	Center Frequency mentioned by specification	±30kHz
B	-30kHz shifted from center frequency of code "A"	±30kHz
C	+30kHz shifted from center frequency of code "A"	±30kHz
D	-60kHz shifted from center frequency of code "A"	±30kHz
E	+60kHz shifted from center frequency of code "A"	±30kHz
H	Center Frequency mentioned by specification	±25kHz
V	-50kHz shifted from center frequency of code "H"	±25kHz
W	+50kHz shifted from center frequency of code "H"	±25kHz
K	Center Frequency mentioned by specification	±20kHz
Z	Combination of A, B, C, D, E	—
M	Combination of A, B, C	—
F	Nominal Center Frequency	—

3dB band width of "F" signifies the frequency difference (both + and -) from reference frequency which is nominal center frequency.

⑦ IC

Code	IC
001	Applicable IC Control Code

⑧ Packaging

Code	Packaging
-B0	Bulk
-A0	Radial Taping H ₀ =18mm
-R0	Embossed Taping ø=180mm
-R1	Embossed Taping ø=330mm

Radial taping is applied to lead type and embossed taping to chip type. With non-standard products, an alphanumerics indicating "Individual Specification" is added between "⑦ IC" and "⑧ Packaging".

CERAFIL® (Filters/Traps/Discriminators) for Audio/Visual Equipment



1

CERAFIL® 10.7MHz Small Chip Type SFECF Series

SFECF10M7 series for FM-receivers are small, high performance and super thin (1.4mm max.) filters. Piezoelectric element is connected in the sandwich shape by ceramics substrate. They have 1.4mm max. thickness and small mounting area. (3.45x3.1mm)
 SFECF series and CDSCB series (MHz Discriminator) enable customers to make VICS/RKE/TPMS set so thin and small sized.

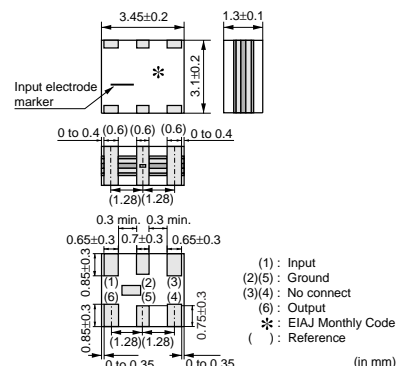

■ Features

- The filters are mountable by automatic placers.
- They are slim, at only 1.4mm max. thickness, and have a small mounting area (3.45x3.1mm) enabling flexible PCB design.
- Various bandwidths are available. Select a suitable type in accordance with the desired selectivity.
- Operating Temperature Range:
 - 20 to +80 (degrees C)(Standard Type)
 - 40 to +85 (degrees C)(High-reliability Type)
 Storage Temperature Range:
 - 40 to +85 (degrees C)(Standard Type)
 - 55 to +85 (degrees C)(High-reliability Type)

Standard Type

Part Number	Center Frequency (fo) (MHz)	Nominal Center Frequency (fn) (MHz)	3dB Bandwidth (kHz)	Attenuation (kHz)	Insertion Loss (dB)	Ripple (dB)	Spurious Attenuation (1) (dB)	Spurious Attenuation (2) (dB)	Input/Output Impedance (ohm)
SFECF10M7HA00-R0	10.700 ±30kHz	-	180 ±40kHz	470 max.	4.0 ±2.0dB	1.0 max.	30 min. [within 9MHz to fo]	30 min. [within fo to 12MHz]	330
SFECF10M7HF00-R0	-	10.700	fn±25 min.	510 max.	8.0 max. [at fn]	1.0 max.	30 min. [within 9MHz to fn]	25 min. [within fn to 12MHz]	330
SFECF10M7GA00-R0	10.700 ±30kHz	-	230 ±50kHz	510 max.	3.5 ±2.0dB	1.0 max.	30 min. [within 9MHz to fo]	30 min. [within fo to 12MHz]	330
SFECF10M7GF00-R0	-	10.700	fn±45 min.	560 max.	8.0 max. [at fn]	1.0 max.	30 min. [within 9MHz to fn]	25 min. [within fn to 12MHz]	330
SFECF10M7FA00-R0	10.700 ±30kHz	-	280 ±50kHz	590 max.	3.0 ±2.0dB	1.0 max.	30 min. [within 9MHz to fo]	30 min. [within fo to 12MHz]	330
SFECF10M7FF00-R0	-	10.700	fn±65 min.	620 max.	7.0 max. [at fn]	1.0 max.	30 min. [within 9MHz to fn]	25 min. [within fn to 12MHz]	330
SFECF10M7EA00-R0	10.700 ±30kHz	-	330 ±50kHz	700 max.	3.0 ±2.0dB	1.0 max.	30 min. [within 9MHz to fo]	30 min. [within fo to 12MHz]	330
SFECF10M7DA0001-R0	10.700 ±30kHz	-	420 min.	950 max.	3.0 ±2.0dB	3.0 max.	35 min. [within 9MHz to fo]	25 min. [within fo to 12MHz]	330
SFECF10M7DF00-R0	-	10.700	fn±150 min.	990 max.	6.0 max. [at fn]	3.0 max.	20 min. [within 9MHz to fn]	20 min. [within fn to 12MHz]	330

Area of Attenuation: [within 20dB]

Area of Insertion Loss: at minimum loss point Area of Ripple: within 3dB B.W.

Center frequency (fo) defined by the center of 3dB bandwidth.

For safety purposes, connect the output of filters to the IF amplifier through a D.C. blocking capacitor. Avoid applying a direct current to the output of ceramic filters.

The order quantity should be an integral multiple of the "Minimum Quantity" shown in the package page.

High-reliability Type

Part Number	Center Frequency (fo) (MHz)	Nominal Center Frequency (fn) (MHz)	3dB Bandwidth (kHz)	Attenuation (kHz)	Insertion Loss (dB)	Ripple (dB)	Spurious Attenuation (1) (dB)	Spurious Attenuation (2) (dB)	Input/Output Impedance (ohm)
SFECF10M7HA00S0-R0	10.700 ±30kHz	-	180 ±40kHz	470 max.	4.0 ±2.0dB	1.0 max.	30 min. [within 9MHz to fo]	30 min. [within fo to 12MHz]	330
SFECF10M7HF00S0-R0	-	10.700	fn±25 min.	510 max.	8.0 max. [at fn]	1.0 max.	30 min. [within 9MHz to fn]	25 min. [within fn to 12MHz]	330
SFECF10M7GA00S0-R0	10.700 ±30kHz	-	230 ±50kHz	510 max.	3.5 ±2.0dB	1.0 max.	30 min. [within 9MHz to fo]	30 min. [within fo to 12MHz]	330
SFECF10M7GF00S0-R0	-	10.700	fn±45 min.	560 max.	8.0 max. [at fn]	1.0 max.	30 min. [within 9MHz to fn]	25 min. [within fn to 12MHz]	330
SFECF10M7FA00S0-R0	10.700 ±30kHz	-	280 ±50kHz	590 max.	3.0 ±2.0dB	1.0 max.	30 min. [within 9MHz to fo]	30 min. [within fo to 12MHz]	330
SFECF10M7FF00S0-R0	-	10.700	fn±65 min.	630 max.	7.0 max. [at fn]	1.0 max.	30 min. [within 9MHz to fn]	25 min. [within fn to 12MHz]	330
SFECF10M7EA00S0-R0	10.700 ±30kHz	-	330 ±50kHz	700 max.	3.0 ±2.0dB	1.0 max.	30 min. [within 9MHz to fo]	30 min. [within fo to 12MHz]	330
SFECF10M7DF00S0-R0	-	10.700	fn±145 min.	990 max.	6.0 max. [at fn]	3.0 max.	20 min. [within 9MHz to fn]	20 min. [within fn to 12MHz]	330

Area of Attenuation: [within 20dB]

Area of Insertion Loss: at minimum loss point Area of Ripple: within 3dB B.W.

Center frequency (fo) defined by the center of 3dB bandwidth.

For safety purposes, connect the output of filters to the IF amplifier through a D.C. blocking capacitor. Avoid applying a direct current to the output of ceramic filters.

The order quantity should be an integral multiple of the "Minimum Quantity" shown in the package page.

Standard Center Frequency Rank Code

CODE	30kHz Step	25kHz Step
D	10.64MHz±30kHz	10.650MHz±25kHz
B	10.67MHz±30kHz	10.675MHz±25kHz
A	10.70MHz±30kHz	10.700MHz±25kHz
C	10.73MHz±30kHz	10.725MHz±25kHz
E	10.76MHz±30kHz	10.750MHz±25kHz
Z	Combination A, B, C, D, E	
M	Combination A, B, C	

Standard Land Pattern Dimensions

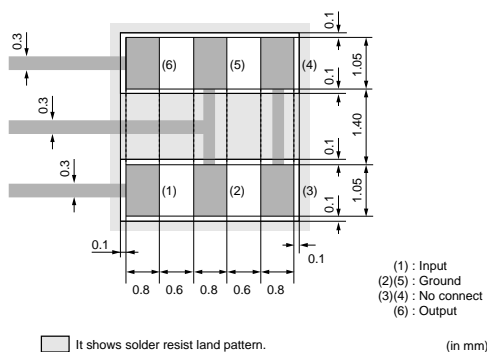

Test Circuit

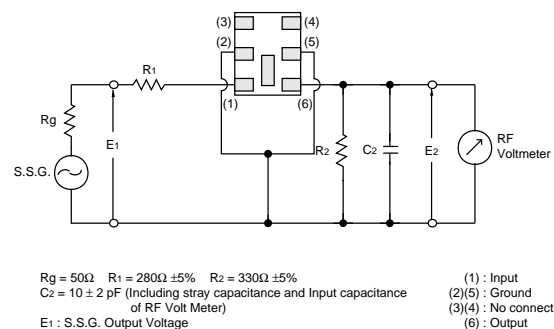

Continued on the following page. ↗

Continued from the preceding page.

Frequency Characteristics Standard Type

1

SFECF10M7HA00-R0/SFECF10M7HF00-R0

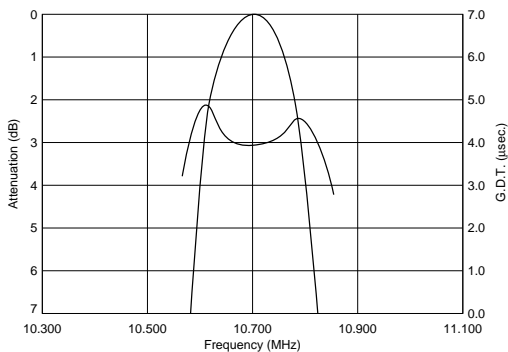

SFECF10M7GA00-R0/SFECF10M7GF00-R0

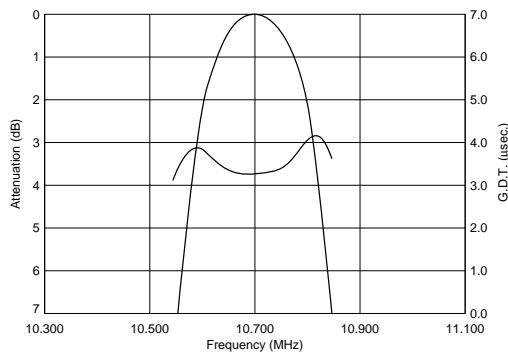

SFECF10M7FA00-R0/SFECF10M7FF00-R0

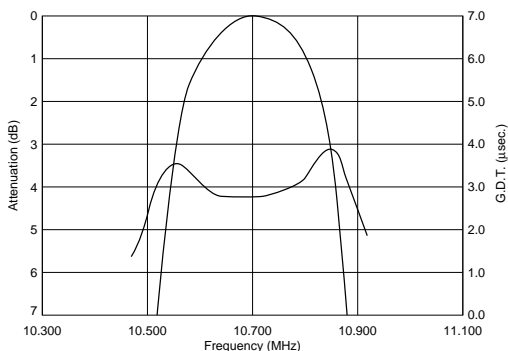

SFECF10M7EA00-R0

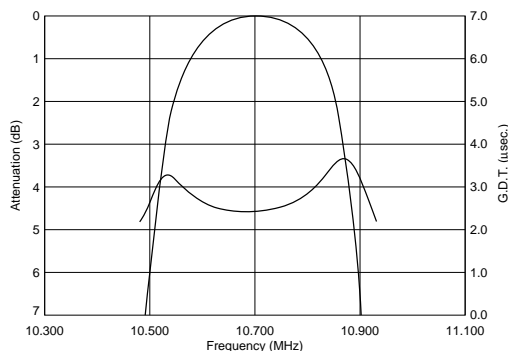

SFECF10M7DA0001-R0

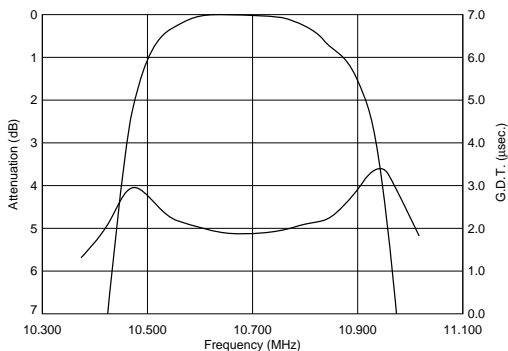

SFECF10M7DF00-R0

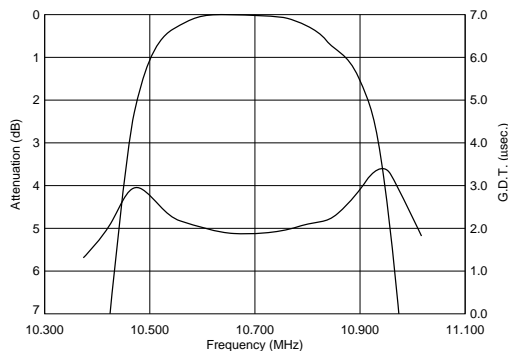

■ Frequency Characteristics High-reliability Type

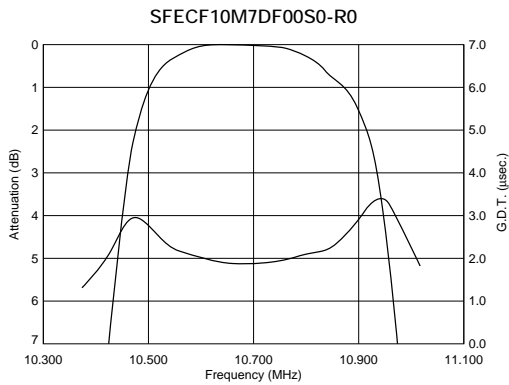
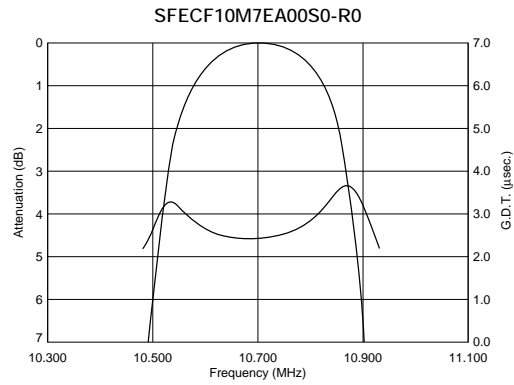
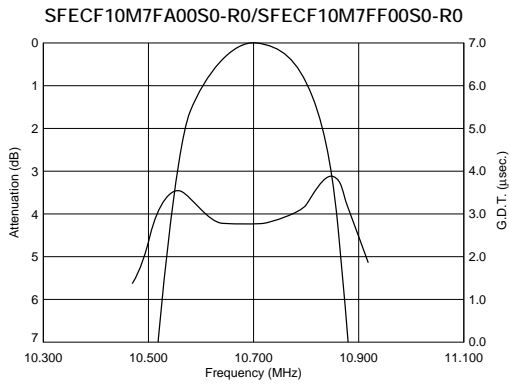
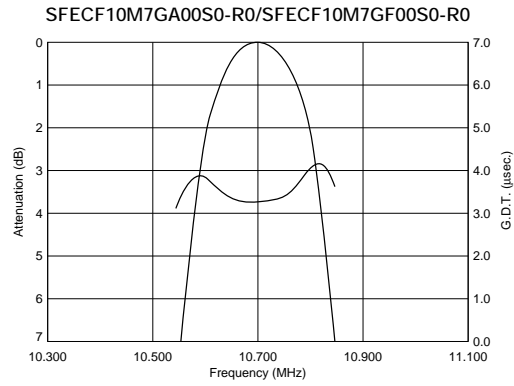
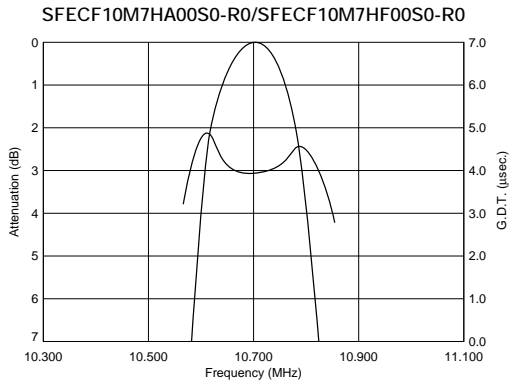

Frequency Characteristics (Spurious) Standard Type

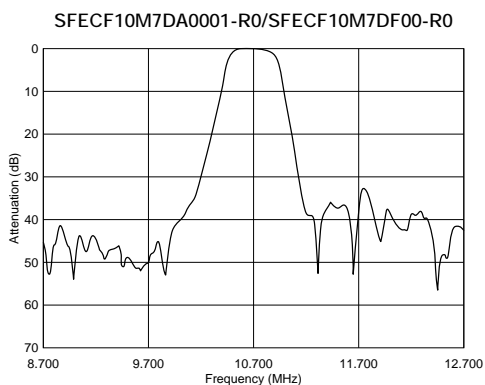
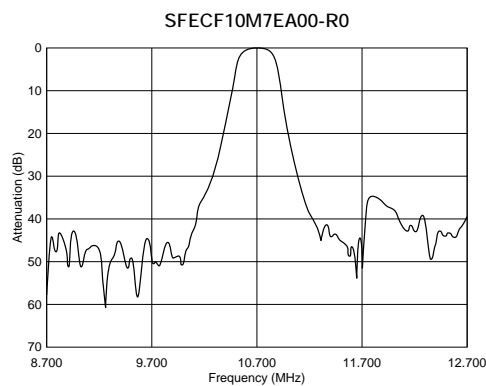
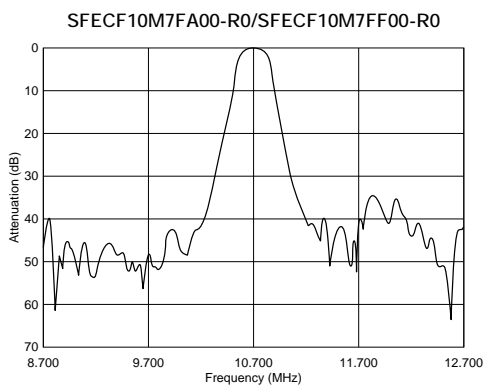
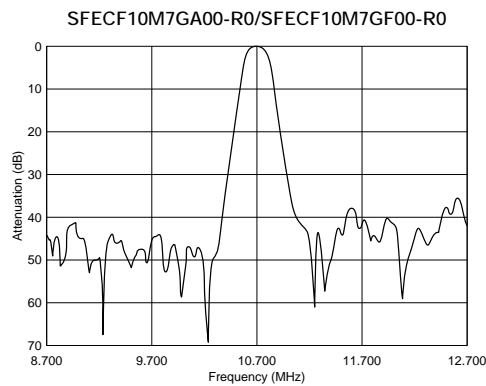
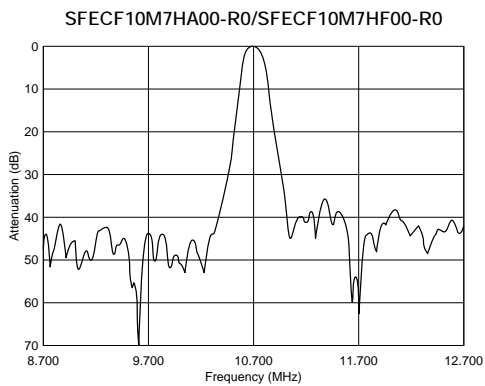

■ Frequency Characteristics (Spurious) High-reliability Type

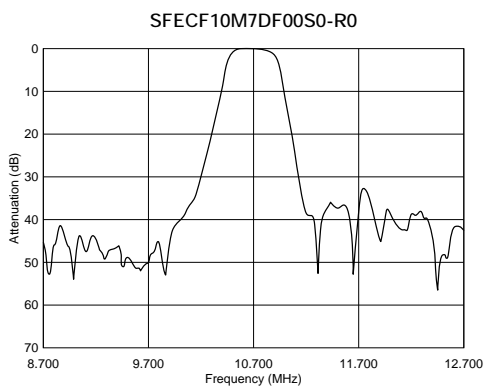
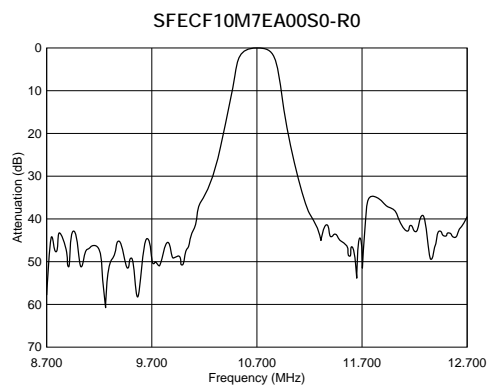
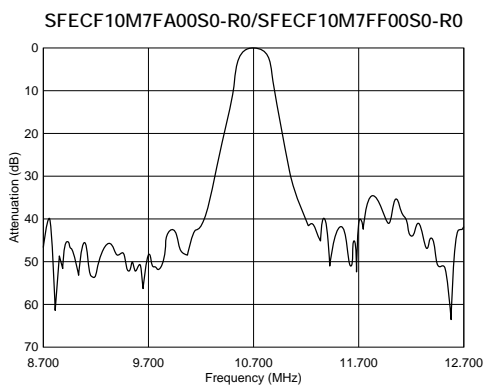
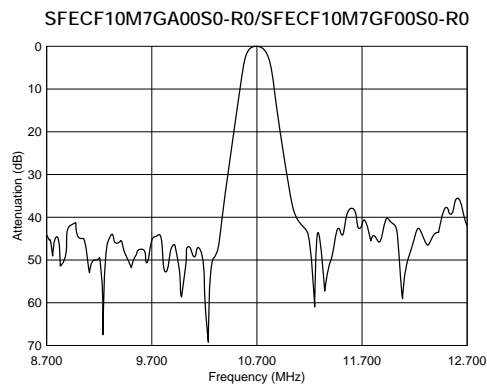
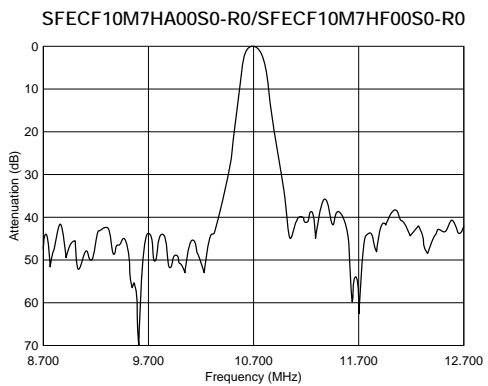

CERAFIL® (Filters/Traps/Discriminators) for Audio/Visual Equipment



CERAFIL® 10.7MHz Chip Type SFECV/SFECK Series

SFECV/SFECK10M7 series for FM-receivers are monolithic type ceramic filters which utilize the thickness expander mode of the piezoelectric ceramic. SFECV series enable customers to make AM/FM set so thin, and it can be of help to the total chip circuit.

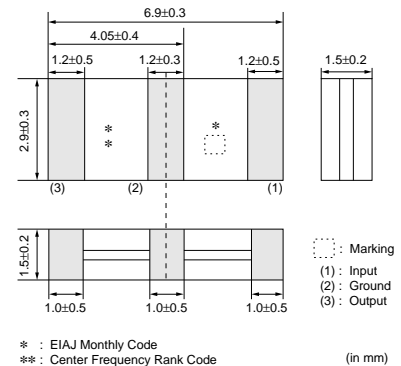
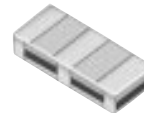

■ Features

1. Piezoelectric element is connected in the sandwich shape by heat resistant substrate, thus it has excellent mechanical strength, and it is suitable for automatic mounting.
2. Various bandwidths are available. Select a suitable type in accordance with the desired selectivity.
3. Operating Temperature Range:
 - 20 to +80 (degrees C)(Standard Type)
 - 40 to +85 (degrees C)(High-reliability Type)
 Storage Temperature Range:
 - 40 to +85 (degrees C)(Standard Type)
 - 55 to +85 (degrees C)(High-reliability Type)

■ Applications

1. Small, thin radios
2. Automotive radios
3. Headphone stereos

Standard Type

Part Number	Center Frequency (fo) (MHz)	3dB Bandwidth (kHz)	Attenuation (kHz)	Insertion Loss (dB)	Ripple (dB)	Spurious Attenuation (1) (dB)	Spurious Attenuation (2) (dB)	Input/Output Impedance (ohm)
SFECV15M0EQ0001-R0	15.000 ±50kHz	300 min.	750 max.	7.0 max.	1.0 max.	30 min. [within 14MHz to fo]	30 min. [within fo to 16MHz]	330
SFECV10M7KA00-R0	10.700 ±30kHz	110 ±30kHz	320 max.	6.0 ±2.0dB	1.0 max.	35 min. [within 9MHz to fo]	35 min. [within fo to 12MHz]	330
SFECV10M7JA00-R0	10.700 ±30kHz	150 ±40kHz	380 max.	5.5 ±2.0dB	1.0 max.	35 min. [within 9MHz to fo]	35 min. [within fo to 12MHz]	330

Area of Attenuation: [within 20dB]
 Area of Insertion Loss: at minimum loss point
 Center frequency (fo) defined by the center of 3dB bandwidth.
 For safety purposes, connect the output of filters to the IF amplifier through a D.C. blocking capacitor. Avoid applying a direct current to the output of ceramic filters.
 The order quantity should be an integral multiple of the "Minimum Quantity" shown in the package page.

High-reliability Type

Part Number	Center Frequency (fo) (MHz)	3dB Bandwidth (kHz)	Attenuation (kHz)	Insertion Loss (dB)	Ripple (dB)	Spurious Attenuation (1) (dB)	Spurious Attenuation (2) (dB)	Input/Output Impedance (ohm)
SFECK10M7KA00S0-R0	10.700 ±30kHz	110 ±30kHz	320 max.	6.0 ±2.0dB	1.0 max.	35 min. [within 9MHz to fo]	35 min. [within fo to 12MHz]	330
SFECK10M7JA00S0-R0	10.700 ±30kHz	150 ±40kHz	380 max.	5.5 ±2.0dB	1.0 max.	35 min. [within 9MHz to fo]	35 min. [within fo to 12MHz]	330

Area of Attenuation: [within 20dB]
 Area of Insertion Loss: at minimum loss point
 Center frequency (fo) defined by the center of 3dB bandwidth.
 For safety purposes, connect the output of filters to the IF amplifier through a D.C. blocking capacitor. Avoid applying a direct current to the output of ceramic filters.
 The order quantity should be an integral multiple of the "Minimum Quantity" shown in the package page.



2

Standard Center Frequency Rank Code

CODE	30kHz Step	25kHz Step
D	10.64MHz±30kHz	10.650MHz±25kHz
B	10.67MHz±30kHz	10.675MHz±25kHz
A	10.70MHz±30kHz	10.700MHz±25kHz
C	10.73MHz±30kHz	10.725MHz±25kHz
E	10.76MHz±30kHz	10.750MHz±25kHz
Z	Combination A, B, C, D, E	
M	Combination A, B, C	

Standard Land Pattern Dimensions

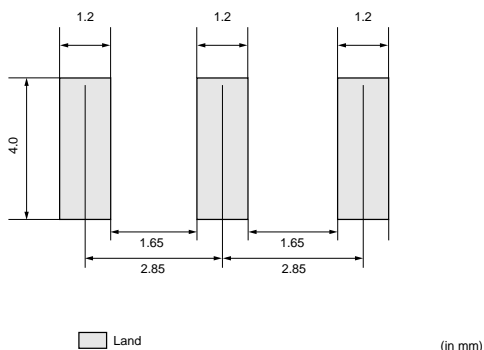

Test Circuit

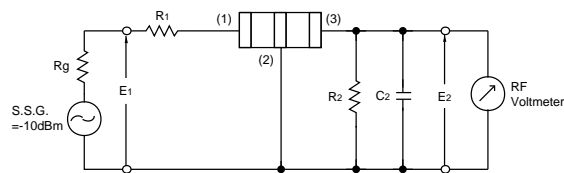

$R_g = 50\Omega$ $R_1 = 280\Omega \pm 5\%$ $R_2 = 330\Omega \pm 5\%$ (1) : Input
 $C_2 = 10 \pm 2 \text{ pF}$ (Including stray capacitance and Input capacitance of RF Volt Meter) (2) : Ground
 E_1 : S.S.G. Output Voltage (3) : Output

Frequency Characteristics Standard Type

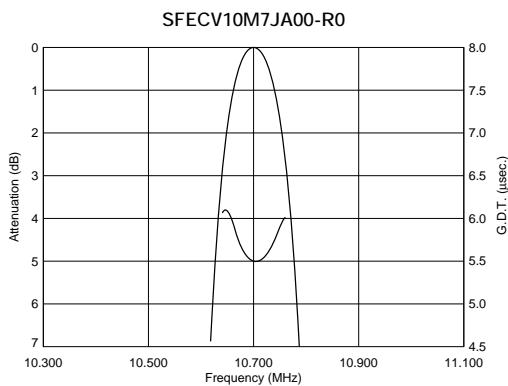
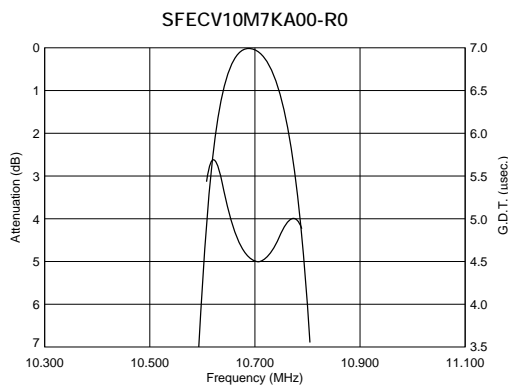
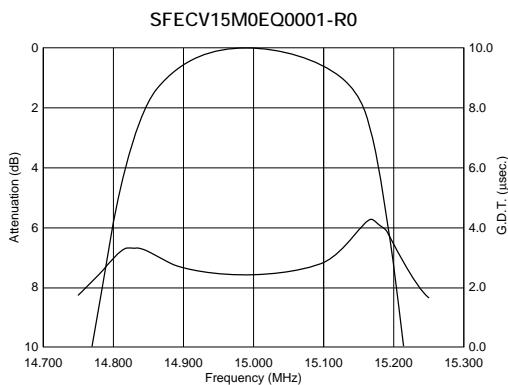

■ Frequency Characteristics High-reliability Type

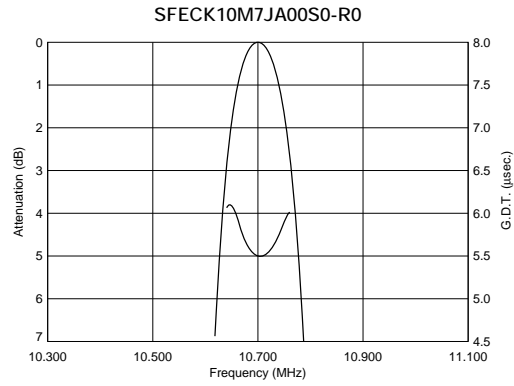
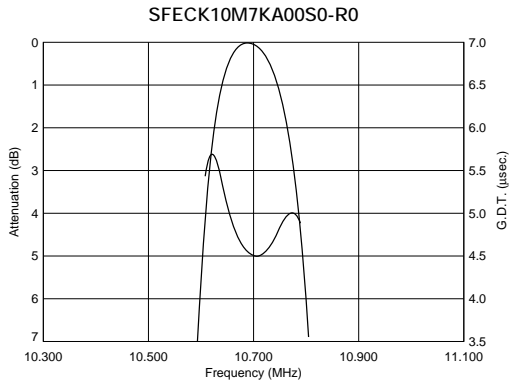

■ Frequency Characteristics (Spurious) Standard Type

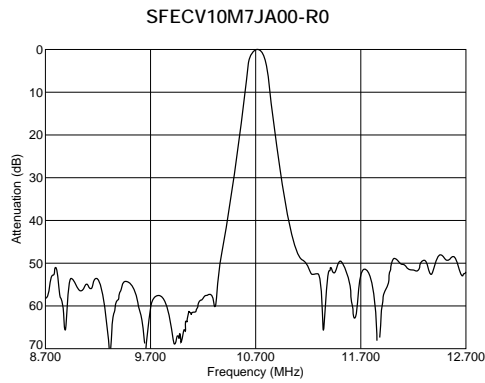
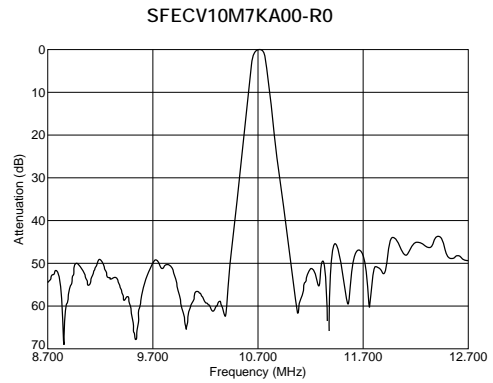
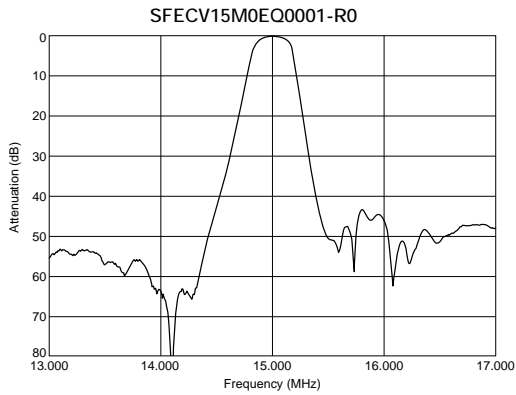

■ Frequency Characteristics (Spurious) High-reliability Type

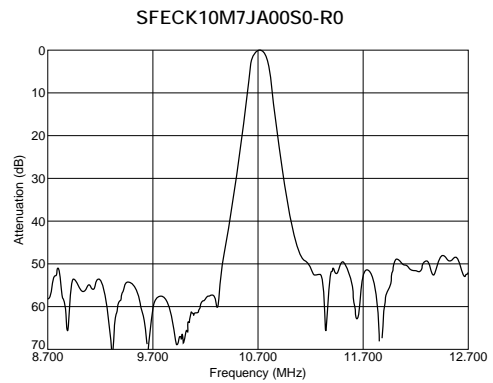
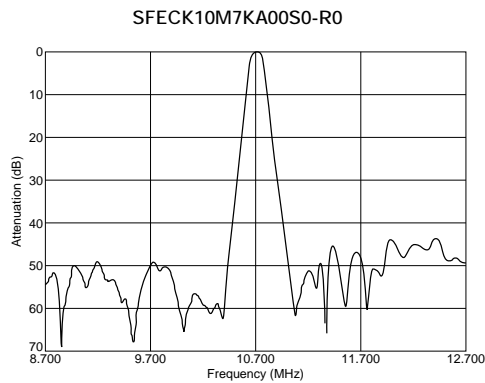

CERAFIL® (Filters/Traps/Discriminators) for Audio/Visual Equipment



CERAFIL® 10.7MHz Standard Lead Type

3

SFELF10M7 series for FM-receivers are monolithic type ceramic filters which use the thickness expander mode of the piezoelectric ceramic.

As part of the environment protection activity, solder for terminal plating and terminal-element connection inside of ceramic filter contain no lead (Pb).

■ Features

1. These miniature filters have high mechanical strength.
2. Low loss, favorable waveform symmetry, and high selectivity
3. Various band widths are available for applications in wide to narrow bands.
4. Small dispersion and stable characteristics
5. Change in center frequency is typically within $\pm 30\text{ppm}/(\text{degrees C})$ at -20 to $+80$ (degrees C).
6. High reliability



SFELF10M7HA00-B0

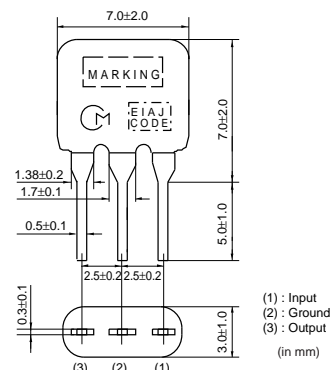

SFELF10M7GA00-B0

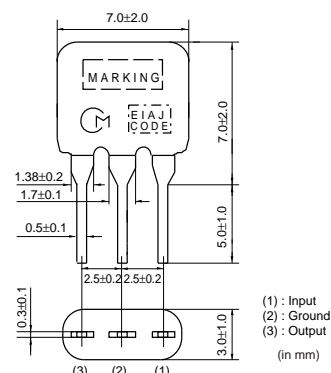

SFELF10M7FA00-B0

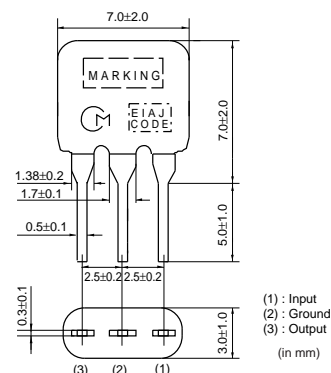

Part Number	Center Frequency (fo) (MHz)	3dB Bandwidth (kHz)	Attenuation (kHz)	Insertion Loss (dB)	Spurious Attenuation (1) (dB)	Spurious Attenuation (2) (dB)	Input/Output Impedance (ohm)
SFELF10M7HA00-B0	10.700 ±30kHz	180 ±40kHz	520 max.	7.0 max.	40 min. [within 9MHz to fo]	40 min. [within fo to 12MHz]	330
SFELF10M7GA00-B0	10.700 ±30kHz	230 ±50kHz	570 max.	4.0 ±2.0dB	40 min. [within 9MHz to fo]	40 min. [within fo to 12MHz]	330
SFELF10M7FA00-B0	10.700 ±30kHz	280 ±50kHz	650 max.	4.0 ±2.0dB	30 min. [within 9MHz to fo]	30 min. [within fo to 12MHz]	330

Area of Attenuation: [within 20dB]

Area of Insertion Loss: at minimum loss point

Center frequency (fo) defined by the center of 3dB bandwidth.

For safety purposes, connect the output of filters to the IF amplifier through a D.C. blocking capacitor. Avoid applying a direct current to the output of ceramic filters.

The order quantity should be an integral multiple of the "Minimum Quantity" shown in the package page.

Standard Center Frequency Rank Code

CODE	30kHz Step	25kHz Step	Color Code
D	10.64MHz±30kHz	10.650MHz±25kHz	Black
B	10.67MHz±30kHz	10.675MHz±25kHz	Blue
A	10.70MHz±30kHz	10.700MHz±25kHz	Red
C	10.73MHz±30kHz	10.725MHz±25kHz	Orange
E	10.76MHz±30kHz	10.750MHz±25kHz	White
Z	Combination A, B, C, D, E		
M	Combination A, B, C		

Test Circuit

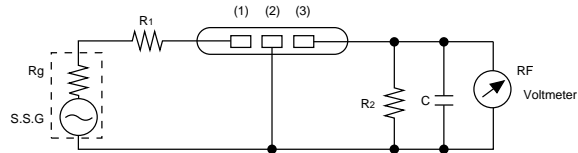

$R_g + R_1 = R_z =$ Input and Output Impedance
 $C = 10\text{pF}$ (Including stray capacitance and input capacitance of RF voltmeter.)

(1) : Input
 (2) : Ground
 (3) : Output

Frequency Characteristics

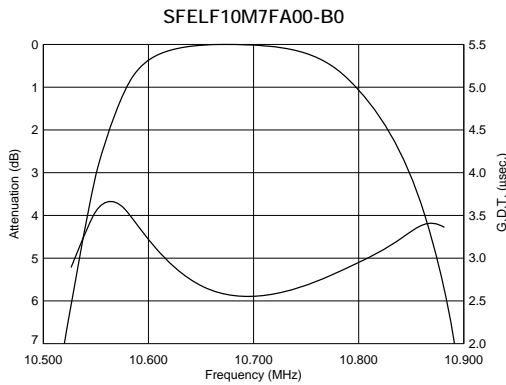
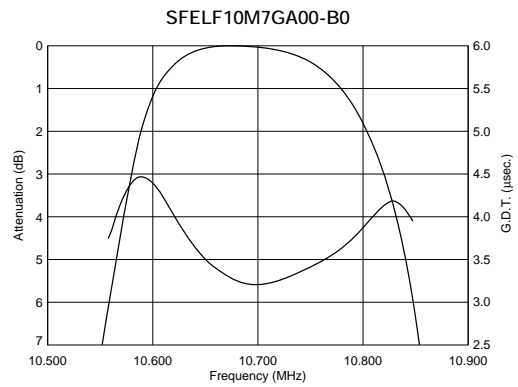
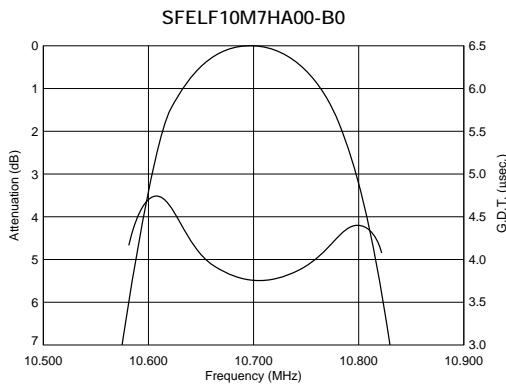

■ Frequency Characteristics (Spurious)

SFELF10M7HA00-B0

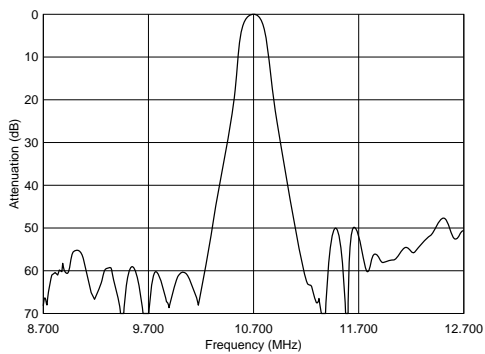

SFELF10M7GA00-B0

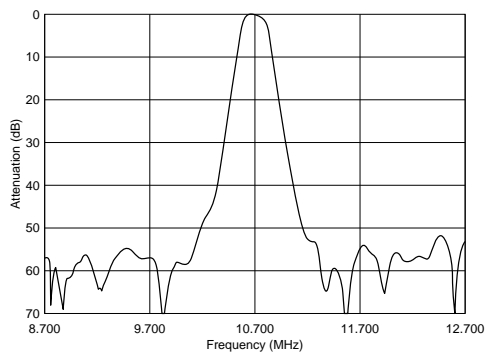

SFELF10M7FA00-B0

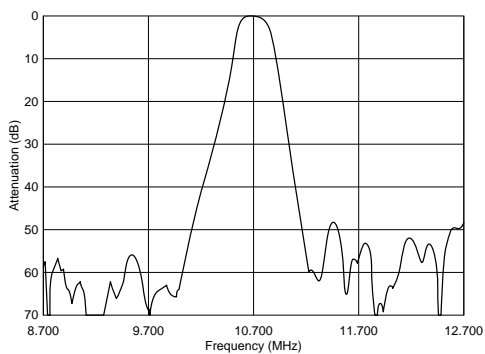

3

CERAFIL® (Filters/Traps/Discriminators) for Audio/Visual Equipment



CERAFIL® 10.7MHz Low Loss Type

SFELF10M7 series for FM-receivers are monolithic type ceramic filters which use the thickness expander mode of the piezoelectric ceramic.

As part of the environment protection activity, solder for terminal plating and terminal-element connection inside of ceramic filter contain no lead (Pb).

■ Features

1. Insertion loss is 1 to 1.5dB lower than conventional products. These types are useful for elevating the sensitivity of sets.
2. Small dispersion and stable characteristics
3. Excellent shape factor of frequency response
4. Good waveform symmetry



SFELF10M7JAA0-B0

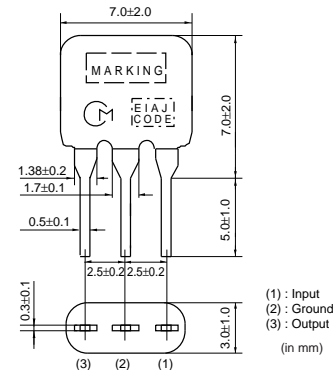

SFELF10M7HAA0-B0

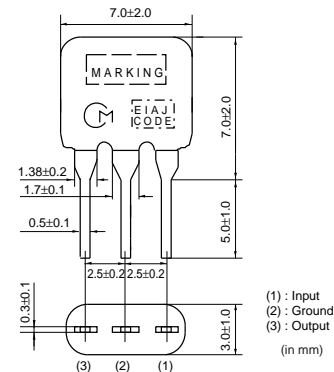

SFELF10M7GAA0-B0

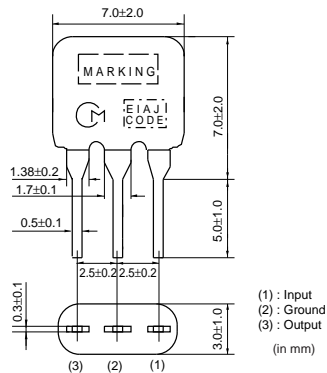

SFELF10M7FAA0-B0

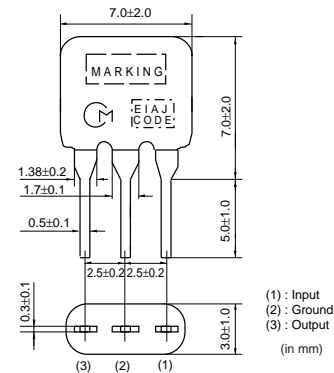

Part Number	Center Frequency (fo) (MHz)	3dB Bandwidth (kHz)	Attenuation (kHz)	Insertion Loss (dB)	Spurious Attenuation (1) (dB)	Spurious Attenuation (2) (dB)	Input/Output Impedance (ohm)
SFELF10M7JAA0-B0	10.700 ±30kHz	150 ±40kHz	360 max.	4.5 ±2.0dB	35 min. [within 9MHz to fo]	35 min. [within fo to 12MHz]	330
SFELF10M7HAA0-B0	10.700 ±30kHz	180 ±40kHz	470 max.	3.5 ±1.5dB	35 min. [within 9MHz to fo]	35 min. [within fo to 12MHz]	330
SFELF10M7GAA0-B0	10.700 ±30kHz	230 ±50kHz	520 max.	3.0 ±2.0dB	35 min. [within 9MHz to fo]	35 min. [within fo to 12MHz]	330
SFELF10M7FAA0-B0	10.700 ±30kHz	280 ±50kHz	590 max.	2.5 ±2.0dB	30 min. [within 9MHz to fo]	30 min. [within fo to 12MHz]	330

Area of Attenuation: [within 20dB]

Area of Insertion Loss: at minimum loss point

Center frequency (fo) defined by the center of 3dB bandwidth.

For safety purposes, connect the output of filters to the IF amplifier through a D.C. blocking capacitor. Avoid applying a direct current to the output of ceramic filters.

The order quantity should be an integral multiple of the "Minimum Quantity" shown in the package page.

Standard Center Frequency Rank Code

CODE	30kHz Step	25kHz Step	Color Code
D	10.64MHz±30kHz	10.650MHz±25kHz	Black
B	10.67MHz±30kHz	10.675MHz±25kHz	Blue
A	10.70MHz±30kHz	10.700MHz±25kHz	Red
C	10.73MHz±30kHz	10.725MHz±25kHz	Orange
E	10.76MHz±30kHz	10.750MHz±25kHz	White
Z	Combination A, B, C, D, E		
M	Combination A, B, C		

4

Test Circuit

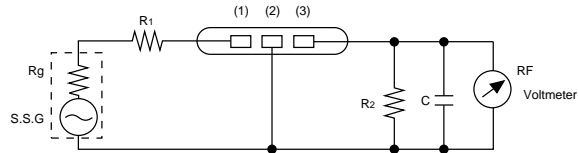

$R_g + R_1 = R_2 =$ Input and Output Impedance
 $C = 10\text{pF}$ (Including stray capacitance and input capacitance of RF voltmeter.)

(1) : Input
 (2) : Ground
 (3) : Output

Frequency Characteristics

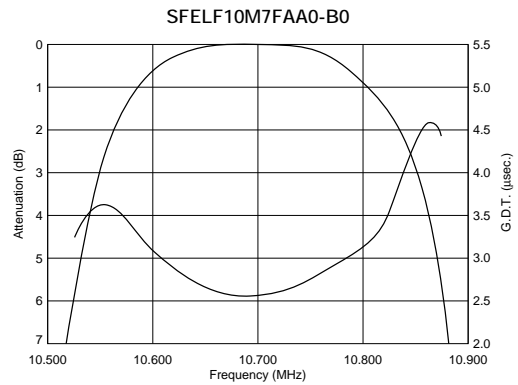
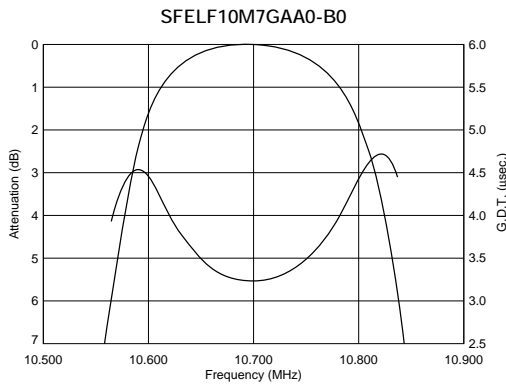
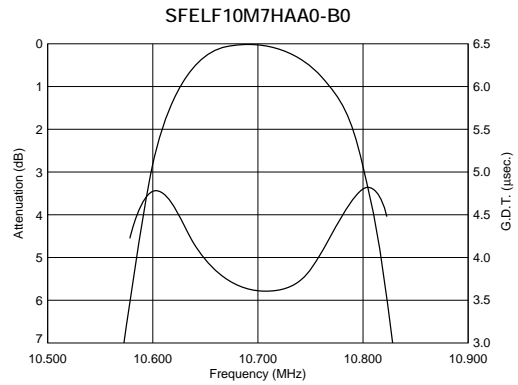
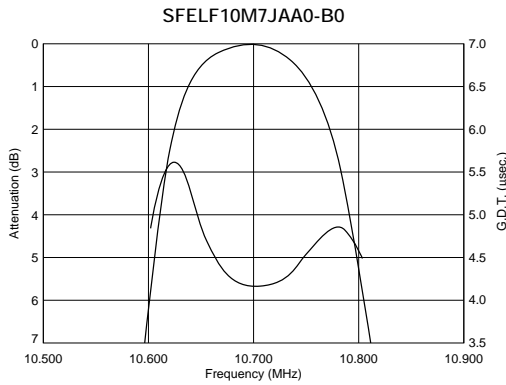

■ Frequency Characteristics (Spurious)

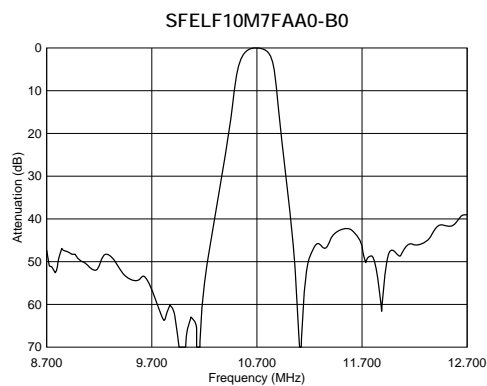
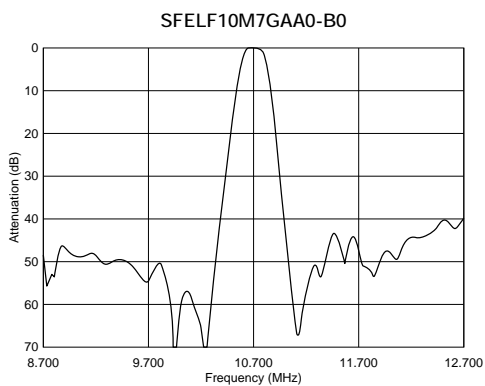
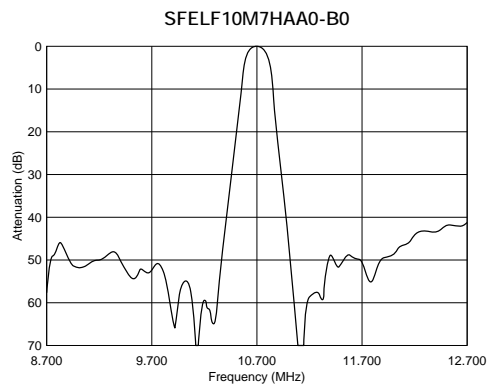
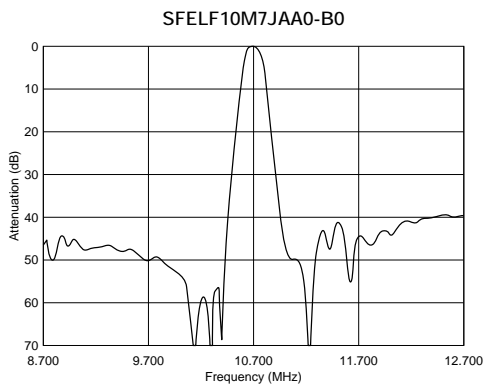

4

CERAFIL® (Filters/Traps/Discriminators) for Audio/Visual Equipment



CERAFIL® 10.7MHz Low Profile Type

SFELG10M7 series for FM-receivers are monolithic type ceramic filters which use the thickness expander mode of the piezoelectric ceramic.

As part of the environment protection activity, solder for terminal plating and terminal-element connection inside of ceramic filter contain no lead (Pb).

5

■ Features

1. Installed height is 6.0mm, making it well suited for compact, thin sets.
2. Environmental reliability is the same as those of the ceramic filter SFELF10M7 series.



SFELG10M7KA00-B0

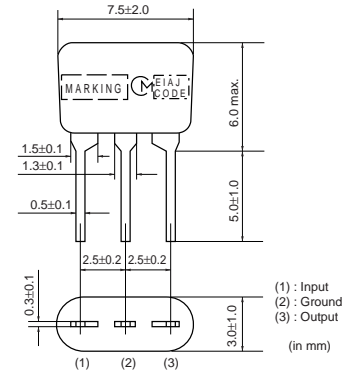

SFELG10M7JA00-B0

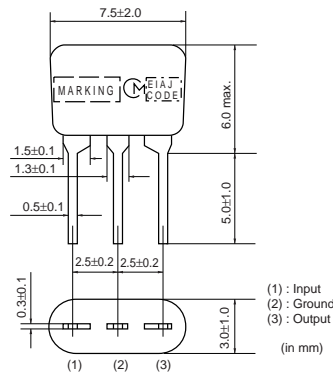

SFELG10M7HA00-B0

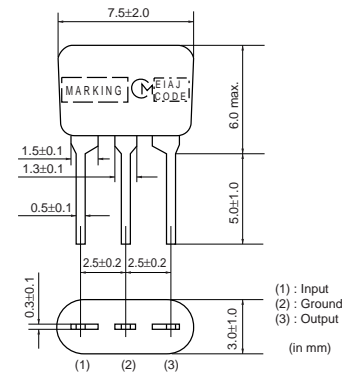

SFELG10M7GA00-B0

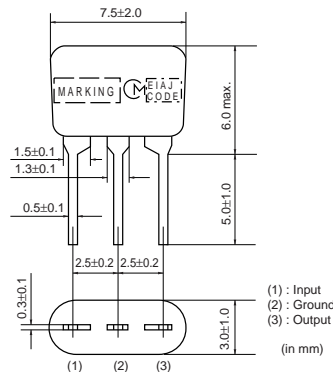

SFELG10M7FA00-B0

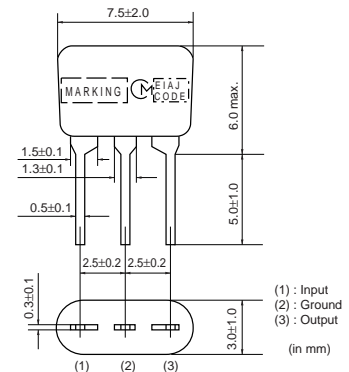

Part Number	Center Frequency (fo) (MHz)	3dB Bandwidth (kHz)	Attenuation (kHz)	Insertion Loss (dB)	Spurious Attenuation (1) (dB)	Spurious Attenuation (2) (dB)	Input/Output Impedance (ohm)
SFELG10M7KA00-B0	10.700 ±30kHz	110 ±30kHz	350 max.	7.0 ±2.0dB	30 min. [within 9MHz to fo]	30 min. [within fo to 12MHz]	330
SFELG10M7JA00-B0	10.700 ±30kHz	150 ±40kHz	360 max.	4.5 ±2.0dB	35 min. [within 9MHz to fo]	35 min. [within fo to 12MHz]	330
SFELG10M7HA00-B0	10.700 ±30kHz	180 ±40kHz	470 max.	3.5 ±2.0dB	35 min. [within 9MHz to fo]	35 min. [within fo to 12MHz]	330
SFELG10M7GA00-B0	10.700 ±30kHz	230 ±50kHz	570 max.	3.0 ±2.0dB	40 min. [within 9MHz to fo]	40 min. [within fo to 12MHz]	330

Continued on the following page.

Continued from the preceding page.

Part Number	Center Frequency (fo) (MHz)	3dB Bandwidth (kHz)	Attenuation (kHz)	Insertion Loss (dB)	Spurious Attenuation (1) (dB)	Spurious Attenuation (2) (dB)	Input/Output Impedance (ohm)
SFELG10M7FA00-B0	10.700 ±30kHz	280 ±50kHz	650 max.	3.0 ±2.0dB	30 min. [within 9MHz to fo]	30 min. [within fo to 12MHz]	330

Area of Attenuation: [within 20dB]

Area of Insertion Loss: at minimum loss point

Center frequency (fo) defined by the center of 3dB bandwidth.

For safety purposes, connect the output of filters to the IF amplifier through a D.C. blocking capacitor. Avoid applying a direct current to the output of ceramic filters.

The order quantity should be an integral multiple of the "Minimum Quantity" shown in the package page.

Standard Center Frequency Rank Code

CODE	30kHz Step	25kHz Step	Color Code
D	10.64MHz±30kHz	10.650MHz±25kHz	Black
B	10.67MHz±30kHz	10.675MHz±25kHz	Blue
A	10.70MHz±30kHz	10.700MHz±25kHz	Red
C	10.73MHz±30kHz	10.725MHz±25kHz	Orange
E	10.76MHz±30kHz	10.750MHz±25kHz	White
Z	Combination A, B, C, D, E		
M	Combination A, B, C		

Test Circuit

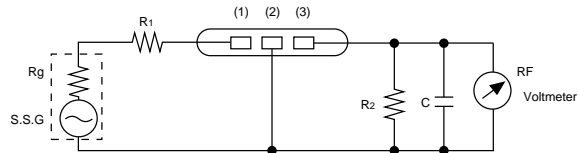

Rg + R1 = Rz = Input and Output Impedance
 C = 10pF (Including stray capacitance and input capacitance of RF voltmeter.)

(1) : Input
 (2) : Ground
 (3) : Output

Frequency Characteristics

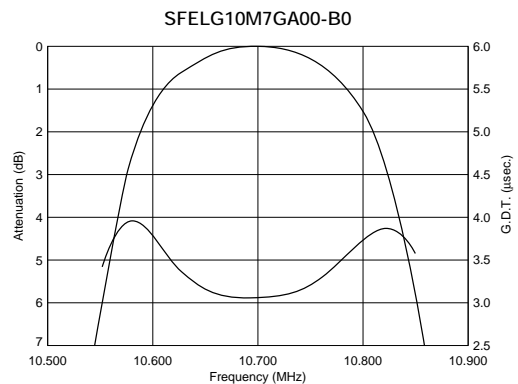
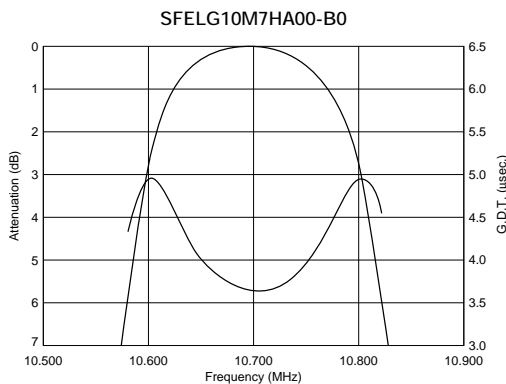
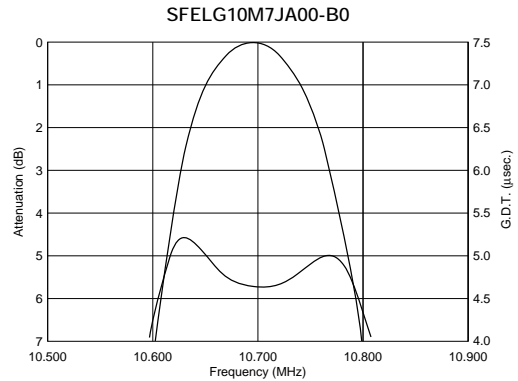
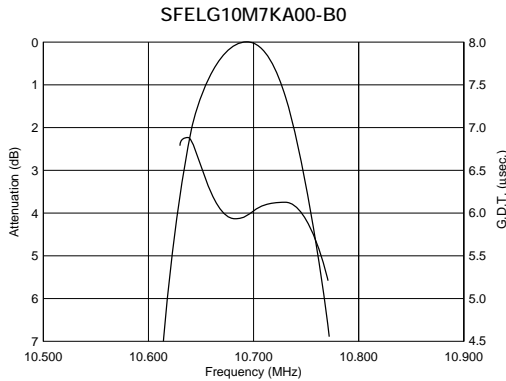

Continued on the following page. ↗

☒ Continued from the preceding page.

■ Frequency Characteristics

SFELG10M7FA00-B0

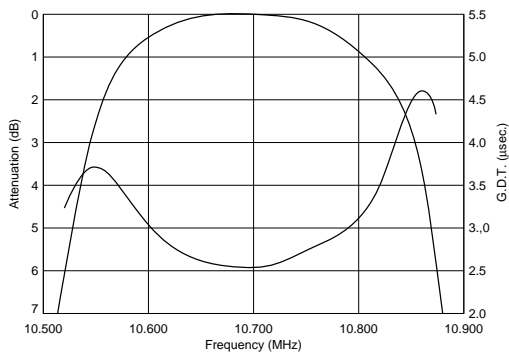

5

■ Frequency Characteristics (Spurious)

SFELG10M7KA00-B0

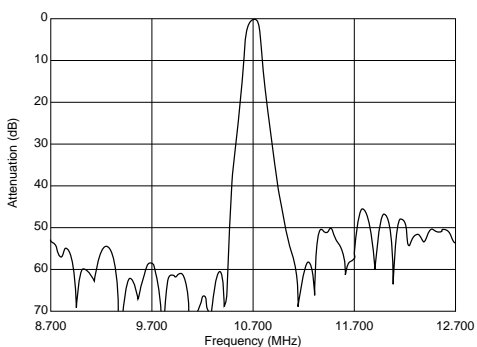

SFELG10M7JA00-B0

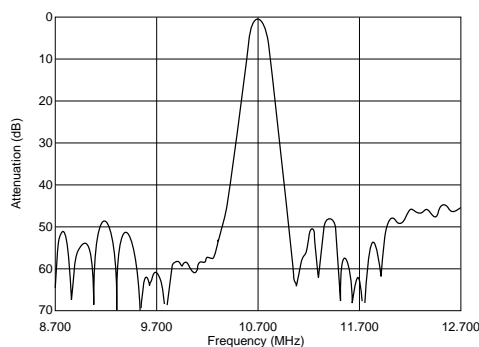

SFELG10M7HA00-B0

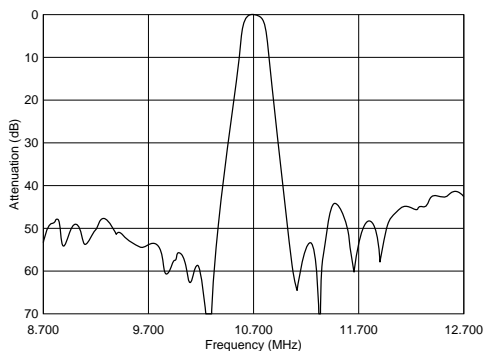

SFELG10M7GA00-B0

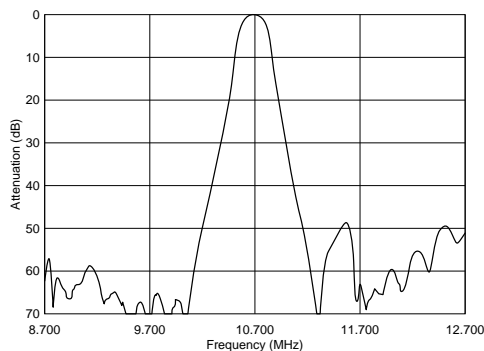

SFELG10M7FA00-B0

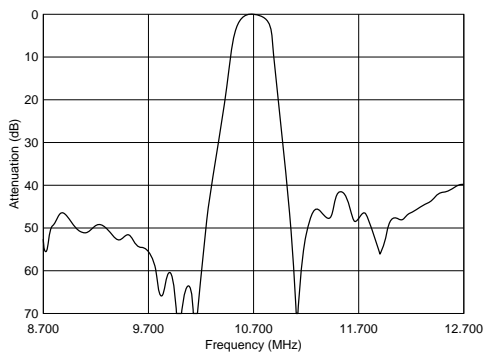

CERAFIL® (Filters/Traps/Discriminators) for Audio/Visual Equipment



CERAFIL® 10.7MHz Low Spurious Response Type

SFELF10M7 series for FM-receivers are monolithic type ceramic filters which use the thickness expander mode of the piezoelectric ceramic.

As part of the environment protection activity, solder for terminal plating and terminal-element connection inside of ceramic filter contain no lead (Pb).

■ Features

These types have lower spurious response compared to the standard filters.



SFELF10M7KAB0-B0

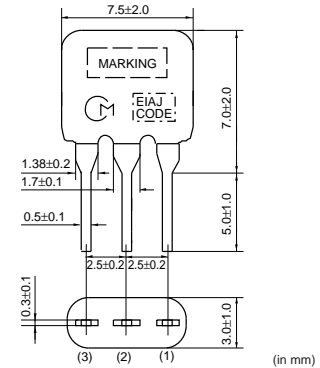

SFELF10M7JAB0-B0

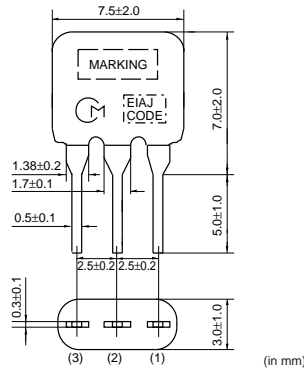

SFELF10M7HAB0-B0

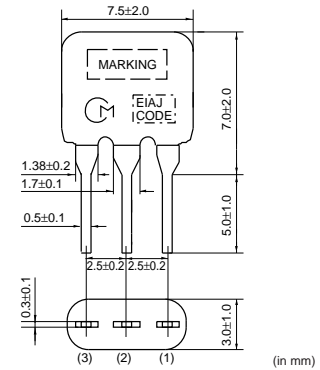

SFELF10M7GAB0-B0

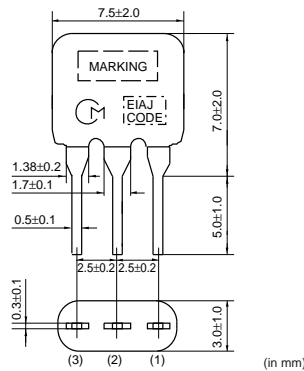

SFELF10M7FAB0-B0

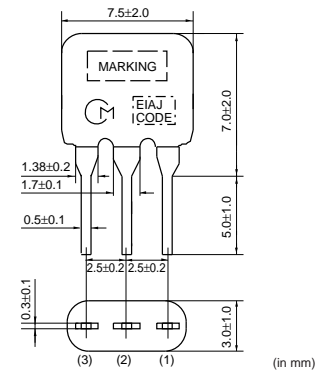

Part Number	Center Frequency (fo) (MHz)	3dB Bandwidth (kHz)	Attenuation (kHz)	Insertion Loss (dB)	Spurious Attenuation (1) (dB)	Spurious Attenuation (2) (dB)	Input/Output Impedance (ohm)
SFELF10M7KAB0-B0	10.700 ±30kHz	110 ±30kHz	350 max.	7.0 ±2.0dB	45 min. [within 9MHz to fo]	30 min. [within fo to 12MHz]	330
SFELF10M7JAB0-B0	10.700 ±30kHz	150 ±40kHz	380 max.	5.5 ±2.0dB	45 min. [within 9MHz to fo]	45 min. [within fo to 12MHz]	330
SFELF10M7HAB0-B0	10.700 ±30kHz	180 ±40kHz	520 max.	5.0 ±2.0dB	45 min. [within 9MHz to fo]	45 min. [within fo to 12MHz]	330
SFELF10M7GAB0-B0	10.700 ±30kHz	230 ±50kHz	570 max.	3.0 ±2.0dB	45 min. [within 9MHz to fo]	45 min. [within fo to 12MHz]	330

Continued on the following page. ↗

Continued from the preceding page.

Part Number	Center Frequency (fo) (MHz)	3dB Bandwidth (kHz)	Attenuation (kHz)	Insertion Loss (dB)	Spurious Attenuation (1) (dB)	Spurious Attenuation (2) (dB)	Input/Output Impedance (ohm)
SFELF10M7FAB0-B0	10.700 ±30kHz	280 ±50kHz	650 max.	3.0 ±2.0dB	45 min. [within 9MHz to fo]	45 min. [within fo to 12MHz]	330

Area of Attenuation: [within 20dB]

Area of Insertion Loss: at minimum loss point

Center frequency (fo) defined by the center of 3dB bandwidth.

For safety purposes, connect the output of filters to the IF amplifier through a D.C. blocking capacitor. Avoid applying a direct current to the output of ceramic filters.

The order quantity should be an integral multiple of the "Minimum Quantity" shown in the package page.

Standard Center Frequency Rank Code

CODE	30kHz Step	25kHz Step	Color Code
D	10.64MHz±30kHz	10.650MHz±25kHz	Black
B	10.67MHz±30kHz	10.675MHz±25kHz	Blue
A	10.70MHz±30kHz	10.700MHz±25kHz	Red
C	10.73MHz±30kHz	10.725MHz±25kHz	Orange
E	10.76MHz±30kHz	10.750MHz±25kHz	White
Z	Combination A, B, C, D, E		
M	Combination A, B, C		

6

Test Circuit

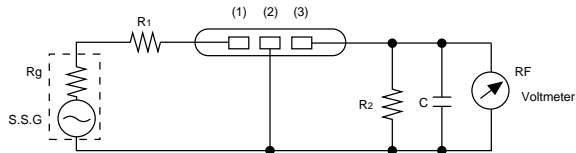

Rg + R1 = Rz = Input and Output Impedance
 C = 10pF (Including stray capacitance and input capacitance of RF voltmeter.)

(1) : Input
 (2) : Ground
 (3) : Output

Frequency Characteristics

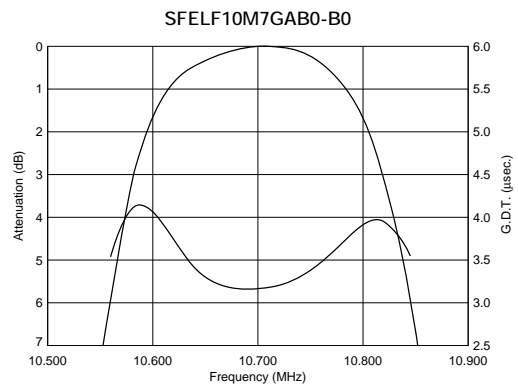
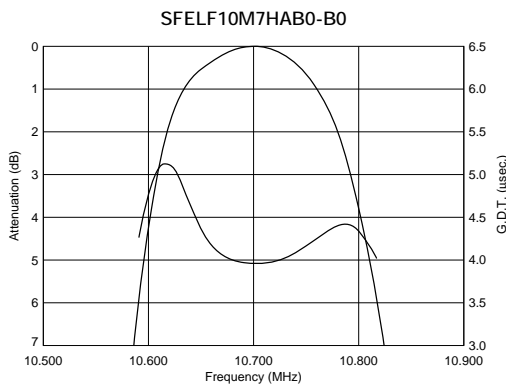
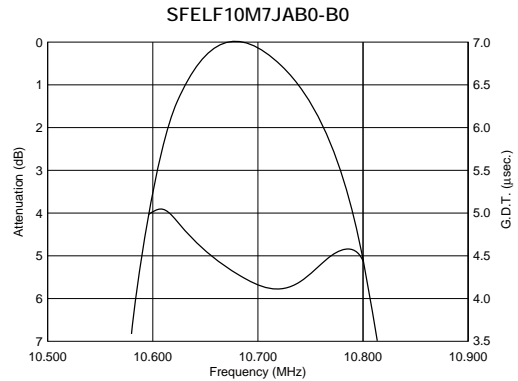
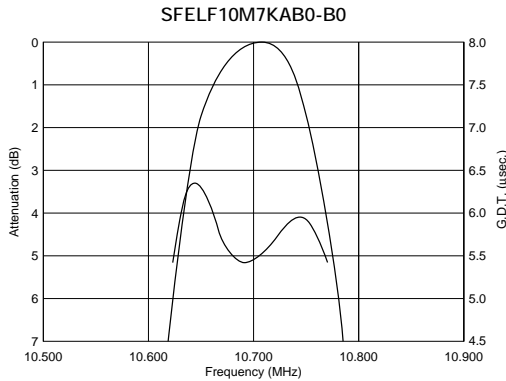

Continued on the following page. ↗

Continued from the preceding page.

Frequency Characteristics

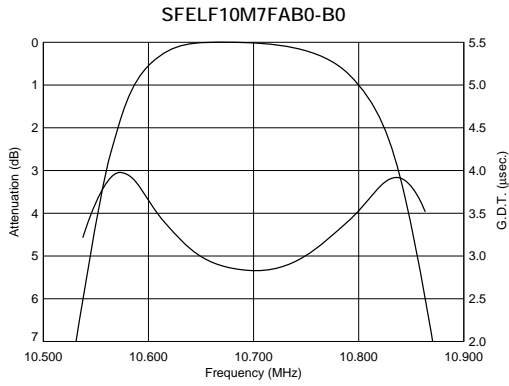

Frequency Characteristics (Spurious)

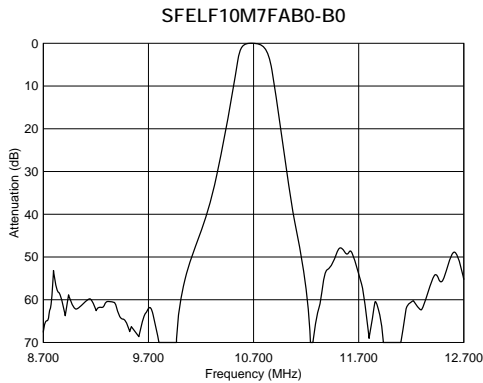
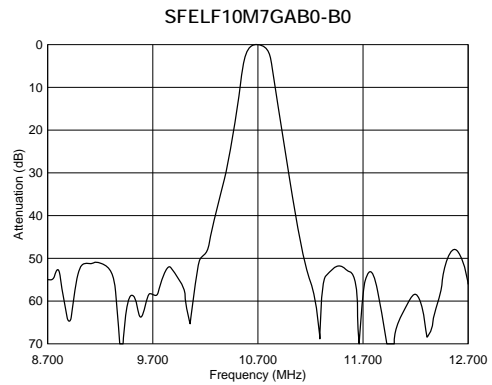
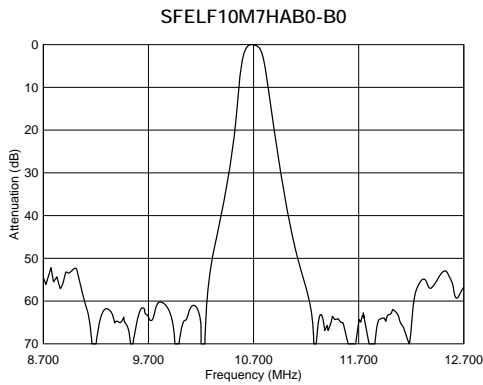
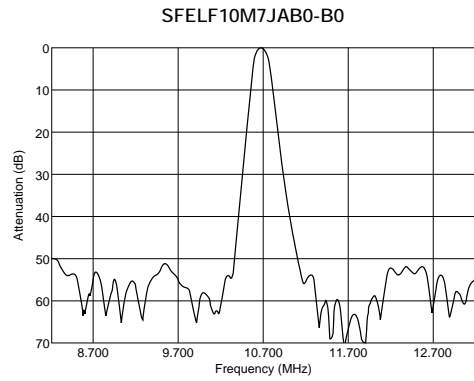
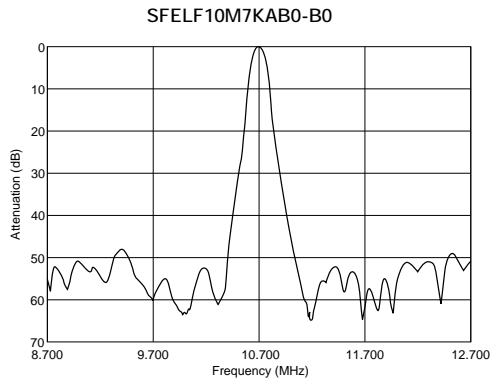

6

CERAFIL® (Filters/Traps/Discriminators) for Audio/Visual Equipment



CERAFIL® 10.7MHz Wide Bandwidth Type

SFELF10M7 series for FM-receivers are monolithic type ceramic filters which use the thickness expander mode of the piezoelectric ceramic.

As part of the environment protection activity, solder for terminal plating and terminal-element connection inside of ceramic filter contain no lead (Pb).

■ Features

Realizes wider band characteristics not obtained by conventional ceramic filters.



SFELF10M7EA00-B0

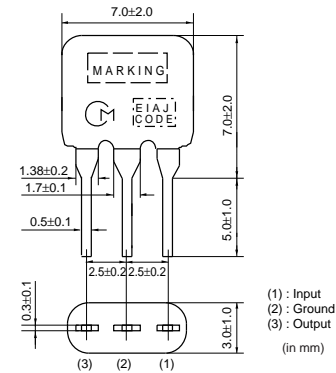

SFELF10M7DF00-B0

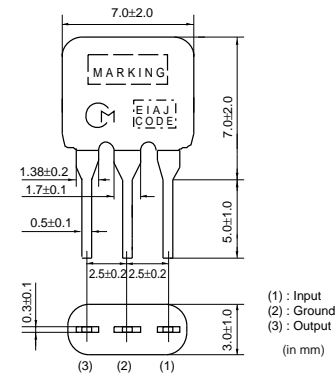

7

Part Number	Center Frequency (fo) (MHz)	Nominal Center Frequency (fn) (MHz)	3dB Bandwidth (kHz)	Attenuation (kHz)	Insertion Loss (dB)	Spurious Attenuation (1) (dB)	Spurious Attenuation (2) (dB)	Input/Output Impedance (ohm)
SFELF10M7EA00-B0	10.700 ±30kHz	-	330 ±50kHz	680 max.	4.0 ±2.0dB	30 min. [within 9MHz to fo]	30 min. [within fo to 12MHz]	330
SFELF10M7DF00-B0	-	10.700	fn±175 min.	950 max.	3.0 ±2.0dB	20 min. [within 5MHz to fn]	20 min. [within fn to 15MHz]	470

Area of Attenuation: [within 20dB]

Area of Insertion Loss: at minimum loss point

Center frequency (fo) defined by the center of 3dB bandwidth.

For safety purposes, connect the output of filters to the IF amplifier through a D.C. blocking capacitor. Avoid applying a direct current to the output of ceramic filters.

The order quantity should be an integral multiple of the "Minimum Quantity" shown in the package page.

■ Standard Center Frequency Rank Code (SFELF10M7EA00-B0)

CODE	30kHz Step	25kHz Step	Color Code
D	10.64MHz±30kHz	10.650MHz±25kHz	Black
B	10.67MHz±30kHz	10.675MHz±25kHz	Blue
A	10.70MHz±30kHz	10.700MHz±25kHz	Red
C	10.73MHz±30kHz	10.725MHz±25kHz	Orange
E	10.76MHz±30kHz	10.750MHz±25kHz	White
Z	Combination A, B, C, D, E		
M	Combination A, B, C		

■ Test Circuit

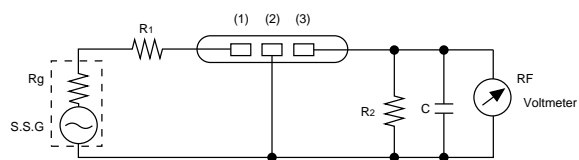

$R_g + R_1 = R_2 =$ Input and Output Impedance
 $C = 10\text{pF}$ (Including stray capacitance and input capacitance of RF voltmeter.)

(1) : Input
 (2) : Ground
 (3) : Output

■ Frequency Characteristics

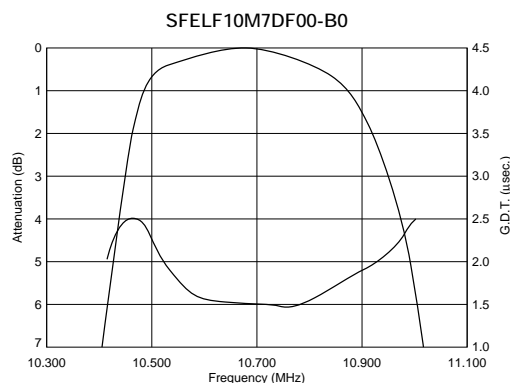
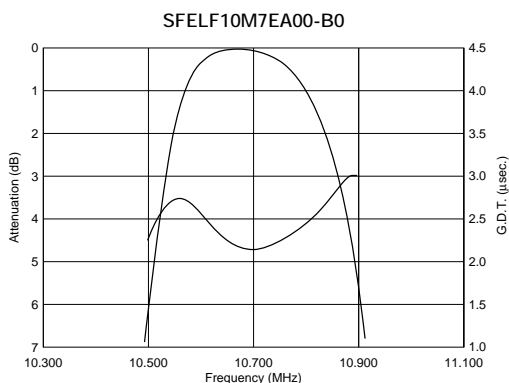

7

■ Frequency Characteristics (Spurious)

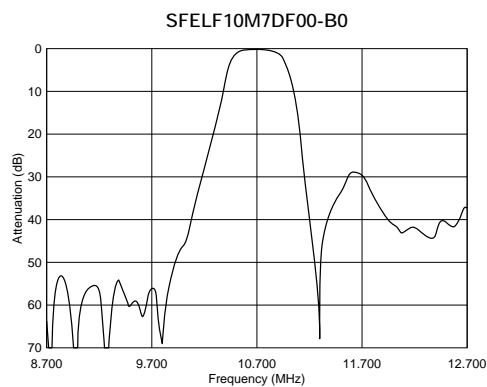
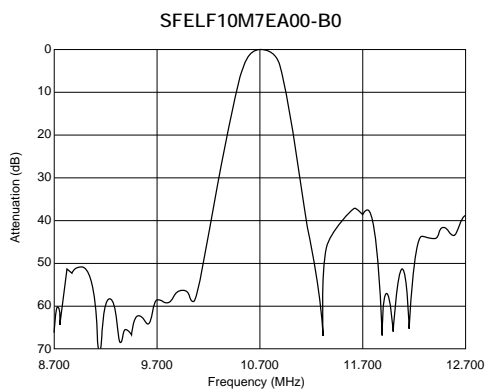

CERAFIL® (Filters/Traps/Discriminators) for Audio/Visual Equipment



CERAFIL® 10.7MHz Narrow Bandwidth Type

■ Features

SFELF10M7LFTA/KAH0, SFVLF/SFKLF series realizes narrower band characteristics not obtained by conventional ceramic filters. Besides, low spurious and temperature characteristics is stable. This series is suitable for European car-audio or AM up conversion use that needs narrow band characteristics are stable. As part of the environment protection activity, solder for terminal plating and terminal-element connection inside of ceramic filter contain no lead (Pb).

8



SFVLF10M7MF00-B0

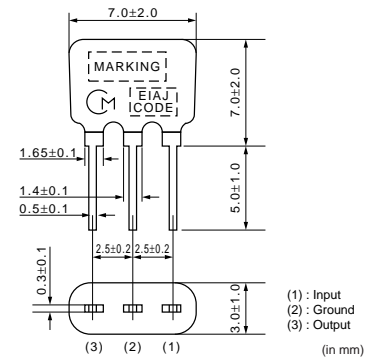

SFVLF10M7LF00-B0

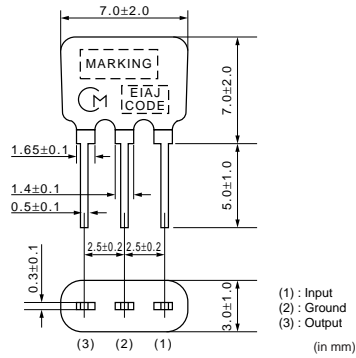

SFKLF10M7NL00-B0

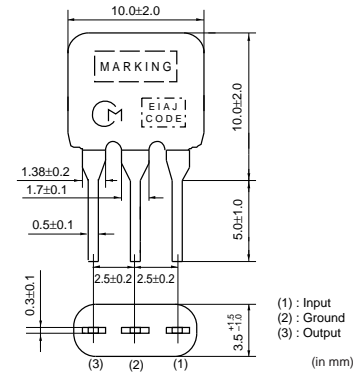

SFELF10M7LFTA-B0

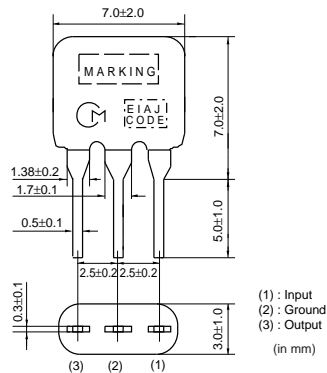

SFELF10M7KAH0-B0

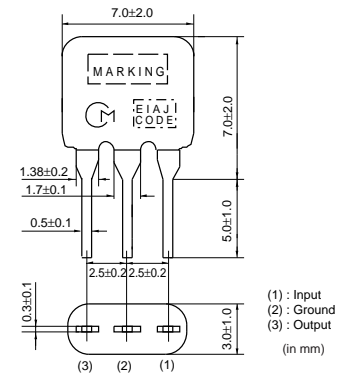

Part Number	Center Frequency (fo) (MHz)	Nominal Center Frequency (fn) (MHz)	3dB Bandwidth (kHz)	Attenuation (kHz)	Insertion Loss (dB)	Spurious Attenuation (1) (dB)	Spurious Attenuation (2) (dB)	Input/Output Impedance (ohm)
SFVLF10M7MF00-B0	-	10.700	fn±13 min.	135 max.	5.0 ±2.0dB	35 min. [within 9MHz to fn]	35 min. [within fn to 12MHz]	330
SFVLF10M7LF00-B0	-	10.700	fn±25 min.	-	5.5 ±2.5dB	30 min. [within 9MHz to fn]	30 min. [within fn to 12MHz]	330
SFKLF10M7NL00-B0	10.700 ±15kHz	-	20 min.	95 max.	6.0 max.	24 min. [within fo-1MHz to fo]	24 min. [within fo to fo+1MHz]	600
SFELF10M7LFTA-B0	-	10.700	fn±25 min.	280 max.	7.0 ±2.0dB	30 min. [within 9MHz to fn]	30 min. [within fn to 12MHz]	330

Continued on the following page. ↗

Continued from the preceding page.

Part Number	Center Frequency (fo) (MHz)	Nominal Center Frequency (fn) (MHz)	3dB Bandwidth (kHz)	Attenuation (kHz)	Insertion Loss (dB)	Spurious Attenuation (1) (dB)	Spurious Attenuation (2) (dB)	Input/Output Impedance (ohm)
SFELF10M7KAH0-B0	10.700 ±30kHz	-	110 ±30kHz	350 max.	7.0 ±2.0dB	30 min. [within 9MHz to fo]	30 min. [within fo to 12MHz]	330

Area of Attenuation: [within 20dB]

Area of Insertion Loss: at minimum loss point

Center frequency (fo) defined by the center of 3dB bandwidth.

For safety purposes, connect the output of filters to the IF amplifier through a D.C. blocking capacitor. Avoid applying a direct current to the output of ceramic filters.

The order quantity should be an integral multiple of the "Minimum Quantity" shown in the package page.

Standard Center Frequency Rank Code (SFELF10M7KAH0-B0)

CODE	30kHz Step	25kHz Step	Color Code
D	10.64MHz±30kHz	10.650MHz±25kHz	Black
B	10.67MHz±30kHz	10.675MHz±25kHz	Blue
A	10.70MHz±30kHz	10.700MHz±25kHz	Red
C	10.73MHz±30kHz	10.725MHz±25kHz	Orange
E	10.76MHz±30kHz	10.750MHz±25kHz	White
Z	Combination A, B, C, D, E		
M	Combination A, B, C		

Test Circuit

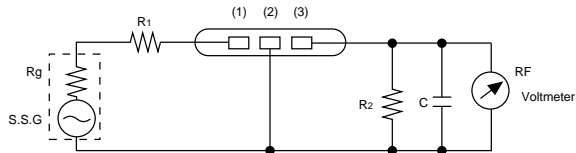

Rg + R1 = Rz = Input and Output Impedance
 C = 10pF (Including stray capacitance and input capacitance of RF voltmeter.)

(1) : Input
 (2) : Ground
 (3) : Output

Frequency Characteristics

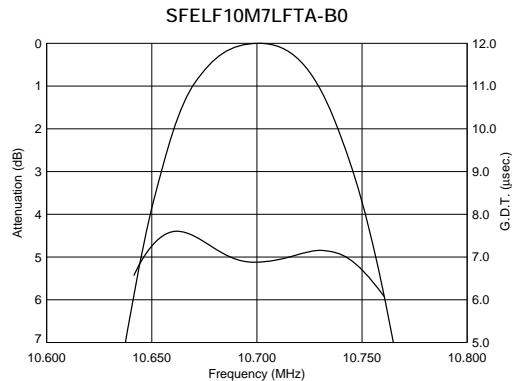
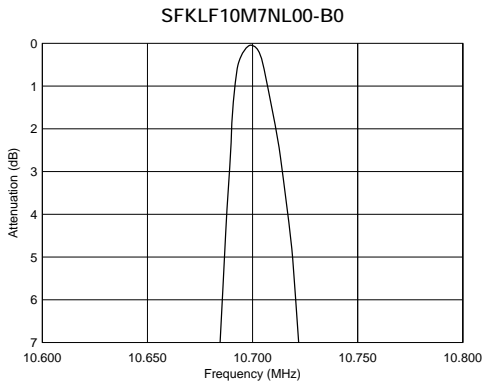
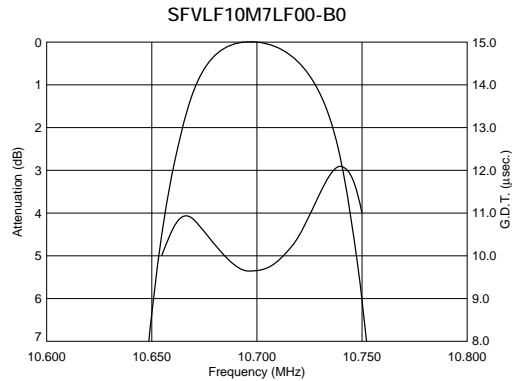
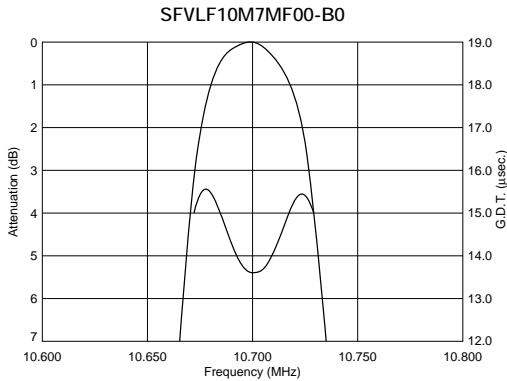

Continued on the following page. ↗

☐ Continued from the preceding page.

■ Frequency Characteristics

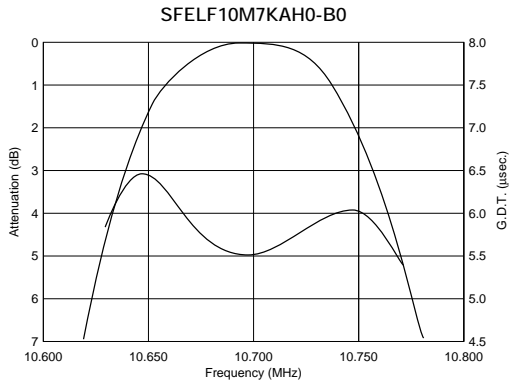

■ Frequency Characteristics (Spurious)

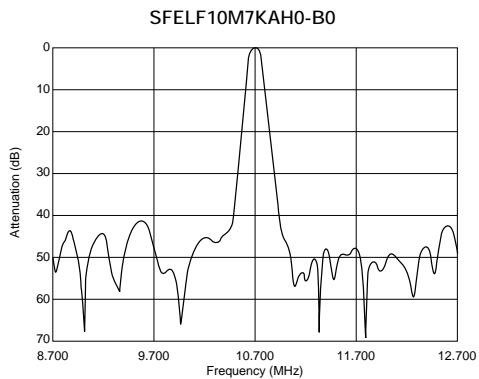
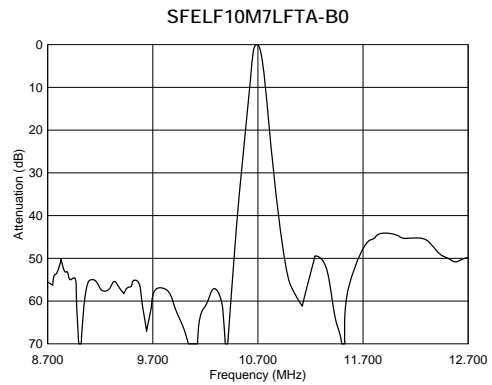
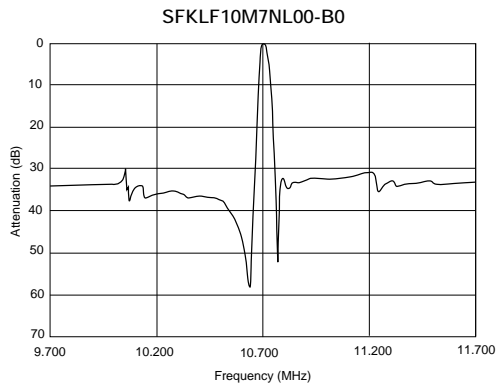
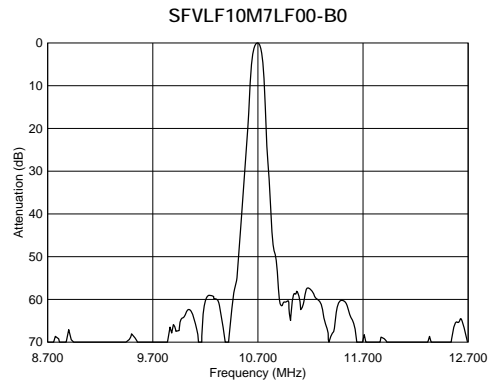
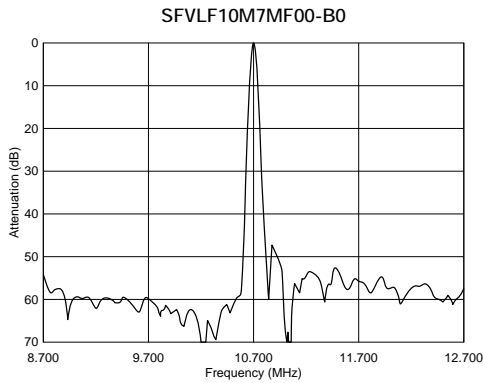

CERAFIL® (Filters/Traps/Discriminators) for Audio/Visual Equipment



CERAFIL® 10.7MHz for FM-IF Tuners

SFELF10M7 series for FM-receivers are monolithic type ceramic filters which use the thickness expander mode of the piezoelectric ceramic.

As part of the environment protection activity, solder for terminal plating and terminal-element connection inside of ceramic filter contain no lead (Pb).

■ Features

1. Little dispersion of amplitude characteristics and phase characteristics (G. D. T. characteristics)
2. The SFELF_G series is based on SFELF_FA00/GA00/HA00, and it obtains high selectivity with low loss. There is little dispersion of amplitude and GDT characteristics, and low distortion rate can be obtained.
3. The flatness of GDT is inspected for all products.



SFELF10M7HA0G-B0

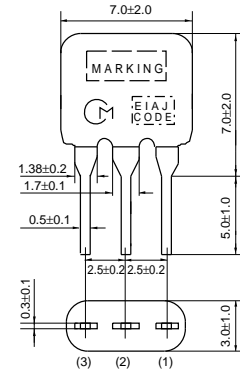

(1) : Input
(2) : Ground
(3) : Output
(in mm)



SFELF10M7GA0G-B0

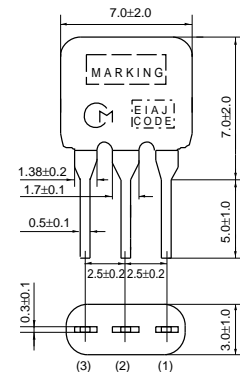

(1) : Input
(2) : Ground
(3) : Output
(in mm)



SFELF10M7FA0G-B0

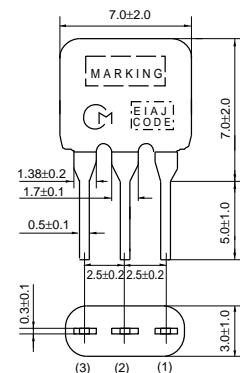

(1) : Input
(2) : Ground
(3) : Output
(in mm)

Part Number	Center Frequency (fo) (MHz)	3dB Bandwidth (kHz)	Attenuation (kHz)	Insertion Loss (dB)	Spurious Attenuation (1) (dB)	Spurious Attenuation (2) (dB)	GDT Bandwidth (kHz)	Input/Output Impedance (ohm)
SFELF10M7HA0G-B0	10.700 ±30kHz	180 ±40kHz	520 max.	7.0 max.	40 min. [within 9MHz to fo]	40 min. [within fo to 12MHz]	fo±45 min. [within 0.5µsec.]	330
SFELF10M7GA0G-B0	10.700 ±30kHz	230 ±50kHz	600 max.	7.0 max.	40 min. [within 9MHz to fo]	40 min. [within fo to 12MHz]	fo±60 min. [within 0.5µsec.]	330
SFELF10M7FA0G-B0	10.700 ±30kHz	280 ±50kHz	650 max.	4.0 ±2.0dB	30 min. [within 9MHz to fo]	30 min. [within fo to 12MHz]	fo±85 min. [within 0.5µsec.]	330

Area of Attenuation: [within 20dB]

Area of Insertion Loss: at minimum loss point

Center frequency (fo) defined by the center of 3dB bandwidth.

For safety purposes, connect the output of filters to the IF amplifier through a D.C. blocking capacitor. Avoid applying a direct current to the output of ceramic filters.

The order quantity should be an integral multiple of the "Minimum Quantity" shown in the package page.

Standard Center Frequency Rank Code

CODE	30kHz Step	25kHz Step	Color Code
D	10.64MHz±30kHz	10.650MHz±25kHz	Black
B	10.67MHz±30kHz	10.675MHz±25kHz	Blue
A	10.70MHz±30kHz	10.700MHz±25kHz	Red
C	10.73MHz±30kHz	10.725MHz±25kHz	Orange
E	10.76MHz±30kHz	10.750MHz±25kHz	White
Z	Combination A, B, C, D, E		
M	Combination A, B, C		

Test Circuit

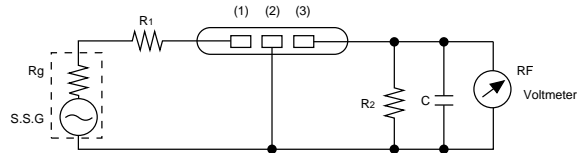

$R_g + R_1 = R_z =$ Input and Output Impedance
 $C = 10\text{pF}$ (Including stray capacitance and input capacitance of RF voltmeter.)

(1) : Input
 (2) : Ground
 (3) : Output

9

Frequency Characteristics

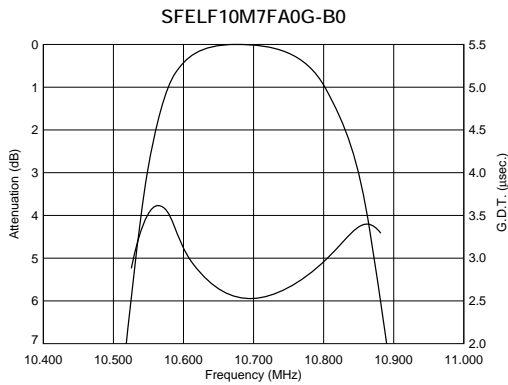
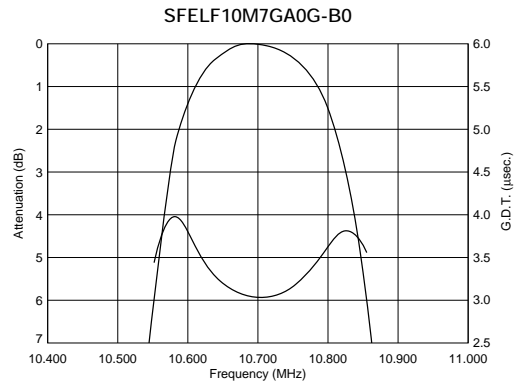
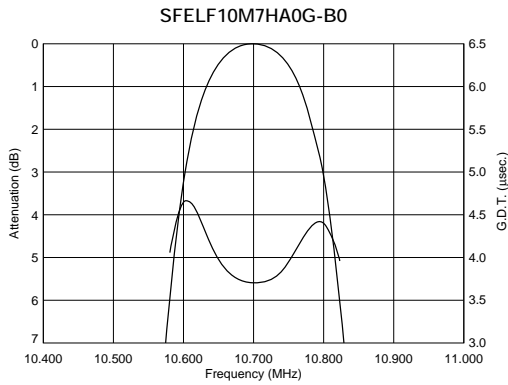

■ Frequency Characteristics (Spurious)

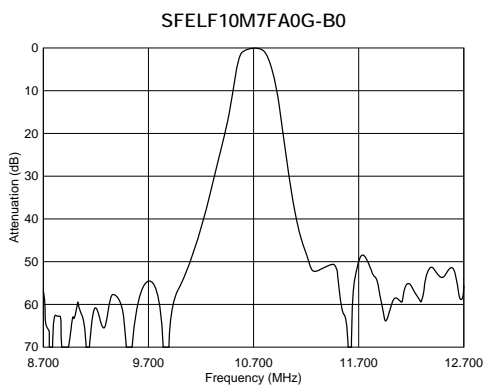
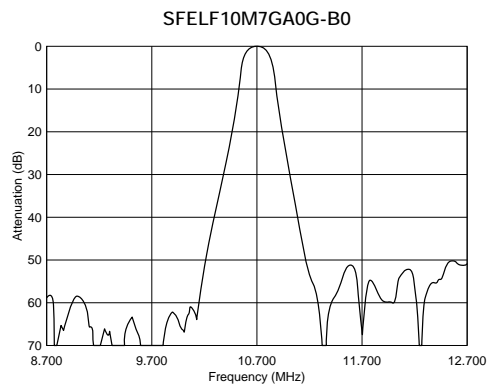
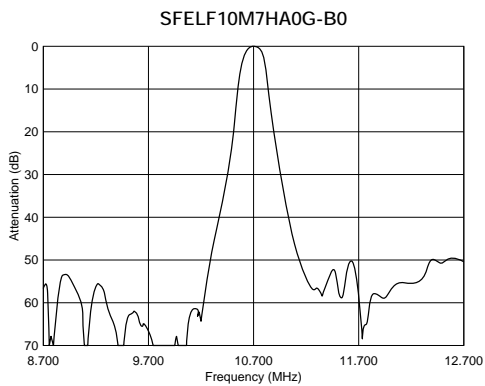

CERAFIL[®] 10.7MHz Related Data on Lead Type

Temperature Characteristics

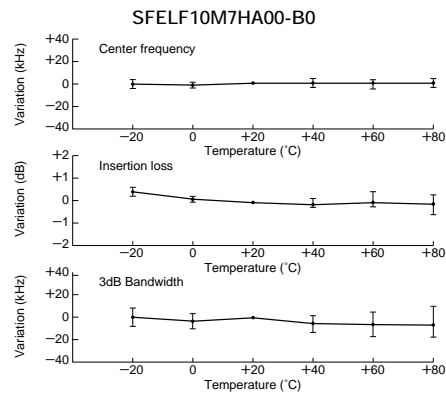
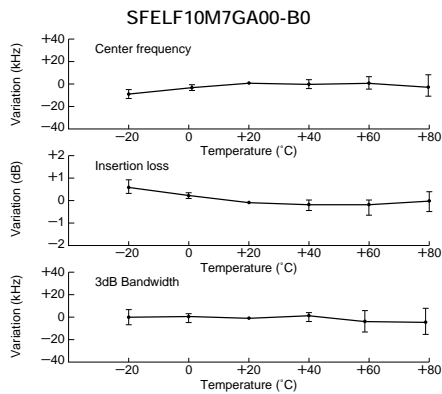

Matching Conditions

- When using ceramic filters, it is most important to match the input/output load to impedance 330 ohm (SFELF10M7DF00-B0 is 470 ohm and SFKLF10M7NL00-B0 is 600 ohm matching).
Waveform symmetry is damaged when reactance is added to the input/output load.
- Two ceramic filters directly connected can be used for high selectivity. For reducing waveform variation, it is recommended to input a buffer AMP between ceramic filters.

- The SFELF10M7 series are of input/output symmetric structure so that in theory there is no input/output directionality. Actual circuits may use different input/output loading conditions (for example, mismatched impedance) or capacitance load. In such cases, the waveform will be a little changed by the direction of the input/output of the ceramic filters.

Loaded Resistance and Waveform (R_g+R₁=330 ohm)

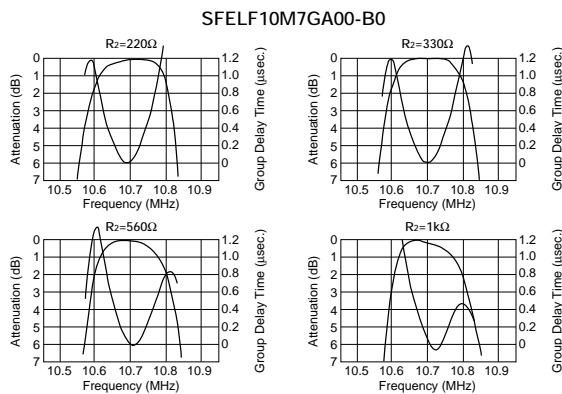

Loaded Capacitance and Waveform (R_g+R₁=R₂=330 ohm)

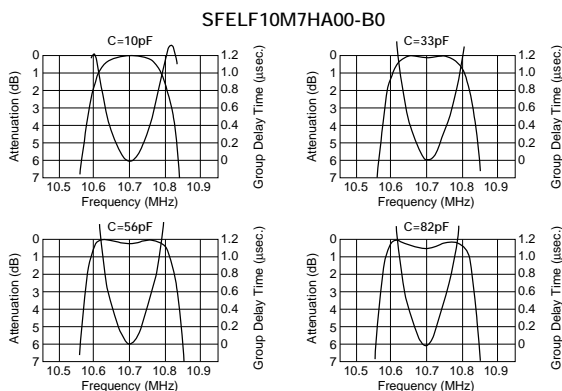

CERAFIL® (Filters/Traps/Discriminators) for Audio/Visual Equipment



CERAFIL® 4.5-6.5MHz Chip Type SFSKA Series

SMD ceramic filter SFSKA_CF is a small and thin SMD filter sealed with a metal cap.
 Recommended for LCD-TVs, and small and thin tuners.

■ Features

1. High attenuation outside bandwidth
2. Small and thin package
3. Reflow-solderable

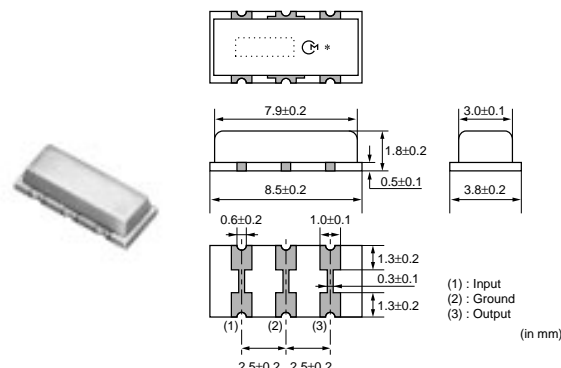

Part Number	Nominal Center Frequency (fn) (MHz)	3dB Bandwidth (kHz)	20dB Bandwidth (kHz)	Insertion Loss (dB)	Spurious Attenuation(1) (dB)	Spurious Attenuation(2) (dB)	Input/Output Impedance (ohm)
SFSKA4M50CF00-R3	4.500	fn±60 min.	600 max.	6.0 max.	20 min. [within 0 to fn]	15 min. [within fn to 7.0MHz]	1000
SFSKA5M50CF00-R3	5.500	fn±60 min.	600 max.	6.0 max.	25 min. [within 0 to fn]	15 min. [within fn to 7.0MHz]	600
SFSKA6M00CF00-R3	6.000	fn±60 min.	600 max.	6.0 max.	25 min. [within 0 to fn]	15 min. [within fn to 7.5MHz]	470
SFSKA6M50CF00-R3	6.500	fn±60 min.	600 max.	6.0 max.	25 min. [within 0 to fn]	15 min. [within fn to 8.5MHz]	470

Area of Insertion Loss: at minimum loss point

For safety purposes, connect the output of filters to the IF amplifier through a D.C. blocking capacitor. Avoid applying a direct current to the output of ceramic filters.

The order quantity should be an integral multiple of the "Minimum Quantity" shown in the package page.

10

■ Standard Land Pattern Dimensions

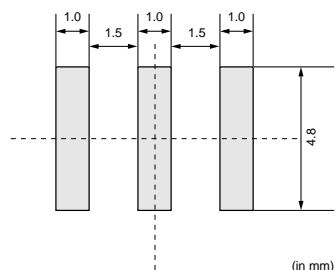

■ Test Circuit

SFSKA4M50CF00-R1

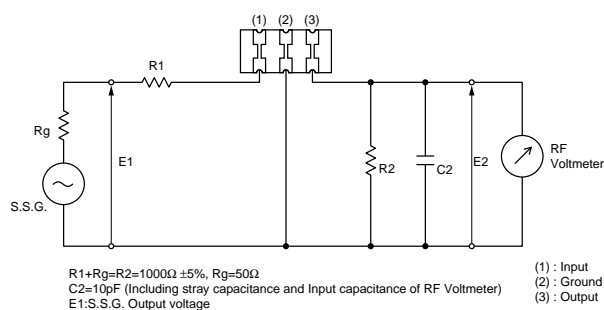

Continued on the following page. ↗

Continued from the preceding page.

Test Circuit

SFSKA5M50CF00-R1

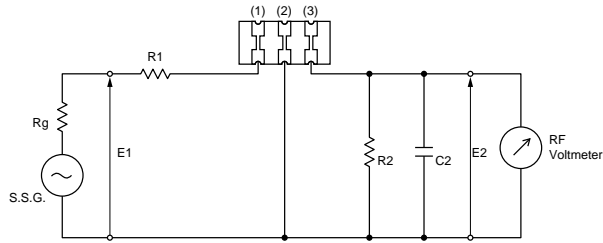

$R1+Rg=R2=600\Omega \pm 5\%$, $Rg=50\Omega$
 $C2=10pF$ (Including stray capacitance and Input capacitance of RF Voltmeter)
 E1: S.S.G. Output voltage
 (1) : Input
 (2) : Ground
 (3) : Output

SFSKA6M00CF00-R1

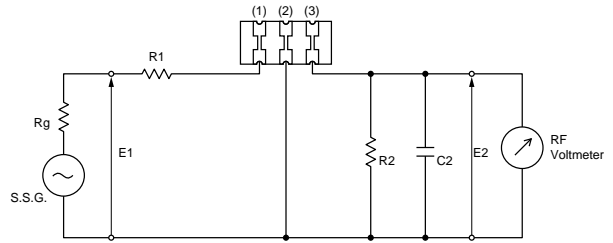

$R1+Rg=R2=470\Omega \pm 5\%$, $Rg=50\Omega$
 $C2=10pF$ (Including stray capacitance and Input capacitance of RF Voltmeter)
 E1: S.S.G. Output voltage
 (1) : Input
 (2) : Ground
 (3) : Output

SFSKA6M50CF00-R1

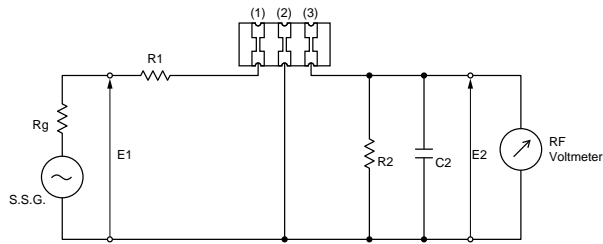

$R1+Rg=R2=470\Omega \pm 5\%$, $Rg=50\Omega$
 $C2=10pF$ (Including stray capacitance and Input capacitance of RF Voltmeter)
 E1: S.S.G. Output voltage
 (1) : Input
 (2) : Ground
 (3) : Output

10

Frequency Characteristics

SFSKA4M50CF00-R1

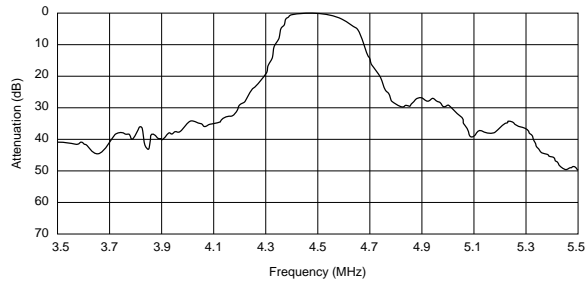

SFSKA5M50CF00-R1

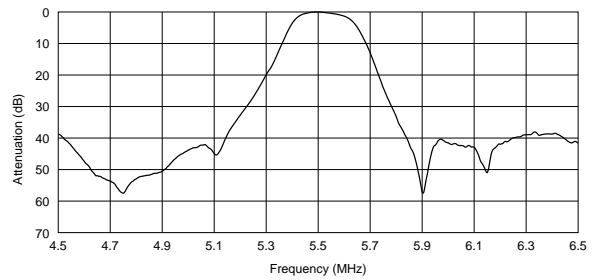

SFSKA6M00CF00-R1

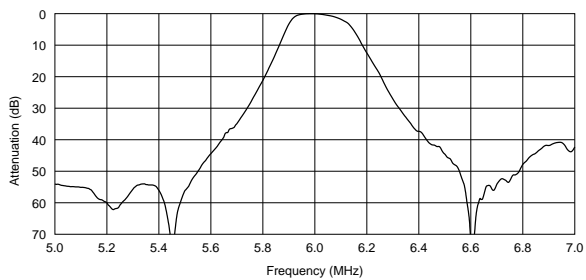

SFSKA6M50CF00-R1

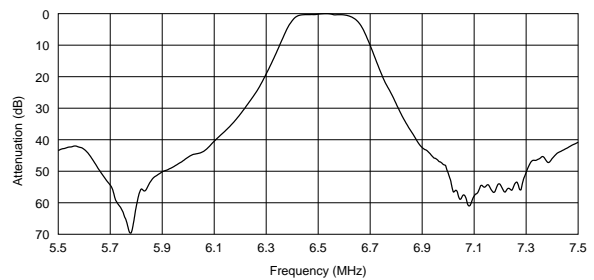

■ Frequency Characteristics (Spurious)

SFSKA4M50CF00-R1

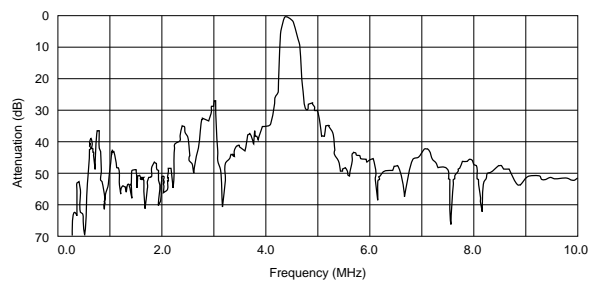

SFSKA5M50CF00-R1

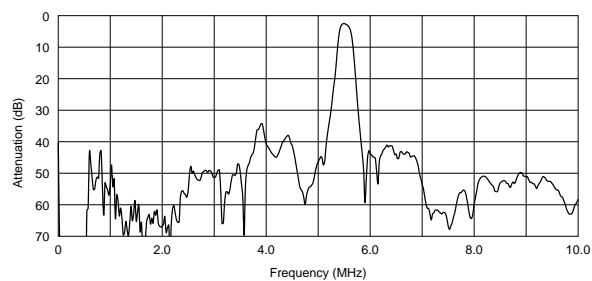

SFSKA6M00CF00-R1

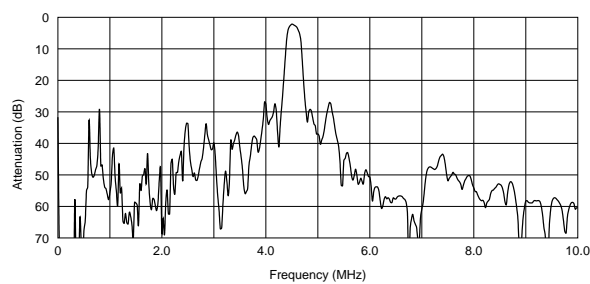

SFSKA6M50CF00-R1

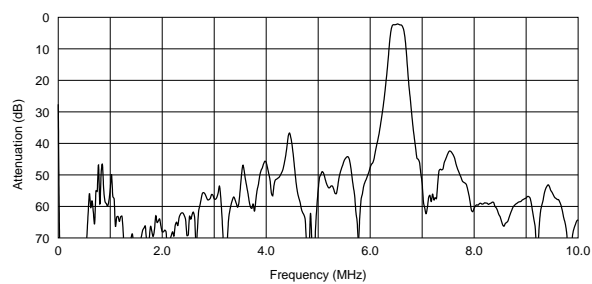

CERAFIL® (Filters/Traps/Discriminators) for Audio/Visual Equipment



CERAFIL® 2.3-5.7MHz Chip Type SFSKB Series

The SFSKB series are SMD ceramic filters which are suitable for IR head phone applications. Center frequencies of 2.3, 2.8, 3.2, 3.8, 4.3, 4.8, 5.2, 5.7MHz are available. Realized Small, thin and lightweight package, compared with conventional LC filters. It helps to compose multi channel circuit on one PCB. No frequency adjustment is required on PCB and it contributes reduction of production cost.

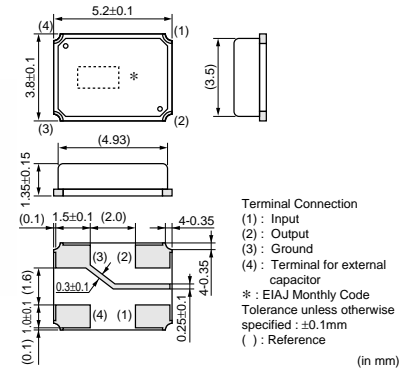

■ Features

1. SMD package in plastic emboss tape, available for automatic placing.
2. They are slim, at only 1.5mm max. thickness, and have a small mounting area (5.2x3.8mm) enabling flexible PCB design.
3. Available for lead (Pb) free re-flow soldering process.
4. Operating temperature range: 0 to +70 (degree C)
Storage temperature range: -55 to +85 (degree C)
5. No frequency adjustment is required in production process.
6. Small, thin and lightweight package compared with conventional LC filters

■ Applications

1. IR head phone
2. Set Top Box for satellite broadcasting

11

Part Number	Nominal Center Frequency (fn) (MHz)	3dB Bandwidth (kHz)	20dB Bandwidth (kHz)	Insertion Loss (dB)	Spurious Attenuation(1) (dB)	Spurious Attenuation(2) (dB)	Input/Output Impedance (ohm)
SFSKB2M30GF00-R1	2.300	fn±75 min.	650 max.	6.0 max.	25 min. [within 1.3 to 1.8MHz]	23 min. [within 2.8 to 3.3MHz]	1000
SFSKB2M80GF00-R1	2.800	fn±75 min.	650 max.	6.0 max.	25 min. [within 1.8 to 2.3MHz]	25 min. [within 3.3 to 3.8MHz]	1000
SFSKB3M20FF00-R1	3.200	fn±75 min.	650 max.	6.0 max.	30 min. [within 2.2 to 2.8MHz]	30 min. [within 3.8 to 4.2MHz]	1000
SFSKB3M80GF00-R1	3.800	fn±75 min.	650 max.	6.0 max.	30 min. [within 2.8 to 3.2MHz]	30 min. [within 4.3 to 4.8MHz]	1000
SFSKB4M30GF00-R1	4.300	fn±75 min.	650 max.	6.0 max.	30 min. [within 3.3 to 3.8MHz]	30 min. [within 4.8 to 5.3MHz]	1000
SFSKB4M80GF00-R1	4.800	fn±75 min.	650 max.	6.0 max.	30 min. [within 3.8 to 4.3MHz]	30 min. [within 5.2 to 5.8MHz]	1000
SFSKB5M20GF00-R1	5.200	fn±75 min.	650 max.	6.0 max.	30 min. [within 4.2 to 4.8MHz]	30 min. [within 5.7 to 6.2MHz]	1000
SFSKB5M70GF00-R1	5.700	fn±75 min.	650 max.	6.0 max.	30 min. [within 4.7 to 5.2MHz]	30 min. [within 6.2 to 6.7MHz]	1000

For safety purposes, connect the output of filters to the IF amplifier through a D.C. blocking capacitor. Avoid applying a direct current to the output of ceramic filters. The order quantity should be an integral multiple of the "Minimum Quantity" shown in the package page.

Standard Center Frequency Rank Code

CODE	30kHz Step	25kHz Step
D	10.64MHz±30kHz	10.650MHz±25kHz
B	10.67MHz±30kHz	10.675MHz±25kHz
A	10.70MHz±30kHz	10.700MHz±25kHz
C	10.73MHz±30kHz	10.725MHz±25kHz
E	10.76MHz±30kHz	10.750MHz±25kHz
Z	Combination A, B, C, D, E	
M	Combination A, B, C	

Standard Land Pattern Dimensions

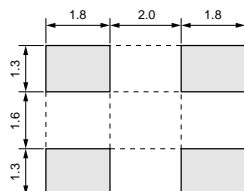

(in mm)

Test Circuit

SFSKB2M30GF00-R1/SFSKB3MZ0GF00-R1

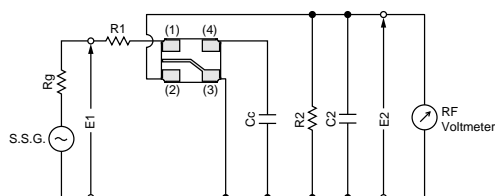

$R1+Rg=R2=1.0k\Omega$
 $C0=22pF\pm5\%$
 $C2=10pF$ (Including stray capacitance and Input capacitance of RF Voltmeter)
 E1 : S.S.G. S.S.G. Output Voltage

(1) : Input
 (2) : Output
 (3) : Ground
 (4) : Terminal for external capacitor

SFSKB2M80GF00-R1/SFSKB3M20FF00-R1

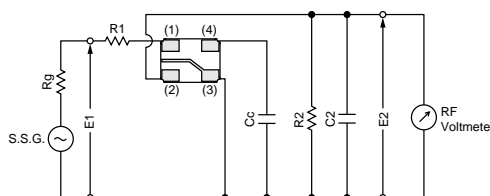

$R1+Rg=R2=1.0k\Omega$
 $C0=39pF\pm5\%$
 $C2=10pF$ (Including stray capacitance and Input capacitance of RF Voltmeter)
 E1 : S.S.G. S.S.G. Output Voltage

(1) : Input
 (2) : Output
 (3) : Ground
 (4) : Terminal for external capacitor

SFSKB4M30GF00-R1/SFSKB5M70GF00-R1

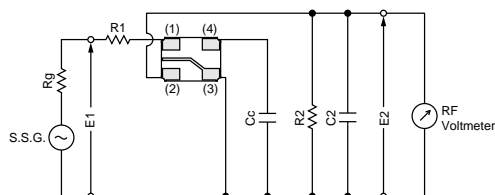

$R1+Rg=R2=1.0k\Omega$
 $C0=33pF\pm5\%$
 $C2=10pF$ (Including stray capacitance and Input capacitance of RF Voltmeter)
 E1 : S.S.G. S.S.G. Output Voltage

(1) : Input
 (2) : Output
 (3) : Ground
 (4) : Terminal for external capacitor

SFSKB4M80GF00-R1

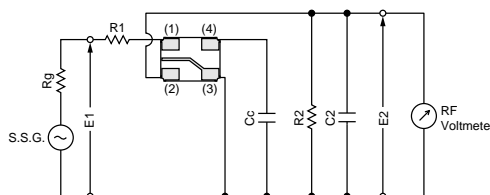

$R1+Rg=R2=1.0k\Omega$
 $C0=15pF\pm5\%$
 $C2=10pF$ (Including stray capacitance and Input capacitance of RF Voltmeter)
 E1 : S.S.G. S.S.G. Output Voltage

(1) : Input
 (2) : Output
 (3) : Ground
 (4) : Terminal for external capacitor

Continued on the following page. ↗

Continued from the preceding page.

Test Circuit

SFSKB5M20GF00-R1

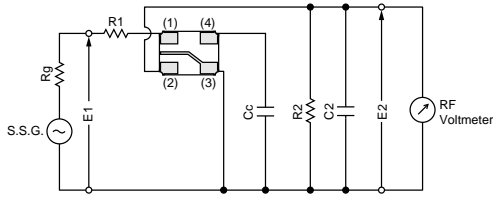

$R1+Rg=R2=1.0k\Omega$
 $Cc=27pF\pm 5\%$
 $C2=10pF$ (Including stray capacitance and input capacitance of RF Voltmeter)
 E1 : S.S.G. S.S.G. Output Voltage

(1) : Input
 (2) : Output
 (3) : Ground
 (4) : Terminal for external capacitor

Frequency Characteristics

SFSKB2M30GF00-R1

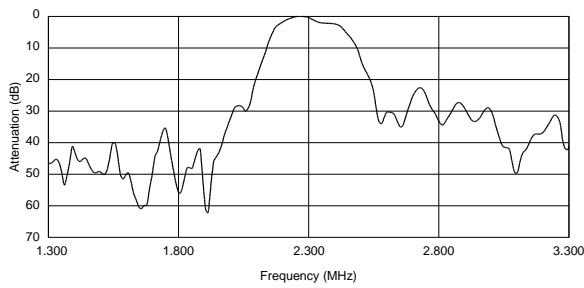

SFSKB2M80GF00-R1

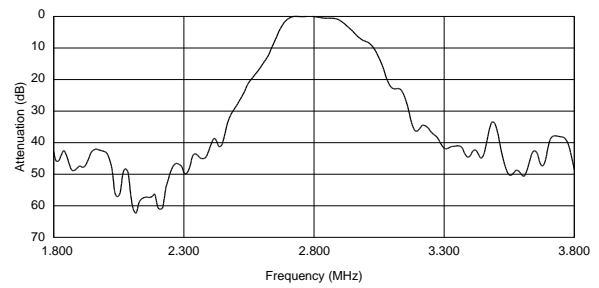

SFSKB3M20FF00-R1

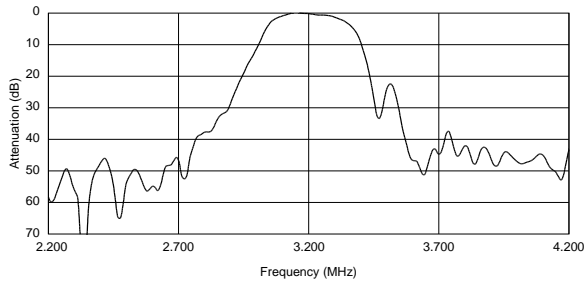

SFSKB3M80GF00-R1

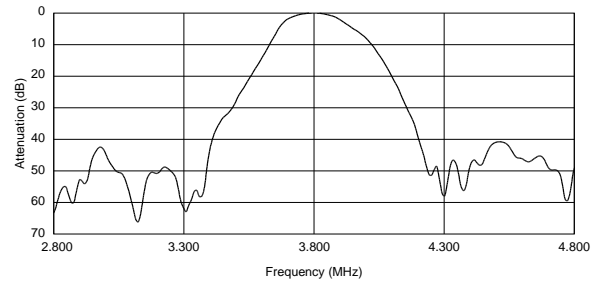

SFSKB4M30GF00-R1

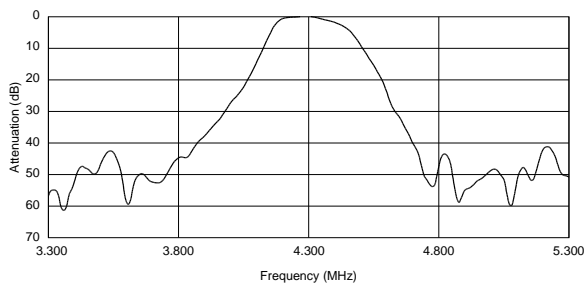

SFSKB4M80GF00-R1

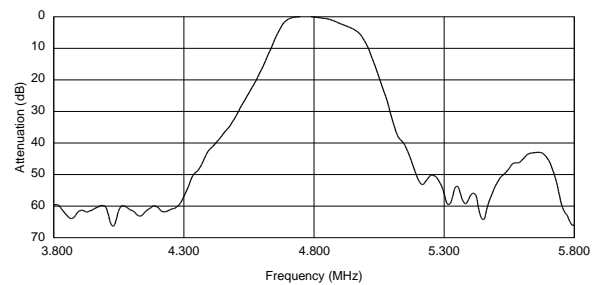

Continued from the preceding page.

Frequency Characteristics

SFSKB5M20GF00-R1

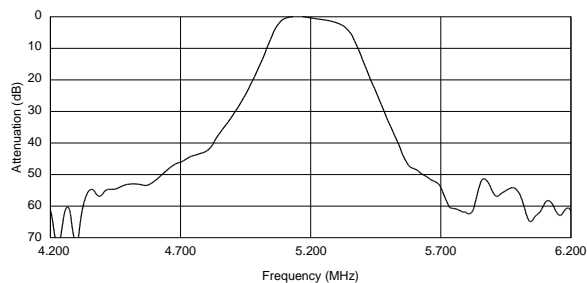

SFSKB5M70GF00-R1

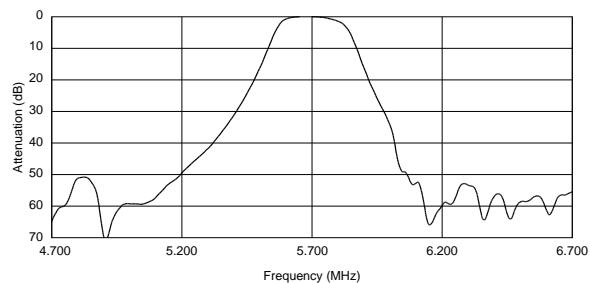

Frequency Characteristics (Spurious)

SFSKB2M30GF00-R1

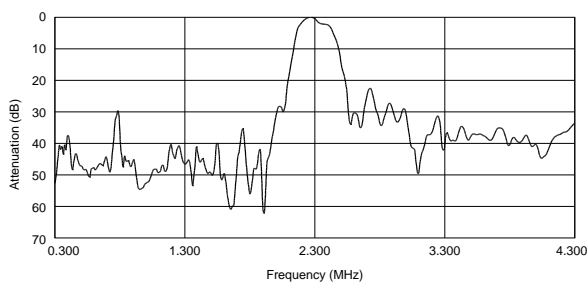

SFSKB2M80GF00-R1

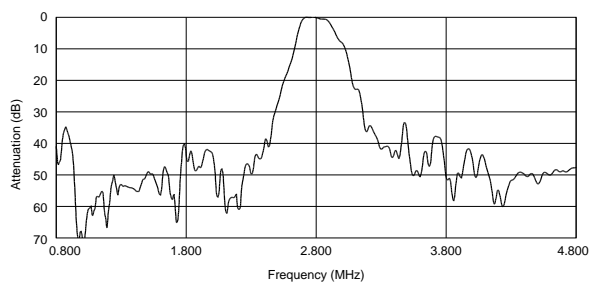

SFSKB3M20FF00-R1

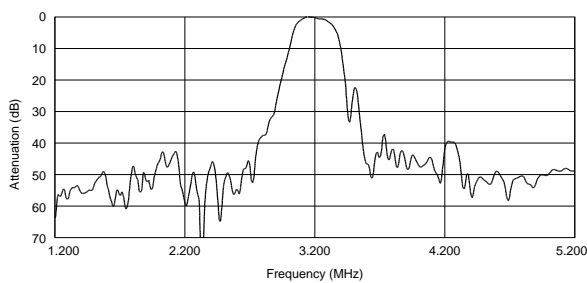

SFSKB3M80GF00-R1

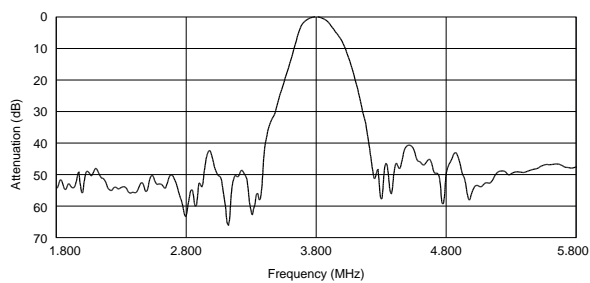

SFSKB4M30GF00-R1

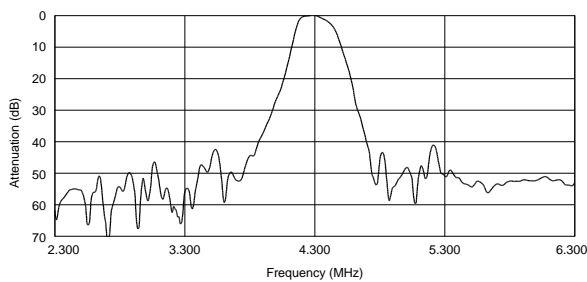

SFSKB4M80GF00-R1

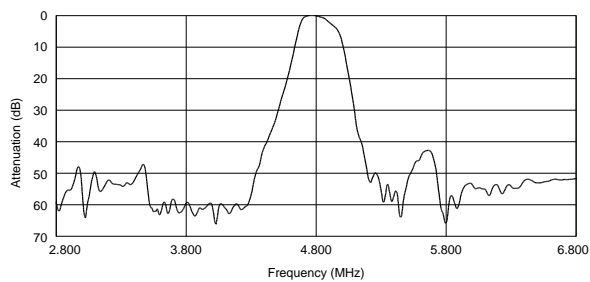

Continued from the preceding page.

Frequency Characteristics (Spurious)

SFSKB5M20GF00-R1

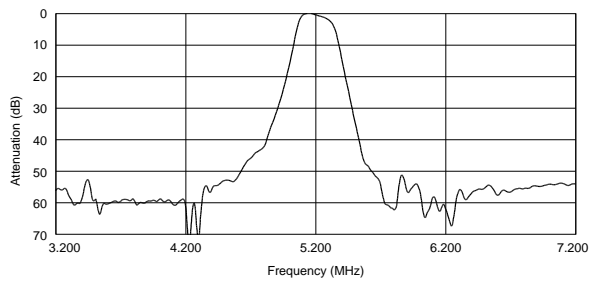

SFSKB5M70GF00-R1

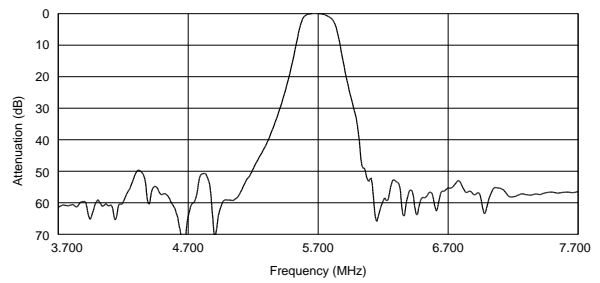

CERAFIL® (Filters/Traps/Discriminators) for Audio/Visual Equipment



CERAFIL® 455kHz Chip Type SFPKA Series

SFPKA series for AM use is one of the most recommendable intermediate filters, having such distinctive features as high selectivity, high stability and adjustment-free operation. Additionally its easy matching with IC helps create an easy circuit design.

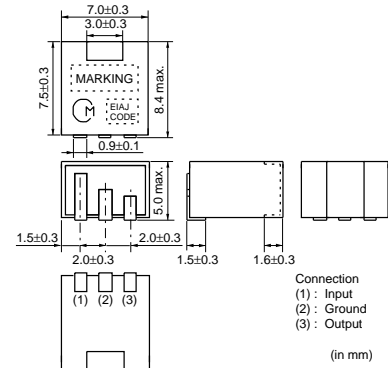

■ Features

1. The filters are mountable by automatic placers and can be reflow soldered and withstand washing.
2. The filters are wide bandwidth and high selectivity. So they are suitable for car radio and multi-band radio.

Part Number	Center Frequency (fo) (kHz)	6dB Bandwidth (kHz)	Selectivity (-) (dB)	Selectivity (+) (dB)	Insertion Loss (dB)	Input/Output Impedance (ohm)	Element
SFPKA450KH1A-R1	450.0 ±1.0kHz	fn±3.0 min.	40 min.[fn-9kHz]	40 min.[fn+9kHz]	6.0 max.	2000	4
SFPKA450KG1A-R1	450.0 ±1.0kHz	fn±4.5 min.	40 min.[fn-10kHz]	40 min.[fn+10kHz]	6.0 max.	1500	4

Area of Insertion Loss: at minimum loss point

Center frequency (fo) is defined by the center of 6dB bandwidth.

(fn) means nominal center frequency (450kHz).

For safety purposes, connect the output of filters to the IF amplifier through a D.C. blocking capacitor. Avoid applying a direct current to the output of ceramic filters.

The order quantity should be an integral multiple of the "Minimum Quantity" shown in the package page.

■ Standard Land Pattern Dimensions

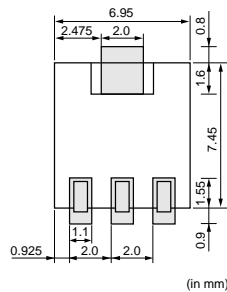

Recommended IFT

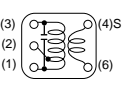
Item	Type	SFPKA		
		(1)—(2)	(2)—(3)	(4)—(6)
Winding Specification	 (Bottom view)	60T	125T	28T
No load Q_u		40		
Tuning Capacitance	180pF			

• Matching of CERAFIL® SFPKA series with IFT is decided by the Q_u of IFT and IFT secondary side impedance, $|Z_2|$. Set the Q_u at about 40 because a Q_u value which is too high (e.g., 90) may produce ripple in the waveform. It is recommended to match the impedance of $|Z_2|$ with that of the CERAFIL®.

Test Circuit

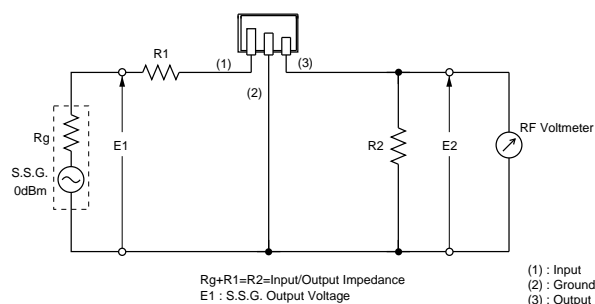

Frequency Characteristics

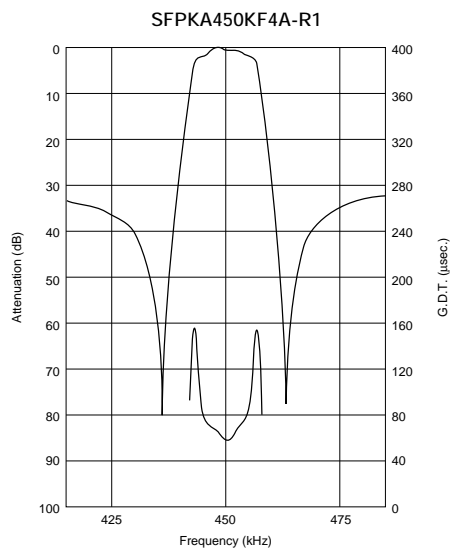
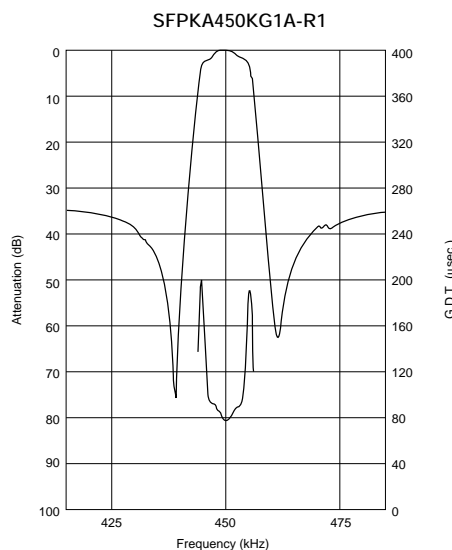
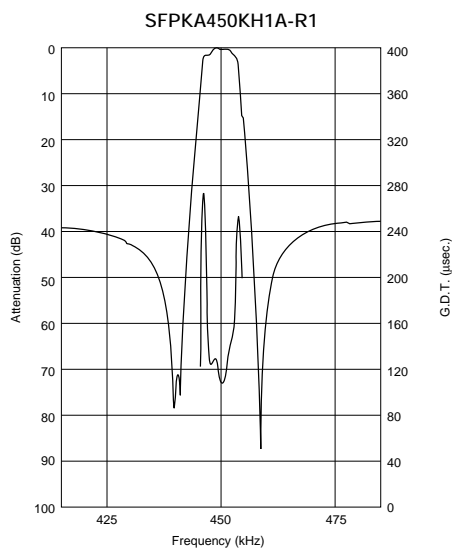

CERAFIL® (Filters/Traps/Discriminators) for Audio/Visual Equipment



CERAFIL® 455kHz SFULA/SFZLA Series

SFULA/SFZLA series for AM use is one of the most recommendable intermediate filters, having such distinctive features as high selectivity, high stability, and adjustment-free operation. Additionally its easy matching with IC helps create an easy circuit design.

■ Features

1. Center frequency range between 450 to 470kHz are available standard tolerance of ± 2 kHz.
2. For frequency synthesizers, center frequencies of 450, 459 and 468kHz are available standard tolerance of ± 1 kHz.



SFULA Series

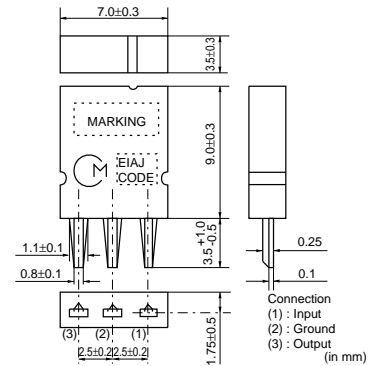

SFZLA Series

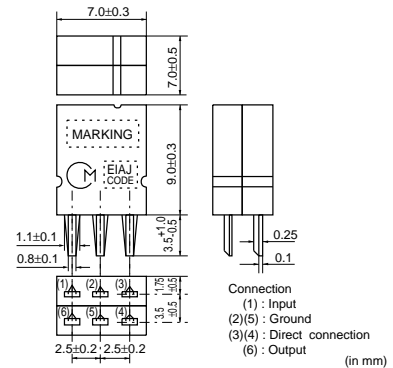

Part Number	Center Frequency (fo) (kHz)	3dB Bandwidth (kHz)	Selectivity (-) (dB)	Selectivity (+) (dB)	Insertion Loss (dB)	Input/Output Impedance (ohm)	Element
SFULA455KU2A-B0	455.0 ± 2.0 kHz	10.0 ± 3.0 kHz	6 min. [fo-10kHz]	4 min. [fo+10kHz]	5.0 max.	3000	1
SFULA455KU2B-B0	462.0 ± 2.0 kHz	10.0 ± 3.0 kHz	6 min. [fo-10kHz]	4 min. [fo+10kHz]	5.0 max.	3000	1
SFZLA455KN2A-B0	455.5 ± 2.0 kHz	4.0 ± 1.0 kHz	23 min. [fo-9kHz]	23 min. [fo+9kHz]	7.0 max.	3000	2
SFZLA455KS2A-B0	456.0 ± 2.0 kHz	5.5 ± 1.0 kHz	18 min. [fo-9kHz]	18 min. [fo+9kHz]	7.0 max.	3000	2
SFZLA455KT2A-B0	456.0 ± 2.0 kHz	7.0 ± 1.0 kHz	16 min. [fo-9kHz]	16 min. [fo+9kHz]	6.0 max.	3000	2

Area of Insertion Loss: at minimum loss point

Center frequency (fo) is defined by the center of 3dB bandwidth.

For safety purposes, connect the output of filters to the IF amplifier through a D.C. blocking capacitor. Avoid applying a direct current to the output of ceramic filters.

The order quantity should be an integral multiple of the "Minimum Quantity" shown in the package page.

■ Frequency Characteristics (CERAFIL® with IFT)

Part Number	6dB Band Width (kHz)	Selectivity		Input Level (at 0.6mV output) (dB)
		-9kHz off (dB)	+9kHz off (dB)	
IFT+SFULA455KU2B-B0	6.5	23	20	78
IFT+SFZLA455KN2A-B0	5.0		38	78
IFT+SFZLA455KS2A-B0	7.0		33	78
IFT+SFZLA455KT2A-B0	8.5		27	78

Typ. value

■ Recommended IFT

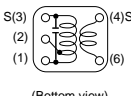
Item	Type	SFULA□B			SFZLA□A		
		7×7mm IFT					
Winding Specification	(1)–(2) (2)–(3) (4)–(6)	(1)–(2)	(2)–(3)	(4)–(6)	(1)–(2)	(2)–(3)	(4)–(6)
S(3) (2) (1)  (Bottom view)		70T	115T	7T	68T	84T	14T
No load Qu		105			90		
Tuning Capacitance		180pF			180pF		

• Matching of CERAFIL® SFULA/SFZLA series with IFT is decided by the IFT secondary side impedance, |Z₂|. The design target values of |Z₂| are:
 For SFULA□B : 300Ω
 For SFZLA□A : 1kΩ

■ Test Circuit (CERAFIL® Only)

SFULA Series

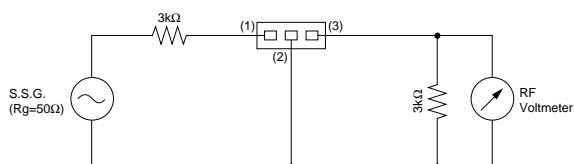

SFZLA Series

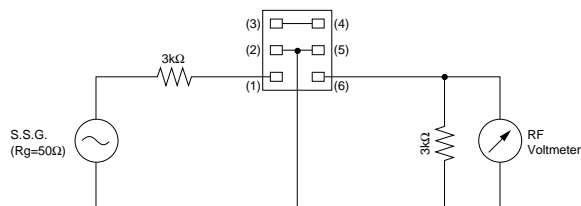

■ Test Circuit (CERAFIL® with IFT)

SFULA Series

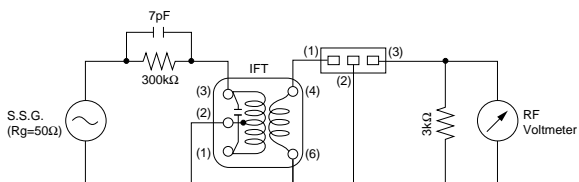

SFZLA Series

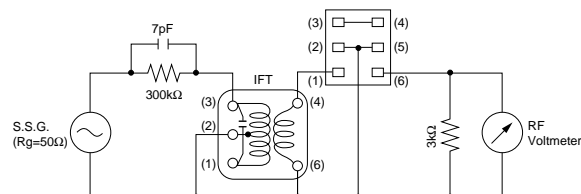

Frequency Characteristics

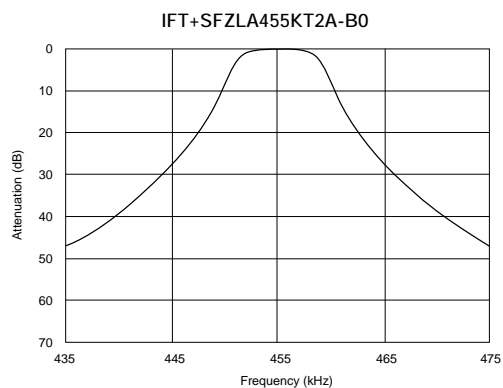
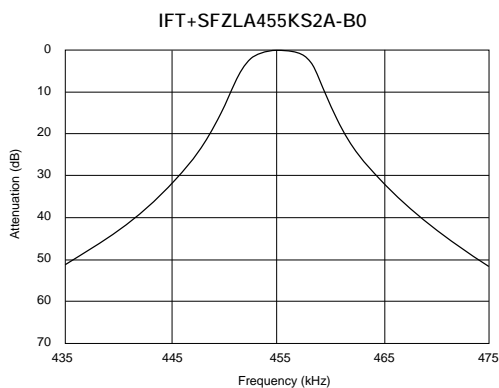
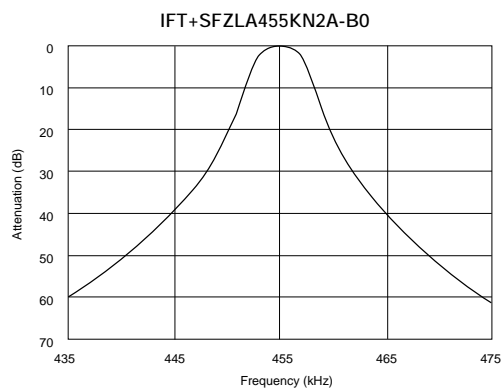
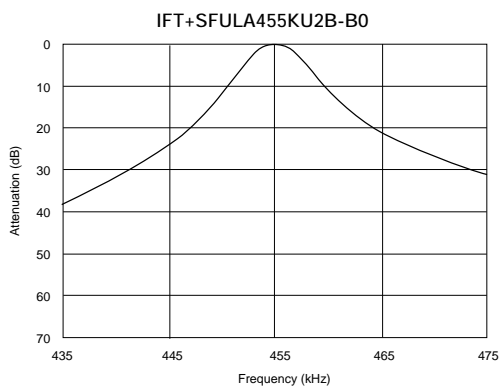

Frequency Characteristics (Spurious)

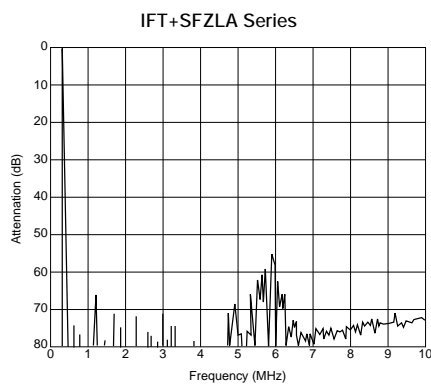
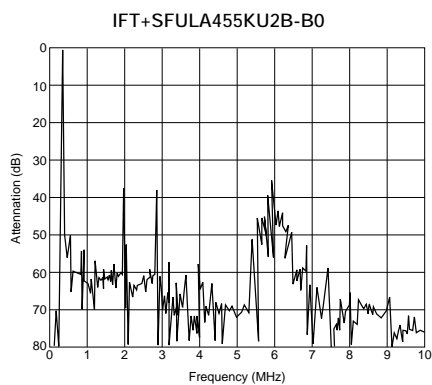

CERAFIL® (Filters/Traps/Discriminators) for Audio/Visual Equipment



CERAFIL® 455kHz SFPLA/CFWLA Series

SFPLA/CFWLA series for AM use is one of the most suitable intermediate filters, having such distinctive features as high selectivity, high stability, high attenuation, and adjustment-free operation. Additionally its easy matching with IC helps create an easy circuit design. This is the most suitable for car-stereo and all band radio with high attenuation.



SFPLA Series

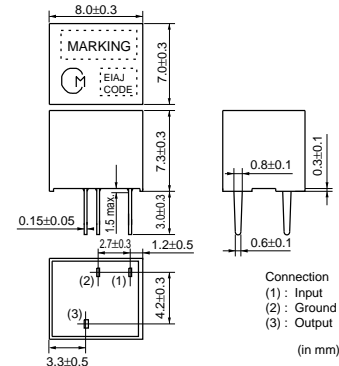

CFWLA Series

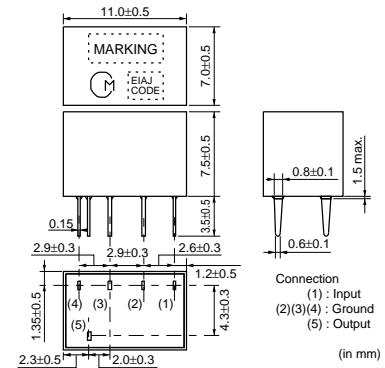

Part Number	Center Frequency (fo) (kHz)	6dB Bandwidth (kHz)	Selectivity (-) (dB)	Selectivity (+) (dB)	Insertion Loss (dB)	Input/Output Impedance (ohm)	Element
SFPLA450KJ1A-B0	450.0 ±1.0kHz	fn±2.0 min.	40 min.[fn-7.5kHz]	40 min.[fn+7.5kHz]	6.0 max.	2000	4
SFPLA450KH1A-B0	450.0 ±1.0kHz	fn±3.0 min.	40 min.[fn-9kHz]	40 min.[fn+9kHz]	6.0 max.	2000	4
CFWLA450KJFA-B0	450.0 (fn)	fn±2.0 min.	50 min.[fn-7.5kHz]	50 min.[fn+7.5kHz]	7.0 max.	2000	6
CFWLA450KHFA-B0	450.0 (fn)	fn±3.0 min.	50 min.[fn-9kHz]	50 min.[fn+9kHz]	6.0 max.	2000	6

Area of Insertion Loss: at minimum loss point

Center frequency (fo) is defined by the center of 6dB bandwidth.

(fn) means nominal center frequency (450kHz).

For safety purposes, connect the output of filters to the IF amplifier through a D.C. blocking capacitor. Avoid applying a direct current to the output of ceramic filters.

The order quantity should be an integral multiple of the "Minimum Quantity" shown in the package page.

14

Recommended IFT

Item	Type	SFPLA/CFULA/CFWLA		
		7x7mm IFT		
Winding Specification		(1)—(2)	(2)—(3)	(4)—(6)
S(3) (2) (1) (Bottom view)		60T	125T	28T
No load Qu		40		
Tuning Capacitance		180pF		

• Matching of CERAFIL® SFPLA/CFULA/CFWLA series with IFT is decided by the Qu of IFT and IFT secondary side impedance, |Z2|. Set the Qu at about 40 because a Qu value which is too high (e.g., 90) may produce ripple in the waveform. It is recommended to match the impedance of |Z2| with that of the CERAFIL®.

Test Circuit

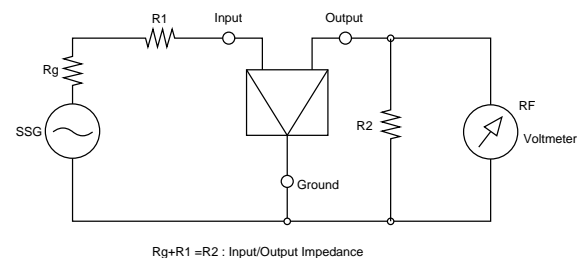

Continued on the following page. ↗

Continued from the preceding page.

Frequency Characteristics

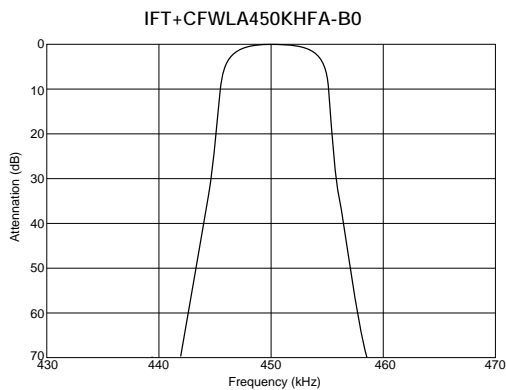
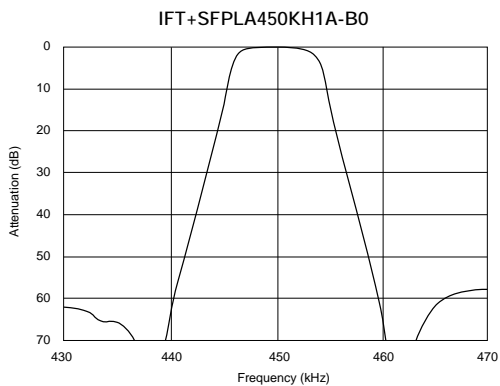

Frequency Characteristics (Spurious)

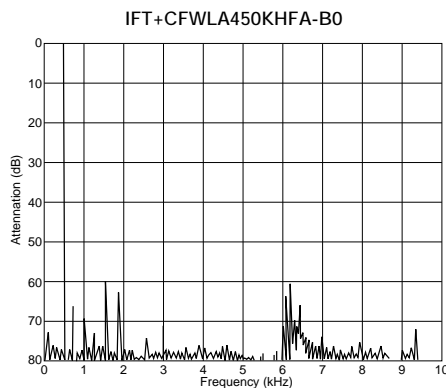
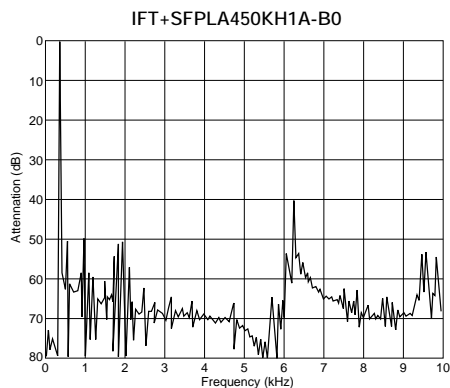

CERAFIL® (Filters/Traps/Discriminators) for Audio/Visual Equipment



CERAFIL® 455kHz for AM Stereo Wide Bandwidth Type SFPLA/CFWLA/CFULA Series

SFPLA/CFULA/CFWLA series for AM use is one of the most suitable intermediate filters, having such distinctive features as high selectivity, high stability, high attenuation, and adjustment-free operation. Additionally its easy matching with IC helps create an easy circuit design. Especially, CFULA/CFWLA_Y series is the frequency fidelity in the high sound area of an AM stereo will be improved with wide band, flat group delay time characteristics.



SFPLA Series

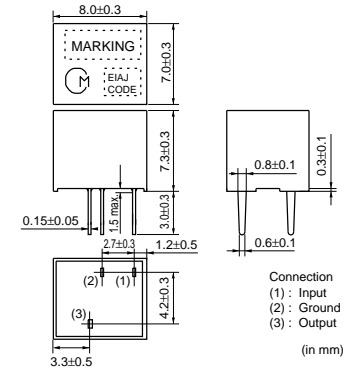

CFWLA Series

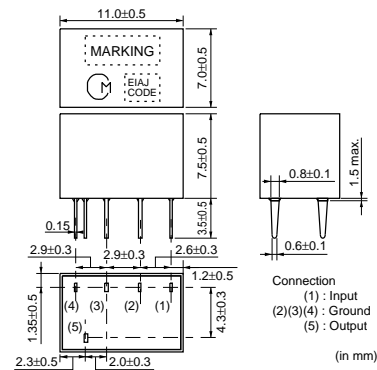

CFULA Series

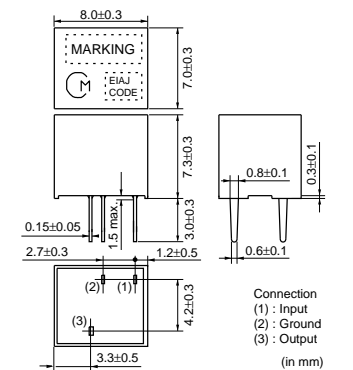

Part Number	Center Frequency (fo) (kHz)	6dB Bandwidth (kHz)	Selectivity (-) (dB)	Selectivity (+) (dB)	Insertion Loss (dB)	GDT 20μsec. Bandwidth (kHz)	Input/Output Impedance (ohm)	Element
SFPLA450KG1A-B0	450.0 ±1.0kHz	fn±4.5 min.	30 min. [fn-9kHz]	30 min. [fn+9kHz]	6.0 max.	-	2000	4
SFPLA450KF1A-B0	450.0 ±1.0kHz	fn±6.0 min.	40 min. [fn-12.5kHz]	40 min. [fn+12.5kHz]	6.0 max.	-	2000	4
SFPLA450KE1A-B0	450.0 ±1.0kHz	fn±7.5 min.	40 min. [fn-15kHz]	40 min. [fn+15kHz]	6.0 max.	-	1500	4
SFPLA450KD1A-B0	450.0 ±1.0kHz	fn±10.0 min.	40 min. [fn-20kHz]	40 min. [fn+20kHz]	4.0 max.	-	1500	4
CFULA450KG1Y-B0	450.0 ±1.0kHz	fn±4.5 min.	40 min. [fn-15kHz]	40 min. [fn+15kHz]	10.0 max.	fn±3	2000	4
CFULA450KF1Y-B0	450.0 ±1.0kHz	fn±6.0 min.	40 min. [fn-17.5kHz]	40 min. [fn+17.5kHz]	9.0 max.	fn±4	2000	4
CFULA450KD1Y-B0	450.0 ±1.0kHz	fn±10.0 min.	40 min. [fn-25kHz]	40 min. [fn+25kHz]	7.0 max.	fn±7	1500	4
CFWLA450KG1Y-B0	450.0 ±1.0kHz	fn±4.5 min.	50 min. [fn-15kHz]	50 min. [fn+15kHz]	11.0 max.	fn±4	2000	6
CFWLA450KF1Y-B0	450.0 ±1.0kHz	fn±6.0 min.	50 min. [fn-17.5kHz]	50 min. [fn+17.5kHz]	10.0 max.	fn±5	2000	6
CFWLA450KD1Y-B0	450.0 ±1.0kHz	fn±10.0 min.	50 min. [fn-25kHz]	50 min. [fn+25kHz]	8.0 max.	fn±8	1500	6
CFWLA450KGFA-B0	450.0 (fn)	fn±4.5 min.	50 min. [fn-10kHz]	50 min. [fn+10kHz]	6.0 max.	-	2000	6
CFWLA450KFFA-B0	450.0 (fn)	fn±6.0 min.	50 min. [fn-12.5kHz]	50 min. [fn+12.5kHz]	6.0 max.	-	2000	6
CFWLA450KEFA-B0	450.0 (fn)	fn±7.5 min.	50 min. [fn-15kHz]	50 min. [fn+15kHz]	6.0 max.	-	1500	6
CFWLA450KDFAB0	450.0 (fn)	fn±10.0 min.	50 min. [fn-20kHz]	50 min. [fn+20kHz]	4.0 max.	-	1500	6

Area of Insertion Loss: at minimum loss point
 Center frequency (fo) is defined by the center of 6dB bandwidth.
 (fn) means nominal center frequency (450kHz).
 For safety purposes, connect the output of filters to the IF amplifier through a D.C. blocking capacitor. Avoid applying a direct current to the output of ceramic filters.
 The order quantity should be an integral multiple of the "Minimum Quantity" shown in the package page.

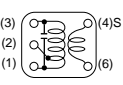

Recommended IFT

Item	Type	SFPLA/CFULA/CFWLA		
		7x7mm IFT		
Winding Specification		(1)—(2)	(2)—(3)	(4)—(6)
	 (Bottom view)	60T	125T	28T
No load Q_u		40		
Tuning Capacitance		180pF		

• Matching of CERAFIL® SFPLA/CFULA/CFWLA series with IFT is decided by the Q_u of IFT and IFT secondary side impedance, [Z2]. Set the Q_u at about 40 because a Q_u value which is too high (e.g., 90) may produce ripple in the waveform. It is recommended to match the impedance of [Z2] with that of the CERAFIL®.

Test Circuit

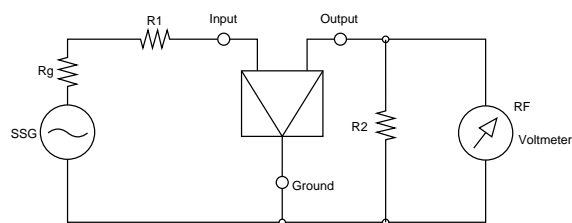

$R_g + R_1 = R_2$: Input/Output Impedance

Frequency Characteristics

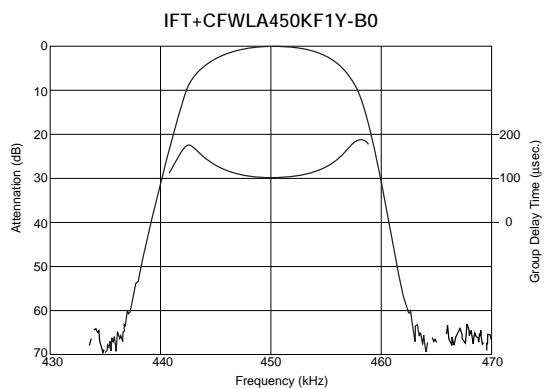
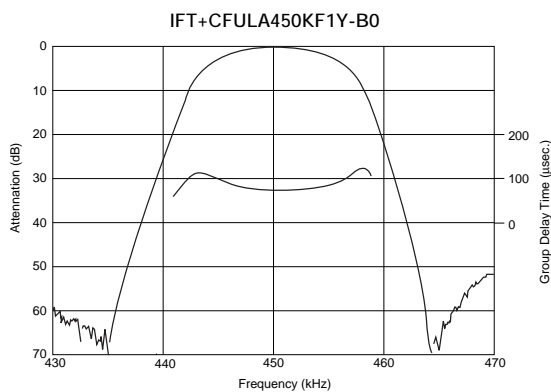
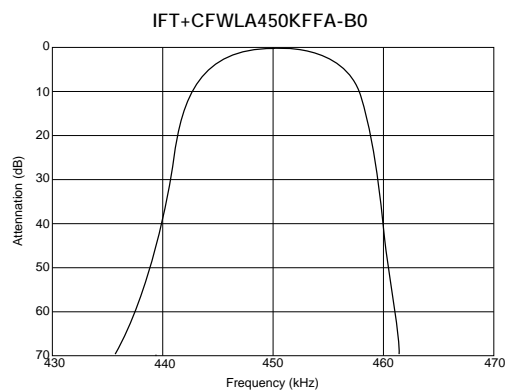
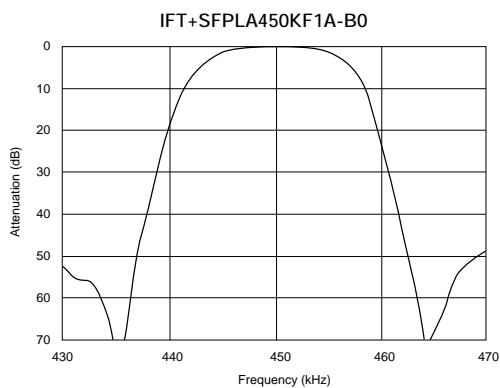

CERAFIL[®] 455kHz SF□ Series Temperature Characteristics

■ SFZLA455KS2A-B0

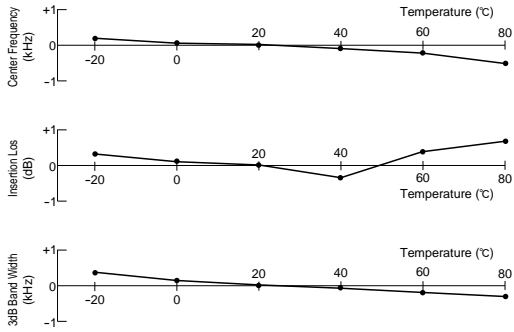

■ SFPLA450KH1A-B0

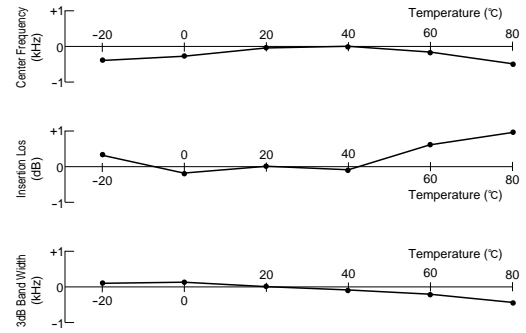

CERAFIL® 455kHz SF□ Series Application Circuit

■ Portable Radio

SFULA455KU2B-B0

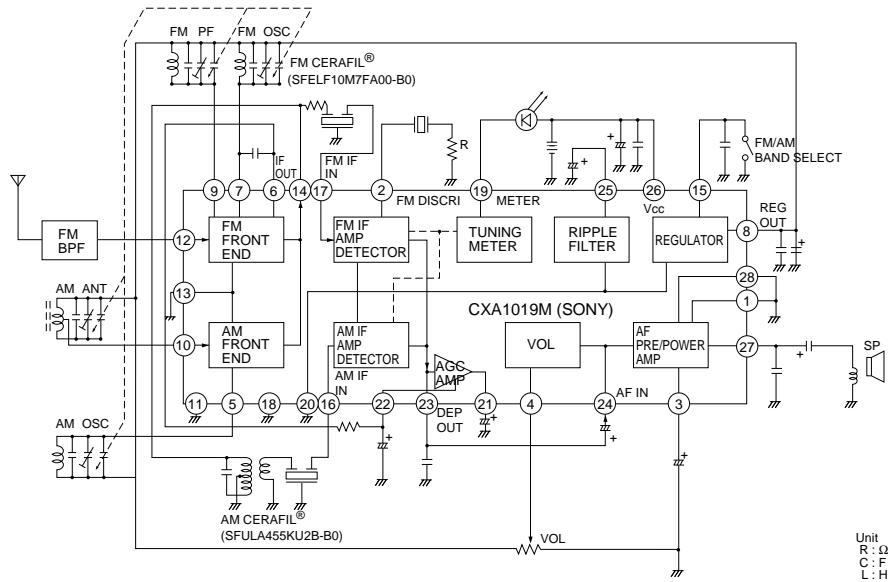

SFULA455KU2B-B0

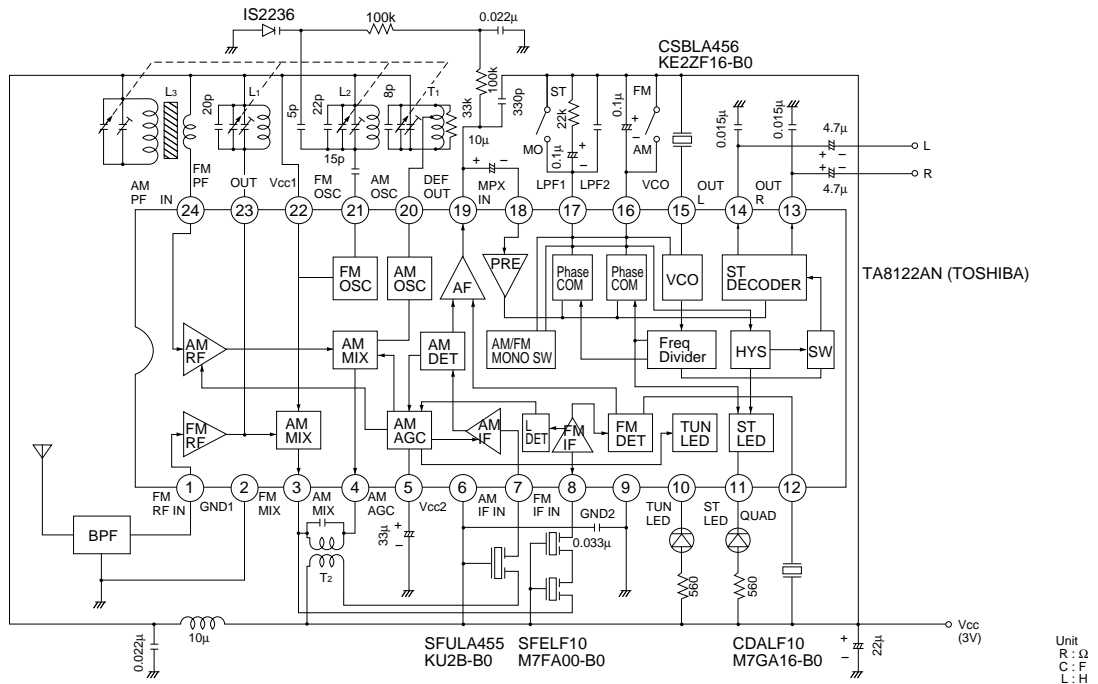

CERAFIL® (Filters/Traps/Discriminators) for Audio/Visual Equipment



Ceramic Trap 4.5-6.5MHz Chip Type TPSKA Series

SMD ceramic trap TPSKA_B is small and thin SMD trap sealed with a metal cap. Recommended for LCD-TV's, and small and thin tuners.

■ Features

1. High attenuation and high performance group delay time
2. Small and thin package
3. Reflow-solderable

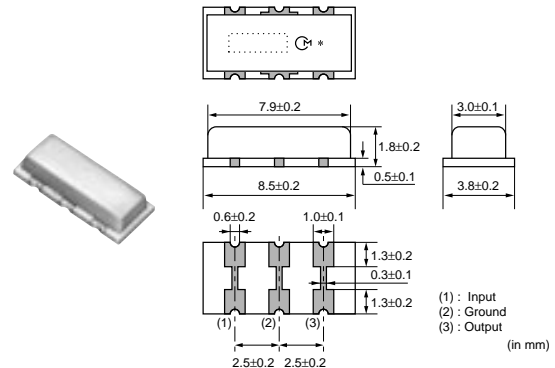

Part Number	Nominal Center Frequency (fn1) (MHz)	Attenuation (at fn1) (dB)	30dB Attenuation BW (fn1) (kHz)
TPSKA4M50B00-R3	4.500	35 min.	50 min.
TPSKA5M50B00-R3	5.500	35 min.	70 min.
TPSKA6M00B00-R3	6.000	35 min.	70 min.
TPSKA6M50B00-R3	6.500	35 min.	70 min.

For safety purposes, connect the output of filters to the IF amplifier through a D.C. blocking capacitor. Avoid applying a direct current to the output of ceramic filters. The order quantity should be an integral multiple of the "Minimum Quantity" shown in the package page.

■ Standard Land Pattern Dimensions

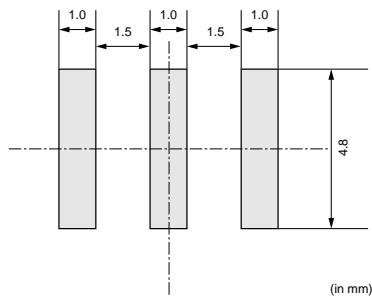

■ Test Circuit

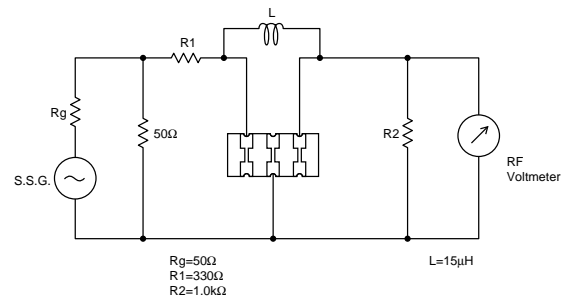

■ Frequency Characteristics

TPSKA4M50B00-R1

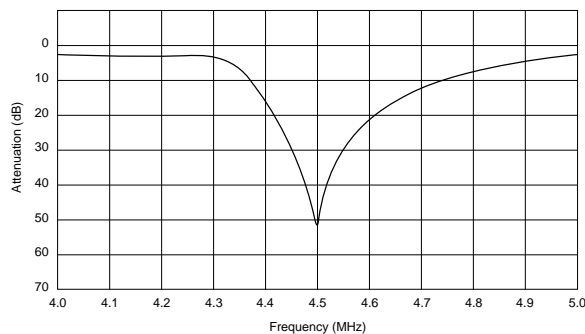

TPSKA5M50B00-R1

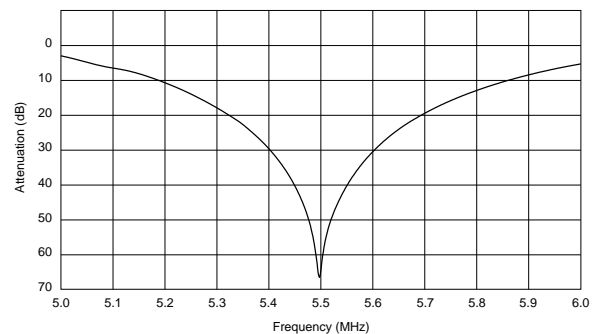

Continued on the following page. ↗

☐ Continued from the preceding page.

■ Frequency Characteristics

TPSKA6M00B00-R1

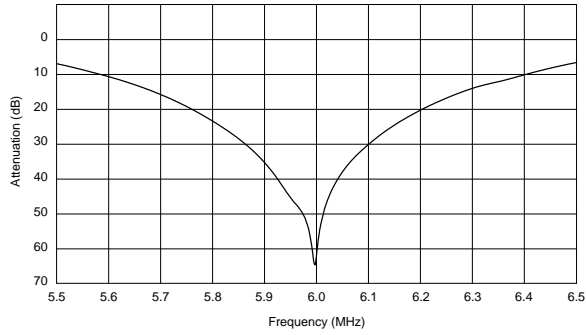

TPSKA6M50B00-R1

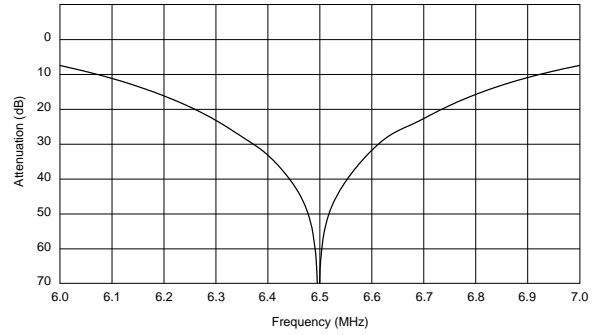

■ Frequency Characteristics (Spurious)

TPSKA4M50B00-R1

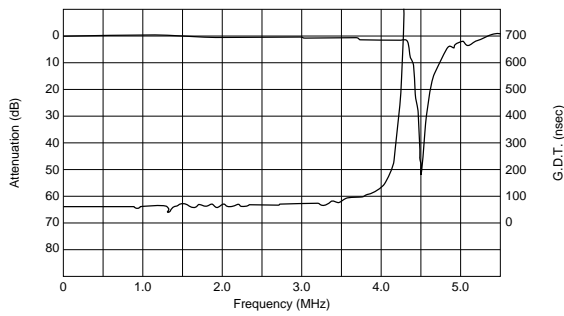

TPSKA5M50B00-R1

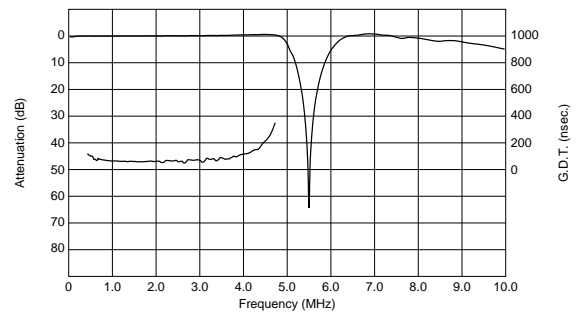

TPSKA6M00B00-R1

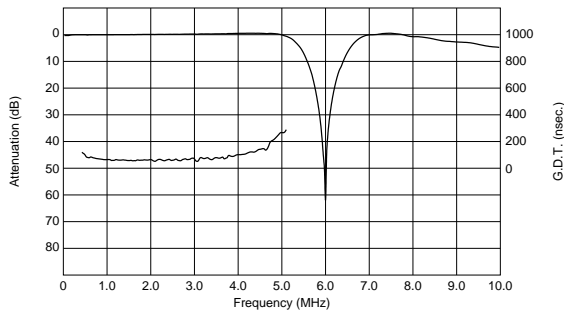

TPSKA6M50B00-R1

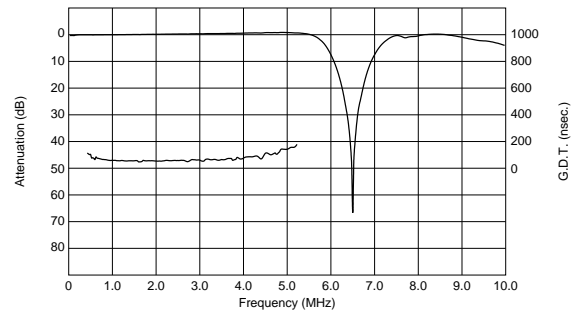

CERAFIL® (Filters/Traps/Discriminators) for Audio/Visual Equipment



Ceramic Trap 4.5-6.5MHz Chip Type Double Traps TPWKA Series

SMD ceramic trap TPWKA is small and thin SMD trap sealed with a metal cap. Recommended for LCD-TV's, and small and thin tuners.

This series consists of 2 wafers with 2 trap frequencies. Recommended for multi-standard set.

■ Features

1. Good performance of attenuation
2. Small and thin package
3. Reflow-solderable

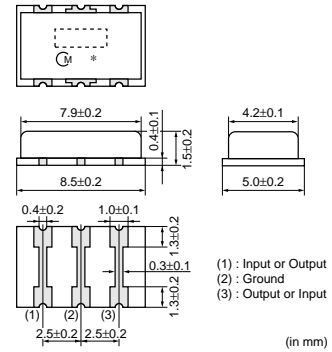

Part Number	Nominal Center Frequency (fn1) (MHz)	Nominal Center Frequency (fn2) (MHz)	Attenuation (at fn1) (dB)	Attenuation (at fn2) (dB)	30dB Attenuation BW (fn1) (kHz)
TPWKA5M50B04-R1	5.500	5.742	30 min.	30 min.	50 min.

For safety purposes, connect the output of filters to the IF amplifier through a D.C. blocking capacitor. Avoid applying a direct current to the output of ceramic filters. The order quantity should be an integral multiple of the "Minimum Quantity" shown in the package page.

■ Standard Land Pattern Dimensions

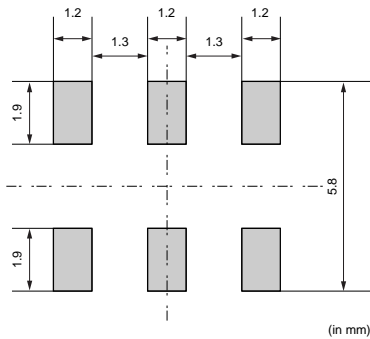

■ Test Circuit

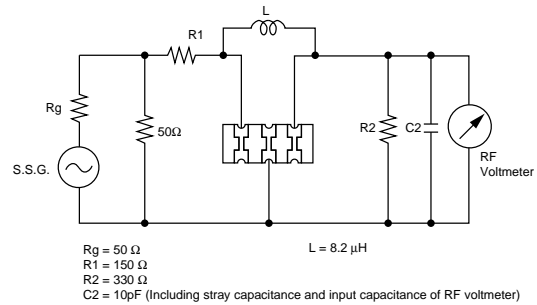

■ Frequency Characteristics

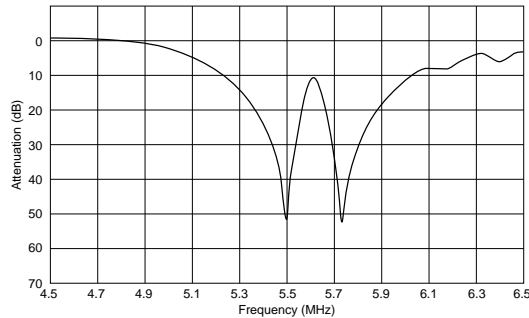

■ Frequency Characteristics (Spurious)

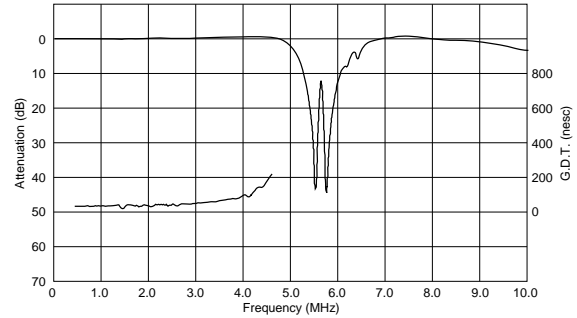

CERAFIL® (Filters/Traps/Discriminators) for Audio/Visual Equipment



Ceramic Discriminator 10.7MHz Ultra Thin Chip Type CDSCB Series

CDSCB10M7 series forms a resonator on a piezoelectric ceramic substrate. In combination with ICs, this type obtains stable demodulation characteristics in a wide bandwidth.
 They have 1.0mm max. thickness and small mounting area (4.5x2.0mm).

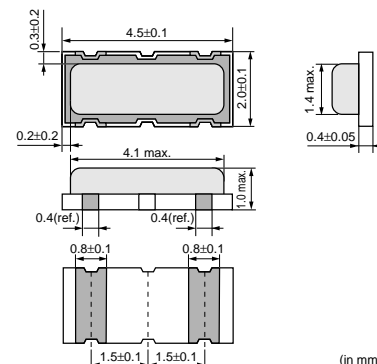

■ Features

1. Compact and high reliability and recommended for automotive applications.
2. Can be combined with various ICs. The IC is determined by the last number in the part number.
3. Stable demodulation characteristics can be obtained without adjustment.
4. Stable temperature characteristics
5. Available lead (Pb) free solder reflow.

Part Number	Center Frequency (fo) (MHz)	Recovered Audio 3dB BW (kHz)	Recovered Audio Output (mV)	Distortion (%)	S Curve (mV)	IC
CDSCB10M7GA105A-R0	10.700 ±30kHz	220 min.	110 min.	1.5 max.	-	TEA5757HL
CDSCB10M7GA113-R0	10.700 ±30kHz	300 min.	110 min.	1.0 max.	-	TA2154FN
CDSCB10M7GA119-R0	10.700 ±30kHz	500 min.	75 min.	1.0 max.	-	TRF6901
CDSCB10M7GA121-R0	10.700 ±30kHz	390 min.	80 min.	1.0 max.	-	LV23100V
CDSCB10M7GA135-R0	10.700 ±30kHz	155 min.	75 min.	-	-	TH71101
CDSCB10M7GA136-R0	10.700 ±30kHz	140 min.	120 min.	-	-	TH7122
CDSCB10M7GF072-R0	10.700 (fn)	fn±150 min.	130 min.	2.0 max.	-	TA31161
CDSCB10M7GF107S-R0	10.700 (fn)	fn±80 min.	52 min.	3.0 max.	-	TA31272FN
CDSCB10M7GF109-R0	10.700 (fn)	fn±100 min.	170 min.	3.0 max.	-	TK14588V
CDSCB10M7GF123-R0	10.700 (fn)	-	-	-	900 min.	TA31275FN
CDSCB10M7GF123S-R0	10.700 (fn)	-	-	-	900 min.	TA31275FN
CDSCB10M7GF126-R0	10.700 (fn)	-	-	-	400 min.	NJM2295AV

(fn) means nominal center frequency (10.700MHz).

For safety purposes, avoid applying a direct current between the terminals.

The order quantity should be an integral multiple of the "Minimum Quantity" shown in the package page.

■ Standard Center Frequency Rank Code

CODE	30kHz Step	25kHz Step
D	10.64MHz±30kHz	10.650MHz±25kHz
B	10.67MHz±30kHz	10.675MHz±25kHz
A	10.70MHz±30kHz	10.700MHz±25kHz
C	10.73MHz±30kHz	10.725MHz±25kHz
E	10.76MHz±30kHz	10.750MHz±25kHz
Z	Combination A, B, C, D, E	
M	Combination A, B, C	

Continued on the following page. ↗

Continued from the preceding page.

Standard Land Pattern Dimensions

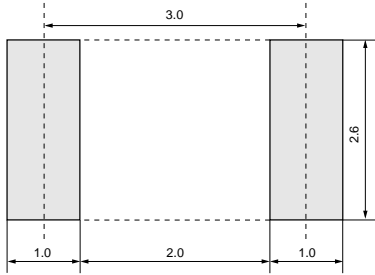

(in mm)

Test Circuit

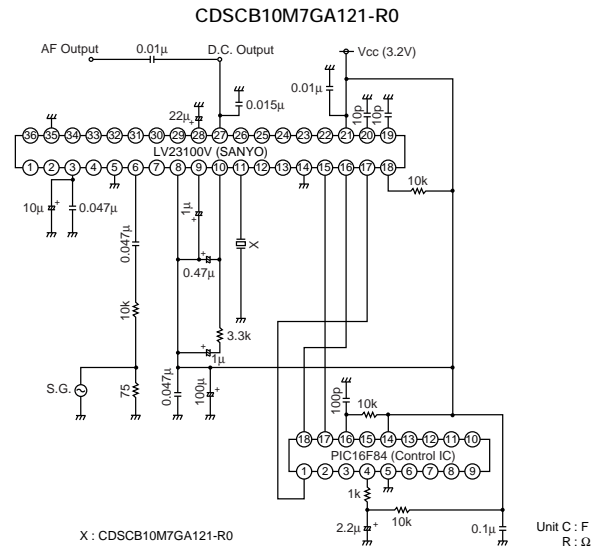
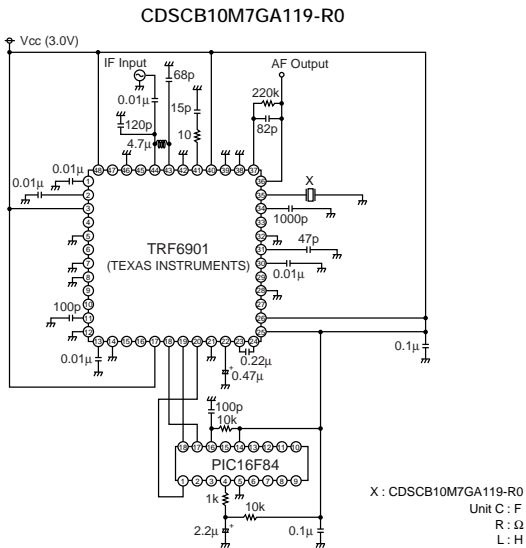
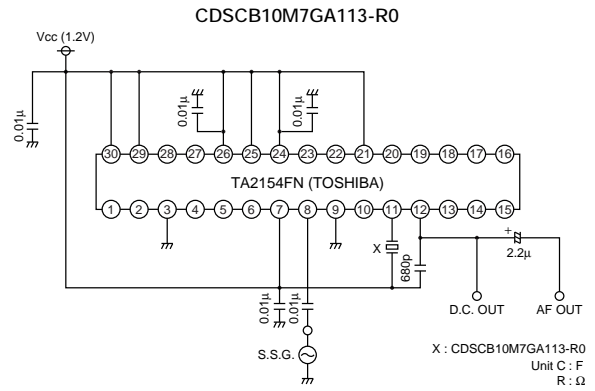
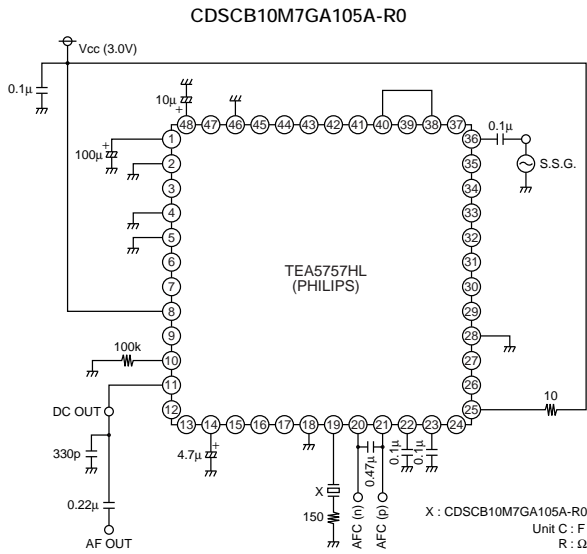

Continued on the following page. ↗

Continued from the preceding page.

Test Circuit

CDSCB10M7GA135-R0

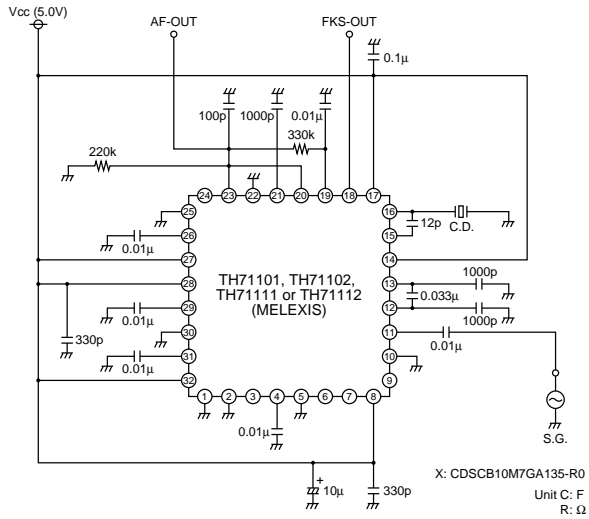

CDSCB10M7GA136-R0

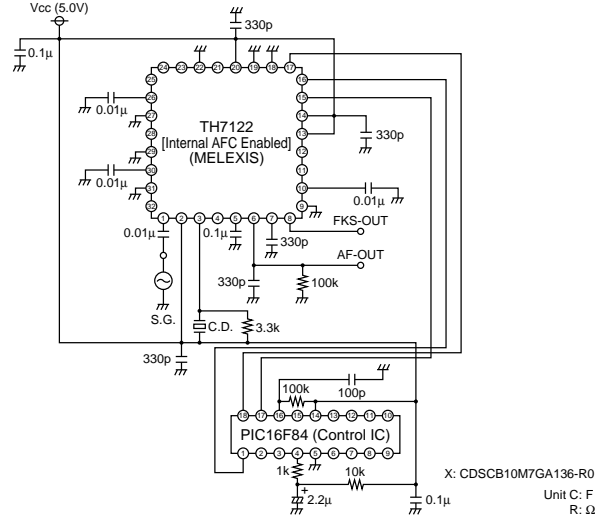

CDSCB10M7GF072-R0

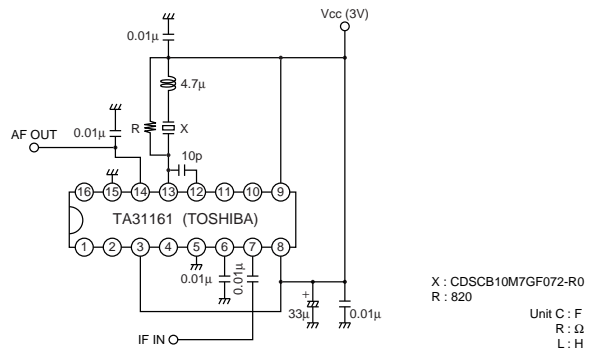

CDSCB10M7GF109-R0

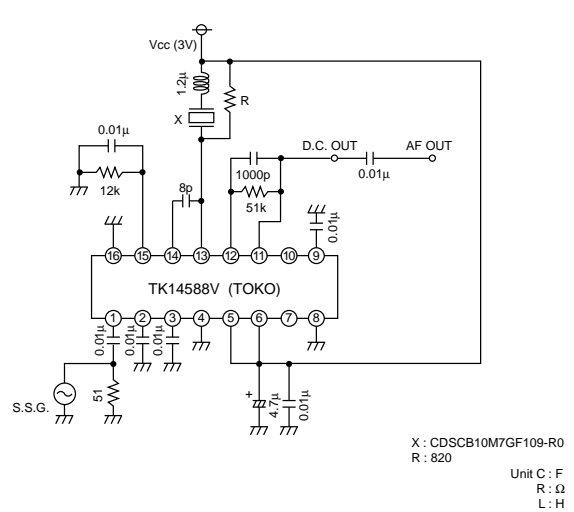

CDSCB10M7GF123-R0

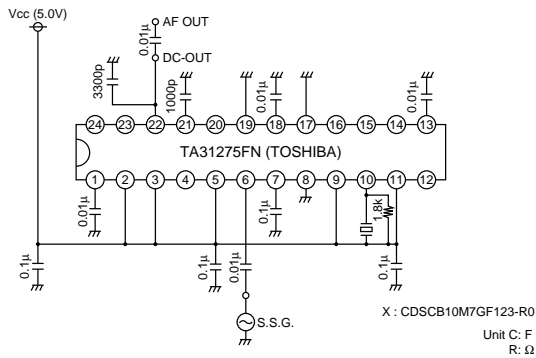

CDSCB10M7GF126-R0

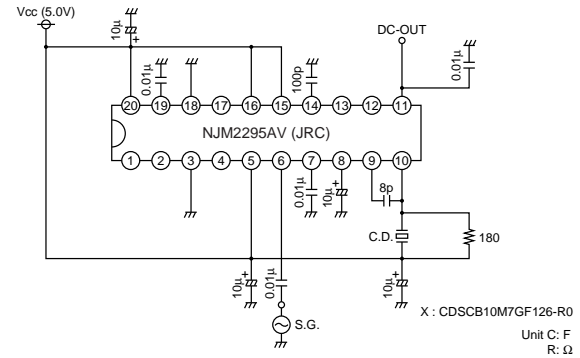

■ Recovered Audio Curve

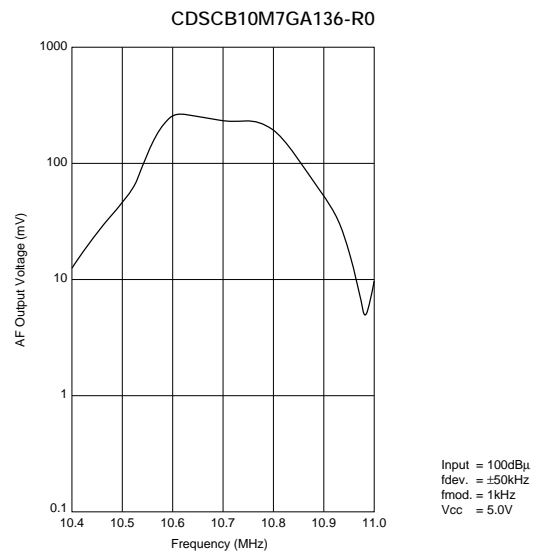
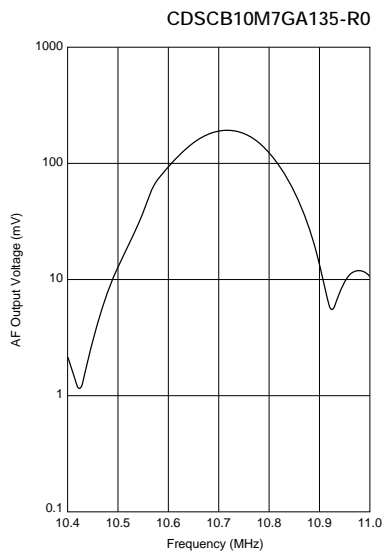
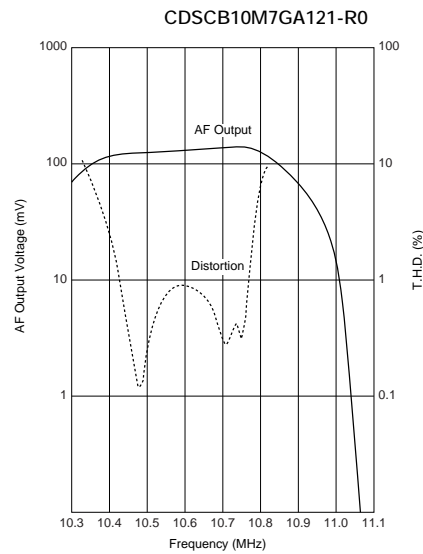
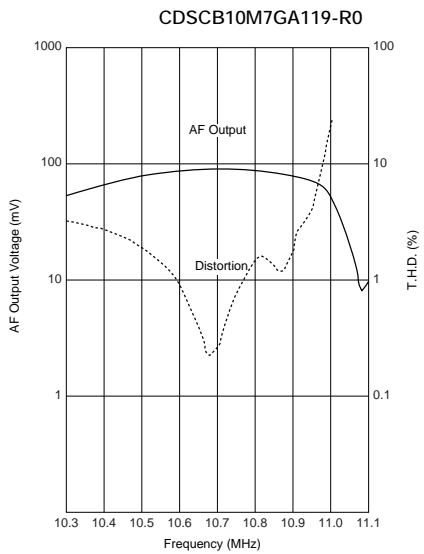
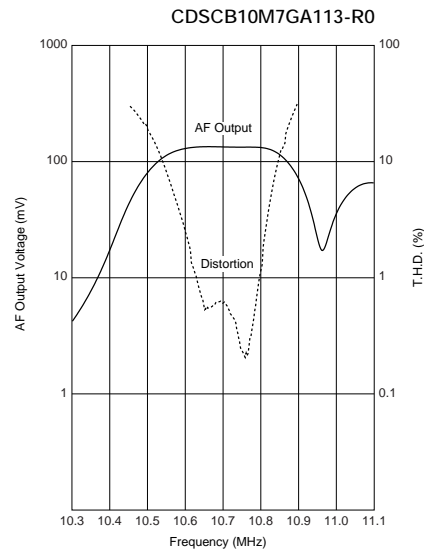
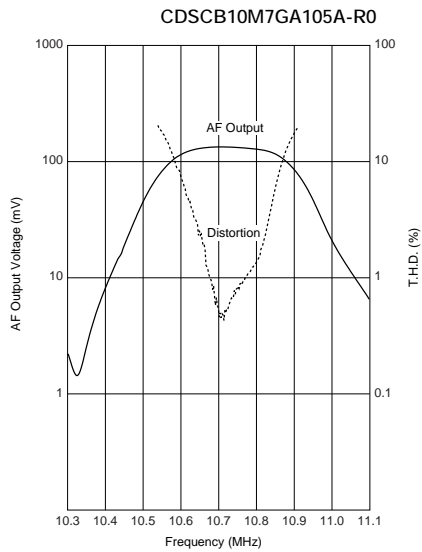

Continued from the preceding page.

Recovered Audio Curve

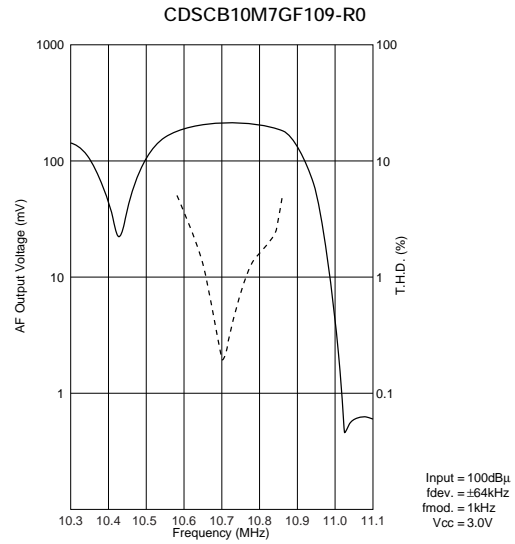
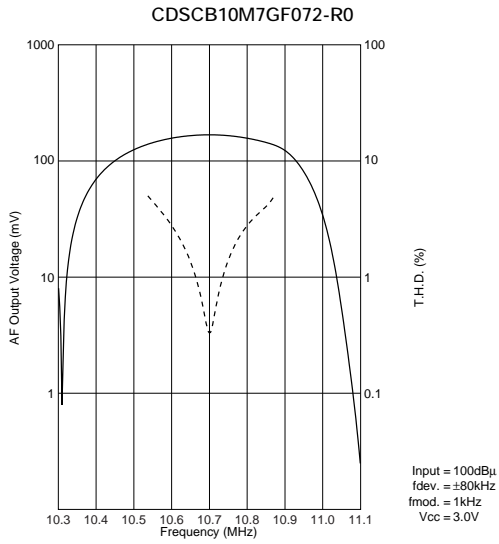

S Curve

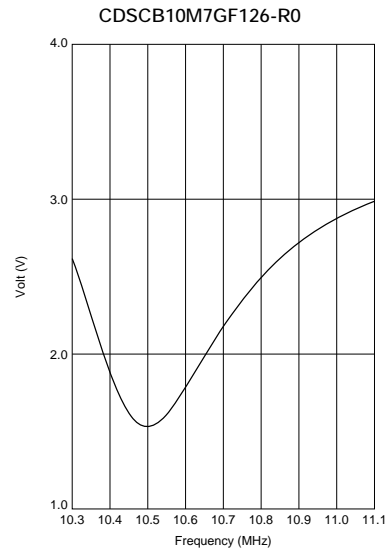
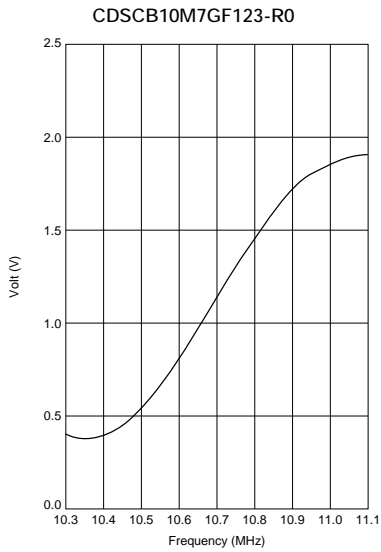

CERAFIL® (Filters/Traps/Discriminators) for Audio/Visual Equipment



Ceramic Discriminator 10.7MHz Standard Lead Type CDALF Series

CDALF10M7 series forms a resonator on a piezoelectric ceramic substrate. In combination with ICs, this type obtains stable demodulation characteristics in wide bandwidths.
 As part of the environment protection activity, solder for terminal plating and terminal-element connection inside of ceramic filter contain no lead (Pb).

■ Features

1. Compact and excellent mechanical strength
2. Can be combined with various ICs. The IC is determined by the last number in the part number.
3. Stable demodulation characteristics can be obtained without adjustment.
4. Stable temperature characteristics
5. Recommended combination: ceramic discriminator CDALF10M7 series and "CERAFIL" SFELF10M7 series of the same frequency rank.

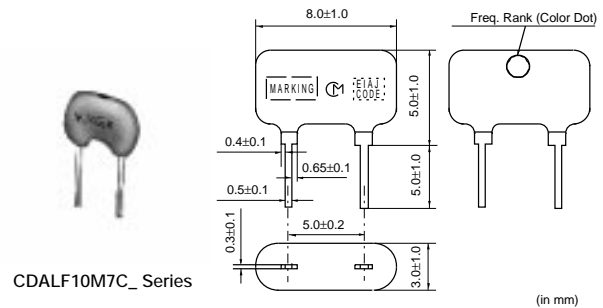
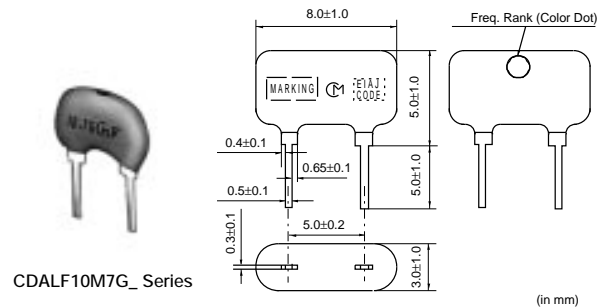

Part Number	Center Frequency (fo) (MHz)	Recovered Audio 3dB BW (kHz)	Recovered Audio Output (mV)	Distortion (%)	IC
CDALF10M7GA016-B0	10.700 ±30kHz	300 min.	within60 to 90mV	0.9 max.	TA8122F
CDALF10M7GA018-B0	10.700 ±30kHz	300 min.	within60 to 90mV	0.9 max.	TA8132N
CDALF10M7GA046-B0	10.700 ±30kHz	330 min.	280 min.	1.0 max.	LA1832
CDALF10M7GA048-B0	10.700 ±30kHz	400 min.	700 min.	1.0 max.	LA1835
CDALF10M7GA092-B0	10.700 ±30kHz	300 min.	60 min.	1.0 max.	TA2132P
CDALF10M7CA005A-B0	10.700 ±30kHz	100 min.	600 min.	6.0 max.	LA7770
CDALF10M7CA040-B0	10.700 ±30kHz	130 min.	40 min.	0.7 max.	TEA5710

For safety purposes, avoid applying a direct current between the terminals.
 The order quantity should be an integral multiple of the "Minimum Quantity" shown in the package page.
 CDALF10M7GA018-B0: Color dot is different from standard series.

■ Standard Center Frequency Rank Code

CODE	30kHz Step	25kHz Step	Color Code
D	10.64MHz±30kHz	10.650MHz±25kHz	Black
B	10.67MHz±30kHz	10.675MHz±25kHz	Blue
A	10.70MHz±30kHz	10.700MHz±25kHz	Red
C	10.73MHz±30kHz	10.725MHz±25kHz	Orange
E	10.76MHz±30kHz	10.750MHz±25kHz	White
Z	Combination A, B, C, D, E		
M	Combination A, B, C		

■ Test Circuit

CDALF10M7GA016-B0

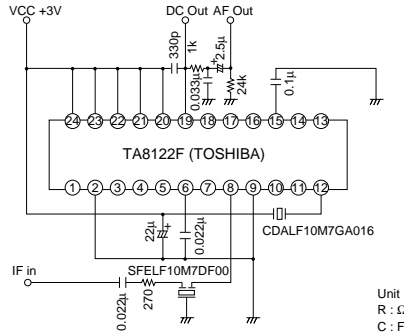

Unit
R : Ω
C : F

CDALF10M7GA018-B0

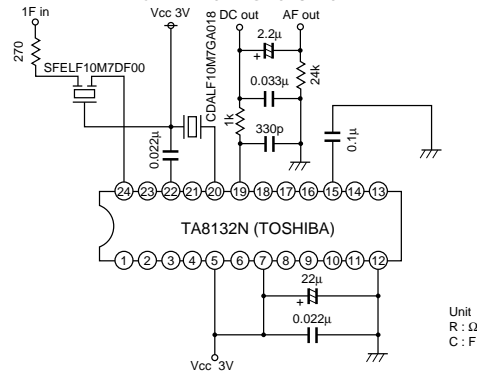

Unit
R : Ω
C : F

CDALF10M7GA046-B0

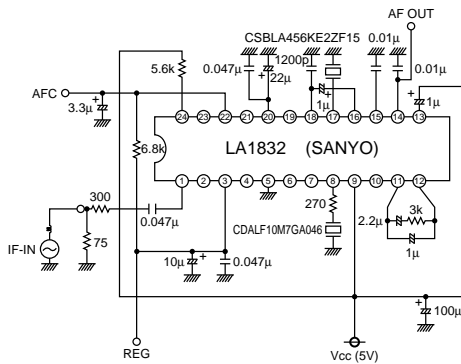

Unit
R : Ω
C : F

CDALF10M7GA048-B0

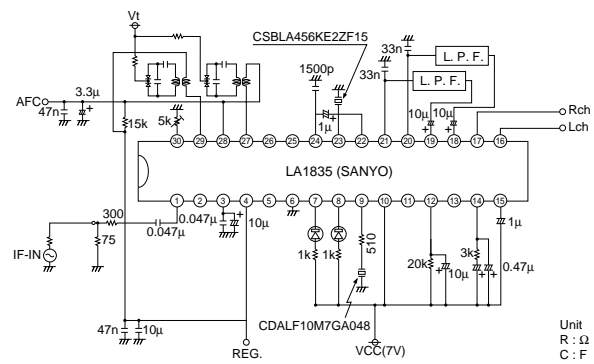

Unit
R : Ω
C : F

CDALF10M7GA092-B0

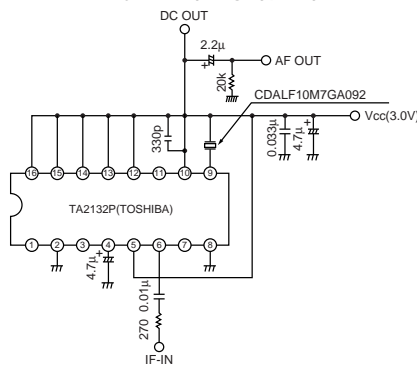

Unit
R : Ω
C : F

CDALF10M7CA005A-B0

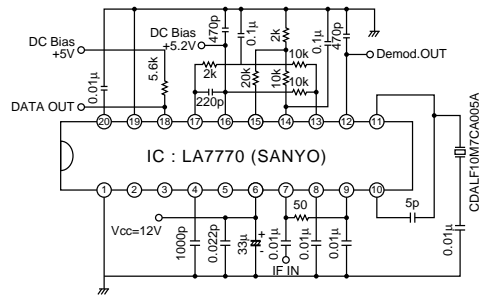

Unit
R : Ω
C : F

CDALF10M7CA040-B0

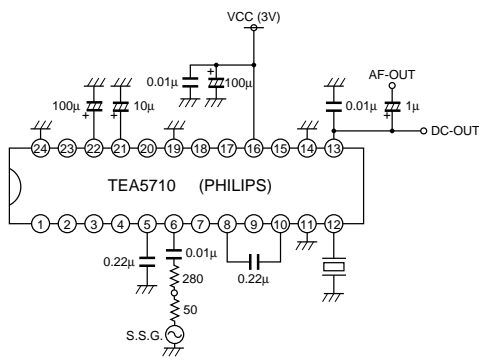

Unit
R : Ω
C : F

Frequency Characteristics

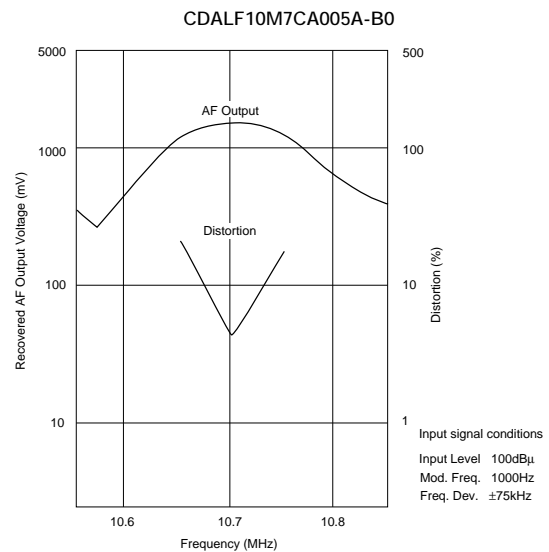
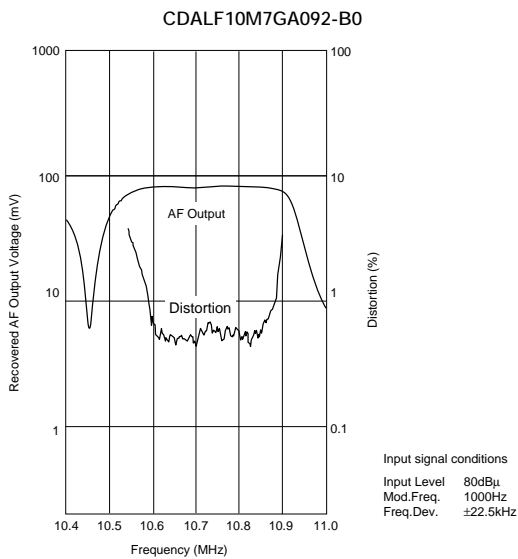
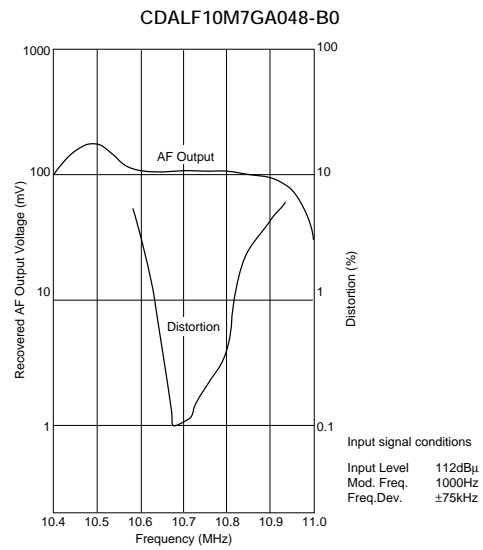
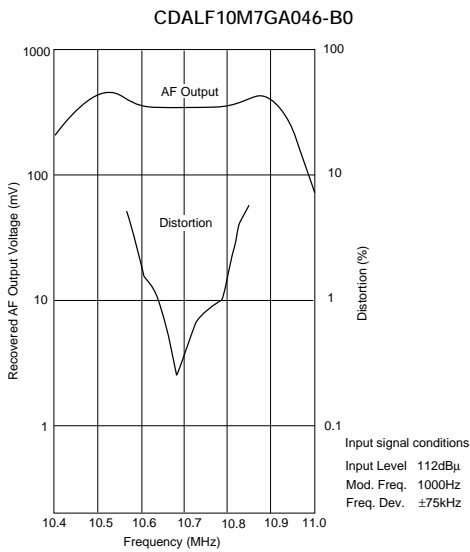
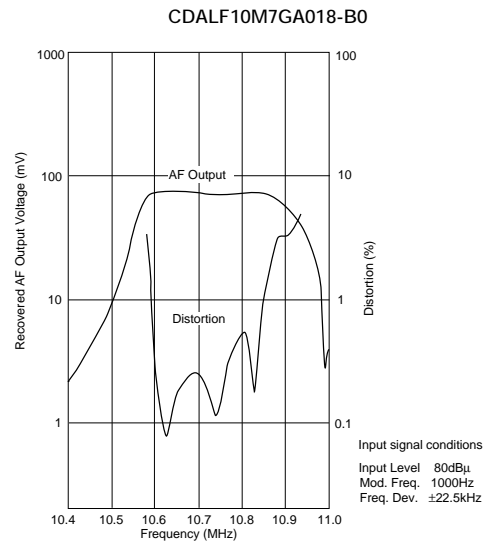
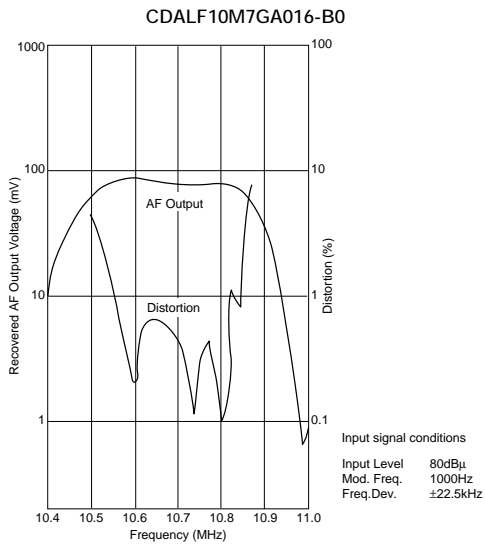

Continued from the preceding page.

Frequency Characteristics

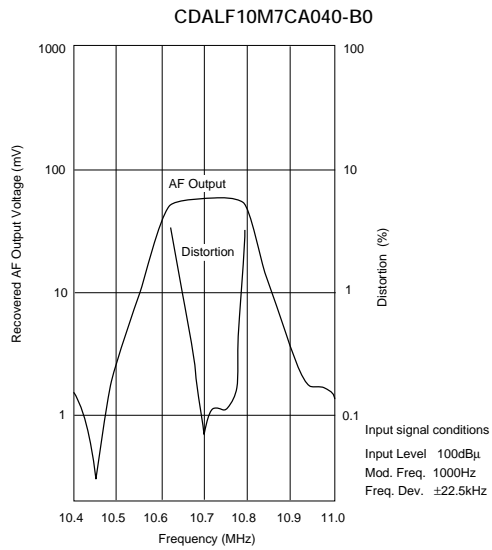

Ceramic Discriminator 10.7MHz Applied IC Reference Table

Please see following table for reference applied IC.

If you cannot find IC part number you are seeking, please contact our sales representative.

ex. : CDALF10M7GA016-B0

Suffix Number

CDSCB10M7GA105A-R0

Suffix Number

IC Manufacturer	IC Part Number	Suffix Number
ATMEL	U2501B	028
	U2765B	095
	U4313B	081
	U4490B	034V
	U829B	025
INFINEON	TDA1576T	051
	TDA6160X	038
	TDA6160-2X	044
MATSUSHITA	AN6138SH	097
	AN7004	011
	AN7006S	014A
	AN7007SU	013
MOTOROLA	AN7232	053
	MC13156	049
	MC13158	073
	MC13173	052
NEC	MC3363	087
	μPC1391M	056
PHILIPS	NE604	020
	SA605	042
	SA626	047
	SA636DK	096
	SA639	085
	TBA120U	029
	TBA229-2	021A
	TDA1596T	120
	TDA2557	024
	TEA5591	017
	TEA5592	030
	TEA5594	035
	TEA5710	040
	TEA5712T	055
	TEA5757HL	105A
	TEA5762 / 5757	061
	UAA3220TS	098
RFMD	RF2905	111
	RF2925	104
ROHM	BA1440	019
	BA1448	060
	BA4110	066
	BA4220	041
	BA4230AF	005
	BA4234L	004
	BA4240L	067

IC Manufacturer	IC Part Number	Suffix Number
SAMSUNG	KA22425	089
	KA2244	059
	KA22901	090
	KA2292	063
	KA2295	064
	KA2297	091
	KA2298B	065
	KB22902	103
	S1A0903	118A
	SANYO	LA1150
LA1225M		108A
LA1260		007
LA1805		026
LA1810		022
LA1814M		115
LA1816		015
LA1822		094
LA1823		101
LA1827M		083
LA1830		037
LA1831		043
LA1832 / M		046
LA1833		086
LA1835 / M		048
LA1838 / M	079	
LA7770	023	
LV23000M	114	
LV23100V	121	
SONY	CX1691M	078
	CX-20029	001
	CX-20076	002
	CXA1030P	012
	CXA1111	093
	CXA1238	027
	CXA1238N	027N
	CX1343M	032
	CXA1376AM	054
	CXA1538M / N / S	069
CXA1611	075	
CXA1619B	117	
CXA1991N	068	
CX3067M	076	
T. I.	TRF6901	119

Continued on the following page. 

Ceramic Discriminator 10.7MHz Applied IC Reference Table

☒ Continued from the preceding page.

IC Manufacturer	IC Part Number	Suffix Number
TOKO	TK14570L	122
	TK14581	062
	TK14583V	112
	TK14588V	109
TOSHIBA	TA2003	031
	TA2007	033
	TA2008A / AN	045
	TA2022	050
	TA2029	036
	TA2046	058
	TA2057	057
	TA2099N	082
	TA2104AFN	080
	TA2104F	080A
	TA2111N / F / FN	077
	TA2132	092
	TA2132BP	092D
	TA2142FN	102
	TA2149AN	100A
	TA2149N	100
	TA2154FN	113
	TA2159F	116
	TA31161	072
	TA31275FN	123
	TA7130P	009
	TA7303P	008
	TA7640AP	006
	TA7765AF	071
TA8122AN / AF	016	
TA8132AN / AF	018	
TA8186	039	
TA8721ASN	088	
TB2132FN	128	

Notice (Soldering and Mounting)

■ CERAFIL® 10.7MHz Chip Type SFECF Series

1. Standard Reflow Soldering Conditions

(1) Reflow

Filter is soldered twice within the following temperature conditions.

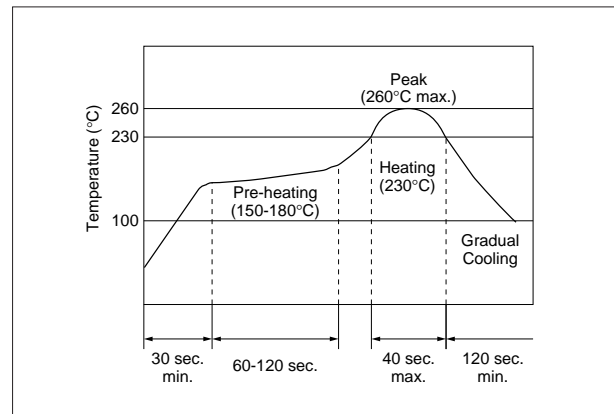

(2) Soldering Iron

Filter is soldered at $+350\pm 5^{\circ}\text{C}$ for 3.0 ± 0.5 seconds. The soldering iron should not touch the filter while soldering.

2. Wash

The component cannot withstand washing.

■ CERAFIL® 10.7MHz Chip Type SFECV/SFECK Series

1. Standard Reflow Soldering Conditions

(1) Reflow

Filter is soldered twice within the following temperature conditions.

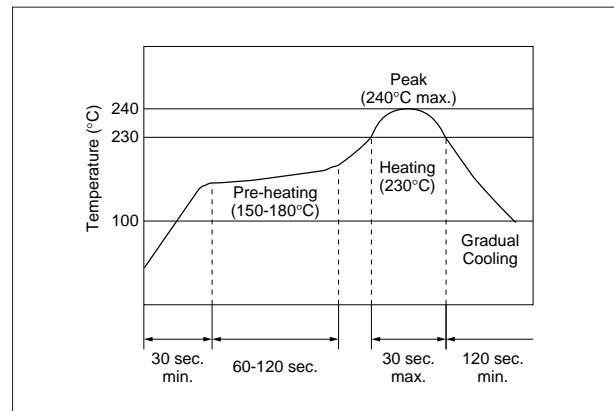

(2) Soldering Iron

Filter is soldered at $+350\pm 5^{\circ}\text{C}$ for 3.0 ± 0.5 seconds. The soldering iron should not touch the filter while soldering.

2. Wash

The component cannot withstand washing.

■ CERAFIL® 10.7MHz Lead Type

The component cannot withstand washing.

Notice (Soldering and Mounting)

■ CERAFIL® 4.5-6.5MHz Chip Type

1. Standard Reflow Soldering Conditions

(1) Reflow

Filter is soldered twice within the following temperature conditions.

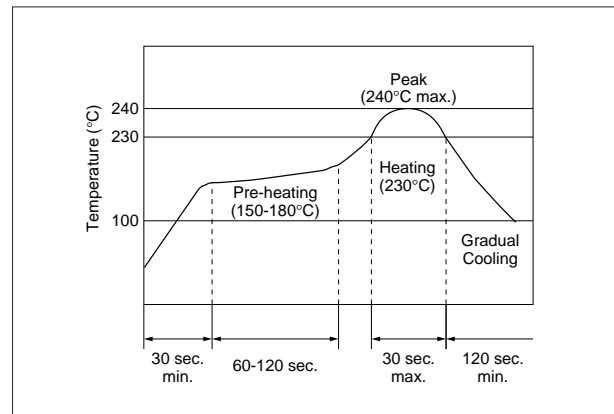

(2) Soldering Iron

Filter is soldered at $+350\pm 5^{\circ}\text{C}$ for 3.0 ± 0.5 seconds. The soldering iron should not touch the filter while soldering.

2. Wash

The component cannot withstand washing.

■ CERAFIL® 2.3-5.7MHz Chip Type SFSKB Series

1. Standard Reflow Soldering Conditions

(1) Reflow

Filter is soldered twice within the following temperature conditions.

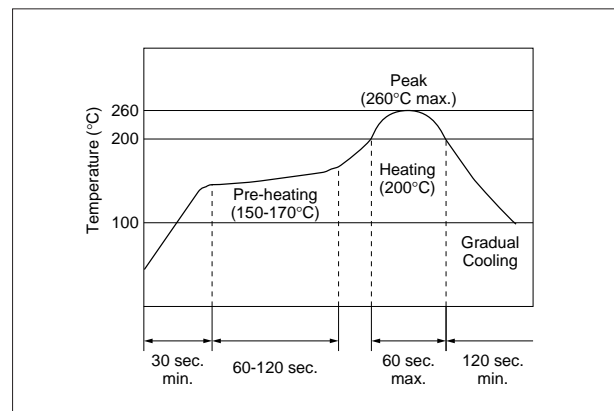

(2) Soldering Iron

Filter is soldered at $+320\pm 5^{\circ}\text{C}$ for 3.0 ± 0.5 seconds. The soldering iron should not touch the filter while soldering.

2. Wash

The component cannot withstand washing.

■ CERAFIL® 3.5-6.5MHz Lead Type

The component cannot withstand washing.

Notice (Soldering and Mounting)

■ CERAFIL® 455kHz Chip Type SFPKA Series

1. Standard Reflow Soldering Conditions

(1) Reflow

Filter is soldered twice within the following temperature conditions.

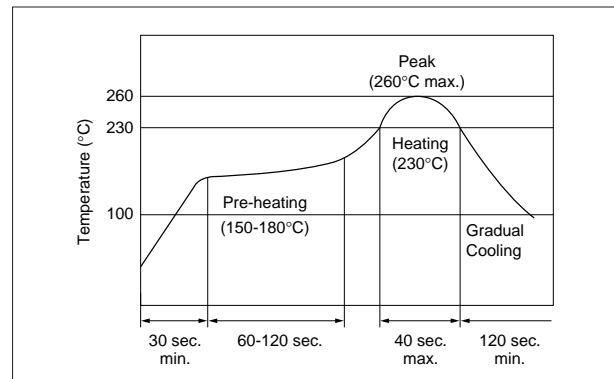

(2) Soldering Iron

Electrode is directly soldered with the tip of soldering iron at $+350\pm 5^{\circ}\text{C}$ for 3.0 ± 0.5 seconds.

2. Wash

(1) Cleaning Solvent

CFC alternatives (HCFC Series), Isopropyl Alcohol (IPA), Water (Demineralized Water), Cleaning Water Solution (Cleantrough-750H, Pine Alpha 100S), Silicon (Technocare FRW)

(2) Cleaning Conditions

- Immersion Wash
2 minutes max. in above solvent at $+60^{\circ}\text{C}$ max.
- Shower or Rinse Wash
2 minutes max. in above solvent at $+60^{\circ}\text{C}$ max.

(3) Notice

- When components are immersed in solvent, be sure to maintain the temperature of components below the temperature of solvent.
- Please do not use ultrasonic cleaning.
- Total washing time should be within 4 minutes.
- Please ensure the component is thoroughly evaluated in your application circuit.
- Please do not use chlorine, petroleum and alkaline cleaning solvents.
- If you plan to use any other type of solvents, please consult with Murata or Murata representative prior to using.

■ CERAFIL® 455kHz Lead Type

The component cannot withstand washing.

Notice (Soldering and Mounting)

■ Ceramic Trap 4.5-6.5MHz Chip Type

1. Standard Reflow Soldering Conditions

(1) Reflow

Filter is soldered twice within the following temperature conditions.

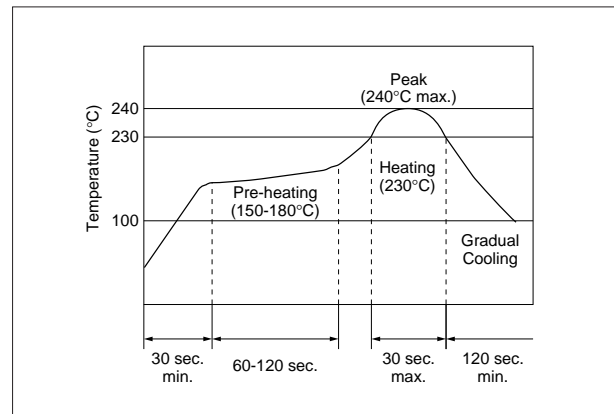

(2) Soldering Iron

Filter is soldered at $+350\pm 5^{\circ}\text{C}$ for 3.0 ± 0.5 seconds. The soldering iron should not touch the filter while soldering.

2. Wash

The component cannot withstand washing.

■ Ceramic Trap 3.5-6.5MHz Lead Type

The component cannot withstand washing.

■ Ceramic Discriminator 10.7MHz Chip Type

1. Standard Reflow Soldering Conditions

(1) Reflow

Filter is soldered twice within the following temperature conditions.

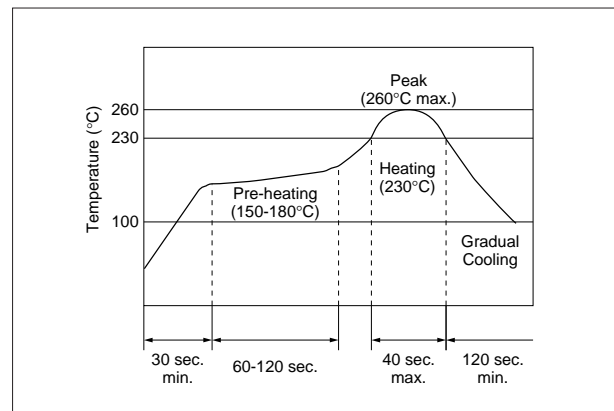

(2) Soldering Iron

Filter is soldered at $+300\pm 5^{\circ}\text{C}$ for 3.0 ± 0.5 seconds. The soldering iron should not touch the filter while soldering.

2. Wash

The component cannot withstand washing.

■ Ceramic Discriminator 10.7MHz Lead Type

The component cannot withstand washing.

■ Ceramic Discriminator 3.5-6.5MHz

The component cannot withstand washing.

Notice (Handling)

■ CERAFIL® 10.7MHz Chip Type SFECF Series

1. The component will be damaged when an excessive stress is applied.
2. The component may be damaged if excess mechanical stress is applied to it mounted on the printed circuit board.
3. Design layout of components on the PC board to minimize the stress imposed on the warp or flexure of the board.
4. After installing chips, if solder is excessively applied to the circuit board, mechanical stress will cause destruction resistance characteristics to lower. To prevent this, be extremely careful in determining shape and dimension before designing the circuit board diagram.
5. The component may be damaged during mounting process if some part of mounter such as positioning claws or nozzle are worn down. The regular maintenance recommended for mounters should be done to prevent trouble.
6. The component is recommended with placement machines which employ optical placement capabilities. The component might be damaged by excessive mechanical force. Please make sure that you have evaluated by using placement machines before going into mass production. Do not use placement machines which utilize mechanical positioning. Please contact Murata for details beforehand.
7. When correcting chips with a soldering iron, the tip of the soldering iron should not directly touch the chip component. Depending on the soldering conditions, the effective area of terminations may be reduced. The use of solder containing Ag should be done to prevent the electrode erosion.
8. Do not clean or wash the component as it is not hermetically sealed.
9. In case of covering filter with over coat, conditions such as material of resin, cure temperature, and so on should be evaluated carefully.
10. Do not use strong acidity flux, more than 0.2wt% chlorine content, in re-flow soldering.
11. Accurate test circuit values are required to measure electrical characteristics.
It may be a cause of miscorrelation if there is any deviation, especially stray capacitance, from the test circuit in the specification.
12. The components, packed in the moisture proof bag (dry pack), are sensitive to moisture. The following treatment is required before applying re-flow soldering. To avoid reliability degradation caused by thermal stress, when unpacked, store the component in an atmosphere at 30°C and below 60%R.H., and solder within 1 week.
13. For safety purposes, connect the output of filters to the IF amplifier through a D.C. blocking capacitor. Avoid applying a direct current to the output of ceramic filters.

[Component Layout Close to Board]

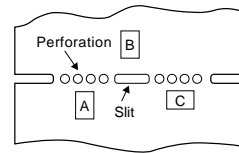

Susceptibility to stress is in the order of : A>C>B

Continued on the following page. 

Notice (Handling)

Continued from the preceding page.

■ CERAFIL® 10.7MHz Chip Type SFECV/SFECK Series

1. The component will be damaged when an excessive stress is applied.
2. The component may be damaged if excess mechanical stress is applied to it mounted on the printed circuit board.
3. Design layout of components on the PC board to minimize the stress imposed on the warp or flexure of the board.
4. After installing chips, if solder is excessively applied to the circuit board, mechanical stress will cause destruction resistance characteristics to lower. To prevent this, be extremely careful in determining shape and dimension before designing the circuit board diagram.
5. The component may be damaged during mounting process if some part of mounter such as positioning claws or nozzle are worn down. The regular maintenance recommended for mounters should be done to prevent troubles.
6. The component is recommended with placement machines which employ optical placement capabilities. The component might be damaged by excessive mechanical force. Please make sure that you have evaluated by using placement machines before going into mass production. Do not use placement machines which utilize mechanical positioning. Please contact Murata for details beforehand.
7. When correcting chips with a soldering iron, the tip of the soldering iron should not directly touch the chip component. Depending on the soldering conditions, the effective area of terminations may be reduced. The use of solder containing Ag should be done to prevent the electrode erosion.
8. Do not clean or wash the component as it is not hermetically sealed.
9. In case of covering filter with over coat, conditions such as material of resin, cure temperature, and so on should be evaluated carefully.
10. Do not use strong acidity flux, more than 0.2wt% chlorine content, in re-flow soldering.
11. Accurate test circuit values are required to measure electrical characteristics. It may be a cause of mis-correlation if there is any deviation, especially stray capacitance, from the test circuit in the specification.
12. For safety purposes, connect the output of filters to the IF amplifier through a D.C. blocking capacitor. Avoid applying a direct current to the output of ceramic filters.

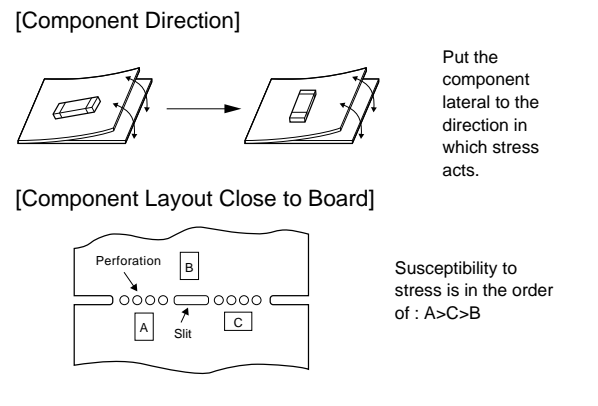

Notice (Handling)

■ CERAFIL® 10.7MHz Lead Type

1. Do not use this product with bend. The component may be damaged if excess mechanical stress is applied to it mounted on the printed circuit board.
2. The component may be damaged when an excessive stress is applied.
3. All kinds of re-flow soldering must not be applied on the component.
4. Do not clean or wash the component as it is not hermetically sealed.
5. Do not use strong acidity flux, more than 0.2wt% chlorine content, in flow soldering.

■ CERAFIL® 4.5-6.5MHz Chip Type

1. The component may be damaged if excess mechanical stress is applied to it mounted on the printed circuit board.
2. Design layout of components on the PC board to minimize the stress imposed on the warp or flexure of the board.
3. After installing chips, if solder is excessively applied to the circuit board, mechanical stress will cause destruction resistance characteristics to lower. To prevent this, be extremely careful in determining shape and dimension before designing the circuit board diagram.
4. The component may be damaged during mounting process if some part of mouter such as positioning claws or nozzle are worn down. The regular maintenance recommended for mounters should be done to prevent troubles.
5. When correcting chips with a soldering iron, the tip of the soldering iron should not directly touch the chip component.
6. Cleaning or washing of the component is not acceptable due to non sealed construction.
7. In case of covering filter with over coat, conditions such as material of resin, cure temperature, and so on should be evaluated carefully.
8. Accurate test circuit values are required to measure electrical characteristics. It may be a cause of miscorrelation if there is any deviation, especially stray capacitance, from the test circuit in the specification.
9. For safety purposes, connect the output of filters to the IF amplifier through a D.C. blocking capacitor. Avoid applying a direct current to the output of ceramic filters.

6. In case of covering discriminator with over coat, conditions such as material of resin, cure temperature, and so on should be evaluated carefully.
7. Accurate test circuit values are required to measure electrical characteristics. It may be a cause of miscorrelation if there is any deviation, especially stray capacitance, from the test circuit in the specification.
8. For safety purposes, avoid applying a direct current between the terminals.

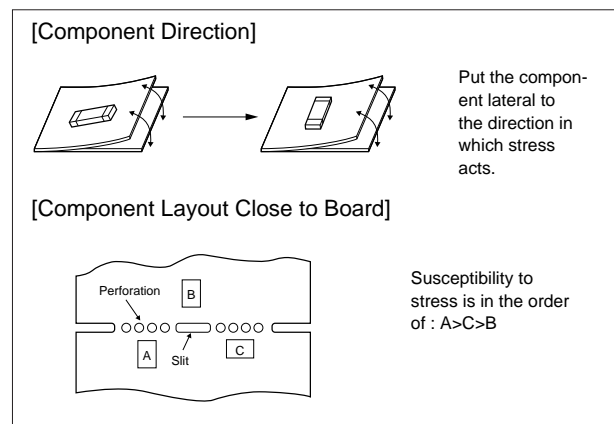

Continued on the following page. 

Notice (Handling)

Continued from the preceding page.

■ CERAFIL® 2.3-5.7MHz Chip Type SFSKB Series

1. The component will be damaged when an excessive stress is applied.
2. The component may be damaged if excess mechanical stress is applied to it mounted on the printed circuit board.
3. Design layout of components on the PC board to minimize the stress imposed on the warp or flexure of the board.
4. After installing chips, if solder is excessively applied to the circuit board, mechanical stress will cause destruction resistance characteristics to lower. To prevent this, be extremely careful in determining shape and dimension before designing the circuit board diagram.
5. The component may be damaged during mounting process if some part of mouter such as positioning claws, nozzle are worn down. The regular maintenance recommended for mounters should be done to prevent the troubles.
6. The component is recommended with placement machines which employ optical placement capabilities. The component might be damaged by excessive mechanical force. Please make sure that you have evaluated by using placement machines before going into mass production. Do not use placement machines which utilize mechanical positioning. Please contact Murata for details beforehand.
7. When correcting chips with a soldering iron, the tip of the soldering iron should not directly touch the chip component. Depending on the soldering conditions, the effective area of terminations may be reduced. The use of solder containing Ag should be done to prevent the electrode erosion.
8. Do not clean or wash the component as it is not hermetically sealed.
9. In case of covering filter with over coat, conditions such as material of resin, cure temperature, and so on should be evaluated carefully.
10. Do not use strong acidity flux, more than 0.2wt% chlorine content, in re-flow soldering.
11. Accurate test circuit values are required to measure electrical characteristics. It may be a cause of miscorrelation if there is any deviation, especially stray capacitance, from the test circuit in the specification.
12. For safety purposes, connect the output of filters to the IF amplifier through a D.C. blocking capacitor. Avoid applying a direct current to the output of ceramic filters.

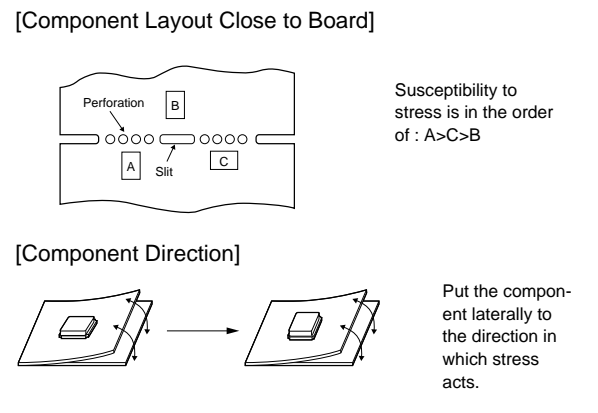

Notice (Handling)

■ CERAFIL® 3.5-6.5MHz Lead Type

1. Do not use this product with bend. The component may be damaged if excess mechanical stress is applied to it mounted on the printed circuit board.
2. The component may be damaged when an excessive stress is applied.
3. All kinds of re-flow soldering must not be applied on the component.
4. Do not clean or wash the component as it is not hermetically sealed.
5. Please contact Murata or Murata representative for soldering condition, in case of using lead free solder.
6. Do not use strong acidity flux, more than 0.2wt% chlorine content, in flow soldering.
7. In case of covering filter with over coat, conditions such as material of resin, cure temperature, and so on should be evaluated carefully.
8. Accurate test circuit values are required to measure electrical characteristics. It may be a cause of miscorrelation if there is any deviation, especially stray capacitance, from the test circuit in the specification.
9. For safety purposes, connect the output of filters to the IF amplifier through a D.C. blocking capacitor. Avoid applying a direct current to the output of ceramic filters.

■ CERAFIL® 455kHz Chip Type SFPKA Series

1. The component will be damaged when an excessive stress is applied.
2. In the case that the component is cleaned, confirm that no reliability degradation is created.
3. In case of covering filter with over coat, conditions such as material of resin, cure temperature, and so on should be evaluated carefully.
4. Do not use strong acidity flux, more than 0.2wt% chlorine content, in re-flow soldering.
5. The product, packed in the moisture-proof bag (dry pack), is sensitive to moisture. The following treatment is required before applying re-flow soldering, to avoid package cracks or reliability degradation caused by thermal stress. When unpacked, store the component in an atmosphere of below 25 degree C and below 65%R.H., and solder within 48 hours.
6. For safety purposes, connect the output of filters to the IF amplifier through a D.C. blocking capacitor. Avoid applying a direct current to the output of ceramic filters.

■ CERAFIL® 455kHz Lead Type

1. Do not use this product with bend. The component may be damaged if excessive mechanical stress is applied to it mounted on the printed circuit board.
2. The component will be damaged when an excessive stress is applied.
3. All kinds of re-flow soldering must not be applied on the component.
4. Do not clean or wash the component as it is not hermetically sealed.
5. Do not use strong acidity flux, more than 0.2wt% chlorine content, in flow soldering.
6. In case of covering filter with over coat, conditions such as material of resin, cure temperature, and so on should be evaluated carefully.
7. Accurate test circuit values are required to measure electrical characteristics. It may be a cause of miscorrelation if there is any deviation, especially stray capacitance, from the test circuit in the specification.
8. For safety purposes, connect the output of filters to the IF amplifier through a D.C. blocking capacitor. Avoid applying a direct current to the output of ceramic filters.

Notice (Handling)

■ Ceramic Trap 4.5-6.5MHz Chip Type

1. The component may be damaged if excess mechanical stress is applied to it mounted on the printed circuit board.
2. Design layout of components on the PC board to minimize the stress imposed on the warp or flexure of the board.
3. After installing chips, if solder is excessively applied to the circuit board, mechanical stress will cause destruction resistance characteristics to lower. To prevent this, be extremely careful in determining shape and dimension before designing the circuit board diagram.
4. The component may be damaged during mounting process if some part of mounter such as positioning claws or nozzle are worn down. The regular maintenance recommended for mounters should be done to prevent troubles.
5. When correcting chips with a soldering iron, the tip of the soldering iron should not directly touch the chip component.
6. Cleaning or washing of the component is not acceptable due to non sealed construction.
7. In case of covering filter with over coat, conditions such as material of resin, cure temperature, and so on should be evaluated carefully.
8. Accurate test circuit values are required to measure electrical characteristics. It may be a cause of miscorrelation if there is any deviation, especially stray capacitance, from the test circuit in the specification.
9. For safety purposes, connect the output of filters to the IF amplifier through a D.C. blocking capacitor. Avoid applying a direct current to the output of ceramic filters.

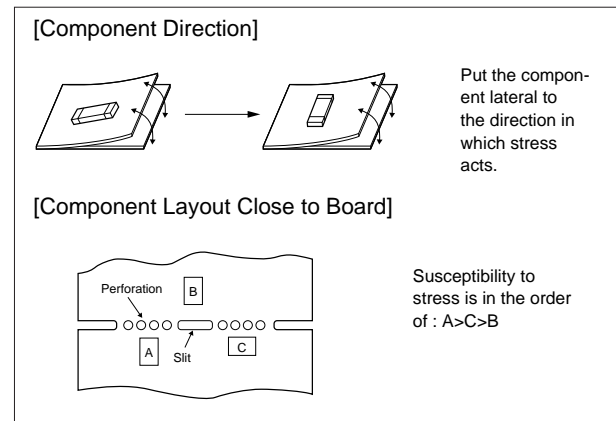

■ Ceramic Trap 3.5-6.5MHz Lead Type

1. Do not use this product with bend. The component may be damaged if excess mechanical stress is applied to it mounted on the printed circuit board.
2. The component may be damaged when an excessive stress is applied.
3. All kinds of re-flow soldering must not be applied on the component.
4. Do not clean or wash the component as it is not hermetically sealed.
5. Please contact Murata or Murata representative for soldering condition, in case of using lead free solder.
6. Do not use strong acidity flux, more than 0.2wt% chlorine content, in flow soldering.
7. In case of covering filter with over coat, conditions such as material of resin, cure temperature, and so on should be evaluated carefully.
8. Accurate test circuit values are required to measure electrical characteristics. It may be a cause of miscorrelation if there is any deviation, especially stray capacitance, from the test circuit in the specification.
9. For safety purposes, connect the output of filters to the IF amplifier through a D.C. blocking capacitor. Avoid applying a direct current to the output of ceramic filters.

Notice (Handling)

■ Ceramic Discriminator 10.7MHz Chip Type

1. The component mounted on the PCB may be damaged if excessive mechanical stress is applied.
2. Layout the components on the PCB to minimize the stress imposed on the warp or flexure of the board.
3. After installing components, if solder is excessively applied to the circuit board, mechanical stress will cause destruction resistance characteristics to lower. To prevent this, be extremely careful in determining shape and dimension before designing the circuit board diagram.
4. The component may be damaged during mounting process if some part of mounter such as positioning claws or nozzle are worn down. The regular maintenance recommended for mounters should be done to prevent troubles.
5. When correcting component's position with a soldering iron, the tip of the soldering iron should not directly touch the chip component. Depending on the soldering conditions, the effective area of terminations may be reduced. The use of solder containing Ag should be considered to prevent the electrode erosion.
6. Do not clean or wash the component as it is not hermetically sealed.
7. In case of overcoating the part, coating conditions such as material of resin, curing temperature, and so on should be evaluated carefully.
8. Accurate test circuit values are required to measure electrical characteristics.
It may be a cause of miscorrelation if there is any deviation, especially stray capacitance, from the test circuit in the specification.
9. For safety purposes, avoid applying a direct current between the terminals.

■ Ceramic Discriminator 10.7MHz Lead Type

1. Do not use this product with bend. The component may be damaged if excess mechanical stress is applied to it mounted on the printed circuit board.
2. The component may be damaged when an excessive stress is applied.
3. All kinds of re-flow soldering must not be applied on the component.
4. Do not clean or wash the component as it is not hermetically sealed.
5. Do not use strong acidity flux, more than 0.2wt% chlorine content, in flow soldering.

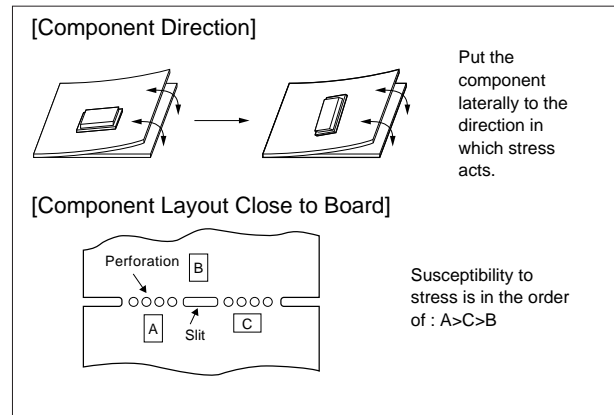

6. In case of covering discriminator with over coat, conditions such as material of resin, cure temperature, and so on should be evaluated carefully.
7. Accurate test circuit values are required to measure electrical characteristics. It may be a cause of miscorrelation if there is any deviation, especially stray capacitance, from the test circuit in the specification.
8. For safety purposes, avoid applying a direct current between the terminals.

Packaging

Minimum Quantity

	Taping		Ammo Pack	Bulk	Magazine	Box
	ø330mm	ø180mm				
CERAFIL®<10.7MHz>	SFEFCF		2,000			
	SFECV/SFECK		2,000			
	SFELF			1,500	500	
	SFELG			1,500	500	
	SFKLF			1,500	500	
	SFVLF			1,000	500	
CERAFIL®<2.3-6.5MHz>	SFSKA	3,000				
	SFSKB	3,000				
CERAFIL®<455kHz>	CFULA					200
	CFWLA				50	150
	SFPKA	1,000				
	SFPLA				50	200
	SFULA				500	50
	SFZLA				200	50
Ceramic Traps<3.5-6.5MHz>	TPSKA	3,000				
	TPWKA	3,000				
Ceramic Discriminators<10.7MHz>	CDALF		1,500	500		
	CDSCB		2,000			

CERAFIL® 10.7MHz Chip Type SFECF Series

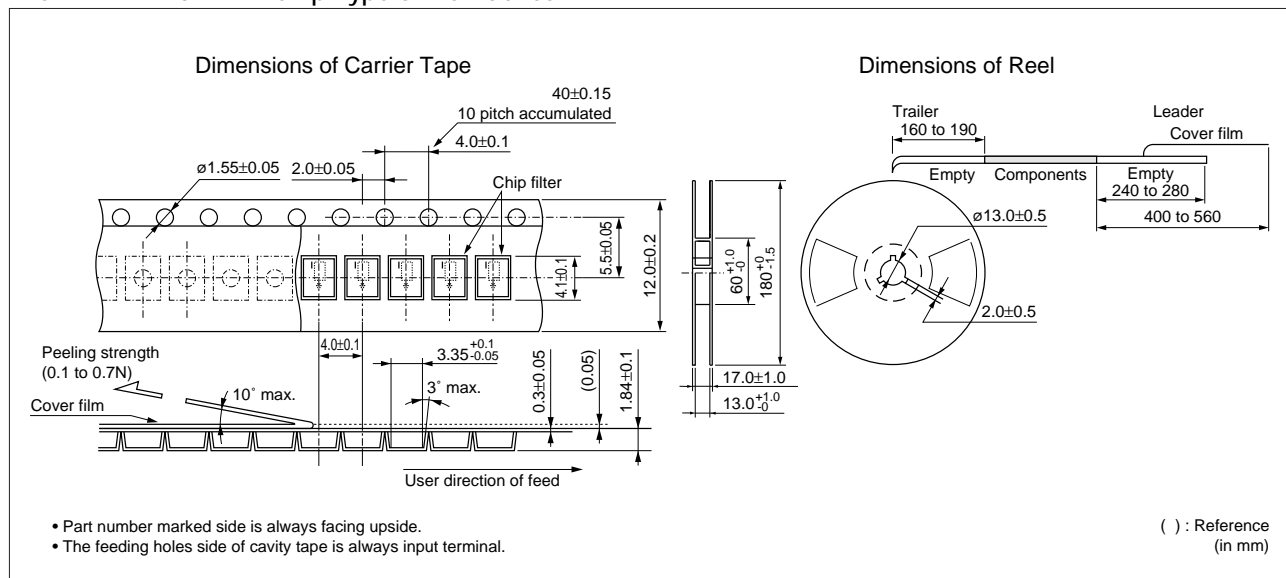

Continued on the following page. ↗

Packaging

Continued from the preceding page.

■ CERAFIL® 10.7MHz Chip Type SFECV/SFECK Series

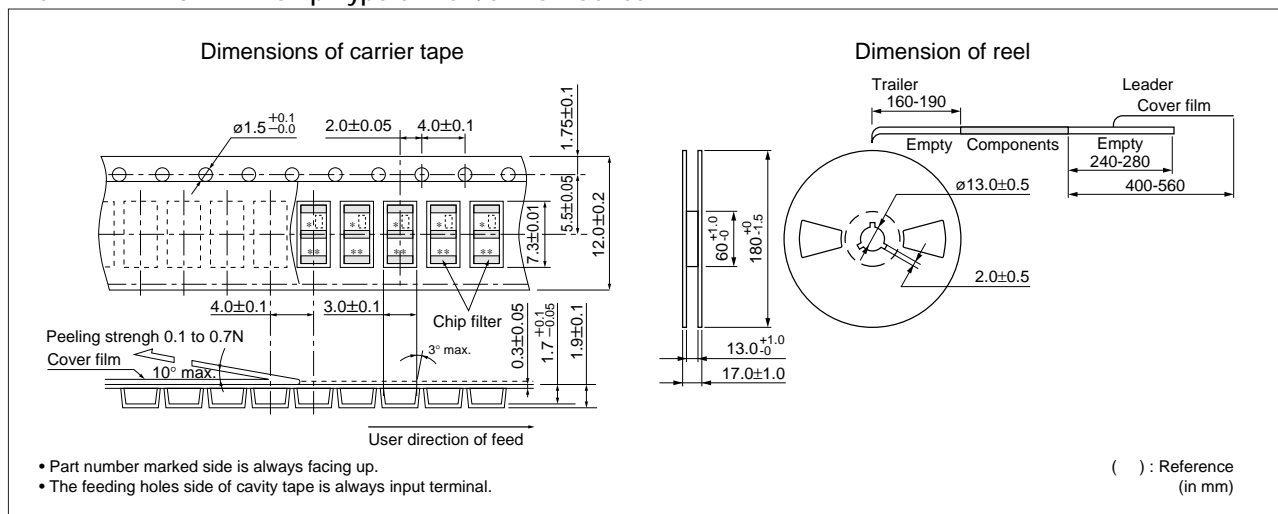

Continued on the following page. ↗

Packaging

Continued from the preceding page.

■ CERAFIL® 10.7MHz Lead Type SF_LF Series

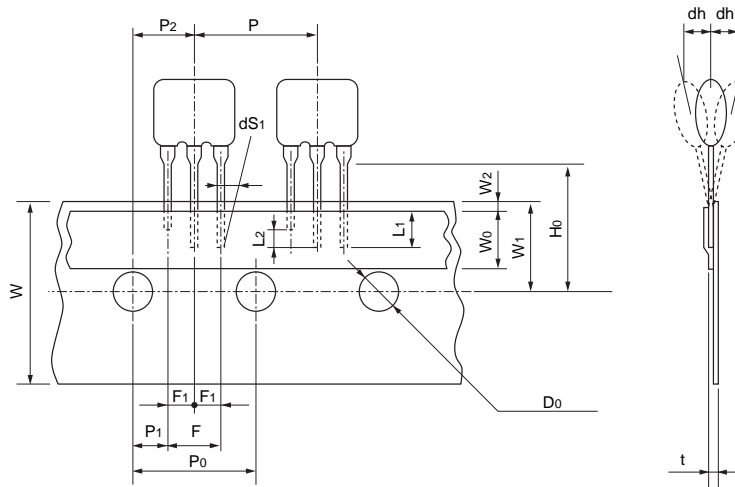

Item	Code	Dimensions	Tolerance	Remarks
Lead length under the hold down tape	L1	3.0 min.	-	
Length of cut off	L2	2.0 max.	-	To distinguish the direction
Pitch of components	P	12.7	±0.5	
Pitch of sprocket hole (1)	P0	12.7	±0.2	
Length from hole center to lead	P1	3.85	±0.5	
Length from hole center to component center	P2	6.35	±0.5	
Lead spacing (1)	F	5.0	+0.5 -0.2	
Lead spacing (2)	F1	2.5	±0.2	
Slant to the forward or backward	dh	0	±1.0	
Slant to the left or right	dS1	0	±1.0	
Width of carrier tape	W	18.0	±0.5	
Width of hold down tape	W0	6.0 min.	-	
Position of sprocket hole	W1	9.0	±0.5	
Gap of hold down tape and carrier tape	W2	0	+0.5 -0	Hold down tape doesn't exceed the carrier tape
Distance between the center of sprocket hole and lead stopper	H0	18.0	±0.5	
Diameter of sprocket hole	D0	ø4.0	±0.2	
Total tape thickness	t	0.6	±0.2	
Pitch of sprocket hole (2)	P020	254.0	±1.5	The pitch of 20 sprocket holes

(in mm)

Continued on the following page. ↗

Packaging

Continued from the preceding page.

■ CERAFIL® 4.5-6.5MHz Chip Type SFSKA Series

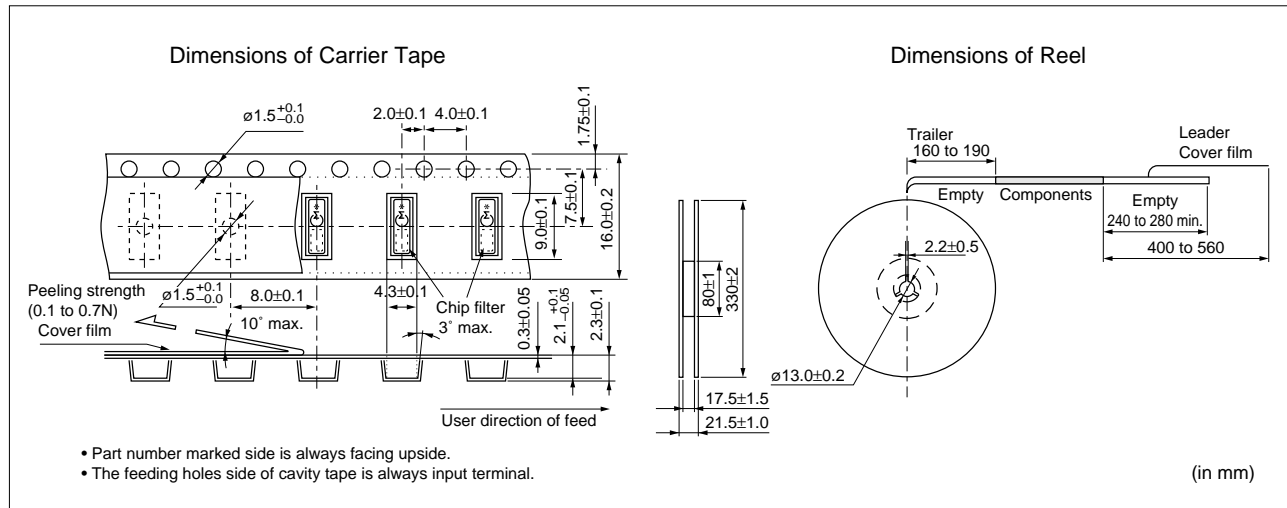

■ CERAFIL® 2.3-5.7MHz Chip Type SFSKB Series

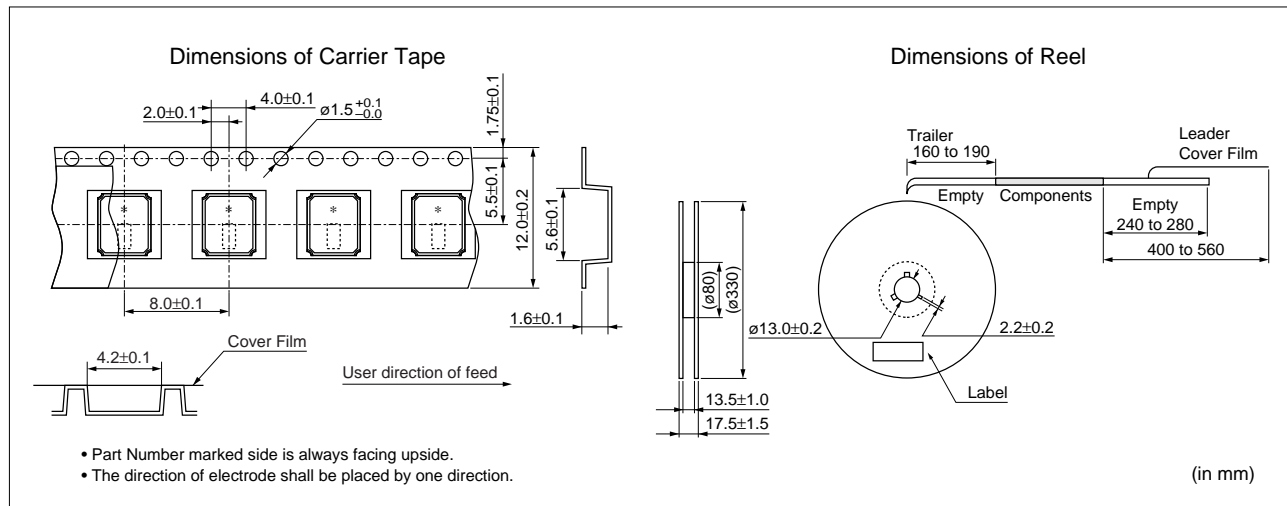

■ CERAFIL® 455kHz Chip Type SFPKA Series

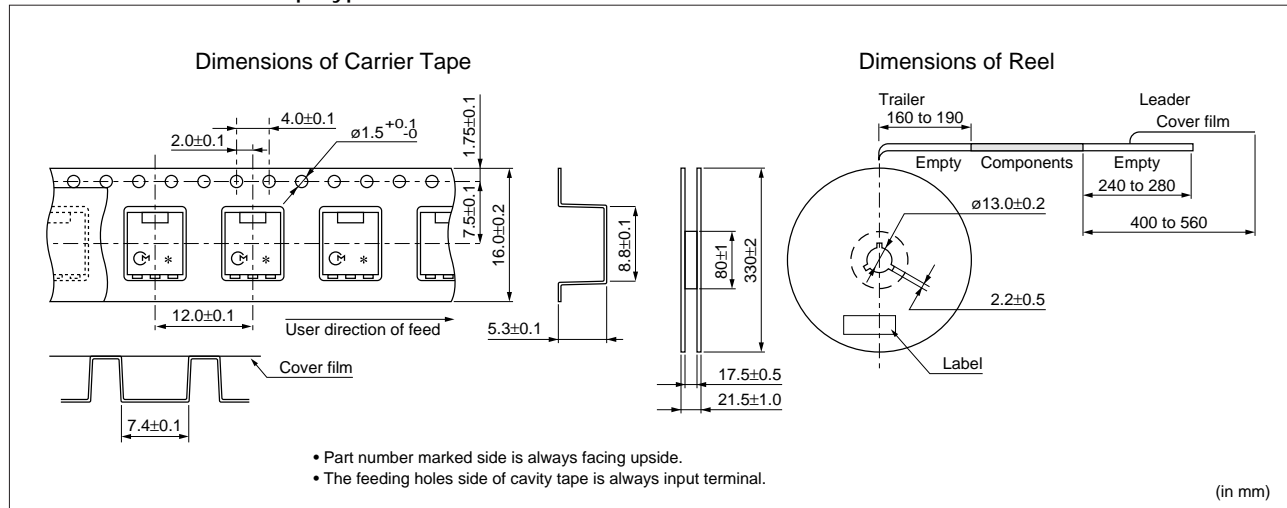

Continued on the following page. ↗

Packaging

Continued from the preceding page.

■ CERAFIL® 455kHz Lead Type SFULA Series

Standard of Magazine Cassette

1. Putting CERAFIL® into Magazine

A magazine should contain 50pcs of CERAFIL®, with the marking of products all facing toward the "Murata" mark on a magazine, and be closed with exclusive stoppers at both ends. Above should be the minimum packaging unit.

2. Quality of Magazine

- (1) Transparent so that input / output direction is visually recognizable.
- (2) With an angle of 35° CERAFIL® should slip down smoothly.
- (3) Antistatic finish
- (4) Recycling

Note: Magazines should be sent back for recycling.
(Therefore, empty magazines should not be damaged.)

3. Dimensions of Magazine Cassette

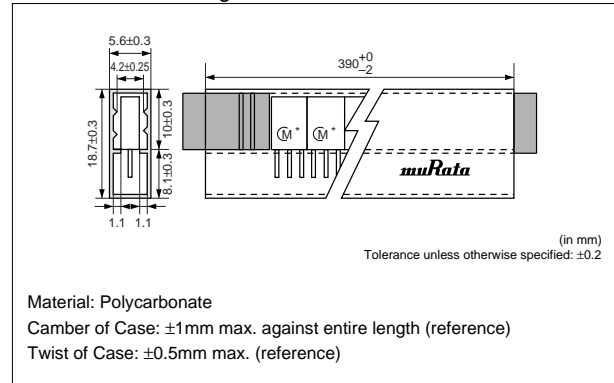

■ CERAFIL® 455kHz Lead Type SFZLA Series

Standard of Magazine Cassette

1. Putting CERAFIL® into Magazine

A magazine should contain 50pcs of CERAFIL®, with the marking of products all facing toward the "Murata" mark on a magazine, and be closed with exclusive stoppers at both ends. Above should be the minimum packaging unit.

2. Quality of Magazine

- (1) Transparent so that input / output direction is visually recognizable.
- (2) With an angle of 35° CERAFIL® should slip down smoothly.
- (3) Antistatic finish
- (4) Recycling

Note: Magazines should be sent back for recycling.
(Therefore, empty magazines should not be damaged.)

3. Dimensions of Magazine Cassette

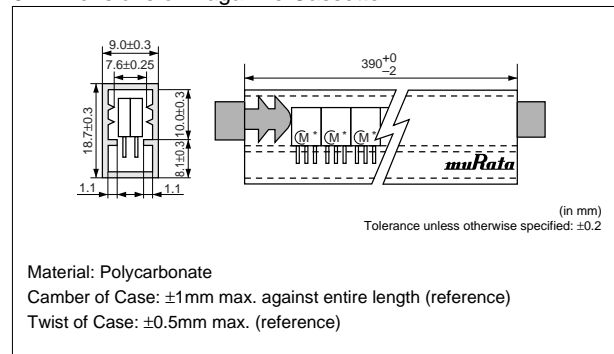

■ CERAFIL® 455kHz Lead Type SFPLA Series

Standard of Magazine Cassette

1. Putting CERAFIL® into Magazine

A magazine should contain 50pcs of CERAFIL®, which ground terminals are all facing toward the "Murata" mark on a magazine, and be closed with exclusive stoppers at both ends. Above should be the minimum packaging unit.

2. Quality of Magazine

- (1) Transparent so that input / output direction is visually recognizable.
- (2) With an angle of 35° CERAFIL® should slip down smoothly.
- (3) Antistatic finish
- (4) Recycling

Note: Magazines should be sent back for recycling.
(Therefore, empty magazines should not be damaged.)

3. Dimensions of Magazine Cassette

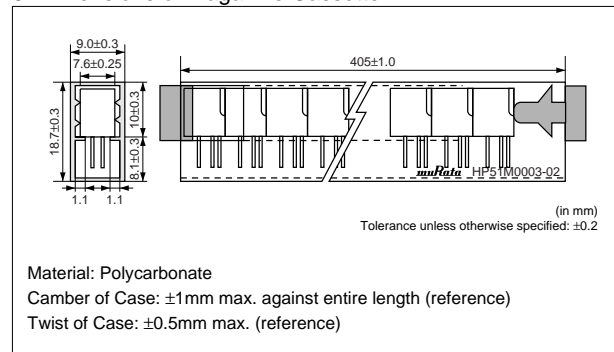

Continued on the following page. ↗

Packaging

Continued from the preceding page.

■ CERAFIL® 455kHz Lead Type CFWLA Series

Standard of Magazine Cassette

1. Putting CERAFIL® into Magazine

A magazine should contain 50pcs of CERAFIL®, with ground terminals all facing toward the "Murata" mark on a magazine, and be closed with exclusive stoppers at both ends. Above should be the minimum packaging unit.

2. Quality of Magazine

- (1) Transparent so that input / output direction is visually recognizable.
- (2) With an angle of 35° CERAFIL® should slip down smoothly.
- (3) Antistatic finish
- (4) Recycling

Note: Magazines should be sent back for recycling.
(Therefore, empty magazines should not be damaged.)

3. Magazine should be packaged in a cardboard box.

MURATA model name, quantity and outgoing inspection number should be indicated on the box.
Cardboard box may contain maximum 33 magazines (1,650 pieces of filter).

4. Dimensions of Magazine Cassette

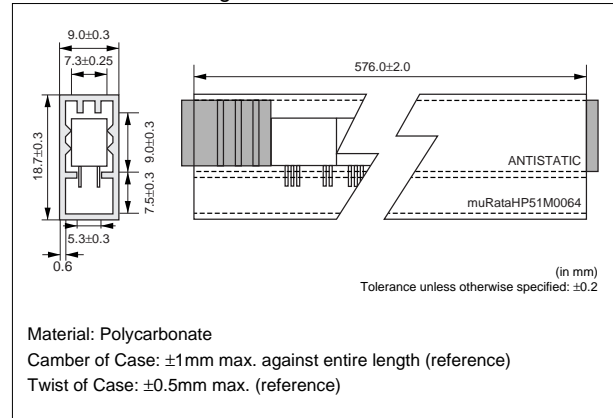

■ Ceramic Trap 4.5-6.5MHz Chip Type TPSKA Series

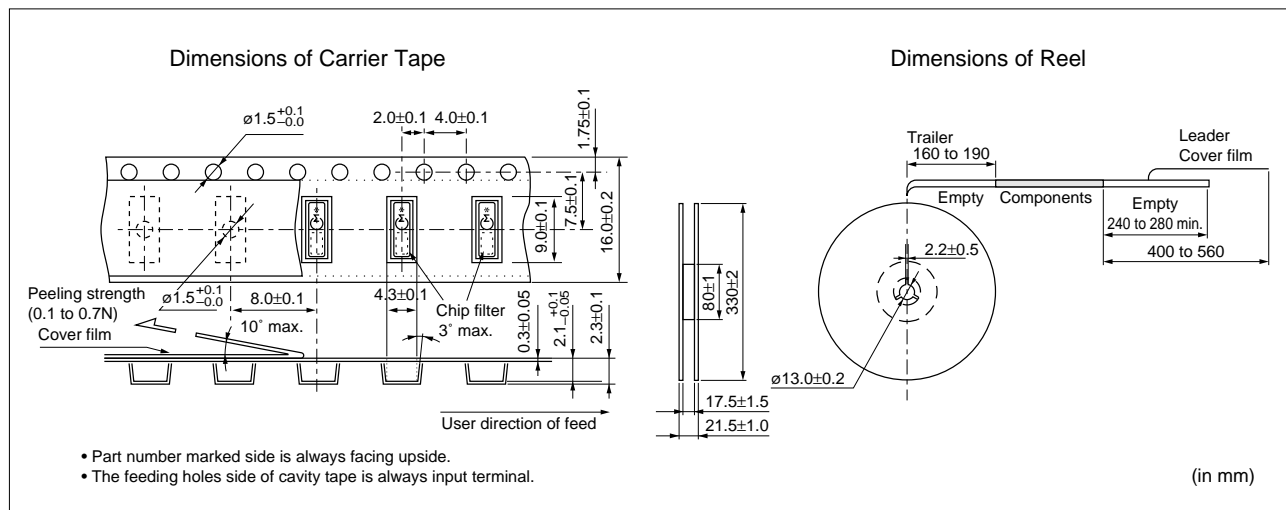

Continued on the following page. ↗

Packaging

Continued from the preceding page.

■ Ceramic Trap 4.5-6.5MHz Chip Type TPWKA Series

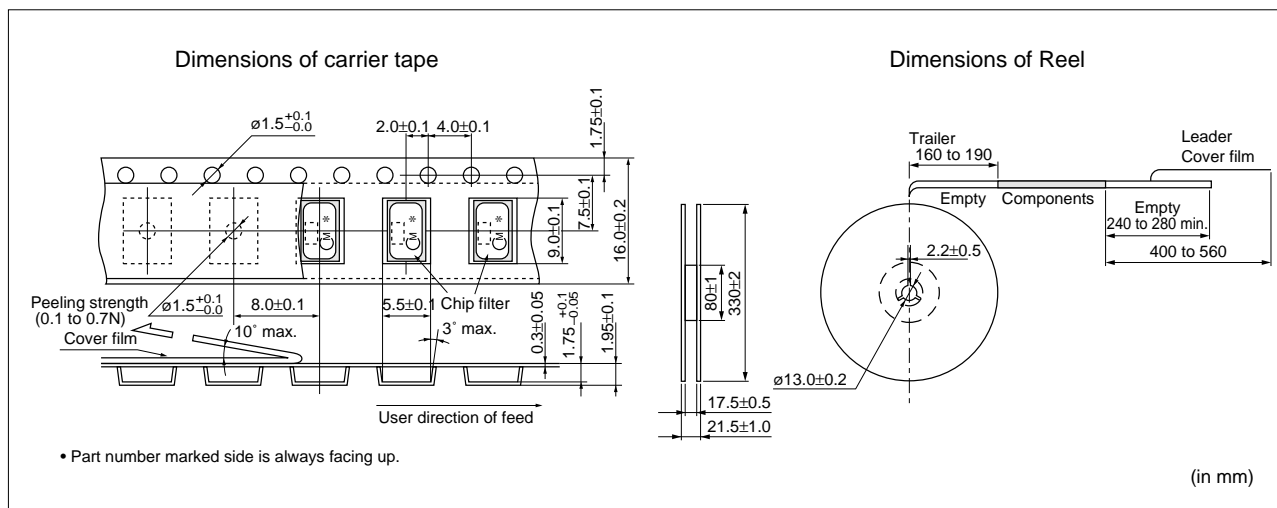

■ Ceramic Discriminator 10.7MHz Chip Type CDSCB Series

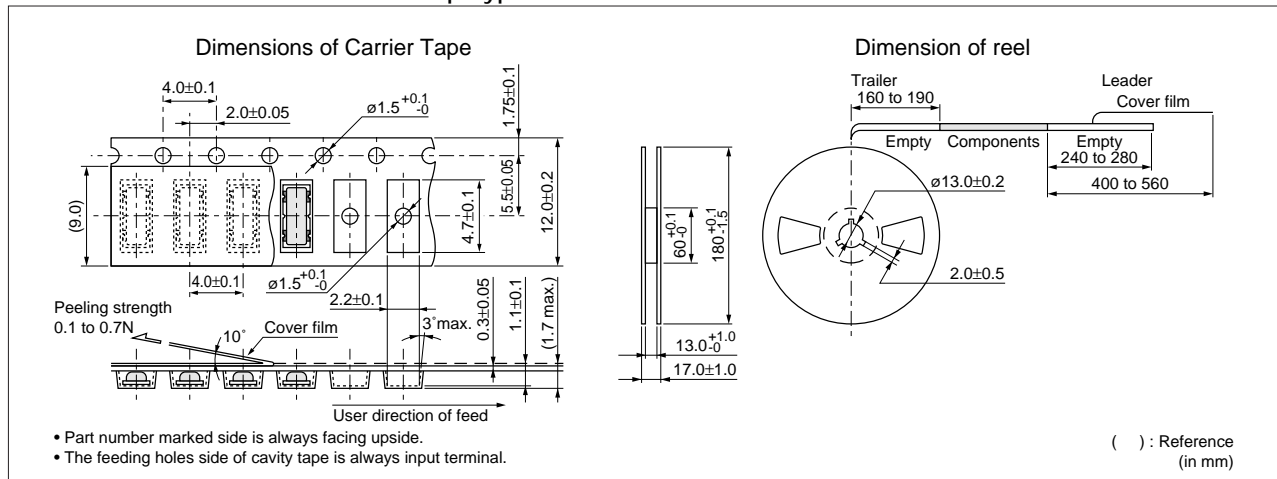

Continued on the following page.

Packaging

Continued from the preceding page.

■ Ceramic Discriminator 10.7MHz Lead Type CDALF Series

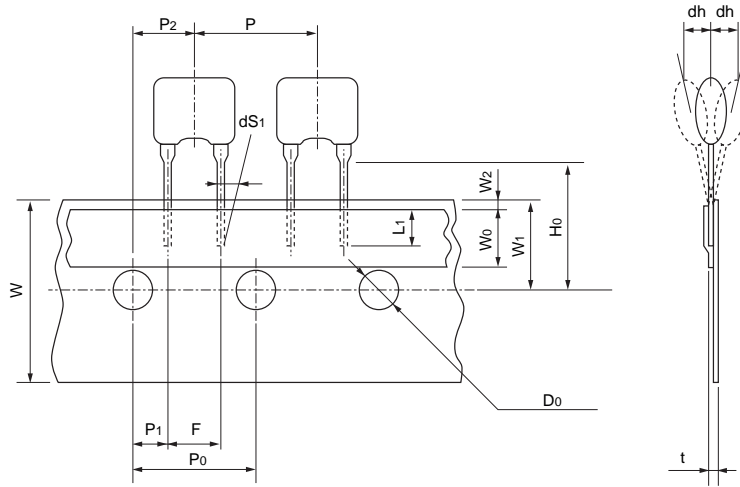

Item	Code	Dimensions	Tolerance	Remarks
Lead length under the hold down tape	L1	3.0 min.	-	
Pitch of component	P	12.7	±0.5	
Pitch of sprocket hole (1)	P0	12.7	±0.2	
Length from hole center to lead	P1	3.85	±0.5	
Length from hole center to component center	P2	6.35	±0.5	
Lead spacing	F	5.0	+0.5 -0.2	
Slant to the forward or backward	dh	0	±1.0	
Slant to the left or right	dS1	0	±1.0	
Width of carrier tape	W	18.0	±0.5	
Width of hold down tape	W0	6.0 min.	-	
Position of sprocket hole	W1	9.0	±0.5	
Gap of hold down tape and carrier tape	W2	0	+0.5 -0.0	Hold down tape doesn't exceed the carrier tape
Distance between the center of sprocket hole and lead stopper	H0	18.0	±0.5	
Diameter of sprocket hole	D0	ø4.0	±0.2	
Total tape thickness	t	0.6	±0.2	
Pitch of sprocket hole (2)	Po20	254.0	±1.5	The pitch of 20 sprocket holes

(in mm)

Part Number Index

CDALF	Ceramic Discriminators for FM	<i>p62</i>
CDSCB	Chip Ceramic Discriminators for FM	<i>p57</i>
CFULA	Ceramic Filters (CERAFIL®) for AM	<i>p50</i>
CFWLA	Ceramic Filters (CERAFIL®) for AM	<i>p48, 50</i>
SFECF	Chip Ceramic Filters (CERAFIL®) for FM	<i>p5-6</i>
SFECK	Chip Ceramic Filters (CERAFIL®) for FM	<i>p11</i>
SFECV	Chip Ceramic Filters (CERAFIL®) for FM	<i>p11</i>
SFELF	Ceramic Filters (CERAFIL®) for FM	<i>p14, 17, 23-24, 26, 28-29, 31</i>
SFELG	Ceramic Filters (CERAFIL®) for FM	<i>p20-21</i>
SFKLF	Ceramic Filters (CERAFIL®) for FM	<i>p28</i>
SFPKA	Chip Ceramic Filters (CERAFIL®) for AM	<i>p43</i>
SFPLA	Ceramic Filters (CERAFIL®) for AM	<i>p48, 50</i>
SFSKA	Chip Ceramic Filters (CERAFIL®) for TV/VCR	<i>p35</i>
SFSKB	Chip Ceramic Filters (CERAFIL®) for TV/VCR	<i>p38</i>
SFULA	Ceramic Filters (CERAFIL®) for AM	<i>p45</i>
SFVLF	Ceramic Filters (CERAFIL®) for FM	<i>p28</i>
SFZLA	Ceramic Filters (CERAFIL®) for AM	<i>p45</i>
TPSKA	Chip Ceramic Traps	<i>p54</i>
TPWKA	Chip Ceramic Traps (Double Traps)	<i>p56</i>

⚠Note:

1. Export Control

<For customers outside Japan>

No Murata products should be used or sold, through any channels, for use in the design, development, production, utilization, maintenance or operation of, or otherwise contribution to (1) any weapons (Weapons of Mass Destruction [nuclear, chemical or biological weapons or missiles] or conventional weapons) or (2) goods or systems specially designed or intended for military end-use or utilization by military end-users.

<For customers in Japan>

For products which are controlled items subject to the "Foreign Exchange and Foreign Trade Law" of Japan, the export license specified by the law is required for export.

2. Please contact our sales representatives or product engineers before using the products in this catalog for the applications listed below, which require especially high reliability for the prevention of defects which might directly damage a third party's life, body or property, or when one of our products is intended for use in applications other than those specified in this catalog.

- | | |
|-----------------------------|--|
| ① Aircraft equipment | ② Aerospace equipment |
| ③ Undersea equipment | ④ Power plant equipment |
| ⑤ Medical equipment | ⑥ Transportation equipment (vehicles, trains, ships, etc.) |
| ⑦ Traffic signal equipment | ⑧ Disaster prevention / crime prevention equipment |
| ⑨ Data-processing equipment | ⑩ Application of similar complexity and/or reliability requirements to the applications listed above |

3. Product specifications in this catalog are as of November 2009. They are subject to change or our products in it may be discontinued without advance notice. Please check with our sales representatives or product engineers before ordering. If there are any questions, please contact our sales representatives or product engineers.

4. Please read rating and ⚠ CAUTION (for storage, operating, rating, soldering, mounting and handling) in this catalog to prevent smoking and/or burning, etc.

5. This catalog has only typical specifications because there is no space for detailed specifications. Therefore, please approve our product specifications or transact the approval sheet for product specifications before ordering.

6. Please note that unless otherwise specified, we shall assume no responsibility whatsoever for any conflict or dispute that may occur in connection with the effect of our and/or a third party's intellectual property rights and other related rights in consideration of your use of our products and/or information described or contained in our catalogs. In this connection, no representation shall be made to the effect that any third parties are authorized to use the rights mentioned above under licenses without our consent.

7. No ozone depleting substances (ODS) under the Montreal Protocol are used in our manufacturing process.



<http://www.murata.com/>

Head Office
1-10-1, Higashi Kotari, Nagaokakyo-shi, Kyoto 617-8555, Japan
Phone: 81-75-951-9111

International Division
3-29-12, Shibuya, Shibuya-ku, Tokyo 150-0002, Japan
Phone: 81-3-5469-6123 Fax: 81-3-5469-6155 E-mail: intl@murata.co.jp