

Hermetically Sealed Threaded Case Filters

This series of filters features hermetic glass seals and high EMI filtering performance. They are excellent for critical applications that demand high reliability in the toughest environmental conditions and provide broadband high performance EMI filtering from 10 KHz to over 10 GHz.

Features

- Popular .375", .410" and .690" case diameters
- Voltage ratings from 50 VDC to 400 VDC/240 VAC, 400 Hz
- Filter configurations available: C, L, Pi, T and double T
- MIL-F-15733 and MIL-F-28861 QPL filters available



Low Pass Filters

Thread length: A - 0.187 (4.76) B - 0.312 (7.92)

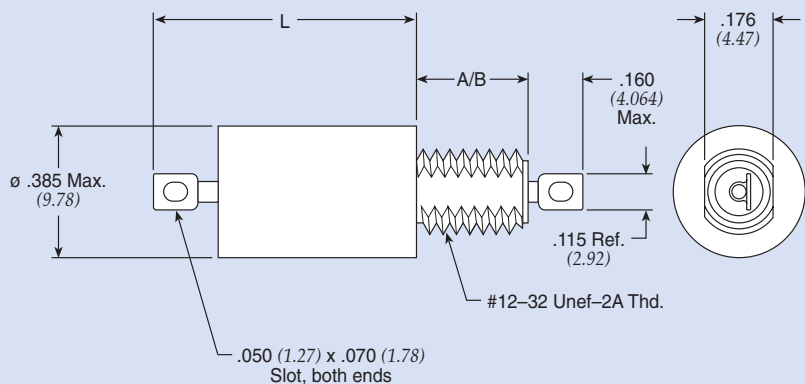
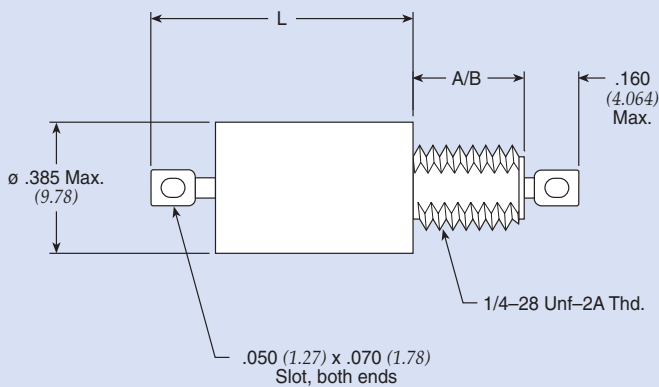

Note: \varnothing .410 Max. for M28861 parts

Dimensions in inches (mm)

Hermetically Sealed Threaded Case Filters

.375 ø C Circuit Standard

Part Number	MIL No	See Pg. 84 for Fig.	Rated Voltage				I Amp	Min Cap µF	DCR Max Ohms	Max L		Thd Lgth	Minimum Insertion Loss (dB)						
			85°C		125°C					In	(mm)		30 KHz	150 KHz	300 KHz	1 MHz	10 MHz	100 MHz	1 GHz
			DC	AC	DC	AC													
† 54-367-008	—	1	80	—	50	—	15	1.400	0.005	0.387	(9.830)	A	15	28	33	44	60	70	70
54-370-007	—	1	80	—	50	—	15	2.800	0.005	0.576	(14.630)	A	20	34	39	50	60	70	70
54-371-001	—	1	80	—	50	—	15	4.000	0.005	0.688	(17.475)	A	26	40	46	55	60	70	70
54-367-005	—	1	150	—	100	—	15	0.450	0.005	0.387	(9.830)	A	6	19	25	36	55	70	70
† 9920-100-6002	—	1	200	—	150	125	15	0.150	0.005	0.387	(9.830)	A	—	6	15	26	42	55	70
54-367-007	—	1	250	—	200	125	15	0.015	0.005	0.387	(9.830)	A	—	—	—	6	25	45	50
† 54-367-006	—	1	250	—	200	125	15	0.250	0.005	0.387	(9.830)	A	—	14	19	30	50	65	70
54-370-006	—	1	250	—	200	125	15	0.500	0.005	0.630	(16.002)	A	7	20	28	39	55	70	70
9923-100-6004	—	1	400	—	400	240	15	0.060	0.005	0.415	(10.541)	A	—	5	10	18	38	55	70

.375 ø C Circuit MIL Qualified (See MIL index on page 244-246 for complete MIL part number listing)

Part Number	M15733 M28861 MIL No	See Pg. 84 for Fig.	Rated Voltage				I Amp	Min Cap µF	DCR Max Ohms	Max L		Thd Lgth	Minimum Insertion Loss (dB)						
			85°C		125°C					In	(mm)		30 KHz	150 KHz	300 KHz	1 MHz	10 MHz	100 MHz	1 GHz
			DC	AC	DC	AC													
54-367-054	1-012	1	—	—	50	—	15	1.200	0.008	0.410	(10.414)	B	15	28	33	40	40	70	70
54-367-049	1-002	1	—	—	50	—	15	1.200	0.008	0.410	(10.414)	A	15	28	33	40	40	70	70
54-370-032	49-0008	1	—	—	50	—	15	2.100	0.010	0.576	(14.630)	A	20	33	40	50	65	70	70
54-367-055	1-014	1	—	—	70	—	15	0.700	0.008	0.410	(10.414)	B	10	24	30	40	40	64	70
54-370-030	34-0035	2	—	—	100	—	10	0.300	0.004	0.474	(12.040)	A	7	19	25	35	55	70	70
54-367-051	1-006	1	—	—	100	—	15	0.450	0.008	0.410	(10.414)	A	6	19	25	36	40	60	70
54-367-056	1-016	1	—	—	100	—	15	0.450	0.008	0.410	(10.414)	B	6	19	25	36	40	60	70
54-367-057	1-018	1	—	—	150	—	15	0.250	0.008	0.410	(10.414)	B	—	14	20	31	40	56	70
54-367-053	1-010	1	—	—	200	125	15	0.150	0.008	0.410	(10.414)	A	—	10	16	26	40	52	70
54-367-058	1-020	1	—	—	200	125	15	0.150	0.008	0.410	(10.414)	B	—	10	16	26	40	52	70
54-370-034	49-0010	1	—	—	330	—	15	0.062	0.004	0.680	(17.272)	A	—	2	7	17	37	55	70

† Also available through Spectrum Control's authorized distributors.

Hermetically Sealed Threaded Case Filters

L-C Filter LT

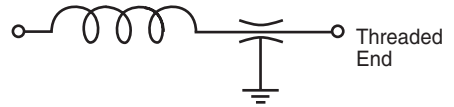

L-C Filter LB

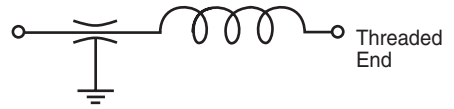

.375 ø L Circuit

Thread length: A - 0.187 (4.76) B - 0.312 (7.92)

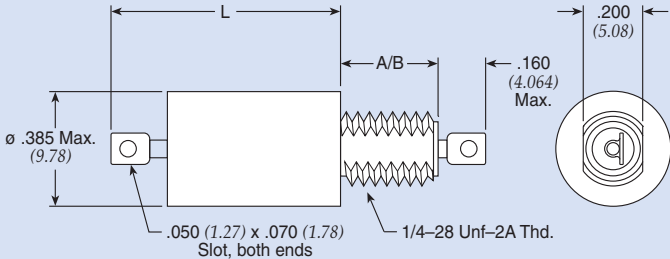

Figure 1

Note: ø .410 Max. for M28861 parts

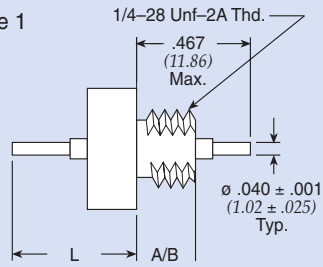

Figure 3

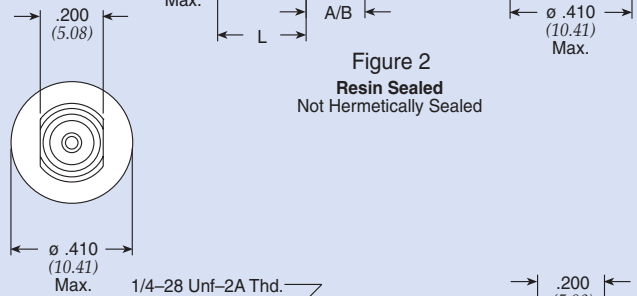

Figure 2
Resin Sealed
Not Hermetically Sealed

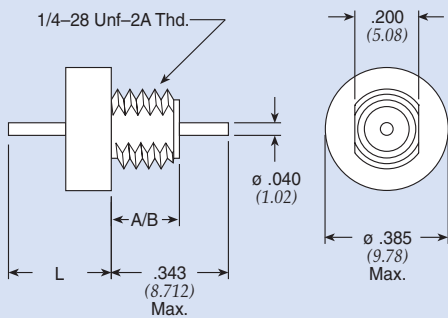

Figure 4

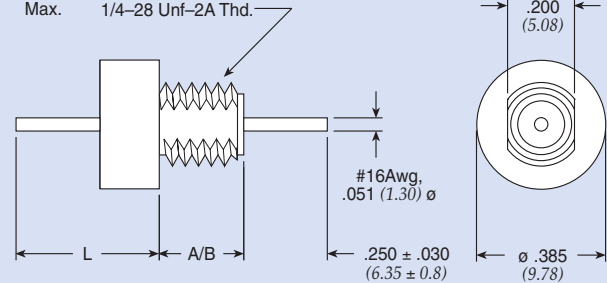

Figure 5

Dimensions in inches (mm)

.375 ø L Standard Low Profile

Part Number	MIL No	Figure	Rated Voltage				I Amp	Min Cap µF	DCR Max Ohms	CKT	Max L In	Max L (mm)	Thd Lgth	Minimum Insertion Loss (dB)						
			DC	AC	DC	AC								30 KHz	150 KHz	300 KHz	1 MHz	10 MHz	100 MHz	1 GHz
† 9051-100-0000	—	1	80	—	50	—	15	1.200	0.005	LB	0.370	(9.398)	A	15	25	34	44	60	70	70
† 51-359-001 €	—	1	80	—	50	—	15	1.400	0.005	LB	0.370	(9.398)	A	15	28	33	44	60	70	70
SCI-1021-000	—	2*	80	—	50	—	15	1.400	0.003	LB	0.280	(7.112)	A	15	28	33	44	60	70	70
† 9053-100-0001	—	1	80	—	50	—	15	1.400	0.005	LB	0.370	(9.398)	A	15	25	34	44	60	70	70
† 51-717-001 €	—	2*	80	—	50	—	15	1.400	0.005	LB	0.325	(8.255)	A	15	28	33	44	60	70	70
51-344-006	—	4	80	—	50	—	15	1.400	0.005	LB	0.330	(8.382)	A	15	28	33	44	60	70	70
† SCI-1020-000	—	1	80	—	50	—	15	1.400	0.003	LB	0.370	(9.398)	A	15	28	33	44	60	70	70
SCI-1021-020	—	2 ⁰ *	80	—	50	—	15	1.400	0.003	LB	0.280	(7.112)	B	15	28	33	44	60	70	70
† SCI-1020-020	—	1	80	—	50	—	15	1.400	0.003	LB	0.370	(9.398)	B	15	28	33	44	60	70	70
SCI-1150-001	—	1	80	—	50	—	15	2.800	0.003	LB	0.450	(11.430)	B	20	34	40	49	60	70	70
9051-101-0018	—	5	80	—	50	—	25	1.400	0.001	LB	0.450	(11.430)	A	15	25	34	44	60	70	70
† 9053-100-0008	—	1	100	—	70	—	15	0.700	0.005	LB	0.370	(9.398)	A	9	20	29	39	52	70	70

* Part is resin sealed, this is not a hermetic part.

† Also available through Spectrum Control's authorized distributors.

€ Also available through Spectrum Control's authorized European distributors/agents.

◇ Note: 0.462" (11.73mm) length from mounting surface to end of lead — not 0.347" (8.8mm).

Hermetically Sealed Threaded Case Filters

L-C Filter LT

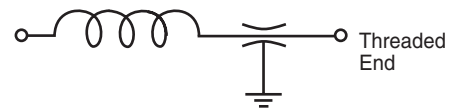

L-C Filter LB

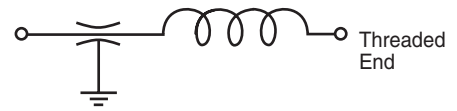

.375 ø L Standard Low Profile *continued*

Part Number	MIL No	See Pg. 86 for Fig	Rated Voltage				I Amp	Min Cap µF	DCR Max Ohms	CKT	Max L		Thd Lgth	Minimum Insertion Loss (dB)						
			85°C		125°C						In	(mm)		30 KHz	150 KHz	300 KHz	1 MHz	10 MHz	100 MHz	1 GHz
			DC	AC	DC	AC														
+9050-100-0008	—	2*	100	—	70	—	15	0.750	0.005	LB	0.325	(8.255)	A	9	20	29	39	52	70	70
+9053-100-0002	—	1	150	—	100	—	15	0.500	0.005	LB	0.370	(9.398)	A	4	12	21	31	48	70	70
SCI-1250-001	—	1	150	—	100	—	15	0.500	0.003	LB	0.450	(11.430)	B	8	20	25	34	50	64	70
€SCI-2150-000	—	1	150	—	100	—	15	1.000	0.003	LB	0.450	(11.430)	A	10	25	30	41	56	70	70
SCI-2150-001	—	1	150	—	100	—	15	1.000	0.003	LB	0.450	(11.430)	B	10	25	30	41	56	70	70
+51-717-007	—	2*	250	125	200	125	15	0.015	0.005	LB	0.325	(8.255)	A	—	—	—	6	25	38	45
+51-359-007	—	1	250	125	200	125	15	0.015	0.005	LB	0.370	(9.398)	A	—	—	—	6	25	38	50
9050-100-0011	—	2	350	125	300	125	15	0.150	0.008	LB	0.325	(8.255)	A	—	10	15	25	40	52	60
€SCI-2350-000	—	1	300	125	300	125	15	0.250	0.003	LB	0.450	(11.430)	A	4	15	21	31	50	70	70
SCI-2350-001	—	1	300	125	300	125	15	0.250	0.003	LB	0.450	(11.430)	B	4	15	21	31	50	70	70

* Part is resin sealed, this is not a hermetic part.

.375 ø L Circuit MIL Qualified Low Profile

(See MIL index on page 244-246 for complete MIL part number listing)

Part Number	M15733 M28861 MIL No	See Pg. 86 for Fig	Rated Voltage				I Amp	Min Cap µF	DCR Max Ohms	CKT	Max L		Thd Lgth	Minimum Insertion Loss (dB)						
			85°C		125°C						In	(mm)		30 KHz	150 KHz	300 KHz	1 MHz	10 MHz	100 MHz	1 GHz
			DC	AC	DC	AC														
+51-359-021	38-0004	1	—	—	50	—	10	1.400	0.008	LB	0.370	(9.398)	A	15	28	33	44	60	70	70
+51-359-024	38-0005	1	80	—	50	—	10	1.400	0.008	LB	0.370	(9.398)	A	15	28	33	44	60	70	70
+51-359-051	58-0001	1	80	—	50	—	10	1.400	0.008	LB	0.545	(13.843)	A	15	28	33	44	60	70	70
51-359-105	58-0004	1	80	—	50	—	10	1.400	0.008	LT	0.545	(13.843)	B	15	28	33	44	60	70	70
+51-359-044	49-0006	1	100	—	50	—	15	1.200	0.010	LB	0.370	(9.398)	A	15	28	33	44	60	70	70
+51-359-055	49-0007	3	100	—	50	—	15	1.200	0.010	LB	0.450	(11.43)	A	15	28	33	44	60	70	70
51-359-081	1-001	1	—	—	50	—	15	1.400	0.008	LB	0.410	(10.414)	A	15	28	33	40	40	70	70
51-359-086	1-011	1	—	—	50	—	15	1.400	0.008	LB	0.410	(10.414)	B	15	28	33	40	40	70	70
+51-359-053	49-0001	4	100	—	50	—	15	0.680	0.010	LB	0.319	(8.103)	A	8	20	28	38	55	70	70
51-359-082	1-003	1	—	—	70	—	15	0.700	0.008	LB	0.410	(10.414)	A	10	24	30	40	40	64	70
51-359-083	1-005	1	—	—	100	—	15	0.450	0.008	LB	0.410	(10.414)	A	6	19	25	36	40	60	70
51-359-088	1-015	1	—	—	100	—	15	0.450	0.008	LB	0.410	(10.414)	B	6	19	25	36	40	60	70
51-359-084	1-007	1	—	—	150	—	15	0.250	0.008	LB	0.410	(10.414)	A	—	14	20	31	40	56	70
51-359-050	38-0008	1	—	—	200	125	15	0.030	0.008	LB	0.370	(9.398)	A	—	—	—	6	25	42	60
51-359-085	1-009	1	—	—	200	125	15	0.150	0.008	LB	0.410	(10.414)	A	—	10	16	26	40	52	70
51-359-090	1-019	1	—	—	200	125	15	0.150	0.008	LB	0.410	(10.414)	B	—	10	16	26	40	52	70

† Also available through Spectrum Control's authorized distributors.

€ Also available through Spectrum Control's authorized European distributors/agents.

Hermetically Sealed Threaded Case Filters

.375 ø L Circuit

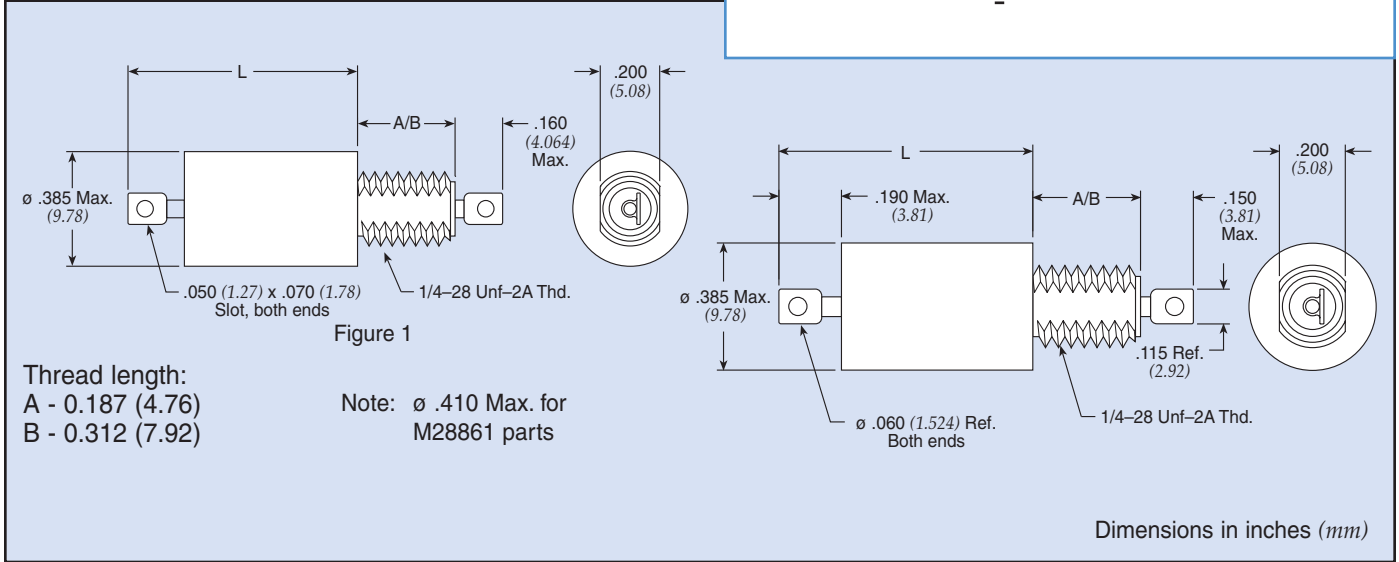

L-C Filter LT

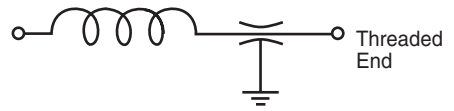

L-C Filter LB

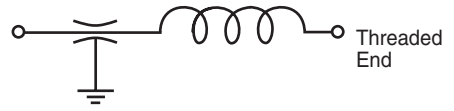

.375 ø L Circuit Standard Product

Part Number	MIL No	Figure	Rated Voltage				I Amp	Min Cap µF	DCR Max Ohms	CKT	Max L In	Max L (mm)	Thd Lgth	Minimum Insertion Loss (dB)						
			85°C DC	85°C AC	125°C DC	125°C AC								30 KHz	150 KHz	300 KHz	1 MHz	10 MHz	100 MHz	1 GHz
51-353-007	—	1	80	—	50	—	0.06	1.400	70.000	LB	0.770	(19.558)	A	44	70	70	70	70	70	70
51-353-095	—	1	80	—	50	—	0.15	1.400	12.000	LT	0.960	(24.384)	A	21	52	64	70	70	70	70
51-353-003	—	1	80	—	50	—	0.45	1.400	1.200	LB	0.770	(19.558)	A	16	31	37	55	70	70	70
51-353-099	—	1	80	—	50	—	1.00	1.400	0.250	LT	0.770	(19.558)	A	16	33	44	70	70	70	70
51-353-100	—	1	80	—	50	—	5.00	1.400	0.015	LT	0.770	(19.558)	A	15	28	33	46	70	70	70
†9200-300-0025	—	1	80	—	50	—	10.00	1.200	0.010	LB	0.450	(11.430)	A	15	28	33	44	60	70	70

† Also available through Spectrum Control's authorized distributors.

Hermetically Sealed Threaded Case Filters

L-C Filter LT



L-C Filter LB



.375 ø L Circuit Standard Product *continued*

Part Number	MIL No	See Pg. 88 for Fig	Rated Voltage				I Amp	Min Cap µF	DCR Max Ohms	CKT	Max L		Thd Lgth	Minimum Insertion Loss (dB)						
			85°C		125°C						In	(mm)		30 KHz	150 KHz	300 KHz	1 MHz	10 MHz	100 MHz	1 GHz
			DC	AC	DC	AC														
†9200-303-0095	—	1	80	—	50	—	10.00	1.200	0.010	LB	0.450	(11.430)	B	15	28	33	44	60	70	70
51-353-101	—	1	80	—	50	—	10.00	1.400	0.010	LT	0.450	(11.430)	A	14	28	33	44	60	70	70
51-353-109	—	1	80	—	50	—	10.00	1.400	0.010	LT	0.450	(11.430)	B	15	28	33	44	60	70	70
51-353-120	—	1	150	—	100	—	1.00	0.750	0.250	LB	0.758	(19.253)	A	9	27	36	57	70	70	70
9000-103-0019	—	1	150	—	100	—	5.00	0.450	0.015	LT	0.758	(19.253)	B	6	20	26	37	68	70	70
SCI-2120-014	—	1	150	—	100	—	10.00	1.000	0.003	LB	0.450	(11.430)	B	14	28	34	44	52	70	70
51-353-110	—	1	250	—	200	125	1.00	0.250	0.250	LT	0.758	(19.253)	A	—	17	29	50	70	70	70
†51-353-111	—	1	250	—	200	125	1.00	0.250	0.250	LB	0.758	(19.253)	A	—	17	29	50	70	70	70
51-353-112	—	1	250	—	200	125	3.00	0.250	0.050	LT	0.758	(19.253)	A	—	13	20	35	70	70	70
†51-353-113	—	1	250	—	200	125	3.00	0.250	0.050	LB	0.758	(19.253)	A	—	13	20	35	70	70	70
51-353-114	—	1	250	—	200	125	5.00	0.250	0.015	LT	0.758	(19.253)	A	—	12	20	30	62	70	70
51-353-116	—	1	250	—	200	125	10.00	0.250	0.010	LT	0.450	(11.430)	A	—	15	20	30	50	70	70
SCI-2320-010	—	1	300	—	300	125	0.50	0.150	1.000	LB	0.758	(19.253)	B	—	23	35	56	70	70	70
SCI-2320-004	—	1	300	—	300	125	1.00	0.150	0.250	LB	0.758	(19.253)	A	—	10	21	41	70	70	70
SCI-2320-005	—	1	300	—	300	125	2.00	0.150	0.063	LB	0.758	(19.253)	A	—	8	14	30	70	70	70
SCI-2320-006	—	1	300	—	300	125	3.00	0.150	0.027	LB	0.758	(19.253)	A	—	8	14	26	64	70	70
SCI-2320-007	—	1	300	—	300	125	10.00	0.150	0.003	LB	0.450	(11.430)	A	—	8	14	25	45	52	70
SCI-2320-014	—	1	300	—	300	125	10.00	0.150	0.003	LB	0.450	(11.430)	B	—	8	14	25	45	52	70

Low Pass Filters

.375 ø L Circuit MIL Qualified Profile

(See MIL index on pages 244-246 for complete MIL part number listing)

Part Number	M15733 MIL No	See Pg. 88 for Fig	Rated Voltage				I Amp	Min Cap µF	DCR Max Ohms	CKT	Max L		Thd Lgth	Minimum Insertion Loss (dB)						
			85°C		125°C						In	(mm)		30 KHz	150 KHz	300 KHz	1 MHz	10 MHz	100 MHz	1 GHz
			DC	AC	DC	AC														
51-390-018	23-0026	1	—	—	50	—	0.50	1.400	0.360	LB	0.630	(16.002)	A	12	36	48	69	70	70	70
51-390-026	23-0038	1	—	—	50	—	1.00	1.400	0.140	LB	0.630	(16.002)	A	11	26	36	55	70	70	70
51-390-034	23-0050	1	—	—	50	—	2.00	1.400	0.070	LB	0.630	(16.002)	A	10	24	32	48	70	70	70
†51-353-067	24-0006	1	80	—	50	—	10.00	1.400	0.010	LB	0.760	(19.304)	B	15	28	31	42	56	70	70
51-353-207	34-0007	1	—	—	50	—	10.00	1.400	0.010	LB	0.760	(19.304)	A	15	28	31	42	56	70	70
51-444-072	58-0002	1	80	—	50	—	10.00	1.400	0.008	LT	0.545	(13.843)	A	15	28	33	44	60	70	70
†51-353-066	24-0005	1	80	—	50	—	10.00	1.400	0.010	LB	0.760	(19.304)	A	15	28	31	42	56	70	70
51-353-287	39-0014	1	—	—	50	—	10.00	1.400	0.003	LT	0.760	(19.304)	B	14	28	34	44	52	70	70
†51-444-060	24-0008	1	80	—	50	—	10.00	1.400	0.010	LT	0.740	(18.796)	B	15	28	31	42	56	70	70
†51-343-028	38-0002	1	—	—	50	—	15.00	1.400	0.008	LB	0.481	(12.217)	A	15	28	33	44	64	70	70
†51-343-034	38-0006	1	—	—	50	—	15.00	1.400	0.008	LB	0.481	(12.217)	B	15	28	33	44	64	70	70
51-353-053	25-0003	1	—	—	100	—	1.00	0.450	0.250	LB	0.738	(18.745)	A	6	23	34	55	70	70	70
†51-353-054	25-0005	1	—	—	100	—	5.00	0.450	0.015	LT	0.758	(19.253)	A	6	17	23	35	69	70	70
†51-353-055	25-0008	1	—	—	100	—	5.00	0.450	0.015	LB	0.738	(18.745)	A	6	17	23	35	69	70	70
51-353-155	39-0008	1	—	—	100	—	5.00	0.450	0.015	LB	0.760	(19.304)	A	6	20	26	35	60	60	70
51-444-039	25-0017	1	—	—	100	—	5.00	0.450	0.015	LT	0.758	(19.253)	B	6	17	23	35	69	70	70

† Also available through Spectrum Control's authorized distributors.

Hermetically Sealed Threaded Case Filters

L-C Filter LT

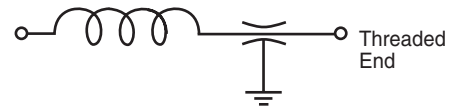

L-C Filter LB

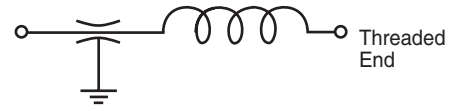

.375 ø L Circuit MIL Qualified Profile *continued*

(See MIL index on pages 244-246 for complete MIL part number listing)

Low Pass Filters

Part Number	M15733 MIL No	See Pg. 88 for Fig	Rated Voltage				I Amp	Min Cap µF	DCR Max Ohms	CKT	Max L In (mm)	Thd Lgth	Minimum Insertion Loss (dB)							
			85°C		125°C								30 KHz	150 KHz	300 KHz	1 MHz	10 MHz	100 MHz	1 GHz	
51-444-040	25-0020	1	—	—	100		5.00	0.450	0.015	LB	0.738 (18.745)	B	6	17	23	35	69	70	70	
51-353-156	39-0009	1	—	—	100		10.00	0.450	0.003	LT	0.760 (19.304)	A	6	20	26	35	56	60	70	
51-353-157	39-0010	1	—	—	100		10.00	0.450	0.003	LB	0.760 (19.304)	A	6	20	26	35	56	60	70	
+ 51-353-076	26-0001	1	—	—	150	125	1.00	0.250	0.250	LT	0.758 (19.253)	A	—	13	24	45	80	70	70	
+ 51-353-077	26-0003	1	—	—	150	125	1.00	0.250	0.250	LB	0.738 (18.745)	A	—	13	24	45	80	70	70	
51-444-043	26-0013	1	—	—	150	125	1.00	0.250	0.250	LT	0.758 (19.253)	B	—	13	24	45	80	70	70	
51-444-044	26-0015	1	—	—	150	125	1.00	0.250	0.250	LB	0.738 (18.745)	B	—	13	24	45	80	70	70	
51-390-040	23-0058	1	—	—	150		2.00	0.250	0.070	LT	0.630 (16.002)	A	3	15	23	38	60	70	60	
51-390-039	23-0057	1	—	—	150		2.00	0.250	0.070	LT	0.630 (16.002)	B	3	15	23	38	60	70	60	
51-444-005	34-0015	1	—	—	150	125	3.00	0.150	0.050	LT	0.758 (19.253)	B	—	8	15	30	68	70	70	
+ 51-353-078	26-0004	1	—	—	150	125	3.00	0.250	0.050	LT	0.758 (19.253)	A	—	8	15	30	68	70	70	
+ 51-353-079	26-0006	1	—	—	150	125	3.00	0.250	0.050	LB	0.738 (18.745)	A	—	8	15	30	68	70	70	
+ 51-444-046	26-0018	1	—	—	150	125	3.00	0.250	0.050	LB	0.738 (18.745)	B	—	8	15	30	68	70	70	
51-444-047	26-0019	1	—	—	150	125	5.00	0.250	0.015	LT	0.758 (19.253)	B	—	8	14	25	58	70	70	
+ 51-353-080	26-0007	1	—	—	150	125	5.00	0.250	0.015	LT	0.758 (19.253)	A	—	8	14	25	58	70	70	
51-353-081	26-0010	1	—	—	150	125	5.00	0.250	0.015	LB	0.738 (18.745)	A	—	8	14	25	58	70	70	
51-444-027	34-0030	1	—	—	200	125	5.00	0.250	0.150	LB	0.900 (22.860)	A	2	15	21	32	60	70	70	
51-444-117	54-0018	2	—	—	300	125	1.00	0.150	0.250	LB	0.740 (18.796)	A	—	10	21	41	70	70	70	

† Also available through Spectrum Control's authorized distributors.

Hermetically Sealed Threaded Case Filters



.375 ø Pi Circuit

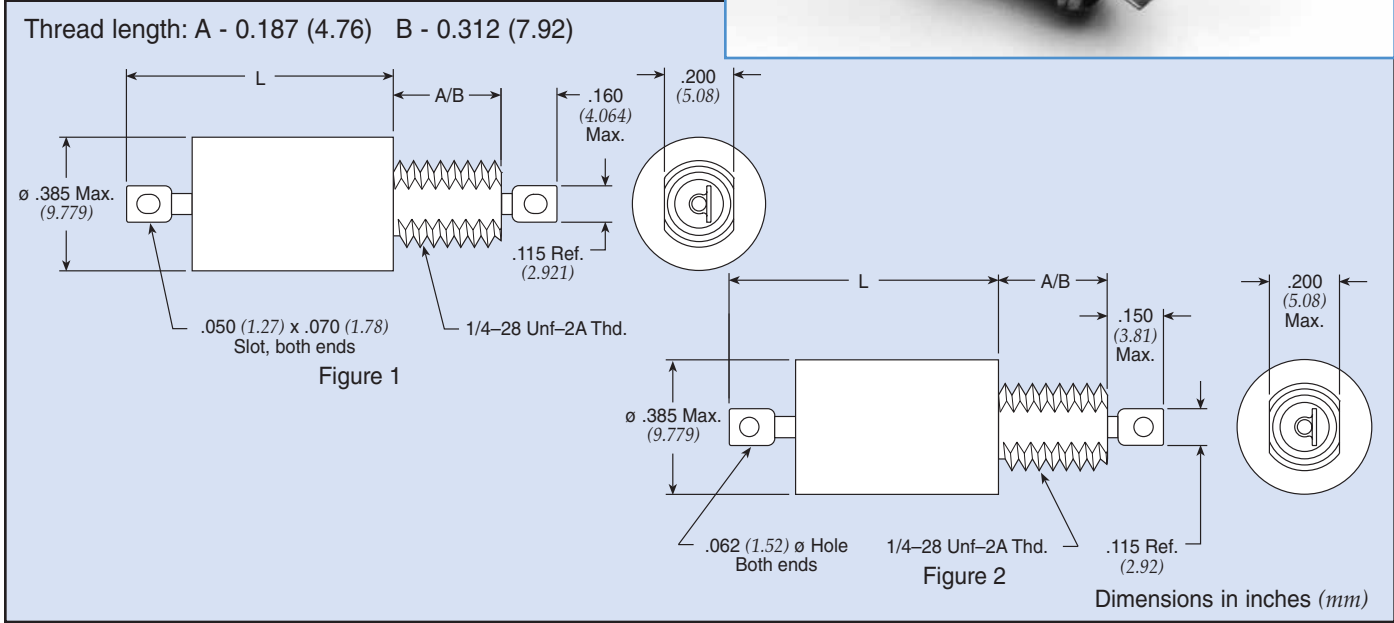

.375 ø Pi Circuit Standard Product

Part Number	MIL No	Figure	Rated Voltage				I Amp	Min Cap µF	DCR Max Ohms	Max L		Thd Lgth	Minimum Insertion Loss (dB)						
			DC	AC	DC	AC				In	(mm)		30 KHz	150 KHz	300 KHz	1 MHz	10 MHz	100 MHz	1 GHz
SCI-2030-010	—	2	80	—	50	—	0.50	1.500	1.000	0.758	(19.253)	B	24	66	70	70	70	70	
SCI-2030-004	—	2	80	—	50	—	1.00	1.500	0.250	0.758	(19.253)	A	15	54	70	70	70	70	
SCI-2030-005	—	2	80	—	50	—	2.00	1.500	0.063	0.758	(19.253)	A	—	45	62	70	70	70	
SCI-2030-006	—	2	80	—	50	—	3.00	1.500	0.027	0.758	(19.253)	A	—	35	55	70	70	70	
SCI-2030-013	—	2	80	—	50	—	3.00	1.500	0.027	0.758	(19.253)	B	—	35	55	70	70	70	
† 9001-100-1080	—	1	80	—	50	—	5.00	2.800	0.015	0.758	(19.253)	A	—	18	60	70	70	70	
† 9001-100-1081	—	1	80	—	50	—	10.0	2.800	0.005	0.758	(19.253)	A	21	32	40	35	68	70	70
SCI-2130-009	—	1	150	—	100	—	0.25	1.000	4.000	0.758	(19.253)	B	28	70	70	70	70	70	
51-311-319	—	1	150	—	100	—	0.50	1.000	0.600	0.758	(19.253)	A	—	51	69	70	70	70	
† 9001-100-1010	—	1	150	—	100	—	0.50	1.000	0.600	0.758	(19.253)	A	6	39	68	70	70	70	
51-311-320	—	1	150	—	100	—	1.00	1.000	0.250	0.758	(19.253)	A	—	41	60	70	70	70	
† 9001-100-1013	—	1	150	—	100	—	1.00	1.000	0.250	0.758	(19.253)	A	—	28	59	70	70	70	
51-311-321	—	1	150	—	100	—	3.00	1.000	0.060	0.758	(19.253)	A	—	16	41	70	70	70	
† 51-311-322	—	1	150	—	100	—	5.00	1.000	0.015	0.758	(19.253)	A	—	—	28	65	70	70	
SCI-2130-007	—	1	150	—	100	—	10.0	1.000	0.003	0.758	(19.253)	A	9	24	29	40	70	70	
SCI-2130-014	—	1	150	—	100	—	10.0	1.000	0.005	0.758	(19.253)	B	9	24	29	40	70	70	
51-311-316	—	1	250	125	200	125	1.00	0.300	0.250	0.758	(19.253)	A	—	20	40	70	70	70	
51-311-317	—	1	250	125	200	125	3.00	0.300	0.050	0.758	(19.253)	A	—	—	20	55	70	70	
† 9001-100-1025	—	1	250	125	200	125	5.00	0.300	0.015	0.758	(19.253)	A	—	—	12	50	70	70	80
SCI-2330-009	—	1	300	125	300	125	0.25	0.300	4.000	0.758	(19.253)	B	8	50	66	70	70	70	
SCI-2330-010	—	1	300	125	300	125	0.50	0.300	1.000	0.758	(19.253)	B	—	40	56	70	70	70	
SCI-2330-012	—	1	300	125	300	125	2.00	0.300	0.063	0.758	(19.253)	B	—	18	33	63	70	70	
SCI-2330-007	—	1	300	125	300	125	10.0	0.300	0.003	0.758	(19.253)	A	—	14	20	30	70	70	

† Also available through Spectrum Control's authorized distributors.

Hermetically Sealed Threaded Case Filters

.375 ø Pi Circuit MIL Qualified Product

(See MIL index on pages 244-246 for complete MIL part number listing)

Part Number	M15733 MIL No	See Pg. 91 for Fig.	Rated Voltage				I Amp	Min Cap µF	DCR Max Ohms	Max L		Thd Lgth	Minimum Insertion Loss (dB)						
			85°C		125°C					In	(mm)		30 KHz	150 KHz	300 KHz	1 MHz	10 MHz	100 MHz	1 GHz
			DC	AC	DC	AC													
51-390-305	23-0017	1	—	—	50	—	0.30	2.800	0.770	0.730	(18.542)	B	29	73	80	80	80	80	
51-390-314	23-0042	1	—	—	50	—	1.00	2.800	0.140	0.730	(18.542)	A	8	52	71	80	80	80	80
† 51-390-318	23-0054	1	—	—	50	—	2.00	1.500	0.070	0.730	(18.542)	A	—	46	65	80	80	80	80
† 51-390-317	23-0053	1	—	—	50	—	2.00	1.500	0.070	0.730	(18.542)	B	—	46	65	80	80	80	80
51-311-311	25-0010	1	—	—	100	—	0.25	0.900	1.500	0.793	(20.142)	A	—	48	66	80	80	80	70
† 51-311-308	25-0002	1	—	—	100	—	1.00	0.500	0.250	0.793	(20.142)	A	—	33	52	80	80	80	70
† 51-311-309	25-0004	1	—	—	100	—	3.00	0.660	0.050	0.793	(20.142)	A	—	17	34	68	80	80	70
† 51-311-310	25-0006	1	—	—	100	—	5.00	0.900	0.015	0.793	(20.142)	A	—	—	17	57	80	80	70
51-353-344	39-0011	1	—	—	100	—	10.0	0.990	0.003	0.760	(19.304)	A	9	24	29	40	70	70	70
51-353-345	39-0012	1	—	—	100	—	10.0	0.990	0.003	0.760	(19.304)	A	9	24	29	40	70	70	70
† 51-311-314	26-0011	1	—	—	150	125	0.25	0.300	1.500	0.793	(20.142)	A	—	29	47	70	80	80	70
51-390-312	23-0036	1	—	—	150	—	0.50	0.500	0.360	0.730	(18.542)	A	—	48	66	70	70	70	70
51-390-311	23-0035	1	—	—	150	—	0.50	0.500	0.360	0.730	(18.542)	B	—	48	66	70	70	70	70
† 51-353-336	26-0002	1	—	—	150	125	1.00	0.300	0.250	0.793	(20.142)	A	—	11	32	63	80	80	70
51-390-315	23-0047	1	—	—	150	—	1.00	0.500	0.140	0.730	(18.542)	B	—	32	51	70	70	70	70
51-311-312	26-0005	1	—	—	150	125	3.00	0.300	0.050	0.793	(20.142)	A	—	5	6	47	80	80	70
51-311-408	54-0005	2	—	—	300	115	1.00	0.300	0.250	0.761	(19.329)	A	—	23	43	70	70	70	70

† Also available through Spectrum Control's authorized distributors.

Transient Suppression Pi Filters

Part Number	See Pg. 91 for Fig.	Rated Volt. VDC	I Amp	Min Cap µF	DCR Min Mohms	Max RDC Ohms	Transient Suppressor*				Length		Max Thd Lgth	Minimum Insertion Loss (dB)						
							VR* (VDC)	BV* (VDC)	IT* (MA)	IPP* (A)	In	(mm)		30 KHz	300 KHz	1 MHz	10 MHz	100 MHz	1 GHz	
51-570-300	1	5	0.50	1.400	0.500	0.600	6.5	7.22/7.98	10	44.7	1.179	(29.947)	A	23	57	70	70	70	70	
51-570-301	1	5	1.00	1.400	0.500	0.350	6.5	7.22/7.98	10	44.7	1.179	(29.947)	A	3	47	70	70	70	70	
51-570-302	1	5	3.00	1.400	0.500	0.060	6.5	7.22/7.98	10	44.7	1.179	(29.947)	A	—	23	58	70	70	70	
51-570-303	1	5	5.00	1.400	0.500	0.015	6.5	7.22/7.98	10	44.7	1.179	(29.947)	A	—	17	48	70	70	70	
51-570-304	1	5	10.00	1.400	0.500	0.005	6.5	7.22/7.98	10	44.7	1.179	(29.947)	A	16	26	35	40	60	70	
51-570-310	1	28	0.50	1.400	30.000	0.600	33.0	36.7/40.6	1	9.4	1.179	(29.947)	A	23	57	70	70	70	70	
51-570-311	1	28	1.00	1.400	30.000	0.350	33.0	36.7/40.6	1	9.4	1.179	(29.947)	A	3	47	70	70	70	70	
51-570-312	1	28	3.00	1.400	30.000	0.060	33.0	36.7/40.6	1	9.4	1.179	(29.947)	A	—	23	58	70	70	70	
51-570-313	1	28	5.00	1.400	30.000	0.015	33.0	36.7/40.6	1	9.4	1.179	(29.947)	A	—	17	48	70	70	70	
51-570-314	1	28	10.00	1.400	30.000	0.005	33.0	36.7/40.6	1	9.4	1.179	(29.947)	A	16	26	35	40	60	70	
51-570-320	1	50	0.50	1.400	50.000	0.600	58.0	64.4/71.2	1	5.3	1.179	(29.947)	A	23	57	70	70	70	70	
51-570-321	1	50	1.00	1.400	50.000	0.350	58.0	64.4/71.2	1	5.3	1.179	(29.947)	A	3	47	70	70	70	70	
51-570-322	1	50	3.00	1.400	50.000	0.060	58.0	64.4/71.2	1	5.3	1.179	(29.947)	A	—	23	58	70	70	70	
51-570-323	1	50	5.00	1.400	50.000	0.015	58.0	64.4/71.2	1	5.3	1.179	(29.947)	A	—	17	48	70	70	70	
51-570-324	1	50	10.00	1.400	50.000	0.005	58.0	64.4/71.2	1	5.3	1.179	(29.947)	A	16	26	35	40	60	70	

* Transient Suppression definitions and ratings

VR = Reverse standoff voltage
BV = Breakdown voltage

IPP = Max. peak pulse current
IT = Test current

Hermetically Sealed Threaded Case Filters



.375 ø T Circuit

Thread length: A - 0.187 (4.76) B - 0.312 (7.92)

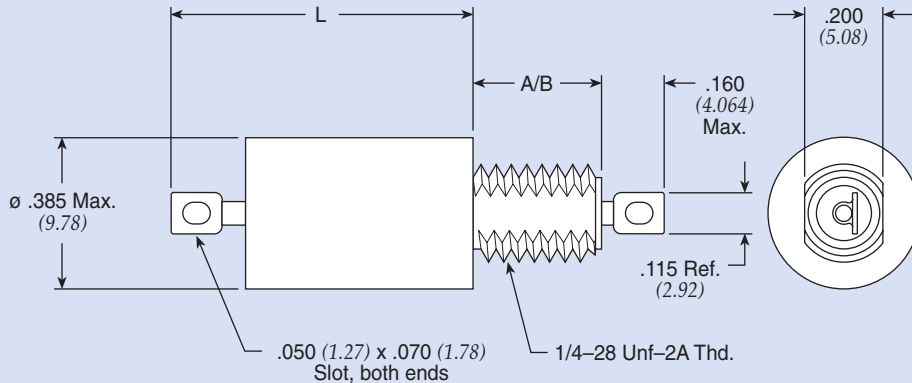

Figure 1

Note: Max. O.D. is ø .416" for Military QPL Filters.

Dimensions in inches (mm)

.375 ø T Circuit Standard Product

Part Number	MIL No	Figure	Rated Voltage				I Amp	Min Cap μ F	DCR Max Ohms	Max L		Thd Lgth	Minimum Insertion Loss (dB)						
			85°C		125°C					In	(mm)		30 KHz	150 KHz	300 KHz	1 MHz	10 MHz	100 MHz	1 GHz
SCI-2040-012	—	1	80	—	50	—	2.00	1.400	0.126	1.071	(27.203)	B	8	22	30	55	70	70	70
SCI-2040-013	—	1	80	—	50	—	3.00	1.400	0.054	1.071	(27.203)	B	8	22	28	43	70	70	70
† 9004-100-2017	—	1	80	—	50	—	15.0	1.400	0.005	1.179	(29.947)	A	17	27	34	44	60	70	70
SCI-2140-004	—	1	150	—	100	—	1.00	0.500	0.500	1.070	(27.178)	A	4	25	40	70	70	70	70
SCI-2140-006	—	1	150	—	100	—	3.00	0.500	0.054	1.071	(27.203)	A	4	19	24	39	70	70	70
SCI-2140-007	—	1	150	—	100	—	10.0	0.500	0.010	1.071	(27.203)	A	4	19	24	34	57	70	70
SCI-2340-009	—	1	300	—	300	125	0.25	0.150	8.000	1.071	(27.203)	B	11	57	70	70	70	70	70
SCI-2340-004	—	1	300	—	300	125	1.00	0.150	0.500	1.071	(27.203)	A	—	13	29	59	70	70	70
SCI-2340-013	—	1	300	—	300	125	3.00	0.150	0.054	1.071	(27.203)	B	—	8	14	29	70	70	70
SCI-2340-014	—	1	300	—	300	125	10.0	0.150	0.010	1.071	(27.203)	B	—	8	14	24	47	70	70

† Also available through Spectrum Control's authorized distributors.

(See MIL index on page 244-246 for complete MIL part number listing)

.375 ø T Circuit MIL Qualified Product

Part Number	M15733 MIL No	Figure	Rated Voltage				I Amp	Min Cap μ F	DCR Max Ohms	Max L		Thd Lgth	Minimum Insertion Loss (dB)						
			85°C		125°C					In	(mm)		30 KHz	150 KHz	300 KHz	1 MHz	10 MHz	100 MHz	1 GHz
51-382-609	25-0024	1	—	—	100	—	2.00	0.750	0.100	1.179	(29.947)	B	10	22	31	55	80	70	70
51-382-603	25-0007	1	—	—	100	—	4.00	0.750	0.063	1.345	(34.163)	A	10	22	28	43	80	70	70
† 51-351-604	26-0012	1	—	—	150	125	2.00	0.250	0.100	1.179	(29.947)	A	—	13	21	43	80	70	70
51-351-603	26-0008	1	—	—	150	125	4.00	0.250	0.063	1.345	(34.163)	A	—	11	18	33	80	70	70

† Also available through Spectrum Control's authorized distributors.

Hermetically Sealed Threaded Case Filters

.375 ø TT Circuit Standard Product

Part Number	MIL No	See Pg. 93 for Fig.	Rated Voltage				I Amp	Min Cap μ F	DCR Max Ohms	Max L		Thd Lgth	Minimum Insertion Loss (dB)						
			85°C		125°C					In	(mm)		30 KHz	150 KHz	300 KHz	1 MHz	10 MHz	100 MHz	1 GHz
			DC	AC	DC	AC													
SCI-2060-009	—	1	—	—	50	—	0.25	1.500	12.000	1.241	(31.521)	B	70	70	70	70	70	70	70
SCI-2060-013	—	1	—	—	50	—	3.00	1.500	0.081	1.241	(31.521)	B	—	33	54	70	70	70	70
SCI-2060-007	—	1	—	—	50	—	10.0	1.500	0.006	1.241	(31.521)	A	15	29	35	42	55	70	70
SCI-2060-014	—	1	—	—	50	—	10.0	1.500	0.006	1.241	(31.521)	B	15	29	35	42	55	70	70
SCI-2160-011	—	1	—	—	100	—	1.00	1.500	0.750	1.241	(31.521)	B	12	52	70	70	70	70	70
SCI-2160-012	—	1	—	—	100	—	2.00	1.500	0.189	1.241	(31.521)	B	—	33	56	70	70	70	70
SCI-2160-013	—	1	—	—	100	—	3.00	1.500	0.081	1.241	(31.521)	B	—	24	54	70	70	70	70
SCI-2160-014	—	1	—	—	100	—	10.0	1.400	0.006	1.241	(31.521)	B	12	25	32	42	55	70	70
SCI-2360-011	—	1	—	—	300	125	1.00	0.500	0.750	1.241	(31.521)	B	—	48	70	70	70	70	70
SCI-2360-006	—	1	—	—	300	125	3.00	0.500	0.080	1.241	(31.521)	A	—	12	38	70	70	70	70
SCI-2360-007	—	1	—	—	300	125	10.0	0.500	0.006	1.241	(31.521)	A	5	18	24	34	55	70	70
SCI-2360-014	—	1	—	—	300	125	10.0	0.500	0.006	1.241	(31.521)	B	5	18	24	34	55	70	70

Hermetically Sealed Threaded Case Filters



.690 ø C Circuit

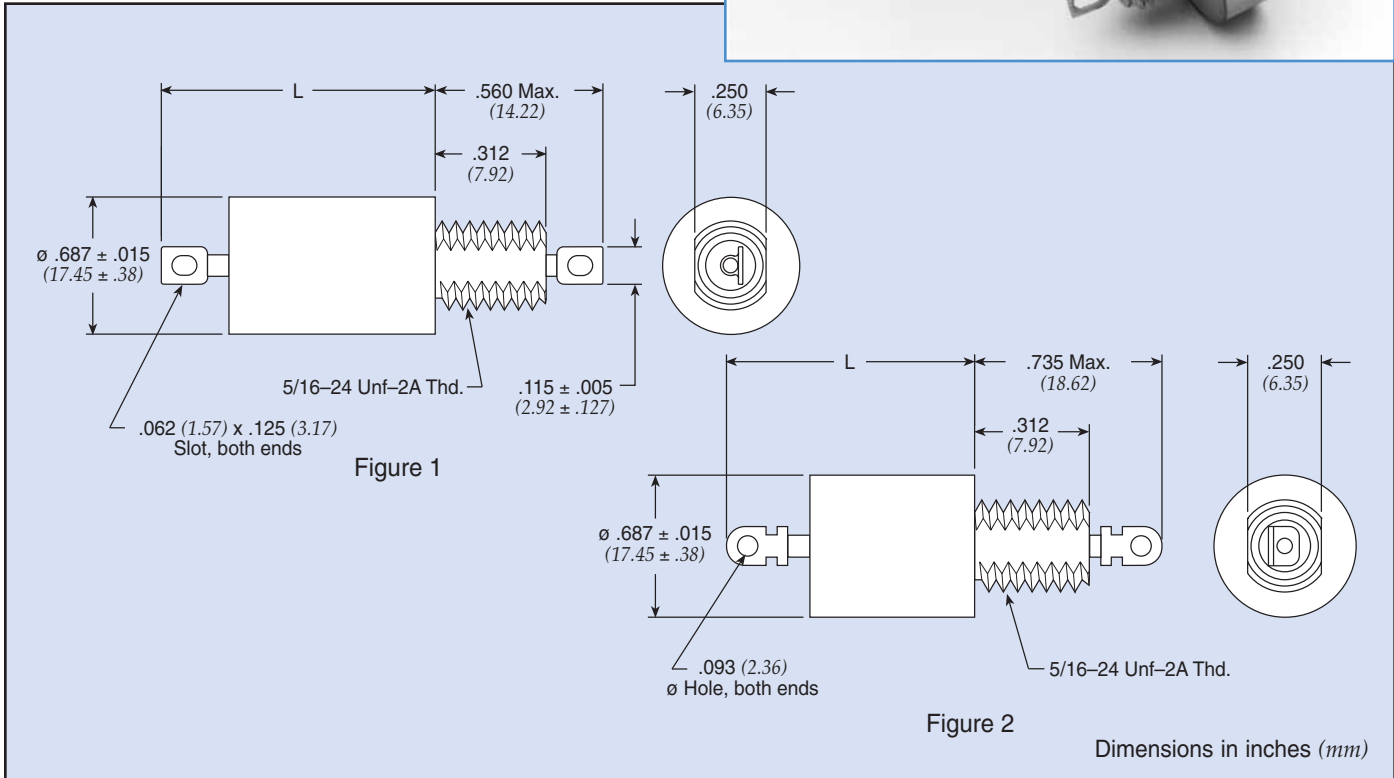

.690 ø C Circuit Standard Product

Part Number	MIL No	Figure	Rated Voltage				I Amp	Min Cap μF	DCR Max Ohms	Max L		Minimum Insertion Loss (dB)						
			DC	AC	DC	AC				In	(mm)	30 KHz	150 KHz	300 KHz	1 MHz	10 MHz	100 MHz	1 GHz
†9932-100-6004	—	1	200	—	150	125	15	2.600	0.005	0.702	(17.831)	10	29	39	50	60	70	70
54-310-001	—	1	300	—	300	125	15	0.500	0.005	0.560	(14.224)	6	19	25	36	50	70	70
54-310-005	—	2	250	—	200	125	25	0.500	0.005	0.750	(19.050)	6	19	25	36	50	70	70
54-310-009	—	1	450	240	400	240	15	0.250	0.005	0.560	(14.224)	—	14	19	30	45	60	70
†9932-100-6005	—	1	450	240	400	240	15	0.250	0.005	0.560	(14.224)	—	14	19	30	50	70	70

.690 ø C Circuit MIL Qualified Product

Part Number	M15733 MIL No	Figure	Rated Voltage				I Amp	Min Cap μF	DCR Max Ohms	Max L		Minimum Insertion Loss (dB)						
			DC	AC	DC	AC				In	(mm)	30 KHz	150 KHz	300 KHz	1 MHz	10 MHz	100 MHz	1 GHz
54-310-039	34-0037	1	—	—	275	125	15	0.200	0.005	0.575	(14.605)	5	15	21	31	51	70	70

.690 ø C Circuit DSCC 84084 Product

Part Number	84084 No	Figure	Rated Voltage				I Amp	Min Cap μF	DCR Max Ohms	Max L		Minimum Insertion Loss (dB)						
			DC	AC	DC	AC				In	(mm)	30 KHz	150 KHz	300 KHz	1 MHz	10 MHz	100 MHz	1 GHz
54-310-042	-001	1	—	—	400	230	15	0.150	0.005	0.700	(17.780)	—	10	16	26	40	52	70

† Also available through Spectrum Control's authorized distributors.

Hermetically Sealed Threaded Case Filters



.690 ø L Circuit

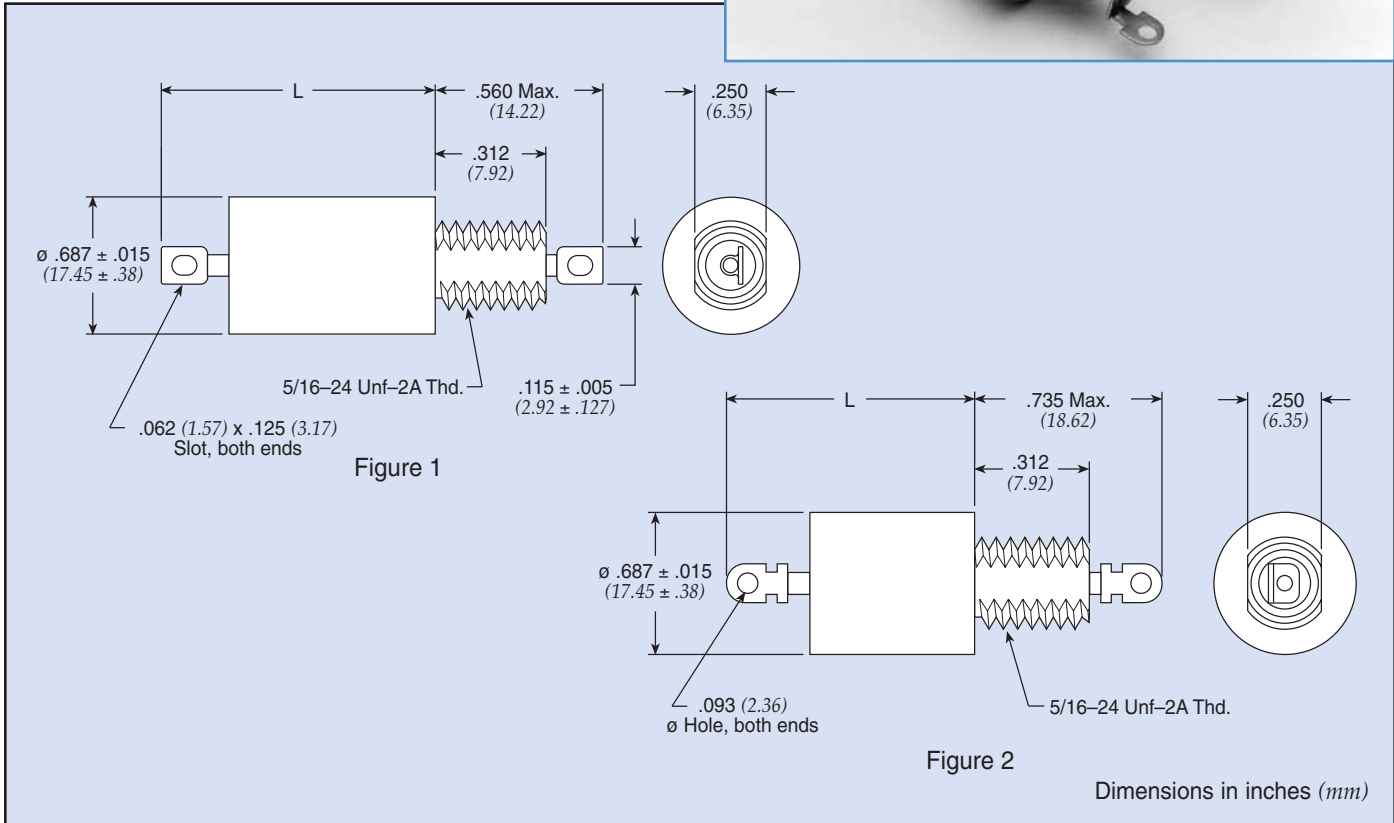

.690 ø L Circuit Standard Product

Part Number	MIL No	Figure	Rated Voltage				I Amp	Min Cap µF	DCR Max Ohms	CKT	Max L		Minimum Insertion Loss (dB)						
			85°C		125°C						In	L (mm)	30 KHz	150 KHz	300 KHz	1 MHz	10 MHz	100 MHz	1 GHz
			DC	AC	DC	AC													
9010-100-0049	—	1	150	—	100	—	10.0	1.400	0.005	LT	0.905 (22.987)	16	24	34	44	60	70	70	
SCI-6120-008	—	1	150	—	100	—	10.0	2.600	0.006	LB	0.959 (24.359)	18	32	39	49	70	70	70	
SCI-6120-009	—	1	150	—	100	—	20.0	2.600	0.001	LB	0.905 (22.987)	18	32	39	49	60	70	70	
51-320-041	—	1	250	—	200	125	10.0	0.500	0.008	LT	0.905 (22.987)	5	19	25	35	50	70	70	
51-320-024	—	1	450	240	400	240	1.00	0.360	0.210	LT	0.905 (22.987)	5	30	38	60	70	70	70	
51-320-100	—	1	450	240	400	240	1.00	0.250	0.210	LT	0.905 (22.987)	—	21	33	55	70	70	70	
† 51-320-026	—	1	450	240	400	240	3.00	0.360	0.030	LT	0.905 (22.987)	5	19	25	45	70	70	70	
51-320-103	—	1	450	240	400	240	5.00	0.360	0.010	LB	0.905 (22.987)	—	12	18	30	60	70	70	
51-322-007	—	1	450	240	400	240	15.0	0.360	0.007	LB	0.650 (16.510)	5	19	25	35	48	62	70	
51-322-015	—	2	450	240	400	240	25.0	0.360	0.007	LT	0.750 (19.050)	5	17	23	34	48	62	70	
51-322-036	—	2	450	240	400	240	25.0	0.250	0.007	LB	0.750 (19.050)	—	10	16	29	45	60	70	
9010-100-0054	—	1	450	240	300	240	1.00	0.150	0.250	LT	0.905 (22.987)	—	14	32	52	70	70	70	
SCI-6320-004	—	1	300	—	300	125	1.00	0.400	0.300	LB	0.959 (24.359)	6	24	35	56	70	70	70	

† Also available through Spectrum Control's authorized distributors.

Hermetically Sealed Threaded Case Filters

L-C Filter LT

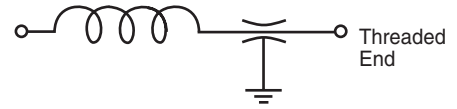

L-C Filter LB



(See MIL index on page 244-246 for complete MIL part number listing)

.690 ø L Circuit MIL Qualified Product

Part Number	M15733 MIL No	See Pg. 96 for Fig.	Rated Voltage				I Amp	Min Cap µF	DCR Max Ohms	CKT	Max L In	Max L (mm)	Minimum Insertion Loss (dB)							
			85°C		125°C								30 KHz	150 KHz	300 KHz	1 MHz	10 MHz	100 MHz	1 GHz	
			DC	AC	DC	AC														
† 51-320-015	27-0005	1	—	—	200	125	3.00	0.250	0.033	LT	0.900	(22.860)	—	14	21	39	80	70	70	
51-320-017	27-0008	1	—	—	200	125	5.00	0.250	0.016	LT	0.900	(22.860)	—	13	19	32	69	70	70	
51-320-018	27-0009	1	—	—	200	125	5.00	0.250	0.016	LB	0.900	(22.860)	—	13	19	32	69	70	70	
51-323-003	27-0011	1	—	—	200	125	10.0	0.250	0.005	LT	1.031	(26.187)	—	13	19	30	61	70	70	
51-323-004	27-0012	1	—	—	200	125	10.0	0.250	0.005	LB	1.031	(26.187)	—	13	19	30	61	70	70	
† 51-322-009	27-0014	2	—	—	200	125	15.0	0.250	0.007	LT	1.763	(44.780)	—	19	25	36	60	70	70	
51-322-017	34-0002	2	—	—	200	125	20.0	0.360	0.050	LB	1.763	(44.780)	—	19	25	35	57	70	70	

.690 ø L Circuit DSCC 84084 Product

Part Number	84084 No	See Pg. 96 for Fig.	Rated Voltage				I Amp	Min Cap µF	DCR Max Ohms	CKT	Max L In	Max L (mm)	Minimum Insertion Loss (dB)							
			85°C		125°C								30 KHz	150 KHz	300 KHz	1 MHz	10 MHz	100 MHz	1 GHz	
			DC	AC	DC	AC														
51-320-162	-004	1	—	—	400	230	1.00	0.150	0.150	LT	0.905	(22.987)	—	19	30	46	60	70	70	
51-320-163	-005	1	—	—	400	230	1.00	0.150	0.150	LB	0.905	(22.987)	—	19	30	46	60	70	70	
51-320-164	-006	1	—	—	400	230	3.00	0.150	0.026	LT	0.905	(22.987)	—	11	19	36	60	70	70	
51-320-165	-007	1	—	—	400	230	3.00	0.150	0.026	LB	0.905	(22.987)	—	11	19	36	60	70	70	
51-320-166	-008	1	—	—	400	230	5.00	0.150	0.013	LT	0.905	(22.987)	—	10	16	28	54	70	70	
51-320-167	-009	1	—	—	400	230	5.00	0.150	0.013	LB	0.905	(22.987)	—	10	16	28	54	70	70	
51-320-168	-010	1	—	—	400	230	10.0	0.150	0.008	LT	0.905	(22.987)	—	10	16	25	48	70	70	
51-320-169	-011	1	—	—	400	230	10.0	0.150	0.008	LB	0.905	(22.987)	—	10	16	25	48	70	70	

† Also available through Spectrum Control's authorized distributors.

Hermetically Sealed Threaded Case Filters

.690 ø Pi Circuit

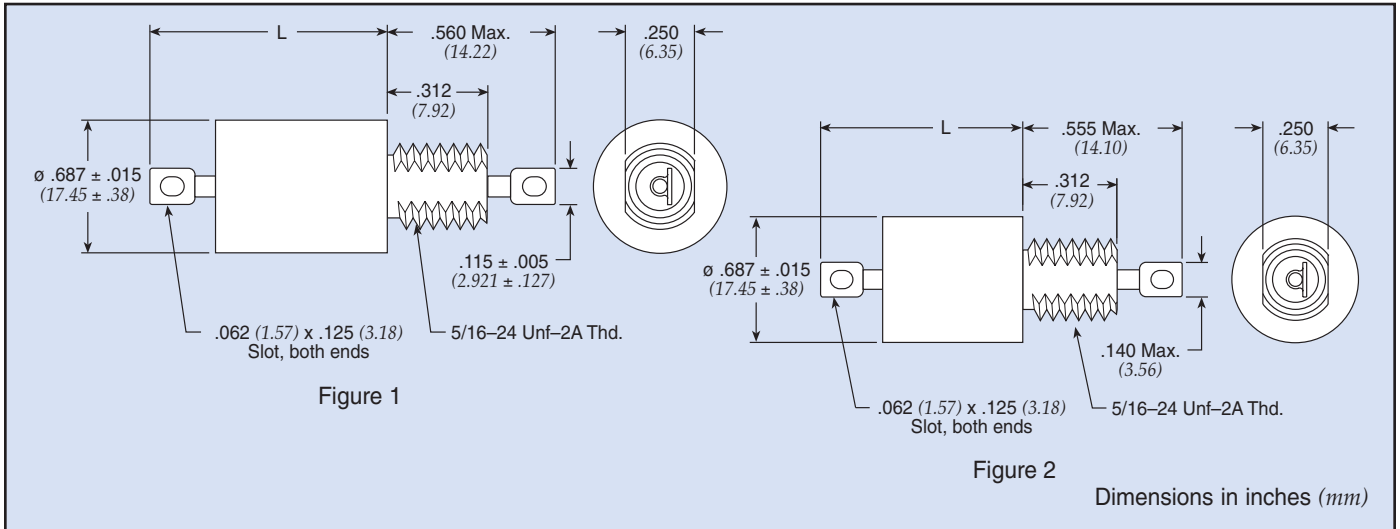

Low Pass Filters

.690 ø Pi Circuit Standard Product

Part Number	MIL No	Figure	Rated Voltage				I Amp	Min Cap μ F	DCR Max Ohms	Max L (mm)		Minimum Insertion Loss (dB)						
			85°C		125°C							30 KHz	150 KHz	300 KHz	1 MHz	10 MHz	100 MHz	1 GHz
			DC	AC	DC	AC						In	L					
51-321-322	—	1	150	—	100	—	1.00	2.800	0.210	1.195	(30.353)	35	69	70	70	70	70	70
SCI-6130-009	—	1	150	—	100	—	20.0	5.200	0.001	1.195	(30.353)	23	31	35	35	70	70	70
51-321-317	—	1	450	240	400	*240	1.00	0.720	0.400	1.195	(30.353)	—	53	70	70	70	70	70
†51-321-318	—	1	450	240	400	*240	3.00	0.720	0.030	1.195	(30.353)	—	31	51	70	70	70	70
†51-321-319	—	1	450	240	400	*240	5.00	0.720	0.020	1.195	(30.353)	—	11	30	65	70	70	70

* 0-60 Hz

(See MIL index on page 244-246 for complete MIL part number listing)

.690 ø Pi Circuit MIL Qualified Product

Part Number	M15733 MIL No	Figure	Rated Voltage				I Amp	Min Cap μ F	DCR Max Ohms	Max L (mm)		Minimum Insertion Loss (dB)						
			85°C		125°C							30 KHz	150 KHz	300 KHz	1 MHz	10 MHz	100 MHz	1 GHz
			DC	AC	DC	AC						In	L					
51-321-312	27-0004	1	—	—	200	125	1.00	0.500	0.250	1.195	(30.353)	—	47	65	80	80	70	70
51-323-313	27-0003	1	—	—	200	125	1.00	0.500	0.270	1.031	(26.187)	—	43	61	80	80	70	70
51-321-313	27-0010	1	—	—	200	125	5.00	0.500	0.024	1.195	(30.353)	—	10	28	64	80	70	70
†51-321-314	27-0013	1	—	—	200	125	10.0	0.500	0.008	1.195	(30.353)	—	16	18	48	80	70	70
51-321-329	34-0005	1	—	—	200	125	10.0	0.500	0.075	1.195	(30.353)	—	16	18	48	80	70	70

.690 ø Pi Circuit DSCC 84084 Product

Part Number	84084 No	Figure	Rated Voltage				I Amp	Min Cap μ F	DCR Max Ohms	Max L (mm)		Minimum Insertion Loss (dB)						
			85°C		125°C							30 KHz	150 KHz	300 KHz	1 MHz	10 MHz	100 MHz	1 GHz
			DC	AC	DC	AC						In	L					
51-321-398	-013	2	—	—	400	230	1.00	0.200	0.150	1.200	(30.480)	—	27	46	74	80	80	80
51-321-399	-014	2	—	—	400	230	3.00	0.200	0.026	1.200	(30.480)	—	—	30	60	80	80	80
51-321-400	-015	2	—	—	400	230	5.00	0.200	0.013	1.200	(30.480)	—	—	12	50	80	80	80
51-321-401	-016	2	—	—	400	230	10.0	0.200	0.008	1.200	(30.480)	—	—	—	30	80	80	80

† Also available through Spectrum Control's authorized distributors.

Hermetically Sealed Threaded Case Filters

.690 ø T Circuit

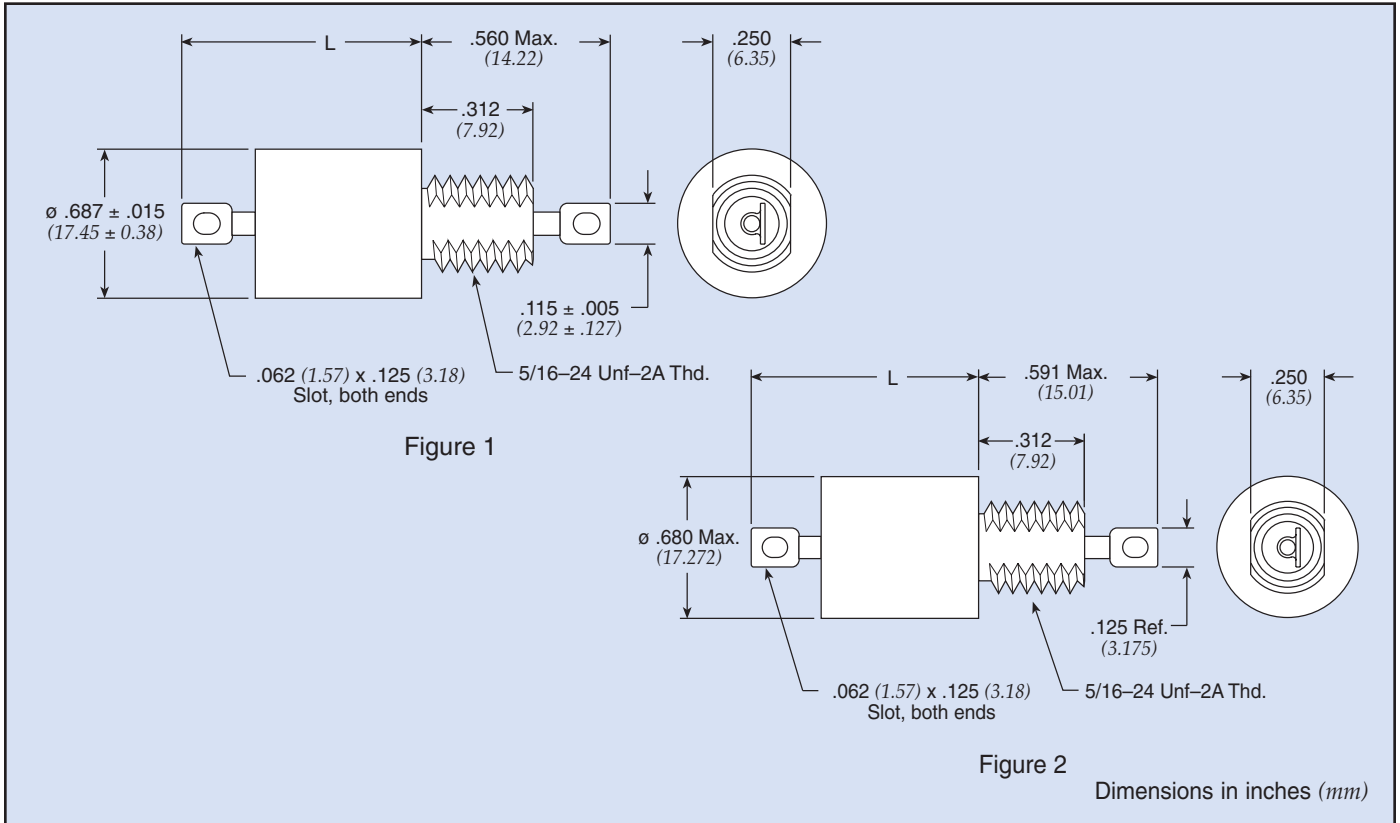

.690 ø T Circuit Standard Product

Part Number	MIL No	Figure	Rated Voltage				I Amp	Min Cap μ F	DCR Max Ohms	Max L (mm)		Minimum Insertion Loss (dB)						
			85°C		125°C							30 KHz	150 KHz	300 KHz	1 MHz	10 MHz	100 MHz	1 GHz
			DC	AC	DC	AC						In						
SCI-6140-004	—	1	150	—	100	—	1.00	2.600	0.600	1.195	(30.353)	23	54	70	70	70	70	70
SCI-6140-006	—	1	150	—	100	—	3.00	2.600	0.100	1.195	(30.353)	21	35	46	70	70	70	70
SCI-6140-007	—	1	150	—	100	—	5.00	2.600	0.060	1.195	(30.353)	21	34	41	58	70	70	70
SCI-6140-009	—	1	150	—	100	—	20.0	2.600	0.002	1.195	(30.353)	21	35	41	50	60	70	70
51-321-649	—	1	250	125	200	125	2.00	0.360	0.090	1.195	(30.353)	—	24	38	65	70	70	70
† 51-321-610	—	1	450	240	400	240	1.00	0.360	0.600	1.195	(30.353)	7	43	60	70	70	70	70

.690 ø T Circuit MIL Qualified Product

(See MIL index on pages 244-246 for complete MIL part number listing)

Part Number	M15733 MIL No	Figure	Rated Voltage				I Amp	Min Cap μ F	DCR Max Ohms	Max L (mm)		Minimum Insertion Loss (dB)						
			85°C		125°C							30 KHz	150 KHz	300 KHz	1 MHz	10 MHz	100 MHz	1 GHz
			DC	AC	DC	AC						In						
51-321-607	27-0017	1	—	—	200	125	1.50	0.250	0.133	1.195	(30.353)	—	19	32	62	70	70	70
51-321-608	27-0018	1	—	—	200	125	4.00	0.250	0.025	1.195	(30.353)	—	14	21	36	70	70	70
51-321-670	54-0017	2	—	—	300	115	10.0	0.500	0.006	1.177	(29.896)	5	20	23	35	60	70	60

† Also available through Spectrum Control's authorized distributors.