

### 2 mode Noise Filters

Type: **EXC24CB/CP**  
**EXC24CN**



#### ■ Features

- Burst/radiation noise filtering for audio circuits
- The optimally magnetic-coupled ferrite beads allow for the filtering of both common and normal mode noises
- The strong multi-layer structure provides high resistance to reflow soldering heat and a high mounting reliability
- Magnetic shield type
- High Impedance : 220 to 1 k $\Omega$  (EXC24CB type)
- Low Resistance Value : 0.4  $\Omega$  max. (EXC24CP type)
- High Impedance : 600  $\Omega$ , Low Resistance Value : 0.9  $\Omega$  max. (EXC24CN type)
- RoHS compliant

#### ■ Recommended Applications

- Receiver lines, speaker lines, microphone lines and headset of mobile phones.
- Audio signal lines of Portable audio equipment, PCs, PDAs.

#### ■ Explanation of Part Numbers

##### ● EXC24CB/CP Type

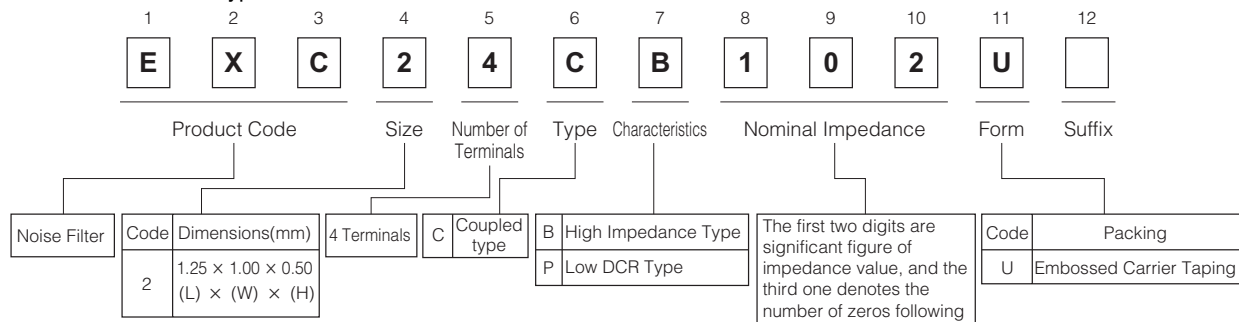

##### ● EXC24CN Type

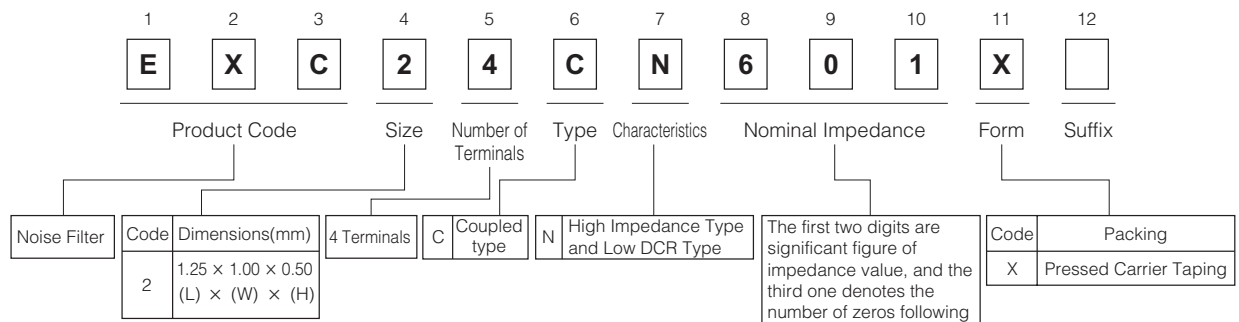

#### ■ Construction

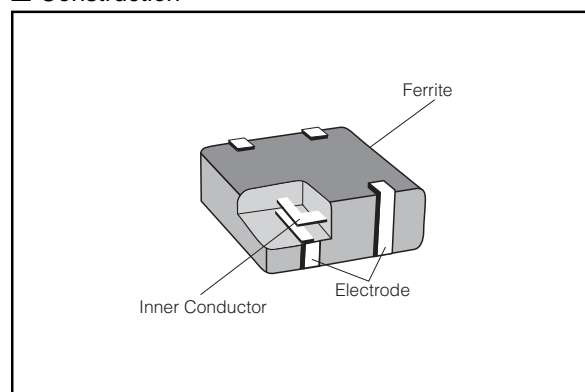

#### ■ Dimensions in mm (not to scale)

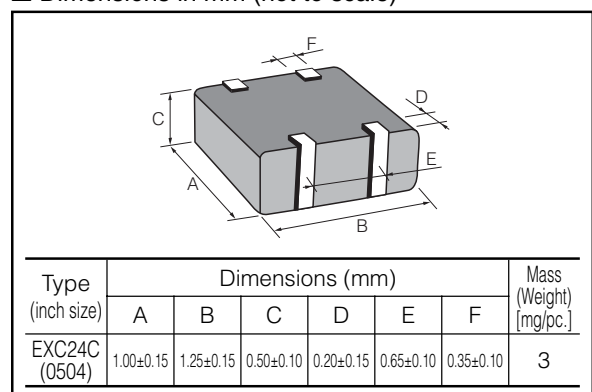

Design and specifications are each subject to change without notice. Ask factory for the current technical specifications before purchase and/or use. Should a safety concern arise regarding this product, please be sure to contact us immediately.

### ■ Circuit Configuration (No Polarity)

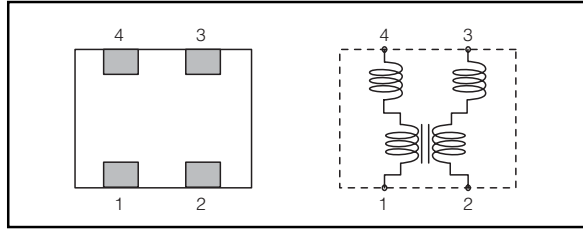

### ■ Ratings

Part Number	Impedance (Open mode)		Rated Voltage (V DC)	Rated Current (mA DC)	DC Resistance ( $\Omega$ ) max.
	( $\Omega$ ) at 100MHz	Tolerance(%)			
EXC24CP121U	120	±25	5	500	0.3
EXC24CP221U	220			350	0.4
EXC24CB221U	220			100	0.7
EXC24CB102U	1000			50	1.5

Part Number	Impedance (Common mode)		Rated Voltage (V DC)	Rated Current (mA DC)	DC Resistance ( $\Omega$ ) max.
	( $\Omega$ ) at 100MHz	Tolerance(%)			
EXC24CN601X	600	±25	5	200	0.9

● Category Temperature Range -40 °C to +85 °C

### ■ Impedance Characteristics (Typical)

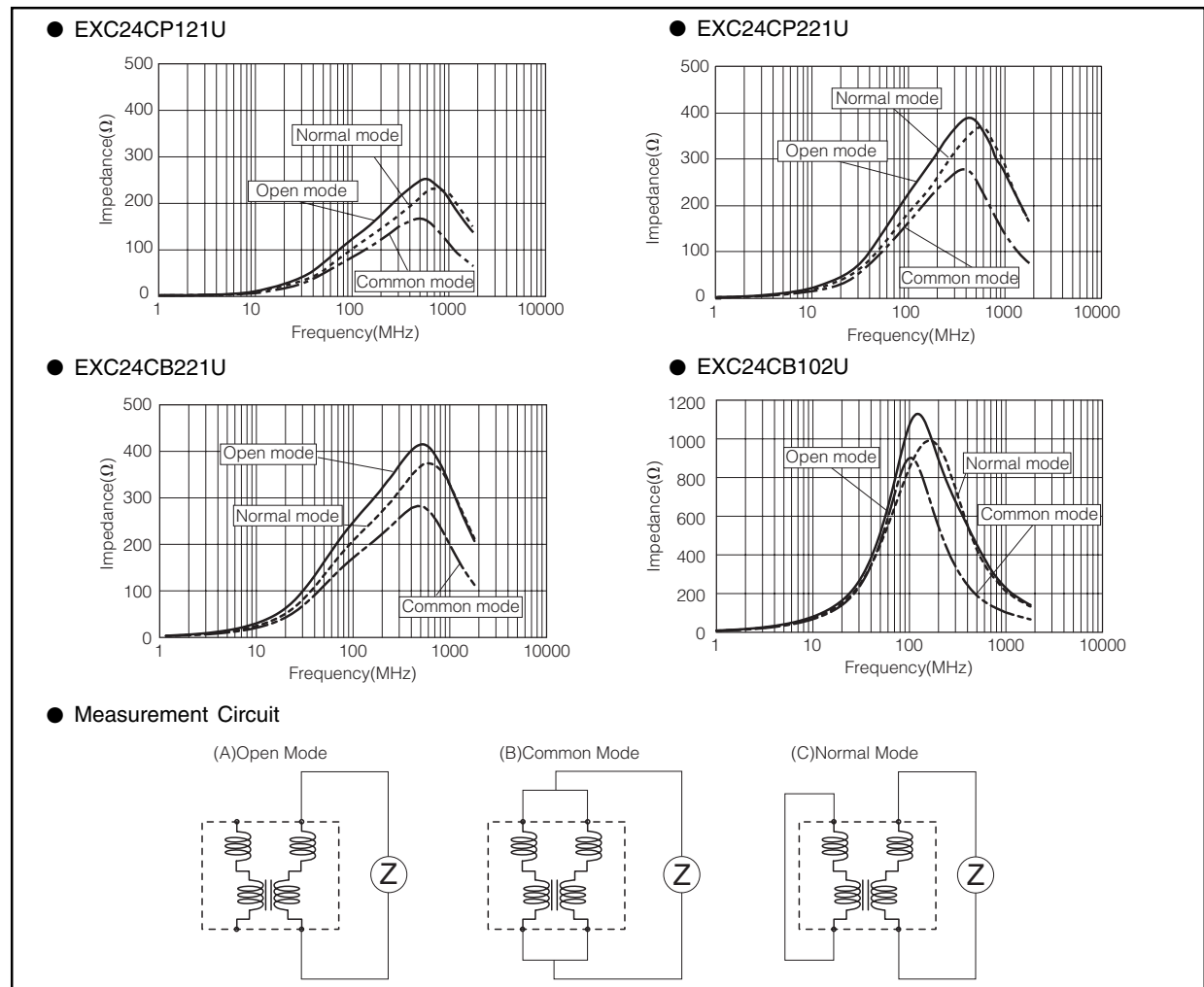

Design and specifications are each subject to change without notice. Ask factory for the current technical specifications before purchase and/or use. Should a safety concern arise regarding this product, please be sure to contact us immediately.

01 Feb. 2011

### Impedance Characteristics (Typical)

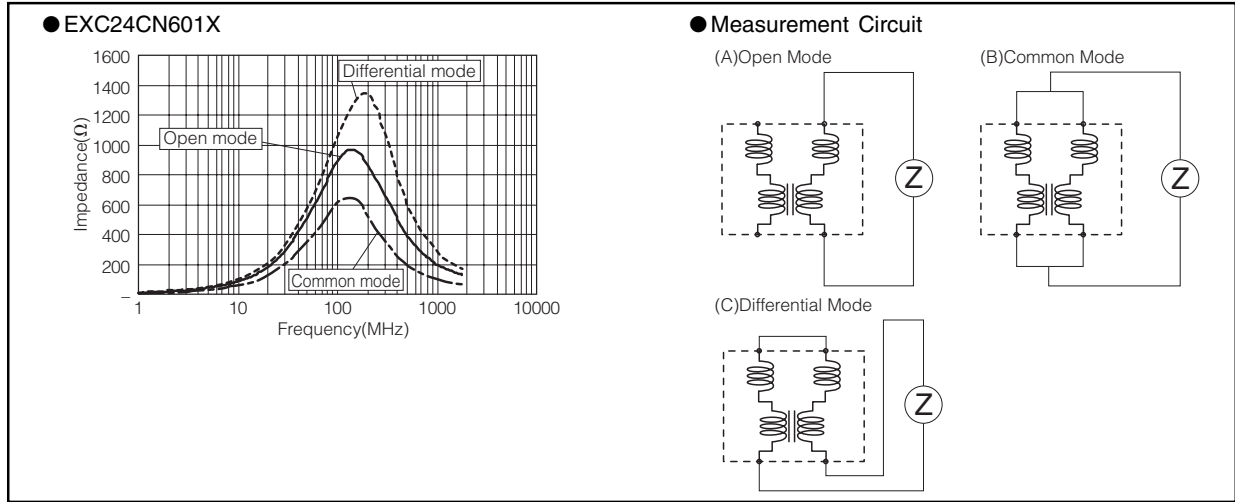

### Packaging Methods (Taping)

● Standard Quantity

Part Number	Kind of Taping	Pitch (P <sub>1</sub> )	Quantity
EXC24CP□□□□U	Embossed Carrier Taping	4 mm	5000 pcs./reel
EXC24CB□□□□U			
EXC24CN□□□□X	Pressed Carrier Taping	2 mm	10000 pcs./reel

#### Embossed Carrier Taping

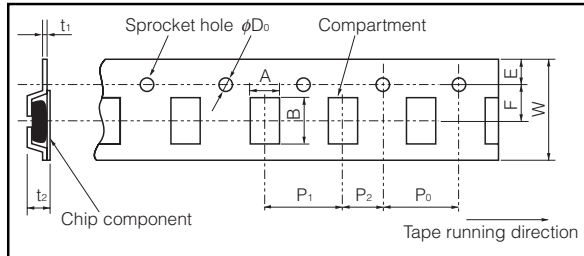

#### Pressed Carrier Taping

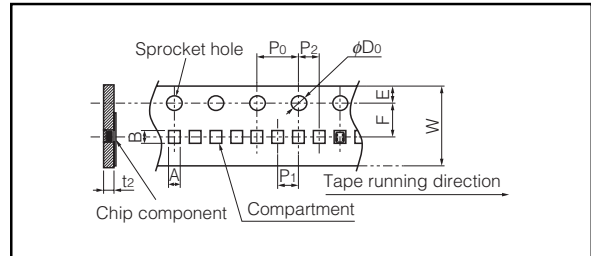

#### Taping Reel

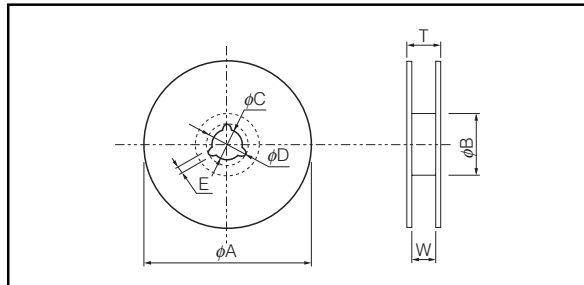

#### Embossed Carrier Dimensions (mm)

Part Number	A	B	W	F	E	P <sub>1</sub>	P <sub>2</sub>	P <sub>0</sub>	φD <sub>0</sub>	t <sub>1</sub>	t <sub>2</sub>
EXC24CP□□□□U	1.20±0.15	1.45±0.15	8.0±0.2	3.5±0.1	1.75±0.10	4.0±0.1	2.0±0.1	4.0±0.1	1.5±0.1	0.25±0.05	0.90±0.15
EXC24CB□□□□U											

#### Pressed Carrier Dimensions (mm)

Part Number	A	B	W	F	E	P <sub>1</sub>	P <sub>2</sub>	P <sub>0</sub>	φD <sub>0</sub>	t <sub>2</sub>
EXC24CN□□□□X	1.14±0.10	1.38±0.15	8.0±0.2	3.5±0.1	1.75±0.10	2.0±0.1	2.0±0.1	4.0±0.1	1.5±0.1	0.68±0.10

#### Standard Reel Dimensions (mm)

Part Number	φA	φB	φC	φD	E	W	T
EXC24C□□□□□	180.0±3.0	60.0±1.0	13.0±0.5	21.0±0.8	2.0±0.5	9.0±0.3	11.4±1.5

Design and specifications are each subject to change without notice. Ask factory for the current technical specifications before purchase and/or use. Should a safety concern arise regarding this product, please be sure to contact us immediately.

### Recommended Land Pattern Design

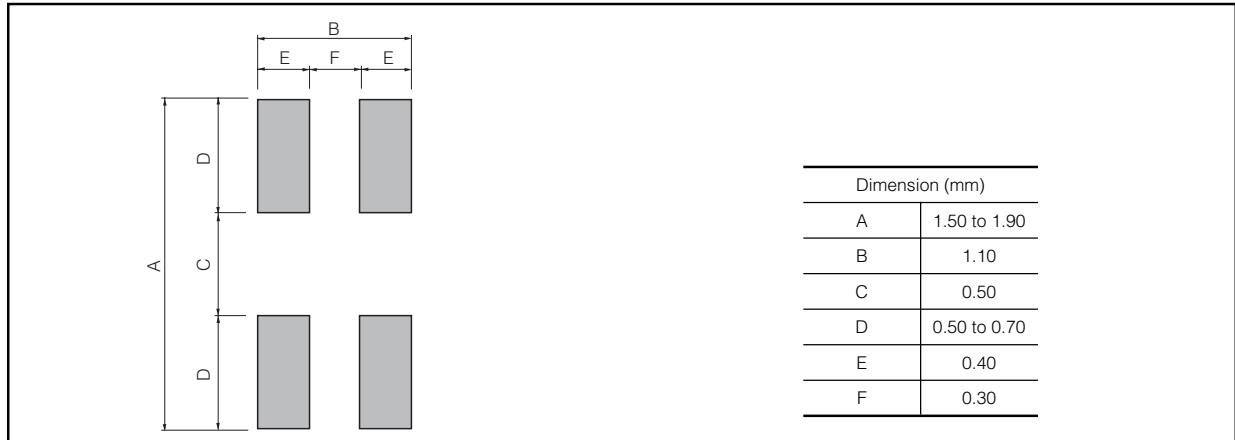

### Recommended Soldering Conditions

Recommendations and precautions are described below.

#### Recommended soldering conditions for reflow

- Reflow soldering shall be performed a maximum of two times.
- Please contact us for additional information when used in conditions other than those specified.
- Please measure the temperature of the terminals and study every kind of solder and printed circuit board for solderability before actual use.

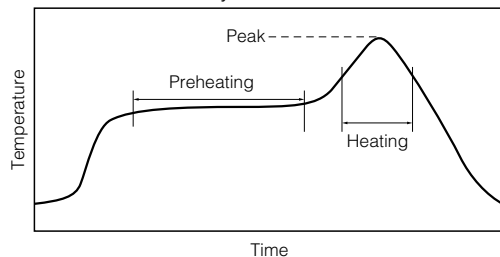

For soldering (Example : Sn-37Pb)

	Temperature	Time
Preheating	140 °C to 160 °C	60 s to 120 s
Main heating	Above 200 °C	30 s to 40 s
Peak	235 ± 10 °C	max. 10 s

For lead-free soldering (Example : Sn/3Ag/0.5Cu)

	Temperature	Time
Preheating	150 °C to 170 °C	60 s to 120 s
Main heating	Above 230 °C	30 s to 40 s
Peak	max. 260 °C	max. 10 s

#### Flow soldering

- We do not recommend flow soldering, because flow soldering may cause bridges between the electrodes.

<Repair with hand soldering>

- Preheat with a blast of hot air or similar method. Use a soldering iron with a tip temperature of 350 °C or less. Solder each electrode for 3 seconds or less.
- Never touch this product with the tip of a soldering iron.

### ⚠ Safety Precautions

The following are precautions for individual products. Please also refer to the common precautions shown on page 4 of this catalog.

1. Use rosin-based flux or halogen-free flux.
2. For cleaning, use an alcohol-based cleaning agent. Before using any other type, consult with our sales person in advance.
3. Do not apply shock to 2 mode Noise Filters (hereafter called the filters) or pinch them with a hard tool (e.g. pliers and tweezers). Otherwise, their bodies may be chipped, affecting their performance. Excessive mechanical stress may damage the filters. Handle with care.
4. Store the filters in a location with a temperature ranging from -5 °C to +40 °C and a relative humidity of 40 % to 60 %, where there are no rapid changes in temperature or humidity.
5. Use the filters within half a year after the date of the outgoing inspection indicated on the packages.