

## Series V

### Type 24V

Dimensions in mm (not to scale)

Recommended PWB piercing plan

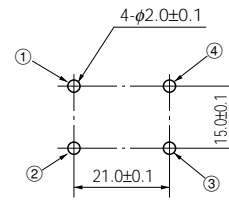
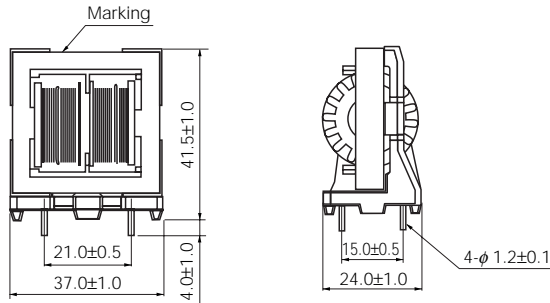

### Standard Parts

Part No.	Marking	Inductance (mH) min.	*R <sub>DC</sub> (Ω) [at 20 °C] (Tol ±20 %)	Current (A rms) max.	Part No.	Marking	Inductance (mH) min.	*R <sub>DC</sub> (Ω) [at 20 °C] (Tol ±20 %)	Current (A rms) max.
ELF24V008A	823 08A	82.00	0.892	0.8	ELF24V034A	562 34A	5.60	0.065	3.4
ELF24V010A	563 10A	56.00	0.608	1.0	ELF24V035A	472 35A	4.70	0.060	3.5
ELF24V012A	473 12A	47.00	0.469	1.2	ELF24V037A	392 37A	3.90	0.052	3.7
ELF24V014A	333 14A	33.00	0.327	1.4	ELF24V042A	332 42A	3.30	0.041	4.2
ELF24V015A	273 15A	27.00	0.274	1.5	ELF24V045A	272 45A	2.70	0.031	4.5
ELF24V018A	223 18A	22.00	0.237	1.8	ELF24V050A	152 50A	1.50	0.028	5.0
ELF24V019A	183 19A	18.00	0.228	1.9	ELF24V070A	801 70A	0.80	0.016	7.0
ELF24V020A	153 20A	15.00	0.161	2.0	ELF24V080A	401 80A	0.40	0.015 max.	8.0
ELF24V025A	103 25A	10.00	0.124	2.5	ELF24V090A	261 90A	0.26	0.012 max.	9.0
ELF24V028A	902 28A	9.00	0.100	2.8	ELF24V100A	151 100A	0.15	0.0085 max.	10.0
ELF24V030A	822 30A	8.20	0.090	3.0					

\* DC Resistance

## Series H

### Type 200

Dimensions in mm (not to scale)

Recommended PWB piercing plan

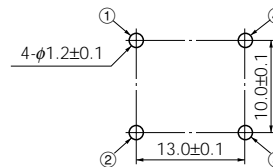
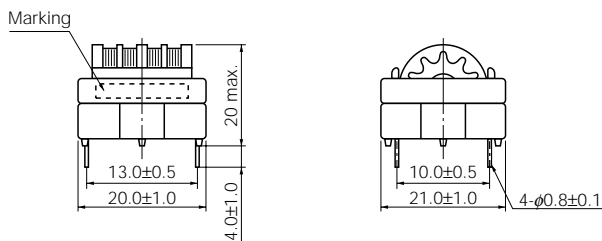

### Standard Parts

Part No.	Marking	Inductance (mH) min.	*R <sub>DC</sub> (Ω) [at 20 °C] (Tol ±20 %)	Current (A rms) max.	Part No.	Marking	Inductance (mH) min.	*R <sub>DC</sub> (Ω) [at 20 °C] (Tol ±20 %)	Current (A rms) max.
ELF18D218	ELF218	22.0	1.564	0.40	ELF18D222F	ELF222F	68.0	4.024	0.25
ELF18D210	ELF210	18.0	1.271	0.50	ELF18D235F	ELF235F	47.0	2.768	0.30
ELF18D214	ELF214	8.2	0.574	0.70	ELF18D221F	ELF221F	33.0	1.790	0.40
ELF18D225	ELF225	6.8	0.519	0.80	ELF18D227F	ELF227F	4.7	0.294	1.00
ELF18D216	ELF216	3.9	0.294	1.00	ELF18D228F	ELF228F	2.2	0.153	1.50
ELF18D219	ELF219	2.7	0.197	1.30	ELF18D230F	ELF230F	1.2	0.082	2.00
ELF18D217	ELF217	1.5	0.119	1.60	ELF18D212F	ELF212F	1.0	0.067	2.10

\* DC Resistance

Design and specifications are each subject to change without notice. Ask factory for the current technical specifications before purchase and/or use. Should a safety concern arise regarding this product, please be sure to contact us immediately.

## Series H

### ● Type 270

Dimensions in mm (not to scale)

Recommended PWB piercing plan

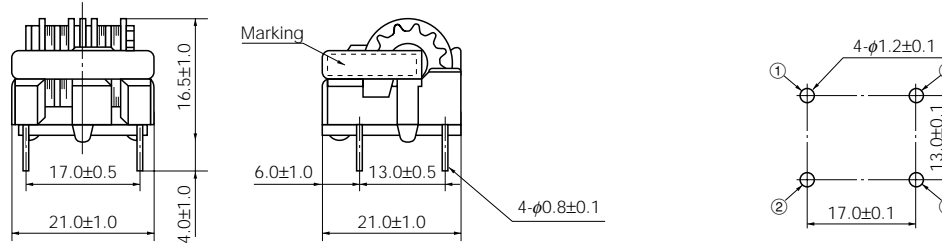

### ● Standard Parts

Part No.	Marking	Inductance (mH) min.	*R <sub>DC</sub> (Ω) [at 20 °C] (Tol ±20 %)	Current (A rms) max.	Part No.	Marking	Inductance (mH) min.	*R <sub>DC</sub> (Ω) [at 20 °C] (Tol ±20 %)	Current (A rms) max.
ELF18D270J	270J	33.0	2.691	0.3	ELF18D270A	270A	6.8	0.571	0.7
ELF18D270B	270B	22.0	1.707	0.4	ELF18D270Q	270Q	5.6	0.504	0.8
ELF18D270H	270H	18.0	1.271	0.5	ELF18D270D	270D	2.7	0.248	1.1
ELF18D270G	270G	10.0	0.782	0.6	ELF18D270C	270C	1.8	0.162	1.5

\* DC Resistance

### ● Type 400

Dimensions in mm (not to scale)

Recommended PWB piercing plan

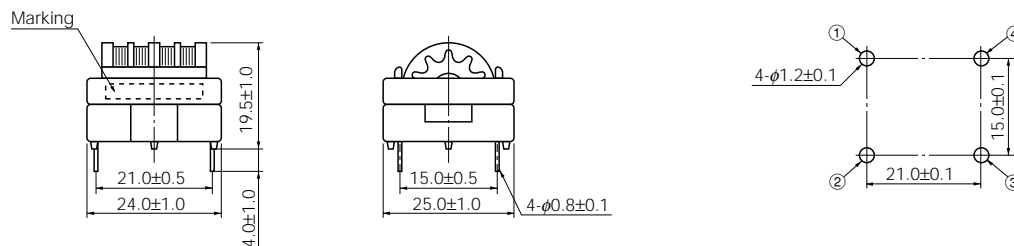

### ● Standard Parts

Part No.	Marking	Inductance (mH) min.	*R <sub>DC</sub> (Ω) [at 20 °C] (Tol ±20 %)	Current (A rms) max.	Part No.	Marking	Inductance (mH) min.	*R <sub>DC</sub> (Ω) [at 20 °C] (Tol ±20 %)	Current (A rms) max.
ELF18D428	ELF428	33.00	1.184	0.5	ELF18D427F	ELF427F	39.00	1.332	0.5
ELF18D423	ELF423	27.00	1.136	0.6	ELF18D417F	ELF417F	18.00	0.655	0.8
ELF18D430	ELF430	12.00	0.595	0.9	ELF18D431F	ELF431F	10.00	0.384	1.0
ELF18D415	ELF415	8.20	0.374	1.0	ELF18D424F	ELF424F	5.60	0.191	1.4
ELF18D412	ELF412	6.80	0.290	1.2	ELF18D434F	ELF434F	2.70	0.111	2.0
ELF18D433	ELF433	3.90	0.176	1.5	ELF18D435F	ELF435F	2.20	0.084	2.2
ELF18D414	ELF414	3.30	0.138	1.8	ELF18D420F	ELF420F	1.20	0.043	3.0
ELF18D419	ELF419	1.50	0.076	2.4	ELF18D441F	ELF441F	0.56	0.030	3.4
ELF18D437F	ELF437F	68.00	2.319	0.4					

\* DC Resistance

Design and specifications are each subject to change without notice. Ask factory for the current technical specifications before purchase and/or use. Should a safety concern arise regarding this product, please be sure to contact us immediately.

## Series H

### ● Type 19H

Dimensions in mm (not to scale)

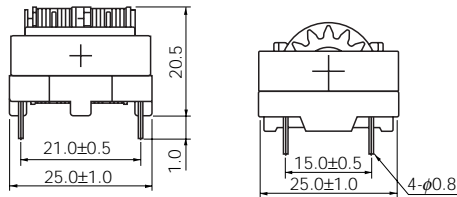

Recommended PWB piercing plan

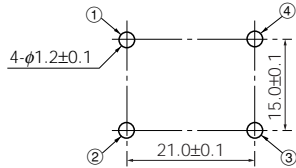

### ● Impedance Characteristics

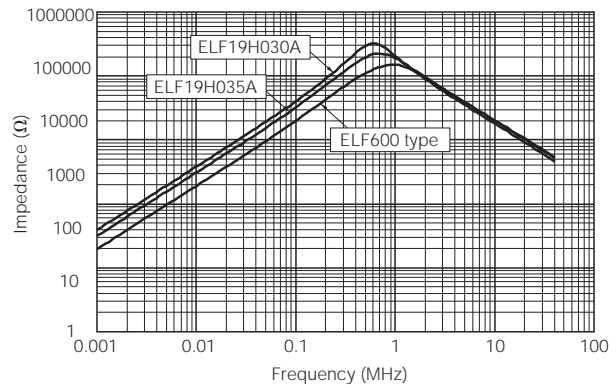

### ● Standard Parts (19H□□□A)

Part No.	Marking	Inductance (mH) min.	*R <sub>DC</sub> (Ω) [at 20 °C] (Tol ±20 %)	Current (A rms) max.	Part No.	Marking	Inductance (mH) min.	*R <sub>DC</sub> (Ω) [at 20 °C] (Tol ±20 %)	Current (A rms) max.
ELF19H010A	353 10A	35.0	0.620	1.0	ELF19H030A	382 30A	3.8	0.068	3.0
ELF19H020A	823 20A	8.0	0.135	2.0	ELF19H035A	302 35A	3.0	0.050	3.5

## Series H

### ● Type 600

Dimensions in mm (not to scale)

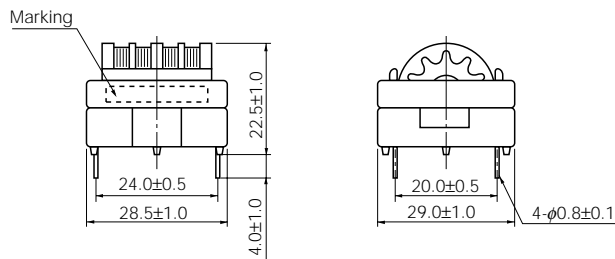

Recommended PWB piercing plan

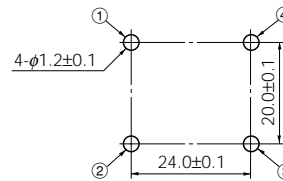

### ● Standard Parts

Part No.	Marking	Inductance (mH) min.	*R <sub>DC</sub> (Ω) [at 20 °C] (Tol ±20 %)	Current (A rms) max.	Part No.	Marking	Inductance (mH) min.	*R <sub>DC</sub> (Ω) [at 20 °C] (Tol ±20 %)	Current (A rms) max.
ELF18D607	ELF607	68.0	1.739	0.5	ELF18D614	ELF614	1.8	0.062	2.8
ELF18D615	ELF615	39.0	1.075	0.7	ELF18D610	ELF610	1.5	0.058	3.1
ELF18D618	ELF618	27.0	0.708	0.8	ELF18D608	ELF608	1.0	0.045	3.4
ELF18D612	ELF612	22.0	0.540	1.0	ELF18D624F	ELF624F	33.0	0.707	0.8
ELF18D602	ELF602	8.2	0.226	1.7	ELF18D606F	ELF606F	18.0	0.331	1.2
ELF18D603	ELF603	5.6	0.155	1.8	ELF18D609F	ELF609F	12.0	0.226	1.6
ELF18D604	ELF604	4.7	0.125	2.0	ELF18D601F	ELF601F	10.0	0.214	1.6
ELF18D613	ELF613	3.9	0.104	2.2	ELF18D603F	ELF603F	5.6	0.111	2.2
ELF18D605	ELF605	3.3	0.087	2.5	ELF18D604F	ELF604F	4.7	0.087	2.5
ELF18D611	ELF611	2.7	0.082	2.6	ELF18D617F	ELF617F	2.2	0.058	2.8

\* DC Resistance

Design and specifications are each subject to change without notice. Ask factory for the current technical specifications before purchase and/or use. Should a safety concern arise regarding this product, please be sure to contact us immediately.