



Applications

Differential and Common Mode filtering for DC-DC converters with 48 V and 24 V input:

- Telecommunications
- Data communications
- Distributed Power Solutions

Features

- Maximum current 4 A
- Maximum operating input voltage 80V
- 100V/50V 100ms transient withstand capability
- Differential LC-filter stage
- Surface mounted design
- Small footprint – only 0.75 sq. in.
- Low profile: 0.339" [8.61 mm] maximum
- Low weight: 0.18 oz [5 g]
- -40°C to 85°C ambient temperature range
- No airflow required up to 3 A current @ 85°C
- Enables **Q**[™] Family converter compliance with EN55022 and FCC Class B requirements conducted emissions
- UL 60950 recognition in U.S. & Canada, and DEMKO certification per IEC/EN 60950
- RoHS compliant (Q4 2005)

Description

The **F4804** Input Filter minimizes the conducted and radiated emissions generated by switch mode DC-DC converters, and allows board designs utilizing **Q**[™] Family converters to easily meet stringent Class B conducted emissions requirements.

Using the **F4804** filter as the primary power-conditioning device in front of any of the **Q**[™] Family converters will provide a "worry-free" EMI design. Unlike most available off-the-shelf filter modules, the **F4804** contains, in addition to common mode noise reduction components, a differential LC-filter stage, which guarantees compliance with conducted noise standards in the whole frequency range from 150 kHz to 30 MHz, including fundamental switching frequency and its harmonics. Test results show headroom of 15-20 dB for conducted noise quasi-peak levels, in relation to Class B requirements; see Figs. 2-8.

F4804 filter is designed specifically for distributed power solutions in conjunction with **Q**[™] Family DC-DC converters. Low profile and small size (only 0.75 sq. in.) in a surface mount package helps the system designer save real estate on the system board, and simplifies the layout.

A single **F4804** filter can be used with multiple converters, and is capable of providing up to a nominal 4 A to the converter input bus. It can provide up to 3 A at 85°C ambient with no airflow.

Electrical Specifications

Conditions: $T_A=25^\circ\text{C}$, No Airflow, $V_{in}=48\text{ Vdc}$, unless otherwise specified.

Parameter	Notes	Min	Typ	Max	Units
Absolute Maximum Ratings					
Input Voltage ¹	Continuous	0		100	Vdc
Operating Ambient Temperature		-40		85	°C
Storage Temperature		-55		125	°C
Electrical Characteristics					
Operating Input Voltage Range ^{1, 2}		0	48	80	Vdc
Maximum Operating Current	85°C ambient, no airflow ³			3	Adc
	85°C ambient, airflow 300 LFM [1.5 m/s]			4	Adc
Voltage Drop at Maximum Load	4 A			0.32	Vdc
Voltage Drop – Typical Application	Loaded with Q48x30033 (3.3 V, 30 A) ⁴		0.16		Vdc
Efficiency at Typical Load	Loaded with Q48x30033 (3.3 V, 30 A)	99.6	99.7		%
Conducted Noises, Quasi-Peak Level ⁵	Loaded with Q48x30033 (3.3 V, 30 A)				
- Main frequency and low harmonics up to 5 MHz			40	45	dB μ V
- High frequencies up to 30 MHz			35	48	dB μ V

Additional Notes:

1. Absolute maximum voltage and maximum operating voltage are for the filter itself; check maximum rating for corresponding DC-DC converters. Filter will not be damaged with reversed input voltage.
2. Designed primarily for 48 V applications, filter can be used with both 48 V converters (operating range from 36 V to 72 V) and 24 V converters (operating range from 18 V to 36 V). Typical filter application schematic is shown on Fig. 1.
3. Maximum current at any ambient temperature without airflow can be calculated as $I_{max} = [4 - 0.025 \cdot (T_{amb} - 45)]\text{ A}$, with constraint $I_{max} \leq 4\text{ A}$.
4. Letter x denotes either T or S, i.e. filter module is loaded either with Q48T30033 through-hole or Q48S30033 surface mounted converter.
5. Typical EMI plot for conducted emissions (with fully loaded Q48x30033 converter connected to the filter output, see schematic Fig. 1) is shown on Fig. 2. Plot was taken by independent test laboratory TUV. TUV report confirms compliance with Class B requirements according EN-55022 (CISPR-22) and FCC standards.

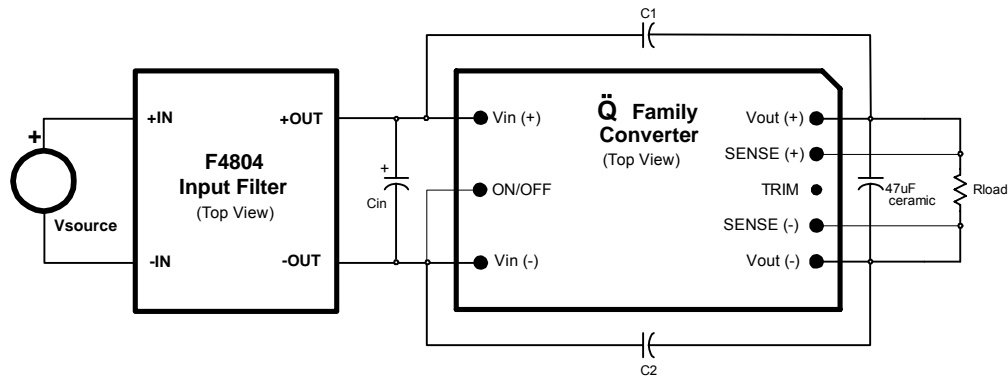

Fig. 1: Typical F4804 application schematic with **Q Family** converter (negative ON/OFF logic). Values C1, C2 and Cin depend on the specific converter input and output voltage.

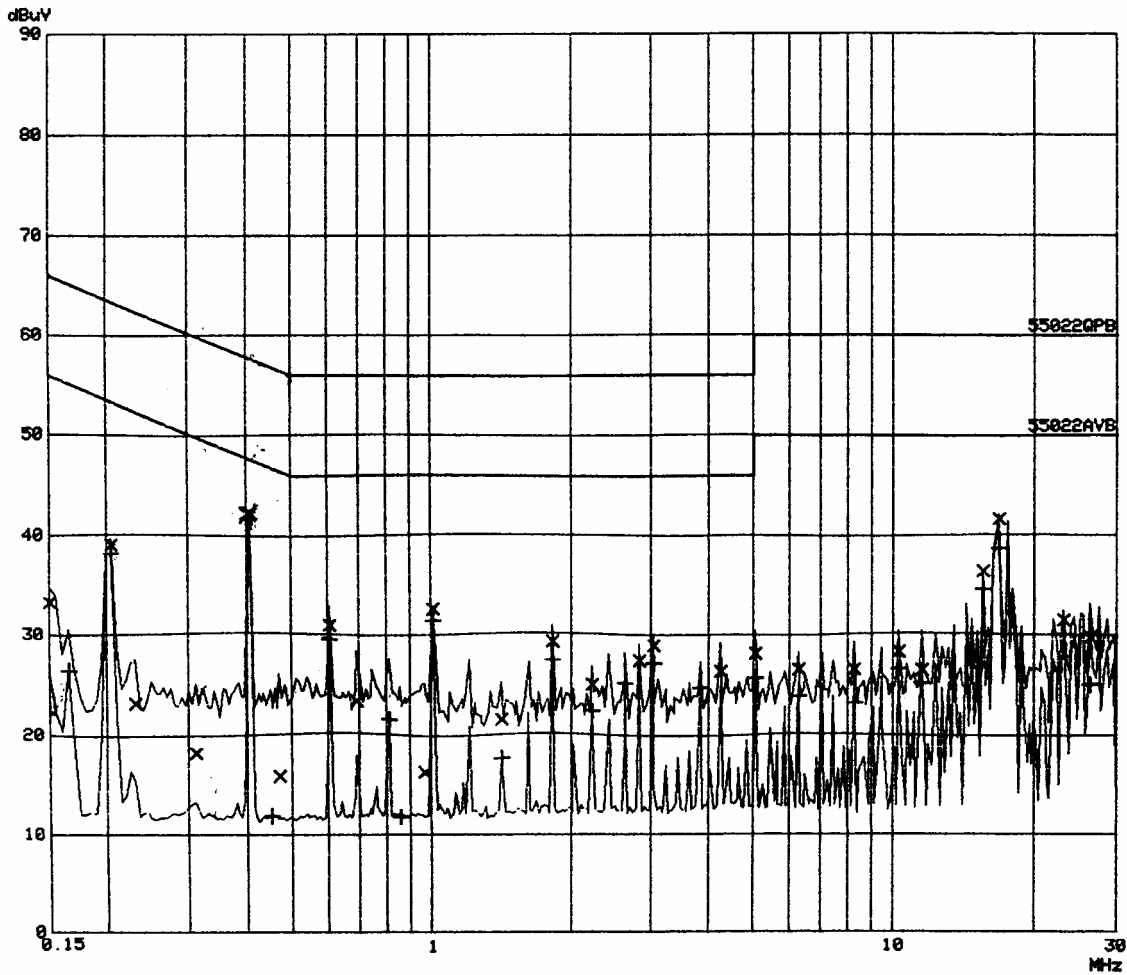

Fig. 2: Conducted emissions plot (quasi-peak values: "x", average values: "+") for Q48x30033 in conjunction with F4804 filter. Limits shown are for quasi-peak (upper limit) and average (lower limit) values. C1 = 2200 pF, C2 = 3300 pF, Cin = 47 µF.

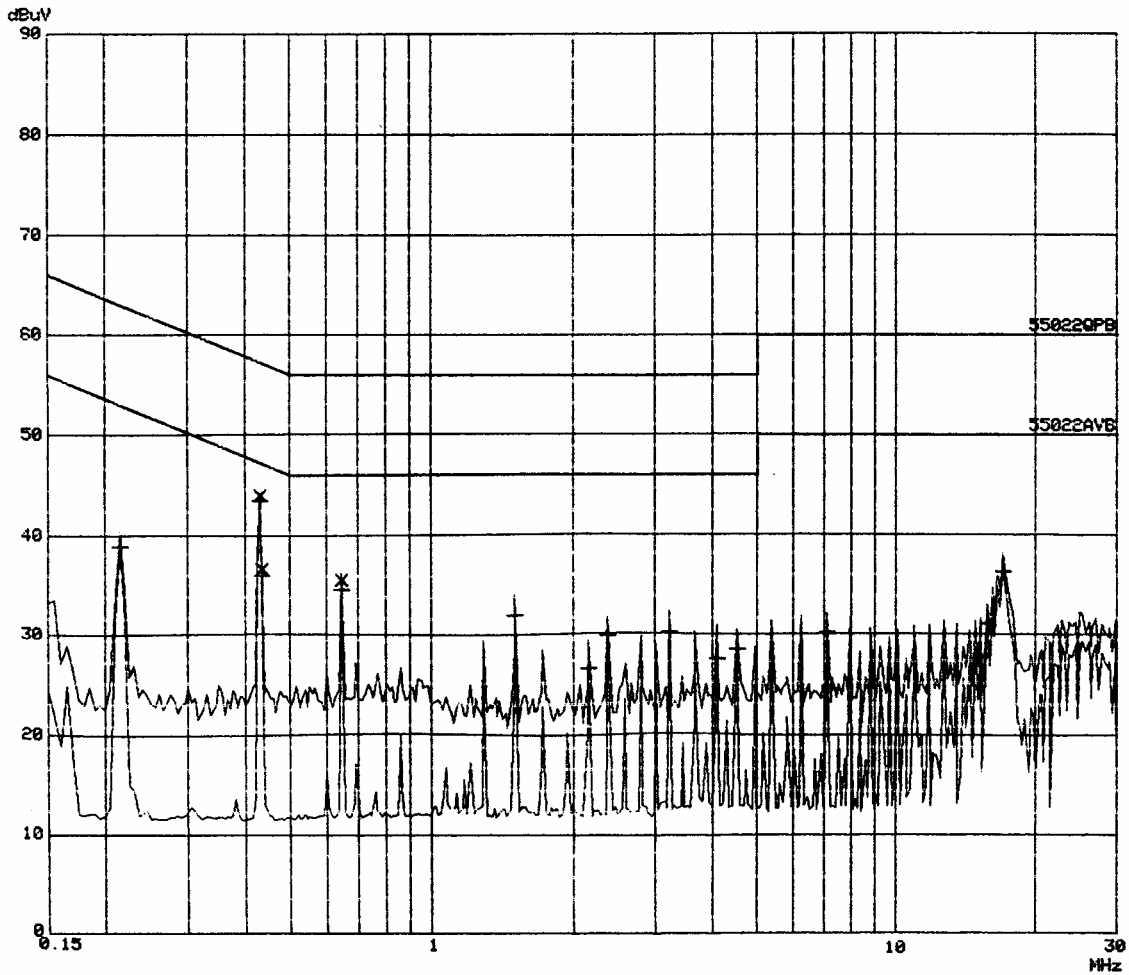

Fig. 3: Conducted emissions plot (quasi-peak values: "x", average values: "+") for Q48x30025 in conjunction with F4804 filter. Limits shown are for quasi-peak (upper limit) and average (lower limit) values. C1 = 2200 pF, C2 = 3300 pF, Cin = 47 µF.

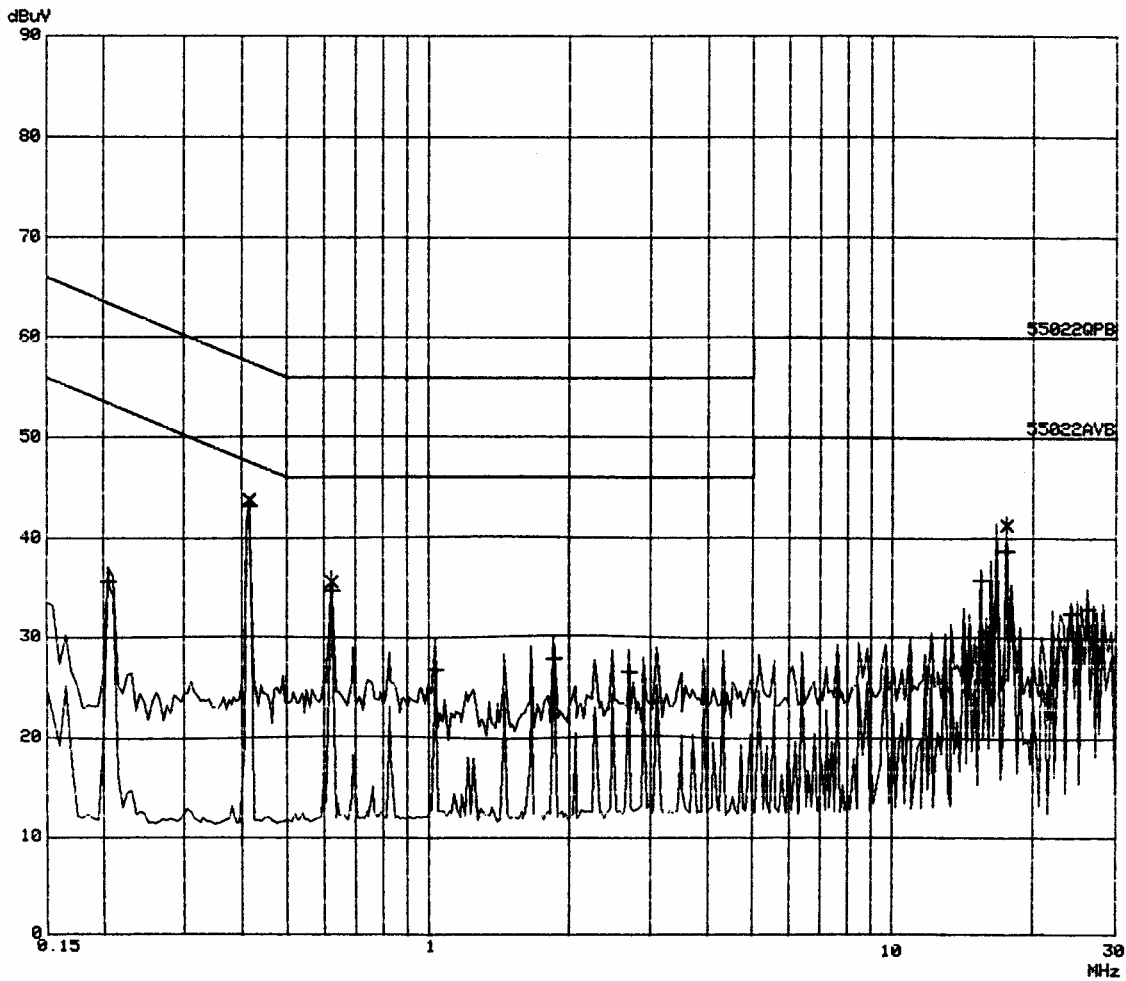

Fig. 4: Conducted emissions plot (quasi-peak values: "x", average values: "+") for Q48x30020 in conjunction with F4804 filter. Limits shown are for quasi-peak (upper limit) and average (lower limit) values. C1 = 2200 pF, C2 = 3300 pF, Cin = 47 μ F.

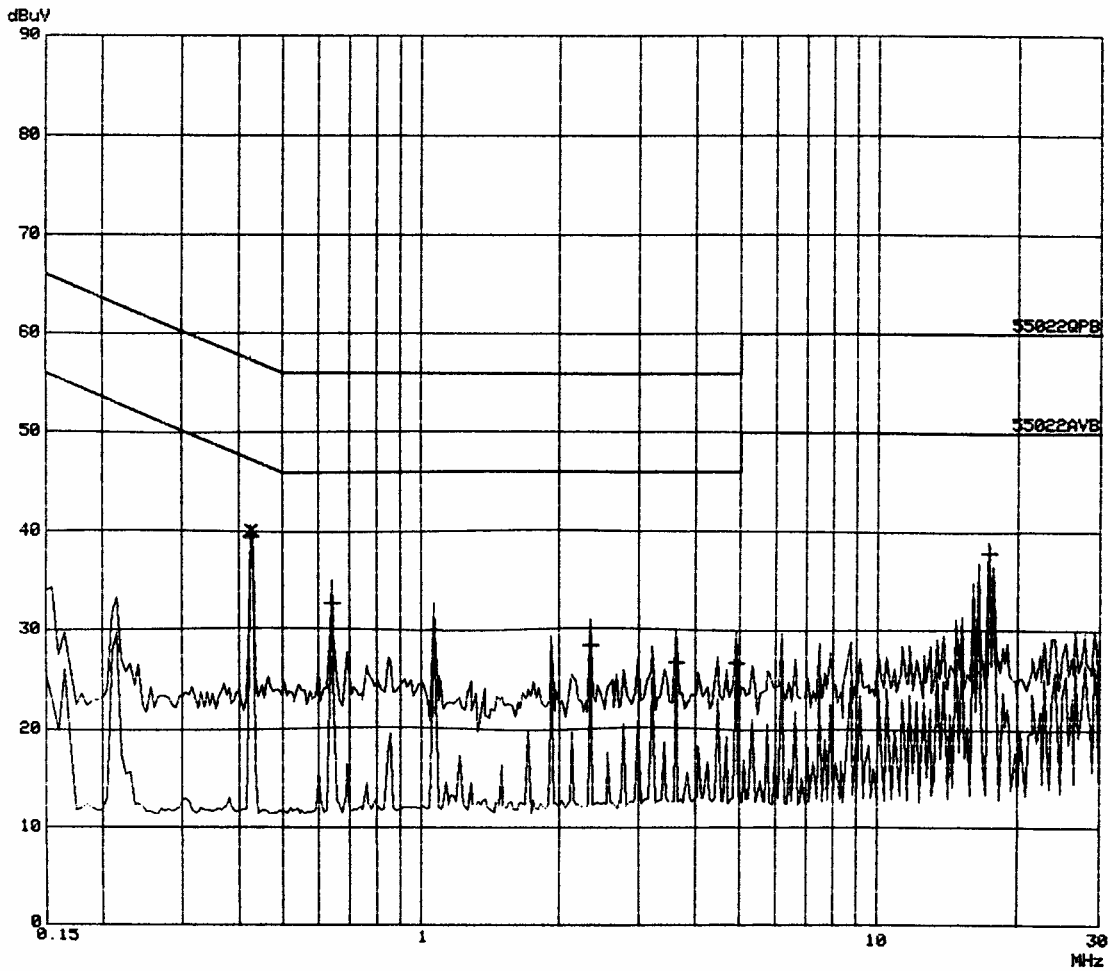

Fig. 5: Conducted emissions plot (quasi-peak values: "x", average values: "+") for Q48x30018 in conjunction with F4804 filter. Limits shown are for quasi-peak (upper limit) and average (lower limit) values. C1 = 2200 pF, C2 = 3300 pF, Cin = 47 μ F.

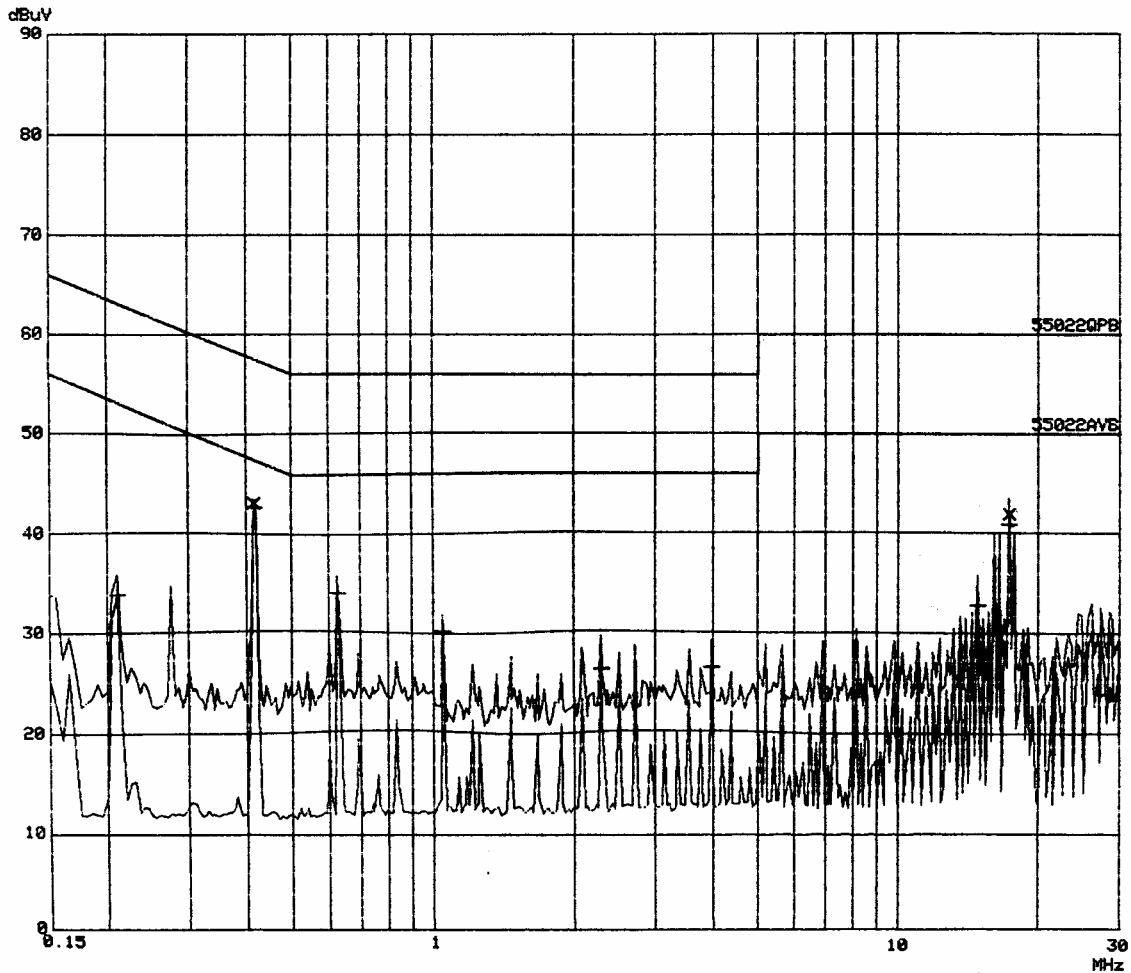

Fig. 6: Conducted emissions plot (quasi-peak values: "x", average values: "+") for Q48x30015 in conjunction with F4804 filter. Limits shown are for quasi-peak (upper limit) and average (lower limit) values. C1 = 2200 pF, C2 = 3300 pF, Cin = 47 μ F.

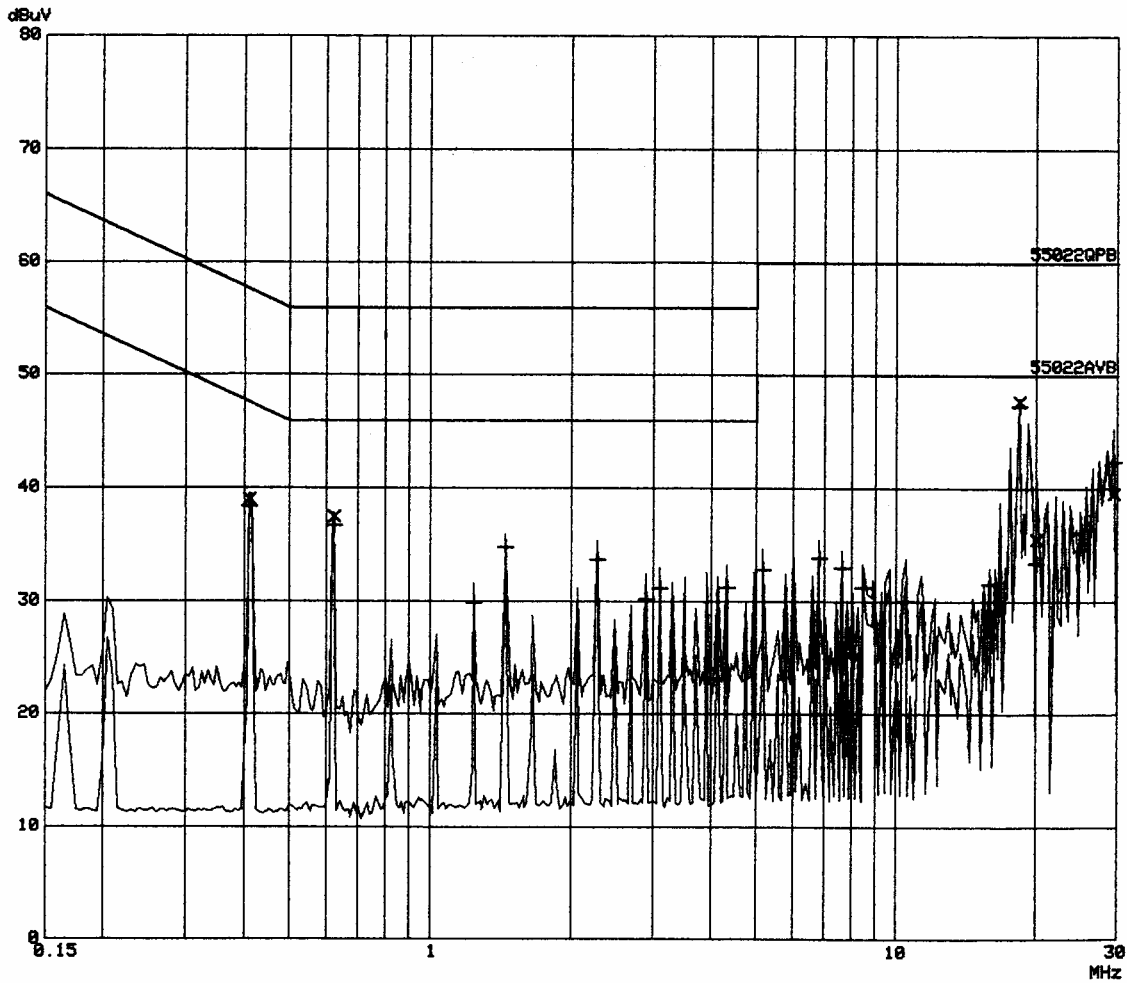

Fig. 7: Conducted emissions plot (quasi-peak values: "x", average values: "+") for Q48x15050 in conjunction with F4804 filter. Limits shown are for quasi-peak (upper limit) and average (lower limit) values. C1 = 0 pF (not mounted), C2 = 1500 pF, Cin = 200 μ F.

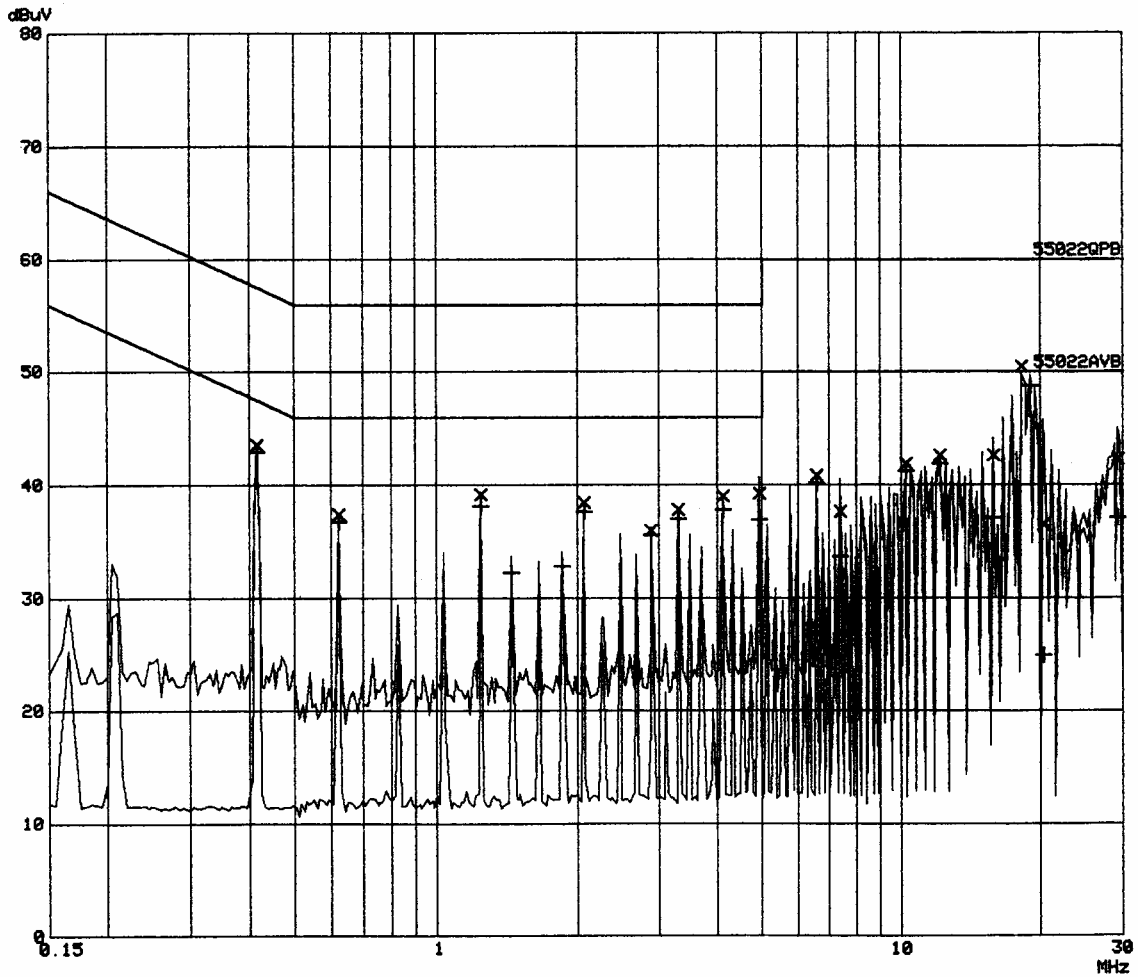
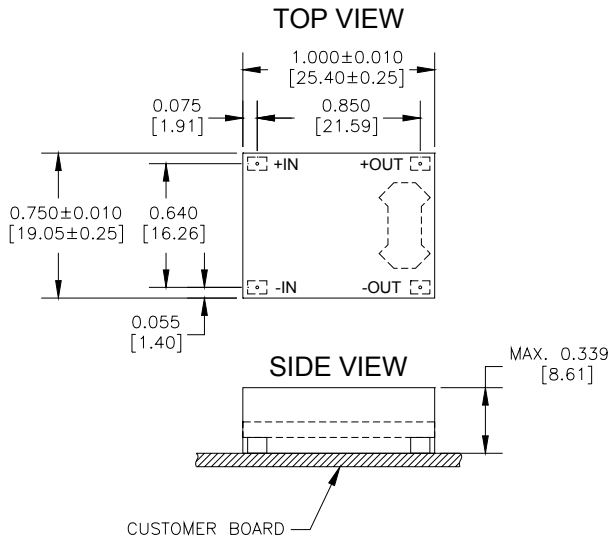

Fig. 8: Conducted emissions plot (quasi-peak values: "x", average values: "+") for Q48x08120 in conjunction with F4804 filter. Limits shown are for quasi-peak (upper limit) and average (lower limit) values. C1 = 0 pF (not mounted), C2 = 1500 pF, Cin = 200 μ F.

Physical Information (Actual size shown)



Pad/Pin Connections	
Pad/Pin #	Function
+IN	Vin (+)
-IN	Vin (-)
-OUT	Vout (-)
+OUT	Vout (+)

- All dimensions are in inches [mm]
- Connector Material: Copper
- Connector Finish: Gold over Nickel
- Converter Weight: 0.18 oz [5 g]
- Recommended Surface-Mount Pads:
Min. 0.080" x 0.112" [2.03 x 2.84]
Max. 0.092" x 0.124" [2.34 x 3.15]

Filter Part Numbering Ordering Information

Product Series	Input Voltage	Rated Load Current		Tape and Reel	Environmental
F	48	04	-	R	G
Filter Module	≤ 80 V	4A		No letter ⇒ Bulk R ⇒ Tape and Reel	G ⇒ Green/RoHS Compliant Not populated ⇒ Non-RoHS Compliant

The example above describes P/N F4804-RG: 0-80 V input, 4 A @ 80 V output, tape and reel, and RoHS compliant. Please consult factory regarding availability of a specific (including RoHS compliant) version.

NUCLEAR AND MEDICAL APPLICATIONS - Power-One products are not designed, intended for use in, or authorized for use as critical components in life support systems, equipment used in hazardous environments, or nuclear control systems without the express written consent of the respective divisional president of Power-One, Inc.

TECHNICAL REVISIONS - The appearance of products, including safety agency certifications pictured on labels, may change depending on the date manufactured. Specifications are subject to change without notice.