

3-terminal Filters(LEAD) For Signal Line and Power Line

Conformity to RoHS Directive

ZJSR Series

FEATURES

- The ZJSR series combine TDK's high performance ferrite bead and a chip capacitor. This board mounted EMC filter is used to prevent microcomputer operational errors and stop noise generation. Most suitable for use in countering radio noise generated by digital circuits.
- SIP shape with 2.4mm max. thickness, making possible high density mounting upon a PCB in a row at DIP pitch.
- When using taped product, possible to mount using automatic equipment.
- Excellent high frequency bypass performance due to short earth-side capacitor lead.

PRODUCT IDENTIFICATION

ZJSR5101 - 101 TA - 01
(1) (2) (3) (4)

- (1) Series name
- (2) Capacitance 101:100pF
- (3) Packaging style TA: Taping
(not needed for specification of bulk products)
- (4) Lead-free(The "-01" designation at the end of the product code indicates Lead-free compatible product.)

SHAPES AND DIMENSIONS

TAPING SPECIFICATIONS

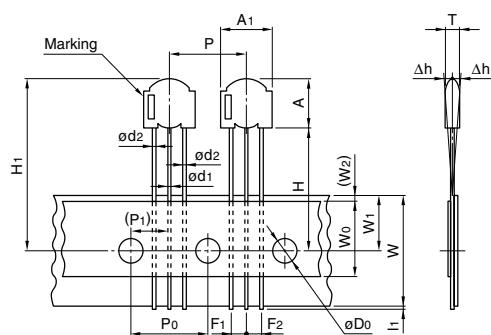

BULK SPECIFICATIONS

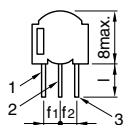

CIRCUIT DIAGRAM

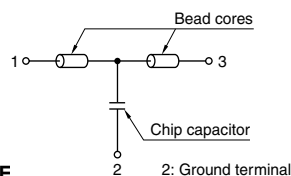

TYPICAL MOUNTING EXAMPLE

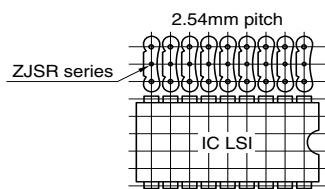

APPLICATIONS

Home electronic equipment, (TVs, VCRs, CD players, DAT players, electric musical instruments, PCs, etc.), office automation equipment (computers, terminals, stand-alone word processors, fax machines, etc.), factory automation equipment (robots, numerical control devices, process controllers, etc.), automotive electronics (automotive engine control units, etc.)

BASIC CHARACTERISTICS

Series	ZJSR
Rated voltage Edc	50V
Rated current	5A
Withstand voltage Edc [Between terminal, No.1, 3 to 2]	125V
Insulation resistance [DC. 50V for 1 min]	10000MΩ min.
DC resistance[Terminal No.1 to 3]	0.05Ω max.
Operating temperature range	-25 to +85°C

- This product should not be used under conditions that exceed those listed above.
- Please note that this product is an EMC filter, so should not be used as a surge absorber, etc.

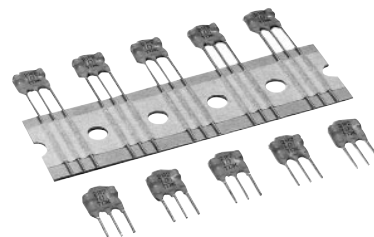

Dimensions in mm

Series	ZJSR
Component width	A1 8.5max.
Component height	A 8max.
Component thickness	T 2.4max.
Lead wire diameter	0.5±0.05
(round)	0.6±0.05
Component pitch	P 12.7±1
Feed hole pitch	P0 12.7±0.3
Feed hole position error	P1 6.35±0.4
Lead pitch	F1, F2 2.5±0.4, -0.1
Component alignment	Δh 0±2
Tape width	W 18+1, -0.5
Cover tape width	W0 12±0.3
Feed hole position error	W1 9±0.5
Cover tape position	(W2) (4max.)
Component bottom position	H 20±1
Maximum component height	H1 28max.
Feed hole diameter	∅D0 4±0.2
Lead wire protrusion	l1 0.5max.
Lead wire length	l 5±1.5
Lead pitch	f1, f2 2.5±0.5

- The tolerance of lead pitch is the dimensions when a lead is released from tape. Not available for bulk packaging.

• Conformity to RoHS Directive: This means that, in conformity with EU Directive 2002/95/EC, lead, cadmium, mercury, hexavalent chromium, and specific bromine-based flame retardants, PBB and PBDE, have not been used, except for exempted applications.

• All specifications are subject to change without notice.

ELECTRICAL CHARACTERISTICS

Part No.	Capacitance (pF)	Tolerance (%)	Maximum attenuation (MHz)	Frequency range (MHz)[normal mode]*		Marking
				15dB min. attenuation	25dB min. attenuation	
ZJSR5101-330-01	33	±20	700	400 to 800	650 to 800	330
ZJSR5101-470-01	47	±20	600	350 to 800	550 to 700	470
ZJSR5101-680-01	68	±20	500	250 to 800	450 to 600	680
ZJSR5101-101-01	100	±20	400	200 to 800	350 to 500	101
ZJSR5101-221-01	220	±20	280	100 to 800	200 to 350	221
ZJSR5101-331-01	330	±20	220	70 to 800	150 to 300	331
ZJSR5101-102-01	1000	±20	140	30 to 800	70 to 200	102
ZJSR5101-222-01	2200	±20	80	20 to 800	45 to 200	222
ZJSR5101-332-01	3300	±20	70	15 to 800	35 to 200	332
ZJSR5101-472-01	4700	±20	60	10 to 800	25 to 200	472
ZJSR5101-682-01	6800	±20	50	8 to 800	20 to 200	682
ZJSR5101-103-01	10000	+80, -20	35	6 to 800	15 to 200	103
ZJSR5101-223-01	22000	+80, -20	27	4 to 800	9 to 200	223
ZJSR5101-333-01	33000	+80, -20	20	3 to 800	7 to 200	333

* Operating temperature range: +5 to +35°C

TYPICAL ELECTRICAL CHARACTERISTICS

ATTENUATION vs. FREQUENCY CHARACTERISTICS

Glass epoxy coated double side mounting PCB(t=1.6mm)

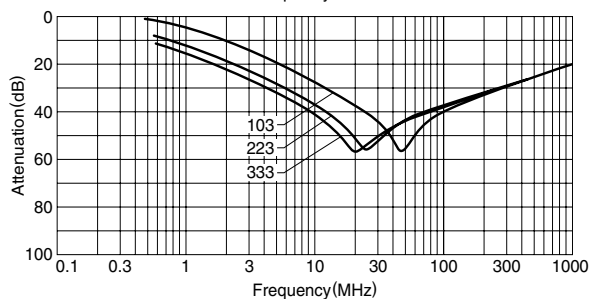
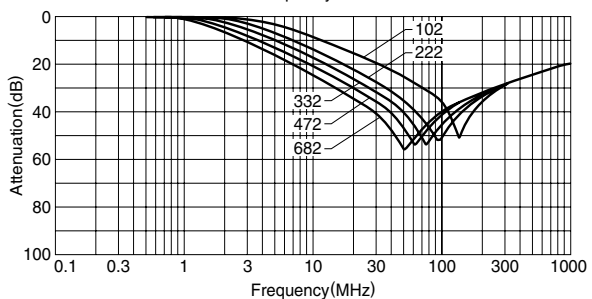
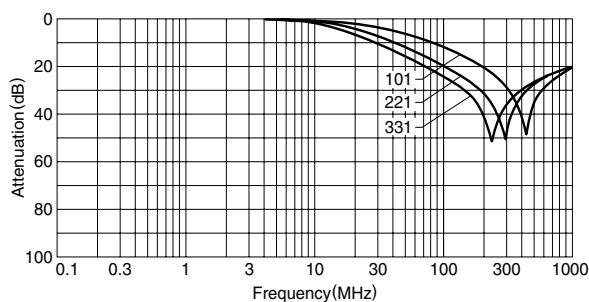
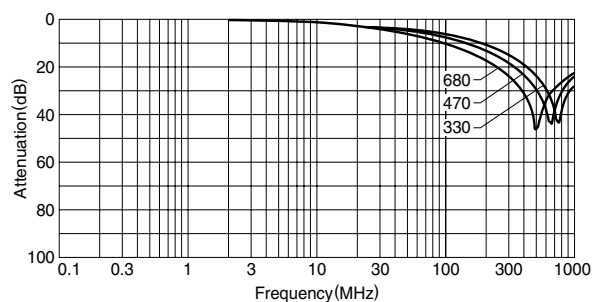

CIRCUIT DIAGRAM

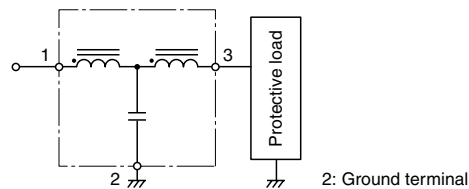

PACKAGING STYLE AND QUANTITIES

Packaging style	Quantity
Taping	2000 pieces/reel

PACKAGING STYLE (Ammo-pack)

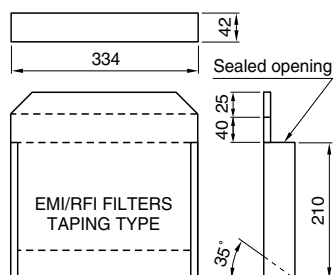

Dimensions in mm

INDICATES INTERIOR CONTENTS OF BOX

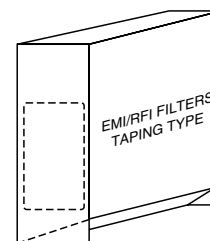

TECHNICAL NOTES INSERTION ATTENUATION MEASUREMENT METHOD

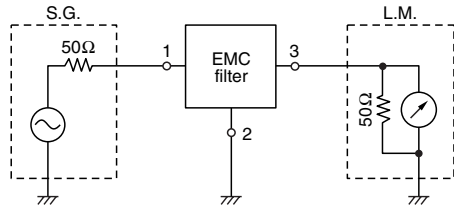

$$\text{Attenuation} = \log_{10} \frac{E_2}{E_1} \text{ (dB)}$$

E2: Set EMC filter in the circuit
E1: Leave EMC filter in the circuit

MOUNTING SUBSTRATE FOR MEASUREMENT

Mount on the glass fabric-backed epoxy resin double-sided through-hole substrate($t=1.6\text{mm}$)

MEASUREMENT TEMPERATURE

+5 to +35°C

TYPICAL APPLICATIONS

An example of radiated noise suppressing circuit by connecting a PC and a printer.

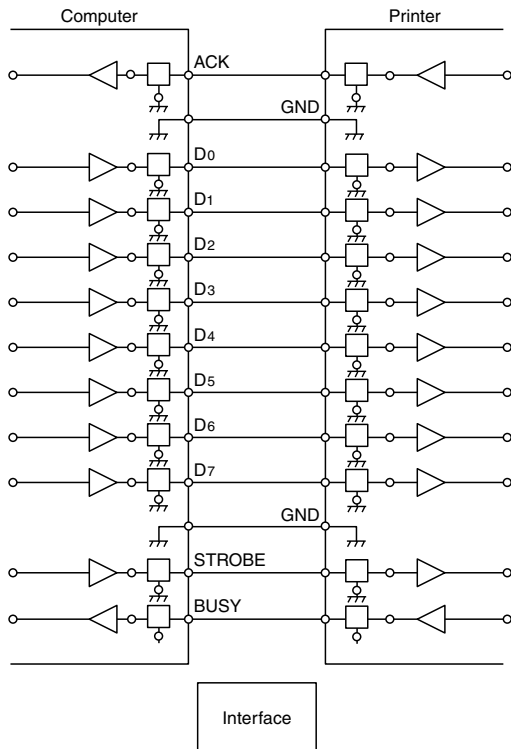

EXAMPLES OF MEASURING NOISE SUPPRESSION EFFECT (Waveform spectrum)

(1)MEASUREMENT CIRCUIT

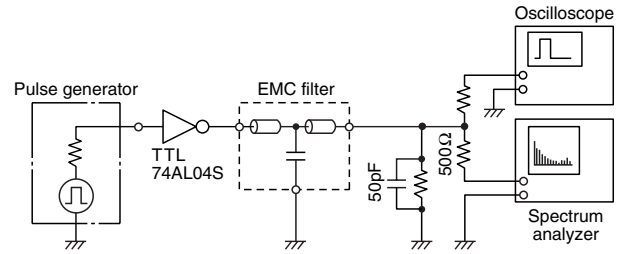

PULSE WAVEFORM

WITHOUT EMC FILTER

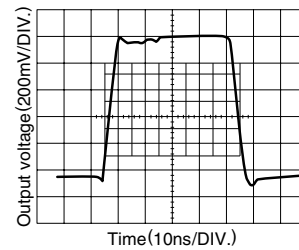

WITH EMC FILTER

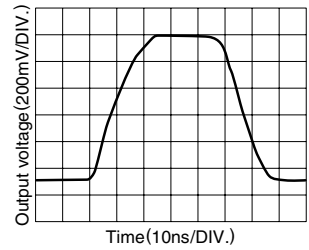

(2)MEASUREMENT RESULTS

(a)SPECTRUM WITHOUT EMC FILTER

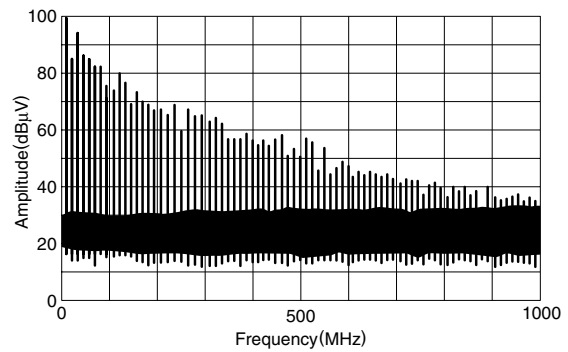

(b)SPECTRUM WITH EMC FILTER

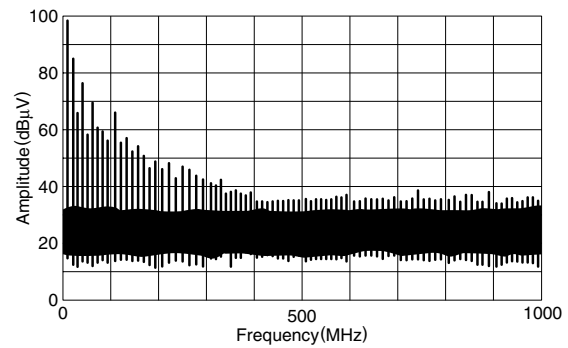

AN EXAMPLE OF MEASURING NOISE SUPPRESSION EFFECT (Radiation spectrum)

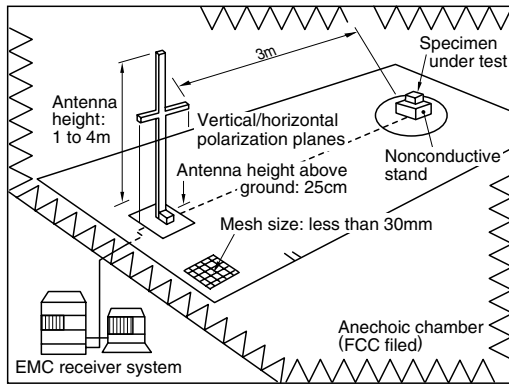

TTL OUTPUT WAVEFORM WITHIN A SHIELDING CASE

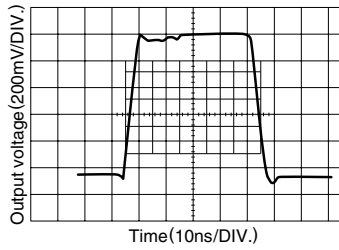

MODEL

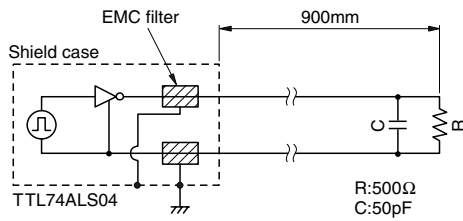

RADIATION LEVEL (a)WITHOUT EMC FILTER

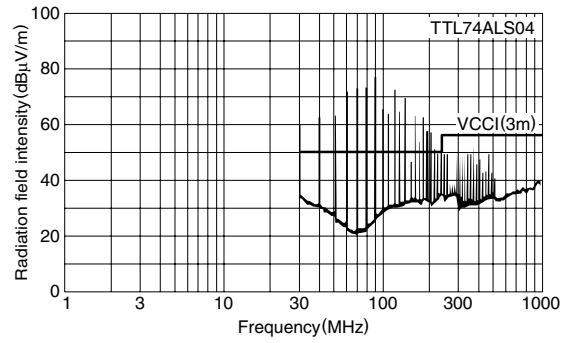

(b)WITH EMC FILTER

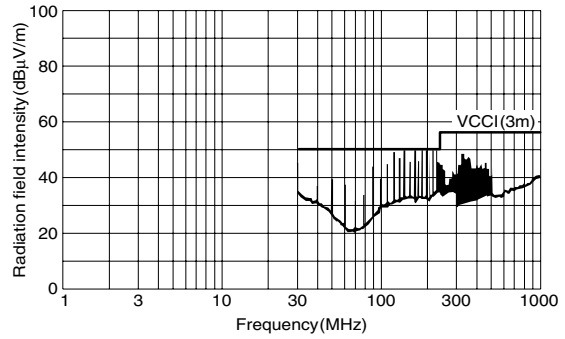

BICONICAL ANTENNA INDUCED WAVEFORM

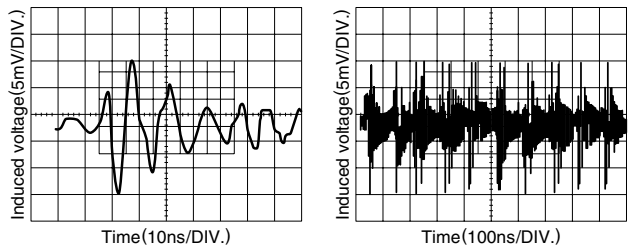

• All specifications are subject to change without notice.