

Table of Contents

Our Position on Quality and the Environment.....	I.F.C.
Introduction	2
Magnetic Properties of Fair-Rite Materials	4
Fair-Rite Materials	7
Board Components	
Solder Profile.....	28
EMI Suppression Beads.....	29
Beads on Leads	34
PC Beads (Through Hole)	36
PC Beads (Surface Mount).....	38
Wound Beads.....	42
Multi-Aperture Cores	44
SM Beads (Differential Mode)	47
SM Beads (Common-Mode)	51
Chip Beads.....	54
Chip Arrays.....	58
Chip Inductors.....	60
Engineering Kits.....	67
Cable Components	
Round Cable EMI Suppression Cores	70
Round Cable Snap-Its.....	75
Split Round Cable EMI Suppressor Cores.....	79
Flat Cable EMI Suppression Cores.....	83
Flat Cable Cores Assembly Clips.....	86
Flat Cable Snap-Its	88
Connector EMI Suppression Plates	89
Miscellaneous Suppression Cores.....	91
Absorber Tiles.....	92
Inductive Components	
Open Magnetic Circuit	
Rods.....	96
Rod Information.....	98
Antenna/RFID Rods	100
Tack Bobbin Cores	103
Bobbins	104
Closed Magnetic Circuit	
Toroids.....	106
Pot Cores.....	114
E Cores	116
I Cores.....	120
U Cores	122
References	
Reference Tables.....	124
Glossary of Terms	125
Soft Ferrite References	126
Magnetic Design Formulas	128
Wire Table of Copper Magnet Wire.....	129
Technical Articles	
The Effect of Direct Current on the Inductance of a Ferrite Core.....	130
Use of Ferrites in Broadband Transformers	135
How to Choose Ferrite Components for EMI Suppression	139
Ferrite Tile Absorbers for EMC Test Chamber Applications	149
Numerical Index	151

Copyright © 2005 by Fair-Rite Products Corp.

All rights reserved. No part of the contents of this book may be published or transmitted in any form or by any means without the expressed written permission of the publisher.

Fair-Rite Products Corp.

PO Box J, One Commercial Row, Wallkill, NY 12589-0288

Phone: (888) FAIR RITE / (845) 895-2055 • FAX: (888) FERRITE / (845) 895-2629 • www.fair-rite.com
(888) 324-7748 (888) 337-7483 • E-Mail: ferrites@fair-rite.com

Introduction

History

The history of magnetism began with the discovery of the properties of a mineral called magnetite (Fe_3O_4). The most plentiful deposits were found in the district of Magnesia in Asia Minor (hence the mineral's name) where it was observed, centuries before the birth of Christ, that these naturally occurring stones would attract iron. Later on it found application in the lodestone of early navigators. In 1600 William Gilbert published *De Magnete*, the first scientific study on magnetism. In 1819 Hans Christian Oersted observed that an electric current in a wire affected a magnetic compass needle, thus with later contributions by Faraday, Maxwell, Hertz and others, the new science of electromagnetism came into being.

Even though the existence of naturally occurring magnetite, a weak type of hard ferrite, had been known since antiquity, producing an analogous soft magnetic material in the laboratory proved elusive. Research on magnetic oxides was going on concurrently during the 1930's, primarily in Japan and the Netherlands. However, it was not until 1945 that J. L. Snoek of the Philips' Research Laboratories in the Netherlands succeeded in producing a soft ferrite material for commercial applications.

Fair-Rite Products Corp. was not far behind in the manufacture and sale of soft ferrites for use in the electronics industry. It was formed in 1952 and officially started operations in 1953. The ensuing years have seen a rather crude product, which was available in only a few shapes and materials, develop into a major line of ferrite components for inductive devices, produced in many core configurations with a wide selection of materials. The application of ferrites in EMI suppression as shield beads and broadband chokes, where an effective resistive impedance is produced at high frequencies, has grown so fast in the last decade, that their use as EMI suppressors is limited only by the imagination of the end user.

Soft Ferrites

The single most important characteristic of soft ferrites, as compared to other magnetic materials, is the high volume resistivity exhibited in the monolithic form. Since eddy current losses are inversely proportional to resistivity and these losses increase with the square of the frequency, high resistivity becomes an essential factor in magnetic materials intended for high frequency operation. The magnetic properties of ferrite components are isotropic, and by employing various pressing, injection molding, and/or grinding techniques, a wide range of complex shapes can be formed. There is no other class of magnetic material that can match soft ferrites in performance, cost and volumetric efficiency, from audio frequencies into the GHz range.

During the last 50 years the basic constituents of ferrites have changed little, but purity of raw materials and process control have improved dramatically. Ferrites are ceramic materials with the general chemical formula $\text{MO}\cdot\text{Fe}_2\text{O}_3$, where MO is one or more divalent metal oxides blended with 48 to 60 mole percent

of iron oxide. Fair-Rite manufactures four broad groups of soft ferrite materials:

Manganese zinc (Fair-Rite 31, 33, 73, 75, 76, 77, 78 and 79 material)

Nickel zinc (Fair-Rite 42, 43, 44, 51, 52, 61, 67 and 68 material)

Manganese (Fair-Rite 85 material)

Magnesium zinc (Fair-Rite 46 material)

Manganese zinc ferrites are completely vitrified and have very low porosity. They have the highest permeabilities and exhibit volume resistivities ranging from one hundred to several thousand ohm-centimeter. Manganese zinc ferrite components are used in tuned circuits and magnetic power designs from the low kilohertz range into the broadcast spectrum. These ferrites have a linear expansion coefficient of approximately 10 ppm/°C.

The nickel zinc ferrites vary in porosity, and frequently contain oxides of other metals, such as those of magnesium, manganese, copper or cobalt. Volume resistivities range from several kilohm-centimeter to tens of megohm-centimeter. In general, they are used at higher frequencies (above 1 MHz), and are suitable for low flux density applications. Nickel zinc ferrites have a linear expansion coefficient of approximately 8 ppm/°C.

The manganese ferrite is a dense, temperature stable material displaying a high degree of squareness in its hysteresis loop. This makes this material uniquely suited for such applications as multiple output control in switched-mode power supplies and high frequency magnetic amplifiers.

The magnesium zinc ferrite has similar characteristics as NiZn ferrite. The composition of MgZn material does not contain any nickel, hence avoiding potential environmental issues as well as reducing the raw material component cost.

As is evident from the flow diagram on page 3, there is considerable processing involved, and the manufacturing cycle will take a minimum of two weeks. The parts listed in the catalog represent a broad cross section of the wide variety of cores produced by Fair-Rite Products. Large OEM quantities are manufactured by Fair-Rite to order. Most of the more commonly used parts are stocked by our distributors, offering prompt deliveries. For a complete listing of our distributors visit our site on the Internet at www.fair-rite.com.

Many of the parts produced by Fair-Rite are made to customer specifications, and we welcome inquiries involving application-specific designs. We have the capability to design tooling rapidly, and have it fabricated either by our own tool shop or by outside vendors.

***Footnote:** *The difference between hard and soft ferrite is not tactile, but rather a magnetic characteristic. Soft ferrite does not retain significant magnetization, whereas hard ferrite magnetization is considered permanent.*

Fair-Rite Products Corp.

Phone: (888) FAIR RITE / (845) 895-2055 • FAX: (888) FERRITE / (845) 895-2629
(888) 324-7748 (888) 337 -7483

PO Box J, One Commercial Row, Wallkill, NY 12589-0288

• www.fair-rite.com
• E-Mail: ferrites@fair-rite.com

Introduction

Simplified Process Flow Diagram

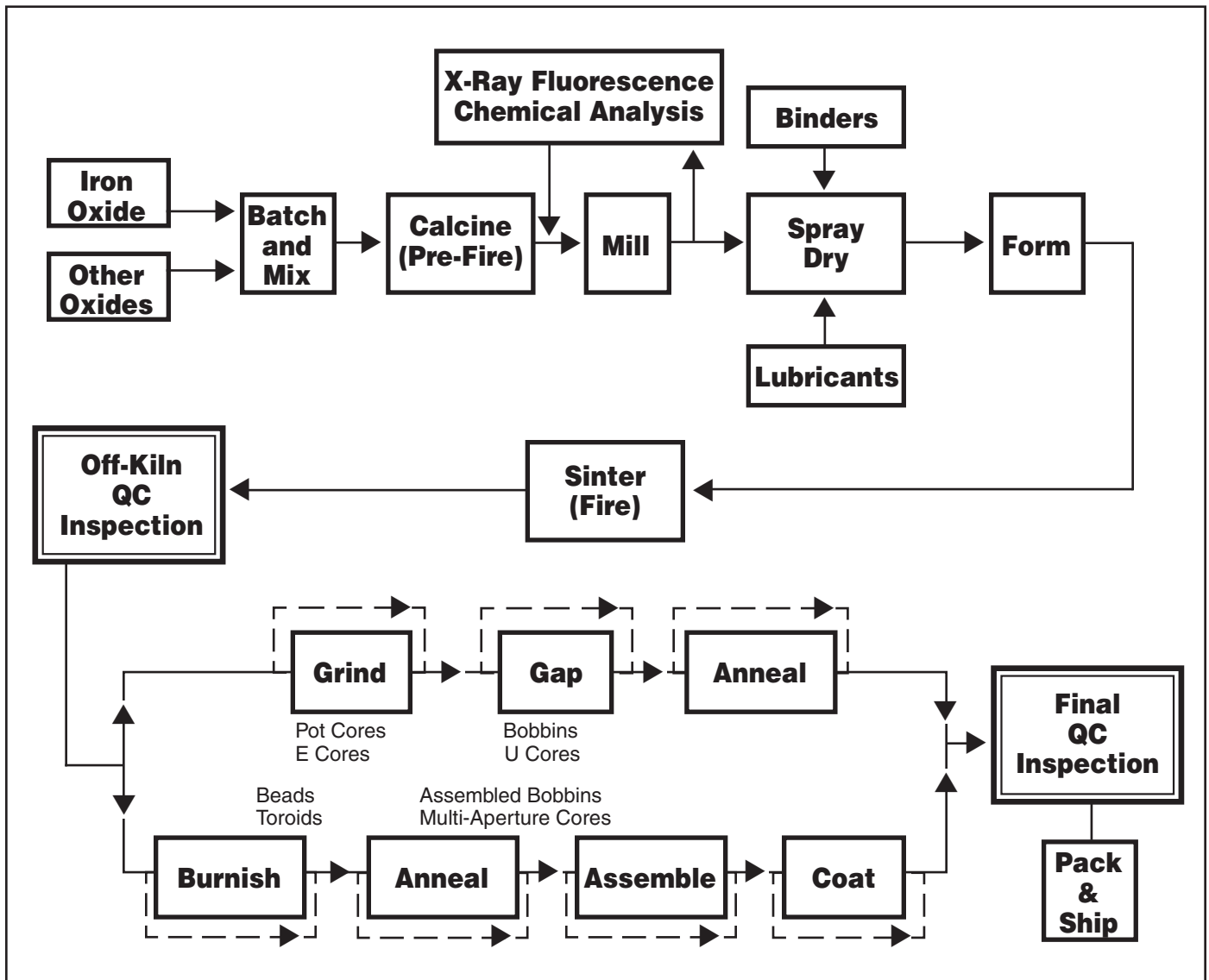

Fair-Rite Products Corp.
 CAGE # 34899
 Federal ID# 141389596

Ferrite Cores
 Standard Industrial Classification (SIC) 3264
 North American Industry
 Classification System (NAICS) 327113

Fair-Rite Products Corp.

PO Box J, One Commercial Row, Wallkill, NY 12589-0288

Phone: (888) FAIR RITE / (845) 895-2055 • FAX: (888) FERRITE / (845) 895-2629 • www.fair-rite.com
 (888) 324-7748 (888) 337-7483 • E-Mail: ferrites@fair-rite.com

Magnetic Properties of Ferrite Materials

Property	Unit	Symbol	68	67	61	52*	51	44
Initial Permeability @ B <10 gauss		μ_i	20	40	125	250	350	500
Flux Density @ Field Strength	gauss	B	2700	2300	2350	4200	3200	3000
	mT		270	230	235	420	320	300
	oersted	H	40	20	15	10	10	10
	A/m		3200	1600	1200	800	800	800
Residual Flux Density	gauss	Br	1000	800	1200	2900	1200	1100
	mT		100	80	120	290	120	110
Coercive Force	oersted	Hc	7.0	3.5	1.8	0.6	0.6	0.45
	A/m		560	280	144	48	48	36
Loss Factor @ Frequency	10 ⁻⁶ MHz	tan δ/μ_i	500	150	30	45	40	125
			100	50	1.0	1.0	1.0	1.0
Temperature Coefficient of Initial Permeability (20-70°C)	%/°C		0.10	0.05	0.10	1.0	0.8	0.75
Curie Temperature	°C	Tc	>500	>475	>300	>250	>170	>160
Resistivity	Ω cm	ρ	1x10 ⁷	1x10 ⁷	1x10 ⁸	1x10 ⁹	1x10 ⁹	1x10 ⁹
Power Loss Density 25kHz - 2000 G - 100°C 100kHz - 1000 G - 100°C 500kHz - 500 G - 100°C	mW cm ³	P	---	---	---	---	---	---
			---	---	---	---	---	---
			---	---	---	---	---	---
Recommended Frequency Range	MHz							
Application Areas	Low flux density devices. EMI suppression. Power magnetics. Special square loop ferrite.		<400	<300	<100	---	---	---
			---	---	>200	<500	>200	20 - 250
			---	---	---	---	---	---
			---	---	---	---	---	---
See this page for additional material data.			7	8	9	10	11	12

42 Material, specifically developed for absorber applications in anechoic chambers, is listed on page 93.

* New Fair-Rite material, added in this edition of the catalog.

Additional ferrite mechanical and thermal characteristics are tabulated on page 124.

Fair-Rite Products Corp.

PO Box J, One Commercial Row, Wallkill, NY 12589-0288

Phone: (888) FAIR RITE / (845) 895-2055 • FAX: (888) FERRITE / (845) 895-2629
(888) 324-7748 (888) 337-7483

• www.fair-rite.com
• E-Mail: ferrites@fair-rite.com

Magnetic Properties of Ferrite Materials

46*	33	85	43	79*	31	77	78	73	75	76
500	600	600	800	1400	1500	2000	2300	2500	5000	10000
3000	2800	4200	2900	4700	3400	4900	4800	3900	4300	4000
300	280	420	290	470	340	490	480	390	430	400
10	5	10	10	5	5	5	5	5	5	5
800	400	800	800	400	400	400	400	400	400	400
1900	1200	3700	1300	1700	2500	1800	1500	1500	1400	1800
190	120	370	130	170	250	180	150	150	140	180
0.40	0.60	0.50	0.45	0.40	0.35	0.30	0.20	0.24	0.16	0.12
32	48	40	36	32	28	24	16	19.2	13	9.6
60	25	30	250	4.0	20	15	4.5	10	15	15
0.1	0.2	0.1	1.0	0.1	0.1	0.1	0.1	0.1	0.1	0.025
---	0.10	---	1.25	0.6	1.6	0.7	1.0	0.65	0.6	0.5
>140	>150	>200	>130	>225	>130	>200	>200	>160	>140	>120
1x10 ⁸	1x10 ²	2x10 ²	1x10 ⁵	2x10 ²	3x10 ³	1x10 ²	2x10 ²	1x10 ²	3x10 ²	50
---	---	---	---	---	---	200	75	---	140	---
---	---	---	---	---	---	---	85	---	---	---
---	---	---	---	80	---	---	---	---	---	---
---	<3	---	<10	---	---	<3	<2.5	---	<0.75	<0.5
20 - 250	---	---	20 - 250	---	<500	---	---	<30	---	---
---	---	---	---	<0.75	---	<0.1	<0.5	---	<0.1	---
---	---	<0.15	---	---	---	---	---	---	---	---
13	14	15	16	18/19	17	20/21	22/23	24	25	26

Fair-Rite Products Corp.

PO Box J, One Commercial Row, Wallkill, NY 12589-0288

Phone: (888) FAIR RITE / (845) 895-2055 • FAX: (888) FERRITE / (845) 895-2629 • www.fair-rite.com
 (888) 324-7748 (888) 337-7483 • E-Mail: ferrites@fair-rite.com



Fair-Rite Products Corp.

Phone: (888) FAIR RITE / (845) 895-2055 • FAX: (888) FERRITE / (845) 895-2629
(888) 324-7748 (888) 337 -7483

PO Box J, One Commercial Row, Wallkill, NY 12589-0288

- www.fair-rite.com
- E-Mail: ferrites@fair-rite.com

68 Material

Our highest frequency NiZn ferrite intended for broadband transformers, antennas and HF high Q inductor applications up to 100 MHz. This material is only supplied to customer-specific requirements and close consultation with our application staff is suggested.

Strong magnetic fields or excessive mechanical stresses may result in irreversible changes in permeability and losses.

68 Material Specifications:

Property	Unit	Symbol	Value
Initial Permeability @ B < 10 gauss		μ_i	20
Flux Density @ Field Strength	gauss oersted	B H	2700 40
Residual Flux Density	gauss	B_r	1000
Coercive Force	oersted	H_c	7.0
Loss Factor @ Frequency	10^{-6} MHz	$\tan \delta / \mu_i$	500 100
Temperature Coefficient of Initial Permeability (20 -70°C)	%/°C		0.10
Curie Temperature	°C	T_c	>500
Resistivity	Ω cm	ρ	1×10^7

Complex Permeability vs. Frequency

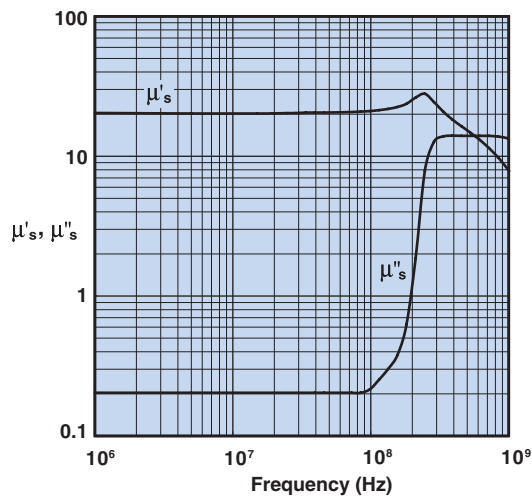

Measured on an 18/10/6mm toroid using the HP 4284A and the HP 4291A.

Initial Permeability vs. Temperature

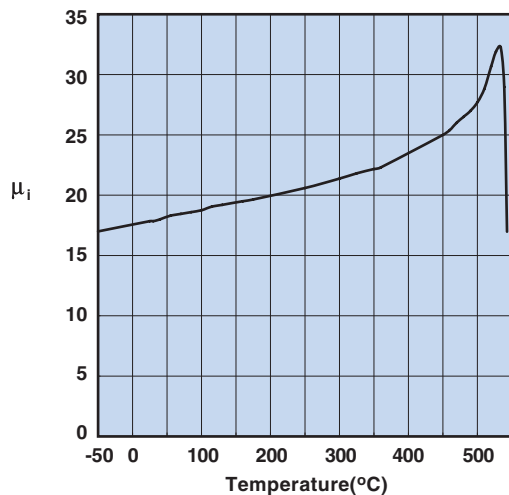

Measured on an 18/10/6mm toroid at 100kHz.

Hysteresis Loop

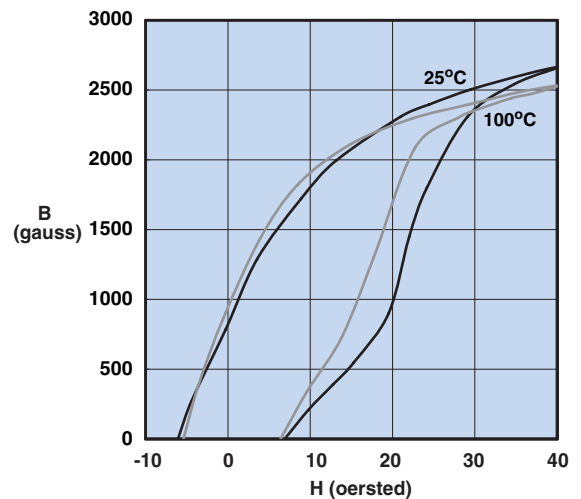

Measured on an 18/10/6mm toroid at 10kHz.

Fair-Rite Products Corp.

Phone: (888) FAIR RITE / (845) 895-2055 • FAX: (888) FERRITE / (845) 895-2629
(888) 324-7748 (888) 337-7483

PO Box J, One Commercial Row, Wallkill, NY 12589-0288

• www.fair-rite.com
• E-Mail: ferrites@fair-rite.com

67 Material

A high frequency NiZn ferrite for the design of broadband transformers, antennas and HF, high Q inductor applications up to 50 MHz. Toroids, multi-aperture cores and antenna/RFID rods are available in this material.

Strong magnetic fields or excessive mechanical stresses may result in irreversible changes in permeability and losses.

67 Material Specifications:

Property	Unit	Symbol	Value
Initial Permeability @ B < 10 gauss		μ_i	40
Flux Density @ Field Strength	gauss oersted	B H	2300 20
Residual Flux Density	gauss	B_r	800
Coercive Force	oersted	H_c	3.5
Loss Factor @ Frequency	10^{-6} MHz	$\tan \delta / \mu_i$	150 50
Temperature Coefficient of Initial Permeability (20 -70°C)	%/°C		0.05
Curie Temperature	°C	T_c	>475
Resistivity	Ω cm	ρ	1×10^7

Complex Permeability vs. Frequency

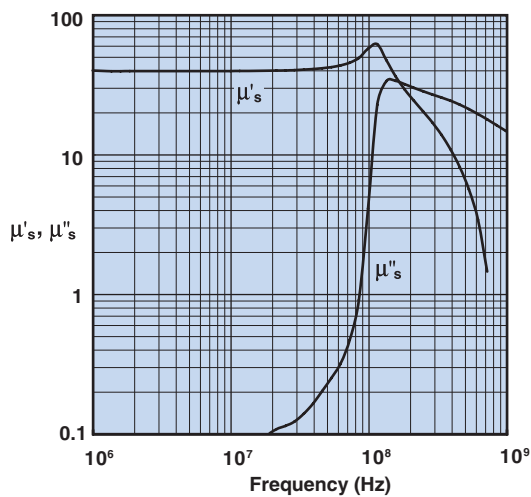

Measured on an 19/10/6mm toroid using the HP 4284A and the HP 4291A.

Initial Permeability vs. Temperature

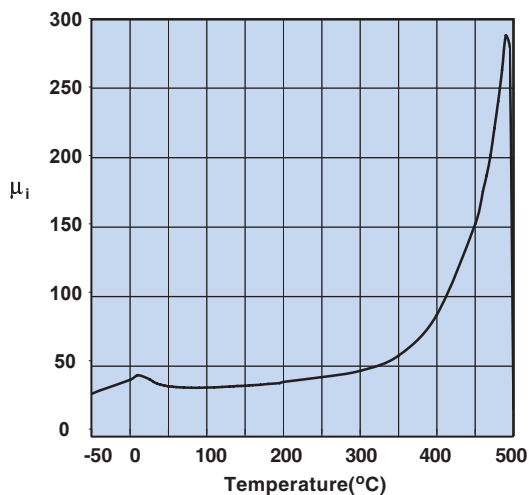

Measured on a 19/10/6mm toroid at 100kHz.

Hysteresis Loop

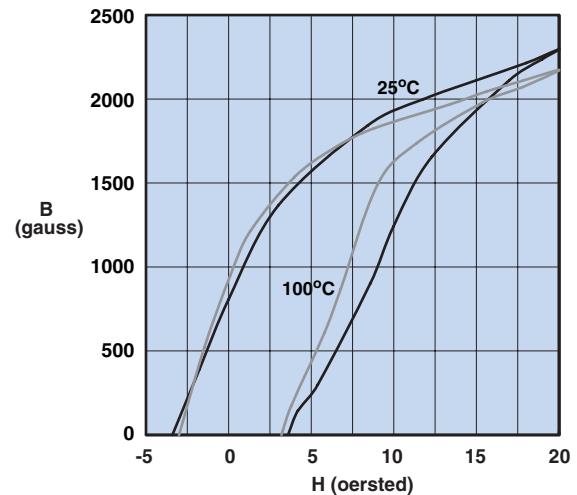

Measured on a 19/10/6mm toroid at 10kHz.

Fair-Rite Products Corp.

PO Box J, One Commercial Row, Wallkill, NY 12589-0288

Phone: (888) FAIR RITE / (845) 895-2055 • FAX: (888) FERRITE / (845) 895-2629
(888) 324-7748 (888) 337-7483

• www.fair-rite.com
• E-Mail: ferrites@fair-rite.com

61 Material

A high frequency NiZn ferrite developed for a range of inductive applications up to 25 MHz. This material is also used in EMI applications for suppression of noise frequencies above 200 MHz.

EMI suppression beads, beads on leads, SM beads, wound beads, multi-aperture cores, round cable EMI suppression cores, round cable snap-its, rods, antenna/RFID rods, and toroids are all available in 61 material.

Strong magnetic fields or excessive mechanical stresses may result in irreversible changes in permeability and losses.

61 Material Specifications:

Property	Unit	Symbol	Value
Initial Permeability @ B < 10 gauss		μ_i	125
Flux Density @ Field Strength	gauss oersted	B H	2350 15
Residual Flux Density	gauss	B_r	1200
Coercive Force	oersted	H_c	1.8
Loss Factor @ Frequency	10^{-6} MHz	$\tan \delta / \mu_i$	30 1.0
Temperature Coefficient of Initial Permeability (20 -70°C)	%/°C		0.10
Curie Temperature	°C	T_c	>300
Resistivity	Ω cm	ρ	1×10^8

Complex Permeability vs. Frequency

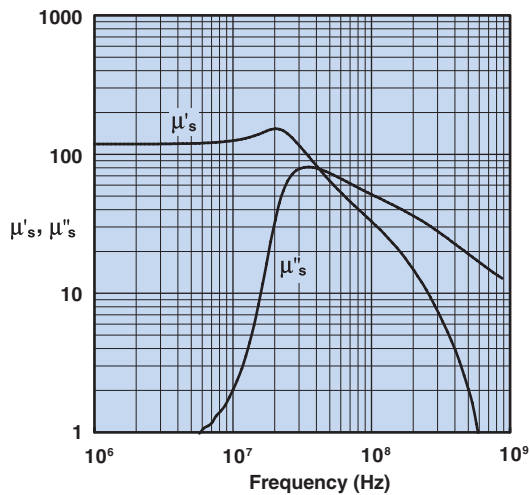

Measured on a 19/10/6mm toroid using the HP 4284A and the HP 4291A.

Percent of Original Impedance vs. Temperature

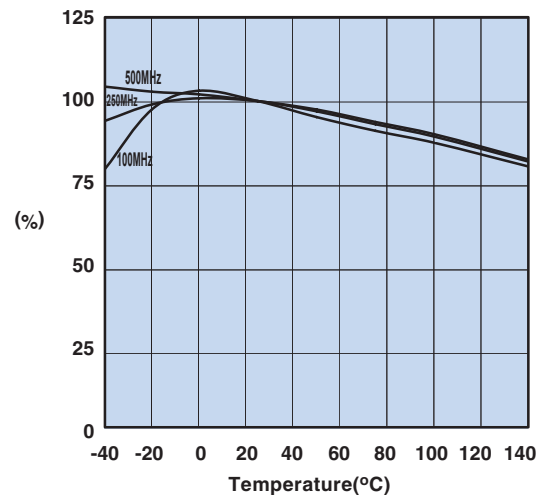

Measured on a 2661000301 using the HP4291A.

Initial Permeability vs. Temperature

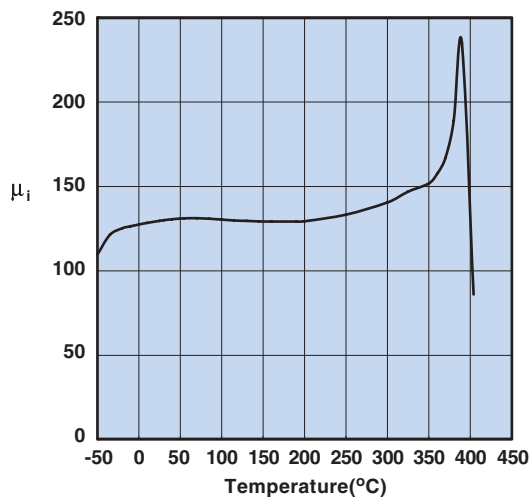

Measured on a 19/10/6mm toroid at 100kHz.

Hysteresis Loop

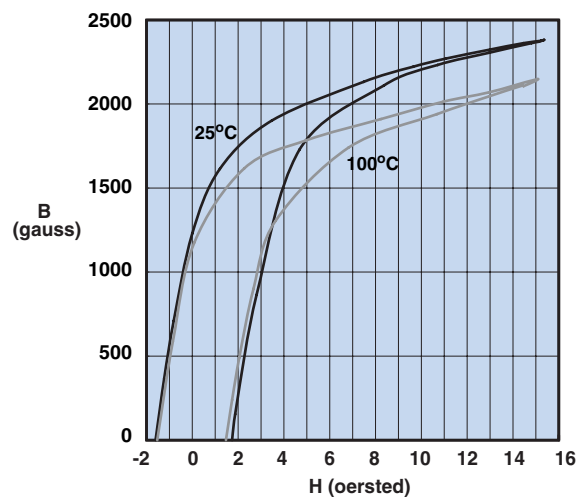

Measured on a 19/10/6mm toroid at 10kHz.

Fair-Rite Products Corp.

PO Box J, One Commercial Row, Wallkill, NY 12589-0288

Phone: (888) FAIR RITE / (845) 895-2055 • FAX: (888) FERRITE / (845) 895-2629
(888) 324-7748 (888) 337-7483

• www.fair-rite.com
• E-Mail: ferrites@fair-rite.com

52 Material

A new high frequency NiZn ferrite material, that combines a high saturation flux density and a high Curie temperature.

SM beads, PC beads and a range of rod cores are available in this material.

52 Material Specifications:

Property	Unit	Symbol	Value
Initial Permeability @ B < 10 gauss		μ_i	250
Flux Density @ Field Strength	gauss oersted	B H	4200 10
Residual Flux Density	gauss	B_r	2900
Coercive Force	oersted	H_c	0.60
Loss Factor @ Frequency	10^{-6} MHz	$\tan \delta / \mu_i$	45 1.0
Temperature Coefficient of Initial Permeability (20 -70°C)	%/°C		1.0
Curie Temperature	°C	T_c	>250
Resistivity	Ω cm	ρ	1×10^9

Complex Permeability vs. Frequency

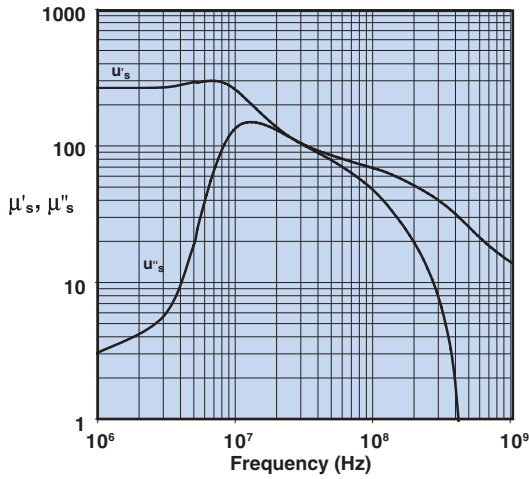

Measured on a 17/10/6mm toroid using the HP 4284A and the HP 4291A.

Flux Density vs. Temperature

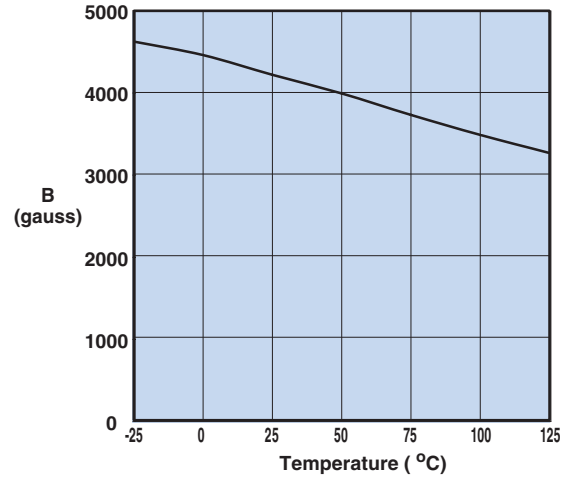

Measured on a 17/10/6mm toroid at 10kHz

Initial Permeability vs. Temperature

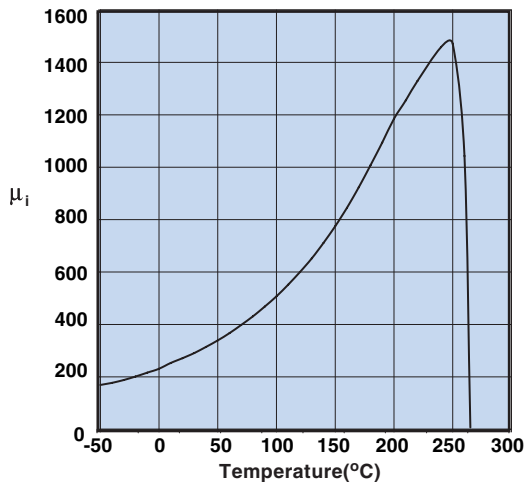

Measured on a 17/10/6mm toroid at 100kHz.

Hysteresis Loop

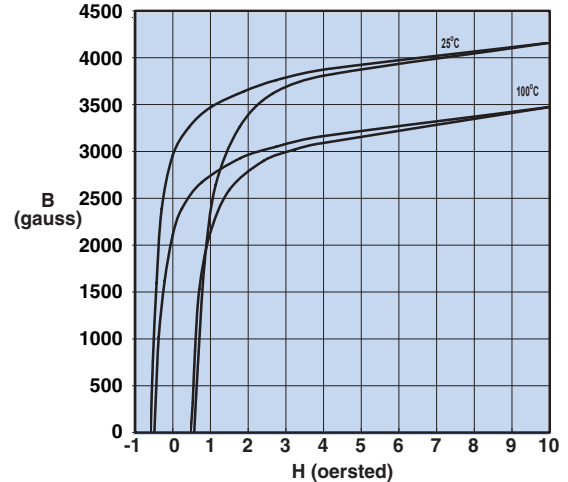

Measured on a 17/10/6mm toroid at 10kHz.

Fair-Rite Products Corp.

Phone: (888) FAIR RITE / (845) 895-2055 • FAX: (888) FERRITE / (845) 895-2629
(888) 324-7748 (888) 337 -7483

PO Box J, One Commercial Row, Wallkill, NY 12589-0288

• www.fair-rite.com
• E-Mail: ferrites@fair-rite.com

51 Material

A NiZn ferrite developed for low loss inductive designs for frequencies up to 5.0 MHz.

51 Material Specifications:

Property	Unit	Symbol	Value
Initial Permeability @ B < 10 gauss		μ_i	350
Flux Density @ Field Strength	gauss oersted	B H	3200 10
Residual Flux Density	gauss	B_r	1200
Coercive Force	oersted	H_c	0.60
Loss Factor @ Frequency	10^{-6} MHz	$\tan \delta / \mu_i$	40 1.0
Temperature Coefficient of Initial Permeability (20 -70°C)	%/°C		0.8
Curie Temperature	°C	T_c	>170
Resistivity	Ω cm	ρ	1×10^9

Complex Permeability vs. Frequency

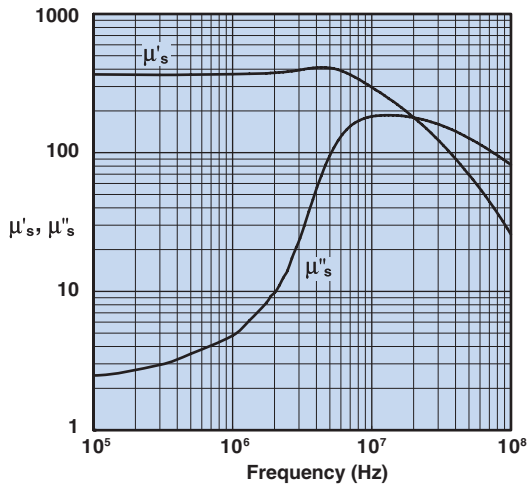

Measured on a 17/10/6mm toroid using the HP 4284A and the HP 4291A.

Incremental Permeability vs. H

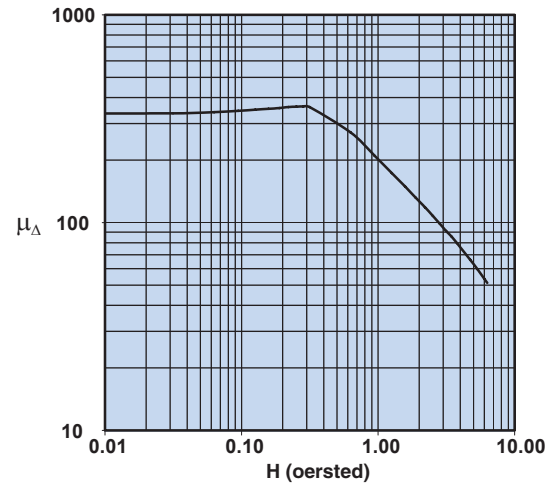

Initial Permeability vs. Temperature

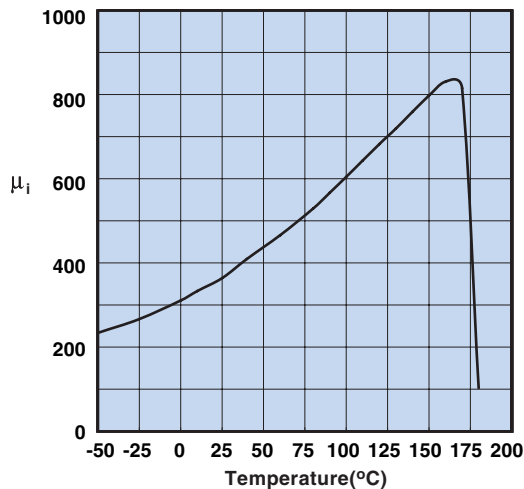

Measured on a 17/10/6mm toroid at 100kHz.

Hysteresis Loop

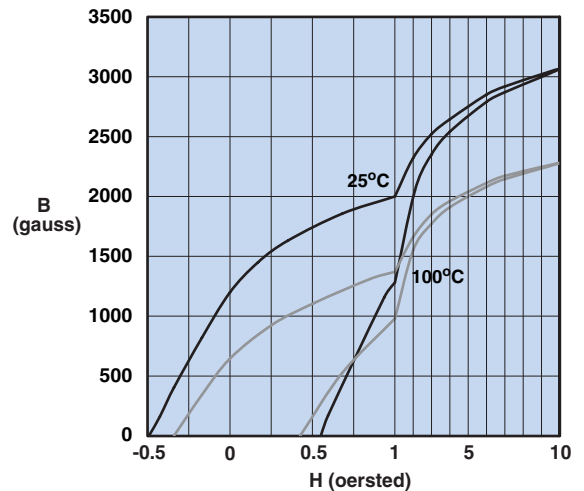

Measured on a 17/10/6mm toroid at 10kHz.

Fair-Rite Products Corp.

Phone: (888) FAIR RITE / (845) 895-2055 • FAX: (888) FERRITE / (845) 895-2629
(888) 324-7748 (888) 337-7483

PO Box J, One Commercial Row, Wallkill, NY 12589-0288

• www.fair-rite.com
• E-Mail: ferrites@fair-rite.com

44 Material

A NiZn ferrite developed to combine a high suppression performance, from 30 MHz to 500 MHz, with a very high dc resistivity.

SM beads, PC beads, wound beads, split round cable EMI suppression cores, round cable snap-its, and connector EMI suppression plates are all available in 44 material.

44 Material Specifications:

Property	Unit	Symbol	Value
Initial Permeability @ B < 10 gauss		μ_i	500
Flux Density @ Field Strength	gauss oersted	B H	3000 10
Residual Flux Density	gauss	B_r	1100
Coercive Force	oersted	H_c	0.45
Loss Factor @ Frequency	10^{-6} MHz	$\tan \delta / \mu_i$	125 1.0
Temperature Coefficient of Initial Permeability (20 -70°C)	%/°C		0.75
Curie Temperature	°C	T_c	>160
Resistivity	Ω cm	ρ	1×10^9

Complex Permeability vs. Frequency

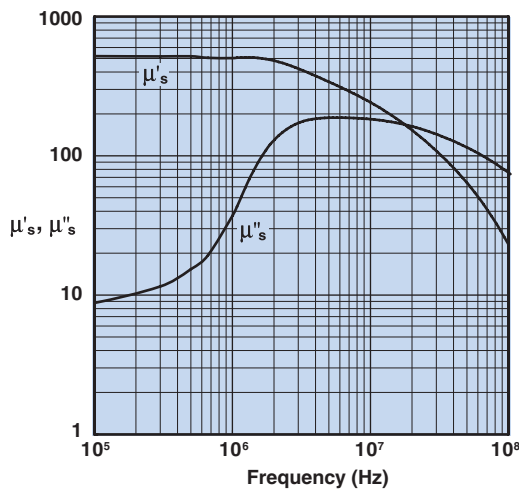

Measured on a 17/10/6mm toroid using the HP 4284A and the HP 4291A.

Percent of Original Impedance vs. Temperature

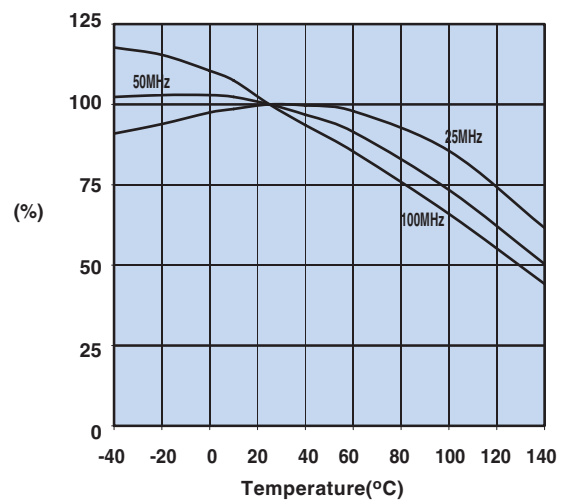

Measured on a 2644000301 using the HP4291A.

Initial Permeability vs. Temperature

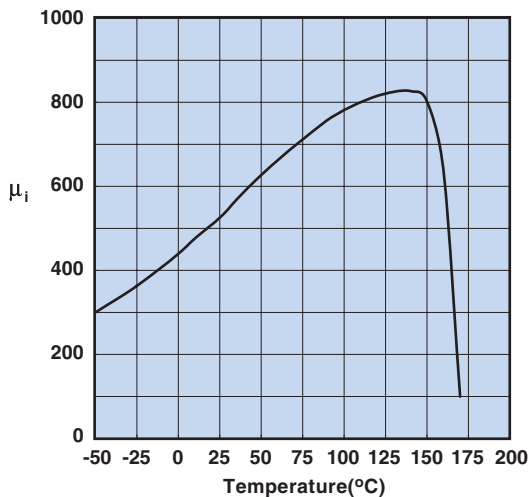

Measured on a 17/10/6mm toroid at 100kHz.

Hysteresis Loop

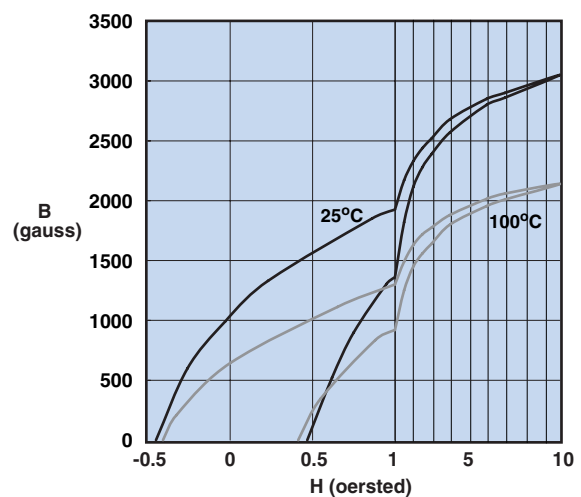

Measured on a 17/10/6mm toroid at 10kHz.

Fair-Rite Products Corp.

Phone: (888) FAIR RITE / (845) 895-2055 • FAX: (888) FERRITE / (845) 895-2629
(888) 324-7748 (888) 337 -7483

PO Box J, One Commercial Row, Wallkill, NY 12589-0288

• www.fair-rite.com
• E-Mail: ferrites@fair-rite.com

46 Material

Our latest material development is a MgZn ferrite intended for suppression applications. This material does not use nickel in its composition, hence it avoids potential environmental issues as well as reduces the cost of the material component of suppression parts. The suppression performance of this 46 material is similar to our widely used 43 material.

The new Fair-Rite grade 46 will initially be supplied in the larger sizes of the round cable EMI suppression and snap-it cores.

46 Material Specifications:

Property	Unit	Symbol	Value
Initial Permeability @ B < 10 gauss		μ_i	500
Flux Density @ Field Strength	gauss oersted	B H	3000 10
Residual Flux Density	gauss	B_r	1900
Coercive Force	oersted	H_c	0.40
Loss Factor @ Frequency	10^{-6} MHz	$\tan \delta / \mu_i$	60 0.1
Temperature Coefficient of Initial Permeability (20 -70°C)	%/°C		-----
Curie Temperature	°C	T_c	>140
Resistivity	Ω cm	ρ	1×10^8

Complex Permeability vs. Frequency

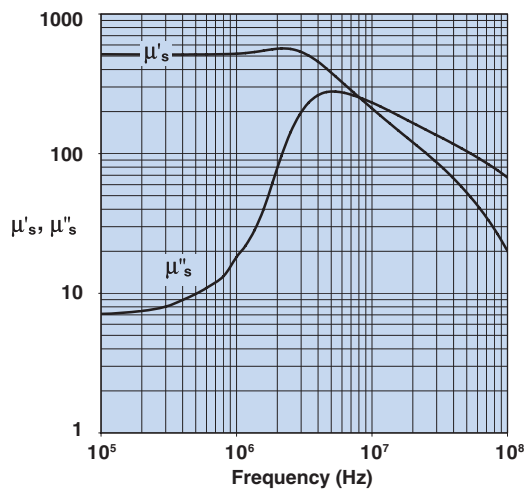

Measured on a 17/10/6mm toroid using the HP 4284A and the HP 4291A.

Percent of Original Impedance vs. Temperature

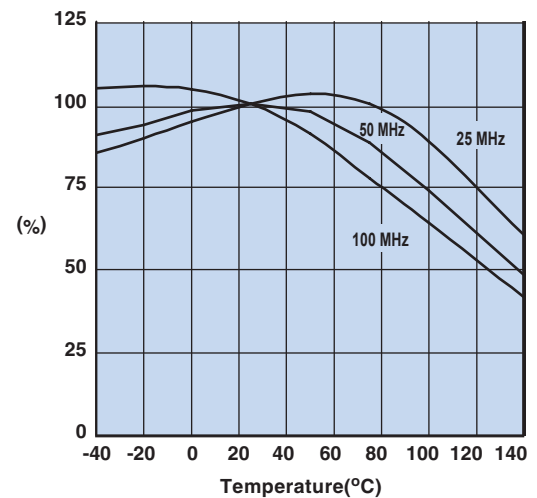

Measured on a 2646000301 using the HP4291A.

Initial Permeability vs. Temperature

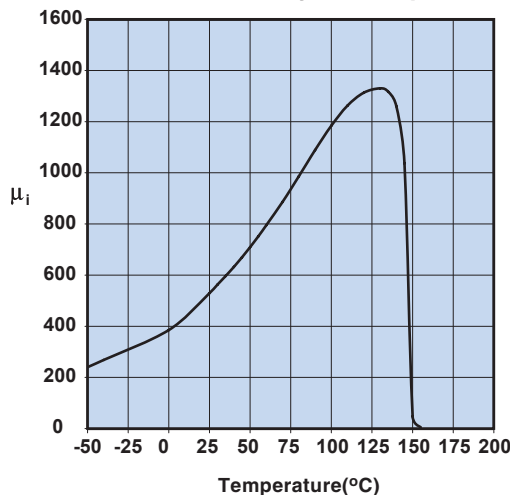

Measured on a 17/10/6mm toroid at 100kHz.

Hysteresis Loop

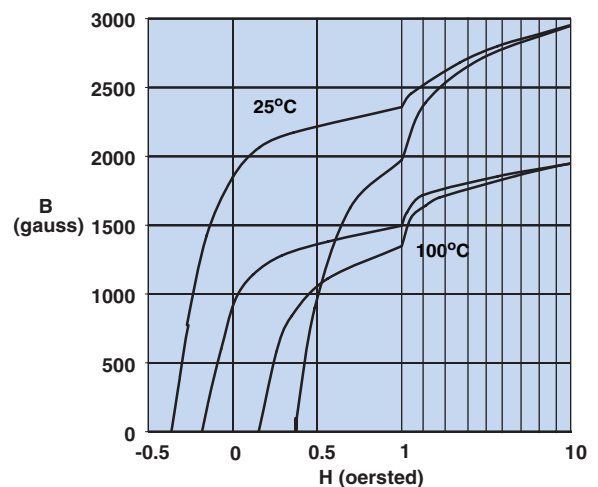

Measured on a 17/10/6mm toroid at 10kHz.

Fair-Rite Products Corp.

PO Box J, One Commercial Row, Wallkill, NY 12589-0288

Phone: (888) FAIR RITE / (845) 895-2055 • FAX: (888) FERRITE / (845) 895-2629
(888) 324-7748 (888) 337-7483

• www.fair-rite.com
• E-Mail: ferrites@fair-rite.com

33 Material

An economical MnZn ferrite designed for use in open circuit applications for frequencies up to 3.0 MHz.

Rods are available in 33 material.

33 Material Specifications:

Property	Unit	Symbol	Value
Initial Permeability @ B < 10 gauss		μ_i	600
Flux Density @ Field Strength	gauss oersted	B H	2800 5
Residual Flux Density	gauss	B_r	1200
Coercive Force	oersted	H_c	0.60
Loss Factor @ Frequency	10^{-6} MHz	$\tan \delta / \mu_i$	25 0.2
Temperature Coefficient of Initial Permeability (20 -70°C)	%/°C		0.10
Curie Temperature	°C	T_c	>150
Resistivity	Ω cm	ρ	1×10^{-2}

Complex Permeability vs. Frequency

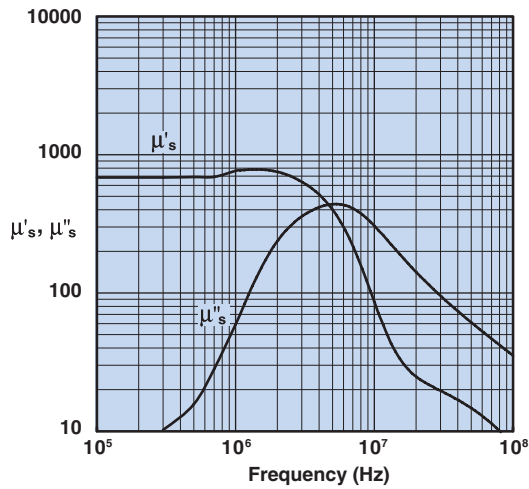

Measured on a 17/10/6mm toroid using the HP 4284A and, the HP 4291A.

Initial Permeability vs. Temperature

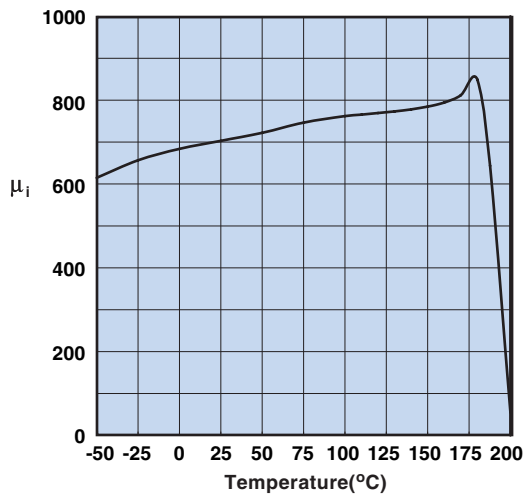

Measured on a 17/10/6mm toroid at 100kHz.

Hysteresis Loop

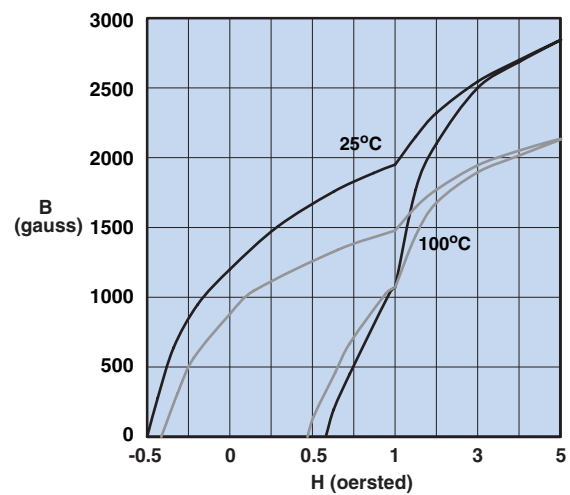

Measured on a 17/10/6mm toroid at 10kHz.

Fair-Rite Products Corp.

Phone: (888) FAIR RITE / (845) 895-2055 • FAX: (888) FERRITE / (845) 895-2629
(888) 324-7748 (888) 337 -7483

PO Box J, One Commercial Row, Wallkill, NY 12589-0288

• www.fair-rite.com
• E-Mail: ferrites@fair-rite.com

85 Material

A square hysteresis loop Mn ferrite developed for use in output regulators and magnetic amplifier designs.

Toroids are available in 85 material.

85 Material Specifications:

Property	Unit	Symbol	Value
Initial Permeability @ B < 10 gauss		μ_i	900
Flux Density @ Field Strength	gauss oersted	B H	4200 10
Residual Flux Density	gauss	B_r	3700
Coercive Force	oersted	H_c	0.50
Loss Factor @ Frequency	10^{-6} MHz	$\tan \delta / \mu_i$	30 0.1
Temperature Coefficient of Initial Permeability (20 -70°C)	%/°C		—
Curie Temperature	°C	T_c	>200
Resistivity	Ω cm	ρ	2×10^2

Complex Permeability vs. Frequency

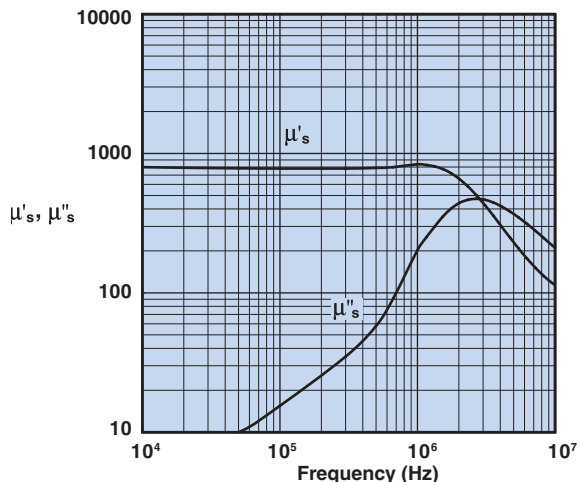

Measured on a 13/8/6mm toroid at 25°C using the HP 4284A and the HP 4291A.

Flux Density, Coercive Force and Squareness Ratio vs. Temperature

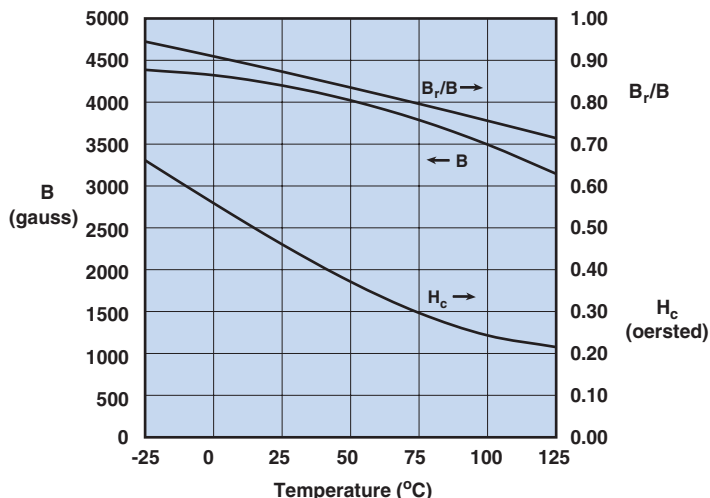

Measured on a 13/8/6mm toroid at 10 kHz. B is measured at H=10 oersted.

Initial Permeability vs. Temperature

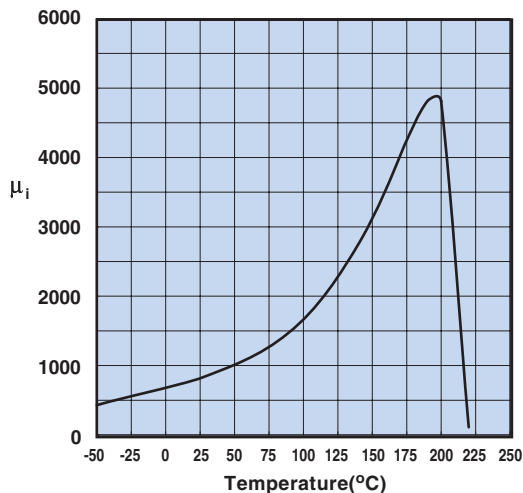

Measured on a 13/8/6mm toroid at 100kHz using the HP 4275.

Hysteresis Loop

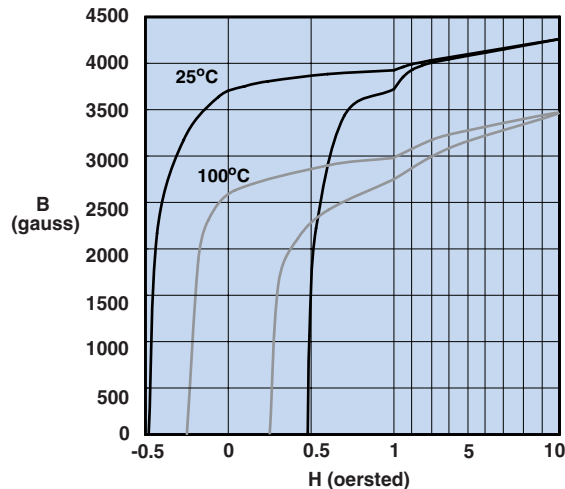

Measured on a 13/8/6mm toroid at 10 kHz.

Fair-Rite Products Corp.

Phone: (888) FAIR RITE / (845) 895-2055 • FAX: (888) FERRITE / (845) 895-2629
(888) 324-7748 (888) 337-7483

PO Box J, One Commercial Row, Wallkill, NY 12589-0288

• www.fair-rite.com
• E-Mail: ferrites@fair-rite.com

43 Material

This NiZn is our most popular ferrite for suppression of conducted EMI from 20 MHz to 250 MHz. This material is also used for inductive applications such as high frequency common-mode chokes.

EMI suppression beads, beads on leads, SM beads, multi-aperture cores, round cable EMI suppression cores, split round EMI suppression cores, round cable snap-its, flat cable EMI suppression cores, flat cable snap-its, miscellaneous suppression cores, bobbins, and toroids are all available in 43 material.

43 Material Specifications:

Property	Unit	Symbol	Value
Initial Permeability @ B < 10 gauss		μ_i	800
Flux Density @ Field Strength	gauss oersted	B H	2900 10
Residual Flux Density	gauss	B_r	1300
Coercive Force	oersted	H_c	0.45
Loss Factor @ Frequency	10^{-6} MHz	$\tan \delta / \mu_i$	250 1.0
Temperature Coefficient of Initial Permeability (20 -70°C)	%/°C		1.25
Curie Temperature	°C	T_c	>130
Resistivity	Ω cm	ρ	1×10^5

Complex Permeability vs. Frequency

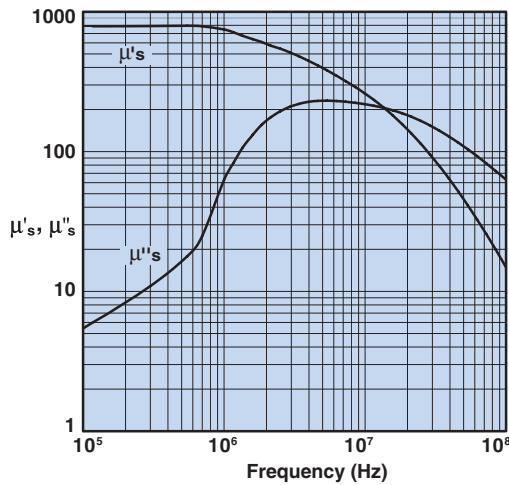

Measured on a 17/10/6mm toroid using the HP 4284A and the HP 4291A.

Percent of Original Impedance vs. Temperature

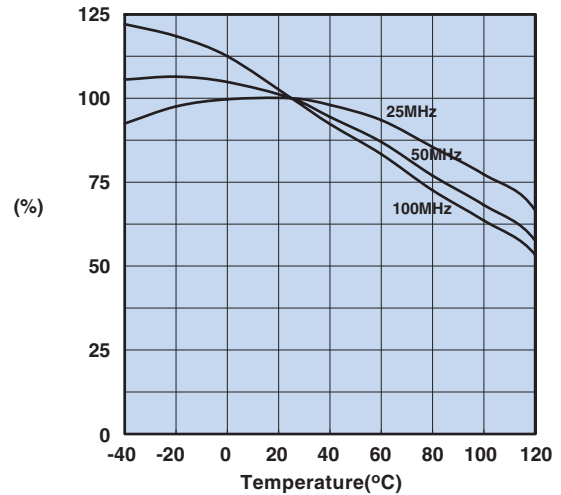

Measured on a 2643000301 using the HP4291A.

Initial Permeability vs. Temperature

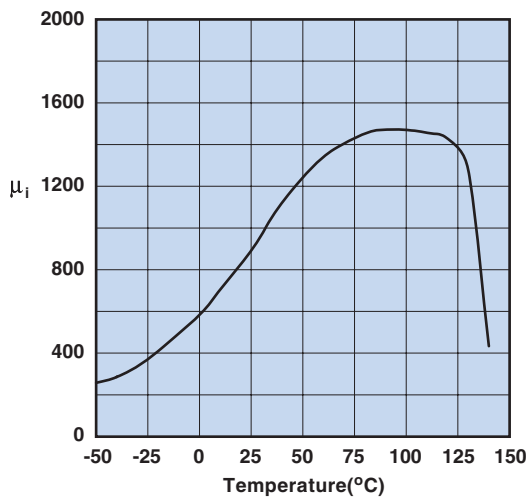

Measured on a 17/10/6mm toroid at 100kHz.

Hysteresis Loop

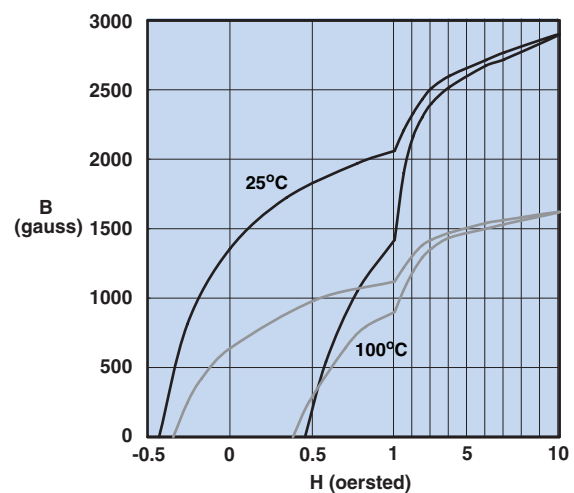

Measured on a 17/10/6mm toroid at 10kHz.

Fair-Rite Products Corp.

Phone: (888) FAIR RITE / (845) 895-2055 • FAX: (888) FERRITE / (845) 895-2629
(888) 324-7748 (888) 337-7483

PO Box J, One Commercial Row, Wallkill, NY 12589-0288

• www.fair-rite.com
• E-Mail: ferrites@fair-rite.com

31 Material

A MnZn ferrite designed specifically for EMI suppression applications from as low as 1 MHz up to 500 MHz. This material does not have the dimensional resonance limitations associated with conventional MnZn ferrite materials.

EMI suppression beads, round cable EMI suppression cores, round cable snap-its, flat cable EMI suppression cores, and flat cable snap-its are all available in 31 material.

31 Material Specifications:

Property	Unit	Symbol	Value
Initial Permeability @ B < 10 gauss		μ_i	1500
Flux Density @ Field Strength	gauss oersted	B H	3400 5
Residual Flux Density	gauss	B_r	2500
Coercive Force	oersted	H_c	0.35
Loss Factor @ Frequency	10^{-6} MHz	$\tan \delta / \mu_i$	20 0.1
Temperature Coefficient of Initial Permeability (20 -70°C)	%/°C		1.6
Curie Temperature	°C	T_c	>130
Resistivity	Ω cm	ρ	3×10^9

Complex Permeability vs. Frequency

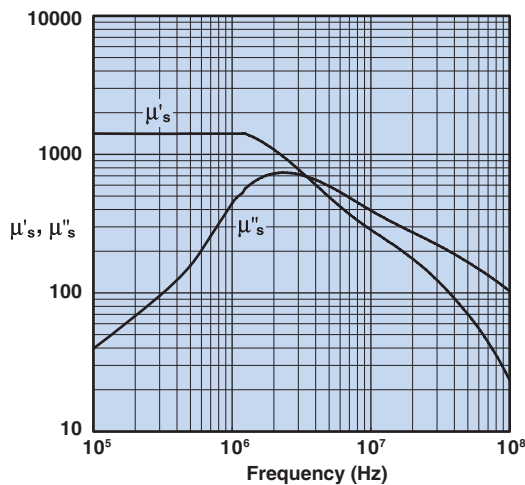

Measured on a 17/10/6mm toroid at 25°C using the HP 4284A and the HP 4291A.

Percent of Original Impedance vs. Temperature

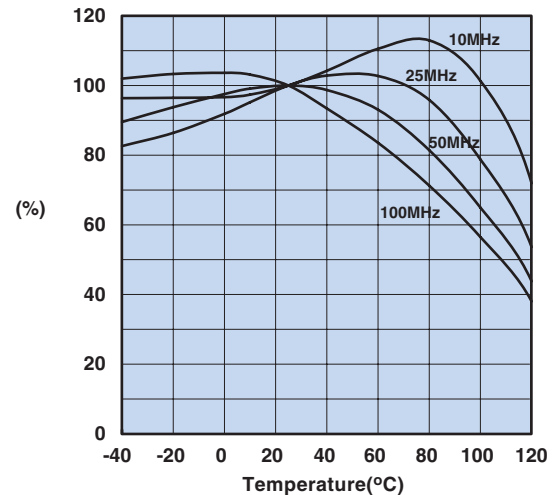

Measured on a 2631000301 using the HP4291A.

Initial Permeability vs. Temperature

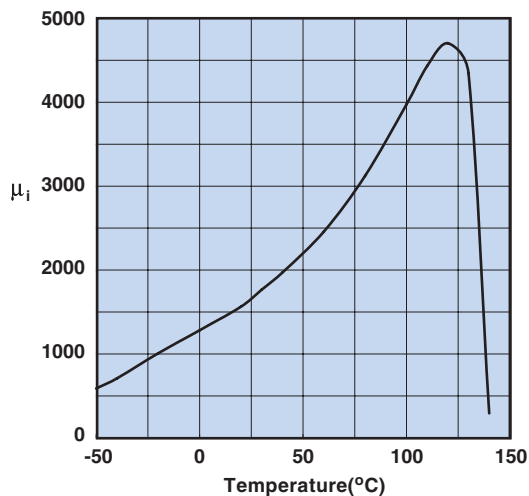

Measured on a 17/10/6mm toroid at 100kHz.

Hysteresis Loop

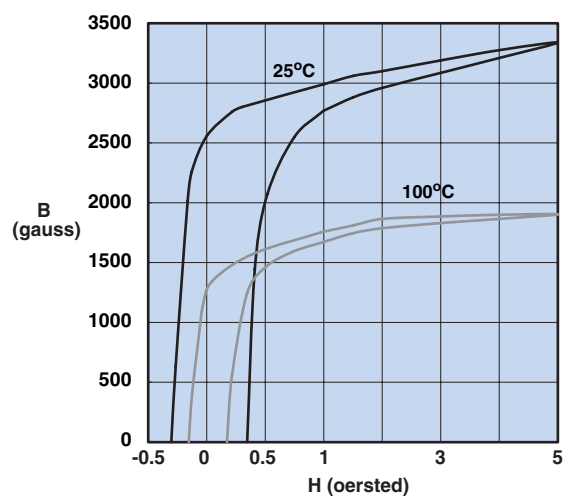

Measured on a 17/10/6mm toroid at 10kHz.

Fair-Rite Products Corp.

PO Box J, One Commercial Row, Wallkill, NY 12589-0288

Phone: (888) FAIR RITE / (845) 895-2055 • FAX: (888) FERRITE / (845) 895-2629
(888) 324-7748 (888) 337-7483

• www.fair-rite.com
• E-Mail: ferrites@fair-rite.com

79 Material

A new high frequency material for power applications up to 750 kHz.

This MnZn power ferrite is available in customer specific core designs.

79 Material Specifications:

Property	Unit	Symbol	Value
Initial Permeability @ B < 10 gauss		μ_i	1400
Flux Density @ Field Strength	gauss oersted	B H	4700 5
Residual Flux Density	gauss	B_r	1700
Coercive Force	oersted	H_c	0.40
Loss Factor @ Frequency	10^{-6} MHz	$\tan \delta / \mu_i$	4.0 0.1
Temperature Coefficient of Initial Permeability (20 -70°C)	%/°C		0.6
Curie Temperature	°C	T_c	>225
Resistivity	Ω cm	ρ	2×10^2

Complex Permeability vs. Frequency

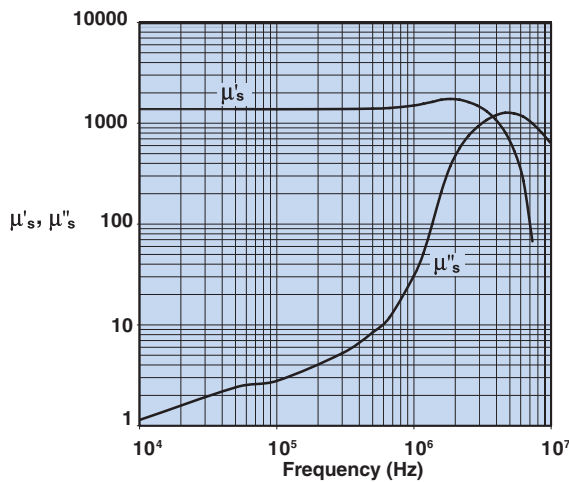

Measured on an 18/10/6mm toroid using the HP 4284A and the HP 4291A.

Incremental Permeability vs. H

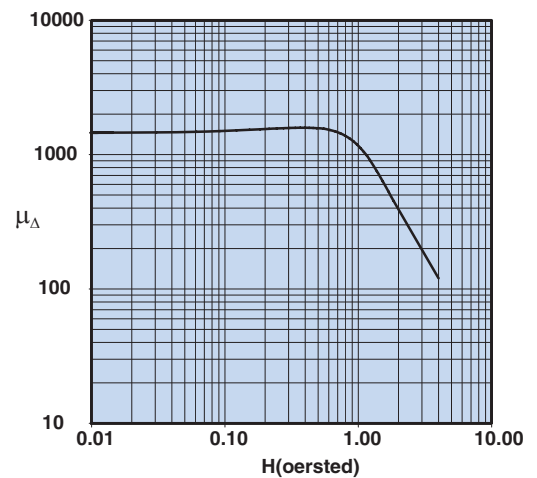

Initial Permeability vs. Temperature

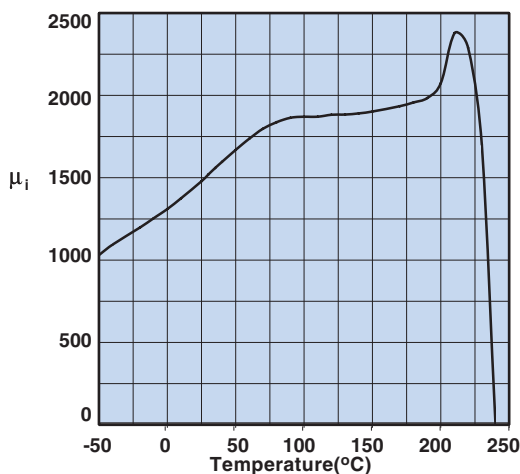

Measured on an 18/10/6mm toroid at 100kHz.

Hysteresis Loop

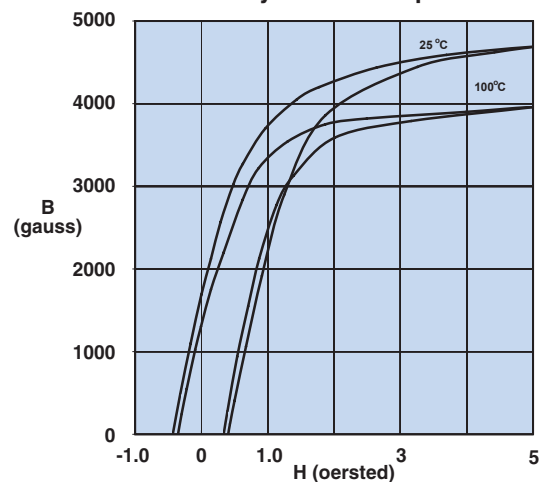

Measured on an 18/10/6mm toroid at 10kHz.

Fair-Rite Products Corp.

Phone: (888) FAIR RITE / (845) 895-2055 • FAX: (888) FERRITE / (845) 895-2629
(888) 324-7748 (888) 337 -7483

PO Box J, One Commercial Row, Wallkill, NY 12589-0288

• www.fair-rite.com
• E-Mail: ferrites@fair-rite.com

79 Material

Amplitude Permeability vs. Flux Density

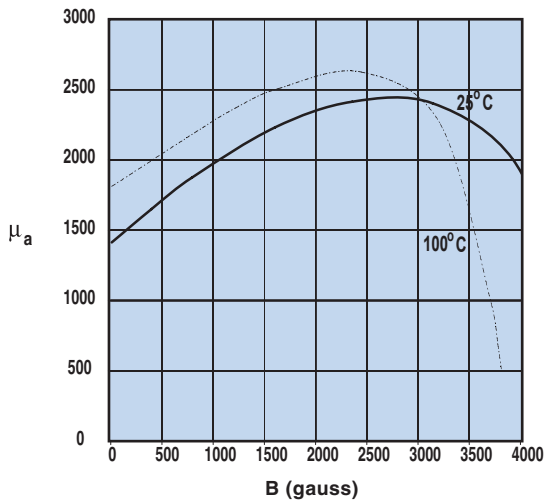

Measured on an 18/10/6mm toroid at 10kHz.

Power Loss Density vs. Flux Density

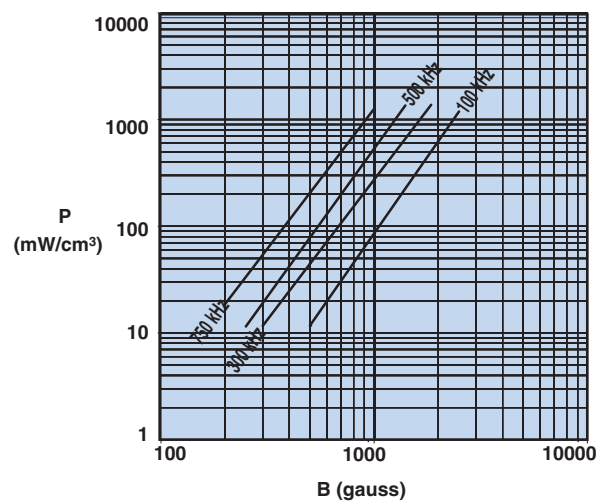

Measured on an 18/10/6mm toroid using the Clarke Hess 258 VAW at 100°C

Power Loss Density vs. Temperature

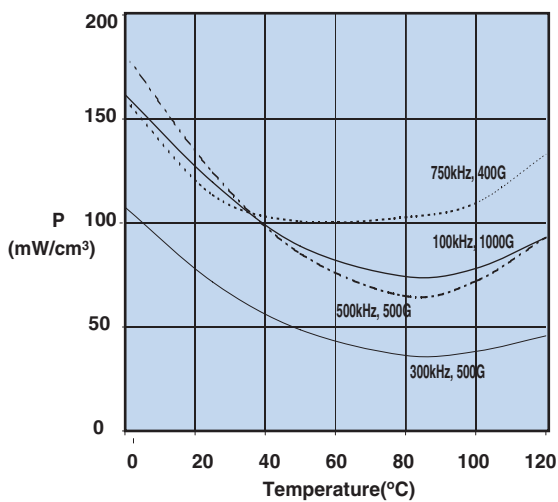

Measured on an 18/10/6mm toroid using the Clarke Hess 258 VAW.

Flux Density vs. Temperature

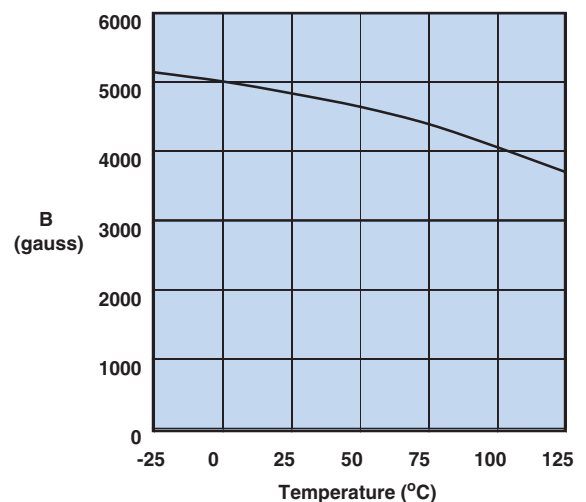

Measured on an 18/10/6mm toroid at 10kHz and H=5 oersted.

77 Material

A MnZn ferrite for use in a wide range of high and low flux density inductive designs for frequencies up to 100 kHz.

E&I cores, U cores, rods, tack bobbin cores, toroids, and bobbins are all available in 77 material.

77 Material Specifications:

Property	Unit	Symbol	Value
Initial Permeability @ B < 10 gauss		μ_i	2000
Flux Density @ Field Strength	gauss oersted	B H	4900 5
Residual Flux Density	gauss	B_r	1800
Coercive Force	oersted	H_c	0.30
Loss Factor @ Frequency	10^{-6} MHz	$\tan \delta / \mu_i$	15 0.1
Temperature Coefficient of Initial Permeability (20 - 70°C)	%/°C		0.7
Curie Temperature	°C	T_c	>200
Resistivity	Ω cm	ρ	1×10^2

Complex Permeability vs. Frequency

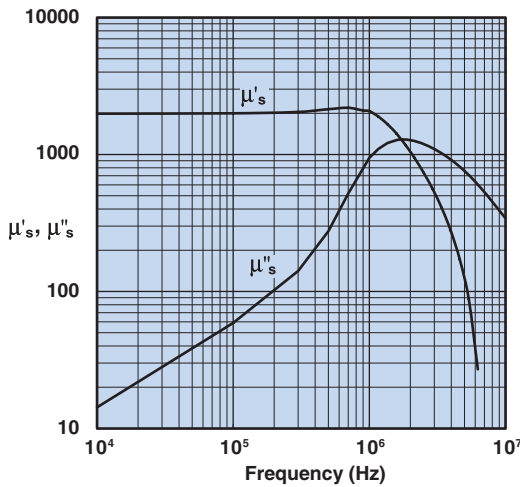

Measured on an 18/10/6mm toroid using the HP 4284A and the HP 4291A.

Incremental Permeability vs. H

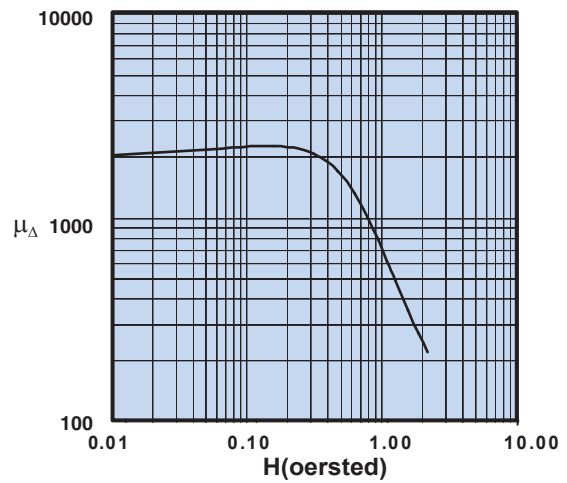

Initial Permeability vs. Temperature

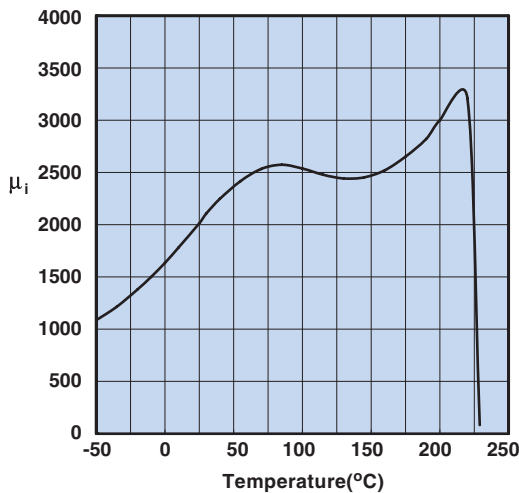

Measured on an 18/10/6mm toroid at 100kHz.

Hysteresis Loop

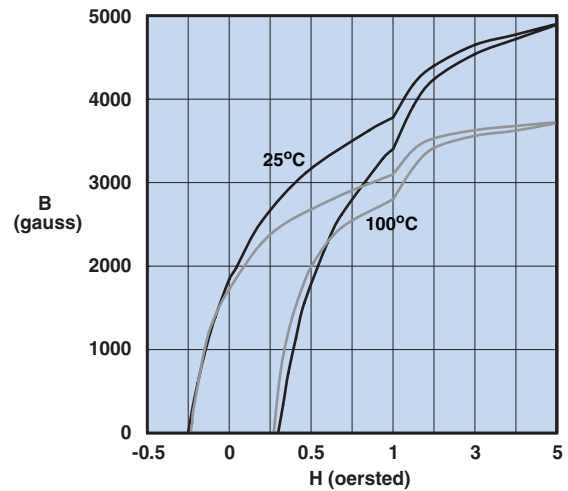

Measured on an 18/10/6mm toroid at 10kHz.

Fair-Rite Products Corp.

Phone: (888) FAIR RITE / (845) 895-2055 • FAX: (888) FERRITE / (845) 895-2629
(888) 324-7748 (888) 337 -7483

PO Box J, One Commercial Row, Wallkill, NY 12589-0288

• www.fair-rite.com
• E-Mail: ferrites@fair-rite.com

77 Material

Amplitude Permeability vs. Flux Density

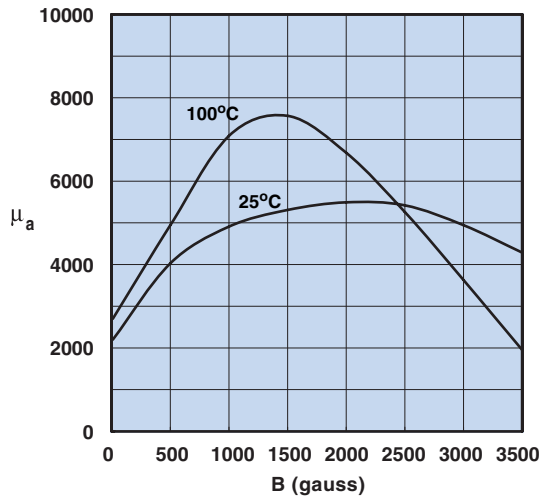

Measured on an 18/10/6mm toroid at 10kHz.

Power Loss Density vs. Flux Density

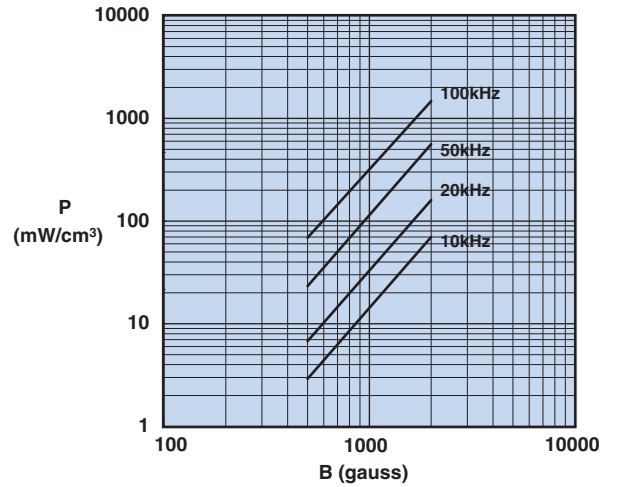

Measured on an 18/10/6mm toroid using the Clarke Hess 258 VAW at 100°C

Power Loss Density vs. Temperature

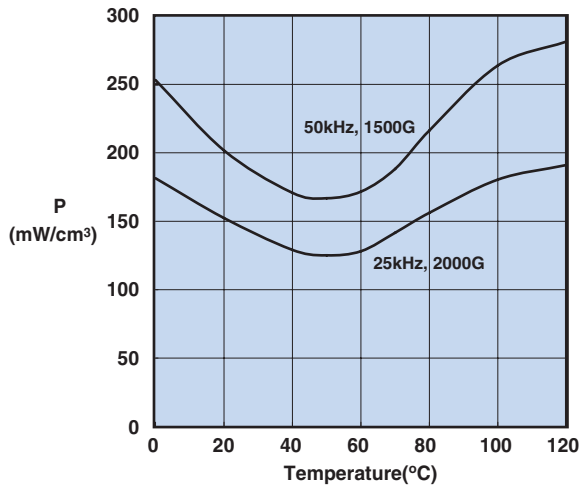

Measured on an 18/10/6mm toroid using the Clarke Hess 258 VAW.

Flux Density vs. Temperature

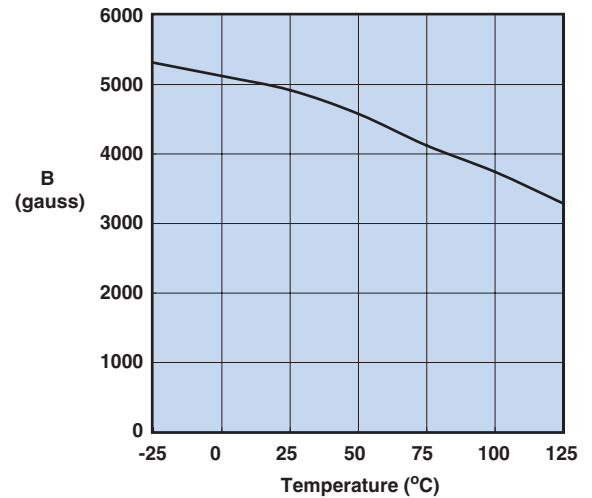

Measured on an 18/10/6mm toroid at 10kHz and H=5 oersted.

78 Material

A MnZn ferrite specifically designed for power applications for frequencies up to 200 kHz.

RFID rods, toroids, pot cores, and E&I cores are all available in 78 material.

78 Material Specifications:

Property	Unit	Symbol	Value
Initial Permeability @ B < 10 gauss		μ_i	2300
Flux Density @ Field Strength	gauss oersted	B H	4800 5
Residual Flux Density	gauss	B_r	1500
Coercive Force	oersted	H_c	0.20
Loss Factor @ Frequency	10^{-6} MHz	$\tan \delta / \mu_i$	4.5 0.1
Temperature Coefficient of Initial Permeability (20 -70°C)	%/°C		1.0
Curie Temperature	°C	T_c	>200
Resistivity	Ω cm	ρ	2×10^2

Complex Permeability vs. Frequency

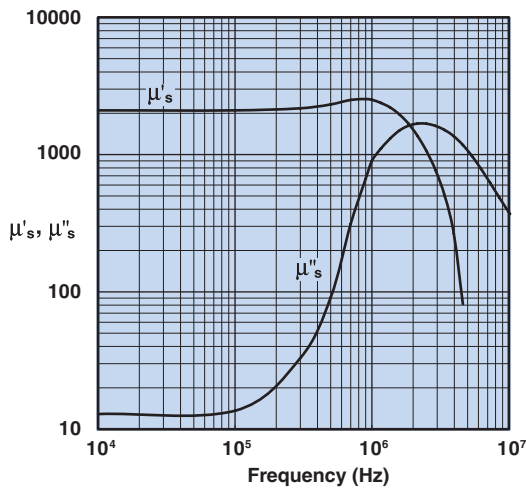

Measured on an 18/10/6mm toroid using the HP 4284A and the HP 4291A.

Incremental Permeability vs. H

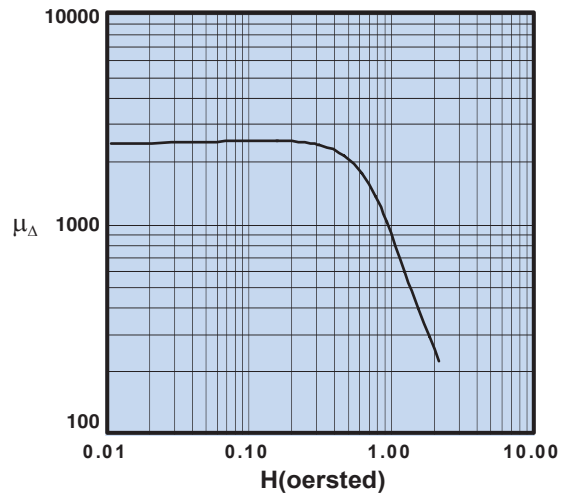

Initial Permeability vs. Temperature

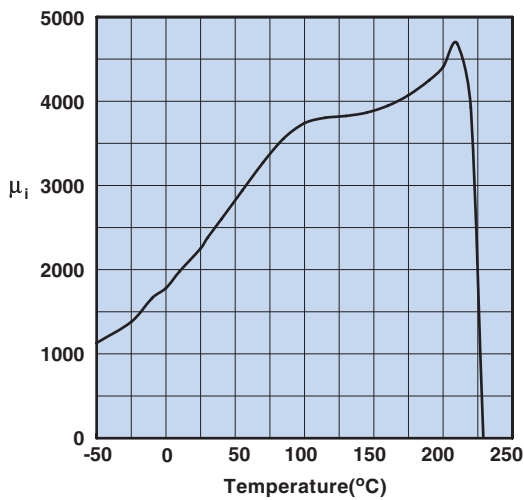

Measured on an 18/10/6mm toroid at 100kHz.

Hysteresis Loop

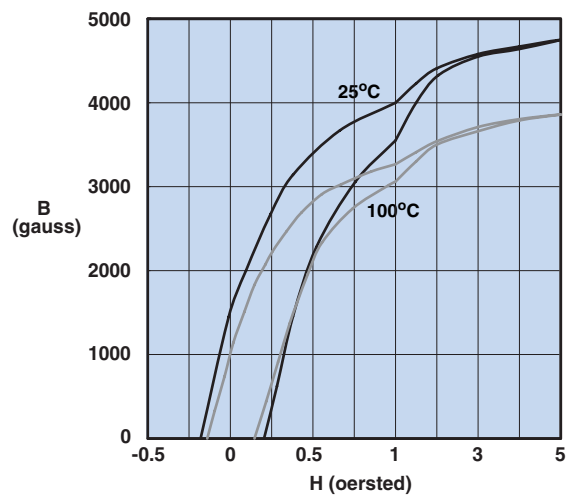

Measured on an 18/10/6mm toroid at 10kHz.

Fair-Rite Products Corp.

Phone: (888) FAIR RITE / (845) 895-2055 • FAX: (888) FERRITE / (845) 895-2629
(888) 324-7748 (888) 337 -7483

PO Box J, One Commercial Row, Wallkill, NY 12589-0288

• www.fair-rite.com
• E-Mail: ferrites@fair-rite.com

78 Material

Amplitude Permeability vs. Flux Density

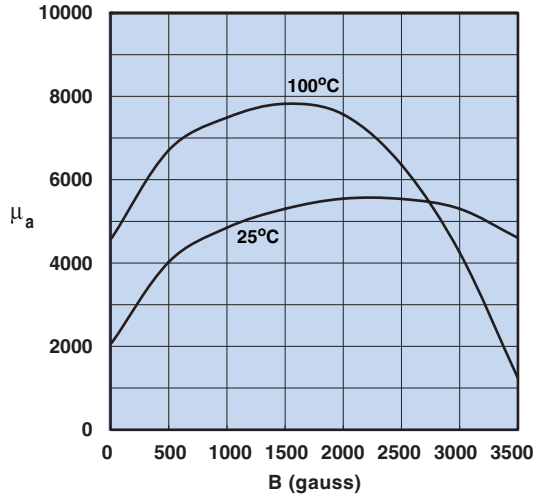

Measured on an 18/10/6mm toroid at 10kHz.

Power Loss Density vs. Flux Density

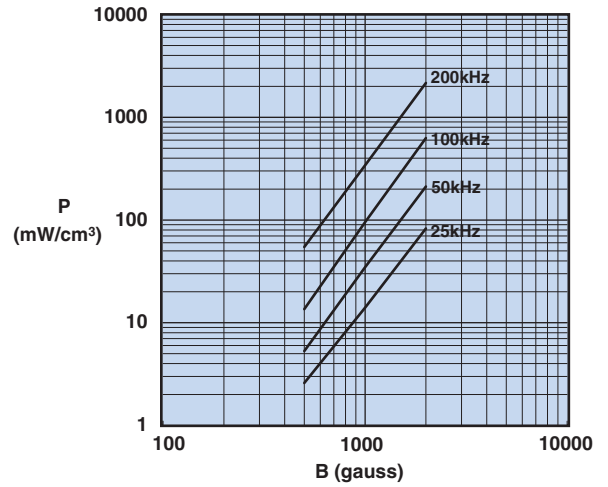

Measured on an 18/10/6mm toroid using the Clarke Hess 258 VAW at 100°C

Power Loss Density vs. Temperature

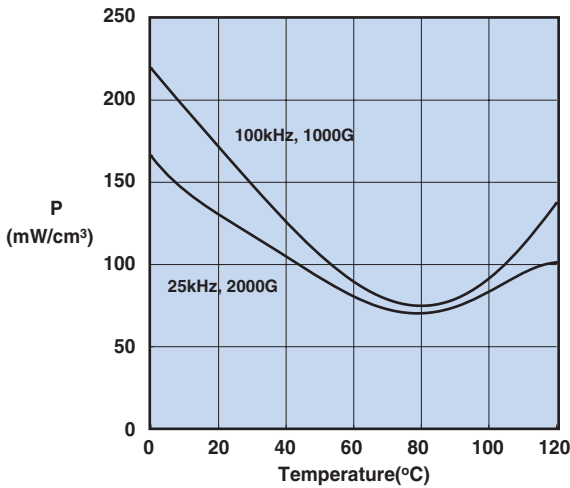

Measured on an 18/10/6mm toroid using the Clarke Hess 258 VAW.

Flux Density vs. Temperature

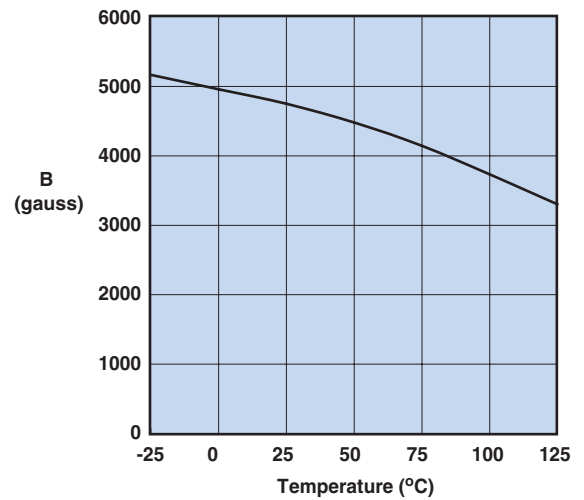

Measured on an 18/10/6 mm toroid at 10kHz and H=5 oersted.

73 Material

A MnZn ferrite, supplied only in small cores, to suppress conducted EMI frequencies below 30 MHz.

EMI suppression beads, beads on leads, SM beads, and multi-aperture cores are all available in 73 material.

73 Material Specifications:

Property	Unit	Symbol	Value
Initial Permeability @ B < 10 gauss		μ_i	2500
Flux Density @ Field Strength	gauss oersted	B H	3900 5
Residual Flux Density	gauss	B_r	1500
Coercive Force	oersted	H_c	0.24
Loss Factor @ Frequency	10^{-6} MHz	$\tan \delta / \mu_i$	10 0.1
Temperature Coefficient of Initial Permeability (20 -70°C)	%/°C		0.65
Curie Temperature	°C	T_c	>160
Resistivity	Ω cm	ρ	1×10^2

Complex Permeability vs. Frequency

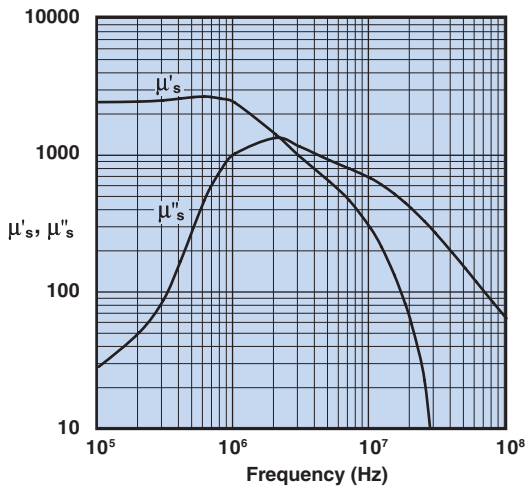

Measured on a 2673000301 bead using the HP 4284A and the HP 4291A.

Percent of Original Impedance vs. Temperature

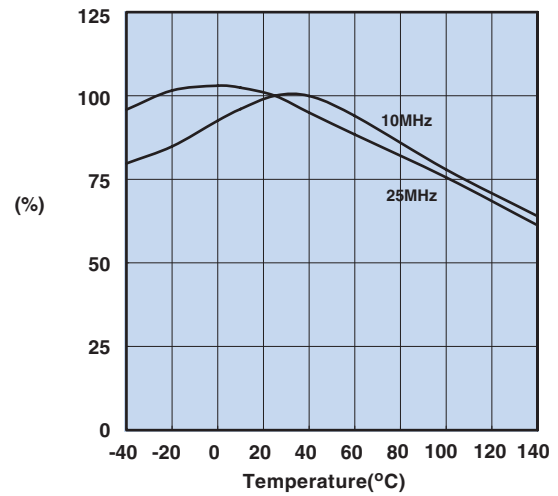

Measured on a 2673000301 using the HP4291A.

Initial Permeability vs. Temperature

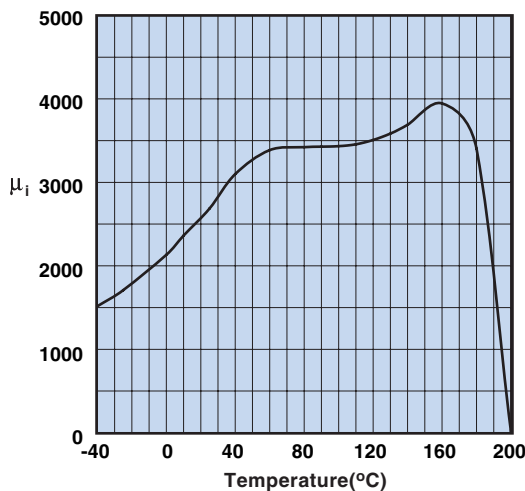

Measured on a 17/10/6mm toroid at 10kHz.

Hysteresis Loop

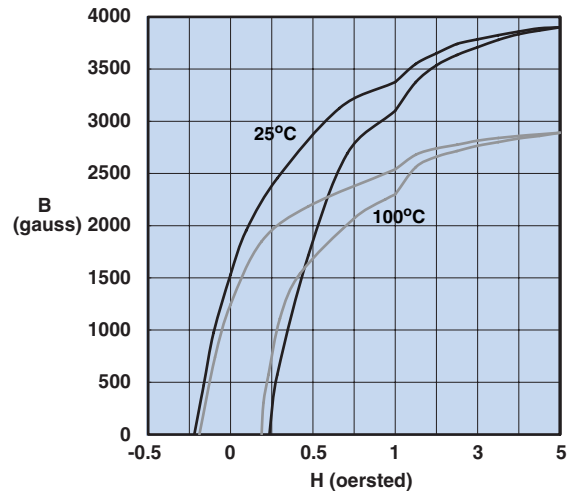

Measured on a 17/10/6mm toroid at 10kHz.

Fair-Rite Products Corp.

Phone: (888) FAIR RITE / (845) 895-2055 • FAX: (888) FERRITE / (845) 895-2629
(888) 324-7748 (888) 337 -7483

PO Box J, One Commercial Row, Wallkill, NY 12589-0288

• www.fair-rite.com
• E-Mail: ferrites@fair-rite.com

75 Material

A high permeability MnZn ferrite intended for a range of broadband and pulse transformer applications and common-mode inductor designs.

Toroids and E&I cores are available in 75 material.

75 Material Specifications:

Property	Unit	Symbol	Value
Initial Permeability @ B < 10 gauss		μ_i	5000
Flux Density @ Field Strength	gauss oersted	B H	4300 5
Residual Flux Density	gauss	B_r	1400
Coercive Force	oersted	H_c	0.16
Loss Factor @ Frequency	10^{-6} MHz	$\tan \delta / \mu_i$	15 0.1
Temperature Coefficient of Initial Permeability (20 -70°C)	%/°C		0.6
Curie Temperature	°C	T_c	>140
Resistivity	Ω cm	ρ	3×10^2

Complex Permeability vs. Frequency

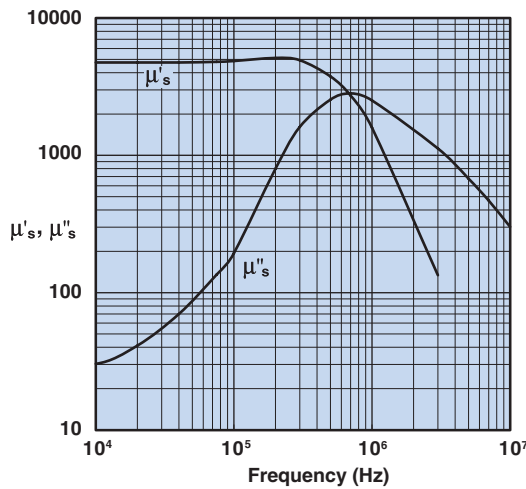

Measured on a 17/10/6mm toroid using the HP 4284A and the HP 4291A.

Power Loss Density vs. Flux Density

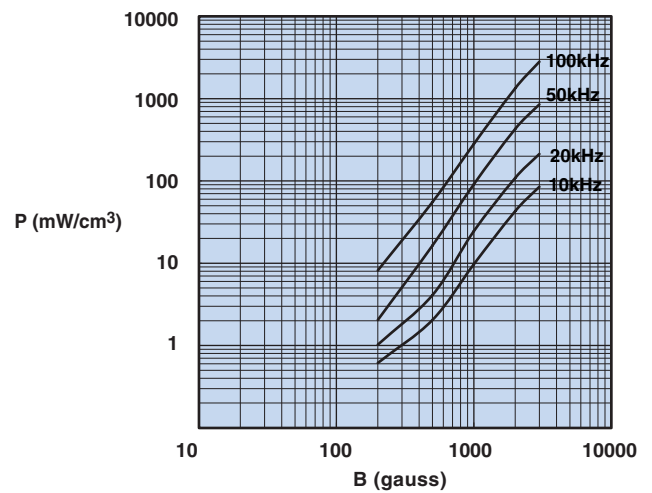

Measured on a 17/10/6mm toroid using the Clarke Hess 258 VAW at 100°C.

Initial Permeability vs. Temperature

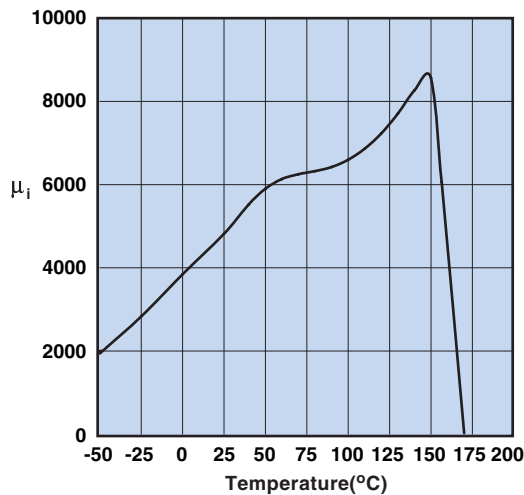

Measured on a 17/10/6mm toroid at 10kHz.

Hysteresis Loop

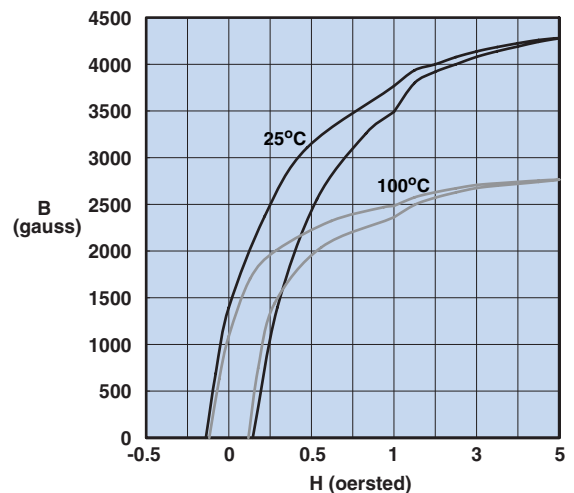

Measured on a 17/10/6mm toroid at 10kHz.

Fair-Rite Products Corp.

Phone: (888) FAIR RITE / (845) 895-2055 • FAX: (888) FERRITE / (845) 895-2629
(888) 324-7748 (888) 337-7483

PO Box J, One Commercial Row, Wallkill, NY 12589-0288

• www.fair-rite.com
• E-Mail: ferrites@fair-rite.com

76 Material

A MnZn ferrite with a 10K permeability and an acceptable Curie temperature for broadband and pulse transformer designs and common-mode choke applications.

Toroids are available in 76 material.

76 Material Specifications:

Property	Unit	Symbol	Value
Initial Permeability @ B < 10 gauss		μ_i	10000
Flux Density @ Field Strength	gauss oersted	B H	4000 5
Residual Flux Density	gauss	B_r	1800
Coercive Force	oersted	H_c	0.12
Loss Factor @ Frequency	10^{-6} MHz	$\tan \delta / \mu_i$	15 0.025
Temperature Coefficient of Initial Permeability (20 -70°C)	%/°C		0.5
Curie Temperature	°C	T_c	>120
Resistivity	Ω cm	ρ	50

Complex Permeability vs. Frequency

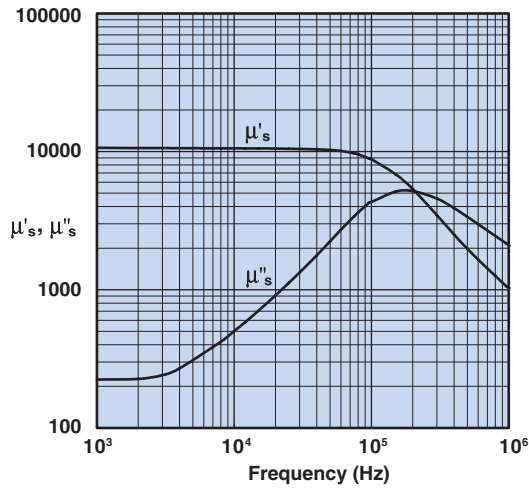

Measured on a 17/10/6mm toroid using the HP 4284A and, the HP 4291A.

Amplitude Permeability vs. Flux Density

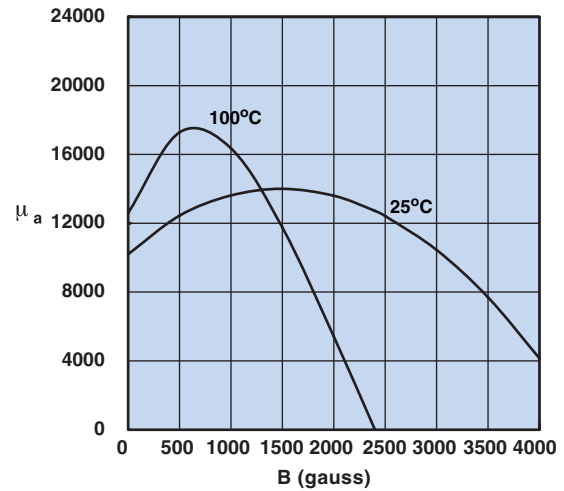

Measured on a 17/10/6mm toroid using the HP 54510A.

Initial Permeability vs. Temperature

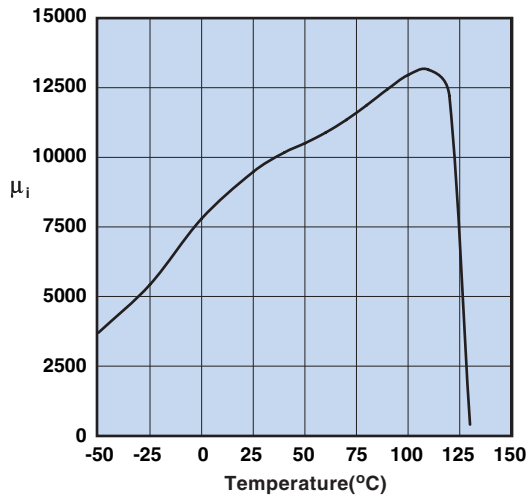

Measured on a 17/10/6mm toroid at 10kHz.

Hysteresis Loop

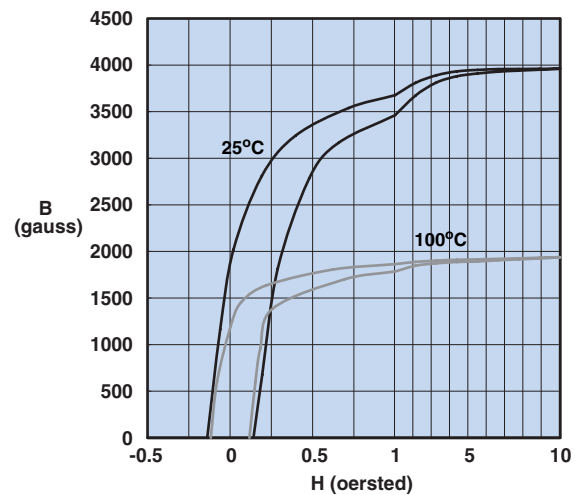

Measured on a 17/10/6mm toroid at 10kHz.

Fair-Rite Products Corp.

Phone: (888) FAIR RITE / (845) 895-2055 • FAX: (888) FERRITE / (845) 895-2629
(888) 324-7748

PO Box J, One Commercial Row, Wallkill, NY 12589-0288

• www.fair-rite.com
• E-Mail: ferrites@fair-rite.com

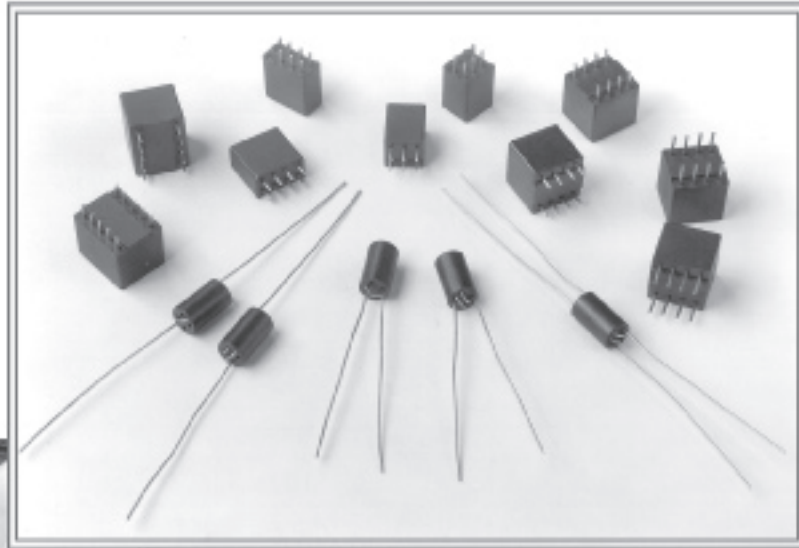

Board Components

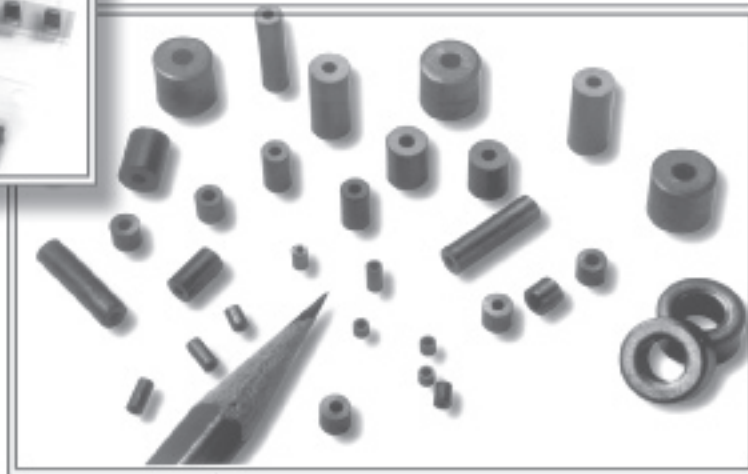

Fair-Rite Products Corp.

PO Box J, One Commercial Row, Wallkill, NY 12589-0288

Phone: (888) FAIR RITE / (845) 895-2055 • FAX: (888) 324-7748

(888) FERRITE / (845) 895-2629
(888) 337-7483

• www.fair-rite.com
• E-Mail: ferrites@fair-rite.com

Solder Profile

REFLOW SOLDER PROFILE FOR LEAD-FREE COMPONENTS

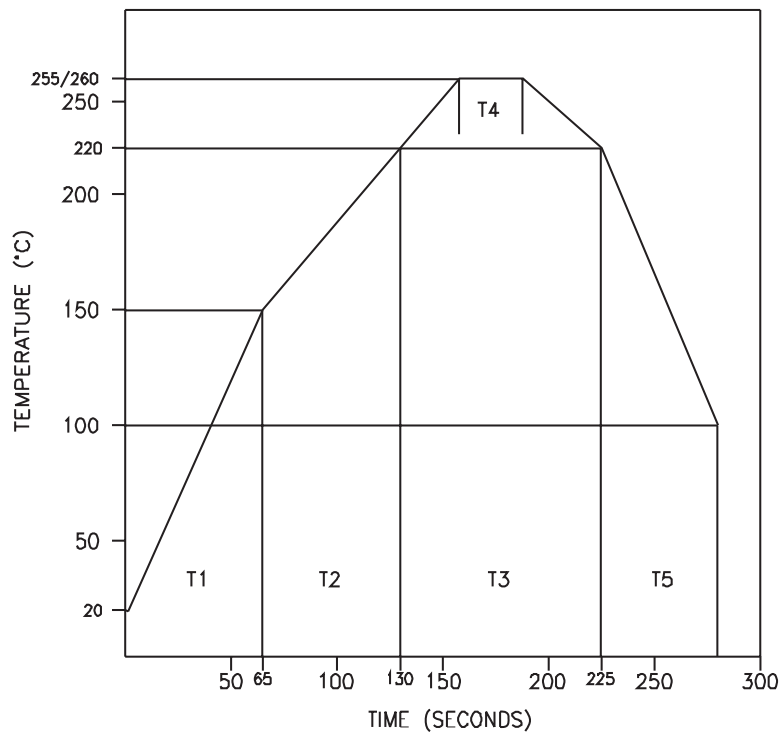

T1 - Pre Heat	50 - 80 Seconds
T2 - Soak Time	60 - 90 Seconds
T3 - Time Above 220°C	60 - 150 Seconds
T4 - Reflow Solder Time	20 - 40 Seconds
T5 - Cool Down	40 Seconds Minimum

Times might be adjusted to accommodate component size

Fair-Rite Products Corp.

PO Box J, One Commercial Row, Wallkill, NY 12589-0288

Phone: (888) FAIR RITE / (845) 895-2055 • FAX: (888) FERRITE / (845) 895-2629 • www.fair-rite.com
 (888) 324-7748 (888) 337-7483 • E-Mail: ferrites@fair-rite.com

EMI Suppression Beads

Listed by frequency range and in ascending order of "B" dimension.

Fair-Rite offers a broad selection of ferrite EMI suppression beads with guaranteed minimum impedance specifications

- Beads with a "1" as the last digit of the part number are not burnished. Parts that are burnished to break the sharp edges have a "2" as the last digit.
- Upon request beads can be supplied with a Parylene coating. The last digit of the Parylene coated part is a "4". The minimum coating thickness beads is 0.005mm (.0002"). See page 124 for material characteristics of Parylene C.
- The column "H (Oe)" gives for each bead the calculated dc bias field in oersted for 1 turn and 1 ampere direct current. The actual dc H field in the application is this value of "H" times the actual NI (ampere-turn) product. For the effect of the dc bias on the impedance of the bead material, see the material graphs on pages 145-146, Figures 18-23.
- Suppression beads are controlled for impedances only. The impedances listed are typical values. Minimum impedance values are specified for the + marked frequencies. The minimum guaranteed impedance is the listed typical impedance less 20%.
- Single turn impedance tests for 73 and 43 material beads are performed on the 4193A Vector Impedance Analyzer. The 61 material beads are tested on the 4191A RF Impedance Analyzer. **Beads are tested with the shortest practical wire length.**
- Performance curves of all listed EMI suppression beads are compiled on the Fair-Rite Products CD-ROM.
- For larger suppression cores, refer to the section "Round Cable EMI Suppression Cores" found on pages 70-74.
- For any EMI suppression bead requirement not listed here, feel free to contact our customer service group for availability and pricing.
- Our "Shield Bead Kit" (part number 0199000019) contains a selection of these beads. See page 67.
- Explanation of Part Numbers: Digits 1&2 = product class, 3&4 = material grade and last digit 1= not burnished, 2 = burnished and 4 = Parylene coated.

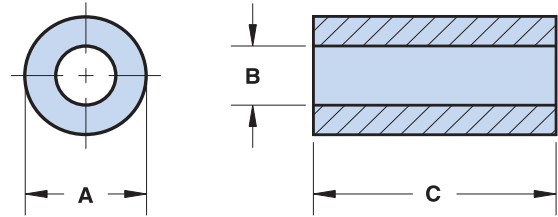

Lower Frequencies < 50 MHz (73 material)

Dimensions (Bold numbers are in millimeters, light numbers are nominal in inches.)

Part Number**	A	B	C*	Wt (g)	H (Oe)	Typical Impedance(Ω)			
						1 MHz	5 MHz	10 MHz ⁺	25 MHz ⁺
2673901301	0.95 - 0.05 .036	0.45+0.1 .020	3.8±0.2 .150	.01	6.0	5.3	13	16	24
2673004601	1.1 - 0.1 .041	0.65+0.1 .028	4.1 - 0.3 .156	.01	4.7	3.3	8.2	12.5	19
2673004701	1.45 - 0.15 .054	0.7+0.1 .029	2.3±0.15 .090	.01	4.0	3.1	7.6	12.5	17
2673030101	1.22 - 0.13 .045	0.8+0.1 .033	5.3 - 0.45 .200	.01	4.1	3.5	8.6	11	17
2673025301	1.25 - 0.1 .047	0.8+0.1 .033	3.8±0.2 .150	.01	4.0	2.9	7.1	10	15
2673010101	1.95 - 0.25 .072	0.8+0.1 .033	10.0 - 0.4 .384	.08	3.3	20.5	48.5	55	77

**Bold part numbers designate preferred parts.

⁺ Test frequency

*This dimension may be modified to suit specific applications.

Fair-Rite Products Corp.

PO Box J, One Commercial Row, Wallkill, NY 12589-0288

Phone: (888) FAIR RITE / (845) 895-2055 • FAX: (888) FERRITE / (845) 895-2629 • www.fair-rite.com
(888) 324-7748 (888) 337-7483 • E-Mail: ferrites@fair-rite.com

EMI Suppression Beads

Listed by frequency range and in ascending order of "B" dimension.

Lower Frequencies < 50 MHz (73 material)

Dimensions (Bold numbers are in millimeters, light numbers are nominal in inches.)

Part Number**	A	B	C*	Wt (g)	H (Oe)	Typical Impedance(Ω)			
						1 MHz	5 MHz	10 MHz ⁺	25 MHz ⁺
2673004801	2.1 - 0.15 .080	0.85+0.1 .034	2.9 - 0.45 .105	.03	3.1	5.5	13.5	18	28
2673028602	2.13 - 0.1 .082	0.85+0.1 .034	5.6±0.15 .220	.07	2.7	13	30.5	38	50
2673012401	1.55 - 0.1 .059	0.95+0.15 .040	4.2 - 0.25 .160	.02	3.3	3.5	8.6	11	19
2673002201	1.95 - 0.2 .072	1.05+0.1 .043	10.4±0.25 .410	.09	2.9	14	33.5	38	55
2673000501	2.0 - 0.15 .076	1.05+0.1 .043	1.65 - 0.25 .060	.01	2.8	2.1	6.3	7.5	12
2673000201	2.0 - 0.15 .076	1.05+0.1 .043	3.8±0.25 .150	.04	2.8	5.2	12.5	18	27
2673000101	3.5±0.2 .138	1.3±0.1 .051	3.25±0.25 .128	.13	2.0	8.1	19.5	25	35
2673000301	3.5±0.2 .138	1.3±0.1 .051	6.0±0.25 .236	.24	2.0	15.5	37.5	57	63
2673000701	3.5±0.2 .138	1.3±0.1 .051	12.7±0.35 .500	.51	2.0	34.5	81.5	120	125
2673022401	5.1±0.25 .200	1.45+0.25 .062	6.35±0.25 .250	.56	1.5	20	47.5	54	58
2673021801	5.1±0.25 .200	1.45+0.25 .062	11.1±0.35 .437	1.0	1.5	35.5	84	94	95
2673018001	2.85±0.1 .112	1.65+0.15 .068	6.65±0.25 .262	.13	1.8	8.3	20	29	41
2673004901	2.85±0.1 .112	1.65+0.15 .068	10.45±0.25 .410	.20	1.8	13.5	32.5	40	58
2673001601	3.55±0.15 .140	1.65+0.25 .070	3.3 - 0.4 .122	.11	1.6	5.1	12.5	16	24
2673015301	4.1 - 0.25 .156	1.8±0.15 .071	6.85±0.25 .270	.32	1.5	14	34	41	54
2673000801	7.5±0.25 .296	2.25+0.25 .094	7.55±0.25 .297	1.4	1.0	23	55.5	48	45
2673200201	5.2±0.15 .205	2.65±0.25 .105	20.6±0.75 .812	1.6	1.1	37	89	110	113
2673003201	5.6 - 0.5 .210	2.65±0.25 .105	12.7±0.5 .500	1.0	1.1	23.5	56.5	60	60
2673002402	9.65±0.25 .380	5.0±0.2 .197	5.05 - 0.45 .190	1.2	.59	7.9	19	19	15

**Bold part numbers designate preferred parts.

⁺ Test frequency

*This dimension may be modified to suit specific applications.

Fair-Rite Products Corp.

PO Box J, One Commercial Row, Wallkill, NY 12589-0288

Phone: (888) FAIR RITE / (845) 895-2055 • FAX: (888) FERRITE / (845) 895-2629
(888) 324-7748 (888) 337-7483

• www.fair-rite.com
• E-Mail: ferrites@fair-rite.com

EMI Suppression Beads

Listed by frequency range and in ascending order of "B" dimension.

Broadband Frequencies 25-300 MHz (43 material)

Dimensions (Bold numbers are in millimeters, light numbers are nominal in inches.)

Part Number**	A	B	C*	Wt (g)	H (Oe)	Typical Impedance (Ω)			
						10 MHz	25 MHz [†]	100 MHz [†]	250 MHz
2643004601	1.1 - 0.1 .041	0.65+0.1 .028	4.1 - 0.3 .156	.01	4.7	9	12.5	31	39
2643004701	1.45 - 0.15 .054	0.7+0.1 .029	2.3±0.15 .090	.01	4.0	8	12.5	26	39
2643004101	3.5±0.2 .138	0.75+0.1 .031	4.45±0.35 .175	.11	2.6	32	48	70	89
2643706001	3.5±0.25 .138	0.8+0.1 .033	2.7 - 0.45 .097	.06	2.5	18	26	45	59
2643020501	1.65±0.025 .065	0.85+0.1 .034	3.68 - 0.25 .140	.02	3.4	12	17	31	47
2643004801	2.1 - 0.15 .080	0.85+0.1 .034	2.9 - 0.45 .105	.03	3.1	12	18	31	47
2643002201	1.95 - 0.2 .072	1.05+0.1 .043	10.4±0.25 .410	.08	2.9	26	34	58	77
2643000501	2.0 - 0.15 .076	1.05+0.1 .043	1.65 - 0.25 .060	.01	2.8	6	9	22	33
2643000201	2.0 - 0.15 .076	1.05+0.1 .043	3.8±0.25 .150	.03	2.8	12	16	31	46
2643000101	3.5±0.2 .138	1.3±0.1 .051	3.25±0.25 .128	.10	2.0	17	26	40	56
2643000301	3.5±0.2 .138	1.3±0.1 .051	6.0±0.25 .236	.18	2.0	29	46	60	83
2643000701	3.5±0.2 .138	1.3±0.1 .051	12.7±0.35 .500	.38	2.0	60	89	125	148
2643200101	5.1±0.25 .200	1.45+0.25 .062	3.4 - 0.45 .125	.19	1.5	19	30	41	61
2643022401	5.1±0.25 .200	1.45+0.25 .062	6.35±0.25 .250	.38	1.5	36	55	82	97
2643021801	5.1±0.25 .200	1.45+0.25 .062	11.1±0.35 .437	.67	1.5	62	96	131	151
2643023801	5.1±0.25 .200	1.45+0.25 .062	22.85±0.75 .900	1.4	1.5	126	192	266	285
2643001501	3.5±0.2 .138	1.6±0.1 .063	3.25±0.25 .128	.10	1.7	13	21	35	50
2643025601	3.5±0.2 .138	1.6±0.1 .063	6.0±0.25 .236	.18	1.7	23	38	55	70
2643023201	2.85±0.1 .112	1.65+0.15 .068	3.75±0.25 .147	.06	1.8	10	15	30	43
2643013801	3.5±0.2 .138	1.65+0.25 .070	4.05±0.25 .160	.12	1.6	14	24	38	52
2643001601	3.55±0.15 .140	1.65+0.25 .070	3.3 - 0.4 .122	.09	1.6	11	19	30	46
2643001301	3.55±0.15 .140	1.65+0.25 .070	5.95±0.25 .234	.18	1.6	21	31	48	65
2643005701	5.1±0.25 .200	2.3±0.2 .090	12.7±0.35 .500	.81	1.2	49	78	120	123
2643000801	7.5±0.2 .296	2.25+0.25 .094	7.55±0.25 .297	1.0	1.0	42	63	92	109

**Bold part numbers designate preferred parts.

[†] Test frequency

*This dimension may be modified to suit specific applications.

Fair-Rite Products Corp.

PO Box J, One Commercial Row, Wallkill, NY 12589-0288

Phone: (888) FAIR RITE / (845) 895-2055 • FAX: (888) FERRITE / (845) 895-2629
(888) 324-7748

• www.fair-rite.com
• E-Mail: ferrites@fair-rite.com

EMI Suppression Beads

Listed by frequency range and in ascending order of "B" dimension.

Broadband Frequencies 25-300 MHz (43 material)

Dimensions (Bold numbers are in millimeters, light numbers are nominal in inches.)

Part Number**	A	B	C*	Wt (g)	H (Oe)	Typical Impedance(Ω)			
						10 MHz	25 MHz ⁺	100 MHz ⁺	250 MHz
2643300101	7.6±0.25 .300	2.25±0.25 .094	15.1±0.75 .595	2.1	1.0	83	115	200	195
2643003201	5.6-0.5 .210	2.65±0.25 .105	12.7±0.5 .500	.87	1.1	42	63	88	110
2643250402	6.35±0.15 .250	2.95±0.45 .125	12.7±0.5 .500	1.2	.91	43	69	102	111
2643250302	6.35±0.15 .250	2.95±0.45 .125	15.9±0.5 .625	1.5	.91	53	85	122	132
2643250202	6.35±0.15 .250	2.95±0.45 .125	25.4±0.75 1.000	2.5	.91	83	135	200	196
2643375102	9.5±0.25 .375	4.5±0.75 .192	6.35±0.35 .250	1.4	.60	21	35	50	66
2643375002	9.5±0.25 .375	4.5±0.75 .192	14.5±0.6 .570	3.1	.60	47	78	115	119
2643006302	9.5±0.25 .375	4.75±0.3 .193	10.4±0.25 .410	2.2	.60	34	53	80	92
2643023402	9.5±0.25 .375	4.75±0.3 .193	15.9±0.45 .625	3.4	.60	51	83	120	127
2643023002	9.5±0.25 .375	4.75±0.3 .193	19.05±0.7 .750	4.1	.60	60	100	145	148
2643002402	9.65±0.25 .380	5.0±0.2 .197	5.05 - 0.45 .190	1.1	.59	16	26	43	56
2643012702	9.65±0.25 .380	6.35±0.15 .250	7.35±0.25 .290	1.3	.51	15	24	38	55

**Bold part numbers designate preferred parts.

⁺ Test frequency

*This dimension may be modified to suit specific applications.

Fair-Rite Products Corp.

PO Box J, One Commercial Row, Wallkill, NY 12589-0288

Phone: (888) FAIR RITE / (845) 895-2055 • FAX: (888) FERRITE / (845) 895-2629
(888) 324-7748

• www.fair-rite.com
• E-Mail: ferrites@fair-rite.com

EMI Suppression Beads

Listed by frequency range and in ascending order of "B" dimension.

Higher Frequencies 250-1000 MHz (61 material)

Dimensions (Bold numbers are in millimeters, light numbers are nominal in inches.)

Part Number**	A	B	C*	Wt (g)	H (Oe)	Typical Impedance(Ω)			
						100 MHz	250MHz ⁺	500 MHz ⁺	1000 MHz
2661030101	1.22 - 0.13 .045	0.8+0.1 .033	5.3 - 0.45 .200	.01	4.1	17	32	53	93
2661002201	1.95 - 0.2 .072	1.05+0.1 .043	10.4±0.25 .410	.08	2.9	53	76	97	122
2661000101	3.5±0.2 .138	1.3±0.1 .051	3.25±0.25 .128	.10	2.0	30	45	62	95
2661000301	3.5±0.2 .138	1.3±0.1 .051	6.0±0.25 .236	.18	2.0	54	82	103	120
2661000701	3.5±0.2 .138	1.3±0.1 .051	12.7±0.35 .500	.38	2.0	120	158	178	185
2661022401	5.1±0.25 .200	1.45+0.25 .062	6.35±0.25 .250	.38	1.5	58	82	103	138
2661021801	5.1±0.25 .200	1.45+0.25 .062	11.1±0.35 .437	.67	1.5	102	141	167	185
2661023801	5.1±0.25 .200	1.45+0.25 .062	22.85±0.75 .900	1.4	1.5	210	286	325	350
2661005701	5.1±0.25 .200	2.3±0.2 .090	12.7±0.35 .500	.81	1.2	97	130	150	167
2661000801	7.5±0.25 .296	2.25+0.25 .094	7.55±0.25 .297	1.0	1.0	84	114	134	160
2661250402	6.35±0.15 .250	2.95+0.45 .125	12.7±0.5 .500	1.2	.91	75	103	120	143
2661250202	6.35±0.15 .250	2.95+0.45 .125	25.4±0.75 1.000	1.4	.91	165	230	275	330
2661375102	9.5±0.25 .375	4.5+0.75 .192	6.35±0.35 .250	2.5	.60	42	63	83	117
2661002402	9.65±0.25 .380	5.0±0.2 .197	5.05 - 0.45 .190	1.1	.59	35	54	75	112

**Bold part numbers designate preferred parts.

⁺ Test frequency

*This dimension may be modified to suit specific applications.

Fair-Rite Products Corp.

PO Box J, One Commercial Row, Wallkill, NY 12589-0288

Phone: (888) FAIR RITE / (845) 895-2055 • FAX: (888) FERRITE / (845) 895-2629 • www.fair-rite.com
(888) 324-7748 (888) 337-7483 • E-Mail: ferrites@fair-rite.com

Beads-on-Leads

Listed by frequency range and in ascending order of Impedance.

Ferrite suppression beads are supplied assembled on tinned copper wire for automated circuit board assembly.

- Parts with a "2" as the last digit of the part number are supplied taped and reeled per IEC 60286-1 and EIA RS-296-F standards. Taped and reeled parts are supplied 4500 pieces on a 14" reel. Taping details: Component pitch 5mm. Inside tape spacing 52.5mm. Tape width 6mm.

- Beads-on-leads can be supplied bulk packed. The last digit of bulk packed parts is a "1"

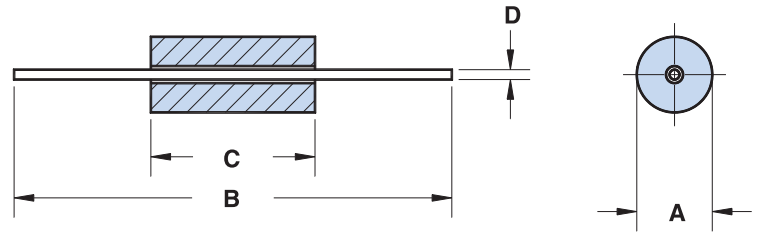

- Wires are oxygen free high conductivity copper with a lead-free tin coating. The resistance of the wire is 3.5 mOhm for the 22 AWG and 2.2 mOhm for the 20 AWG wire. If required beads-on-leads can be supplied with a tin/lead coating.
- Beads-on-leads are controlled for impedances only. The impedances listed are typical values. Minimum impedance values are specified for the + marked frequencies. The minimum guaranteed impedance is the listed impedance less 20%. The impedances of the 73 & 43 beads-on-leads are measured on the 4193A Vector Impedance Analyzer. The 61 beads-on-leads are tested for impedance on the 4191A RF Impedance Analyzer.
- Performance curves for all beads-on-leads can be found on the Fair-Rite Products CD-ROM.
- For any bead-on-lead requirement not listed, please contact our customer service group for availability and pricing.
- Our "Bead-on-Lead Suppression Kit" (part number 0199000028) is available for prototype evaluation. See page 67.
- Explanation of Part Numbers: Digits 1&2 = product class, 3&4 = material grade and last digit 1 = bulk packed, 2 = taped and reeled.

Lower Frequencies < 50 MHz (73 material)

Dimensions (Bold numbers are in millimeters, light numbers are nominal in inches.)

Part Number*	A	B	C	D	Wt (g)	Typical Impedance (Ω)			
						1 MHz	5 MHz	10 MHz ⁺	25 MHz ⁺
277300112	3.5±0.25 .138	62.0±1.5 2.440	4.45±0.25 .175	0.65 22 AWG	.4	12	34	48	61
2773015112	3.5±0.25 .138	62.0±1.5 2.440	5.25±0.25 .206	0.65 22 AWG	.4	17	43	55	68
2773005112	3.5±0.25 .138	62.0±1.5 2.440	6.0±0.25 .236	0.65 22 AWG	.4	22	51	63	78
2773003112	3.5±0.25 .138	62.0±1.5 2.440	6.7±0.25 .263	0.65 22 AWG	.5	26	59	70	86
2773004112	3.5±0.25 .138	62.0±1.5 2.440	7.6±0.3 .300	0.65 22 AWG	.5	30	69	80	100
2773002112	3.5±0.25 .138	62.0±1.5 2.440	8.9±0.3 .350	0.65 22 AWG	.6	36	84	94	115
2773007112	3.5±0.25 .138	62.0±1.5 2.440	9.5±0.3 .374	0.65 22 AWG	.6	38	90	110	115
2773008112	3.5±0.25 .138	62.0±1.5 2.440	11.4±0.4 .450	0.65 22 AWG	.7	43	112	125	145
2773009112	3.5±0.25 .138	62.0±1.5 2.440	13.8±0.5 .545	0.65 22 AWG	.7	46	138	151	170

*Bold part numbers designate preferred parts.

⁺ Test frequency

Fair-Rite Products Corp.

PO Box J, One Commercial Row, Wallkill, NY 12589-0288

Phone: (888) FAIR RITE / (845) 895-2055 • FAX: (888) FERRITE / (845) 895-2629
(888) 324-7748 (888) 337-7483

• www.fair-rite.com
• E-Mail: ferrites@fair-rite.com

Beads-on-Leads

Listed by frequency range and in ascending order of Impedance.

Broadband Frequencies 25-300 MHz (43 material)

Dimensions (Bold numbers are in millimeters, light numbers are nominal in inches.)

Part Number*	A	B	C	D	Wt (g)	Typical Impedance(Ω)			
						10 MHz	25 MHz ⁺	100 MHz ⁺	250 MHz
2743001112	3.5±0.25 .138	62.0±1.5 2.440	4.45±0.25 .175	0.65 22 AWG	.4	31	49	68	65
2743015112	3.5±0.25 .138	62.0±1.5 2.440	5.25±0.25 .206	0.65 22 AWG	.4	36	54	82	78
2743005112	3.5±0.25 .138	62.0±1.5 2.440	6.0±0.25 .236	0.65 22 AWG	.4	40	60	91	90
2743003112	3.5±0.25 .138	62.0±1.5 2.440	6.7±0.25 .263	0.65 22 AWG	.5	44	65	100	101
2743004112	3.5±0.25 .138	62.0±1.5 2.440	7.6±0.3 .300	0.65 22 AWG	.5	50	75	110	115
2743002112	3.5±0.25 .138	62.0±1.5 2.440	8.9±0.3 .350	0.65 22 AWG	.6	57	88	133	134
2743007112	3.5±0.25 .138	62.0±1.5 2.440	9.5±0.3 .374	0.65 22 AWG	.6	61	96	150	143
2743008112	3.5±0.25 .138	62.0±1.5 2.440	11.4±0.4 .450	0.65 22 AWG	.7	72	116	180	168
2743009112	3.5±0.25 .138	62.0±1.5 2.440	13.8±0.5 .545	0.65 22 AWG	.7	86	143	220	196
2743012201	9.8±0.3 .385	62.0±1.5 2.440	11.4±0.4 .449	0.8 20 AWG	4.5	121	193	271	253
2743013211	9.8±0.3 .385	62.0±1.5 2.440	14.0±0.5 .550	0.8 20 AWG	5.5	147	235	331	281
2743014221	9.8±0.3 .385	62.0±1.5 2.440	16.5±0.5 .650	0.8 20 AWG	6.5	173	280	391	296

Higher Frequencies 250-1000 MHz (61 material)

Part Number*	A	B	C	D	Wt (g)	Typical Impedance(Ω)			
						100 MHz	250 MHz ⁺	500 MHz ⁺	1000 MHz
2761001112	3.5±0.25 .138	62.0±1.5 2.440	4.45±0.25 .175	0.65 22 AWG	.4	52	72	83	90
2761015112	3.5±0.25 .138	62.0±1.5 2.440	5.25±0.25 .206	0.65 22 AWG	.4	62	85	97	105
2761005112	3.5±0.25 .138	62.0±1.5 2.440	6.0±0.25 .236	0.65 22 AWG	.4	70	96	110	118
2761003112	3.5±0.25 .138	62.0±1.5 2.440	6.7±0.25 .263	0.65 22 AWG	.5	79	107	122	131
2761004112	3.5±0.25 .138	62.0±1.5 2.440	7.6±0.3 .300	0.65 22 AWG	.5	89	121	138	148
2761002112	3.5±0.25 .138	62.0±1.5 2.440	8.9±0.3 .350	0.65 22 AWG	.6	105	142	161	171
2761007112	3.5±0.25 .138	62.0±1.5 2.440	9.5±0.3 .374	0.65 22 AWG	.6	112	151	171	182
2761008112	3.5±0.25 .138	62.0±1.5 2.440	11.4±0.4 .450	0.65 22 AWG	.7	134	181	204	217
2761009112	3.5±0.25 .138	62.0±1.5 2.440	13.8±0.5 .545	0.65 22 AWG	.7	162	218	246	261

*Bold part numbers designate preferred parts.

⁺ Test frequency

Fair-Rite Products Corp.

PO Box J, One Commercial Row, Wallkill, NY 12589-0288

Phone: (888) FAIR RITE / (845) 895-2055 • FAX: (888) FERRITE / (845) 895-2629 • www.fair-rite.com
(888) 324-7748 (888) 337-7483 • E-Mail: ferrites@fair-rite.com

PC Beads (Through Hole)

Multiple single turn or multi-turn printed circuit EMI suppression beads are available in two Fair-Rite materials. The broadband 44 material and in the high frequency 52 material grade. PC Beads are made in two standard component heights.

- Parts with a "1" as the last digit of the part number are supplied with a minimum wire length "F" dimension of 2.4 mm (.095"). A longer minimum wire length of 3.1 mm (.125") is also available, these parts have a "2" as the last digit.
- Wires are oxygen free high conductivity copper with a lead-free tin coating. If required PC Beads can be supplied with a tin/lead coating. Wires on top of the beads are covered with a layer of epoxy.
- PC Beads are controlled for impedance only. The impedances listed are typical values. Minimum impedance values are specified for the + marked frequencies.
The minimum guaranteed impedance is the listed impedance less 20%.
The PC Beads in 44 material are measured on the 4193A Vector Impedance Analyzer. The 52 PC Beads are tested for impedance on the 4191A RF Impedance Analyzer.
- Recommended operating and storage temperature for the PC Beads is -55 °C to +125 °C.
- Performance curves for all PC beads are on the Fair-Rite Products CD-ROM.
- For equivalent PC Beads suitable for surface mounting see pages 38 and 41.
- Explanation of Part Numbers: Digits 1&2 = product class, 3&4 = material grade and last digit 1 = standard wire length 2.4 mm (.095") minimum, 2 longer wire length 3.1 mm (.125") minimum.

Broadband Frequencies 10-300 MHz (44 material)

Dimensions (Bold numbers are in millimeters, light numbers are nominal in inches.)

Part Number	Fig.	A	B	C Max.	D	E	F Min.	G	Wt (g)	Typical Impedance (Ω)			
										10 MHz	25 MHz ⁺	100 MHz ⁺	250 MHz
2944776101	1	8.0 - 0.35 .308	7.6 - 0.5 .290	11.8 .464	2.54±0.1 .100	2.54±0.1 .100	2.4 .095	0.65 22 AWG	2.6	115	188	288	305
2944786101	1	8.0 - 0.35 .308	7.6 - 0.5 .290	6.8 .267	2.54±0.1 .100	2.54±0.1 .100	2.4 .095	0.65 22 AWG	1.3	66	95	150	155
2944778101	2	11.2 - 0.5 .430	5.75 - 0.5 .216	11.8 .464	2.54±0.1 .100	2.54±0.1 .100	2.4 .095	0.65 22 AWG	2.7	115	188	288	305
2944788101	2	11.2 - 0.5 .430	5.75 - 0.5 .216	6.8 .267	2.54±0.1 .100	2.54±0.1 .100	2.4 .095	0.65 22 AWG	1.4	66	95	150	155
2944778301	3	11.2 - 0.5 .430	11.2 - 0.5 .430	11.8 .464	2.54±0.1 .100	7.6±0.2 .300	2.4 .095	0.65 22 AWG	6.0	142	219	338	335
2944788301	3	11.2 - 0.5 .430	11.2 - 0.5 .430	6.8 .267	2.54±0.1 .100	7.6±0.2 .300	2.4 .095	0.65 22 AWG	3.0	76	110	175	180
2944770301	4	13.45±0.25 .530	11.2 - 0.5 .430	11.8 .464	2.54±0.1 .100	7.6±0.2 .300	2.4 .095	0.65 22 AWG	7.4	142	219	338	335
2944780301	4	13.45±0.25 .530	11.2 - 0.5 .430	6.8 .267	2.54±0.1 .100	7.6±0.2 .300	2.4 .095	0.65 22 AWG	3.7	76	110	175	180

⁺ Test frequency

Fair-Rite Products Corp.

PO Box J, One Commercial Row, Wallkill, NY 12589-0288

Phone: (888) FAIR RITE / (845) 895-2055 • FAX: (888) FERRITE / (845) 895-2629
(888) 324-7748 (888) 337-7483

• www.fair-rite.com
• E-Mail: ferrites@fair-rite.com

PC Beads (Through Hole)

Higher Frequencies 250-1000 MHz (52 material)

Dimensions (Bold numbers are in millimeters, light numbers are nominal in inches.)

Part Number	Fig.	A	B	C Max.	D	E	F Min.	G	Wt (g)	Typical Impedance (Ω)			
										100 MHz	250 MHz ⁺	500 MHz ⁺	1000 MHz
2952776101	1	8.0 - 0.35 .308	7.6 - 0.5 .290	11.8 .464	2.54±0.1 .100	2.54±0.1 .100	2.4 .095	0.65 22 AWG	2.6	270	380	345	250
2952786101	1	8.0 - 0.35 .308	7.6 - 0.5 .290	6.8 .267	2.54±0.1 .100	2.54±0.1 .100	2.4 .095	0.65 22 AWG	1.3	125	180	180	170
2952778101	2	11.2 - 0.5 .430	5.75 - 0.5 .216	11.8 .464	2.54±0.1 .100	2.54±0.1 .100	2.4 .095	0.65 22 AWG	2.7	270	380	345	250
2952788101	2	11.2 - 0.5 .430	5.75 - 0.5 .216	6.8 .267	2.54±0.1 .100	2.54±0.1 .100	2.4 .095	0.65 22 AWG	1.4	125	180	180	170
2952778301	3	11.2 - 0.5 .430	11.2 - 0.5 .430	11.8 .464	2.54±0.1 .100	7.6±0.2 .300	2.4 .095	0.65 22 AWG	6.0	320	460	395	300
2952788301	3	11.2 - 0.5 .430	11.2 - 0.5 .430	6.8 .267	2.54±0.1 .100	7.6±0.2 .300	2.4 .095	0.65 22 AWG	3.0	150	220	220	210
2952770301	4	13.45±0.25 .530	11.2 - 0.5 .430	11.8 .464	2.54±0.1 .100	7.6±0.2 .300	2.4 .095	0.65 22 AWG	7.4	320	460	395	300
2952780301	4	13.45±0.25 .530	11.2 - 0.5 .430	6.8 .267	2.54±0.1 .100	7.6±0.2 .300	2.4 .095	0.65 22 AWG	3.7	150	220	220	210

⁺ Test frequency

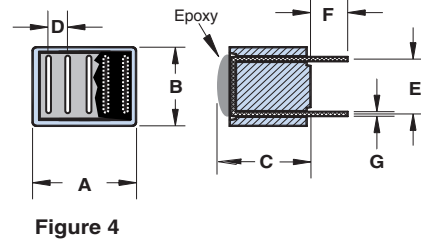
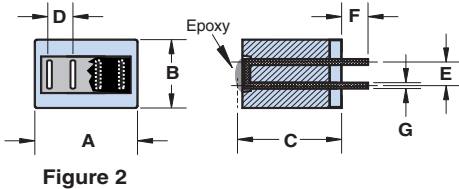
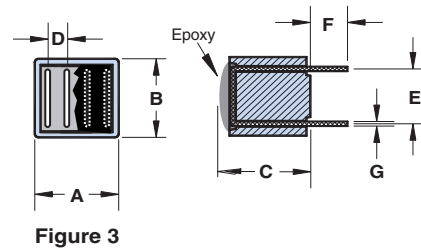
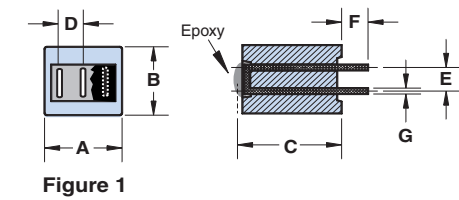

Typical Multi Turn Printed Circuit Board Layouts

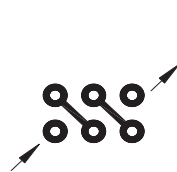

Figure 1A:
3 Turn winding
for parts in Fig. 1

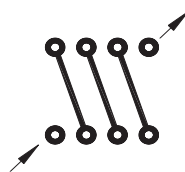

Figure 3A:
4 Turn turn winding
for parts in Fig. 3.

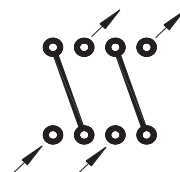

Figure 3B:
2 x 2 Turn winding
for parts in Fig. 3.

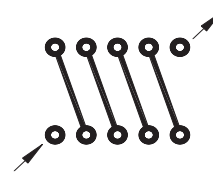

Figure 4A:
5 Turn winding
for parts in Fig. 4.

PC Beads (Surface Mount)

Surface mount PC Beads are supplied in two suppression materials. SMPC Beads are available for 3, 4 and 5 line designs in the high resistivity 44 material for broadband applications and for the higher frequencies in the new 52 material grade.

Surface mount PC Beads are supplied taped and reeled on 13" reels per EIA 481 and IEC 60286 standards. These beads can also be supplied not taped and reeled and then are bulk packed. This packing method will change the last digit of the part number to a "6".

- The flat wire conductors are oxygen free high conductivity copper, 0.30 x 0.65 mm (.012 x .025"), and a lead-free tin coating. If required SMPC Beads can be supplied with same size copper conductors but with a tin/lead coating. See page 28 for suggested solder profile for lead-free components
- The SMPC Beads can withstand a minimum breakdown voltage of 750 Vdc between wires. Leads co-planarity is < 0.10 mm (.004").
- SMPC Beads are controlled for impedance only. The impedances listed are typical values. Minimum impedance values are specified for the + marked frequencies.
The minimum guaranteed impedance is the listed impedance less 20%.
The 44 material beads are measured on the 4193A vector Impedance Analyzer. The 52 beads are tested for impedance on the 4191A RF Impedance Analyzer.
- SMPC Beads meet the solderability specifications when tested in accordance with MIL-STD-202, method 208.
- After preheating the SMPC Beads to within 100 °C of the soldering temperature, the beads will meet the resistance to soldering requirements of EIA-186-10E, temperature 260 +/- 5 °C and time of 10 +/- 1 seconds.
- Recommended storage and operating temperature range is -55 °C to 125 °C.
- Suggested land patterns are in accordance with the latest revision of IPC-7351.
- The maximum current rating for the SMPC Beads is 5 amps. The flat wire cross-sectional area is 5% less than the 24 AWG wire size.
- For equivalent PC Beads for through hole designs see pages 36 and 37.
- Performance curves of all SMPC Beads are compiled on the Fair-rite Products CD-ROM.
- Explanation of Part Numbers: Digits 1&2 = product class, 3&4 = material grade, last digit 6 = bulk packed, 7 = taped and reeled.

Fair-Rite Products Corp.

Phone: (888) FAIR RITE / (845) 895-2055 • FAX: (888) FERRITE / (845) 895-2629
(888) 324-7748 (888) 337 -7483

PO Box J, One Commercial Row, Wallkill, NY 12589-0288

• www.fair-rite.com
• E-Mail: ferrites@fair-rite.com

PC Beads (Surface Mount)

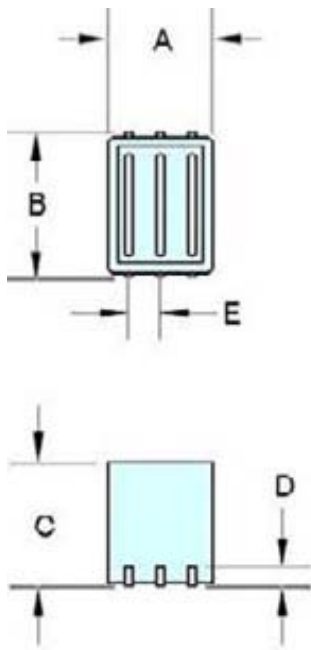

Figure 1

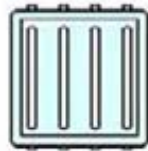

Figure 2

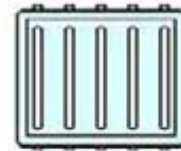
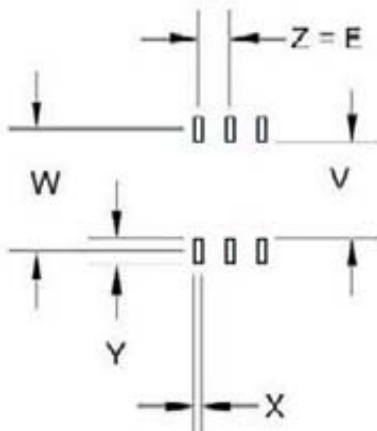

Figure 3



Land Pattern

Fair-Rite Products Corp.

PO Box J, One Commercial Row, Wallkill, NY 12589-0288

Phone: (888) FAIR RITE / (845) 895-2055 • FAX: (888) FERRITE / (845) 895-2629 • www.fair-rite.com
 (888) 324-7748 (888) 337-7483 • E-Mail: ferrites@fair-rite.com

PC Beads (Surface Mount)

Broadband Frequencies 10-300 MHz (44 material)

Dimensions (Bold numbers are in millimeters, light numbers are nominal in inches.)

Part Number	Fig.	A	B max	C max	D	E	Wt (g)	Tape Width mm	Pitch mm	Parts/Reel
2744776147	1	8.0 - 0.35 .308	8.6 .338	11.8 .464	2.6±0.6 .102	2.54±0.1 .100	2.6	24	16	300
2744786147	1	8.0 - 0.35 .308	8.6 .338	7.0 .275	2.6±0.6 .102	2.54±0.1 .100	1.5	24	16	600
2744778147	2	11.2 - 0.5 .430	6.75 .265	11.8 .464	2.6±0.6 .102	2.54±0.1 .100	2.7	16	20	250
2744788147	2	11.2 - 0.5 .430	6.75 .265	7.0 .275	2.6±0.6 .102	2.54±0.1 .100	1.6	16	20	500
2744778347	2	11.2 - 0.5 .430	12.2 .480	11.8 .464	2.6±0.6 .102	2.54±0.1 .100	7.0	24	20	250
2744788347	2	11.2 - 0.5 .430	12.2 .480	7.0 .275	2.6±0.6 .102	2.54±0.1 .100	3.5	24	20	500
2744770347	3	13.45±0.25 .530	12.2 .480	11.8 .464	2.6±0.6 .102	2.54±0.1 .100	7.4	24	24	200
2744780347	3	13.45±0.25 .530	12.2 .480	7.0 .275	2.6±0.6 .102	2.54±0.1 .100	4.4	24	24	450

Higher Frequencies 250-1000 MHz (52 material)

Part Number	Fig.	A	B max	C max	D	E	Wt (g)	Tape Width mm	Pitch mm	Parts/Reel
2752776147	1	8.0 - 0.35 .308	8.6 .338	11.8 .464	2.6±0.6 .102	2.54±0.1 .100	2.6	24	16	300
2752786147	1	8.0 - 0.35 .308	8.6 .338	7.0 .275	2.6±0.6 .102	2.54±0.1 .100	1.5	24	16	600
2752778147	2	11.2 - 0.5 .430	6.75 .265	11.8 .464	2.6±0.6 .102	2.54±0.1 .100	2.7	16	20	250
2752788147	2	11.2 - 0.5 .430	6.75 .265	7.0 .275	2.6±0.6 .102	2.54±0.1 .100	1.6	16	20	500
2752778347	2	11.2 - 0.5 .430	12.2 .480	11.8 .464	2.6±0.6 .102	2.54±0.1 .100	7.0	24	20	250
2752788347	2	11.2 - 0.5 .430	12.2 .480	7.0 .275	2.6±0.6 .102	2.54±0.1 .100	3.5	24	20	500
2752770347	3	13.45±0.25 .530	12.2 .480	11.8 .464	2.6±0.6 .102	2.54±0.1 .100	7.4	24	24	200
2752780347	3	13.45±0.25 .530	12.2 .480	7.0 .275	2.6±0.6 .102	2.54±0.1 .100	4.4	24	24	450

Fair-Rite Products Corp.

PO Box J, One Commercial Row, Wallkill, NY 12589-0288

Phone: (888) FAIR RITE / (845) 895-2055 • FAX: (888) FERRITE / (845) 895-2629 • www.fair-rite.com
(888) 324-7748 (888) 337 -7483 • E-Mail: ferrites@fair-rite.com

PC Beads (Surface Mount)

Broadband Frequencies 10-300 MHz (44 material)

Part Number	Typical Impedance(Ω)				Max Rdc(m Ω)	Land Pattern Dimensions				
	10 MHz	25 MHz ⁺	100 MHz ⁺	250 MHz		V	W (ref.)	X	Y	Z
2744776147	115	188	288	305	3.0	2.0 .079	6.0 .236	1.0 .039	4.0 .158	2.54 .100
2744786147	66	95	150	155	1.9	2.0 .079	6.0 .236	1.0 .039	4.0 .158	2.54 .100
2744778147	115	188	288	305	3.0	2.0 .079	5.0 .197	1.0 .039	3.0 .118	2.54 .100
2744788147	66	95	150	155	1.9	2.0 .079	5.0 .197	1.0 .039	3.0 .118	2.54 .100
2744778347	142	219	338	335	3.5	5.0 .197	9.5 .374	1.0 .039	4.5 .177	2.54 .100
2744788347	76	110	175	180	2.4	5.0 .197	9.5 .374	1.0 .039	4.5 .177	2.54 .100
2744770347	142	219	338	335	3.5	5.0 .197	9.5 .374	1.0 .039	4.5 .177	2.54 .100
2744780347	76	110	175	180	2.4	5.0 .197	9.5 .374	1.0 .039	4.5 .177	2.54 .100

Higher Frequencies 250-1000 MHz (52 material)

Part Number	Typical Impedance(Ω)				Max Rdc(m Ω)	Land Pattern Dimensions				
	100 MHz	250 MHz ⁺	500 MHz ⁺	1000 MHz		V	W (ref.)	X	Y	Z
2752776147	270	380	345	250	3.0	2.0 .079	6.0 .236	1.0 .039	4.0 .158	2.54 .100
2752786147	125	180	180	170	1.9	2.0 .079	6.0 .236	1.0 .039	4.0 .158	2.54 .100
2752778147	270	380	345	250	3.0	2.0 .079	5.0 .197	1.0 .039	3.0 .118	2.54 .100
2752788147	125	180	180	175	1.9	2.0 .079	5.0 .197	1.0 .039	3.0 .118	2.54 .100
2752778347	320	460	395	300	3.5	5.0 .197	9.5 .374	1.0 .039	4.5 .177	2.54 .100
2752788347	150	220	220	210	2.4	5.0 .197	9.5 .374	1.0 .039	4.5 .177	2.54 .100
2752770347	320	460	395	300	3.5	5.0 .197	9.5 .374	1.0 .039	4.5 .177	2.54 .100
2752780347	150	220	220	210	2.4	5.0 .197	9.5 .374	1.0 .039	4.5 .177	2.54 .100

⁺ Test frequency

Fair-Rite Products Corp.

PO Box J, One Commercial Row, Wallkill, NY 12589-0288

Phone: (888) FAIR RITE / (845) 895-2055 • FAX: (888) FERRITE / (845) 895-2629 • www.fair-rite.com
(888) 324-7748 (888) 337-7483 • E-Mail: ferrites@fair-rite.com

Wound Beads

Six and eleven hole beads, in two NiZn materials, are available both as beads (product class 26) and wound with tinned copper wire in several winding configurations (product class 29).

- Parts with a "1" as the last digit of the part number are supplied bulk packed. Wound beads with part numbers 29--666631 and 29--666651 can be supplied radially taped and reeled per IEC 60286-1 and EIA 468-B standards. For these taped and reeled wound beads the last digit of the part number is a "4". Taped and reeled wound beads are supplied 500 pieces on a 13" reel.
- Wire used for winding is oxygen free high conductivity copper with a lead-free tin plating. If required the wound beads can be supplied with a tin/lead coating.
- Beads are controlled for impedance limits only. The impedances listed are typical values. Minimum impedance values are specified for the + marked frequencies. The minimum guaranteed impedance is the listed impedance less 20%. The 44 material beads and wound beads are tested on the 4193A Vector Impedance Meter. The 61 material parts on the 4191A RF Impedance Analyzer.
- Recommended storage temperature and operating temperature is -55°C to 125°C
- Performance curves for all wound beads can be found on the Fair-Rite Products CD-ROM.
- For any wound bead requirement not listed in here, please contact our customer service group for availability and pricing.
- Explanation of Part Numbers: Digits 1&2 = product class, 3&4 = material grade and last digit 1 = bulk packed, 4 = taped and reeled.

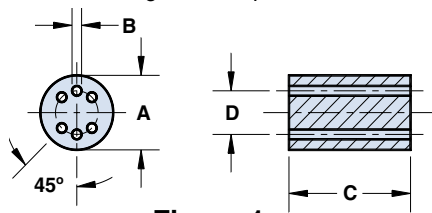

Figure 1

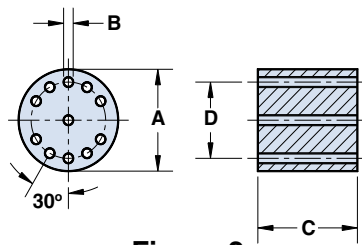

Figure 2

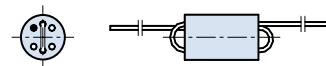

Figure 1-1



Figure 1-2

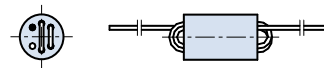

Figure 1-3

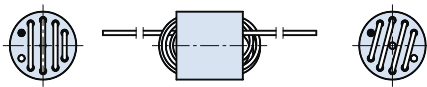

Figure 2-1

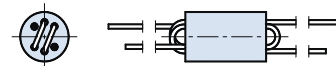

Figure 1-4

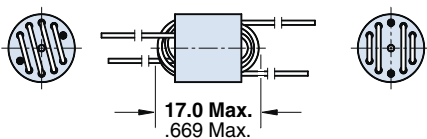

Figure 2-2

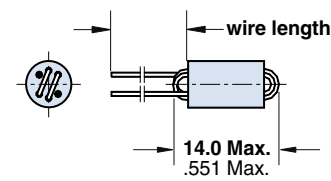

Figure 1-5

Fair-Rite Products Corp.

PO Box J, One Commercial Row, Wallkill, NY 12589-0288

Phone: (888) FAIR RITE / (845) 895-2055 • FAX: (888) FERRITE / (845) 895-2629
(888) 324-7748 (888) 337-7483

• www.fair-rite.com
• E-Mail: ferrites@fair-rite.com

Wound Beads

Dimensions (Bold numbers are in millimeters, light numbers are nominal in inches.)

Part Number	Fig.	A	B	C	D _{Ref}	Wt (g)	Typical Impedance (Ω)			
							10 MHz ⁺	50 MHz ⁺	100 MHz ⁺	200 MHz ⁺
2644666611 ^①	1	6.0±0.25 .236	0.75+0.15 .032	10.0±0.25 .394	3.5 .138	1.2	213	400	470	380
2661666611 ^①	1	6.0±0.25 .236	0.75+0.15 .032	10.0±0.25 .394	3.5 .138	1.2	–	280	380	510
2644777711 ^②	2	10.0±0.25 .394	0.9+0.15 .038	10.0±0.25 .394	7.5 .295	3.3	375	905	500	400

① Tested with 1½ turns. ② Tested with 2½ turns. (A ½ turn is defined as a single pass through a hole.)

Broadband Frequencies 1-200 MHz (44 material)

Part Number	Fig.	Turns	Wire Size	Wire Length	Wt (g)	Typical Impedance (Ω)				
						1 MHz	10 MHz ⁺	50 MHz ⁺	100 MHz ⁺	200 MHz
2944666661	1-1	1½	0.53 24 AWG	38.0±3.0 1.500	1.3	45	213	400	470	380
2944666651	1-2	2	0.53 24 AWG	38.0±3.0 1.500	1.3	58	300	650	600	415
2944666671	1-3	2½	0.53 24 AWG	38.0±3.0 1.500	1.4	87	400	850	725	410
2944666681	1-4	2 x 1½	0.53 24 AWG	③	1.4	45	213	400	470	380
2944666631	1-5	3	0.53 24 AWG	38.0±3.0 1.500	1.4	115	500	1000	690	400
2944777741	2-1	4½	0.65 22 AWG	38.0±3.0 1.500	3.8	150	815	1250	500	375
2944777721	2-2	2 x 2½	0.65 22 AWG	③	3.9	45	375	905	500	400

Higher Frequencies 50-500 MHz (61 material)

Part Number	Fig.	Turns	Wire Size	Wire Length	Wt (g)	Typical Impedance (Ω)				
						10 MHz	50 MHz ⁺	100 MHz ⁺	200 MHz ⁺	400 MHz
2961666661	1-1	1½	0.53 24 AWG	38.0±3.0 1.500	1.3	75	280	380	510	600
2961666651	1-2	2	0.53 24 AWG	38.0±3.0 1.500	1.3	100	400	560	760	700
2961666671	1-3	2½	0.53 24 AWG	38.0±3.0 1.500	1.4	150	560	780	960	600
2961666681	1-4	2 x 1½	0.53 24 AWG	③	1.4	75	280	380	510	600
2961666631	1-5	3	0.53 24 AWG	38.0±3.0 1.500	1.4	175	700	1000	1100	625

③ Wire length of one winding is **38.0±3.0** (1.500). Wire length of second winding is **28.0±3.0** (1.125) ⁺ Test frequency

Fair-Rite Products Corp.

PO Box J, One Commercial Row, Wallkill, NY 12589-0288

Phone: (888) FAIR RITE / (845) 895-2055 • FAX: (888) FERRITE / (845) 895-2629 • www.fair-rite.com
(888) 324-7748 (888) 337-7483 • E-Mail: ferrites@fair-rite.com

Multi-Aperture Cores

Multi-aperture cores are used in balun (balance-unbalance) transformers and find wide applications as broadband transformers in communications and CATV circuits. They are also employed in airbag designs to prevent accidental activation.

- All multi-aperture cores are supplied burnished.
- Multi-aperture cores in 73 and 43 materials are controlled for impedance only. The 61 NiZn material is controlled for both impedance and AL value. The high frequency 67 material is controlled for AL value. All listed impedance values are typical values. Minimum impedance values are specified for the + marked frequencies. The minimum guaranteed impedance is the listed typical impedance less 20%.
- Multi-aperture cores are measured for impedance on the 4193A Vector Impedance Analyzer. The cores are wound with a single turn through both holes, with the shortest practical wire length.
- The 61 and 67 material multi-hole beads are tested for AL value. The test frequency is 10 kHz at < 10 gauss. The test winding is five turns wound through both holes.
- Performance curves for all multi-hole cores can be found on the Fair-Rite Products CD-ROM.
- For any multi-aperture core requirement not listed, please contact our customer service group for availability and pricing.
- Our "Multi-Aperture Core Kit" (part number 0199000036) is available for proto type evaluation. See page 68.
- Explanation of Part Numbers: Digits 1&2 = product class, 3&4 = material grade last digit 2 = burnished.

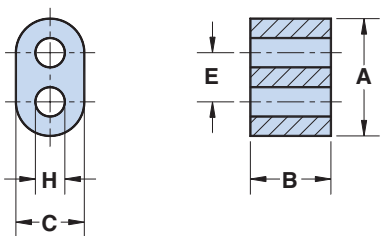

Figure 1

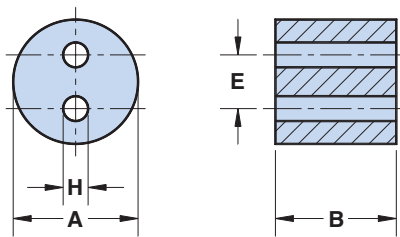

Figure 2

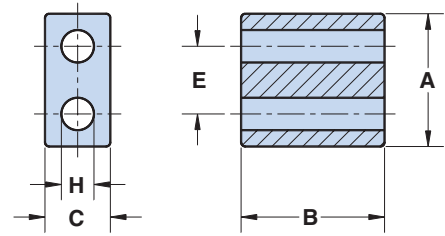

Figure 3

Fair-Rite Products Corp.

PO Box J, One Commercial Row, Wallkill, NY 12589-0288

Phone: (888) FAIR RITE / (845) 895-2055 • FAX: (888) FERRITE / (845) 895-2629
(888) 324-7748 (888) 337-7483

• www.fair-rite.com
• E-Mail: ferrites@fair-rite.com

Multi-Aperture Cores

Lower Frequencies < 50 MHz (73 material)

Dimensions (Bold numbers are in millimeters, light numbers are nominal in inches.)

Part Number	Fig.	A	B	C	E	H	Wt (g)	Typical Impedance (Ω)	
								10 MHz	25 MHz ⁺
2873002302	1	3.45±0.25 .136	2.35±0.25 .093	2.0±0.15 .079	1.45±0.1 .057	0.75+0.25 .034	.1	35	44
2873002702	1	7.0±0.25 .276	3.1±0.25 .122	4.2 - 0.25 .160	2.9±0.1 .114	1.7+ 0.2 .071	.3	28	38
2873002402	1	7.0±0.25 .276	6.2±0.25 .244	4.2 - 0.25 .160	2.9±0.1 .114	1.7+ 0.2 .071	.5	80	75
2873001802	2	6.35±0.25 .250	6.15±0.25 .242	—	2.75±0.2 .108	1.1 + 0.3 .050	.8	115	106
2873001702	2	6.35±0.25 .250	12.0±0.35 .471	—	2.75±0.2 .108	1.1 + 0.3 .050	1.6	200	200
2873001502	1	13.3±0.6 .525	6.6±0.25 .260	7.5±0.35 .295	5.7±0.25 .225	3.8±0.25 .150	1.7	57	50
2873000302	1	13.3±0.6 .525	10.3±0.3 .407	7.5±0.35 .295	5.7±0.25 .225	3.8±0.25 .150	2.6	94	75
2873000102	1	13.3±0.6 .525	13.4±0.3 .528	7.5±0.35 .295	5.7±0.25 .225	3.8±0.25 .150	3.5	127	93
2873000202	1	13.3±0.6 .525	14.35±0.5 .565	7.5±0.35 .295	5.7±0.25 .225	3.8±0.25 .150	3.7	125	106
2873006802	1	13.3±0.6 .525	27.0±0.75 1.062	7.5±0.35 .295	5.7±0.25 .225	3.8±0.25 .150	7.0	195	180

Broadband Frequencies 20-300 MHz (43 material)

Part Number	Fig.	A	B	C	E	H	Wt (g)	Typical Impedance (Ω)	
								25 MHz	100 MHz ⁺
2843002302	1	3.45±0.25 .136	2.35±0.25 .093	2.0±0.15 .079	1.45±0.1 .057	0.75+0.25 .034	.1	29	44
2843002702	1	7.0±0.25 .276	3.1±0.25 .122	4.2 - 0.25 .160	2.9±0.1 .114	1.7+ 0.2 .071	.3	37	50
2843002402	1	7.0±0.25 .276	6.2±0.25 .244	4.2 - 0.25 .160	2.9±0.1 .114	1.7+ 0.2 .071	.5	74	100
2843001802	2	6.35±0.25 .250	6.15±0.25 .242	—	2.75±0.2 .108	1.1 + 0.3 .050	.8	100	131
2843001702	2	6.35±0.25 .250	12.0±0.35 .471	—	2.75±0.2 .108	1.1 + 0.3 .050	1.6	188	256
2843001502	1	13.3±0.6 .525	6.6±0.25 .260	7.5±0.35 .295	5.7±0.25 .225	3.8±0.25 .150	1.7	59	88
2843000302	1	13.3±0.6 .525	10.3±0.3 .407	7.5±0.35 .295	5.7±0.25 .225	3.8±0.25 .150	2.6	104	130
2843000102	1	13.3±0.6 .525	13.4±0.3 .528	7.5±0.35 .295	5.7±0.25 .225	3.8±0.25 .150	3.5	122	175
2843000202	1	13.3±0.6 .525	14.35±0.5 .565	7.5±0.35 .295	5.7±0.25 .225	3.8±0.25 .150	3.7	123	180
2843006802	1	13.3±0.6 .525	27.0±0.75 1.062	7.5±0.35 .295	5.7±0.25 .225	3.8±0.25 .150	7.0	219	300
2843010402	3	19.45±0.4 .765	12.7±0.5 .500	9.5±0.25 .375	9.9±0.25 .390	4.75±0.2 .187	7.5	135	200
2843010302	3	19.45±0.4 .765	25.4±0.7 1.000	9.5±0.25 .375	9.9±0.25 .390	4.75±0.2 .187	18	295	400
2843009902	3	28.7±0.6 1.130	28.7±0.7 1.130	14.25±0.3 .560	14.0±0.3 .550	6.35±0.15 .250	48	380	500

⁺ Test frequency

Fair-Rite Products Corp.

PO Box J, One Commercial Row, Wallkill, NY 12589-0288

Phone: (888) FAIR RITE / (845) 895-2055 • FAX: (888) FERRITE / (845) 895-2629 • www.fair-rite.com
(888) 324-7748 (888) 337-7483 • E-Mail: ferrites@fair-rite.com

Multi-Aperture Cores

Higher Frequencies > 250 MHz (61 & 67 materials)

Dimensions (Bold numbers are in millimeters, light numbers are nominal in inches.)

Part Number	Fig.	A	B	C	E	H	Wt (g)	Typical Impedance (Ω)		Minimum AL (nH)
								100 MHz ⁺	250 MHz	
2861002302	1	3.45±0.25 .136	2.35±0.25 .093	2.0±0.15 .079	1.45±0.1 .057	0.75+0.25 .034	.1	38	50	60
2867002302	1	3.45±0.25 .136	2.35±0.25 .093	2.0±0.15 .079	1.45±0.1 .057	0.75+0.25 .034	.1	–	–	18
2861002702	1	7.0±0.25 .276	3.1±0.25 .122	4.2 - 0.25 .160	2.9±0.1 .114	1.7+ 0.2 .071	.3	44	58	80
2867002702	1	7.0±0.25 .276	3.1±0.25 .122	4.2 - 0.25 .160	2.9±0.1 .114	1.7+ 0.2 .071	.3	–	–	24
2861002402	1	7.0±0.25 .276	6.2±0.25 .244	4.2 - 0.25 .160	2.9±0.1 .114	1.7+ 0.2 .071	.5	88	120	160
2867002402	1	7.0±0.25 .276	6.2±0.25 .244	4.2 - 0.25 .160	2.9±0.1 .114	1.7+ 0.2 .071	.5	–	–	48
2861001802	2	6.35±0.25 .250	6.15±0.25 .242	–	2.75±0.2 .108	1.1 + 0.3 .050	.8	119	155	220
2867001802	2	6.35±0.25 .250	6.15±0.25 .242	–	2.75±0.2 .108	1.1 + 0.3 .050	.8	–	–	65
2861001702	2	6.35±0.25 .250	12.0±0.35 .471	–	2.75±0.2 .108	1.1 + 0.3 .050	1.6	230	320	440
2867001702	2	6.35±0.25 .250	12.0±0.35 .471	–	2.75±0.2 .108	1.1 + 0.3 .050	1.6	–	–	130
2861001502	1	13.3±0.6 .525	6.6±0.25 .260	7.5±0.35 .295	5.7±0.25 .225	3.8±0.25 .150	1.7	69	90	145
2867001502	1	13.3±0.6 .525	6.6±0.25 .260	7.5±0.35 .295	5.7±0.25 .225	3.8±0.25 .150	1.7	–	–	44
2861000302	1	13.3±0.6 .525	10.3±0.3 .407	7.5±0.35 .295	5.7±0.25 .225	3.8±0.25 .150	2.6	106	145	230
2867000302	1	13.3±0.6 .525	10.3±0.3 .407	7.5±0.35 .295	5.7±0.25 .225	3.8±0.25 .150	2.6	–	–	68
2861000102	1	13.3±0.6 .525	13.4±0.3 .528	7.5±0.35 .295	5.7±0.25 .225	3.8±0.25 .150	3.5	138	175	300
2867000102	1	13.3±0.6 .525	13.4±0.3 .528	7.5±0.35 .295	5.7±0.25 .225	3.8±0.25 .150	3.5	–	–	89
2861000202	1	13.3±0.6 .525	14.35±0.5 .565	7.5±0.35 .295	5.7±0.25 .225	3.8±0.25 .150	3.7	150	210	320
2867000202	1	13.3±0.6 .525	14.35±0.5 .565	7.5±0.35 .295	5.7±0.25 .225	3.8±0.25 .150	3.7	–	–	95
2861006802	1	13.3±0.6 .525	27.0±0.75 1.062	7.5±0.35 .295	5.7±0.25 .225	3.8±0.25 .150	7.0	280	400	600
2867006802	1	13.3±0.6 .525	27.0±0.75 1.062	7.5±0.35 .295	5.7±0.25 .225	3.8±0.25 .150	7.0	–	–	180
2861010002	3	30.2±0.6 1.190	28.7±0.7 1.130	15.0±0.4 .590	14.6±0.4 .575	6.8±0.2 .268	46	600	800	800

⁺ Test frequency

Fair-Rite Products Corp.

PO Box J, One Commercial Row, Wallkill, NY 12589-0288

Phone: (888) FAIR RITE / (845) 895-2055 • FAX: (888) FERRITE / (845) 895-2629 • www.fair-rite.com
(888) 324-7748 (888) 337-7483 • E-Mail: ferrites@fair-rite.com

SM Beads (Differential-Mode)

Surface mount beads are available from Fair-Rite in several materials and sizes. Their rugged construction lowers the dc resistance and increases current carrying capacity compared to plated beads.

- SM Beads on 12mm tape width are supplied taped and reeled per EIA 481-1 and IEC 60286-3 standards. SM Beads on 16 and 24mm tape widths are supplied taped and reeled per EIA 481-2 and IEC 60286-3 standards. Taped and reeled parts are supplied on a 13" reel.
- SM Beads can also be supplied not taped and reeled and then are bulk packed. This packing method will change the last digit of the part number to a "6".
- The copper conductors have a lead-free tin coating. If required SM Beads can be supplied with copper conductors having a tin/lead coating. See page 28 for suggested solder profile for lead-free components.
- SM Beads meet the solderability specifications when tested in accordance with MIL-STD-202, method 208. After dipping the mounting site of the bead, the solder surface shall be at least 95% covered with a smooth solder coating. The edges of the copper strip are not specified as solderable surfaces.
- After preheating the beads to within 100 °C of the soldering temperature, the parts meet the resistance to soldering requirements of EIA-186-10E, temperature 260±5 °C and time 10±1 seconds.
- Suggested land patterns are in accordance with the latest revision of IPC-7351.
- SM Beads are controlled for impedance limits only. The impedances listed are typical values. Minimum impedance values are specified for the + marked frequencies.
The minimum guaranteed impedance is the listed value less 20%.
SM Beads in 73, 43 and 44 materials are measured for impedance on the 4193 Vector Impedance Analyzer. The 52 and 61 SM Beads are tested for impedance on the 4191A RF Impedance Analyzer.
- Recommended storage and operation temperature is -55 °C to 125 °C.
- The maximum current rating for these SM Beads is 5 amps.
- Performance curves of all the SM Beads are compiled on the Fair-Rite Products CD-ROM.
- For any SM Bead requirement not listed, please contact our customer service group for availability and pricing.
- Our "Surface Mount Bead Kit" (part number 0199000025) is available for prototype evaluation. See page 67.
- Explanation of Part Numbers: Digits 1&2 = product class, 3&4 = material grade, last digit 6 = bulk packed, 7 = taped and reeled.

Fair-Rite Products Corp. PO Box J, One Commercial Row, Wallkill, NY 12589-0288

Phone: (888) FAIR RITE / (845) 895-2055 • FAX: (888) FERRITE / (845) 895-2629 • www.fair-rite.com
(888) 324-7748 (888) 337-7483 • E-Mail: ferrites@fair-rite.com

SM Beads (Differential-Mode)

Lower Frequencies < 50 MHz (73 material)

Dimensions (Bold numbers are in millimeters, light numbers are nominal in inches.)

Part Number	Fig.	A	B	C	D	E	Wt (g)	Tape Width mm	Pitch mm	Parts/Reel
2773019447	1	2.85±0.2 .112	3.05±0.1 .120	5.1 - 0.85 .184	1.5±0.5 .059	—	.15	12	8	2800
2773021447	1	2.85±0.2 .112	3.05±0.1 .120	9.6 - 0.95 .359	1.5±0.5 .059	—	.30	16	8	2800
2773037447	1	2.70±0.2 .106	4.6±0.2 .181	9.25 - 0.7 .350	1.4±0.4 .055	—	.45	16	8	2800
2773044447	1	1.75 Max. .068 Max.	3.1±0.1 .122	5.65±0.45 .222	1.55±0.5 .061	—	.09	12	8	4500

Broadband Frequencies 25-300 MHz (43 & 44 material)

Dimensions (Bold numbers are in millimeters, light numbers are nominal in inches.)

Part Number	Fig.	A	B	C	D	E	Wt (g)	Tape Width mm	Pitch mm	Parts/Reel
2743019447	1	2.85±0.2 .112	3.05±0.1 .120	5.1 - 0.85 .184	1.5±0.5 .059	—	.15	12	8	2800
2743021447	1	2.85±0.2 .112	3.05±0.1 .120	9.6 - 0.95 .359	1.5±0.5 .059	—	.30	16	8	2800
2743037447	1	2.70±0.2 .106	4.6±0.2 .181	9.25 - 0.7 .350	1.4±0.4 .055	—	.45	16	8	2800
2744044447	1	1.75 Max. .068 Max.	3.1±0.1 .122	5.65±0.45 .222	1.55±0.5 .061	—	.09	12	8	4500
2744040447	2	1.95 Max. .076 Max.	4.5±0.2 .177	6.4 - 0.6 .240	1.4±0.4 .055	1.27±0.05 .050	.14	12	8	4000
2744555567	4	5.0 Max. .197 Max.	5.00±0.25 .197	11.0 Max. .433 Max.	2.5±0.5 .098	—	.96	24	12	1500
2744555577	3	5.0 Max. .197 Max.	5.00±0.25 .197	11.0 Max. .433 Max.	2.5±0.5 .098	—	.96	24	12	1500

Higher Frequencies 250-1000 MHz (52 & 61 material)

Dimensions (Bold numbers are in millimeters, light numbers are nominal in inches.)

Part Number	Fig.	A	B	C	D	E	Wt (g)	Tape Width mm	Pitch mm	Parts/Reel
2761019447	1	2.85±0.2 .112	3.05±0.1 .120	5.1 - 0.85 .184	1.5±0.5 .059	—	.15	12	8	2800
2761021447	1	2.85±0.2 .112	3.05±0.1 .120	9.6 - 0.95 .359	1.5±0.5 .059	—	.30	16	8	2800
2752555567	4	5.0 Max. .197 Max.	5.00±0.25 .197	11.0 Max. .433 Max.	2.5±0.5 .098	—	.96	24	12	1500
2752555577	3	5.0 Max. .197 Max.	5.00±0.25 .197	11.0 Max. .433 Max.	2.5±0.5 .098	—	.96	24	12	1500

Fair-Rite Products Corp.

PO Box J, One Commercial Row, Wallkill, NY 12589-0288

Phone: (888) FAIR RITE / (845) 895-2055 • FAX: (888) FERRITE / (845) 895-2629 • www.fair-rite.com
(888) 324-7748 (888) 337-7483 • E-Mail: ferrites@fair-rite.com

SM Beads (Differential-Mode)

Lower Frequencies < 50 MHz (73 material)

Part Number	Typical Impedance(Ω)				Max Rdc(m Ω)	Land Pattern Dimensions				
	1 MHz	5 MHz	10 MHz ⁺	25 MHz ⁺		V	W (ref.)	X	Y	Z
2773019447	12	25	31	40	0.8	1.0 .040	4.0 .157	1.8 .071	3.0 .118	-
2773021447	25	50	60	78	1.2	4.5 .177	7.5 .295	1.8 .071	3.0 .118	-
2773037447	25	50	60	78	1.2	5.0 .197	8.0 .315	1.8 .071	3.0 .118	-
2773044447	9	19	25	33	1.1	1.5 .059	4.5 .177	1.8 .071	3.0 .118	-

Broadband Frequencies 25-300 MHz (43 & 44 material)

Part Number	Typical Impedance(Ω)				Max Rdc(m Ω)	Land Pattern Dimensions				
	10 MHz	25 MHz ⁺	100 MHz ⁺	250 MHz		V	W (ref.)	X	Y	Z
2743019447	18	29	47	49	0.8	1.0 .040	4.0 .157	1.8 .071	3.0 .118	-
2743021447	37	56	95	100	1.2	4.5 .177	7.5 .295	1.8 .071	3.0 .118	-
2743037447	37	56	95	100	1.2	5.0 .197	8.0 .315	1.8 .071	3.0 .118	-
2744044447	13	21	36	39	1.1	1.5 .059	4.5 .177	1.8 .071	3.0 .118	-
2744040447	18	29	56	60	1.6	1.8 .071	4.8 .189	0.8 .032	3.0 .118	1.27 .050
2744555567	150	250	375	385	3.8	2.0 .079	7.0 .276	2.0 .079	5.0 .197	-
2744555577	255	425	600	575	6.2	2.0 .079	7.0 .276	2.0 .079	5.0 .197	-

Higher Frequencies 250-1000 MHz (52 & 61 material)

Part Number	Typical Impedance(Ω)				Max Rdc(m Ω)	Land Pattern Dimensions				
	100 MHz	250 MHz ⁺	500 MHz ⁺	1000 MHz		V	W (ref.)	X	Y	Z
2761019447	36	50	55	59	0.8	1.0 .040	4.0 .157	1.8 .071	3.0 .118	-
2761021447	69	94	106	118	1.2	4.5 .177	7.5 .295	1.8 .071	3.0 .118	-
2752555567	400	490	425	250	3.8	2.0 .079	7.0 .276	2.0 .079	5.0 .197	-
2752555577	700	770	440	250	6.2	2.0 .079	7.0 .276	2.0 .079	5.0 .197	-

+ Test frequency

Fair-Rite Products Corp.

PO Box J, One Commercial Row, Wallkill, NY 12589-0288

Phone: (888) FAIR RITE / (845) 895-2055 • FAX: (888) FERRITE / (845) 895-2629 • www.fair-rite.com
(888) 324-7748 (888) 337-7483 • E-Mail: ferrites@fair-rite.com

SM Beads (Differential-Mode)

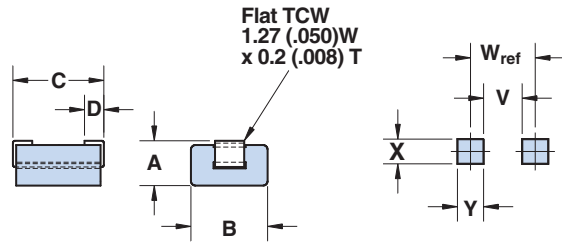

Figure 1

Land Pattern
for Fig. 1

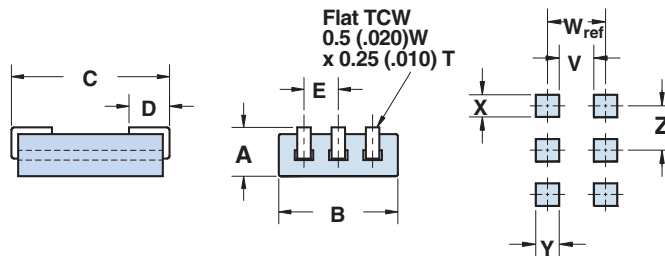

Figure 2

Land Pattern
for Fig. 2
E = Z

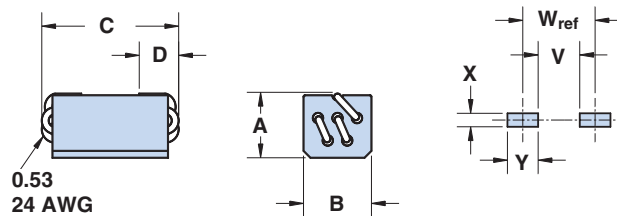

Figure 3

Land Pattern
for Fig. 3

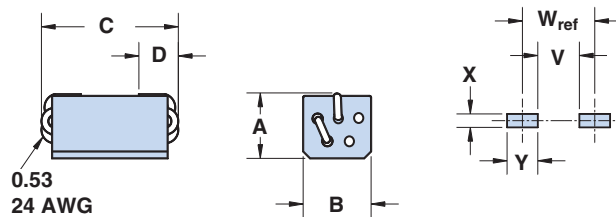

Figure 4

Land Pattern
for Fig. 4

SM Beads (Common-Mode)

Surface mount common-mode beads are available from Fair-Rite in several materials and sizes. The common-mode bead provides a common magnetic path for the flux generated by the current to the load and the return current from the load. The current compensation results in zero magnetic flux in the bead.

- SM Beads on 12mm tape width are supplied taped and reeled per EIA 481-1 and IEC 60286-3 standards. SM Beads on 16 and 24 mm tape widths are supplied taped and reeled per EIA 481-2 and IEC 60286-3 standards. Taped and reeled parts are supplied on a 13" reel.
- SM Beads can also be supplied not taped and reeled and then are bulk packed. This packing method will change the last digit of the part number to a "6".
- The copper conductors have a lead-free tin coating. If required SM Beads can be supplied with copper conductors having a tin/lead coating. See page 28 for suggested solder profile for lead-free components.
- SM Beads meet the solderability specifications when tested in accordance with MIL-STD-202, method 208. After dipping the mounting site of the bead, the solder surface shall be at least 95% covered with a smooth solder coating. The edges of the copper strip are not specified as solderable surfaces.
- After preheating the beads to within 100 °C of the soldering temperature, the parts meet the resistance to soldering requirements of EIA-186-10E, temperature 260±5 °C and time 10±1 seconds.
- Suggested land patterns are in accordance with the latest revision of IPC-7351.
- SM Beads are controlled for impedance limits only. The impedances listed are typical values. Minimum impedance values are specified for the + marked frequencies.
The minimum guaranteed impedance is the listed value less 20%.
SM Beads in 44 materials are measured for impedance on the 4193 Vector Impedance Analyzer. The 52 SM Beads are tested for impedance on the 4191A RF Impedance Analyzer.
- Recommended storage and operation temperature is -55 °C to 125 °C.
- The maximum current rating for these SM Beads is 5 amps.
- Performance curves of all the SM Beads are compiled on the Fair-Rite Products CD-ROM.
- For any SM Bead requirement not listed, please contact our customer service group for availability and pricing.
- Our "Surface Mount Bead Kit" (part number 0199000025) is available for prototype evaluation. See page 67.
- Explanation of Part Numbers: Digits 1&2 = product class, 3&4 = material grade, last digit 6 = bulk packed, 7 = taped and reeled.

Fair-Rite Products Corp. PO Box J, One Commercial Row, Wallkill, NY 12589-0288

Phone: (888) FAIR RITE / (845) 895-2055 • FAX: (888) FERRITE / (845) 895-2629 • www.fair-rite.com
(888) 324-7748 (888) 337-7483 • E-Mail: ferrites@fair-rite.com

SM Beads (Common-Mode)

Broadband Frequencies 10-300 MHz (44 material)

Dimensions (Bold numbers are in millimeters, light numbers are nominal in inches.)

Part Number	Fig.	A	B	C	D	E	Wt (g)	Tape Width mm	Pitch mm	Parts/Reel
2744041447	1	2.85±0.2 .112	5.6±0.2 .220	5.0 - 0.6 .185	1.35±0.5 .053	2.54±0.1 .100	.30	12	8	2400
2744045447	1	2.85±0.2 .112	5.6±0.2 .220	8.9 - 0.8 .335	1.35±0.5 .053	2.54±0.1 .100	.53	16	8	2400
2744051447	2	4.5 Max. .177 Max.	6.65 Max. .262 Max.	12.0 Max. .472 Max.	2.5±0.5 .098	3.00±0.1 .118	1.0	24	12	1000
2744065447	2	5.3 Max. .209 Max.	7.00 Max. .275 Max.	14.8 Max. .582 Max.	2.5±0.5 .098	3.00±0.1 .118	1.8	24	12	1000

Higher Frequencies 250-1000 MHz (52 material)

Part Number	Fig.	A	B	C	D	E	Wt (g)	Tape Width mm	Pitch mm	Parts/Reel
2752041447	1	2.85±0.2 .112	5.6±0.2 .220	5.0 - 0.6 .185	1.35±0.5 .053	2.54±0.1 .100	.30	12	8	2400
2752045447	1	2.85±0.2 .112	5.6±0.2 .220	8.9 - 0.8 .335	1.35±0.5 .053	2.54±0.1 .100	.53	16	8	2400
2752051447	2	4.5 Max. .177 Max.	6.65 Max. .262 Max.	12.0 Max. .472 Max.	2.5±0.5 .098	3.00±0.1 .118	1.0	24	12	1000
2752065447	2	5.3 Max. .209 Max.	7.00 Max. .275 Max.	14.8 Max. .582 Max.	2.5±0.5 .098	3.00±0.1 .118	1.8	24	12	1000

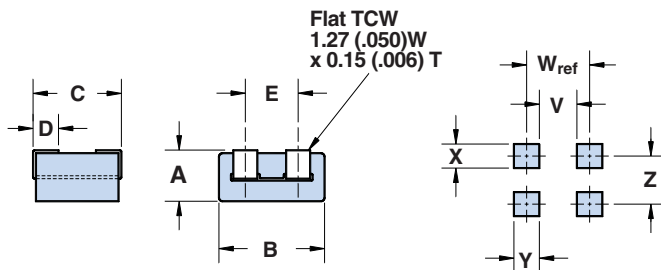

Figure 1
Common-Mode Bead

Land Pattern
for Fig. 1
E = Z

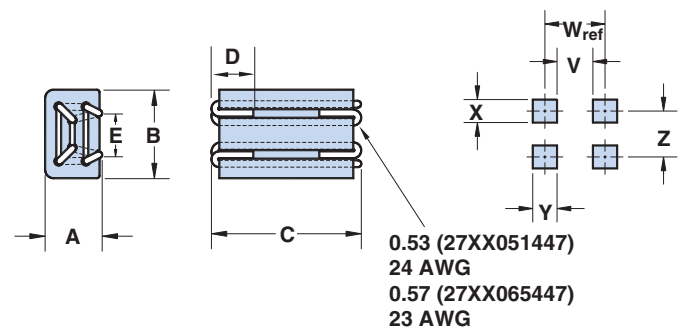

Figure 2
Common-Mode Bead

Land Pattern
for Fig. 2
E = Z

SM Beads (Common-Mode)

Broadband Frequencies 10-300 MHz (44 material)

Part Number	Typical Impedance(Ω)				Max Rdc(m Ω)	Land Pattern Dimensions				
	10 MHz	25 MHz ⁺	100 MHz ⁺	250 MHz		V	W (ref.)	X	Y	Z
2744041447	12	20	33	41	1.1	1.0 .040	4.0 .157	1.8 .071	3.0 .118	2.54 .100
2744045447	23	38	60	78	1.4	4.0 .158	7.0 .276	1.8 .071	3.0 .118	2.54 .100
2744051447	60	100	230	275 @300MHz	4.0	4.0 .158	9.0 .354	1.0 .040	5.0 .197	3.0 .118
2744065447	95	145	255	375 @300MHz	4.1	6.8 .268	11.8 .465	1.1 .043	5.0 .197	3.0 .118

Higher Frequencies 250-1000 MHz (52 material)

Part Number	Typical Impedance(Ω)				Max Rdc(m Ω)	Land Pattern Dimensions				
	100 MHz	250 MHz ⁺	500 MHz ⁺	1000 MHz		V	W (ref.)	X	Y	Z
2752041447	32	50	63	70	1.1	1.0 .040	4.0 .157	1.8 .071	3.0 .118	2.54 .100
2752045447	58	90	115	130	1.4	4.0 .158	7.0 .276	1.8 .071	3.0 .118	2.54 .100
2752051447	200	330	400	350	4.0	4.0 .158	9.0 .354	1.0 .040	5.0 .197	3.0 .118
2752065447	230	390	460	380	4.1	6.8 .268	11.8 .465	1.1 .043	5.0 .197	3.0 .118

⁺ Test frequency

Fair-Rite Products Corp.

PO Box J, One Commercial Row, Wallkill, NY 12589-0288

Phone: (888) FAIR RITE / (845) 895-2055 • FAX: (888) FERRITE / (845) 895-2629
(888) 324-7748 (888) 337-7483

• www.fair-rite.com
• E-Mail: ferrites@fair-rite.com

Chip Beads

Fair-Rite offers a broad selection of cost effective chip beads to suppress conducted EMI in a wide variety of devices such as cellular phones, computers, laptops, pagers, etc.

The small standard package sizes accommodate automated installation and allow for a dense packaging of circuit boards.

Chip beads are 100% tested for impedance and dc resistance. They are available in standard, high and GHz signal speeds. Chip beads are organized and listed by increasing current carrying capacity.

- All multi-layer chip beads are supplied taped and reeled, if required bulk packed chip beads can be provided. See table on the next page with tape and reel particulars.
- Chip beads are controlled for impedance. The impedance values listed are typical values. A nominal impedance with a +/- 25% tolerance is specified for the + marked frequency.
- Chip beads are measured for impedance on the HP 4291A and fixture HP 16192A.
- Chip beads can accommodate both reflow and wave soldering technologies. See page 28 for the recommended soldering profile for chip components.
- Suggested land patterns are in accordance to the latest revision of IPC-7351.
- Chip beads have plated contacts, 100% tin over a nickel undercoating.
- Recommended storage and operating temperature range is -55°C to 125°C.
- Performance curves for all listed chip beads, with and without dc bias, are on the Fair-Rite Products CD-ROM.
- Our "Chip Bead Kit" (part number 0199000018) is available for prototype evaluation. See page 68.

Part Number System: Example 2512063017Y1

25	1206	301	7	Y	1
Chip Bead Code	Package Size Code	Impedance Code	Packaging Code	Material Code	Current Code
		6= Bulk Packed 7= Taped and Reeled 7" Reel 8= Taped and Reeled 13" Reel		Y = Standard Signal Speed Z = High Signal Speed H = GHz Speed	0 < 1.0A 1 ≥ 1.0A < 2.0A 3 ≥ 3.0A < 4.0A ETC

Fair-Rite Products Corp.

Phone: (888) FAIR RITE / (845) 895-2055 • FAX: (888) FERRITE / (845) 895-2629
(888) 324-7748 (888) 337 -7483

PO Box J, One Commercial Row, Wallkill, NY 12589-0288

• www.fair-rite.com
• E-Mail: ferrites@fair-rite.com

Chip Beads

Dimensions (Bold numbers are in millimeters, light numbers are in inches.)

Pkg. Size	Dimensions					Land Patterns				Tape Width mm	Pitch mm	Parts per Reel	
	A	B	C	D	Wt(g)	V	W ref	X	Y			7"	13"
0402 (1005)	0.5±0.15 .020	0.5±0.15 .020	1.0±0.15 .040	0.25±0.15 .010	0.002	0.40 .016	1.30 .051	0.70 .028	0.90 .035	8	4	10,000	N/A
0603 (1608)	0.8±0.3 .031	0.8±0.3 .031	1.6±0.15 .063	0.4±0.2 .016	0.006	0.60 .024	1.70 .067	1.00 .039	1.10 .043	8	4	4,000	10,000
0805 (2012)	0.9±0.2 .035	1.25±0.2 .049	2.0±0.2 .079	0.5±0.3 .020	0.01	0.60 .024	1.90 .075	1.50 .059	1.30 .051	8	4	4,000	10,000
1206 (3216)	1.1±0.2 .043	1.6±0.2 .063	3.2±0.2 .126	0.7±0.3 .028	0.03	1.20 .047	2.80 .110	1.80 .071	1.60 .063	8	4	3,000	10,000
1806 (4516)	1.6±0.2 .063	1.6±0.2 .063	4.5±0.2 .177	0.7±0.3 .028	0.06	2.00 .079	3.90 .154	1.80 .071	1.90 .075	12	8	2,000	10,000
1812 (4532)	1.6±0.2 .063	3.2±0.2 .126	4.5±0.2 .177	0.7±0.3 .028	0.09	2.00 .079	3.90 .154	3.40 .134	1.90 .075	12	8	1,000	5,000

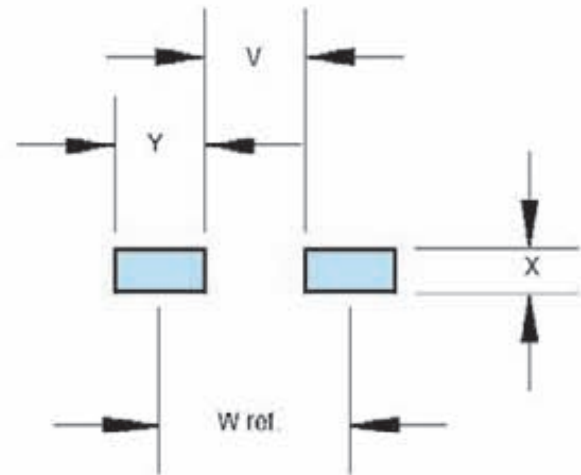
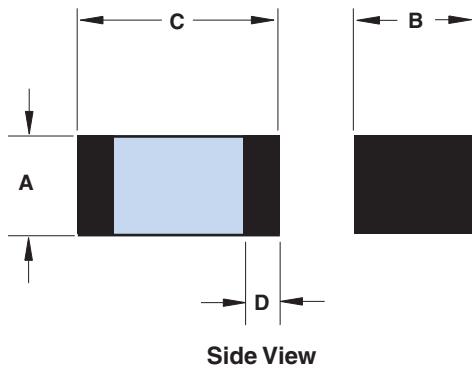

Fair-Rite Products Corp.

PO Box J, One Commercial Row, Wallkill, NY 12589-0288

Phone: (888) FAIR RITE / (845) 895-2055 • FAX: (888) FERRITE / (845) 895-2629 • www.fair-rite.com
 (888) 324-7748 (888) 337-7483 • E-Mail: ferrites@fair-rite.com

Chip Beads

Current	Pkg. Size	Signal Speed	Part Number	Z (Ω) 50 MHz	Z (Ω) ± 25% 100 MHz ⁺	Z (Ω) 500 MHz	Z (Ω) 1000 MHz	Max.DCR (Ω)	Max Cur. mA
Low	0402 (1005)	Standard	2504021007Y0	8	10	13	14	0.05	500
			2504026007Y0	48	60	79	79	0.4	200
			2504021217Y0	88	120	170	157	0.5	200
			2504023017Y0	234	300	370	264	0.75	100
			2504026017Y0	421	600	652	362	1.1	50
	0603 (1608)	Standard	2506033007Y0	23	30	46	48	0.1	400
			2506036007Y0	45	60	94	82	0.15	400
			2506038007Y0	59	80	121	102	0.15	400
			2506031017Y0	77	100	144	131	0.15	400
			2506031217Y0	90	120	179	142	0.15	400
			2506031517Y0	109	150	224	179	0.15	400
			2506033017Y0	213	300	326	205	0.3	400
			2506036017Y0	426	600	405	226	0.35	400
		High	2506031027Y0	653	1000	241	110	0.55	300
			2506036007Z0	28	60	145	96	0.25	450
			2506031217Z0	60	120	278	192	0.3	450
		GHz	2506033017Z0	112	300	314	142	0.35	450
			2506030707H0	4	7	30	38	0.1	700
			2506031007H0	5	10	43	50	0.1	700
			2506031217H0	50	120	600	500	0.5	200
			2506032217H0	100	220	800	1000	0.8	100
		0805 (2012)	Standard	2506033317H0	150	330	1300	1500	1.2
	2508051107Y0			8	11	16	16	0.1	300
	2508053007Y0			22	30	46	49	0.1	300
	2508055007Y0			36	50	73	76	0.15	300
	2508056007Y0			45	60	88	89	0.15	300
	2508059007Y0			68	90	125	107	0.2	300
	2508051017Y0			75	100	134	120	0.2	300
	2508051217Y0			89	120	172	127	0.2	300
	2508051817Y0			134	180	198	111	0.2	300
	2508053017Y0			216	300	161	84	0.25	300
	2508056017Y0		428	600	284	141	0.35	300	
	High		2508051027Y0	688	1000	300	148	0.45	300
2508051527Y0			989	1500	235	118	0.7	300	
2508056007Z0		28	60	111	122	0.15	300		
GHz	2508051217Z0	45	120	253	191	0.2	250		
	2508053017Z0	118	300	280	139	0.25	200		
			2508052027Z0	440	2000	160	80	0.4	200
			2508050507H0	2	5	17	22	0.07	500

+ Test frequency

Fair-Rite Products Corp.

PO Box J, One Commercial Row, Wallkill, NY 12589-0288

Phone: (888) FAIR RITE / (845) 895-2055 • FAX: (888) FERRITE / (845) 895-2629 • www.fair-rite.com
 (888) 324-7748 (888) 337-7483 • E-Mail: ferrites@fair-rite.com

Chip Beads

Current	Pkg. Size	Signal Speed	Part Number	Z (Ω) 50 MHz	Z (Ω) ± 25% 100 MHz ⁺	Z (Ω) 500 MHz	Z (Ω) 1000 MHz	Max.DCR (Ω)	Max Cur. mA
Low	1206 (3216)	Standard	2512063007Y0	21	30	49	52	0.1	800
			2512065007Y0	38	50	68	67	0.15	800
			2512067007Y0	53	70	101	102	0.15	500
			2512069007Y0	72	90	121	113	0.2	450
			2512061017Y0	72	100	127	86	0.2	450
			2512061217Y0	87	120	151	109	0.2	450
			2512063017Y0	203	300	233	118	0.2	350
			2512066017Y0	581	600	116	67	0.25	350
			2512061027Y0	784	1000	230	117	0.35	350
			2512061527Y0	1500	1500	250	200	0.4	350
	1806 (4516)	Standard	2518061017Y0	73	100	153	155	0.3	400
			2518061517Y0	110	150	205	167	0.5	200
Medium	0603 (1608)	Standard	2506033007Y3	23	30	40	41	0.04	3000
			2506036007Y3	48	60	84	81	0.04	3000
			2506031217Y2	90	120	170	152	0.05	2000
	0805 (2012)	Standard	2508053007Y3	23	30	41	41	0.03	3000
			2508056007Y3	49	60	84	84	0.04	3000
			2508051217Y3	91	120	165	135	0.05	3000
			2508053017Y3	239	300	218	117	0.05	3000
			2508056017Y2	449	600	293	159	0.1	2000
			2508051027Y1	764	1000	402	216	0.3	1000
	1206 (3216)	Standard	2512063007Y3	24	30	40	38	0.03	3000
			2512065007Y3	39	50	69	70	0.03	3000
			2512067007Y3	53	70	102	103	0.04	3000
			2512061517Y3	120	150	173	130	0.05	3000
			2512063017Y3	212	300	150	88	0.06	3000
			2512066017Y1	460	600	260	120	0.08	1000
			2512061027Y1	925	1000	210	117	0.30	1000
	1806 (4516)	Standard	2518066007Y3	44	60	91	94	0.04	3000
			2518068007Y3	64	80	114	114	0.04	3000
	1812 (4532)	Standard	2518127007Y3	54	70	96	96	0.04	3000
			2518121217Y3	92	120	150	106	0.04	3000
High	0805 (2012)	Standard	2508056007Y6	47	60	88	68	0.02	6000
			2508051217Y6	94	120	158	132	0.025	6000
	1206 (3216)	Standard	2512065007Y6	39	50	68	56	0.02	6000
			2512061217Y5	96	120	137	91	0.025	5000
	1806 (4516)	Standard	2518065007Y6	36	50	63	61	0.01	6000
			2518061017Y6	75	100	139	132	0.02	6000
1812	Standard	2518121217Y6	92	120	149	105	0.02	6000	

+ Test frequency

Fair-Rite Products Corp.

PO Box J, One Commercial Row, Wallkill, NY 12589-0288

 Phone: (888) FAIR RITE / (845) 895-2055 • FAX: (888) FERRITE / (845) 895-2629
 (888) 324-7748 (888) 337-7483

 • www.fair-rite.com
 • E-Mail: ferrites@fair-rite.com

Chip Arrays

Fair-Rite offers an effective cost and real estate reduction by our line of chip arrays. Four chip beads, packaged in a 1206 (3216) size, for suppression of conducted EMI where size is at a premium. Chip arrays are 100% tested for impedance and dc resistance. They are available in standard and high signal speeds.

- Chip arrays have plated contacts, 100% tin over a nickel undercoating.
- Chip arrays are supplied taped and reeled, if required bulk packed arrays can be supplied. For particulars on the taped and reeled parts see the Part Number System below.
- Chip arrays are controlled for impedance. The impedance values listed are typical values. The nominal impedance with a +/- 25% tolerance is specified for the + marked 100 MHz frequency. Chip arrays are measured for impedance on the HP 4291A and fixture HP 16192A.
- The arrays can accommodate both reflow and wave soldering technologies. See page 28 for the recommended soldering profile for lead-free chip components.
- Suggested land patterns are in accordance to the IPC-7351.
- Recommended storage and operating temperature range is -55 °C to 125 °C.
- Performance curves for the chip arrays, with and without dc bias, are on the Fair-Rite Products CD-ROM.
- "Chip Bead Kit" (part number 0199000018) contains the high speed 220 ohm 4 line chip array. See page 67.

Part Number Sytem: Example 2512066007Y0A4

25	1206	600	7	Y	0	A4
Chip Suppression Component	Package Size	Impedance Code	Packaging Code	Material Code	Current Code	Array 4 Lines
		600 = 60 Ω	6 = Bulk Packed 7 = T&R	Y = Std Signal Speed Z = GHz Speed	0 < 1A	

Fair-Rite Products Corp.

Phone: (888) FAIR RITE / (845) 895-2055 • FAX: (888) FERRITE / (845) 895-2629
(888) 324-7748 (888) 337 -7483

PO Box J, One Commercial Row, Wallkill, NY 12589-0288

• www.fair-rite.com
• E-Mail: ferrites@fair-rite.com

Chip Arrays

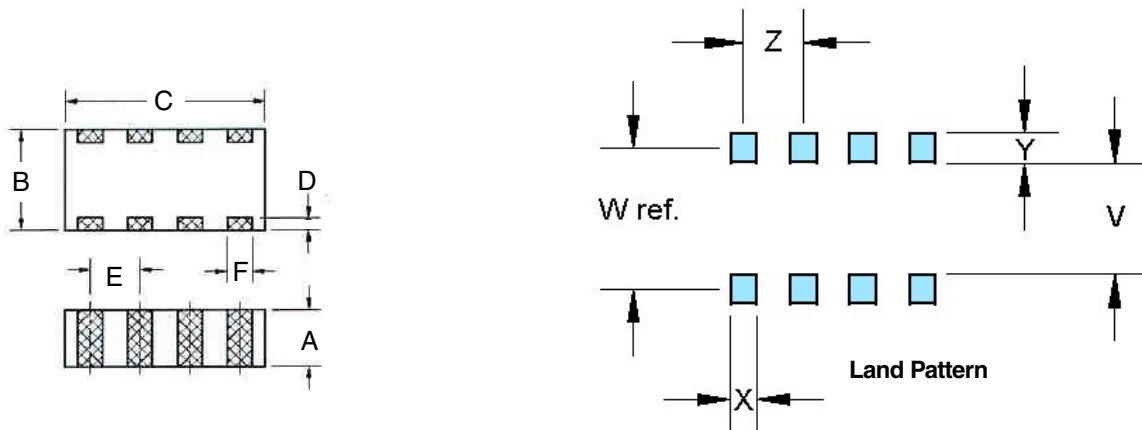

Pkg. Size	Dimensions	A	B	C	D	E	F	Wgt (g)
1206	mm	0.8±0.2	1.6±0.2	3.2±0.2	0.3±0.2	0.8±0.1	0.4±0.15	0.03
	inches	.031	.063	.126	.011	.031	.016	

Land Pattern						Reel Information		
	V	W ref.	X	Y	Z	Tape Width mm	Pitch mm	Parts per 7" reel
mm	0.7	1.3	0.5	0.6	0.8	8	4	3000
inches	.028	.051	.020	.024	.032			

Part Number	Speed	Z (Ω) 50MHz	Z (Ω) ±25% 100MHz	Z (Ω) 500MHz	Z (Ω) 1000MHz	Max DCR (Ω)	Max Current (mA)
2512066007Y0A4	Standard	48	60	77	75	0.25	200
2512061217Y0A4	Standard	95	120	150	118	0.3	150
2512063017Y0A4	Standard	225	300	280	160	0.3	150
2512066017Y0A4	Standard	460	600	400	205	0.5	100
2512061027Y0A4	Standard	770	1000	400	200	0.7	50
2512061217Z0A4	High Speed	68	120	215	205	0.3	200
2512062217Z0A4	High Speed	95	220	360	205	0.45	150

Fair-Rite Products Corp.

PO Box J, One Commercial Row, Wallkill, NY 12589-0288

Phone: (888) FAIR RITE / (845) 895-2055 • FAX: (888) FERRITE / (845) 895-2629 • www.fair-rite.com
 (888) 324-7748 (888) 337-7483 • E-Mail: ferrites@fair-rite.com

Chip Inductors

Multi-Layer chip inductors have complimented our line of chip components. These chip inductors have silk-screened windings on a ferrite or non-magnetic ceramic body which after sintering forms a monolithic structure which is a self shielding, closed magnetic unit.

Chip inductors come in two types, with a ferrite body and with a non-magnetic ceramic core. Both types provide excellent solderability and heat resistance for either flow or reflow soldering processes.

Both chip inductor types are used in tuned applications and for energy storage devices for frequencies in the hundreds of MHz into the GHz range.

- Chip inductors are supplied taped and reeled, if required bulk packed parts can be supplied. See table on the next page for tape and reel particulars.
- Chip inductors are 100% tested for a toleranced inductance and minimum Q at specified test frequencies.
- Suggested land patterns are in accordance to the latest revision of IPC-7351.
- Chip inductors have plated contacts, 100% tin over a nickel undercoating.
- Suggested temperature soldering profile is shown page 28.
- Recommended storage and operating temperature range is -40 °C to +85 °C.
- The Fair-Rite Products CD-ROM has a number of typical performance curves for the ferrite and ceramic multi-layer chip inductors.
- The new "Chip Inductor Kit" (part number 0199000035) contains a cross section of both types of multi-layer chip inductors. See page 68.

Part Number Sytem: Example 2212061R2K7F

22	1206	1R2	K	7	F
Multi-Layer Chip Inductor	Package Size	Inductance Code	Inductance Tolerance	Packaging Code	Material Code
		N = Decimal point for nH (4N7 = 4.7nH = 0.0047μH) (47N = 47nH = 0.047μH) R = Decimal point for μH (>99nH) (R22 = 0.22μH) (2R2 = 2.2μH)	S = ± 0.3nH J = ± 5% K = ± 10% M = ± 20%	6 = Bulk Packed 7 = T&R (7") 8 = T&R (13")	F = Ferrite Body For general signal usage C = Ceramic Body For high frequency usage

Fair-Rite Products Corp.

PO Box J, One Commercial Row, Wallkill, NY 12589-0288

Phone: (888) FAIR RITE / (845) 895-2055 • FAX: (888) FERRITE / (845) 895-2629
(888) 324-7748 (888) 337-7483

• www.fair-rite.com
• E-Mail: ferrites@fair-rite.com

Chip Inductors

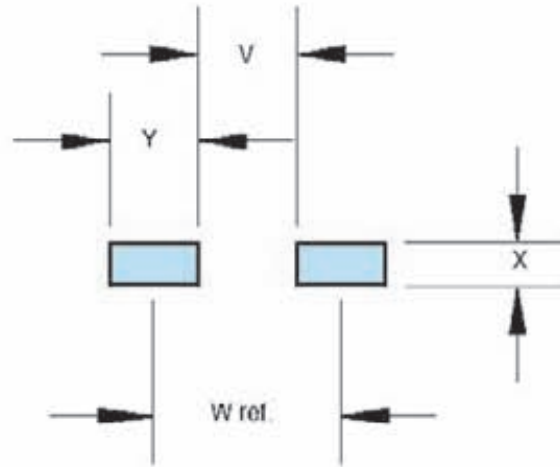
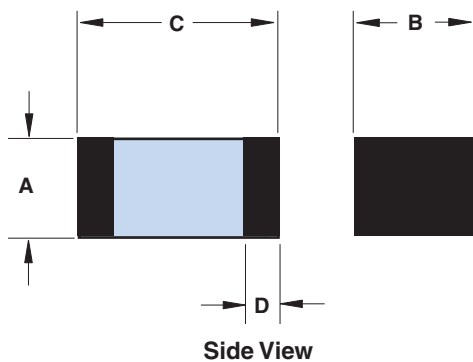

Dimensions (Bold numbers are in millimeters, light numbers are in inches.)

Pkg. Size	Dimensions					Land Patterns				Tape Width mm	Pitch mm	Parts per Reel	
	A	B	C	D	Wt(g)	V	W ref	X	Y			7"	13"
0402 (1005)	0.5±0.1 .020	0.5±0.1 .020	1.0±0.1 .040	0.25±0.15 .010	0.002	0.40 .016	1.30 .051	0.70 .028	0.90 .035	8	4	10,000	N/A
0603 (1608)	0.8±0.15 .031	0.8±0.15 .031	1.6±0.15 .063	0.4±0.2 .016	0.006	0.60 .024	1.70 .067	1.00 .039	1.10 .043	8	4	4,000	10,000
0805 (2012)	See Part Table	1.25±0.2 .049	2.0±0.2 .079	0.5±0.3 .020	0.01	0.60 .024	1.90 .075	1.50 .059	1.30 .051	8	4	4,000	10,000
1206 (3216)	1.1±0.3 .043	1.6±0.2 .063	3.2±0.2 .126	0.7±0.3 .028	0.03	1.20 .047	2.80 .110	1.80 .071	1.60 .063	8	4	3,000	10,000

Fair-Rite Products Corp.

PO Box J, One Commercial Row, Wallkill, NY 12589-0288

Phone: (888) FAIR RITE / (845) 895-2055 • FAX: (888) FERRITE / (845) 895-2629 • www.fair-rite.com
 (888) 324-7748 (888) 337-7483 • E-Mail: ferrites@fair-rite.com

Chip Inductors (Ferrite)

Package Size - 0603

Part Number	Inductance (μH)	Tolerance	Q Min	Test Frequency L, Q (MHz)	Self Resonant Frequency (Min MHz)	DCR (Ohm) Max	Rated Current (mA Max)
22060347NM7F	0.047	± 20%	10	50	260	0.30	50
22060368NM7F	0.068	± 20%	10	50	250	0.30	50
22060382NM7F	0.082	± 20%	10	50	245	0.30	50
220603R10K7F	0.10	± 10%	15	25	240	0.50	50
220603R12K7F	0.12	± 10%	15	25	205	0.50	50
220603R15K7F	0.15	± 10%	15	25	180	0.60	50
220603R18K7F	0.18	± 10%	15	25	165	0.60	50
220603R22K7F	0.22	± 10%	15	25	150	0.80	50
220603R27K7F	0.27	± 10%	15	25	136	0.80	50
220603R33K7F	0.33	± 10%	15	25	125	0.85	35
220603R39K7F	0.39	± 10%	15	25	110	1.00	35
220603R47K7F	0.47	± 10%	15	25	105	1.35	35
220603R56K7F	0.56	± 10%	15	25	95	1.55	35
220603R68K7F	0.68	± 10%	15	25	90	1.70	35
220603R82K7F	0.82	± 10%	15	25	85	2.10	35
2206031R0K7F	1.0	± 10%	35	10	75	0.60	25
2206031R2K7F	1.2	± 10%	35	10	65	0.80	25
2206031R5K7F	1.5	± 10%	35	10	60	0.80	25
2206031R8K7F	1.8	± 10%	35	10	55	0.95	25
2206032R2K7F	2.2	± 10%	35	10	50	1.15	15
2206032R7K7F	2.7	± 10%	35	10	45	1.35	15
2206033R3K7F	3.3	± 10%	35	10	40	1.55	15
2206033R9K7F	3.9	± 10%	35	10	35	1.70	15
2206034R7K7F	4.7	± 10%	35	10	33	2.10	15
2206035R6K7F	5.6	± 10%	35	4	22	1.55	5
2206036R8K7F	6.8	± 10%	35	4	20	1.70	5
2206038R2K7F	8.2	± 10%	35	4	18	2.10	5
22060310RK7F	10	± 10%	30	2	17	1.85	3
22060312RK7F	12	± 10%	30	2	15	2.10	3
22060315RK7F	15	± 10%	20	1	14	1.70	1

Fair-Rite Products Corp.

PO Box J, One Commercial Row, Wallkill, NY 12589-0288

Phone: (888) FAIR RITE / (845) 895-2055 • FAX: (888) FERRITE / (845) 895-2629
(888) 324-7748

• www.fair-rite.com
• E-Mail: ferrites@fair-rite.com

Chip Inductors (Ferrite)

Package Size - 0805

Part Number	Inductance (μH)	Tolerance	Q Min	Test Frequency L, Q (MHz)	Self Resonant Frequency (Min MHz)	DCR (Ohm) Max	Rated Current (mA Max)	A dim (mm)
22080547NM7F	0.047	± 20%	15	50	320	0.20	300	0.85±0.2 (.033")
22080568NM7F	0.068	± 20%	15	50	280	0.20	300	0.85±0.2 (.033")
22080582NM7F	0.082	± 20%	15	50	255	0.20	300	0.85±0.2 (.033")
220805R10K7F	0.10	± 10%	20	25	235	0.30	250	0.85±0.2 (.033")
220805R12K7F	0.12	± 10%	20	25	220	0.30	250	0.85±0.2 (.033")
220805R15K7F	0.15	± 10%	20	25	200	0.40	250	0.85±0.2 (.033")
220805R18K7F	0.18	± 10%	20	25	185	0.40	250	0.85±0.2 (.033")
220805R22K7F	0.22	± 10%	20	25	170	0.50	250	0.85±0.2 (.033")
220805R27K7F	0.27	± 10%	20	25	150	0.50	250	0.85±0.2 (.033")
220805R33K7F	0.33	± 10%	20	25	145	0.55	250	0.85±0.2 (.033")
220805R39K7F	0.39	± 10%	25	25	135	0.65	200	0.85±0.2 (.033")
220805R47K7F	0.47	± 10%	25	25	125	0.65	200	0.85±0.2 (.033")
220805R56K7F	0.56	± 10%	25	25	115	0.75	150	0.85±0.2 (.033")
220805R68K7F	0.68	± 10%	25	25	105	0.80	150	0.85±0.2 (.033")
220805R82K7F	0.82	± 10%	25	25	100	1.00	150	0.85±0.2 (.033")
2208051R0K7F	1.0	± 10%	45	10	75	0.40	50	0.85±0.2 (.033")
2208051R2K7F	1.2	± 10%	45	10	65	0.50	50	0.85±0.2 (.033")
2208051R5K7F	1.5	± 10%	45	10	60	0.50	50	0.85±0.2 (.033")
2208051R8K7F	1.8	± 10%	45	10	55	0.60	50	0.85±0.2 (.033")
2208052R2K7F	2.2	± 10%	45	10	50	0.65	30	0.85±0.2 (.033")
2208052R7K7F	2.7	± 10%	45	10	45	0.75	30	1.25±0.2 (.049")
2208053R3K7F	3.3	± 10%	45	10	41	0.80	30	1.25±0.2 (.049")
2208053R9K7F	3.9	± 10%	45	10	38	0.90	30	1.25±0.2 (.049")
2208054R7K7F	4.7	± 10%	45	10	35	1.00	30	1.25±0.2 (.049")
2208055R6K7F	5.6	± 10%	50	4	32	0.90	15	1.25±0.2 (.049")
2208056R8K7F	6.8	± 10%	50	4	29	1.00	15	1.25±0.2 (.049")
2208058R2K7F	8.2	± 10%	50	4	26	1.10	15	1.25±0.2 (.049")
22080510RK7F	10	± 10%	50	2	24	1.15	15	1.25±0.2 (.049")
22080512RK7F	12	± 10%	50	2	22	1.25	15	1.25±0.2 (.049")
22080515RK7F	15	± 10%	30	1	19	0.80	5	1.25±0.2 (.049")
22080518RK7F	18	± 10%	30	1	18	0.90	5	1.25±0.2 (.049")
22080522RK7F	22	± 10%	30	1	16	1.10	5	1.25±0.2 (.049")
22080527RK7F	27	± 10%	30	1	14	1.15	5	1.25±0.2 (.049")
22080533RK7F	33	± 10%	30	0.4	13	1.25	5	1.25±0.2 (.049")
22080539RK7F	39	± 10%	35	2	8	2.90	4	1.25±0.2 (.049")
22080547RM7F	47	± 20%	35	2	7.5	3.00	4	1.25±0.2 (.049")

Fair-Rite Products Corp.

PO Box J, One Commercial Row, Wallkill, NY 12589-0288

Phone: (888) FAIR RITE / (845) 895-2055 • FAX: (888) FERRITE / (845) 895-2629
(888) 324-7748 (888) 337-7483

• www.fair-rite.com
• E-Mail: ferrites@fair-rite.com

Chip Inductors (Ferrite)

Package Size - 1206

Part Number	Inductance (μH)	Tolerance	Q Min	Test Frequency L, Q (MHz)	Self Resonant Frequency (Min MHz)	DCR (Ohm) Max	Rated Current (mA Max)
22120647NM7F	0.047	± 20%	20	50	320	0.15	300
22120668NM7F	0.068	± 20%	20	50	280	0.25	300
22120682NM7F	0.082	± 20%	20	50	255	0.25	300
221206R10K7F	0.10	± 10%	20	25	235	0.25	250
221206R12K7F	0.12	± 10%	20	25	220	0.30	250
221206R15K7F	0.15	± 10%	20	25	200	0.30	250
221206R18K7F	0.18	± 10%	20	25	185	0.40	250
221206R22K7F	0.22	± 10%	20	25	170	0.40	250
221206R27K7F	0.27	± 10%	20	25	150	0.50	250
221206R33K7F	0.33	± 10%	20	25	145	0.60	250
221206R39K7F	0.39	± 10%	25	25	135	0.50	200
221206R47K7F	0.47	± 10%	25	25	125	0.60	200
221206R56K7F	0.56	± 10%	25	25	115	0.70	150
221206R68K7F	0.68	± 10%	25	25	105	0.80	150
221206R82K7F	0.82	± 10%	25	25	100	0.90	150
2212061R0K7F	1.0	± 10%	45	10	75	0.40	100
2212061R2K7F	1.2	± 10%	45	10	65	0.50	100
2212061R5K7F	1.5	± 10%	45	10	60	0.50	50
2212061R8K7F	1.8	± 10%	45	10	55	0.50	50
2212062R2K7F	2.2	± 10%	45	10	50	0.60	50
2212062R7K7F	2.7	± 10%	45	10	45	0.60	50
2212063R3K7F	3.3	± 10%	45	10	41	0.70	50
2212063R9K7F	3.9	± 10%	45	10	38	0.80	50
2212064R7K7F	4.7	± 10%	45	10	35	0.90	50
2212065R6K7F	5.6	± 10%	50	4	32	0.70	25
2212066R8K7F	6.8	± 10%	50	4	29	0.80	25
2212068R2K7F	8.2	± 10%	50	4	26	0.90	25
22120610RK7F	10	± 10%	35	2	24	1.00	25
22120612RK7F	12	± 10%	50	2	22	1.05	15
22120615RK7F	15	± 10%	35	1	19	0.70	5
22120618RK7F	18	± 10%	35	1	18	0.70	5
22120622RK7F	22	± 10%	35	1	16	0.90	5
22120627RK7F	27	± 10%	35	1	14	0.90	5
22120633RK7F	33	± 10%	35	0.4	13	1.05	5
22120639RK7F	39	± 10%	40	2	11	3.00	10
22120647RK7F	47	± 10%	40	2	10	3.40	10

Fair-Rite Products Corp.

PO Box J, One Commercial Row, Wallkill, NY 12589-0288

Phone: (888) FAIR RITE / (845) 895-2055 • FAX: (888) FERRITE / (845) 895-2629
(888) 324-7748

• www.fair-rite.com
• E-Mail: ferrites@fair-rite.com

(888) 337-7483

Chip Inductors (Ceramic)

Package Size - 0402

Part Number	Inductance (nH)	Tolerance	Q Min	Test Frequency L, Q (MHz)	Self Resonant Frequency (Min MHz)	DCR (Ohm) Max	Rated Current (mA Max)
2204021N0S7C	1.0	± 0.3 nH	8	100	4000	0.12	300
2204021N2S7C	1.2	± 0.3 nH	8	100	4000	0.12	300
2204021N5S7C	1.5	± 0.3 nH	8	100	4000	0.13	300
2204021N8S7C	1.8	± 0.3 nH	8	100	4000	0.14	300
2204022N2S7C	2.2	± 0.3 nH	8	100	4000	0.16	300
2204022N7S7C	2.7	± 0.3 nH	8	100	4000	0.17	300
2204023N3S7C	3.3	± 0.3 nH	8	100	4000	0.19	300
2204023N9S7C	3.9	± 0.3 nH	8	100	4000	0.22	300
2204024N7S7C	4.7	± 0.3 nH	8	100	4000	0.24	300
2204025N6S7C	5.6	± 0.3 nH	8	100	4000	0.27	300
2204026N8J7C	6.8	± 5%	8	100	3900	0.32	300
2204028N2J7C	8.2	± 5%	8	100	3600	0.37	250
22040210NJ7C	10	± 5%	8	100	3200	0.42	250
22040212NJ7C	12	± 5%	8	100	2700	0.50	250
22040215NJ7C	15	± 5%	8	100	2300	0.55	250
22040218NJ7C	18	± 5%	8	100	2100	0.65	200
22040222NJ7C	22	± 5%	8	100	1900	0.80	200
22040227NJ7C	27	± 5%	8	100	1600	0.90	200

Fair-Rite Products Corp.

PO Box J, One Commercial Row, Wallkill, NY 12589-0288

Phone: (888) FAIR RITE / (845) 895-2055 • FAX: (888) FERRITE / (845) 895-2629 • www.fair-rite.com
 (888) 324-7748 (888) 337-7483 • E-Mail: ferrites@fair-rite.com

Chip Inductors (Ceramic)

Package Size - 0603

Part Number	Inductance (nH)	Tolerance	Q Min	Test Frequency L, Q (MHz)	Self Resonant Frequency (Min MHz)	DCR (Ohm) Max	Rated Current (mA Max)
2206031N0S7C	1.0	± 0.3 nH	8	100	4000	0.10	300
2206031N2S7C	1.2	± 0.3 nH	8	100	4000	0.10	300
2206031N5S7C	1.5	± 0.3 nH	8	100	4000	0.10	300
2206031N8S7C	1.8	± 0.3 nH	8	100	4000	0.10	300
2206032N2S7C	2.2	± 0.3 nH	8	100	4000	0.10	300
2206032N7S7C	2.7	± 0.3 nH	10	100	4000	0.10	300
2206033N3S7C	3.3	± 0.3 nH	10	100	4000	0.12	300
2206033N9S7C	3.9	± 0.3 nH	10	100	4000	0.14	300
2206034N7S7C	4.7	± 0.3 nH	10	100	4000	0.16	300
2206035N6S7C	5.6	± 0.3 nH	10	100	4000	0.18	300
2206036N8J7C	6.8	± 5%	10	100	4000	0.22	300
2206038N2J7C	8.2	± 5%	10	100	4000	0.24	300
22060310NJ7C	10	± 5%	12	100	3000	0.26	300
22060312NJ7C	12	± 5%	12	100	3000	0.28	300
22060315NJ7C	15	± 5%	12	100	2000	0.32	300
22060318NJ7C	18	± 5%	12	100	2000	0.35	300
22060322NJ7C	22	± 5%	12	100	2000	0.40	300
22060327NJ7C	27	± 5%	12	100	1000	0.45	300
22060333NJ7C	33	± 5%	12	100	1000	0.55	300
22060339NJ7C	39	± 5%	12	100	1000	0.60	300
22060347NJ7C	47	± 5%	12	100	1000	0.70	300
22060356NJ7C	56	± 5%	12	100	1000	0.75	300
22060368NJ7C	68	± 5%	12	100	1000	0.85	300
22060382NJ7C	82	± 5%	12	100	1000	0.95	300
220603R10J7C	100	± 5%	12	100	1000	1.00	300
220603R12J7C	120	± 5%	8	50	800	1.20	300
220603R15J7C	150	± 5%	8	50	800	1.20	300
220603R18J7C	180	± 5%	8	50	700	1.30	300
220603R22J7C	220	± 5%	8	50	600	1.30	300

Fair-Rite Products Corp.

PO Box J, One Commercial Row, Wallkill, NY 12589-0288

Phone: (888) FAIR RITE / (845) 895-2055 • FAX: (888) FERRITE / (845) 895-2629
(888) 324-7748

• www.fair-rite.com
• E-Mail: ferrites@fair-rite.com

(888) 337-7483

Engineering Kits

Expanded Cable & Suppressor Kit

Part Number 0199000005

This is our most popular engineering kit. As the name implies, this kit contains a broad sampling of suppression cores to reduce conducted EMI over wires and cables.

Chip Bead Kit

Part Number 0199000018

The chip bead kit has a number of different EIA size chip components with a range of impedance values and signal speeds. Also one of our chip arrays is included in this kit. Parts are RoHS compliant.

Shield Bead Kit

Part Number 0199000019

The shield bead kit has 28 different beads in three suppression materials, 73, 43, and 61.

Antenna/RFID Kit

Part Number 0199000024

The kit contains a range of rods in three low losses, high Q, materials, 78, 61 and 67, to cover frequencies from 10 kHz to 50 MHz.

Surface Mount Bead Kit

Part Number 0199000025

An assortment of surface mount beads for differential and common-mode applications in 73 material for < 50 MHz, 43/44 material for 25-300 MHz and 52/61 material for 250-1000 MHz frequencies. Parts are RoHS compliant.

Wound Bead Kit

Part Number 0199000027

The wound bead kit has twelve wound beads in two suppression materials, 44 and 61, wound in several winding configurations. Parts are RoHS compliant.

Bead-On-Lead Kit

Part Number 0199000028

This bead-on-lead kit has three parts each in three materials, 73, 43 and 61, for through hole applications. Parts are RoHS compliant.

Fair-Rite Products Corp.

PO Box J, One Commercial Row, Wallkill, NY 12589-0288

Phone: (888) FAIR RITE / (845) 895-2055 • FAX: (888) FERRITE / (845) 895-2629
(888) 324-7748 (888) 337-7483

• www.fair-rite.com
• E-Mail: ferrites@fair-rite.com

Engineering Kits

Rod Kit (52 Matl)

Part Number 0199000029

A new rod kit in the new 52 material. Samples of seven sizes intended for open circuit applications that require a ferrite material with high saturation and Curie temperature.

31 Snap-It Kit

Part Number 0199000030

This 31 material snap-it kit has a range parts for different cable diameters. Suggested operating frequency 1-300 MHz.

43 Snap-It Kit

Part Number 0199000031

Snap-it assemblies suitable for the 25-300 MHz frequency range. Can accommodate cable diameters from .250 to .590 inches.

46 Core and Snap-It Kit

Part Number 0199000032

This kit has a selection of cable cores and snap-its in our new economical 46 material. This material has similar performance as our 43/44 grade materials over the 25-300 MHz frequency range.

61 Snap-It Kit

Part Number 0199000033

Our recommendation for suppressing conducted EMI in 200-1000 MHz is the 61 material. This kit has a selection of 61 snap-its.

Chip Inductor Kit

Part Number 0199000035

The chip inductor kit has several EIA sizes in both ferrite and ceramic chip inductors. Parts are RoHS compliant.

Multi-Aperture Core Kit

Part Number 0199000036

Kit contains several sizes in four materials, 73, 43, 61 and 67. This allows experimentation from a few kHz into the 50-100 MHz range.

Fair-Rite Products Corp.

PO Box J, One Commercial Row, Wallkill, NY 12589-0288

Phone: (888) FAIR RITE / (845) 895-2055 • FAX: (888) FERRITE / (845) 895-2629
(888) 324-7748 (888) 337-7483

• www.fair-rite.com
• E-Mail: ferrites@fair-rite.com

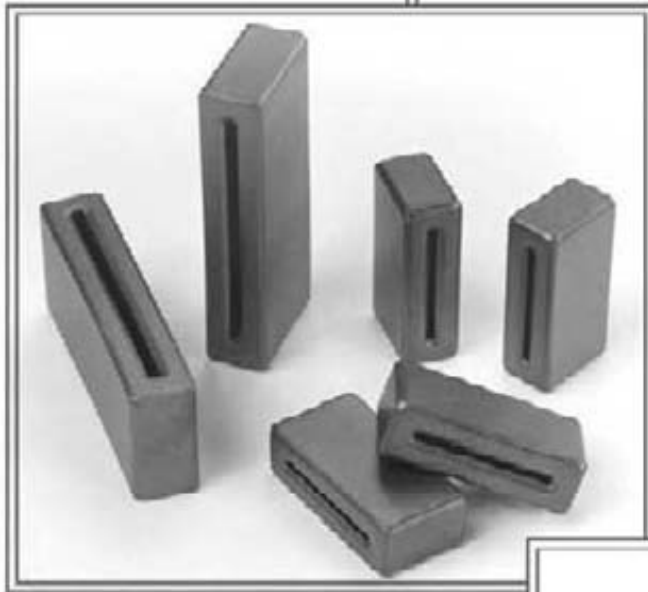

Cable Components



Fair-Rite Products Corp.

PO Box J, One Commercial Row, Wallkill, NY 12589-0288

Phone: (888) FAIR RITE / (845) 895-2055 • FAX: (888) 324-7748

(888) FERRITE / (845) 895-2629 • (888) 337-7483

• www.fair-rite.com
• E-Mail: ferrites@fair-rite.com

Round Cable EMI Suppression Cores

Listed by frequency range and in ascending order of "B" dimension.

Fair-Rite offers a broad selection of ferrite EMI suppression cable cores in several materials with guaranteed minimum impedance specifications.

. All cable cores have been burnished to remove the sharp edges.

. The column "H" (Oe) gives for each cable core the calculated dc bias field in oersted for 1 turn and 1 ampere direct current. The actual dc H field in the application, is this value of "H" times the actual NI (ampere-turns) product. For the effect of the dc bias on the impedance of the core material, see the material graphs on pages 145-146, Figures 18-23.

. Suppression cable cores are controlled for impedances only. The impedances listed are typical values. Minimum impedance values are specified for the + marked frequencies. The minimum guaranteed impedance is the listed impedance less 20%.

. Single turn impedance tests for 31, 43 and 46 material cores are performed on the 4193A Vector Impedance Meter. The 61 material parts are tested on the 4191A RF Impedance Analyzer. **Cores are tested with the shortest practical wire length.**

. Performance curves of all listed cable suppression cores are compiled on the Fair-Rite Products CD-ROM.

. For smaller suppression parts, refer to the section "EMI Suppression Beads" on pages 29-33.

. For any cable suppression core not listed here, feel free to contact our customer service group for availability and pricing.

. Our "Expanded Cable and Connector EMI Suppression Kit" (part number 0199000005) contains a selection of these suppression cores. See page 67.

. Explanation of Part Numbers: Digits 1&2 = product class, 3&4 material grade and last digit 2 = burnished.

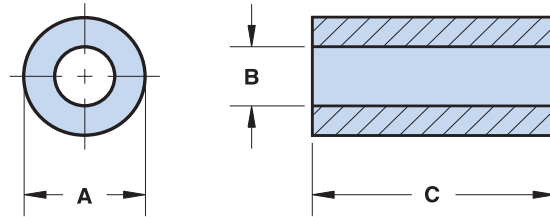

Lower & Broadband Frequencies 1-300 MHz (31 material)

Dimensions (Bold numbers are in millimeters, light numbers are nominal in inches.)

Part Number	A	B	C*	Wt (g)	H (Oe)	Typical Impedance (Ω)					
						1 MHz	5 MHz	10 MHz ⁺	25 MHz ⁺	100 MHz ⁺	250 MHz
2631250202	6.35±0.15 .250	2.95±0.45 .125	25.4±0.75 1.000	2.9	.52	27	70	90	138	230	240
2631023002	9.5±0.25 .375	4.75±0.3 .193	19.05±0.7 .750	4.7	.52	19	49	62	95	160	185
2631480102	12.3±0.4 .485	4.95±0.25 .200	12.7±0.4 .500	6.0	.52	18	45	58	88	140	167
2631480002	12.3±0.4 .485	4.95±0.25 .200	25.4±0.75 1.000	12	.52	34	88	115	175	295	267
2631540202	14.3±0.45 .562	6.35±0.25 .250	13.8 - 0.7 .530	8.3	.43	17	44	58	88	140	160
2631540002	14.3±0.45 .562	6.35±0.25 .250	28.6±0.75 1.125	17.7	.43	35	91	119	181	300	280
2631625002	16.25 - 0.75 .625	7.9±0.25 .312	14.3±0.35 .562	10.3	.36	16	40	53	75	130	150
2631625102	16.25 - 0.75 .625	7.9±0.25 .312	28.6±0.75 1.125	20.5	.36	30	79	103	156	260	268
2631665802	17.45±0.4 .687	9.5±0.25 .375	12.7±0.5 .500	10.3	.32	13	31	38	60	115	137
2631665702	17.45±0.4 .687	9.5±0.25 .375	28.6±0.75 1.125	23.1	.32	27	69	89	138	225	265

* This dimension may be modified to suit specific applications.

⁺ Test frequency

Fair-Rite Products Corp.

PO Box J, One Commercial Row, Wallkill, NY 12589-0288

Phone: (888) FAIR RITE / (845) 895-2055 • FAX: (888) FERRITE / (845) 895-2629
(888) 324-7748 (888) 337-7483

• www.fair-rite.com
• E-Mail: ferrites@fair-rite.com

Round Cable EMI Suppression Cores

Listed by frequency range and in ascending order of "B" dimension.

Lower & Broadband Frequencies 1-300 MHz (31 material)

Dimensions (Bold numbers are in millimeters, light numbers are nominal in inches.)

Part Number	A	B	C*	Wt (g)	H (Oe)	Typical Impedance (Ω)					
						1 MHz	5 MHz	10 MHz ⁺	25 MHz ⁺	100 MHz ⁺	250 MHz
2631626302	18.7±0.5 .735	10.15±0.25 .400	14.65 - 0.75 .562	13.3	.29	14	35	44	69	115	140
2631626402	18.7±0.5 .735	10.15±0.25 .400	28.6±0.75 1.125	26.6	.29	27	69	89	138	225	235
2631102002	25.9±0.75 1.020	12.8±0.25 .505	28.6±0.8 1.125	55	.22	31	79	103	156	260	280
2631101902	28.5±0.6 1.122	13.8±0.3 .543	28.6±0.8 1.125	68	.21	32	82	106	163	270	300
2631801202	29.0±0.75 1.142	19.0±0.5 .748	13.85±0.4 .545	25	.17	10	24	31	49	88	130
2631103002	31.1±0.85 1.225	19.05±0.6 .750	50.8±1.0 2.000	116	.17	37	98	120	205	340	315
2631626202	50.8±1.3 2.000	25.4±0.8 1.000	38.1±0.75 1.500	278	.11	40	103	140	215	365	290
2631803802	61.0±1.3 2.400	35.55±0.85 1.400	12.7±0.5 .500	118	.09	12	28	40	63	119	215

Broadband Frequencies 25-300 MHz (43 material)

Part Number	A	B	C*	Wt (g)	H (Oe)	Typical Impedance (Ω)			
						10 MHz	25 MHz ⁺	100 MHz ⁺	250 MHz
2643480102	12.3±0.4 .485	4.95±0.25 .200	12.7±0.4 .500	6.0	.52	52	84	121	145
2643480002	12.3±0.4 .485	4.95±0.25 .200	25.4±0.75 1.000	12	.52	102	165	236	233
2643540702	14.3±0.45 .562	6.35±0.25 .250	5.3 - 0.45 .200	3.1	.43	20	30	50	68
2643540102	14.3±0.45 .562	6.35±0.25 .250	10.15±0.4 .400	6.3	.43	39	61	89	104
2643540202	14.3±0.45 .562	6.35±0.25 .250	13.8 - 0.7 .530	8.3	.43	51	78	118	140
2643540002	14.3±0.45 .562	6.35±0.25 .250	28.6±0.75 1.125	17.7	.43	105	171	250	255
2643540302	14.3±0.45 .562	7.1±0.25 .280	15.25±0.4 .600	8.9	.41	50	75	118	137
2643800302	12.7±0.25 .500	7.15±0.2 .282	4.9 - 0.25 .188	2.0	.43	15	26	42	59
2643540402	14.3±0.45 .562	7.25±0.2 .286	28.6±0.75 1.125	16	.40	88	143	215	230
2643801102	12.7±0.25 .500	7.9±0.2 .312	6.35±0.2 .250	2.4	.40	16	26	41	59
2643801902	12.7±0.25 .500	7.9±0.2 .312	12.7±0.4 .500	4.7	.40	29	44	73	91

* This dimension may be modified to suit specific applications.

⁺ Test frequency

Fair-Rite Products Corp.

PO Box J, One Commercial Row, Wallkill, NY 12589-0288

Phone: (888) FAIR RITE / (845) 895-2055 • FAX: (888) FERRITE / (845) 895-2629 • www.fair-rite.com
(888) 324-7748 (888) 337-7483 • E-Mail: ferrites@fair-rite.com

Round Cable EMI Suppression Cores

Listed by frequency range and in ascending order of "B" dimension.

Broadband Frequencies 25-300 MHz (43 material)

Dimensions (Bold numbers are in millimeters, light numbers are nominal in inches.)

Part Number	A	B	C*	Wt (g)	H (Oe)	Typical Impedance (Ω)			
						10 MHz	25 MHz ⁺	100 MHz ⁺	250 MHz
2643625002	16.25 - 0.75 .625	7.9±0.25 .312	14.3±0.35 .562	10.3	.36	45	70	113	135
2643625102	16.25 - 0.75 .625	7.9±0.25 .312	28.6±0.75 1.125	20.5	.36	90	130	213	305
2643625202	15.9±0.4 .625	7.9±0.3 .312	50.8±1.0 2.000	36	.36	158	235	384	373
2643665902	17.45±0.4 .687	9.5±0.25 .375	6.35±0.25 .250	5.1	.32	19	26	44	62
2643665802	17.45±0.4 .687	9.5±0.25 .375	12.7±0.5 .500	10.3	.32	35	55	88	108
2643665702	17.45±0.4 .687	9.5±0.25 .375	28.6±0.75 1.125	23.1	.32	78	125	200	255
2643626302	18.7±0.5 .735	10.15±0.25 .400	14.65 - 0.75 .562	13.3	.29	41	63	96	123
2643626402	18.7±0.5 .735	10.15±0.25 .400	28.6±0.75 1.125	26.6	.29	79	128	196	220
2643626502	18.7±0.6 .735	10.15±0.4 .400	50.8±1.0 2.000	47	.29	138	225	348	405
2643801502	25.4±0.65 1.000	12.7±0.35 .500	6.35±0.25 .250	11.6	.23	22	34	53	87
2643102402	25.9±0.75 1.020	12.8±0.25 .505	21.3±0.5 .840	41	.22	68	110	183	230
2643102002	25.9±0.75 1.020	12.8±0.25 .505	28.6±0.8 1.125	55	.22	91	145	235	275
2643800602	20.95±0.4 .825	13.2±0.3 .520	6.35±0.2 .250	6.3	.24	16	24	44	67
2643800502	20.95±0.4 .825	13.2±0.3 .520	11.9±0.4 .468	11.9	.24	27	45	82	115
2643801802	22.1±0.4 .870	13.7±0.3 .540	6.35±0.2 .250	7.2	.23	15	25	45	70
2643101902	28.5±0.6 1.122	13.8±0.3 .543	28.6±0.8 1.125	67	.21	93	145	230	290
2643801402	25.4±0.6 1.000	15.5±0.5 .610	8.1±0.3 .320	12.4	.20	20	35	55	95
2643806402	25.4±0.6 1.000	15.5±0.5 .610	12.7±0.4 .500	19.4	.20	30	53	90	130
2643251002	39.1±0.75 1.540	16.75±0.5 .660	22.2±0.8 .875	104	.16	85	135	230	325
2643801002	29.0±0.75 1.142	19.0±0.5 .748	7.5±0.25 .295	13.6	.17	17	28	47	80
2643801202	29.0±0.75 1.142	19.0±0.5 .748	13.85±0.4 .545	25.1	.17	28	51	92	142
2643103102	29.0±0.75 1.142	19.0±0.5 .748	38.1±0.75 1.500	69	.17	87	130	200	250

* This dimension may be modified to suit specific applications.

⁺ Test frequency

Fair-Rite Products Corp.

PO Box J, One Commercial Row, Wallkill, NY 12589-0288

Phone: (888) FAIR RITE / (845) 895-2055 • FAX: (888) FERRITE / (845) 895-2629 • www.fair-rite.com
(888) 324-7748 (888) 337-7483 • E-Mail: ferrites@fair-rite.com

Round Cable EMI Suppression Cores

Listed by frequency range and in ascending order of "B" dimension.

Broadband Frequencies 25-300 MHz (43 material)

Dimensions (Bold numbers are in millimeters, light numbers are nominal in inches.)

Part Number	A	B	C*	Wt (g)	H (Oe)	Typical Impedance (Ω)			
						10 MHz	25 MHz ⁺	100 MHz ⁺	250 MHz
2643804502	31.1±0.75 1.225	19.05±0.5 .750	16.3 - 0.75 .627	36	.17	37	60	100	153
2643103002	31.1±0.85 1.225	19.05±0.6 .750	50.8 ± 1.0 2.000	116	.17	105	195	330	310
2643802702	35.55±0.75 1.400	22.85±0.5 .900	12.7±0.5 .500	36	.14	28	48	80	135
2643626102	50.8±1.0 2.000	25.4±0.5 1.000	25.4±0.75 1.000	190	.11	80	128	224	310
2643625902	50.8±1.0 2.000	25.4±0.5 1.000	28.7±0.75 1.130	215	.11	90	145	254	373
2643626202	50.8±1.3 2.000	25.4±0.8 1.000	38.1±0.75 1.500	285	.11	118	193	336	280
2643626002	50.8±1.3 2.000	25.4±0.8 1.000	50.8±1.0 2.000	380	.11	157	240	360	257
2643803802	61.0±1.3 2.400	35.55±0.85 1.400	12.7±0.5 .500	118	.09	33	58	108	218

Broadband Frequencies 25-300 MHz (Economical 46 material)

Part Number	A	B	C*	Wt (g)	H (Oe)	Typical Impedance (Ω)			
						10 MHz	25 MHz	100 MHz ⁺	250 MHz
2646480102	12.3±0.4 .485	4.95±0.25 .200	12.7±0.4 .500	6.0	.52	42	62	110	145
2646480002	12.3±0.4 .485	4.95±0.25 .200	25.4±0.75 1.000	12	.52	83	125	212	233
2646540202	14.3±0.45 .562	6.35±0.25 .250	13.8 - 0.7 .530	8.3	.43	45	66	106	127
2646540002	14.3±0.45 .562	6.35±0.25 .250	28.6±0.75 1.125	17.7	.43	89	134	225	253
2646625002	16.25 - 0.75 .625	7.9±0.25 .312	14.3±0.35 .562	10.3	.36	44	63	102	135
2646625102	16.25 - 0.75 .625	7.9±0.25 .312	28.6±0.75 1.125	20.5	.36	78	115	192	235
2646625202	15.9±0.4 .625	7.9±0.3 .312	50.8±1.0 2.000	36	.36	138	204	345	270
2646665802	17.45±0.4 .687	9.5±0.25 .375	12.7±0.5 .500	10.3	.32	32	49	79	110
2646665702	17.45±0.4 .687	9.5±0.25 .375	28.6±0.75 1.125	23.1	.32	72	106	180	225
2646102402	25.9±0.75 1.020	12.8±0.25 .505	21.3±0.5 .840	41	.22	67	100	165	218
2646102002	25.9±0.75 1.020	12.8±0.25 .505	28.6±0.8 1.125	55	.22	74	118	212	268
2646101902	28.5±0.6 1.122	13.8±0.3 .543	28.6±0.8 1.125	67	.21	80	121	207	285

* This dimension may be modified to suit specific applications.

⁺ Test frequency

Fair-Rite Products Corp.

PO Box J, One Commercial Row, Wallkill, NY 12589-0288

Phone: (888) FAIR RITE / (845) 895-2055 • FAX: (888) FERRITE / (845) 895-2629
(888) 324-7748 (888) 337-7483

• www.fair-rite.com
• E-Mail: ferrites@fair-rite.com

Round Cable EMI Suppression Cores

Listed by frequency range and in ascending order of "B" dimension.

Broadband Frequencies 25-300 MHz (Economical 46 material)

Dimensions (Bold numbers are in millimeters, light numbers are nominal in inches.)

Part Number	A	B	C*	Wt (g)	H (Oe)	Typical Impedance (Ω)			
						10 MHz	25 MHz	100 MHz ⁺	250 MHz
2646804502	31.1±0.75 1.225	19.05±0.5 .750	16.3 - 0.75 .627	36	.17	33	49	90	150
2646103002	31.1±0.85 1.225	19.05±0.6 .750	50.8 ± 1.0 2.000	116	.17	95	155	297	310
2646626202	50.8±1.3 2.000	25.4±0.8 1.000	38.1±0.75 1.500	285	.11	102	165	302	280
2646803802	61.0±1.3 2.400	35.55±0.85 1.400	12.7±0.5 .500	118	.09	30	44	100	200

Higher Frequencies 200-1000 MHz (61 material)

Part Number	A	B	C*	Wt (g)	H (Oe)	Typical Impedance(Ω)			
						100 MHz	250 MHz ⁺	500 MHz ⁺	1000 MHz
2661480002	12.3±0.4 .485	4.95±0.25 .200	25.4±0.75 1.000	12	.52	???	???	???	???
2661540202	14.3±0.45 .562	6.35±0.25 .250	13.8 - 0.7 .530	8.3	.43	100	145	185	260
2661540002	14.3±0.45 .562	6.35±0.25 .250	28.6±0.75 1.125	17.7	.43	205	295	370	350
2661801902	12.7±0.25 .500	7.9±0.25 .312	12.7± 0.4 .500	4.7	.40	45	70	105	175
2661665802	17.45±0.4 .687	9.5±0.25 .375	12.7±0.5 .500	10.3	.32	85	125	160	205
2661665702	17.45±0.4 .687	9.5±0.25 .375	28.6±0.75 1.125	23.1	.32	190	280	360	450
2661626302	19.0 - 0.65 .735	10.15±0.25 .400	14.65 - 0.75 .562	13.3	.29	90	135	180	235
2661626402	19.0 - 0.65 .735	10.15±0.25 .400	28.6±0.75 1.125	26.6	.29	185	250	370	460
2661102402	25.9±0.75 1.020	12.8±0.25 .505	21.3±0.5 .840	41	.22	125	200	310	550
2661102002	25.9±0.75 1.020	12.8±0.25 .505	28.6±0.8 1.125	55	.22	190	300	380	400

* This dimension may be modified to suit specific applications.

⁺ Test frequency

Fair-Rite Products Corp.

PO Box J, One Commercial Row, Wallkill, NY 12589-0288

Phone: (888) FAIR RITE / (845) 895-2055 • FAX: (888) FERRITE / (845) 895-2629
(888) 324-7748

• www.fair-rite.com
• E-Mail: ferrites@fair-rite.com

(888) 337 -7483

Round Cable Snap-its

Listed by frequency range and in ascending order of cable diameter.

Round cable snap-its can easily accommodate round cables or bundled wires with diameters from 2.5 mm (.100") to 25.4 mm (1.000"). These assemblies are available in four ferrite material grades to suppress differential or common-mode conducted EMI from 1 MHz into the GHz region.

The polypropylene cases are meeting the RoHS restrictions of hazardous substances and have a flammability rating of UL 94-VO.

- Round cable snap-it assemblies are controlled for impedances only. The impedances listed are typical values. Minimum impedance values are specified for the + marked frequencies. The minimum guaranteed impedance is the listed impedance less 20%.
- Single turn impedance tests for the 31, 43 and 44 material are performed on the 4193A Vector Impedance Analyzer. The 61 material parts are tested on the 4191A RF Impedance Analyzer. **Cores are tested with the shortest practical wire length.**
- Performance curves of all listed round cable snap-its are compiled on the Fair-Rite Products CD-ROM.
- Many of the snap-it parts have round core equivalents. See section Round Cable EMI Suppression Cores on pages 70-74.
- Round Cable Snap-it Kits are available for each of the four suppression materials. 31 Snap-It Kit (0199000030), 43 Snap-It Kit (0199000031), 46 Core and Snap-It Kit (0199000032) and 61 Snap-It Kit (0199000033). For additional details see page 68.
- Explanation of Part Numbers: Digits 1&2 = product class and 3&4 material grade.

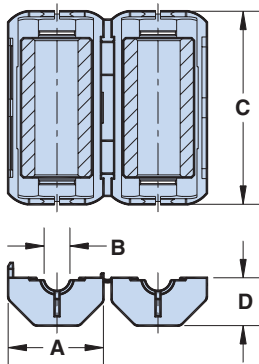

Figure 1

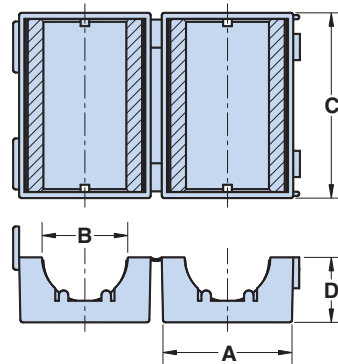

Figure 2

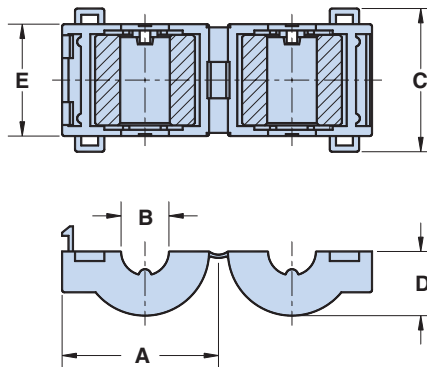

Figure 3

Fair-Rite Products Corp.

PO Box J, One Commercial Row, Wallkill, NY 12589-0288

Phone: (888) FAIR RITE / (845) 895-2055 • FAX: (888) FERRITE / (845) 895-2629 • www.fair-rite.com
(888) 324-7748 (888) 337-7483 • E-Mail: ferrites@fair-rite.com

Round Cable Snap-its

Listed by frequency range and in ascending order of cable diameter.

Lower & Broadband Frequencies 1-300 MHz (31 material)

Dimensions (Bold numbers are in millimeters, light numbers are nominal in inches.)

Part Number	Fig.	Max. Cable Diameter	A	B**	C	D	Wt. (g)	Typical Impedance(Ω)						Solid Equivalent*
								1 MHz	5 MHz	10 MHz ⁺	25 MHz ⁺	100 MHz ⁺	250 MHz	
0431178181	1	4.1 .161	11.8 .465	4.3 .169	23.2 .913	5.6 .221	4.2	12	43	60	90	160	183	
0431173951	1	4.9 .193	12.8 .504	5.1 .201	25.0 .984	5.6 .220	6.5	14	44	60	100	180	208	2631023002
0431164951	1	4.9 .193	17.3 .680	5.1 .201	36.2 1.420	8.4 .331	17	25	75	100	169	280	247	2631480002
0431164281	1	6.3 .250	20.0 .788	6.6 .260	39.4 1.550	9.8 .385	26	28	83	105	180	310	240	2631540002
0431178281	1	8.7 .343	21.5 .846	9.0 .354	39.4 1.550	10.55 .415	23	18	63	85	130	250	275	2631665702
0431167281	1	9.85 .388	23.7 .933	10.15 .400	39.4 1.550	11.7 .461	33	18	56	81	144	240	270	2631626402
0431164181	1	12.7 .500	31.0 1.220	13.05 .514	39.4 1.550	15.25 .600	61	25	71	100	156	260	260	2631102002
0431176451	1	18.0 .709	38.6 1.520	18.35 .722	47.5 1.870	19.15 .755	161	47	95	130	225	380	370	2631103002
0431173551	2	18.5 .728	29.2 1.150	18.8 .740	42.0 1.65	14.7 .579	78	16	48	69	125	220	310	2631103102
0431177081	1	25.4 1.000	56.4 2.220	25.9 1.020	42.95 1.690	27.45 1.080	308	45	90	125	218	375	340	2631626202

Broadband Frequencies 25-300 MHz (43 & 44 materials)

Part Number	Fig.	Max. Cable Diameter	A	B**	C	D	E	Wt. (g)	Typical Impedance(Ω)				Solid Equivalent*
									10 MHz	25 MHz ⁺	100 MHz ⁺	250 MHz	
0443178181	1	4.1 .161	11.8 .465	4.3 .169	23.2 .913	5.6 .221		4.2	40	70	125	152	
0444173951	1	4.9 .193	12.8 .504	5.1 .201	25.0 .984	5.6 .220		6.5	54	94	150	187	2643023002
0444164951	1	4.9 .193	17.3 .680	5.1 .201	38.2 1.420	8.4 .331		17	90	144	245	257	2643480002
0443164251	2	6.3 .250	17.9 .705	6.6 .260	32.2 1.270	9.2 .362		31	100	163	275	275	2643540002
0444164281	1	6.3 .250	20.0 .788	6.6 .260	39.4 1.550	9.8 .385		26	95	156	260	270	2643540002
0443625006	3	7.6 .299	24.7 .972	7.9 .311	22.8 .898	10.2 .402	17.8 .701	13	27	50	113	188	2643625002
0443178281	1	8.7 .343	21.5 .846	9.0 .354	39.4 1.550	10.55 .415		24	65	120	230	265	2643665702
0443665806	3	9.2 .362	26.3 1.035	9.5 .374	21.4 .843	11.0 .433	16.4 .646	13	23	41	88	122	2643665802

* For solid cable cores see pages 32 and 70-74

⁺ Test Frequency

** "B" dimension is the core dimension.

Fair-Rite Products Corp.

PO Box J, One Commercial Row, Wallkill, NY 12589-0288

Phone: (888) FAIR RITE / (845) 895-2055 • FAX: (888) FERRITE / (845) 895-2629
(888) 324-7748 (888) 337-7483

• www.fair-rite.com
• E-Mail: ferrites@fair-rite.com

Round Cable Snap-its

Listed by frequency range and in ascending order of cable diameter.

Broadband Frequencies 25-300 MHz (43 & 44 materials)

Dimensions (Bold numbers are in millimeters, light numbers are nominal in inches.)

Part Number	Fig.	Max. Cable Diameter	A	B**	C	D	E	Wt. (g)	Typical Impedance(Ω)				Solid Equivalent*
									10 MHz	25 MHz ⁺	100 MHz ⁺	250 MHz	
0443167251	2	9.85 .388	22.1 .870	10.15 .400	32.3 1.272	11.0 .433		42	79	138	225	285	2643626402
0444167281	1	9.85 .388	23.7 .933	10.15 .400	39.4 1.550	11.7 .460		33	77	125	210	260	2643626402
0443164151	2	12.7 .500	29.0 1.142	13.05 .514	32.5 1.280	14.8 .583		84	90	156	250	305	2643102002
0444164181	1	12.7 .500	31.0 1.220	13.05 .514	39.4 1.550	15.25 .600		61	76	138	230	280	2643102002
0443800506	3	12.8 .504	29.7 1.169	13.2 .520	20.6 .811	12.7 .500	15.6 .614	16	18	35	75	120	2643800502
0443806406	3	15.0 .591	34.3 1.360	15.5 .610	21.2 .835	15.0 .591	16.2 .638	23	24	43	90	147	2643806402
0444176451	1	18.0 .709	38.6 1.520	18.35 .722	47.5 1.870	19.15 .755		161	100	175	365	365	2643103002
0444173551	2	18.5 .728	29.2 1.150	18.8 .740	42.0 1.650	14.7 .579		78	50	95	195	322	2643103102
0444177081	1	25.4 1.000	56.4 2.220	25.9 1.020	42.95 1.690	27.45 1.080		308	115	194	335	330	2643626202

Broadband Frequencies 25-300 MHz (Economical 46 material)

Part Number	Fig.	Max. Cable Diameter	A	B**	C	D	E	Wt. (g)	Typical Impedance(Ω)				Solid Equivalent*
									10 MHz	25 MHz	100 MHz ⁺	250 MHz	
0446173951	1	4.9 .193	12.8 .504	5.1 .201	25.0 .984	5.6 .220		6.5	46	82	135	185	
0446164951	1	4.9 .193	17.3 .680	5.1 .201	38.2 1.420	8.4 .331		17	72	120	220	250	2646480002
0446164281	1	6.3 .250	20.0 .788	6.6 .260	39.4 1.550	9.8 .385		26	81	131	235	265	2646540002
0446164251	2	6.3 .250	17.9 .705	6.6 .260	32.2 1.270	9.2 .362		31	81	134	245	273	2646540002
0446167281	1	9.85 .388	23.7 .933	10.15 .400	39.4 1.550	11.7 .460		33	66	105	190	275	
0446167251	2	9.85 .388	22.1 .870	10.15 .400	32.3 1.272	11.0 .433		42	72	116	202	247	
0446164181	1	12.7 .500	31.0 1.220	13.05 .514	39.4 1.550	15.25 .600		61	73	115	205	275	2646102002
0446164151	2	12.7 .500	29.0 1.142	13.05 .514	32.5 1.280	14.8 .583		84	84	127	225	270	2646102002
0446176451	1	18.0 .709	38.6 1.520	18.35 .722	47.5 1.870	19.15 .755		161	85	137	330	360	2646103002
0446173551	2	18.5 .728	29.2 1.150	18.8 .740	42.0 1.650	14.7 .579		78	48	85	176	300	
0446177081	1	25.4 1.000	56.4 2.220	25.9 1.020	42.95 1.690	27.45 1.080		308	97	169	330	330	2646626202

* For solid cable cores see pages 70-74

⁺ Test frequency

** "B" dimension is the core dimension.

Fair-Rite Products Corp.

PO Box J, One Commercial Row, Wallkill, NY 12589-0288

Phone: (888) FAIR RITE / (845) 895-2055 • FAX: (888) FERRITE / (845) 895-2629 • www.fair-rite.com
(888) 324-7748 (888) 337-7483 • E-Mail: ferrites@fair-rite.com

Round Cable Snap-its

Listed by frequency range and in ascending order of cable diameter.

Higher Frequencies 200-1000 MHz (61 material)

Dimensions (Bold numbers are in millimeters, light numbers are nominal in inches.)

Part Number	Fig.	Max. Cable Diameter	A	B**	C	D	Wt. (g)	Typical Impedance(Ω)				Solid Equivalent*
								100 MHz	250 MHz ⁺	500 MHz ⁺	1000 MHz	
0461178181	1	4.1 .161	11.8 .465	4.3 .169	23.2 .913	5.6 .221	42	115	165	215	300	
0461164951	1	4.9 .193	17.3 .620	5.1 .201	38.2 1.420	8.4 .331	17	215	325	385	332	
0461164281	1	6.3 .250	20.0 .788	6.6 .260	39.4 1.550	9.8 .385	26	230	355	425	420	2661540002
0461178281	1	8.7 .343	21.5 .846	9.0 .354	39.4 1.550	10.55 .415	24	180	285	380	430	2661665702
0461167281	1	9.85 .388	23.7 .933	10.15 .400	39.4 1.550	11.7 .460	33	175	275	375	400	2661626402
0461164181	1	12.7 .500	29.0 1.142	13.05 .514	32.5 1.280	14.8 .583	61	205	320	435	257	2661102002
0461176451	1	18.0 .709	38.6 1.520	18.35 .722	47.5 1.870	19.15 .755	161	360	480	350	110	

* For solid cable cores see pages 70-74

⁺ Test frequency

** "B" dimension is the core dimension.

Fair-Rite Products Corp.

PO Box J, One Commercial Row, Wallkill, NY 12589-0288

Phone: (888) FAIR RITE / (845) 895-2055 • FAX: (888) FERRITE / (845) 895-2629
(888) 324-7748 (888) 337-7483

• www.fair-rite.com
• E-Mail: ferrites@fair-rite.com

Split Round Cable EMI Suppression Cores

Listed by frequency and in ascending order of cable diameter.

Split round cable suppression cores can be used on cables and wire harnesses with diameters ranging from 2.5 mm (.100") to 25.4 mm (1.000"). These cores are available in three ferrite material grades to attenuate conducted differential and common-mode EMI from 1 MHz into the GHz region.

- Split round cable suppression cores are controlled for impedances only. The impedances listed are typical values. Minimum impedance values are specified for the + marked frequencies. The minimum guaranteed impedance is the listed impedance less 20%.
- Single turn impedance tests for the 31, 43, 44 and 46 material are performed on the 4193A Vector Impedance Analyzer. The 61 material parts are tested on the 4191A RF Impedance Analyzer. **Cores are tested with the shortest practical wire length.**
- Over-molding, heat shrink tubing or any other suitable mechanical arrangement can be utilized to clamp split cable cores together. Many of these split round cable cores can be supplied as Round Snap-It assemblies. The first two digits change from 26 to 04. See pages 75 - 78 for the listing of Round Cable Snap-Its.
- Many of the split round cable suppression cores have round cable core equivalents. See section Round Cable EMI Suppression Cores on pages 70-74.
- Performance curves of all listed split round cable suppression cores are compiled on the Fair-Rite CD-ROM.
- The "Expanded Cable and Suppressor Kit" (part number 0199000005) contains a selection of these split round cable suppression cores. For details see page 67.
- Explanation of Part Numbers: Digits 1&2 = product class and 3&4 material grade.

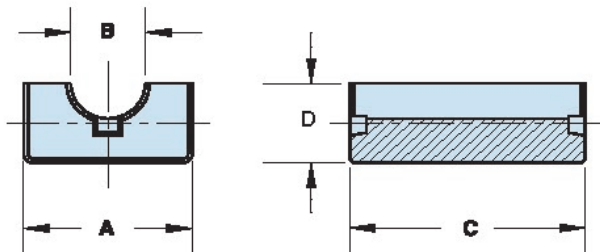

Figure 1

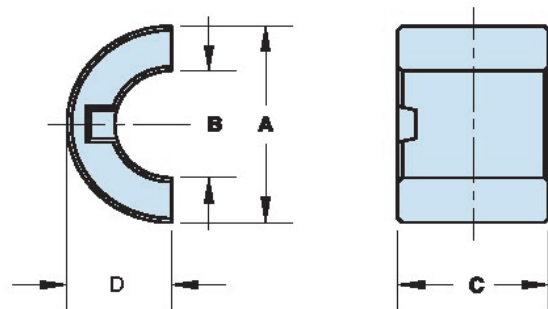

Figure 2

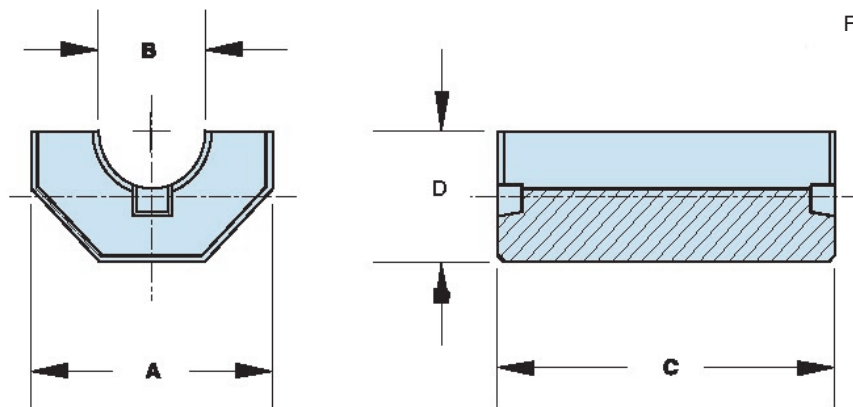

Figure 3

Fair-Rite Products Corp.

PO Box J, One Commercial Row, Wallkill, NY 12589-0288

Phone: (888) FAIR RITE / (845) 895-2055 • FAX: (888) FERRITE / (845) 895-2629 • www.fair-rite.com
(888) 324-7748 (888) 337-7483 • E-Mail: ferrites@fair-rite.com

Split Round Cable EMI Suppression Cores

Listed by frequency and in ascending order of cable diameter.

Lower & Broadband Frequencies 1-300 MHz (31 material)

Dimensions (Bold numbers are in millimeters, light numbers are nominal in inches.)

Part Number	Fig.	Max. Cable Diameter	A	B**	C	D	Wt. (g)	Typical Impedance(Ω)						Solid Equivalent*
								1 MHz	5 MHz	10 MHz ⁺	25 MHz ⁺	100 MHz ⁺	250 MHz	
2631178181	3	4.1 .161	9.0 ± 0.25 .354	4.3 ± 0.2 .169	18.0 ± 0.5 .709	4.2 ± 0.15 .166	2.0	12	43	60	90	160	183	
2631173951	3	4.9 .193	10.0 ± 0.25 .394	5.1 ± 0.2 .201	19.8 ± 0.5 .780	4.6 ± 0.15 .181	2.8	14	44	60	100	180	208	2631023002
2631164951	3	4.9 .193	12.3 ± 0.45 .484	5.1 ± 0.2 .201	25.4 ± 0.75 1.000	6.15 ± 0.2 .242	6.6	25	75	100	169	280	247	2631480002
2631164281	3	6.3 .250	15.0 ± 0.25 .590	6.6 ± 0.3 .260	28.9 ± 0.6 1.125	7.5 ± 0.15 .295	11	28	83	105	180	310	240	2631540002
2631178281	3	8.7 .343	16.5 ± 0.4 .648	9.0 ± 0.3 .354	28.6 ± 0.8 1.126	8.25 ± 0.15 .325	9.9	18	63	85	130	250	275	2631665702
2631167281	3	9.85 .388	18.6 ± 0.45 .732	10.15 ± 0.3 400	28.9 ± 0.6 1.138	9.5 ± 0.25 .375	14	18	56	81	144	240	270	2631626402
2631164181	3	12.7 .500	25.9 ± 0.5 1.020	13.05 ± 0.3 .514	28.9 ± 0.6 1.138	12.95 ± 0.25 .510	27	25	71	100	156	260	260	2631102002
2631176451	3	18.0 .709	34.9 ± 0.65 1.374	18.35 ± 0.35 .722	44.35 ± 0.35 1.746	17.45 ± 0.3 .687	76	47	95	130	225	380	370	2631103002
2631173551	1	18.5 .728	25.9 ± 0.5 1.020	18.8 ± 0.3 .740	38.9 ± 0.4 1.532	13.0 ± 0.25 .512	35	16	48	69	125	220	310	2631103102
2631177081	3	25.4 1.000	50.8 ± 1.0 2.000	25.9 ± 0.5 1.030	37.45 ± 0.75 1.474	25.4 ± 0.5 1.000	145	45	90	125	218	375	340	2631626202

Broadband Frequencies 25-300 MHz (43 & 44 material)

Part Number	Fig.	Max. Cable Diameter	A	B**	C	D	Wt. (g)	Typical Impedance(Ω)				Solid Equivalent*
								10 MHz	25 MHz ⁺	100 MHz ⁺	250 MHz	
2643166751	1	2.3 .090	7.65 - 0.25 .296	2.3 ± 0.25 .095	7.8 - 0.5 .297	3.9 - 0.25 .148	1.0	30	60	93	105	2643000801
2643178181	3	4.1 .161	9.0 ± 0.25 .354	4.3 ± 0.2 .169	18.0 ± 0.5 .709	4.2 ± 0.15 .166	2.0	40	70	125	152	
2644173951	3	4.9 .193	10.0 ± 0.25 .394	5.1 ± 0.2 .201	19.8 ± 0.5 .780	4.6 ± 0.15 .181	2.8	54	94	150	187	2643023002
2644164951	3	4.9 .193	12.3 ± 0.45 .484	5.1 ± 0.2 .201	25.4 ± 0.75 1.000	6.15 ± 0.2 .242	6.6	90	144	245	257	2643480002
2643164251	1	6.3 .250	15.0 ± 0.25 .590	6.6 ± 0.3 .260	28.6 ± 0.8 1.125	7.5 ± 0.15 .295	14	100	163	275	275	2643540002
2644164281	3	6.3 .250	15.0 ± 0.25 .590	6.6 ± 0.3 .260	28.9 ± 0.6 1.125	7.5 ± 0.15 .295	11	95	156	260	270	2643540002
2643165451	1	6.3 .250	15.0 ± 0.25 .590	6.6 ± 0.3 .260	15.25 ± 0.6 .600	7.5 ± 0.15 .295	7.0	52	94	155	232	
2643625006	2	7.6 .300	15.9 ± 0.4 .626	7.9 ± 0.3 .311	14.3 ± 0.4 .563	7.95 ± 0.2 .313	5.3	27	50	113	188	2643625002
2643178281	3	8.7 .343	16.5 ± 0.4 .648	9.0 ± 0.3 .354	28.6 ± 0.8 1.126	8.25 ± 0.15 .325	9.9	65	120	230	265	2643665702
2643665806	2	9.3 .365	17.5 ± 0.5 .689	9.5 ± 0.3 .374	12.7 ± 0.4 .500	8.75 ± 0.25 .344	5.1	23	41	88	122	2643665802

* For solid cable cores see pages 31-32 and 70-74

⁺ Test frequency

** "B" dimension is the core dimension.

Fair-Rite Products Corp.

Phone: (888) FAIR RITE / (845) 895-2055 • FAX: (888) FERRITE / (845) 895-2629
(888) 324-7748

PO Box J, One Commercial Row, Wallkill, NY 12589-0288

• www.fair-rite.com
• E-Mail: ferrites@fair-rite.com

Split Round Cable EMI Suppression Cores

Listed by frequency and in ascending order of cable diameter.

Broadband Frequencies 25-300 MHz (43 & 44 material)

Dimensions (Bold numbers are in millimeters, light numbers are nominal in inches.)

Part Number	Fig.	Max. Cable Diameter	A	B**	C	D	Wt. (g)	Typical Impedance(Ω)				Solid Equivalent*
								10 MHz	25 MHz ⁺	100 MHz ⁺	250 MHz	
2643167251	1	9.85 .388	18.65±0.4 .735	10.15±0.3 .400	28.6±0.8 1.125	9.4±0.15 .370	19	79	138	225	285	2643626402
2644167281	3	9.85 .388	18.6±0.45 .732	10.15±0.3 .400	28.9±0.6 1.138	9.5±0.25 .375	14	77	125	210	260	2643626402
2643164151	1	12.7 .500	25.9±0.5 1.020	13.05±0.3 .514	28.6±0.8 1.125	12.95±0.25 .510	39	90	156	250	305	2643102002
2644164181	3	12.7 .500	25.9±0.5 1.020	13.05±0.3 .514	28.9±0.6 1.138	12.95±0.25 .510	27	76	138	230	280	2643102002
2643800506	2	12.8 .504	21.0±0.5 .827	13.2±0.4 .520	11.9±0.4 .469	10.5±0.25 .413	6.3	18	35	75	120	2643800502
2643806406	2	15.0 .591	25.4±0.6 1.000	15.5±0.5 .610	12.7±0.4 .500	12.7±0.3 .500	9.9	24	43	90	147	2643806402
2644176451	3	18.0 .709	34.9±0.65 1.374	18.35±0.35 .722	44.35±0.35 1.746	17.45±0.3 .687	76	100	175	365	365	2643103002
2644173551	1	18.5 .728	25.9±0.5 1.020	18.8±0.3 .740	38.9±0.4 1.532	13.0±0.25 .512	35	50	95	195	322	2643103102
2644177081	3	25.4 1.000	50.8±1.0 2.000	25.9±0.5 1.030	37.45±0.75 1.474	25.4±0.5 1.000	145	115	194	335	350	2643626202

Broadband Frequencies 25-300 MHz (Economical 46 material)

Part Number	Fig.	Max. Cable Diameter	A	B**	C	D	Wt. (g)	Typical Impedance(Ω)				Solid Equivalent*
								10 MHz	25 MHz	100 MHz ⁺	250 MHz	
2646173951	3	4.9 .193	10.0±0.25 .394	5.1±0.2 .201	19.8±0.5 .780	4.6±0.15 .181	2.8	46	82	135	185	
2646164951	3	4.9 .193	12.3±0.45 .484	5.1±0.2 .201	25.4±0.75 1.000	6.15±0.2 .242	6.6	72	120	220	250	2646800002
2646164251	1	6.3 .250	15.0±0.25 .590	6.6±0.3 .260	28.6±0.8 1.125	7.5±0.15 .295	14	81	134	245	273	2646540002
2646164281	3	6.3 .250	15.0±0.25 .590	6.6±0.3 .260	28.9±0.6 1.125	7.5±0.15 .295	11	81	131	235	265	2646540002
2646167281	3	9.85 .388	18.6±0.45 .732	10.15±0.3 .400	28.9±0.6 1.138	9.5±0.25 .375	14	66	105	190	275	
2646167251	1	9.85 .388	18.65±0.4 .735	10.15±0.3 .400	28.6±0.8 1.125	9.4±0.15 .370	19	72	116	202	247	
2646164181	3	12.7 .500	25.9±0.5 1.020	13.05±0.3 .514	28.9±0.6 1.138	12.95±0.25 .510	27	73	115	205	275	2646102002
2646164151	1	12.7 .500	25.9±0.5 1.020	13.05±0.3 .514	28.6±0.8 1.125	12.95±0.25 .510	39	84	127	225	270	2646102002
2646176451	3	18.0 .709	34.9±0.65 1.374	18.35±0.35 .722	44.35±0.35 1.746	17.45±0.3 .687	76	85	152	330	360	2646103002
2646173551	1	18.5 .728	25.9±0.5 1.020	18.8±0.3 .740	38.9±0.4 1.532	13.0±0.25 .512	35	48	85	176	300	
2646177081	3	25.4 1.000	50.8±1.0 2.000	25.9±0.5 1.030	37.45±0.75 1.474	25.4±0.5 1.000	145	97	169	330	330	2646626202

* For solid cable cores see pages 70-74

⁺ Test frequency

** "B" dimension is the core dimension.

Fair-Rite Products Corp.

PO Box J, One Commercial Row, Wallkill, NY 12589-0288

Phone: (888) FAIR RITE / (845) 895-2055 • FAX: (888) FERRITE / (845) 895-2629
(888) 324-7748 (888) 337-7483

• www.fair-rite.com
• E-Mail: ferrites@fair-rite.com

Split Round Cable EMI Suppression Cores

Listed by frequency and in ascending order of cable diameter.

Higher Frequencies 200-1000 MHz (61 material)

Dimensions (Bold numbers are in millimeters, light numbers are nominal in inches.)

Part Number	Fig.	Max. Cable Diameter	A	B**	C	D	Wt. (g)	Typical Impedance(Ω)				Solid Equivalent*
								100 MHz ⁺	250 MHz ⁺	500 MHz ⁺	1000 MHz	
2661178181	3	4.1 .161	9.0±0.25 .354	4.5±0.2 .169	18.0±0.5 .709	4.2±0.15 .166	2.0	115	165	215	300	
2661164951	3	4.9 .193	12.3±0.45 .484	5.1±0.2 .201	25.4±0.75 1.000	6.15±0.2 .242	6.6	215	325	385	332	
2661164281	3	6.3 .250	15.0±0.25 .590	6.6±0.3 .260	28.9±0.6 1.125	7.5±0.15 .295	11	230	355	425	420	2661540002
2661178281	3	8.7 .343	16.5±0.4 .648	9.0±0.3 .354	28.6±0.8 1.126	8.25±0.15 .325	9.9	180	285	380	430	2661665702
2661167281	3	9.85 .388	18.6±0.45 .732	10.15±0.3 .400	28.9±0.6 1.138	9.5±0.25 .375	14	175	275	375	400	2661626402
2661164181	3	12.7 .500	25.9±0.5 1.020	13.05±0.3 .514	28.9±0.6 1.138	12.95±0.25 .510	27	205	320	435	257	2661102002
2661176451	3	18.0 .709	34.9±0.65 1.374	18.35±0.35 .722	44.35±0.35 1.746	17.45±0.3 .687	76	360	400	350	110	

* For solid cable cores see pages 70-74

+ Test frequency

** "B" dimension is the core dimension.

Fair-Rite Products Corp.

PO Box J, One Commercial Row, Wallkill, NY 12589-0288

Phone: (888) FAIR RITE / (845) 895-2055 • FAX: (888) FERRITE / (845) 895-2629
(888) 324-7748 (888) 337-7483

• www.fair-rite.com
• E-Mail: ferrites@fair-rite.com

Flat Cable EMI Suppression Cores

Listed by frequency range and in ascending order of cable width.

Flat cable suppression core can accommodate multi-conductors flat cables, in widths from 12.7 mm (.500") up to 78 mm (3.1"). These flat cable cores are available in two ferrite material grades to reduce conducted EMI from 1 MHz into the hundreds of MHz.

- Flat cable suppression cores, split or single cores, are controlled for impedances only. The impedances listed are typical values. Minimum impedance values are specified for the + marked frequencies. The minimum guaranteed impedance is the listed impedance less 20%.
- Single turn impedance tests for the 31 and 43 material are made on the 4193A Vector Impedance Analyzer.
All tests are made with the shortest practical wire length.
- Performance curves for all flat cable parts are compiled on the Fair-Rite Products CD-ROM.
- Assembly clips are available for most of the split flat cable cores. See pages 86-87 for a listing of flat cable cores and the clips that can be used with these cores.
- Our "Expanded Cable & Connector EMI Suppressor Kit" (part number 0199000005) contains a selection of these flat cable cores and clips. See page 67.
- Explanation of Part Numbers: Digits 1&2 = product class and 3&4 = material grade.

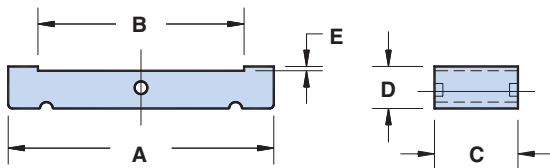

Figure 1

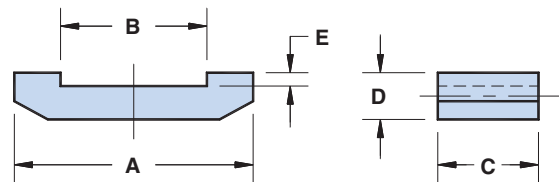

Figure 2

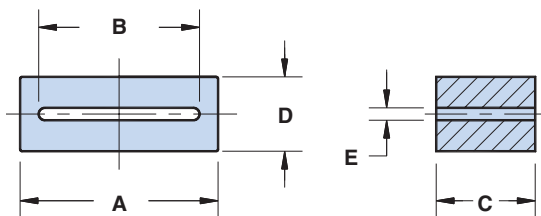

Figure 3

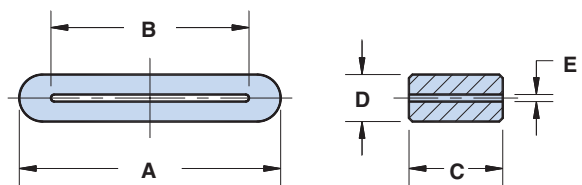

Figure 4

Fair-Rite Products Corp.

PO Box J, One Commercial Row, Wallkill, NY 12589-0288

Phone: (888) FAIR RITE / (845) 895-2055 • FAX: (888) FERRITE / (845) 895-2629
(888) 324-7748 (888) 337-7483

• www.fair-rite.com
• E-Mail: ferrites@fair-rite.com

Flat Cable EMI Suppression Cores

Listed by frequency range in ascending order of cable width.

Lower & Broadband Frequencies 1-300 MHz (31 material)

Dimensions (Bold numbers are in millimeters, light numbers are nominal in inches.)

Part Number	Fig.	Max. Cable Dimensions	A	B	C	D	E	Wt. (g)	Typical Impedance(Ω)					
									1 MHz	5 MHz	10 MHz ⁺	25 MHz ⁺	100 MHz ⁺	250 MHz
2631163851	3	25.9 x 1.5 1.020 x .060	38.1±1.0 1.500	26.65±0.75 1.050	25.4±0.75 1.000	12.05±0.4 .475	1.9±0.4 .075	51	20	52	68	112	240	440
2631163951*	1	51.0 x 1.3 2.000 x .050	63.5±1.3 2.500	52.1±1.1 2.050	28.6±0.8 1.125	6.35±0.25 .250	0.85±0.2 .033	50	13	35	54	105	300	425
2631164051*	1	64.0 x 1.3 2.520 x .050	76.2±1.5 3.000	65.3±1.3 2.570	28.6±0.8 1.125	6.35±0.25 .250	0.85±0.2 .033	60	11	34	52	105	310	440

Broadband Frequencies 25-300 MHz (43 material)

Part Number	Fig.	Max. Cable Dimensions	A	B	C	D	E	Wt. (g)	Typical Impedance(Ω)			
									10 MHz	25 MHz ⁺	100 MHz ⁺	250 MHz
2643170251	2	12.2 x 2.3 .480 x .091	22.75±0.65 .895	12.7±0.5 .500	12.7±0.5 .500	3.3 - 0.25 .125	1.15±0.25 .050	3.5	20	35	70	135
2643178451	4	13.1 x 1.35 .516 x .053	18.5±0.4 .728	13.5±0.4 .531	6.0±0.3 .236	6.6±0.25 .260	1.6±0.25 .063	2.9	15	25	48	90
2643178351	4	13.1 x 1.35 .516 x .053	18.5±0.4 .728	13.5±0.4 .531	12.0±0.3 .472	6.6±0.25 .260	1.6±0.25 .063	5.9	31	48	82	140
2643169552	3	13.95 x 0.75 .549 x .030	19.95±0.4 .785	14.2±0.25 .560	10.15±0.5 .400	6.35±0.25 .250	0.9±0.15 .035	5.7	25	40	90	160
2643168751	3	17.3 x 2.3 .681 x .091	25.4±0.75 1.000	17.8±0.5 .700	12.7±0.4 .500	10.15±0.25 .400	2.55±0.25 .100	13	31	50	95	200
2643173351	4	19.6 x 0.5 .772 x .020	24.5±0.4 .965	20.0±0.4 .787	12.0±0.3 .472	5.0±0.25 .197	0.75±0.25 .030	6.6	23	39	88	157
2643178651	4	21.1 x 1.35 .831 x .053	26.5±0.4 1.043	21.5±0.4 .846	6.0±0.3 .236	6.6±0.25 .260	1.6±0.25 .063	4.1	13	22	50	95
2643178551	4	21.1 x 1.35 .831 x .053	26.5±0.4 1.043	21.5±0.4 .846	12.0±0.3 .472	6.6±0.25 .260	1.6±0.25 .063	8.2	24	38	82	155
2643168651	2	25.4 x 12.2 1.000 x .480	38.85±0.75 1.530	26.15±0.75 1.030	28.6±0.7 1.125	13.0±0.3 .512	6.35±0.25 .255	45	57	100	188	295
2643164551	3	25.9 x 1.5 1.020 x .059	38.1±1.0 1.500	26.65±0.75 1.050	12.3±0.4 .485	12.05±0.4 .475	1.9±0.4 .075	25	33	53	105	215
2643171051*	1	25.9 x 1.3 1.020 x .051	38.1±1.0 1.500	26.65±0.75 1.050	12.7±0.4 .500	6.35±0.25 .250	0.85±0.2 .033	14	32	53	112	235

* For assembly clips see page 86.

⁺ Test frequency

Fair-Rite Products Corp.

PO Box J, One Commercial Row, Walkill, NY 12589-0288

Phone: (888) FAIR RITE / (845) 895-2055 • FAX: (888) FERRITE / (845) 895-2629
(888) 324-7748 (888) 337-7483

• www.fair-rite.com
• E-Mail: ferrites@fair-rite.com

Flat Cable EMI Suppression Cores

Listed by frequency range in ascending order of cable width.

Broadband Frequencies 25-300 MHz (43 material)

Dimensions (Bold numbers are in millimeters, light numbers are nominal in inches.)

Part Number	Fig.	Max. Cable Dimensions	A	B	C	D	E	Wt. (g)	Typical Impedance(Ω)			
									10 MHz	25 MHz ⁺	100 MHz ⁺	250 MHz
2643166851*	1	25.9 x 1.3 1.020 x .051	38.1±1.0 1.500	26.65±0.75 1.050	25.4±0.75 1.000	6.35±0.25 .250	0.85±0.2 .033	27	66	115	235	410
2643163851	3	25.9 x 1.5 1.020 x .059	38.1±1.0 1.500	26.65±0.75 1.050	25.4±0.75 1.000	12.05±0.4 .475	1.9±0.4 .075	51	64	105	220	385
2643178851	4	26.1 x 1.35 1.028 x .053	31.5±0.4 1.240	26.5±0.4 1.043	6.0±0.3 .236	6.6±0.25 .260	1.6±0.25 .063	4.8	12	22	55	94
2643178751	4	26.1 x 1.35 1.028 x .053	31.5±0.4 1.240	26.5±0.4 1.043	12.0±0.3 .472	6.6±0.25 .260	1.6±0.25 .063	9.7	22	37	85	157
2643172551	4	26.5 x 1.25 1.043 x .049	33.5±0.65 1.319	27.0±0.5 1.063	8.0±0.4 .315	6.5±0.25 .256	1.25±0.7 .063	6.8	12	22	58	106
2643169351	3	27.0 x 1.1 1.063 x .043	33.65±0.75 1.325	27.5±0.5 1.083	13.2±0.5 .520	6.7±0.4 .265	1.35±0.25 .053	12	22	39	98	192
2643166451*	1	26.95 x 3.05 1.061 x .120	38.35±1.0 1.510	27.95±1.0 1.100	28.6±0.7 1.125	9.0±0.3 .355	3.3±0.25 .130	35	61	96	185	335
2643168051	1	32.3 x 6.2 1.272 x .244	52.9±1.0 2.083	33.0±0.7 1.299	31.25±1.0 1.230	12.5±0.4 .492	3.5±0.4 .138	84	81	140	265	400
2643167551	1	32.3 x 6.2 1.272 x .244	52.9±1.0 2.083	33.0±0.7 1.299	63.5±1.8 2.500	12.5±0.4 .492	3.5±0.4 .138	170	150	270	480	370
2643170951*	1	33.7 x 1.3 1.327 x .051	45.1±0.75 1.775	34.4±0.7 1.355	12.7±0.4 .500	6.35±0.25 .250	0.85±0.2 .033	16	25	50	115	240
2643166551	3	33.7 x 1.2 1.327 x .047	45.1±0.75 1.775	34.4±0.7 1.355	28.6±0.7 1.125	12.45±0.4 .490	1.5±0.3 .060	71	67	115	300	415
2643166651	1	33.7 x 1.3 1.327 x .051	45.1±0.75 1.775	34.4±0.7 1.355	28.6±0.7 1.125	6.35±0.25 .250	0.85±0.2 .033	36	60	110	290	435
2643168251*	1	51.0 x 1.3 2.008 x .051	63.5±1.3 2.500	52.1±1.1 2.050	12.7±0.4 .500	6.35±0.25 .250	0.85±0.2 .033	22	22	50	125	255
2643163951*	1	51.0 x 1.3 2.008 x .051	63.5±1.3 2.500	52.1±1.1 2.050	28.6±0.8 1.125	6.35±0.25 .250	0.85±0.2 .033	50	56	100	290	400
2643167751*	1	64.0 x 1.3 2.520 x .051	76.2±1.5 3.000	65.3±1.3 2.570	12.7±0.4 .500	6.35±0.25 .250	0.85±0.2 .033	27	22	45	115	240
2643164051*	1	64.0 x 1.3 2.520 x .051	76.2±1.5 3.000	65.3±1.3 2.570	28.6±0.8 1.125	6.35±0.25 .250	0.85±0.2 .033	60	48	100	290	420
2643168351*	1	76.7 x 1.3 3.020 x .051	88.9±1.8 3.500	78.2±1.5 3.080	28.6±0.8 1.125	6.5±0.35 .256	0.95±0.3 .037	70	45	100	280	440

*For assembly clips see page 86.

⁺ Test frequency

Fair-Rite Products Corp.

PO Box J, One Commercial Row, Wallkill, NY 12589-0288

Phone: (888) FAIR RITE / (845) 895-2055 • FAX: (888) FERRITE / (845) 895-2629
(888) 324-7748 (888) 337-7483

• www.fair-rite.com
• E-Mail: ferrites@fair-rite.com

Flat Cable Cores Assembly Clips

Fair-Rite offers several clips to accommodate the assembly of the split flat cable suppression cores.

- Figures 1 and 2 are metal clips, made from 0.5mm (.020") high carbon steel with a zinc electroplate finish.
- Figure 3 clips are a polypropylene material RoHS compliant, with a flammability rating of UL94-V0.

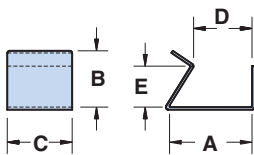

Figure 1

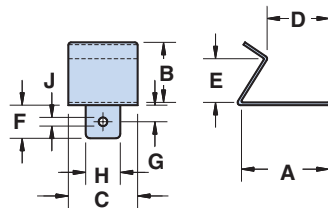

Figure 2

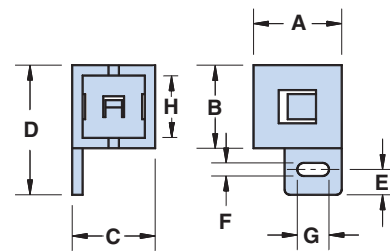

Figure 3

Clips

Dimensions (Bold numbers are in millimeters, light numbers are nominal in inches.)

Part Number Clip	Fig.	A	B	C	D	E	F	G	H	J
0199001401	1	16.1 .635	11.0 .433	12.7 .500	11.4 .450	8.0 .315	—	—	—	—
0199010301	2	21.2 .835	11.0 .433	12.7 .500	16.5 .650	8.0 .315	7.5 .295	4.0 .157	6.0 .236	3.0 .118
0199016051	3	16.7 .657	15.9 .626	15.9 .626	24.6 .969	4.4 .171	3.2 .126	6.4 .252	13.1 .516	—
0199016551	3	16.7 .657	32.2 1.27	15.9 .626	40.5 1.59	4.4 .171	3.2 .126	6.4 .252	29.5 1.161	—

Fair-Rite Products Corp.

PO Box J, One Commercial Row, Wallkill, NY 12589-0288

Phone: (888) FAIR RITE / (845) 895-2055 • FAX: (888) FERRITE / (845) 895-2629
(888) 324-7748 (888) 337-7483

• www.fair-rite.com
• E-Mail: ferrites@fair-rite.com

Flat Cable Cores Assembly Clips

	0199001401	0199010301	0199016051	0199016551
2631163951	X			X
2631164051	X			
2643163951	X			X
2643164051	X			X
2643166451		X		
2643166651	X			X
2643166851	X			
2643167751	X		X	
2643168251	X		X	
2643168351	X			X
2643170951	X		X	
2643171051	X		X	

Fair-Rite Products Corp.

PO Box J, One Commercial Row, Wallkill, NY 12589-0288

Phone: (888) FAIR RITE / (845) 895-2055 • FAX: (888) FERRITE / (845) 895-2629
(888) 324-7748 (888) 337-7483

• www.fair-rite.com
• E-Mail: ferrites@fair-rite.com

Flat Cable Snap-its

Listed by frequency range in ascending order of cable width.

Flat cable snap-its for use on multi-conductor flat cables to suppress common-mode conducted EMI from 1MHz to hundreds of MHz. These flat cable snap-its are available in two ferrite materials, 31 and 43.

The polypropylene cases are meeting the RoHS restrictions of hazardous substances and have a flammability rating of UL94-V0.

- Flat cable snap-it assemblies are controlled for impedances only. The impedances listed are typical values. Minimum impedance values are specified for the + marked frequencies. The minimum guaranteed impedance is the listed impedance less 20%.
- Single turn impedance tests on the 31 and 43 material parts are performed on the 4193A Vector Impedance Analyzer. **Cores are tested with the shortest practical wire length.**
- Performance curves of all listed flat cable snap-its are compiled on the Fair-Rite Products CD-ROM.
- The "Expanded Cable and Connector EMI Suppressor Kit" (part number 0199000005) contains several flat cable snap-it assemblies. See page 67.
- Explanation of Part Numbers: Digits 1&2 = product class and 3&4 material grade.

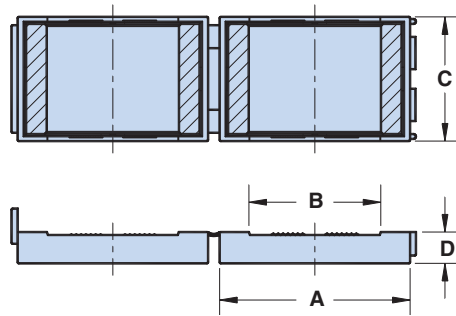

Lower & Broadband Frequencies 1-300 MHz (31 material)

Dimensions (Bold numbers are in millimeters, light numbers are nominal in inches.)

Part Number	Max. Cable Dimensions	A	B	C	D	Wt. (g)	Typical Impedance(Ω)					
							1 MHz	5 MHz	10 MHz ⁺	25 MHz ⁺	100 MHz ⁺	250 MHz
0431163951	51.0 x 1.3 2.000 x .050	67.8 2.670	52.1 2.050	32.3 1.272	8.1 .320	110	13	35	54	105	300	425
0431164051	64.0 x 1.3 2.520 x .050	80.8 3.180	65.3 2.570	32.3 1.272	8.1 .320	130	11	34	52	105	310	440

Broadband Frequencies 25-300 MHz (43 material)

Part Number	Max. Cable Dimensions	A	B	C	D	Wt. (g)	Typical Impedance(Ω)			
							10 MHz	25 MHz ⁺	100 MHz ⁺	250 MHz
0443166651	33.7 X 1.3 1.325 X .050	49.5 1.950	34.4 1.350	32.3 1.272	8.1 .320	80	60	110	290	435
0443163951	51.0 X 1.3 2.000 X .050	67.8 2.670	52.1 2.050	32.3 1.272	8.1 .320	110	56	100	290	400
0443164051	64.0 X 1.3 2.520 X .050	80.8 3.180	65.3 2.570	32.3 1.272	8.1 .320	130	48	100	290	420

⁺ Test frequency

Fair-Rite Products Corp.

PO Box J, One Commercial Row, Wallkill, NY 12589-0288

Phone: (888) FAIR RITE / (845) 895-2055 • FAX: (888) FERRITE / (845) 895-2629
(888) 324-7748 (888) 337 -7483

• www.fair-rite.com
• E-Mail: ferrites@fair-rite.com

Connector EMI Suppression Plates

To provide suppression of conducted EMI at critical interfaces Fair-Rite has available a line of suppression plates that can be used with many types of connectors. All connector plates are supplied in the NiZn 44 grade ideally suited for this application because of its high impedance along with a high resistivity.

- Connector plates are controlled for impedance only. The impedances listed are typical values. Minimum impedance values are specified for the + marked frequencies. The minimum guaranteed impedance is the listed typical impedance less 20%. Single turn impedance tests are performed on the 4193A Vector Impedance Analyzer.
- Performance curves of all listed connector plates are included on the Fair-Rite Products CD-ROM.
- For any connector EMI suppression plate requirement not listed here, feel free to contact our customer service group for availability and pricing.
- Explanation of Part Numbers: Digits 1&2 = product class and 3&4 = the 44 material grade.

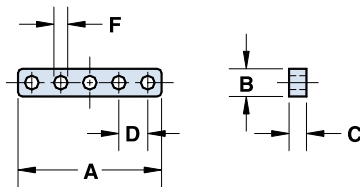

Figure 1

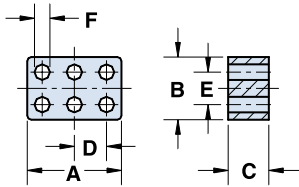

Figure 2

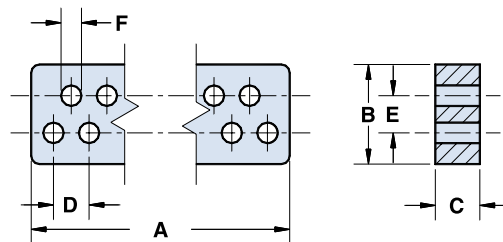

Figure 3

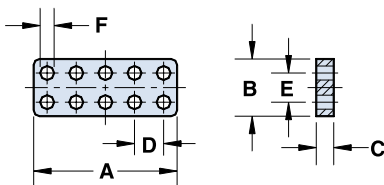

Figure 4

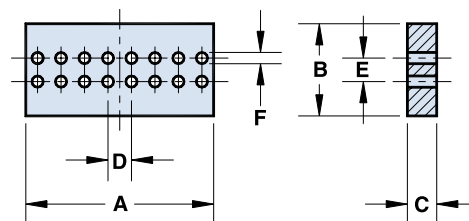

Figure 5

Fair-Rite Products Corp.

PO Box J, One Commercial Row, Wallkill, NY 12589-0288

Phone: (888) FAIR RITE / (845) 895-2055 • FAX: (888) FERRITE / (845) 895-2629 • www.fair-rite.com
 (888) 324-7748 (888) 337-7483 • E-Mail: ferrites@fair-rite.com

Connector EMI Suppression Plates

Dimensions (Bold numbers are in millimeters, light numbers are nominal in inches.)

Part Number	Figure	Total Holes	Number of Rows	A	B	C*	D	E	F	Wt (g)	Typical Impedance(Ω)	
											25 MHz ⁺	100 MHz ⁺
2644246701	1	5	1	12.52±0.13 .493	2.54 Max. .100 Max.	1.52±0.13 .060	2.54±0.13 .100	—	1.22±0.07 .048	.18	13	28
2644246201	2	6	2	5.86±0.10 .231	3.86±0.10 .152	1.52±0.13 .060	2.00±0.08 .079	2.00±0.08 .079	0.82±0.1 .034	.14	14	28
2644245701	2	6	2	7.44±0.10 .293	4.90±0.10 .193	1.52±0.13 .060	2.54±0.13 .100	2.54±0.10 .100	1.22±0.07 .048	.22	13	28
2644236101	3	9	2	14.40±0.15 .567	7.75 0.25 .300	3.43±0.13 .135	2.75±0.13 .108	2.85±0.13 .112	1.60±0.08 .062	1.6	30	51
2644236401	3	9	2	14.40±0.15 .567	7.75 0.25 .300	6.86±0.13 .270	2.75±0.13 .108	2.85±0.13 .112	1.60±0.08 .062	3.2	56	91
2644247001	4	10	2	12.52±0.13 .493	4.90±0.10 .193	1.52±0.13 .060	2.54±0.13 .100	2.54±0.10 .100	1.22±0.07 .048	.37	13	28
2644247101	4	10	2	12.52±0.13 .493	4.90±0.10 .193	3.05±0.13 .120	2.54±0.13 .100	2.54±0.10 .100	1.22±0.07 .048	.74	23	40
2644236301	3	15	2	22.55±0.25 .888	7.75 0.25 .300	3.43±0.13 .135	2.75±0.13 .108	2.85±0.13 .112	1.60±0.08 .062	2.4	30	51
2644236501	3	15	2	22.55±0.25 .888	7.75 0.25 .300	6.86±0.13 .270	2.75±0.13 .108	2.85±0.13 .112	1.60±0.08 .062	4.9	56	91
2644373941	5	16	2	21.60±0.25 .850	11.65 0.40 .451	1.52±0.13 .060	2.54±0.13 .100	7.62±0.15 .300	1.00±0.15 .042	2.9	19	36
2644373841	5	16	2	20.30±0.25 .800	10.15 0.40 .392	3.18±0.13 .125	2.54±0.13 .100	2.54±0.10 .100	1.22±0.07 .048	2.8	30	51
2644236001	3	25	2	36.3±0.4 1.430	7.75 0.25 .300	3.43±0.13 .135	2.75±0.13 .108	2.85±0.13 .112	1.60±0.08 .062	3.6	30	51
2644236601	3	25	2	36.3±0.4 1.430	7.75 0.25 .300	6.86±0.13 .270	2.75±0.13 .108	2.85±0.13 .112	1.60±0.08 .062	7.2	56	91

* This dimension may be modified to suit specific applications.

⁺ Test Frequency

Fair-Rite Products Corp.

PO Box J, One Commercial Row, Walkill, NY 12589-0288

Phone: (888) FAIR RITE / (845) 895-2055 • FAX: (888) FERRITE / (845) 895-2629
(888) 324-7748

• www.fair-rite.com
• E-Mail: ferrites@fair-rite.com

Miscellaneous Suppression Cores

Fair-Rite has tooled several special core geometries in the 43 & 77 material for suppression of conducted EMI.

- These suppression cores are controlled for impedance only. The impedances listed are typical values. Single turn tests are performed on the 4193A Vector Impedance Analyzer **with the shortest practical wire length**.
- Performance curves on these miscellaneous cores are included on the Fair-Rite Products CD-ROM.
- For any non-catalog suppression core design feel free to contact our customer service or application group for feasibility and availability.
- Explanation of Part Numbers: Digits 1&2 = product class and 3&4 = the material grade.

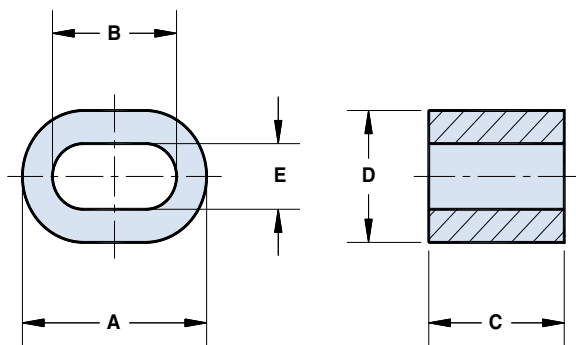

Figure 1

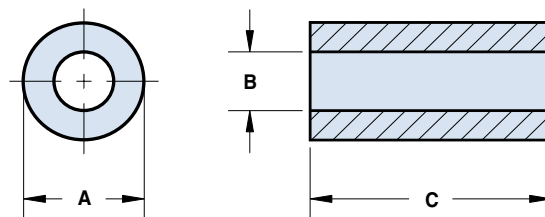

Figure 2

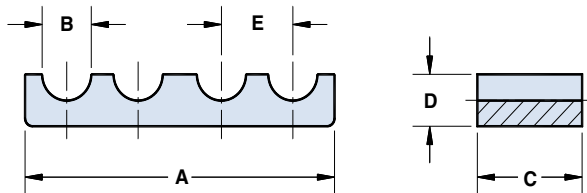

Figure 3

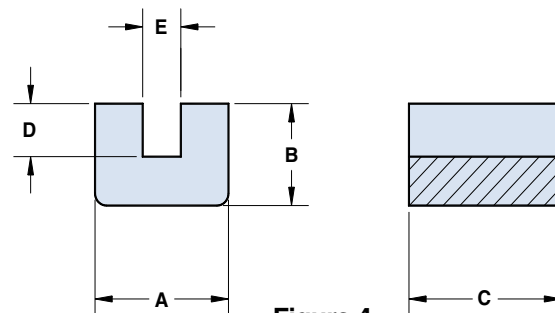

Figure 4

Dimensions (Bold numbers are in millimeters, light numbers are nominal in inches.)

Part Number	Fig.	A	B	C*	D	E	Typical Impedance (Ω)				
							1 MHz	10 MHz	25 MHz	100 MHz	250 MHz
2643167851	1	38.85±0.75 1.530	26.15±0.75 1.030	28.6±0.7 1.125	26.0±0.6 1.025	12.95±0.25 .510	---	60	94	169	250
2643165151	3	82.6±1.6 3.250	13.1±0.3 .516	28.0±0.7 1.100	12.95±0.25 .510	19.05±0.4 .750	---	100	163	280	340
2643175451	4	17.8±0.4 .700	12.7±0.5 .500	20.32±0.5 .800	6.6±0.25 .260	5.08±0.25 .200	---	75	119	180	270
2677006302	2	9.5±0.25 .375	4.75±0.3 .193	10.4±0.25 .410	---	---	25	48	33	---	---
2677102402	2	25.9±0.75 1.020	12.8±0.25 .505	21.3±0.5 .840	---	---	52	28	24	---	---

*This dimension may be modified to suit specific applications.

Fair-Rite Products Corp.

PO Box J, One Commercial Row, Wallkill, NY 12589-0288

Phone: (888) FAIR RITE / (845) 895-2055 • FAX: (888) FERRITE / (845) 895-2629 • www.fair-rite.com
 (888) 324-7748 (888) 337-7483 • E-Mail: ferrites@fair-rite.com

Absorber Tiles

Ferrite Tile Absorber

for EMC Test Chamber
Applications from 30-1500 MHz



Fair-Rite Products Corp.

Phone: (888) FAIR RITE / (845) 895-2055 • FAX: (888) FERRITE / (845) 895-2629
(888) 324-7748 (888) 337-7483

PO Box J, One Commercial Row, Wallkill, NY 12589-0288

• www.fair-rite.com
• E-Mail: ferrites@fair-rite.com

Absorber Tiles

The NiZn 42 material is specifically designed and optimized for use as tile absorbers for anechoic chambers.

42 Material Properties:

Property	Unit	Symbol	Value
Initial Permeability		μ_i	2100
Permittivity (Relative)		ϵ_r	14
Resistivity	Ω -cm	ρ	5×10^6
Curie Temperature	$^{\circ}\text{C}$	T_c	>95
Specific Gravity	g/cm^3		5.2
Young's Modulus	kgf/mm^2		1.8×10^4
Tensile Strength	kgf/mm^2		4.9
Compressive Strength	kgf/mm^2		42
Flexural Strength	kgf/mm^2		6
Vickers Hardness			740
Coeff. of Thermal Expansion	PPM / $^{\circ}\text{C}$		9

NAMAS-1-U Grid Tile Absorber

This tile offers premium performance with wide-band absorption from 30-1500 MHz and exhibit improved low-frequency (up to -20 dB @ 30 MHz) performance with reduced gap loss effects compared to flat tiles.

Grid Tile

Dimensions (Bold numbers are in millimeters, light numbers are in inches.)

Part Number	A	B	C	D	E	Wt (g)
3642014000	100±0.7 3.937	100±0.7 3.937	17.6±0.5 .693	13.4 .527	13.4 .527	500

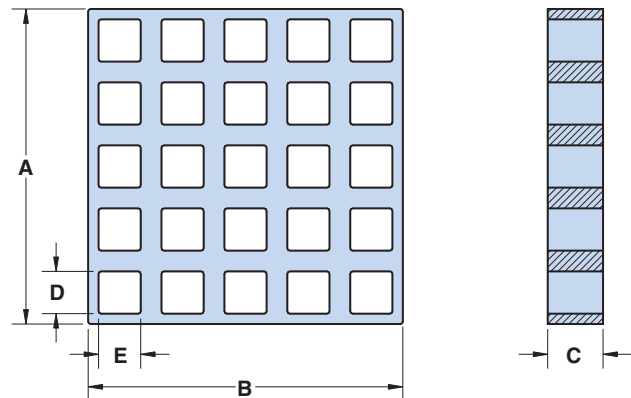
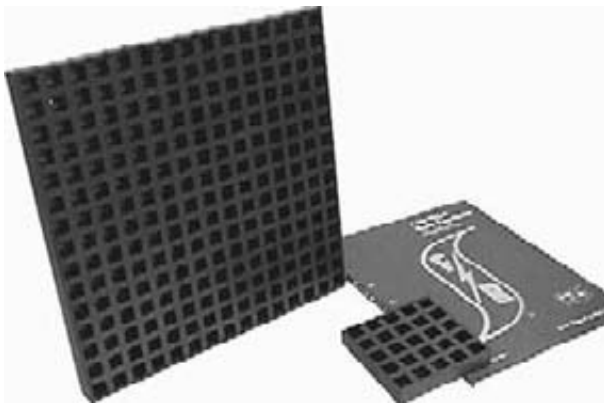

Fair-Rite Products Corp. PO Box J, One Commercial Row, Wallkill, NY 12589-0288

Phone: (888) FAIR RITE / (845) 895-2055 • FAX: (888) FERRITE / (845) 895-2629 • www.fair-rite.com
(888) 324-7748 (888) 337-7483 • E-Mail: ferrites@fair-rite.com

Absorber Tiles

100mm Tiles

This tile is the industry standard size and exhibits excellent overall performance vs. cost. These 100mm tiles can be installed individually using screws or adhesive and are optionally available in panel format. The 5.5mm thickness is ideally suited for compact pre-compliance emissions and IEC-61000-4-3 radiated immunity chambers, while the 6.3mm thickness is recommended for use in ANSI C63.4 compliant 3 meter chambers. Tiles are surface ground on all sides to precise mechanical tolerances, minimizing gaps between adjacent tiles to ensure maximum low-frequency performance.

6.3mm Return Loss (dB)

Freq (MHz)						
30	100	200	400	600	1000	1500
-18	-25	-30	-25	-20	-12	-9

Notes:

For more technical information on absorber tile applications, see "Ferrite Tile Absorbers for EMC Test Chamber Applications" on page 157.

Return Loss values measured in 39mm coaxial airline, using HP 8753D Analyzer.

Wide-Angle Return Loss - TM Polarization

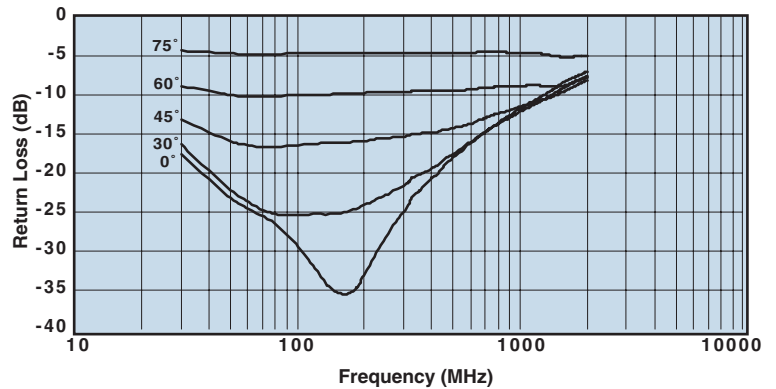

100mm Tiles

Dimensions (Bold numbers are in millimeters, light numbers are in inches.)

Part Number	A	B	C*	D	Wt (g)
3642011601	100±0.13 3.937	100±0.13 3.937	6.3±0.13 .248	10±0.3 .394	324
3642012401	100±0.13 3.937	100±0.13 3.937	5.5±0.13 .217	10±0.3 .394	290

* This dimension may be modified. Thicknesses are available from 5.0 to 6.7mm

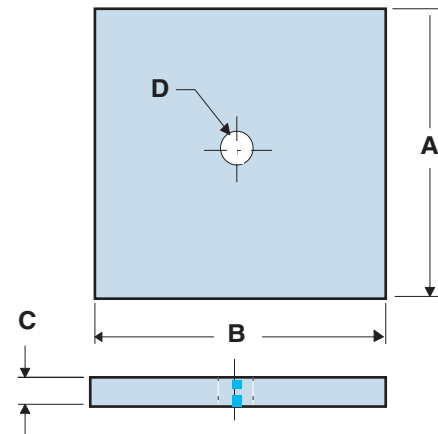

Panels

Dimensions (Bold numbers are in millimeters, light numbers are in inches.)

Part Number	A	B	C	Wt (kg)
3742011901	600 23.62	600 23.62	16.8 .66	17.7

Each panel consists of:

36 Ferrite Tiles epoxy bonded to **9mm (.35")** particle board faced with 26 GA (**0.46mm**) zinc coated steel on two sides.

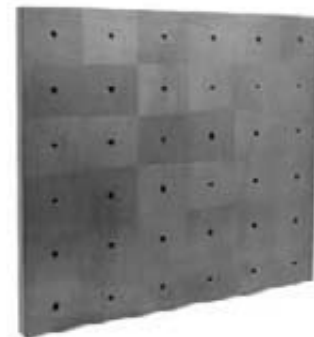

Fair-Rite Products Corp.

PO Box J, One Commercial Row, Wallkill, NY 12589-0288

Phone: (888) FAIR RITE / (845) 895-2055 • FAX: (888) FERRITE / (845) 895-2629 • www.fair-rite.com
 (888) 324-7748 (888) 337-7483 • E-Mail: ferrites@fair-rite.com

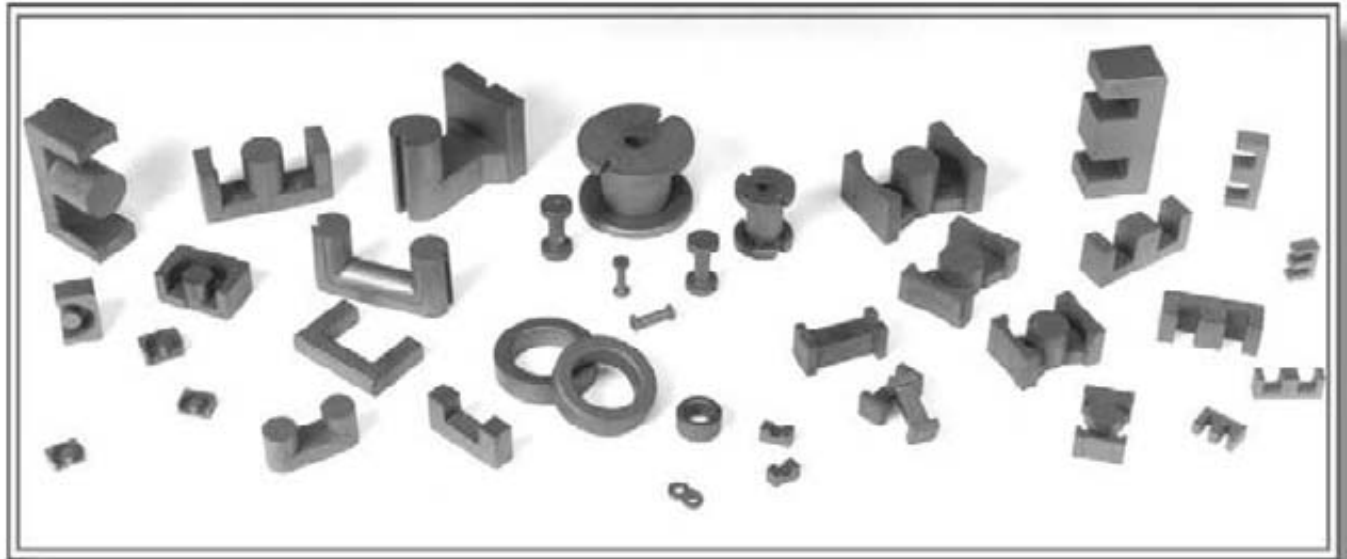

Inductive Components



Fair-Rite Products Corp.

PO Box J, One Commercial Row, Wallkill, NY 12589-0288

Phone: (888) FAIR RITE / (845) 895-2055 • FAX: (888) FERRITE / (845) 895-2629
(888) 324-7748

• www.fair-rite.com
• E-Mail: ferrites@fair-rite.com

Rods

Pressed Fair-Rite rods are used extensively in high-energy storage designs. These rods can also be used for inductive components that require temperature stability or have to accommodate large dc bias conditions.

- The "A" dimension can be centerless ground to tighter tolerances.
- Figure 2 rods are also used in the assembled bobbins, listed on page 104, Figure 5. These rods have a 0.6mm (.024") maximum chamfer on the end faces.
- A separate class of rods for antenna and RFID applications is listed on pages 100 - 101.
- See the graphs on pages 98 and 99 for information on rod permeability and typical changes in inductance vs temperature for the same rod in different materials.
- For any rod requirement not listed here, feel free to contact our customer service group for availability and pricing.
- Explanation of Part Numbers: Digits 1&2 = product class, 3&4 = material grade.

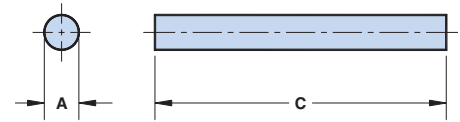

Figure 1

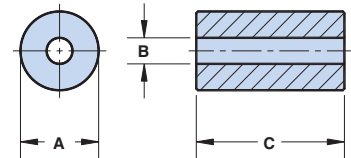

Figure 2

Low Permeability, 61 ($\mu_j=125$) Material

Dimensions (Bold numbers are in millimeters, light numbers are nominal in inches.)

Part Number	Fig.	A	C	Wt (g)
4061129011	1	3.25-0.25 .125	12.7±0.4 .500	.5
4061272011	1	6.35±0.25 .250	19.05±0.75 .750	2.9
4061287011	1	6.35±0.25 .250	22.1±0.7 .870	3.4
4061276011	1	6.35±0.25 .250	25.4±0.7 1.000	3.9
4061266011	1	6.35±0.25 .250	38.1±0.75 1.500	5.8
4061378111	1	9.5±0.3 .374	25.4±0.8 1.000	8.6

Low Permeability, High Saturation 52 ($\mu_j=250$) Material

Part Number	Fig.	A	C	Wt (g)
4052077111	1	2.0±0.13 .079	15.0±0.3 .591	.23
4052098411	1	2.5±0.13 .098	15.0±0.3 .591	.35
4052111011	1	3.0±0.13 .118	20.0±0.4 .787	.7
4052155611	1	4.0±0.15 .157	25.0±0.5 .984	1.5
4052195211	1	5.0±0.2 .197	25.0±0.5 .984	2.4
4052235211	1	6.0±0.25 .236	30.0±0.6 1.181	4.1
4052251111	1	6.5±0.25 .256	30.0±0.6 1.181	4.8

Fair-Rite Products Corp.

PO Box J, One Commercial Row, Wallkill, NY 12589-0288

Phone: (888) FAIR RITE / (845) 895-2055 • FAX: (888) FERRITE / (845) 895-2629 • www.fair-rite.com
(888) 324-7748 (888) 337-7483 • E-Mail: ferrites@fair-rite.com

Rods

Temperature Stable, 33 ($\mu_j=600$) Material

Dimensions (Bold numbers are in millimeters, light numbers are nominal in inches.)

Part Number	Fig.	A	C	Wt (g)
4033129021	1	3.25 - 0.25 .125	12.7±0.4 .500	.5
4033122011	1	3.25 - 0.25 .125	25.4±0.75 1.000	0.9
4033276011	1	6.35±0.25 .250	25.4±0.75 1.000	3.9
4033266011	1	6.35±0.25 .250	38.1±0.75 1.500	5.8

Medium Permeability, 77 ($\mu_j=2000$) & 78 ($\mu_j=2300$) Materials

Part Number	Fig.	A	B	C	Wt (g)
4077122011	1	3.25 - 0.25 .125	—	25.4±0.75 1.000	1.0
4077172011	1	4.6 - 0.3 .175	—	22.2±0.75 .875	1.7
4077272011	1	6.35±0.25 .250	—	19.05±0.75 .750	2.9
4077276011	1	6.35±0.25 .250	—	25.4±0.75 1.000	3.8
4077292011	1	6.35±0.25 .250	—	28.6±0.75 1.125	4.4
4077296011	1	6.35±0.25 .250	—	31.75±0.75 1.250	4.8
4077266011	1	6.35±0.25 .250	—	38.1±0.75 1.500	5.8
4077312911	1	8.0±0.35 .315	—	38.1±0.75 1.500	9.2
4077374711	1	9.45±0.2 .372	—	31.75±0.75 1.250	11
4078375111	1	9.45±0.2 .372	—	38.1±0.75 1.500	13
4077375411	1	9.45±0.2 .372	—	41.3±0.8 1.625	14
4077375211	1	9.45±0.2 .372	—	50.8±1.0 2.000	17
4078377511	1	9.5±0.25 .374	—	70.0±1.5 2.756	24
4077485111	1	12.3±0.4 .485	—	31.75±0.75 1.250	18
4077484611	1	12.3±0.4 .485	—	41.3±0.8 1.625	27
4277142009	2	9.0±0.3 .354	3.2±0.1 .126	13.5±0.3 .532	3.6
4277182209	2	11.0±0.3 .433	3.2±0.1 .126	15.5±0.35 .610	6.5
4277242409	2	13.0±0.3 .512	3.2±0.1 .126	17.5±0.4 .690	10
4278282509	2	17.0±0.4 .670	4.2±0.15 .165	18.95±0.45 .746	19.4
4277352509	2	21.0±0.5 .825	6.9±0.4 .272	18.95±0.45 .746	28
4277353509	2	21.0±0.5 .825	6.9±0.4 .272	29.0±0.6 1.140	43
4278453509	2	27.0±0.5 1.063	9.0±0.3 .354	27.0±0.6 1.064	66

Fair-Rite Products Corp.

PO Box J, One Commercial Row, Wallkill, NY 12589-0288

Phone: (888) FAIR RITE / (845) 895-2055 • FAX: (888) FERRITE / (845) 895-2629 • www.fair-rite.com
(888) 324-7748 (888) 337-7483 • E-Mail: ferrites@fair-rite.com

Rod Information

Figure 1 shows the rod permeability as a function of the length to diameter ratio for the six materials available in rods.

Figures 3, 4 and 5 illustrate typical temperature behavior of wound rods. Wound rods in 33 and 77 material yield the best temperature stable inductors, see Figure 4. Both show a typical inductance change of < 1% over the -40 to 120 C temperature range. The parts have a L/D ratio of 8.1. Lower ratios will change less. This is shown in detail in Figure 5 for the same 52 material but with the L/D ratio as the parameter. A lower ratio means a lower rod permeability but with improved temperature stability.

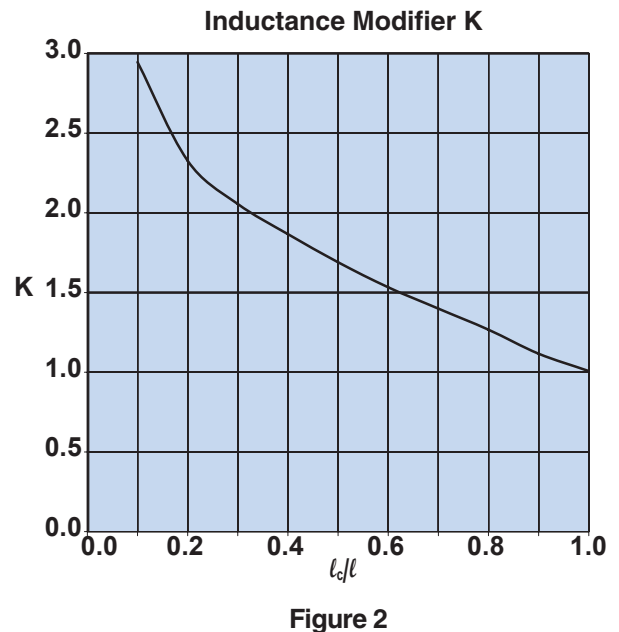
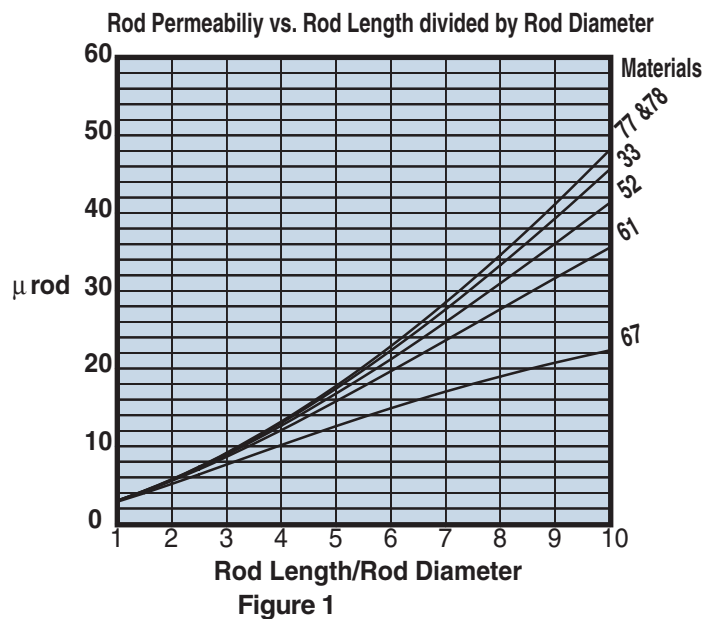

Wound Rod Inductance Calculations.

To calculate the inductance of a wound rod the following formula can be used. $L = k\mu_0\mu_{rod} \frac{N^2 A_e}{l} 10^4 (\mu H)$

Where: K = Inductance modifier

$$\mu_0 = 4\pi 10^{-7}$$

μ_{rod} = rod permeability found in Figure 1.

N = Number of turns

A_e = Cross sectional area of the rod (cm²)

l = Length of the rod (cm)

l_c = Length of the winding (cm)

Fair-Rite Products Corp.

PO Box J, One Commercial Row, Wallkill, NY 12589-0288

Phone: (888) FAIR RITE / (845) 895-2055 • FAX: (888) FERRITE / (845) 895-2629
(888) 324-7748 (888) 337-7483

• www.fair-rite.com
• E-Mail: ferrites@fair-rite.com

Rod Information

The inductance modifier is found in Figure 2. The ratio winding length divided by the rod length will give the inductance modifier. If the rod is totally wound the $K = 1$. Shorter but centered windings will yield higher K values.

Using the rod 3061990871 as an example.

For this rod the length over diameter ratio is 8.33 and for 61 material Figure 1 gives a Urod of 29. The rod has an $A_e = 0.0707 \text{ cm}^2$ and $l = 2.5 \text{ cm}$.

A winding of 80 turns of 30 AWG wire will yield a fully wound rod, therefore $K = 1$. Using the above formula the calculated inductance is 65.96 μH .

The same rod but wound with 50 turns of the 30 AWG wire has a winding length of 1.5 cm. The inductance modifier is $1.5/2.5 = 0.60$, which results from Figure 2 in a K value of 1.51.

Again with the above formula we calculated an inductance of 38.9 μH .

The measured values for both windings were 66.95 and 39.50 μH respectively.

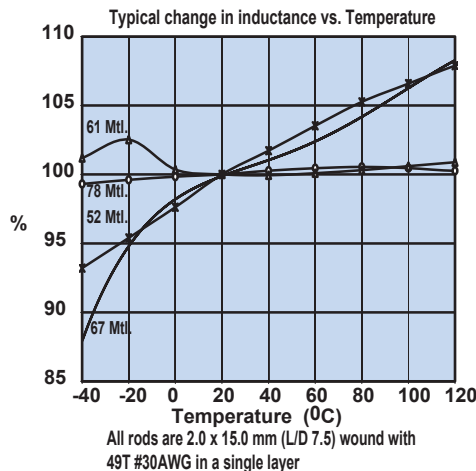

Figure 3

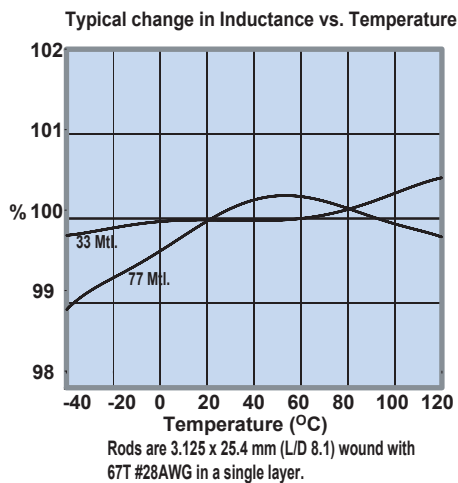

Figure 4

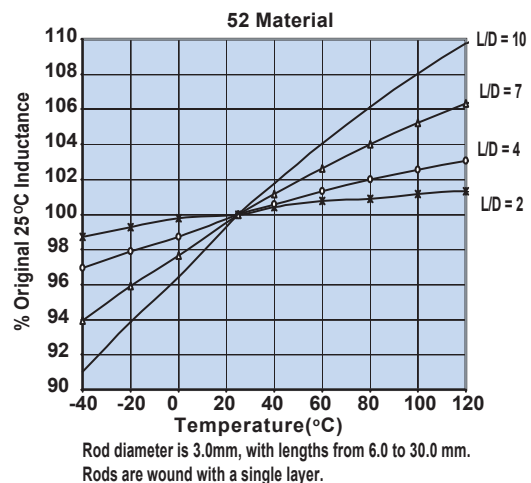

Figure 5

Fair-Rite Products Corp.

Phone: (888) FAIR RITE / (845) 895-2055 • FAX: (888) FERRITE / (845) 895-2629
 (888) 324-7748 (888) 337-7483

PO Box J, One Commercial Row, Wallkill, NY 12589-0288

• www.fair-rite.com
 • E-Mail: ferrites@fair-rite.com

Antenna/RFID Rods

These rods are designed for use in antenna and RFID transponder applications. Rods are available in three materials to cover a frequency range from 50 kHz to 25 MHz. Suggested frequency ranges: 78 material < 200 kHz, 61 material 0.2 - 5.0 MHz and 67 material > 5.0 MHz.

- See graphs on pages 98 and 99 with temperature information of these rods in the three materials.
- For rods used for energy storage applications see pages 96 and 97
- Rods can be supplied with a Parylene C coating. Parylene coated rods have a "4" as the last digit. Parylene C is RoHS compliant.
- For any rod requirement not listed here, feel free to contact our customer service group for availability and pricing.
- The "Antenna/RFID Kit" (part number 0199000024) contains a selection of these rods. See page 67.
- Explanation of Part Numbers: Digits 1&2 = product class, 3&4 = material grade, the last digit 1 = uncoated rod and 4 = Parylene coated rod.

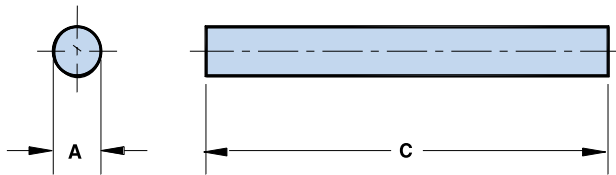

Low Permeability, 67 ($\mu_i = 40$) & 61 ($\mu_i = 125$) Materials

Dimensions (Bold numbers are in millimeters, light numbers are nominal in inches.)

Part Number	A	C	μ_{ROD}	Wt (g)	Ae(cm ²)
3067990821	0.75±0.025 .030	7.5±0.15 .295	22	.02	0.00442
3061990821	0.75±0.025 .030	7.5±0.15 .295	35	.02	0.00442
3067990831	1.0±0.025 .039	10.0±0.2 .394	22	.04	0.00785
3061990831	1.0±0.025 .039	10.0±0.2 .394	35	.04	0.00785
3067990841	1.5±0.025 .059	15.0±0.3 .591	22	.13	0.0177
3061990841	1.5±0.025 .059	15.0±0.3 .591	35	.13	0.0177
3067990851	2.0±0.025 .079	15.0±0.3 .591	18	.23	0.0314
3061990851	2.0±0.025 .079	15.0±0.3 .591	25	.23	0.0314
3067990861	2.5±0.025 .098	20.0±0.4 .787	19	.47	0.0491
3061990861	2.5±0.025 .098	20.0±0.4 .787	27	.47	0.0491
3067990871	3.0±0.04 .118	25.0±0.5 .984	20	.85	0.0707
3061990871	3.0±0.04 .118	25.0±0.5 .984	29	.85	0.0707

Fair-Rite Products Corp.

PO Box J, One Commercial Row, Wallkill, NY 12589-0288

Phone: (888) FAIR RITE / (845) 895-2055 • FAX: (888) FERRITE / (845) 895-2629
(888) 324-7748 (888) 337-7483

• www.fair-rite.com
• E-Mail: ferrites@fair-rite.com

Antenna/RFID Rods

Low Permeability, 67 ($\mu_j = 40$) & 61 ($\mu_j = 125$) Materials

Dimensions (Bold numbers are in millimeters, light numbers are nominal in inches.)

Part Number	A	C	μ_{ROD}	Wt (g)	Ae (cm ²)
3067990881	4.0±0.04 .157	30.0±0.6 1.181	18	1.8	0.126
3061990881	4.0±0.04 .157	30.0±0.6 1.181	25	1.8	0.126
3061990891	5.0±0.04 .197	35.0±0.7 1.378	24	3.3	0.196
3061990901	6.0±0.05 .236	40.0±0.8 1.575	22	5.4	0.283
3061990911	8.0±0.05 .315	45.0±0.9 1.772	24	11.9	0.503

Medium Permeability, 78 ($\mu_j = 2300$) Material

Part Number	A	C	μ_{ROD}	Wt (g)	Ae (cm ²)
3078990821	0.75±0.025 .030	7.5±0.15 .295	48	.02	0.00442
3078990831	1.0±0.025 .039	10.0±0.2 .394	48	.04	0.00785
3078990841	1.5±0.025 .059	15.0±0.3 .591	48	.13	0.0177
3078990851	2.0±0.025 .079	15.0±0.3 .591	31	.23	0.0314
3078990861	2.5±0.025 .098	20.0±0.4 .787	34	.47	0.0491
3078990871	3.0±0.04 .118	25.0±0.5 .984	36	.85	0.0707
3078990881	4.0±0.04 .157	30.0±0.6 1.181	31	1.8	0.126
3078990891	5.0±0.04 .197	35.0±0.7 1.378	29	3.3	0.196
3078990901	6.0±0.05 .236	40.0±0.8 1.575	26	5.4	0.283
3078990911	8.0±0.05 .315	45.0±0.9 1.772	20	11.9	0.503

Fair-Rite Products Corp.

PO Box J, One Commercial Row, Wallkill, NY 12589-0288

Phone: (888) FAIR RITE / (845) 895-2055 • FAX: (888) FERRITE / (845) 895-2629 • www.fair-rite.com
(888) 324-7748 (888) 337-7483 • E-Mail: ferrites@fair-rite.com



Fair-Rite Products Corp.

Phone: (888) FAIR RITE / (845) 895-2055 • FAX: (888) FERRITE / (845) 895-2629
(888) 324-7748 (888) 337 -7483

PO Box J, One Commercial Row, Wallkill, NY 12589-0288

- www.fair-rite.com
- E-Mail: ferrites@fair-rite.com

Tack Bobbins

This patented core design, patent number 6,073,869, of a self-centered tack bobbin core that can be easily assembled into bobbin cores. The design will accommodate heavy wire, pre-wound coils that might be difficult to wind directly on bobbins.

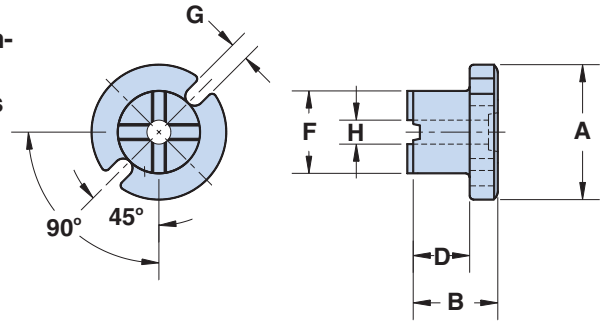

- Tack cores are tested for A_L value at 1kHz, <10 gauss.
- Tack cores can also be purchased as assembled parts. (See pages 104-105).
- For any tack bobbin core requirement not listed in the catalog, please contact our customer service group for availability and pricing.
- Explanation of Part Numbers: Digits 1&2 = product class, 3&4 = material grade, 5&6 = diameter (mm) and 7&8 = height (mm).

Dimensions (Bold numbers are in millimeters, light numbers are nominal in inches.)

Part Number	A	B*	D	F	G	H	Wt (g)
7177141009	14.0±0.35 .551	10.0±0.35 .394	6.25±0.15 .247	9.0±0.3 .354	2.0±0.3 .079	3.2±0.1 .126	4.2
7177181009	18.0±0.45 .709	10.0±0.35 .394	6.25±0.15 .247	11.0±0.3 .433	2.5±0.3 .098	3.2±0.1 .126	6.5
7177181109	18.0±0.45 .709	11.0±0.35 .433	7.25±0.15 .285	11.0±0.3 .433	2.5±0.3 .098	3.2±0.1 .126	7.0
7177241009	24.0±0.6 .945	10.0±0.35 .394	6.25±0.15 .247	13.0±0.3 .512	3.0±0.3 .118	3.2±0.1 .126	11
7177241209	24.0±0.6 .945	12.0±0.35 .472	8.25±0.20 .325	13.0±0.3 .512	3.0±0.3 .118	3.2±0.1 .126	12

Magnetic Parameters (For assembly of two tack bobbin cores.)

Part Number	A_L (nH)±10%	A_L min. @ NI (At)	N/AWG	A_w (cm ²)
7177141009	55	47 325	81/28	.31
7177181009	66	56 400	50/20	.44
7177181109	65	55 410	95/22	.51
7177241009	88	75 430	50/18	.69
7177241209	84	72 450	67/18	.91

Symbols **Definitions**
 A_L Inductance factor ($\frac{L}{N^2}$)
 NI Value of dc ampere-turns
 A_w Winding Area
 N/AWG Number of Turns/
 wire size for test coil

Fair-Rite Products Corp.

PO Box J, One Commercial Row, Wallkill, NY 12589-0288

Phone: (888) FAIR RITE / (845) 895-2055 • FAX: (888) FERRITE / (845) 895-2629 • www.fair-rite.com
 (888) 324-7748 (888) 337-7483 • E-Mail: ferrites@fair-rite.com

Bobbins

Bobbins are an economical and well-proven core design for many applications where relatively low but stable inductance values are required.

- For higher frequency designs, use a small bobbin (Figure 1) in 43 material.
- For power applications, bobbins in 77 material are specified for A_L and dc bias limits.
- Bobbins in Figures 2-5 can be supplied with a uniform coating of thermo-set plastic coating which can withstand a minimum breakdown of 500Vrms. This coating will change the dimensions a maximum of 0.5mm (.020"). The last digit of the thermo-set plastic coated part is an "8". Bobbins in Figure 5 can be supplied with notches at one end only. This changes the last digit of the part number to a "7". Bobbins of this type can also be provided with a thermo-set plastic coating. The last digit becomes a "6".
- The listed dimensions are for assembled bobbins without thermo-set plastic.
- Bobbins are tested for AL value at 1kHz < 10 gauss.
- Bobbins 9677142089 through 9677242489 can also be purchased as tack bobbin cores. (See page 103).
- For any bobbin requirement not listed in the catalog, please contact our customer service group for availability and pricing,

Dimensions (Bold numbers are in millimeters, light numbers are nominal in inches.)

Innovators
Again
Patented
Design

Part Number	Fig.	A	B	D	F	G	H	Wt (g)
9643001165	1	5.05 - 0.15 .196	12.7±0.25 .500	10.0+0.3 .400	2.65+0.1 .107	0.5±0.1 .020	1.0+0.1 .042	1.3
9677001165	1	5.05 - 0.15 .196	12.7±0.25 .500	10.0+0.3 .400	2.65+0.1 .107	0.5±0.1 .020	1.0+0.1 .042	1.3
9643001015	1	9.55 - 0.15 .373	19.0±0.7 .750	12.7±0.15 .500	4.65+0.2 .187	1.0+0.25 .045	1.0+0.1 .042	6.7
9677001015	1	9.55 - 0.15 .373	19.0±0.7 .750	12.7±0.15 .500	4.65+0.2 .187	1.0+0.25 .045	1.0+0.1 .042	6.7
9843000104	2	8.05±0.2 .317	19.0±0.4 .750	12.7±0.25 .500	5.55+0.25 .225	2.7+0.25 .111	8.05±0.2 .317	3.0
9877000104	2	8.05±0.2 .317	19.0±0.4 .750	12.7±0.25 .500	5.55+0.25 .225	2.7+0.25 .111	8.05±0.2 .317	3.0
9877000204	3	11.3±0.25 .445	24.4±0.5 .960	17.8+0.9 .718	7.5±0.25 .295	7.25±0.25 .285	11.2±0.4 .440	8.4
9677142089	4	14.0±0.35 .551	20.0±0.7 .788	12.5±0.3 .492	9.0±0.3 .354	2.0±0.3 .079	3.2±0.1 .126	8.5
9677182089	4	18.0±0.45 .709	20.0±0.7 .788	12.5±0.3 .492	11.0±0.3 .433	2.5±0.3 .098	3.2±0.1 .126	13
9677182289	4	18.0±0.45 .709	22.0±0.7 .866	14.5±0.35 .570	11.0±0.3 .433	2.5±0.3 .098	3.2±0.1 .126	14
9677242089	4	24.0±0.6 .945	20.0±0.7 .788	12.5±0.3 .492	13.0±0.3 .512	3.0±0.3 .118	3.2±0.1 .126	22
9677242489	4	24.0±0.6 .945	24.0±0.7 .946	16.5±0.4 .650	13.0±0.3 .512	3.0±0.3 .118	3.2±0.1 .126	24
9677282009	5	28.0±0.7 1.102	20.0±0.7 .788	12.5±0.3 .492	17.0±0.4 .670	3.0±0.3 .118	4.2±0.15 .165	33
9677282509	5	28.0±0.7 1.102	25.0±0.7 .985	18.0±0.45 .708	17.0±0.4 .670	3.0±0.3 .118	4.2±0.15 .165	38
9677352509	5	35.0±0.9 1.381	25.0±0.7 .985	18.0±0.45 .708	21.0±0.5 .825	3.0±0.3 .118	6.9±0.4 .272	56
9677353509	5	35.0±0.9 1.381	35.0±0.75 1.380	28.0±0.6 1.100	21.0±0.5 .825	3.0±0.3 .118	6.9±0.4 .272	71
9677453509	5	45.0±1.0 1.771	35.0±0.75 1.380	26.0±0.6 1.024	27.0±0.5 1.063	3.6±0.3 .142	9.0±0.3 .354	127

Fair-Rite Products Corp.

PO Box J, One Commercial Row, Wallkill, NY 12589-0288

Phone: (888) FAIR RITE / (845) 895-2055 • FAX: (888) FERRITE / (845) 895-2629 • www.fair-rite.com
 (888) 324-7748 (888) 337-7483 • E-Mail: ferrites@fair-rite.com

Bobbins

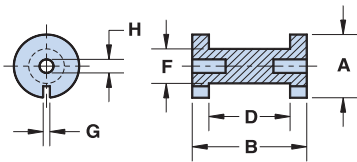

Figure 1

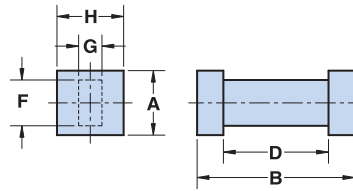

Figure 2

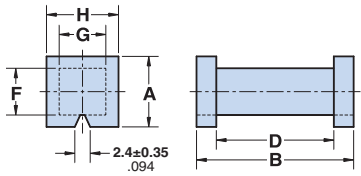

Figure 3

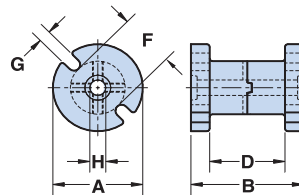

Figure 4

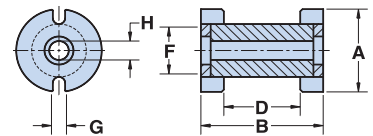

Figure 5

Magnetic Parameters

Part Number	A_L (nH)±10%	A_L min.@ NI (At)		N/AWG	A_w (cm ²)
9643001165	17.5	-		30/24	.12
9677001165	18	15	90	30/24	.12
9643001015	38	-		75/24	.30
9677001015	39	33	125	75/24	.30
9843000104	38	-		50/28	.33
9877000104	39	33	125	36/24	.33
9877000204	49	42	360	45/24	.37
9677142089	55	47	325	81/28	.31
9677182089	66	56	400	50/20	.44
9677182289	65	55	410	95/22	.51
9677242089	88	75	430	50/18	.69
9677242489	84	72	450	67/18	.91
9677282009	100	86	470	40/18	.69
9677282509	95	81	520	55/18	.99
9677352509	124	106	580	55/16	1.27
9677353509	110	94	700	70/16	1.97
9677453509	142	121	750	100/16	2.34

Symbols

Symbols	Definitions
A_L	Inductance factor ($\frac{L}{N^2}$)
NI	Value of dc ampere-turns
A_w	Winding Area
N/AWG	Number of Turns/ wire size for test coil

Toroids

A ring configuration provides the ultimate utilization of the intrinsic ferrite material properties. Toroidal cores are used in a wide variety of applications such as power input filters, ground-fault interrupters, common-mode filters and in pulse and broadband transformers.

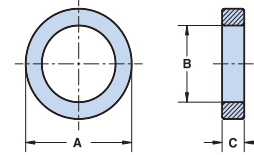

- Toroids are listed by initial permeability classes and increasing dimension of the inside diameter.
- All toroidal cores are supplied burnished to break sharp edges.
- Toroids are tested for A_L values at 10 kHz. The square loop 85 material toroids are specified to a squareness ratio and not to an A_L value.
- Toroids with an outside diameter of 9.5mm (.375") or smaller can be supplied Parylene C coated. The Parylene coating will increase the "A" and "C" dimensions and decrease the "B" dimension a maximum of 0.038mm (.0015"). The ninth digit of a Parylene coated toroid part number is a "1". See page 124 for the material characteristics of Parylene C. Parylene C coating is RoHS compliant.
- Toroids with an outside diameter of 9.5mm (.375") or larger can be supplied with a uniform coating of thermo-set plastic coating. This coating will increase the "A" and "C" dimensions and decrease the "B" dimension a maximum of 0.5mm (.020"). The 9th digit of the thermo-set plastic coated toroid part number is a "2". Thermo-set plastic coating is RoHS compliant.
- Thermo-set plastic coated parts can withstand a minimum breakdown voltage of 1000 Vrms, uniformly applied across the "C" dimension of the toroid.
- For any toroidal core requirement not listed in the catalog, please contact our customer service department for availability and pricing.
- Explanation of Part Numbers: Digits 1&2 = product class, 3&4 = material grade, 9th digit 1 = Parylene coating, 2 = thermo-set plastic coating,

Symbols	Definitions
$\Sigma l/A$	Core constant
ℓ_e	Effective path length
A_e	Effective cross-sectional area
V_e	Effective core volume
A_L	Inductance factor ($\frac{\ell_e}{N^2}$)

Low Permeability, 67 ($\mu_i=40$) & 61 ($\mu_i=125$) Materials

Dimensions (Bold numbers are in millimeters, light numbers are nominal in inches.)

Part Number	A	B	C*	Wt (g)	$\Sigma l/A(\text{cm}^{-1})$	ℓ_e (cm)	$A_e(\text{cm}^2)$	$V_e(\text{cm}^3)$	$A_L(\text{nH})$ $\pm 25\%$
5961000101	5.95 - 0.25 .230	3.05±0.1 .120	1.65 - 0.25 .060	.14	63.8	1.30	0.020	0.027	25
5967000201	9.5±0.2 .375	4.75±0.15 .187	3.3 - 0.25 .125	.83	28.6	2.07	0.072	0.15	18
5961000201	9.5±0.2 .375	4.75±0.15 .187	3.3 - 0.25 .125	.83	28.6	2.07	0.072	0.15	55
5967000301	12.7±0.25 .500	7.15±0.2 .281	4.9 - 0.25 .188	2.0	22.9	2.95	0.129	0.38	22
5961000301	12.7±0.25 .500	7.15±0.2 .281	4.9 - 0.25 .188	2.0	22.9	2.95	0.129	0.38	69
5967001101	12.7±0.25 .500	7.9±0.2 .312	6.35±0.25 .250	2.4	20.8	3.12	0.150	0.47	24
5961001101	12.7±0.25 .500	7.9±0.2 .312	6.35±0.25 .250	2.4	20.8	3.12	0.150	0.47	75
5967001901	12.7±0.25 .500	7.9±0.2 .312	12.7±0.35 .500	4.7	10.4	3.12	0.299	0.93	48
5961001901	12.7±0.25 .500	7.9±0.2 .312	12.7±0.35 .500	4.7	10.4	3.12	0.299	0.93	150
5961004901	16.0±0.4 .630	9.6±0.3 .378	6.35±0.25 .250	4.0	19.4	3.85	0.199	0.77	80
5967000601	21.0±0.35 .825	13.2±0.3 .520	6.35±0.25 .250	6.4	21.3	5.2	0.243	1.26	24
5961000601	21.0±0.35 .825	13.2±0.3 .520	6.35±0.25 .250	6.4	21.3	5.2	0.243	1.26	75

* This dimension may be modified to suit specific applications.

Fair-Rite Products Corp.

PO Box J, One Commercial Row, Wallkill, NY 12589-0288

Phone: (888) FAIR RITE / (845) 895-2055 • FAX: (888) FERRITE / (845) 895-2629 • www.fair-rite.com
(888) 324-7748 (888) 337 -7483 • E-Mail: ferrites@fair-rite.com

Toroids

Symbols	Definitions
$\Sigma l/A$	Core constant
ℓ_e	Effective path length
A_e	Effective cross-sectional area
V_e	Effective core volume
A_L	Inductance factor ($\frac{L}{N^2}$)

Low Permeability, 67 ($\mu_i=40$) & 61 ($\mu_i=125$) Materials

Dimensions (Bold numbers are in millimeters, light numbers are nominal in inches.)

Part Number	A	B	C*	Wt (g)	$\Sigma l/A(\text{cm}^{-1})$	ℓ_e (cm)	$A_e(\text{cm}^2)$	$V_e(\text{cm}^3)$	$A_L(\text{nH})$ $\pm 25\%$
5961000501	21.0±0.35 .825	13.2±0.3 .520	11.9±0.4 .468	12	11.4	5.2	0.46	2.36	135
5967001801	22.1±0.4 .870	13.7±0.3 .540	6.35±0.25 .250	7.2	20.7	5.4	0.262	1.42	24
5961001801	22.1±0.4 .870	13.7±0.3 .540	6.35±0.25 .250	7.2	20.7	5.4	0.262	1.42	75
5961001001	29.0±0.65 1.142	19.0±0.5 .748	7.5±0.25 .295	13	19.8	7.3	0.37	2.70	80
5961001201	29.0±0.65 1.142	19.0±0.5 .748	13.85±0.3 .545	26	10.7	7.3	0.68	5.0	145
5961001701	31.75±0.75 1.250	19.05±0.5 .750	9.5±0.3 .375	23	12.9	7.6	0.59	4.5	120
5967002701	35.55±0.75 1.400	23.0±0.55 .900	12.7±0.5 .500	33	11.2	8.9	0.79	7.0	45
5961002701	35.55±0.75 1.400	23.0±0.55 .900	12.7±0.5 .500	33	11.2	8.9	0.79	7.0	140
5967003801	61.0±1.3 2.400	35.55±0.85 1.400	12.7±0.5 .500	106	9.2	14.5	1.58	22.8	55
5961003801	61.0±1.3 2.400	35.55±0.85 1.400	12.7±0.5 .500	106	9.2	14.5	1.58	22.8	170

Low - Medium Permeability, 43 ($\mu_i=800$) Material

Part Number	A	B	C*	Wt (g)	$\Sigma l/A(\text{cm}^{-1})$	ℓ_e (cm)	$A_e(\text{cm}^2)$	$V_e(\text{cm}^3)$	$A_L(\text{nH})$ $\pm 20\%$
5943000801	3.95±0.15 .155	2.15±0.15 .088	1.4 - 0.25 .050	.05	87.6	0.92	0.011	0.0097	117
5943002101	4.95 - 0.25 .190	2.2±0.15 .090	1.4 - 0.25 .050	.09	69.2	1.04	0.015	0.0157	150
5943000101	5.95 - 0.25 .230	3.05±0.1 .120	1.65 - 0.25 .060	.14	63.8	1.30	0.020	0.027	158
5943000201	9.5±0.2 .375	4.75±0.15 .187	3.3 - 0.25 .125	.83	28.6	2.07	0.072	0.15	350
5943000301	12.7±0.25 .500	7.15±0.2 .281	4.9 - 0.25 .188	2.0	22.9	2.95	0.129	0.38	440
5943001101	12.7±0.25 .500	7.9±0.2 .312	6.35±0.25 .250	2.4	20.8	3.12	0.150	0.47	480
5943001901	12.7±0.25 .500	7.9±0.2 .312	12.7±0.35 .500	4.7	10.4	3.12	0.299	0.93	965
5943005101	16.0±0.4 .630	9.6±0.3 .378	4.75 - 0.25 .182	2.8	26.6	3.85	0.145	0.56	375
5943004901	16.0±0.4 .630	9.6±0.3 .378	6.35±0.25 .250	4.0	19.4	3.85	0.199	0.77	520
5943000601	21.0±0.35 .825	13.2±0.3 .520	6.35±0.25 .250	6.4	21.3	5.2	0.243	1.26	470
5943000501	21.0±0.35 .825	13.2±0.3 .520	11.9±0.4 .468	12	11.4	5.2	0.46	2.36	885

* This dimension may be modified to suit specific applications.

Fair-Rite Products Corp.

PO Box J, One Commercial Row, Wallkill, NY 12589-0288

Phone: (888) FAIR RITE / (845) 895-2055 • FAX: (888) FERRITE / (845) 895-2629 • www.fair-rite.com
(888) 324-7748 (888) 337-7483 • E-Mail: ferrites@fair-rite.com

Toroids

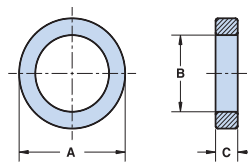

Low - Medium Permeability, 43 ($\mu_i=800$) Material

Dimensions (Bold numbers are in millimeters, light numbers are nominal in inches.)

Part Number**	A	B	C*	Wt (g)	$\Sigma l/A(\text{cm}^{-1})$	$\ell_e(\text{cm})$	$A_e(\text{cm}^2)$	$V_e(\text{cm}^3)$	$A_L(\text{nH})$ $\pm 20\%$
5943001801	22.1±0.4 .870	13.7±0.3 .540	6.35±0.25 .250	7.2	20.7	5.4	0.262	1.42	485
5943007601	22.1±0.4 .870	13.7±0.3 .540	12.7±0.45 .500	15	10.3	5.4	0.52	2.83	970
5943001301	25.4±0.6 1.000	15.5±0.5 .610	6.35±0.25 .250	9.6	20.0	6.2	0.308	1.90	500
5943001401	25.4±0.6 1.000	15.5±0.5 .610	8.15±0.3 .320	12	15.1	6.2	0.41	2.52	645
5943006401	25.4±0.6 1.000	15.5±0.5 .610	12.7±0.5 .500	19	10.0	6.2	0.62	3.80	1000
5943001001	29.0±0.65 1.142	19.0±0.5 .748	7.5±0.25 .295	13	19.8	7.3	0.37	2.70	510
5943001201	29.0±0.65 1.142	19.0±0.5 .748	13.85±0.3 .545	26	10.7	7.3	0.68	5.0	950
5943001601	31.1±0.75 1.225	19.05±0.5 .750	7.9±0.3 .312	18	16.2	7.6	0.47	3.53	620
5943001701	31.75±0.75 1.250	19.05±0.5 .750	9.5±0.3 .375	23	12.9	7.6	0.59	4.5	775
5943002701	35.55±0.75 1.400	23.0±0.55 .900	12.7±0.5 .500	33	11.2	8.9	0.79	7.0	885
5943018601	43.6±1.0 1.717	23.1±0.50 .909	18.0±0.5 .709	90	5.5	9.8	1.78	17.5	1550 Min.
5943017301	48.3±1.0 1.902	31.8±0.6 1.252	19.05±0.35 .750	94	7.9	12.2	1.55	18.9	1080 Min.
5943018701	56.3±1.2 2.217	32.7±0.7 1.287	18.0±0.5 .709	135	6.4	13.3	2.07	27.6	1330 Min.
5943003801	61.0±1.3 2.400	35.55±0.85 1.400	12.7±0.5 .500	106	9.2	14.5	1.58	22.8	1075
5943011101	73.65±1.5 2.900	38.85±0.75 1.530	12.7±0.4 .500	188	7.8	16.7	2.15	35.9	1100 Min.
5943015901	100.0±2.0 3.937	55.0±1.2 2.165	12.7±0.3 .500	320	8.3	23.0	2.77	63.7	1030 Min.
5943017501	102.6±2.1 4.039	63.5±1.3 2.500	15.85±0.35 .624	360	8.3	25.1	3.0	70.5	1035 Min.

Medium Permeability, 77 ($\mu_i=2000$) & 78 ($\mu_i=2300$) Materials

Part Number**	A	B	C*	Wt (g)	$\Sigma l/A(\text{cm}^{-1})$	$\ell_e(\text{cm})$	$A_e(\text{cm}^2)$	$V_e(\text{cm}^3)$	$A_L(\text{nH})$ $\pm 20\%$
5977000801	3.95±0.15 .155	2.15±0.15 .088	1.4 - 0.25 .050	.05	87.6	0.92	0.011	0.0097	285
5978000801	3.95±0.15 .155	2.15±0.15 .088	1.4 - 0.25 .050	.05	87.6	0.92	0.011	0.0097	335

* This dimension may be modified to suit specific applications.

** Bold part numbers designate preferred parts.

Fair-Rite Products Corp.

PO Box J, One Commercial Row, Wallkill, NY 12589-0288

Phone: (888) FAIR RITE / (845) 895-2055 • FAX: (888) FERRITE / (845) 895-2629 • www.fair-rite.com
(888) 324-7748 (888) 337-7483 • E-Mail: ferrites@fair-rite.com

Toroids

Symbols	Definitions
$\Sigma l/A$	Core constant
ℓ_e	Effective path length
A_e	Effective cross-sectional area
V_e	Effective core volume
A_L	Inductance factor ($\frac{L}{N^2}$)

Medium Permeability, 77 ($\mu_i=2000$) & 78 ($\mu_i=2300$) Materials

Dimensions (Bold numbers are in millimeters, light numbers are nominal in inches.)

Part Number**	A	B	C*	Wt (g)	$\Sigma l/A(\text{cm}^{-1})$	ℓ_e (cm)	$A_e(\text{cm}^2)$	$V_e(\text{cm}^3)$	$A_L(\text{nH})$ $\pm 20\% \pm$
5977002101	4.95 - 0.25 .190	2.2±0.15 .090	1.4 - 0.25 .050	.09	69.2	1.04	0.015	0.0157	360
5978002101	4.95 - 0.25 .190	2.2±0.15 .090	1.4 - 0.25 .050	.09	69.2	1.04	0.015	0.0157	440
5977000101	5.95 - 0.25 .230	3.05±0.1 .120	1.65 - 0.25 .060	.14	63.8	1.30	0.020	0.027	390
5978000101	5.95 - 0.25 .230	3.05±0.1 .120	1.65 - 0.25 .060	.14	63.8	1.30	0.020	0.027	455
5977000201	9.5±0.2 .375	4.75±0.15 .187	3.3 - 0.25 .125	.83	28.6	2.07	0.072	0.15	880
5978000201	9.5±0.2 .375	4.75±0.15 .187	3.3 - 0.25 .125	.83	28.6	2.07	0.072	0.15	1010
5977000301	12.7±0.25 .500	7.15±0.2 .281	4.9 - 0.25 .188	2.0	22.9	2.95	0.129	0.38	1100
5978000301	12.7±0.25 .500	7.15±0.2 .281	4.9 - 0.25 .188	2.0	22.9	2.95	0.129	0.38	1260
5977001101	12.7±0.25 .500	7.9±0.2 .312	6.35±0.25 .250	2.4	20.8	3.12	0.150	0.47	1200
5978001101	12.7±0.25 .500	7.9±0.2 .312	6.35±0.25 .250	2.4	20.8	3.12	0.150	0.47	1390
5977001901	12.7±0.25 .500	7.9±0.2 .312	12.7±0.35 .500	4.7	10.4	3.12	0.299	0.93	2400
5978001901	12.7±0.25 .500	7.9±0.2 .312	12.7±0.35 .500	4.7	10.4	3.12	0.299	0.93	2775
5977005101	16.0±0.4 .630	9.6±0.3 .378	4.75 - 0.25 .182	2.8	26.6	3.85	0.145	0.56	940
5978005101	16.0±0.4 .630	9.6±0.3 .378	4.75 - 0.25 .182	2.8	26.6	3.85	0.145	0.56	1090
5977004901	16.0±0.4 .630	9.6±0.3 .378	6.35±0.25 .250	4.0	19.4	3.85	0.199	0.77	1300
5978004901	16.0±0.4 .630	9.6±0.3 .378	6.35±0.25 .250	4.0	19.4	3.85	0.199	0.77	1490
5977000601	21.0±0.35 .825	13.2±0.3 .520	6.35±0.25 .250	6.4	21.3	5.2	0.243	1.26	1175
5978000601	21.0±0.35 .825	13.2±0.3 .520	6.35±0.25 .250	6.4	21.3	5.2	0.243	1.26	1355
5977000501	21.0±0.35 .825	13.2±0.3 .520	11.9±0.4 .468	12	11.4	5.2	0.46	2.36	2200
5978000501	21.0±0.35 .825	13.2±0.3 .520	11.9±0.4 .468	12	11.4	5.2	0.46	2.36	2540
5977001801	22.1±0.4 .870	13.7±0.3 .540	6.35±0.25 .250	7.2	20.7	5.4	0.262	1.42	1200
5978001801	22.1±0.4 .870	13.7±0.3 .540	6.35±0.25 .250	7.2	20.7	5.4	0.262	1.42	1400

* This dimension may be modified to suit specific applications.

* AL tolerance for plastic coated toroids is +20%, -25%.

** Bold part numbers designate preferred parts.

Fair-Rite Products Corp.

PO Box J, One Commercial Row, Wallkill, NY 12589-0288

Phone: (888) FAIR RITE / (845) 895-2055 • FAX: (888) FERRITE / (845) 895-2629
(888) 324-7748 (888) 337-7483

• www.fair-rite.com
• E-Mail: ferrites@fair-rite.com

Toroids

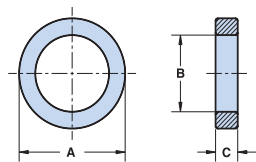

Medium Permeability, 77 ($\mu_i=2000$) & 78 ($\mu_i=2300$) Materials

Dimensions (Bold numbers are in millimeters, light numbers are nominal in inches.)

Part Number**	A	B	C*	Wt (g)	$\Sigma l/A(\text{cm}^{-1})$	$\ell_e(\text{cm})$	$A_e(\text{cm}^2)$	$V_e(\text{cm}^3)$	$A_L(\text{nH})$ $\pm 20\% +$
5977007601	22.1±0.4 .870	13.7±0.3 .540	12.7±0.45 .500	15	10.3	5.4	0.52	2.83	2425
5978007601	22.1±0.4 .870	13.7±0.3 .540	12.7±0.45 .500	15	10.3	5.4	0.52	2.83	2795
5977001301	25.4±0.6 1.000	15.5±0.5 .610	6.35±0.25 .250	9.6	20.0	6.2	0.308	1.90	1250
5978001301	25.4±0.6 1.000	15.5±0.5 .610	6.35±0.25 .250	9.6	20.0	6.2	0.308	1.90	1445
5977001401	25.4±0.6 1.000	15.5±0.5 .610	8.15±0.3 .320	12	15.1	6.2	0.41	2.52	1600
5978001401	25.4±0.6 1.000	15.5±0.5 .610	8.15±0.3 .320	12	15.1	6.2	0.41	2.52	1850
5977006401	25.4±0.6 1.000	15.5±0.5 .610	12.7±0.5 .500	19	10.0	6.2	0.62	3.80	2500
5978006401	25.4±0.6 1.000	15.5±0.5 .610	12.7±0.5 .500	19	10.0	6.2	0.62	3.80	2885
5977001001	29.0±0.65 1.142	19.0±0.5 .748	7.5±0.25 .295	13	19.8	7.3	0.37	2.70	1275
5978001001	29.0±0.65 1.142	19.0±0.5 .748	7.5±0.25 .295	13	19.8	7.3	0.37	2.70	1460
5977001201	29.0±0.65 1.142	19.0±0.5 .748	13.85±0.3 .545	26	10.7	7.3	0.68	5.0	2350
5978001201	29.0±0.65 1.142	19.0±0.5 .748	13.85±0.3 .545	26	10.7	7.3	0.68	5.0	2695
5977001601	31.1±0.75 1.225	19.05±0.5 .750	7.9±0.3 .312	18	16.2	7.6	0.47	3.53	1550
5978001601	31.1±0.75 1.225	19.05±0.5 .750	7.9±0.3 .312	18	16.2	7.6	0.47	3.53	1780
5977001701	31.75±0.75 1.250	19.05±0.5 .750	9.5±0.3 .375	23	12.9	7.6	0.59	4.5	1950
5978001701	31.75±0.75 1.250	19.05±0.5 .750	9.5±0.3 .375	23	12.9	7.6	0.59	4.5	2230
5977002701	35.55±0.75 1.400	23.0±0.55 .900	12.7±0.5 .500	33	11.2	8.9	0.79	7.0	2250
5978002701	35.55±0.75 1.400	23.0±0.55 .900	12.7±0.5 .500	33	11.2	8.9	0.79	7.0	2545

* This dimension may be modified to suit specific applications.

* AL tolerance for plastic coated toroids is +20%, -25%.

** Bold part numbers designate preferred parts.

Fair-Rite Products Corp.

PO Box J, One Commercial Row, Wallkill, NY 12589-0288

Phone: (888) FAIR RITE / (845) 895-2055 • FAX: (888) FERRITE / (845) 895-2629
(888) 324-7748 (888) 337-7483

• www.fair-rite.com
• E-Mail: ferrites@fair-rite.com

Toroids

Symbols	Definitions
$\Sigma l/A$	Core constant
ℓ_e	Effective path length
A_e	Effective cross-sectional area
V_e	Effective core volume
A_L	Inductance factor ($\frac{L}{N^2}$)

Medium Permeability, 77 ($\mu_i=2000$) & 78 ($\mu_i=2300$) Materials

Dimensions (Bold numbers are in millimeters, light numbers are nominal in inches.)

Part Number**	A	B	C*	Wt (g)	$\Sigma l/A(\text{cm}^{-1})$	ℓ_e (cm)	$A_e(\text{cm}^2)$	$V_e(\text{cm}^3)$	$A_L(\text{nH})$ $\pm 25\% +$
5978018601	43.6±1.0 1.717	23.1±0.50 .909	18.0±0.5 .709	90	5.5	9.8	1.78	17.5	5260
5978017301	48.3±1.0 1.902	31.8±0.6 1.252	19.05±0.35 .750	94	7.9	12.2	1.55	18.9	3670
5978018701	56.3±1.2 2.217	32.7±0.7 1.287	18.0±0.5 .709	135	6.4	13.3	2.07	27.6	4500
5977003801	61.0±1.3 2.400	35.55±0.85 1.400	12.7±0.5 .500	106	9.2	14.5	1.58	22.8	2725
5978003801	61.0±1.3 2.400	35.55±0.85 1.400	12.7±0.5 .500	106	9.2	14.5	1.58	22.8	3155
5977011101	73.65±1.5 2.900	38.85±0.75 1.530	12.7±0.4 .500	188	7.8	16.7	2.15	35.9	3225
5978011101	73.65±1.5 2.900	38.85±0.75 1.530	12.7±0.4 .500	188	7.8	16.7	2.15	35.9	3740
5978015901	100.0±2.0 3.937	55.0±1.2 2.165	12.7±0.3 .500	320	8.3	23.0	2.77	63.7	3500
5978017501	102.6±2.1 4.039	63.5±1.3 2.500	15.85±0.35 .624	360	8.3	25.1	3.0	70.5	3500
5978008001	152.4±3.1 6.000	68.6±1.5 2.701	19.05±0.5 .750	1240	4.1	31.3	7.6	237	7000
5978014001	101.6±2.1 4.000	75.2±1.5 2.961	24.75±0.55 .974	425	8.4	27.4	3.24	88.7	3425

* AL tolerance for plastic coated toroids is +25%, -30%.

High Permeability, 75 ($\mu_i=5000$) & 76 ($\mu_i=10,000$) Materials

Part Number**	A	B	C*	Wt (g)	$\Sigma l/A(\text{cm}^{-1})$	ℓ_e (cm)	$A_e(\text{cm}^2)$	$V_e(\text{cm}^3)$	$A_L(\text{nH})$ $\pm 20\%$
5975000801	3.95±0.15 .155	2.15±0.15 .088	1.4 - 0.25 .050	.05	87.6	0.92	0.011	0.0097	715
5976000801	3.95±0.15 .155	2.15±0.15 .088	1.4 - 0.25 .050	.05	87.6	0.92	0.011	0.0097	1430±30%
5975002101	4.95 - 0.25 .190	2.2±0.15 .090	1.4 - 0.25 .050	.09	69.2	1.04	0.015	0.0157	900
5976002101	4.95 - 0.25 .190	2.2±0.15 .090	1.4 - 0.25 .050	.09	69.2	1.04	0.015	0.0157	1800±30%
5975000101	5.95 - 0.25 .230	3.05±0.1 .120	1.65 - 0.25 .060	.14	63.8	1.30	0.020	0.027	975
5976000101	5.95 - 0.25 .230	3.05±0.1 .120	1.65 - 0.25 .060	.14	63.8	1.30	0.020	0.027	1950±30%
5975000201	9.5±0.2 .375	4.75±0.15 .187	3.3 - 0.25 .125	.83	28.6	2.07	0.072	0.15	2200
5976000201	9.5±0.2 .375	4.75±0.15 .187	3.3 - 0.25 .125	.83	28.6	2.07	0.072	0.15	4400±30%

* This dimension may be modified to suit specific applications.

** Bold part numbers designate preferred parts.

Fair-Rite Products Corp.

PO Box J, One Commercial Row, Wallkill, NY 12589-0288

Phone: (888) FAIR RITE / (845) 895-2055 • FAX: (888) FERRITE / (845) 895-2629 • www.fair-rite.com
(888) 324-7748 (888) 337-7483 • E-Mail: ferrites@fair-rite.com

Toroids

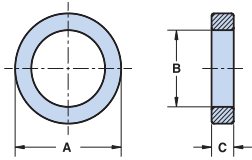

High Permeability , 75 ($\mu_i = 5000$) Material

Dimensions (Bold numbers are in millimeters, light numbers are nominal in inches.)

Part Number	A	B	C*	Wt (g)	$\Sigma l/A(\text{cm}^{-1})$	$l_e(\text{cm})$	$A_e(\text{cm}^2)$	$V_e(\text{cm}^3)$	$A_L(\text{nH})$ $\pm 20\% +$
5975000301	12.7±0.25 .500	7.15±0.2 .281	4.9 - 0.25 .188	2.0	22.9	2.95	0.129	0.38	2725
5975001101	12.7±0.25 .500	7.9±0.2 .312	6.35±0.25 .250	2.4	20.8	3.12	0.150	0.47	3000
5975001901	12.7±0.25 .500	7.9±0.2 .312	12.7±0.35 .500	4.7	10.4	3.12	0.299	0.93	6000
5975005101	16.0±0.4 .630	9.6±0.3 .378	4.75 - 0.25 .182	2.8	26.6	3.85	0.145	0.56	2350
5975004901	16.0±0.4 .630	9.6±0.3 .378	6.35±0.25 .250	4.0	19.4	3.85	0.199	0.77	3225
5975000601	21.0±0.35 .825	13.2±0.3 .520	6.35±0.25 .250	6.4	21.3	5.2	0.243	1.26	2950
5975000501	21.0±0.35 .825	13.2±0.3 .520	11.9±0.4 .468	12	11.4	5.2	0.46	2.36	5500
5975001801	22.1±0.4 .870	13.7±0.3 .540	6.35±0.25 .250	7.2	20.7	5.4	0.262	1.42	3025
5975007601	22.1±0.4 .870	13.7±0.3 .540	12.7±0.45 .500	15	10.3	5.4	0.52	2.83	6100
5975001301	25.4±0.6 1.000	15.5±0.5 .610	6.35±0.25 .250	9.6	20.0	6.2	0.308	1.90	3140
5975001401	25.4±0.6 1.000	15.5±0.5 .610	8.15±0.3 .320	12	15.1	6.2	0.41	2.52	4000
5975006401	25.4±0.6 1.000	15.5±0.5 .610	12.7±0.5 .500	19	10.0	6.2	0.62	3.80	6250
5975001001	29.0±0.65 1.142	19.0±0.5 .748	7.5±0.25 .295	13	19.8	7.3	0.37	2.70	3175
5975001601	31.1±0.75 1.225	19.05±0.5 .750	7.9±0.3 .312	18	16.2	7.6	0.47	3.53	3850
5975001701	31.75±0.75 1.250	19.05±0.5 .750	9.5±0.3 .375	23	12.9	7.6	0.59	4.5	4850
5975002701	35.55±0.75 1.400	23.0±0.55 .900	12.7±0.5 .500	33	11.2	8.9	0.79	7.0	5500
5975003801	61.0±1.3 2.400	35.55±0.85 1.400	12.7±0.5 .500	106	9.2	14.5	1.58	22.8	6850
5975011101	73.65±1.5 2.900	38.85±0.75 1.530	12.7±0.4 .500	188	7.8	16.7	2.15	35.9	8100

* This dimension may be modified to suit specific applications.

* A_L tolerance for plastic coated toroids is +20%, -25%.

Fair-Rite Products Corp.

PO Box J, One Commercial Row, Wallkill, NY 12589-0288

Phone: (888) FAIR RITE / (845) 895-2055 • FAX: (888) FERRITE / (845) 895-2629
(888) 324-7748

• www.fair-rite.com
• E-Mail: ferrites@fair-rite.com

Toroids

The Fair-Rite grade 85 ferrite is a unique square loop high frequency material. Toroids from this material are used in magnetic amplifiers and saturable reactors

Symbols	Definitions
$\Sigma l/A$	Core constant
ℓ_e	Effective path length
A_e	Effective cross-sectional area
V_e	Effective core volume

Square Loop, 85 Material

Dimensions (Bold numbers are in millimeters, light numbers are nominal in inches.)

Part Number	A	B	C*	Wt (g)	Radial Resonant Frequency** (kHz)	$\Sigma l/A$ (cm ⁻¹)	ℓ_e (cm)	A_e (cm ²)	V_e (cm ³)
5985010101	2.55±0.1 .100	1.2±0.15 .050	1.4 - 0.25 .050	.02	984	71.3	0.56	0.0078	0.0043
5985010201	3.5±0.1 .138	1.7±0.15 .070	1.4 - 0.25 .050	.05	687	72.3	0.77	0.011	0.0081
5985000801	3.95±0.15 .155	2.15±0.15 .088	1.4 - 0.25 .050	.06	589	87.6	0.92	0.011	0.0097
5985002101	4.95±0.25 .190	2.2±0.15 .090	1.4 - 0.25 .050	.09	510	69.2	1.04	0.015	0.0157
5985000101	5.95±0.25 .230	3.05±0.1 .120	1.65±0.25 .060	.14	408	63.8	1.30	0.020	0.027
5985015501	6.35±0.2 .250	3.2±0.2 .125	12.7±0.35 .500	1.5	381	7.14	1.38	0.194	0.27
5985000201	9.5±0.2 .375	4.75±0.15 .187	3.3±0.25 .125	.83	254	28.6	2.07	0.072	0.15
5985016001	9.5±0.2 .375	5.7±0.2 .224	3.3±0.25 .125	.70	239	38.4	2.29	0.059	0.136
5985001101	12.7±0.25 .500	7.9±0.20 .312	6.35±0.25 .250	2.4	176	20.8	3.12	0.150	0.47
5985013501	14.0±0.25 .551	9.0±0.3 .354	5.0±0.15 .197	2.2	158	28.4	3.50	0.123	0.43
5985004901	16.0±0.4 .630	9.6±0.3 .378	6.35±0.25 .250	4.0	142	19.4	3.85	0.199	0.77
5985001801	22.1±0.4 .870	13.7±0.3 .540	6.35±0.25 .250	7.2	101	20.7	5.4	0.262	1.42
5985001301	25.4±0.6 1.000	15.5±0.5 .610	6.35±0.25 .250	9.6	89	20.0	6.2	0.308	1.90

* This dimension may be modified to suit specific applications.

** It is not advised to drive the toroidal cores within 10% of their radial resonant frequency. Cracks or even breakage of the cores could result.

Fair-Rite Products Corp.

PO Box J, One Commercial Row, Wallkill, NY 12589-0288

Phone: (888) FAIR RITE / (845) 895-2055 • FAX: (888) FERRITE / (845) 895-2629 • www.fair-rite.com
(888) 324-7748 (888) 337-7483 • E-Mail: ferrites@fair-rite.com

Pot Cores

The pot core has found wide application in all types of inductive components. The core configuration provides a high degree of self-shielding. It also facilitates gapping to enhance its utility for a variety of magnetic designs.

- The part number is for a single core.
- Pot cores can be supplied with the center post gapped to a mechanical dimension.
- Pot cores can also be gapped to an A_L value. These parts will be supplied as sets. Figure 1 pot core sets that have an airgap in one of the core halves will be marked with a white marking on the backwall. Pot core sets that are gapped symmetrically will not be marked.
- A_L value is measured at 1 kHz, at < 10 gauss.
- The pot cores shown in Figure 1 are in conformance with IEC 60133.
- For any pot core requirement not listed here or for gapped pot core designs feel free to contact our customer service department.
- Explanation of Part Numbers: Digits 1&2 = product class, 3&4 = material grade, 5&6 = core OD in mm's, 7&8 = height of assembled cores in mm's, 9&10 = 21 for ungapped core halves.

Dimensions (Bold numbers are in millimeters, light numbers are nominal in inches.)

Part Number	Fig.	A	B	C	D	E	F	G	H	J Min.
5678090521	1	9.15±0.15 .360	2.7 - 0.15 .103	6.75±0.25 .266	1.8±0.15 .074	7.5±0.25 .300	3.8±0.1 .150	2.0±0.4 .079	2.1±0.1 .083	-
5678110721	1	11.1±0.2 .437	3.3 - 0.15 .127	7.25±0.25 .285	2.2 + 0.15 .090	9.2±0.2 .362	4.6±0.1 .181	2.5±0.35 .105	2.1±0.1 .083	-
5678140821	1	14.05±0.25 .553	4.25 - 0.15 .164	9.5±0.25 .374	2.9±0.1 .114	11.8±0.2 .465	5.9±0.1 .232	3.3±0.4 .130	3.1±0.1 .122	0.2 .008
5678181121	1	18.0±0.4 .709	5.35 - 0.15 .208	12.3±0.3 .484	3.7±0.1 .146	15.15±0.25 .596	7.45±0.15 .293	3.85±0.6 .152	3.1±0.1 .122	0.3 .012
5678221321	1	21.6±0.4 .850	6.7±0.1 .264	14.9±0.35 .587	4.7±0.1 .185	18.2±0.3 .717	9.25±0.15 .364	3.1±0.6 .122	4.55±0.15 .179	0.4 .016
5678261621	1	25.5±0.5 1.004	8.05±0.1 .317	18.15±0.4 .715	5.6±0.1 .220	21.6±0.4 .850	11.3±0.2 .445	3.6±0.6 .142	5.55±0.15 .218	0.5 .020
5678301921	1	30.0±0.5 1.181	9.4±0.1 .370	21.5±1.0 .846	6.6±0.1 .260	25.4±0.4 1.000	13.3±0.2 .524	4.2±0.6 .165	5.55±0.15 .218	0.6 .024
5678362221	1	35.6±0.6 1.402	10.85±0.15 .427	26.0±1.0 1.024	7.4±0.1 .291	30.4±0.5 1.197	15.9±0.3 .626	5.1±0.5 .201	5.55±0.15 .218	0.6 .024
5678422921	1	42.4±0.7 1.669	14.8±0.2 .582	32.0±1.0 1.260	10.3±0.15 .406	36.3±0.7 1.429	17.4±0.3 .685	5.1±0.6 .201	5.55±0.15 .218	0.95 .038

Fair-Rite Products Corp.

PO Box J, One Commercial Row, Wallkill, NY 12589-0288

Phone: (888) FAIR RITE / (845) 895-2055 • FAX: (888) FERRITE / (845) 895-2629
(888) 324-7748

• www.fair-rite.com
• E-Mail: ferrites@fair-rite.com

Pot Cores

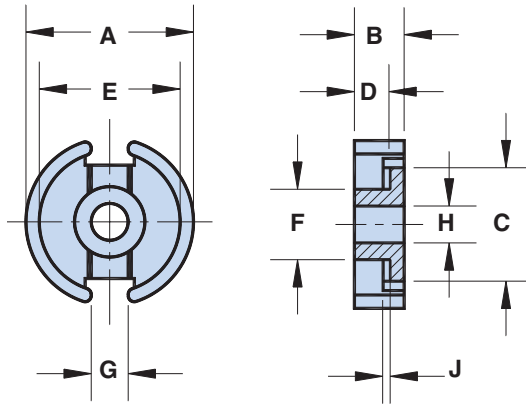

Figure 1

Symbols	Definitions
$\Sigma l/A$	Core constant
l_e	Effective path length
A_e	Effective cross-sectional area
V_e	Effective core volume
A_L	Inductance factor ($\frac{L}{N^2}$)

Magnetic Parameters

Part Number	$\Sigma l/A(\text{cm}^{-1})$	$l_e(\text{cm})$	$A_e(\text{cm}^2)$	$V_e(\text{cm}^3)$	$A_{\text{min}}(\text{cm}^2)$	Wt (g)	A_L (nH)
5678090521	12.6	1.24	.098	.122	.078	.40	800 Min.
5678110721	10.0	1.59	.159	.252	.131	.75	1220 Min.
5678140821	8.0	2.00	.250	.50	.197	1.9	1575 Min.
5678181121	6.0	2.59	.43	1.12	.360	4.7	2350 Min.
5678221321	5.0	3.16	.63	2.00	.51	7.2	3000 Min.
5678261621	4.0	3.76	.93	3.46	.76	12	3900 Min.
5678301921	3.30	4.5	1.36	6.1	1.14	19	4900 Min.
5678362221	2.58	5.2	2.02	10.6	1.74	34	6550 Min.
5678422921	2.58	6.9	2.66	18.2	2.10	51	6950 Min.

Fair-Rite Products Corp.

PO Box J, One Commercial Row, Wallkill, NY 12589-0288

Phone: (888) FAIR RITE / (845) 895-2055 • FAX: (888) FERRITE / (845) 895-2629
(888) 324-7748 (888) 337-7483

• www.fair-rite.com
• E-Mail: ferrites@fair-rite.com

E Cores

The E core geometry offers an economical design approach for a wide range of inductive applications. The 77 and 78 materials are used in a variety power designs. The high permeability 75 material is utilized for matching and broad-band transformers.

- Part number is for a single core.
- E cores can be supplied with the center post gapped to a mechanical dimension. E cores can also be gapped to an AL value. These cores will be supplied as sets. For any gapped E core requirement contact our customer service group.
- AL value is measured at 1 kHz, < 10 gauss.
- See "The Effect of Direct Current on the Inductance of a Ferrite Core" on page 132, Figure 4 for information on AL vs. gap length.
- Fair-Rite equivalents to lamination sizes:

E2829	94..019002	E375	94..375002
E187	94..016002	E21	94..500002
E2425	94..015002	E625	94..625002
- Explanation of Part Numbers: Digits 1&2 = product class and 3&4 = material grade.

Dimensions (Bold numbers are in millimeters, light numbers are nominal in inches.)

Part Number*	A	B	C	D	E Min.	F	Wt (g)
9477019002	12.7±0.25 .500	5.8 - 0.25 .224	3.45 - 0.5 .125	4.1±0.15 .161	9.3 .365	3.3 - 0.25 .125	.8
9478019002	12.7±0.25 .500	5.8 - 0.25 .224	3.45 - 0.5 .125	4.1±0.15 .161	9.3 .365	3.3 - 0.25 .125	.8
9475019002	12.7±0.25 .500	5.8 - 0.25 .224	3.45 - 0.5 .125	4.1±0.15 .161	9.3 .365	3.3 - 0.25 .125	.8
9477020002	12.7±0.25 .500	5.8 - 0.25 .224	6.6 - 0.5 .250	4.1±0.15 .161	9.3 .365	3.3 - 0.25 .125	1.5
9478020002	12.7±0.25 .500	5.8 - 0.25 .224	6.6 - 0.5 .250	4.1±0.15 .161	9.3 .365	3.3 - 0.25 .125	1.5
9475020002	12.7±0.25 .500	5.8 - 0.25 .224	6.6 - 0.5 .250	4.1±0.15 .161	9.3 .365	3.3 - 0.25 .125	1.5
9477016002	19.3±0.4 .760	8.2 - 0.25 .318	4.75±0.20 .187	5.6 + 0.25 .225	14.3 .562	4.95 - 0.35 .187	2.4
9478016002	19.3±0.4 .760	8.2 - 0.25 .318	4.75±0.20 .187	5.6 + 0.25 .225	14.3 .562	4.95 - 0.35 .187	2.4
9475016002	19.3±0.4 .760	8.2 - 0.25 .318	4.75±0.20 .187	5.6 + 0.25 .225	14.3 .562	4.95 - 0.35 .187	2.4
9477012002	19.3±0.4 .760	8.2 - 0.25 .318	9.5±0.25 .375	5.6 + 0.25 .225	14.3 .562	4.95 - 0.35 .187	4.8
9478012002	19.3±0.4 .760	8.2 - 0.25 .318	9.5±0.25 .375	5.6 + 0.25 .225	14.3 .562	4.95 - 0.35 .187	4.8
9475012002	19.3±0.4 .760	8.2 - 0.25 .318	9.5±0.25 .375	5.6 + 0.25 .225	14.3 .562	4.95 - 0.35 .187	4.8
9477015002	25.4±0.5 1.000	9.8 - 0.3 .380	6.6 - 0.5 .250	6.35 + 0.25 .255	18.8 .740	6.6 - 0.5 .250	5.4
9478015002	25.4±0.5 1.000	9.8 - 0.3 .380	6.6 - 0.5 .250	6.35 + 0.25 .255	18.8 .740	6.6 - 0.5 .250	5.4

*Bold part numbers designate preferred parts.

Fair-Rite Products Corp.

PO Box J, One Commercial Row, Walkill, NY 12589-0288

Phone: (888) FAIR RITE / (845) 895-2055 • FAX: (888) FERRITE / (845) 895-2629
(888) 324-7748 (888) 337-7483

• www.fair-rite.com
• E-Mail: ferrites@fair-rite.com

E Cores

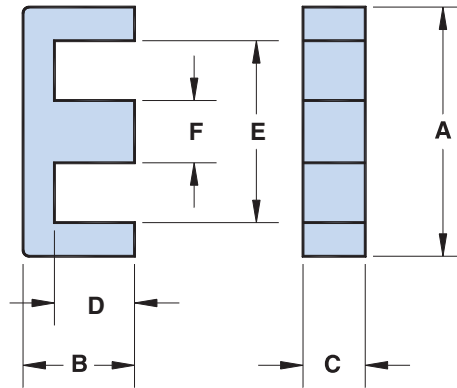

Magnetic Parameters

Part Number	$\Sigma l/A(\text{cm}^{-1})$	$l_e(\text{cm})$	$A_e(\text{cm}^2)$	$V_e(\text{cm}^3)$	$A_L(\text{nH})$
9477019002	27.6	2.77	.101	.279	475 Min.
9478019002	27.6	2.77	.101	.279	525 Min.
9475019002	27.6	2.77	.101	.279	1290±25%
9477020002	13.8	2.77	.202	.56	1000 Min.
9478020002	13.8	2.77	.202	.56	1075 Min.
9475020002	13.8	2.77	.202	.56	2600±25%
9477016002	17.9	4.0	.225	.90	825 Min.
9478016002	17.9	4.0	.225	.90	925 Min.
9475016002	17.9	4.0	.225	.90	2300±25%
9477012002	8.92	4.0	.45	1.80	1700 Min.
9478012002	8.92	4.0	.45	1.80	1900 Min.
9475012002	8.92	4.0	.45	1.80	4600±25%
9477015002	12.06	4.9	.40	1.95	1300 Min.
9478015002	12.06	4.9	.40	1.95	1450 Min.

Symbols	Definitions
$\Sigma l/A$	Core constant
l_e	Effective path length
A_e	Effective cross-sectional area
V_e	Effective core volume
A_L	Inductance factor ($\frac{l_e}{\mu_r}$)

Fair-Rite Products Corp. PO Box J, One Commercial Row, Wallkill, NY 12589-0288

Phone: (888) FAIR RITE / (845) 895-2055 • FAX: (888) FERRITE / (845) 895-2629 • www.fair-rite.com
 (888) 324-7748 (888) 337-7483 • E-Mail: ferrites@fair-rite.com

E Cores

Dimensions (Bold numbers are in millimeters, light numbers are nominal in inches.)

Part Number*	A	B	C	D	E Min.	F	Wt (g)
9475015002	25.4±0.5 1.000	9.8 - 0.3 .380	6.6 - 0.5 .250	6.35 + 0.25 .255	18.8 .740	6.6 - 0.5 .250	5.4
9477014002	25.4±0.5 1.000	9.8 - 0.3 .380	12.7±0.25 .500	6.35 + 0.25 .255	18.8 .740	6.6 - 0.5 .250	11
9478014002	25.4±0.5 1.000	9.8 - 0.3 .380	12.7±0.25 .500	6.35 + 0.25 .255	18.8 .740	6.6 - 0.5 .250	11
9475014002	25.4±0.5 1.000	9.8 - 0.3 .380	12.7±0.25 .500	6.35 + 0.25 .255	18.8 .740	6.6 - 0.5 .250	11
9477034002	25.4±0.5 1.000	16.0±0.25 .630	6.6 - 0.5 .250	12.7 + 0.35 .507	18.8 .740	6.6 - 0.5 .250	8.4
9478034002	25.4±0.5 1.000	16.0±0.25 .630	6.6 - 0.5 .250	12.7 + 0.35 .507	18.8 .740	6.6 - 0.5 .250	8.4
9477017002	28.0±0.6 1.102	10.6 - 0.25 .413	11.2±0.25 .440	5.6 + 0.25 .225	19.2 .756	7.7±0.25 .303	13
9478017002	28.0±0.6 1.102	10.6 - 0.25 .413	11.2±0.25 .440	5.6 + 0.25 .225	19.2 .756	7.7±0.25 .303	13
9477375002	34.55±0.7 1.360	14.5 - 0.25 .567	9.25±0.25 .365	9.5 + 0.25 .380	25.5 1.004	9.4±0.15 .370	16
9478375002	34.55±0.7 1.360	14.5 - 0.25 .567	9.25±0.25 .365	9.5 + 0.25 .380	25.5 1.004	9.4±0.15 .370	16
9477500002	40.75±0.8 1.604	16.5±0.15 .650	12.2±0.4 .480	10.15 + 0.25 .405	27.8 1.095	12.2±0.35 .480	30
9478500002	40.75±0.8 1.604	16.5±0.15 .650	12.2±0.4 .480	10.15 + 0.25 .405	27.8 1.095	12.2±0.35 .480	30
9477036002	42.85±0.75 1.687	21.15 - 0.25 .828	15.85 - 0.75 .609	14.95 + 0.25 .593	30.4 1.197	11.9±0.25 .468	48
9478036002	42.85±0.75 1.687	21.15 - 0.25 .828	15.85 - 0.75 .609	14.95 + 0.25 .593	30.4 1.197	11.9±0.25 .468	48
9477625002	47.1±0.75 1.855	19.85 - 0.4 .773	15.6±0.25 .615	12.0+0.25 .477	31.6 1.245	15.6±0.25 .615	57
9478625002	47.1±0.75 1.855	19.85 - 0.4 .773	15.6±0.25 .615	12.0+0.25 .477	31.6 1.245	15.6±0.25 .615	57

*Bold part numbers designate preferred parts.

Fair-Rite Products Corp.

PO Box J, One Commercial Row, Wallkill, NY 12589-0288

Phone: (888) FAIR RITE / (845) 895-2055 • FAX: (888) FERRITE / (845) 895-2629
(888) 324-7748

• www.fair-rite.com
• E-Mail: ferrites@fair-rite.com

E Cores

Magnetic Parameters

Part Number	$\Sigma l/A(\text{cm}^{-1})$	$l_e(\text{cm})$	$A_e(\text{cm}^2)$	$V_e(\text{cm}^3)$	$A_L(\text{nH})$
9475015002	12.06	4.9	.40	1.95	3500±25%
9477014002	6.03	4.9	.80	3.92	2625 Min.
9478014002	6.03	4.9	.80	3.92	2950 Min.
9475014002	6.03	4.9	.80	3.92	7000±25%
9477034002	18.0	7.3	.40	2.98	870 Min.
9478034002	18.0	7.3	.40	2.98	990 Min.
9477017002	5.0	4.8	.96	4.6	3000 Min.
9478017002	5.0	4.8	.96	4.6	3340 Min.
9477375002	7.92	6.9	.86	6.0	2050 Min.
9478375002	7.92	6.9	.86	6.0	2350 Min.
9477500002	5.12	7.6	1.50	11.5	3225 Min.
9478500002	5.12	7.6	1.50	11.5	3750 Min.
9477036002	5.34	9.8	1.84	18.1	3175 Min.
9478036002	5.34	9.8	1.84	18.1	3600 Min.
9477625002	3.74	8.9	2.37	21.1	4500 Min.
9478625002	3.74	8.9	2.37	21.1	5100 Min.

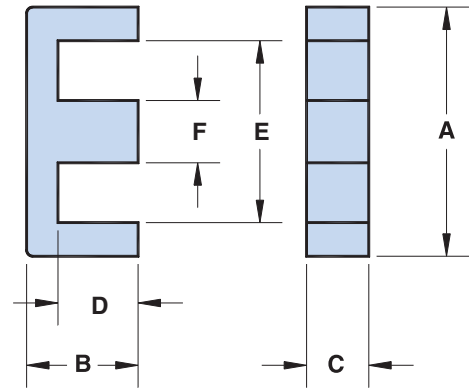

Fair-Rite Products Corp. PO Box J, One Commercial Row, Wallkill, NY 12589-0288

Phone: (888) FAIR RITE / (845) 895-2055 • FAX: (888) FERRITE / (845) 895-2629 • www.fair-rite.com
 (888) 324-7748 (888) 337-7483 • E-Mail: ferrites@fair-rite.com

I Cores

I cores are available in three MnZn ferrite materials, 77, 78 and 75. They can be used with several E core sizes.

- Part number is for a single core.
- For any I core requirement not listed in the catalog, please contact our customer service group.
- Explanation of Part Numbers: Digits 1&2 = product class and 3&4 = material grade.

Dimensions (Bold numbers are in millimeters, light numbers are nominal in inches.)

Part Number*	A	B	C	Wt (g)
9377020002	25.4±0.6 1.000	3.3 - 0.25 .125	6.6 - 0.5 .250	2.7
9378020002	25.4±0.6 1.000	3.3 - 0.25 .125	6.6 - 0.5 .250	2.7
9375020002	25.4±0.6 1.000	3.3 - 0.25 .125	6.6 - 0.5 .250	2.7
9377024002	25.4±0.6 1.000	6.5 - 0.25 .250	6.6 - 0.5 .250	5.4
9378024002	25.4±0.6 1.000	6.5 - 0.25 .250	6.6 - 0.5 .250	5.4
9377036002	42.85±0.75 1.687	6.1 - 0.25 .235	15.85 - 0.75 .609	21
9378036002	42.85±0.75 1.687	6.1 - 0.25 .235	15.85 - 0.75 .609	21

*Bold part numbers designate preferred parts.

Fair-Rite Products Corp.

PO Box J, One Commercial Row, Wallkill, NY 12589-0288

Phone: (888) FAIR RITE / (845) 895-2055 • FAX: (888) FERRITE / (845) 895-2629
(888) 324-7748 (888) 337 -7483

• www.fair-rite.com
• E-Mail: ferrites@fair-rite.com

I Cores

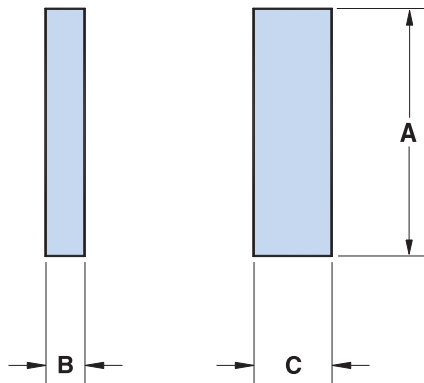

Symbols	Definitions
$\Sigma l/A$	Core constant
ℓ_e	Effective path length
A_e	Effective cross-sectional area
V_e	Effective core volume
A_L	Inductance factor ($\frac{L}{N^2}$)

Magnetic Parameters

Part Number	$\Sigma l/A(\text{cm}^{-1})$	$\ell_e(\text{cm})$	$A_e(\text{cm}^2)$	$V_e(\text{cm}^3)$	$A_L(\text{nH})$	
9377020002	8.82	3.56	.40	1.44	1575 Min.	with 9477015002, page 118
9378020002	8.82	3.56	.40	1.44	1725 Min.	with 9478015002, page 118
9375020002	8.82	3.56	.40	1.44	4200±25%	with 9475015002, page 118
9377024002**	8.64	3.48	.40	1.41	1700 Min.	with 9477015002, page 118
9378024002	8.64	3.48	.40	1.41	1950 Min.	with 9478015002, page 118
9377036002	3.68	6.8	1.84	12.5	4275 Min.	with 9477036002, page 120
9378036002	3.68	6.8	1.84	12.5	4800 Min.	with 9478036002, page 120

** May be used with U cores, see page 122

Fair-Rite Products Corp. PO Box J, One Commercial Row, Wallkill, NY 12589-0288

Phone: (888) FAIR RITE / (845) 895-2055 • FAX: (888) FERRITE / (845) 895-2629 • www.fair-rite.com
 (888) 324-7748 (888) 337-7483 • E-Mail: ferrites@fair-rite.com

U Cores

The U core offers an economical core design with a nearly uniform cross-sectional area.

In a power ferrite material they are frequently used in output chokes, power input filters and transformers for switched-mode power supplies and HF fluorescent ballasts.

- Part number is for a single core.
- These U cores have the same minimum cross-sectional area as the listed effective cross-sectional area.
- A_L value is measured at 1kHz, < 10 gauss.
- For any U core requirement not listed in the catalog, please contact our customer service group for availability and pricing.
- Explanation of Part Numbers: Digits 1&2 = product class, 3&4 = material grade.

Dimensions (Bold numbers are in millimeters, light numbers are nominal in inches.)

Part Number	Fig.	A	B	C	D Min.	E Min.	F	Wt (g)
9077002002	1	8.9 - 0.5 .340	4.45±0.25 .180	4.05±0.2 .160	1.3 .051	2.3 .090	-	.7
9077026002 ⁺	1	25.4±0.75 1.000	12.6±0.25 .500	6.6 - 0.5 .250	6.2 .244	12.45 .490	-	9.0
9077025002 ⁺	1	25.4±0.75 1.000	15.75±0.25 .625	6.6 - 0.5 .250	9.4 .370	12.45 .490	-	9.0
9077024002 ⁺	1	25.4±0.75 1.000	18.9±0.25 .750	6.6 - 0.5 .250	12.55 .494	12.45 .490	-	10
9277023002	2	26.5±0.7 1.045	15.75±0.25 .625	10.0 - 0.5 .385	10.0 .394	7.25 .285	-	14
9277002002	2	26.5±0.7 1.045	20.2±0.15 .795	10.0 - 0.5 .385	14.35 .565	7.25 .285	-	17
9277024002	3	31.4±0.6 1.237	18.5±0.15 .729	10.25 - 0.5 .394	9.4 .370	12.5 .492	26.6±0.5 1.047	18
9277008002	3	41.15±0.75 1.620	17.45±0.15 .687	11.7±0.25 .460	7.8 .307	18.65 .735	35.3±0.6 1.390	26
9277010002	3	41.15±0.75 1.620	20.5±0.25 .812	11.7±0.25 .460	10.95 .431	18.65 .735	35.3±0.6 1.390	29
9277012002	3	41.15±0.75 1.620	25.4±0.15 1.000	11.7±0.25 .460	15.75 .620	18.65 .735	35.3±0.6 1.390	34

⁺ An I core, 9377024002, is available for these U cores, see page 120.

Fair-Rite Products Corp.

PO Box J, One Commercial Row, Wallkill, NY 12589-0288

Phone: (888) FAIR RITE / (845) 895-2055 • FAX: (888) FERRITE / (845) 895-2629
(888) 324-7748 (888) 337 -7483

• www.fair-rite.com
• E-Mail: ferrites@fair-rite.com

U Cores

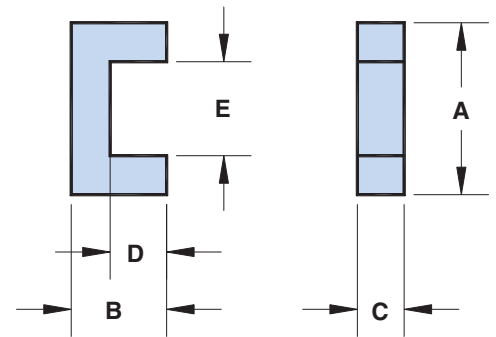

Figure 1

Symbols	Definitions
$\Sigma l/A$	Core constant
l_e	Effective path length
A_e	Effective cross-sectional area
V_e	Effective core volume
A_L	Inductance factor ($\frac{L}{N^2}$)

Magnetic Parameters

Part Number	$\Sigma l/A(\text{cm}^{-1})$	$l_e(\text{cm})$	$A_e(\text{cm}^2)$	$V_e(\text{cm}^3)$	$A_L(\text{nH})$
9077002002	16.8	2.08	.124	.257	695 Min.
9077026002	17.6	7.1	.40	2.85	940 Min.
9077025002	20.7	8.4	.40	3.36	790 Min.
9077024002	23.9	9.6	.40	3.88	695 Min.
9277023002	11.6	7.8	.67	5.2	1390 Min.
9277002002	13.9	9.5	.68	6.5	1180 Min.
9277024002	11.2	9.3	.83	7.7	1425 Min.
9277008002	10.5	10.3	.98	10.1	1575 Min.
9277010002	11.8	11.6	.98	11.3	1425 Min.
9277012002	13.8	13.5	.98	13.2	1255 Min.

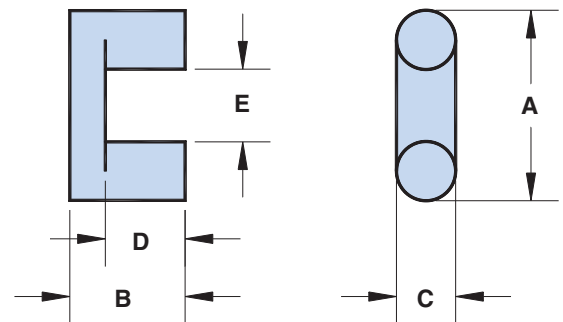

Figure 2

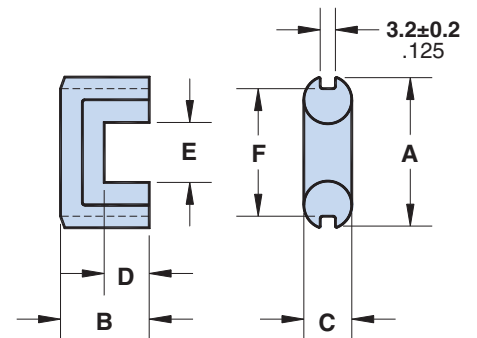

Figure 3

Fair-Rite Products Corp.

PO Box J, One Commercial Row, Wallkill, NY 12589-0288

Phone: (888) FAIR RITE / (845) 895-2055 • FAX: (888) FERRITE / (845) 895-2629 • www.fair-rite.com
 (888) 324-7748 (888) 337-7483 • E-Mail: ferrites@fair-rite.com

Reference Tables

Ferrite Material Constants

Specific Heat	0.25 cal/g/°C
Thermal Conductivity	10x10 ⁻³ cal/sec/cm/°C
Coefficient of Linear Expansion	8 - 10x10 ⁻⁶ /°C
Tensile Strength	4.9 kgf/mm ²
Compressive Strength	42 kgf/mm ²
Young's Modulus	15x10 ³ kgf/mm ²
Hardness (Knoop)	650
Specific Gravity	≈ 4.7 g/cm ³

The above quoted properties are typical for Fair-Rite MnZn and NiZn ferrites.

Properties of Parylene C Coating Material

Dielectric Strength	5600	V/mil
Volume Resistivity	8.8x10 ¹⁶	ohm
Surface Resistivity	10 ¹⁴	ohm
Dielectric Constant (1MHz)	2.95	
Dissipation Factor (1MHz)	0.013	
Density	1.29	g/cm ³
Water Absorption (24 hrs)	<0.1	%
Coefficient of Friction	0.29	
Continuous Operating Temperature	<100	°C
Thermal Conductivity	2.0x10 ⁻⁴	cal/sec/cm/°C
Maximum Operating Temperature	<160	°C

Conversion Table

SI Units	CGS Units
1 T (tesla) = 1 Vs/m ²	= 10 ⁴ gauss
1 mT	= 10 gauss
1 A/m = 10 ⁻² A/cm	= .0125 oersted
.1 mT	= 1 gauss
80 A/m	= 1 oersted

Greek Alphabet

A, α	Alpha	N, ν	Nu
B, β	Beta	Ξ, ξ	Xi
Γ, γ	Gamma	O, ο	Omicron
Δ, δ	Delta	Π, π	Pi
E, ε	Epsilon	Ρ, ρ	Rho
Z, ζ	Zeta	Σ, σ	Sigma
H, η	Eta	T, τ	Tau
Θ, θ	Theta	Υ, υ	Upsilon
I, ι	Iota	Φ, φ	Phi
K, κ	Kappa	X, χ	Chi
Λ, λ	Lambda	Ψ, ψ	Psi
M, μ	Mu	Ω, ω	Omega

Air Core Inductance - L_0 (henry)

The inductance that would be measured if the core had unity permeability and the flux distribution remained unaltered.

Coercive Force - H_c (oersted or A/m)

The magnetizing field strength required to bring the magnetic flux density of the magnetized material to zero.

Core Constant - C_1 (cm⁻¹)

The summation of the magnetic path lengths of each section of a magnetic circuit divided by the corresponding magnetic area of the same section.

Core Constant - C_2 (cm⁻³)

The summation of the magnetic path lengths of each section of a magnetic circuit divided by the square of the corresponding magnetic area of the same section.

Curie Temperature - T_c (°C)

The transition temperature above which a ferrite loses its ferromagnetic properties.

Disaccommodation - D

The proportional decrease of permeability after a disturbance of magnetic material, measured at constant temperature, over a given time interval.

Disaccommodation Factor - DF

The disaccommodation factor if the disaccommodation after magnetic conditioning divided by the permeability of the first measurement times \log_{10} of the ratio of time intervals.

Effective Dimensions of a Magnetic Circuit -

Area A_e (cm²), Path Length l_e (cm) and Volume V_e (cm³)

For a magnetic core of given geometry, the magnetic path length, the cross-sectional area and the volume that a hypothetical toroidal core of the same material properties should possess to be the magnetic equivalent to the given core.

Field Strength - H (oersted or A/m)

The parameter characterizing the amplitude of the alternating field strength.

Flux Density - B (gauss or mT)

The corresponding parameter for the induced magnetic field in an area perpendicular to the flux path.

Flux Density, saturation - B_s (gauss or mT)

The maximum intrinsic induction possible in a material.

Inductance Factor - A_L (nH)

Inductance of a coil on a specified core divided by the square of the number of turns. (Unless otherwise specified the inductance test conditions for the inductance factor are at flux density <10 gauss).

Loss Factor - $\tan \delta/\mu_i$

The phase of displacement between the fundamental components of the flux density and the field strength divided by the initial permeability.

Magnetic Constant - μ_0

The permeability of free space.

Magnetic Hysteresis

In the magnetic material, the irreversible variation of the flux density or the magnetization which is associated with the change of magnetic field strength and is independent of the rate change.

Magnetically Soft Material

A magnetic material with low coercivity.

Permeability, amplitude - μ_a

The quotient of the peak value of the flux density and the peak value of the applied field strength at a stated amplitude of either, with no static present.

Permeability, complex series - μ_s', μ_s''

The real and imaginary components respectively of the complex permeability expressed in series terms.

Permeability, effective - μ_e

For a magnetic circuit constructed with an air gap or air gaps, the permeability of a hypothetical homogeneous material which would provide the same reluctance.

Permeability, incremental - μ_Δ

Under stated conditions the permeability obtained from the ratio of the flux density and the applied field strength of an alternating field and a superimposed static field.

Permeability, initial - μ_i

The permeability obtained from the ratio of the flux density, kept at <10 gauss, and the required applied field strength. Material initially in a specified neutralized state.

Power Loss Density - P (mW/cm³)

The power absorbed by a body of ferrimagnetic material and dissipated as heat, when the body is subject to an alternating field which results in a measurable temperature rise. The total loss is divided by the volume of the body.

Remanence - B_r (gauss or mT)

The flux density remaining in a magnetic material when the applied magnetic field strength is reduced to zero.

Temperature Coefficient - TC

The relative change of the quantity considered, divided by the difference in the temperatures producing it.

Temperature Factor - TF

The fractional change in the initial permeability over temperature range, divided by the initial permeability.

Soft Ferrite References

IEC Publications on Soft Ferrite Materials and Components

IEC 60133	Dimensions of pot cores made of magnetic oxides and associated parts.
IEC 60205	Calculations of the effective parameters of magnetic piece parts.
IEC 60401-1	Terms and nomenclature for cores made of magnetically soft ferrites. Part 1: Terms used for physical irregularities.
IEC 60401-2	Terms and nomenclature for cores made of magnetically soft ferrites. Part 2: Reference of dimensions.
IEC 60401-3	Terms and nomenclature for cores made of magnetically soft ferrites. Part 3: Guidelines on the format of data appearing in manufacturers' catalogues of transformers and inductors cores.
IEC 60424-1	Ferrite cores. Guides on the limits of surface irregularities. Part 1: General specification.
IEC 60424-2	Guidance of the limits of surface irregularities of ferrite cores. Part 2: RM cores.
IEC 60424-3	Ferrite cores. Guide on the limits of surface irregularities. Part 3: ETD cores and E cores.
IEC 60424-4	Ferrite cores. Guide on the limits of surface irregularities. Part 4: Ring cores.
IEC 60431 IEC 60431-am 1 IEC 60431-am 2	Dimensions of square cores (RM cores) made of magnetic oxides and associated parts. Amendment 1. Amendment 2.
IEC 60647	Dimensions for magnetic oxide cores intended for use in power supplies (EC cores).
IEC 60732	Measuring methods for cylinder cores, tubes cores and screw cores of magnetic oxides.
IEC 61007	Transformers and inductors for use in telecommunication equipment. Measuring methods and test procedures.
IEC 61185 IEC 61185-am 1	Magnetic oxide cores (ETD cores) intended for use in power supply applications. Dimensions. Amendment 1.
IEC 61246 IEC 61246-am 1	Magnetic oxide cores (E cores) of rectangular cross-section and associated parts. Dimensions. Amendment 1.
IEC 61247	PM cores made of magnetic oxide and associated parts. Dimensions.
IEC 61332	Soft ferrite material classification.
IEC 61333	Marking on U and E ferrite cores.
IEC 61596	Magnetic oxide EP cores and associated parts for use in inductors and transformers. Dimensions.
IEC/TR 61604	Dimensions of uncoated ring cores of magnetic oxides.

Fair-Rite Products Corp.

PO Box J, One Commercial Row, Wallkill, NY 12589-0288

Phone: (888) FAIR RITE / (845) 895-2055 • FAX: (888) FERRITE / (845) 895-2629
(888) 324-7748 (888) 337-7483

• www.fair-rite.com
• E-Mail: ferrites@fair-rite.com

Soft Ferrite References

IEC 61631	Test method for the mechanical strength of cores made of magnetic oxides.
IEC 61860	Dimensions of low profile cores made of magnetic oxides.
IEC 62024-1	High frequency inductive components. Electrical characteristics and measuring methods. Part 1: Nanohenry range chip inductors.
IEC 62044-1	Cores made of soft magnetic materials. Measuring methods. Part 1: Generic specification.
IEC 62044-2	Cores made of soft magnetic materials. Measuring methods. Part 2: Magnetic Properties at low excitation level.
IEC 62044-3	Cores made of soft magnetic materials. Measuring methods. Part 3: Magnetic properties at high excitation level.
IEC 62211	Inductive components. Reliability management.
IEC 62358	Ferrite cores. Standard inductance factor (AI) and its tolerance.
IEC/TS 62398	Ferrite cores. Technology approval schedule (TAS).
IEC/PAS 62323	Dimensions of half pot cores of magnetic oxides for inductive proximity switches.

The International Electrotechnical Commission (IEC) is the world organization that prepares and publishes international standards for all electrical, electronic and related technologies. Founded in 1906, the IEC is presently composed of more than 60 participating countries, including all the world's major trading nations and a growing number of industrializing countries.

The above publications have been issued by the IEC Technical Committee No. 51: Magnetic Components and Ferrite Materials. Publications can be purchased from the American National Standards Institute. Visit their web site webstore.ansi.org to purchase the documents.

Reference Books for Soft Ferrite Applications

Ferrites for Inductors and Transformers, 1983
Snelling, E.C. and Giles, A.D. , John Wiley & Sons, New York, NY

Soft Ferrites, Properties and Applications, 2nd Edition, 1988
Snelling, E.C. , Butterworths, Stoneham, MA

Transformer and Inductor Design Handbook, 1988
McLyman, Wm. T., Marcel Dekker, New York, NY

Transmission Line Transformers, 1990
Sevick, J., American Radio Relay League, Newington, CT

Soft Magnetic Materials, 1979
Boll, R., John Wiley & Sons, New York, NY

Transformers for Electronic Circuits, 2nd Edition, 1990
Grossner, N., McGraw Hill, New York, NY

Modern Ferrite Technology, Second Edition, 1999
Goldman, A., Kluwer Academic Publishers, Boston/
Dordrecht, Netherlands

Fair-Rite Products Corp. PO Box J, One Commercial Row, Wallkill, NY 12589-0288

Phone: (888) FAIR RITE / (845) 895-2055 • FAX: (888) FERRITE / (845) 895-2629 • www.fair-rite.com
(888) 324-7748 (888) 337-7483 • E-Mail: ferrites@fair-rite.com

Magnetic Design Formulas

Effective Core Parameters

$$C_1 = \Sigma l/A \quad (\text{cm}^{-1}) \quad C_2 = \Sigma l/A^2 \quad (\text{cm}^{-3})$$

$$\ell_e = C_1^2/C_2 \quad (\text{cm}), \quad A_e = C_1/C_2 \quad (\text{cm}^2)$$

Magnetic path is divided into elements with length ℓ and cross-sectional area A .

$$V_e = C_1^3/C_2^2 \quad (\text{cm}^3)$$

Flux Density Peak

$$\hat{B} = \frac{E 10^8}{4.44 f N A_e} \quad (\text{gauss})$$

Field Strength (Peak)

$$\hat{H} = \frac{.4 \pi N I_p}{\ell_e} \quad (\text{oersted})$$

Where E = RMS sine wave voltage (V)
 f = Frequency (Hz)
 A_e = Effective cross-sectional area (cm²)
 ℓ_e = Effective path length (cm)
 I_p = Peak current (A)
 N = Number of turns

* To check for maximum peak flux density in a non-uniform core set substitute A_{\min} for A_e .

Air Core Inductance

$$L_o = \frac{4 \pi N^2 10^{-9}}{C_1} \quad (\text{H})$$

C_1 in cm⁻¹

Number of Turns

$$N = \sqrt{\frac{L 10^9}{A_L}} \quad L \text{ in H}$$

Inductance

$$L = N^2 A_L \quad (\text{nH})$$

$$L = \mu_i \frac{4 \pi N^2}{C_1} 10^{-9} \quad (\text{H})$$

$$L = \mu_e \frac{4 \pi N^2}{C_1} 10^{-9} \quad (\text{H})$$

C_1 in cm⁻¹

Effective Permeability

$$\mu_e = \frac{\ell_e}{\ell_e/\mu_i + \ell}$$

Where ℓ_e = Effective path length
 ℓ = Air gap length

Attenuation

$$A = 20 \log_{10} \frac{|Z_s + Z_L + Z_{sc}|}{|Z_s + Z_L|} \quad (\text{dB})$$

Where Z_s = Source impedance
 Z_L = Load impedance
 Z_{sc} = Suppression core impedance

Quality Factor

$$Q = \frac{2 \pi f L_s}{R_s} = \frac{R_p}{2 \pi f L_p}$$

Wire Table of Copper Magnet Wire

AWG & B&S Gauge	Diameter (Inch)	Cross-Sectional Area		Feet per Ohm (20°C)	Ohms per 1000 ft (20°C)	Amperes for 1mA/cir mil	Turns per Inch ²
		(Inch ²)	(cir mils)				
10	.1019	.00815	10380	1001	1.00	10.4	92
11	.0907	.00647	8234	794	1.26	8.25	118
12	.0808	.00513	6530	630	1.59	6.54	146
13	.0719	.00407	5178	499	2.00	5.18	180
14	.0641	.00322	4107	396	2.53	4.11	231
15	.0571	.00256	3257	314	3.18	3.26	275
16	.0508	.00203	2583	249	4.02	2.59	346
17	.0453	.00161	2048	198	5.06	2.05	432
18	.0403	.00127	1624	157	6.39	1.62	544
19	.0359	.00101	1288	124	8.05	1.29	679
20	.0320	.000804	1022	98.5	10.2	1.03	854
21	.0285	.000638	810.1	78.1	12.8	.81	1065
22	.0254	.000505	642.4	62.0	16.1	.64	1345
23	.0226	.000400	509.5	49.1	20.4	.51	1675
24	.0201	.000317	404.0	39.0	25.7	.40	2095
25	.0179	.000252	320.4	30.9	32.4	.321	2630
26	.0159	.000200	254.1	24.5	40.8	.255	3325
27	.0142	.000158	201.5	19.4	51.4	.201	4110
28	.0126	.000126	159.8	15.4	64.9	.160	5210
29	.0113	.000100	126.7	12.2	81.9	.128	6385
30	.0100	.0000785	100.5	9.7	103.1	.100	8145
31	.0089	.0000622	79.7	7.7	130.1	.079	10,097
32	.0080	.0000503	63.2	6.1	163	.064	12,270
33	.0071	.0000396	50.1	4.8	206	.050	15,615
34	.0063	.0000312	39.8	3.83	261	.040	19,655
35	.0056	.0000248	31.5	3.04	330	.0316	25,530
36	.0050	.0000196	25.0	2.41	415	.0250	31,405
37	.0045	.0000159	19.8	1.91	524	.0203	39,570
38	.0040	.0000126	15.7	1.52	670	.0160	49,070
39	.0035	.00000962	12.5	1.20	832	.0122	65,790
40	.0031	.00000755	9.89	0.953	1049	.0098	82,180
41	.0028	.00000616	7.84	0.756	1323	.0079	98,860
42	.0025	.00000491	6.20	0.598	1672	.0062	121,175
43	.0022	.00000380	4.93	0.476	2101	.0048	158,245
44	.0020	.00000314	3.88	0.374	2674	.0039	205,515
45	.0018	.00000254	3.10	0.299	3344	.0032	249,855
46	.0016	.00000201	2.46	0.238	4202	.0025	310,205

Fair-Rite Products Corp.

PO Box J, One Commercial Row, Wallkill, NY 12589-0288

Phone: (888) FAIR RITE / (845) 895-2055 • FAX: (888) FERRITE / (845) 895-2629
(888) 324-7748

• www.fair-rite.com
• E-Mail: ferrites@fair-rite.com

The Effect of Direct Current on the Inductance of a Ferrite Core

Introduction

If ferrite cores are used in the design of transformers, chokes or filters, which are required to carry direct current, it is necessary to predict the degree of inductance degradation caused by the static field. When dc flows through the winding of a ferromagnetic device, it tends to pre-magnetize the core and reduce its inductance. The permeability of a ferrite material measured with superimposed dc might increase slightly for very low values of dc ampere-turns, but then it progressively decreases as the dc field is increased and the core approaches saturation. This permeability is referred to as the incremental permeability μ_{Δ} . If an air gap is introduced into the magnetic path of a core, the reluctance is increased hence the inductance is decreased. However, the core's capacity for dc ampere-turns without a degradation in inductance is significantly improved, albeit at the expense of a lower effective permeability.

DC Bias in Gapped Cores

The use of graphs such as the Hanna* curves has simplified the tedious trial and error methods often employed when designing inductors with superimposed dc. A Hanna curve is created by measuring the inductance vs. dc bias of various core sizes and gap lengths of the same material grade. The measured data is used to create curves such as those plotted in Figure 1 (this curve is specific for a set of 9478015002 E cores). A line is drawn connecting the individual curves through the point of tangency. The graphs are then normalized by dividing the vertical scale of Figure 1 by the effective core volume V_e and the horizontal scale by the effective path length l_e of the core set. The individual curves, once normalized, overlay creating the Hanna curve. Figure 2 is such a curve for Fair-Rite 78 material and can be used for all core sets in that material.

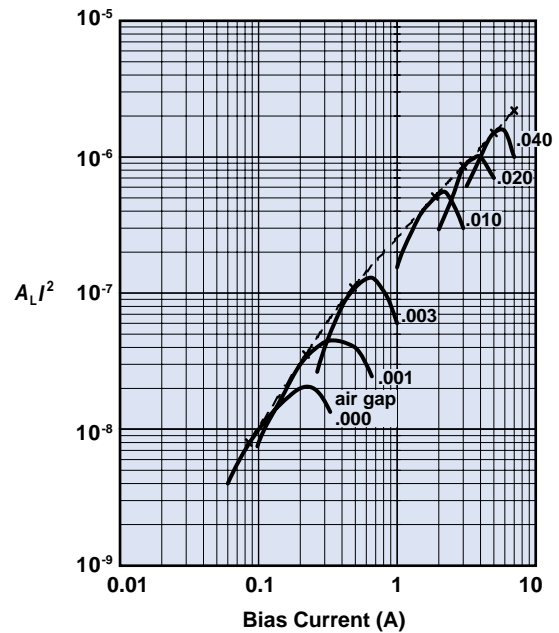

Figure 1 Product inductance factor and current squared vs. DC current for a pair of 9478015002 E cores.

Design Example

For a typical output choke application, the designer knows a number of design criteria such as the required inductance, the direct current, alternating ripple current and allowable dc resistance. He will also have requirements for core size, ambient temperature and often a preference for a particular core geometry.

*Footnote: C.R. Hanna presented a paper "Design of Reactances and Transformers which Carry Direct Current" at the 1927 Winter Convention of AIEE. The paper provided a method of calculating the air gap that will yield the maximum inductance for a given number of turns, with a specified amount of dc, for a particular material.

The following example illustrates the use of the Hanna curve in the design of an inductor.

Inductor specifications:

Minimum inductance	$L = 1 \text{ mH}$
Direct current	$I_{dc} = 1 \text{ A}$
Alternating ripple current	$I_{ac} = 0.2 \text{ A}$
Maximum dc resistance	$R_{dc} < 0.2 \Omega$

Step 1. Initial Core Selection.

Using the Hanna curve for 78 material of Figure 2, select a value for L^2 / V_e approximately mid range on the vertical axis, that is between 10^{-4} and 10^{-3} . Any value greater than 10^{-3} will work the ferrite too hard and the dc resistance is apt to be high. Anything lower than 10^{-4} will result in a conservative design and the dc resistance will be quite low.

Select therefore $L^2 / V_e = 3.5 \cdot 10^{-4}$

Calculate V_e from:

$$V_e = L^2 / 3.5 \cdot 10^{-4}$$

$$L_{min} = 1 \text{ mH, design for } L = 1.1 \cdot 10^{-3} \text{ H}$$

$$I = I_{dc} + I_{ac} / 2 = 1 + 0.2 / 2 = 1.1 \text{ A}$$

$$V_e = 1.1 \cdot 10^{-3} \times 1.1^2 / 3.5 \cdot 10^{-4} = 3.8 \text{ cm}^3$$

Select E core (preferred core shape), based upon the calculated core volume of 3.8 cm^3 from the catalog, pages 118 and 120. Two Fair-Rite E cores are considered:

9478015002	$V_e = 1.95 \text{ cm}^3$ and
9478014002	$V_e = 3.92 \text{ cm}^3$.

The 9478014002 is closest and will be used in this inductor design. The core parameters for this E core set are:

$$l_e = 4.9 \text{ cm, } A_e = .80 \text{ cm}^2 \text{ and } V_e = 3.92 \text{ cm}^3.$$

Recalculate

$$L^2 / V_e = 1.1 \cdot 10^{-3} \times 1.1^2 / 3.92 = 3.4 \cdot 10^{-4}.$$

Step 2. Number of Turns, Wire Size and Wire Fit.

From Figure 2, a $L^2 / V_e = 3.4 \cdot 10^{-4}$ yields a H value of 17 oersted.

Calculate turns N from the formula $H = .4 \pi NI / l_e$ oersted.

$$N = 17 \times 4.9 / (.4 \times \pi \times 1.1) = 60.3 \text{ or } 61 \text{ turns.}$$

From the core dimensions, the core winding area can be calculated, see Table 1.

Winding area for a set of E cores 9478014002 is:

$$A_w = D (E-F) \text{ in inch}^2.$$

$$A_w = .255 (.740 - .250) = .125 \text{ inch}^2.$$

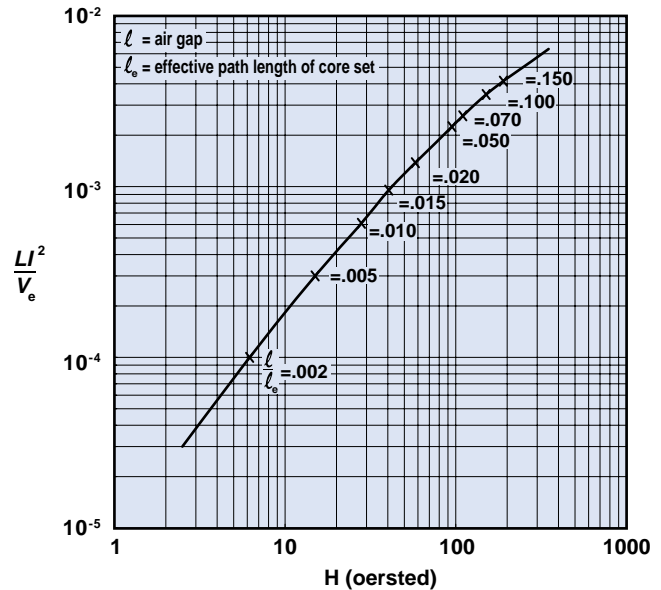

Figure 2 Hanna curve for core sets in 78 material.

E Cores	D(E-F)
ETD Cores	D(E-F)
PQ Cores	D(E-F)
Pot Cores	D(E-F)
EP Cores	D(E-F)

Since the winding area of the appropriate bobbin is smaller than the core winding area, a correction factor F_c has to be used to determine the bobbin winding area. Figure 3 gives this correction factor F_c as a function of the calculated core winding area A_w . A set of E cores 9478014002 has a $A_w = .125 \text{ inch}^2$, from Figure 3 can be determined that the $F_c = .55$, therefore the bobbin winding area is $.55 \times .125 = .069 \text{ inch}^2$. Using a conservative current density of 1 mA per circular mil or 1275 A per inch², an initial wire size selection of 20 AWG can be made from the Wire Table on page 137. To determine the dc resistance of the winding, first find the average length of turn from Table 2.

E Cores	2 (C+E)
ETD Cores	.5 π (E+F)
PQ Cores	.5 π (E+F)
Pot Cores	.5 π (E+F)
EP Cores	.5 π (E+F)

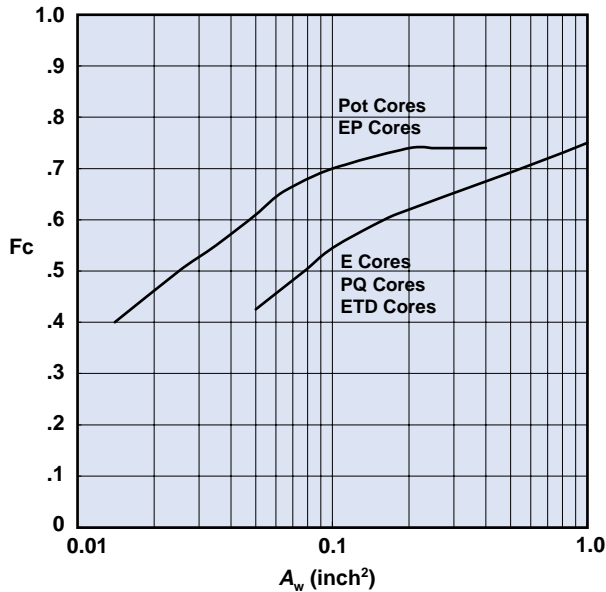

Figure 3 Correction factor F_c vs. core winding area A_w .

Average length of turn for E 9478014002 is:

$$l_{avg.} = 2 (C+F)$$

$$l_{avg.} = 2 (.500 + .740) = 2.48 \text{ inch.}$$

$$R_{dc} = 2.48 \times 61 \times 10.2/12000 = 0.13 \Omega$$

(From the Wire Table, 1000 ft of 20 AWG has a resistance of 10.2 Ω)

To check for winding fit, multiply the number of turns per square inch for 20 AWG from the Wire Table with the bobbin winding area of .069 inch². For 20 AWG, the bobbin winding area can accommodate 854 x .069 = 58.9 turns. This is too close to the calculated turns for an easily manufactured magnetic design. Use 21 AWG wire instead.

$$R_{dc} = 2.48 \times 61 \times 12.8/12000 = 0.16 \Omega.$$

Winding fit for 21 AWG:

$$N = 1065 \times .069 = 73.5, \text{ well above the require 61 turns.}$$

Step 3. Air gap.

Going back to Figure 2, for $LP^2 / V_e = 3.4 \cdot 10^{-4}$ and a $H = 17$ oersted, a l/l_e ratio of approximately .006 is found.

$$\text{The gap length} = .006 \times l_e.$$

$$l = .006 \times 4.9/2.54 = .012 \text{ inch.}$$

To summarize:

- E core 9478014002 $N = 61$ turns
- Wire size 21 AWG Gap length .012 inch

The graphs in Figures 4 through 8 show the inductance factors or A_L values as a function of the air gaps for the different core types and sizes. The air gap determined in the design example and the air gaps shown in Figures 4 through 8 represent the total air gap. The most practical way to obtain this air gap is to grind this gap into the center leg of one of the core halves. Non-metallic shims can also be used to obtain the desired air gap. This is usually done by placing shims between the outer legs or outside rims of the core halves. In cores with a uniform cross-sectional area, the A_L value or inductance index will be the same whether the core is gapped or shims are used that have a thickness half the total air gap. For cores that have a non-uniform cross-sectional area the shim thickness can be calculated from:

$$\text{Shim thickness} = \text{total air gap} \times \frac{\text{center mating area}}{\text{total mating area}}$$

The above example of the E core 9478014002, a core with a uniform cross-sectional area, can therefore use .006 inch shims between the outer legs.

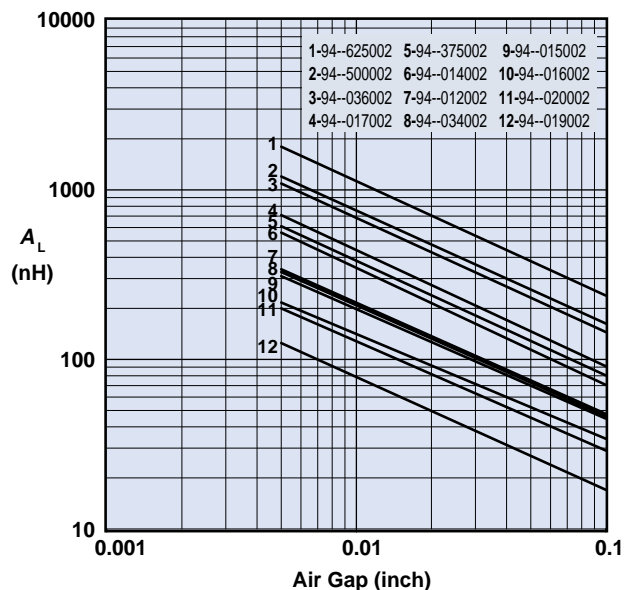

Figure 4 A_L vs. gap for E cores in 77 and 78 material.

Technical Information

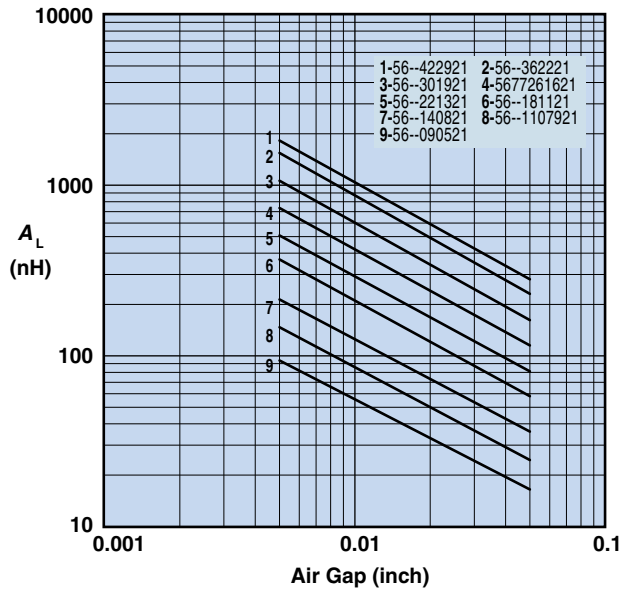

Figure 5 A_L vs. gap for pot cores in 77 and 78 material.

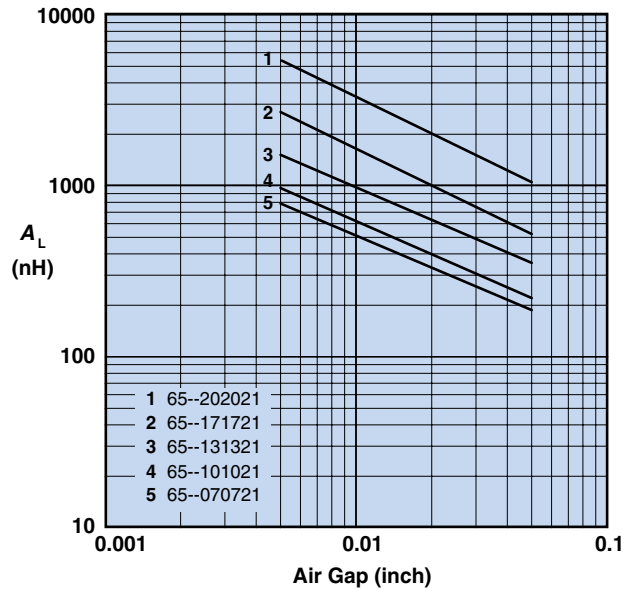

Figure 6 A_L vs. gap for EP cores in 77 and 78 material.

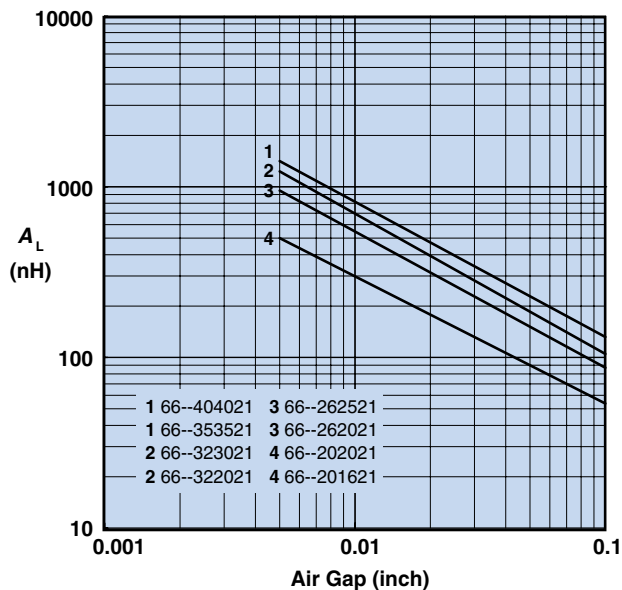

Figure 7 A_L vs. gap for PQ cores in 77 and 78 material.

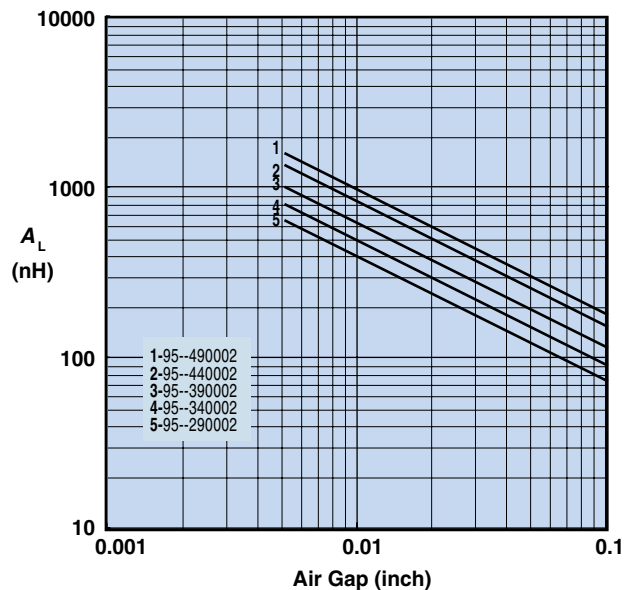

Figure 8 A_L vs. gap for ETD cores in 77 and 78 material.

Fair-Rite Products Corp.

PO Box J, One Commercial Row, Wallkill, NY 12589-0288

Phone: (888) FAIR RITE / (845) 895-2055 • FAX: (888) FERRITE / (845) 895-2629
(888) 324-7748 (888) 337-7483

• www.fair-rite.com
• E-Mail: ferrites@fair-rite.com

Technical Information

DC Bias in Open Magnetic Cores

The discussion so far has been on core types that have a closed magnetic path, in which a small air gap has been inserted by either a ground gap or the use of shims. An open magnetic core can be thought of as a core with a very large fixed air gap. Since the air gap is determined by the core geometry and cannot be changed, the Hanna curves can not be used for these types of cores. Such cores as rods, slugs and bobbins can be used quite successfully in inductor designs that have relative low inductance values and can accommodate significant amounts of static currents.

The large air gap will forestall the saturation of this type of core, hence the inductance will not as rapidly decrease as a function of the dc ampere-turns. The Fair-Rite bobbins, listed on the pages 104 and 105 of the catalog, are specified to an inductance factor or A_L with a tolerance of $\pm 10\%$ and also by a NI product of dc ampere-turns, which would reduce the A_L value but not more than 5%. For an inductor design the number of turns can

be calculated from the required inductance L and the inductance factor of the bobbin. $N = L/A_L$, (L in nH). The turns N times the direct current A will give the NI product, which should be less than the value quoted for the bobbin. For winding fit and dc resistance check, the same procedure is used as outlined in the example above, except here the A_w of the bobbin is the total available winding area. The graphs of Figure 9 show the effect of temperature on the inductance factor vs. dc bias characteristics of the 9677242489 bobbin. As can be seen from these curves, the decrease in inductance increases with temperature. The NI values listed in the catalog are at room temperature, and must be derated when operating at elevated temperatures. Open magnetic cores, rods, slugs and bobbins are used and designed into SCR and triac controls, speaker crossover networks and differential-mode input filters. They are also utilized for EMI suppression applications where relative large direct currents are present and for output chokes in switched-mode power supplies.

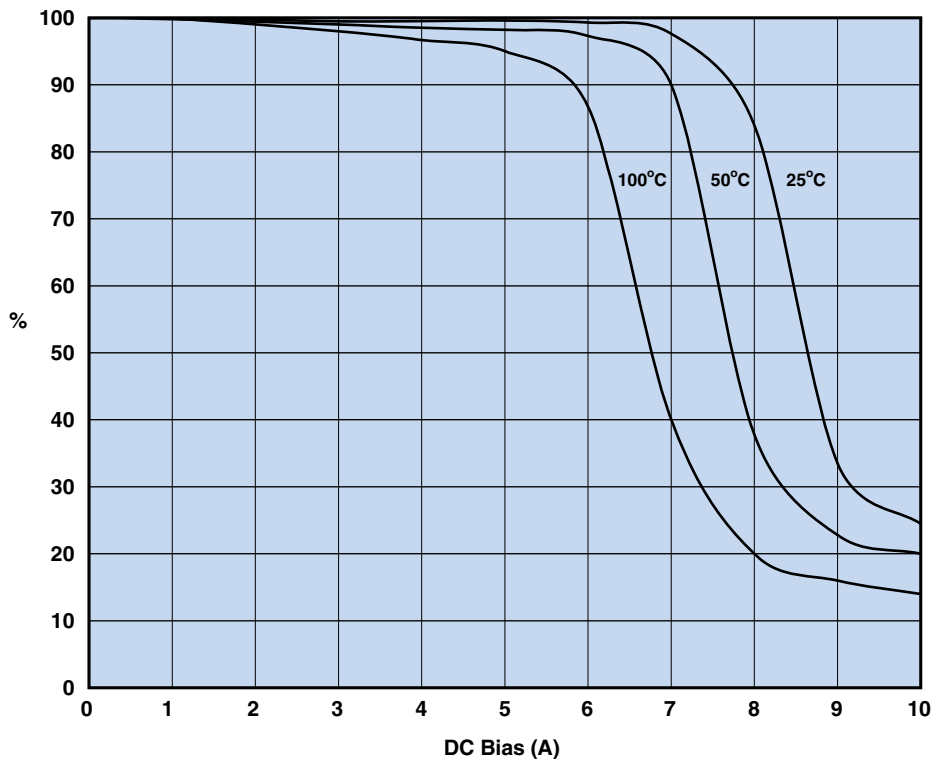

Figure 9 Percent of original inductance factor vs. DC bias and temperature.

Fair-Rite Products Corp.

PO Box J, One Commercial Row, Wallkill, NY 12589-0288

Phone: (888) FAIR RITE / (845) 895-2055 • FAX: (888) FERRITE / (845) 895-2629
(888) 324-7748 (888) 337-7483

• www.fair-rite.com
• E-Mail: ferrites@fair-rite.com

Technical Information

Use of Ferrites in Broadband Transformers

Introduction

Most of the magnetic information in this catalog is data obtained from cores wound with a single multi-turn-winding which forms an inductor. When a second winding is added on the core, the inductor becomes a transformer. Depending on the requirements, transformers can be designed to provide dc isolation, impedance matching and specific current or voltage ratios. Transformer designed for power, broadband, pulse, or impedance matching can often be used over a broad frequency spectrum.

In many transformer designs ferrites are used as the core material. This article will address the properties of the ferrite materials and core geometries which are of concern in the design of low power broadband transformers.

Brief Theory

Broadband transformers are wound magnetic devices that are designed to transfer energy over a wide frequency range. Most applications for broadband transformers are in telecommunication equipment where they are extensively used at a low power levels.

Figure 1 shows a typical performance curve of insertion loss as a function of frequency for a broadband transformer. The bandwidth of a broadband transformer is the frequency difference between f_2 and f_1 , or between f_2' and f_1' , and is a function of the specified insertion loss and the transformer roll-off characteristics.

It can be seen that the bandwidth is narrower for transformers with a steep roll-off ($f_2' - f_1'$) than those with a more gradual roll-off ($f_2 - f_1$). Also in Figure 1, the three frequency regions are identified.

The cutoff frequencies are determined by the requirements of the individual broadband transformer design. Therefore, f_1 can be greater than 10 MHz or less than 300 Hz. Bandwidths also can vary from a few hundred hertz to hundreds of MHz. A typical

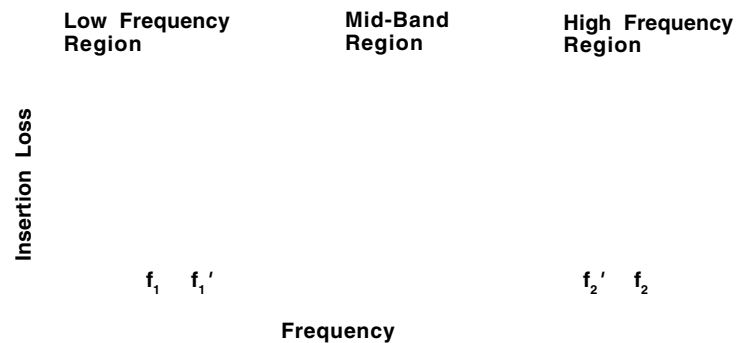

Figure 1 Typical Characteristic Curve of Insertion Loss vs. Frequency for a broadband transformer.

broadband transformer design will specify for the mid frequency range a maximum insertion loss and for the cutoff frequencies, f_1 and f_2 maximum allowable losses. Figure 2 is a schematic diagram of the lumped element equivalent circuit of a transformer, separating the circuit into an ideal transformer, its components and equivalent parasitic resistances and reactances. The secondary components, parasitics and the load resistance have been transferred to the primary side and are identified with a prime.

To simplify this circuit, the primary and secondary circuit elements have been combined and the equivalent reduced circuit is shown in Figure 3. The physical significance of the parameters are listed below the equivalent circuits. In the low frequency region the roll-off in transmission characteristics is due a lowering of the shunt impedance. The shunt impedance decreases when the frequency is reduced, which results in the increases level of attenuation. The impedance is mainly a function of the

Technical Information

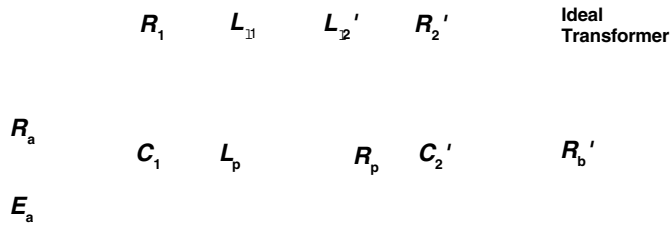

Figure 2 Lumped equivalent of a transformer.

- E_a = source EMF
- R_a = source resistance
- C_1 = primary winding capacitance
- R_1 = resistance of primary winding
- L_{l1} = primary leakage inductance
- L_p = open circuit inductance of primary winding
- R_p = shunt resistance that represents loss in core
- Secondary parameters reflected to the primary side.
- C_2' = secondary winding capacitance
- R_2' = resistance of secondary winding
- L_{l2}' = secondary leakage inductance
- R_b' = load resistance

primary reactance X_{LP} with a negligible contribution of the equivalent shunt loss resistance R_p . The insertion loss may therefore be expressed in terms of the shunt inductance:

$$A_i = 10 \log_{10} \left(1 + \left(\frac{R}{\omega L_p} \right)^2 \right) \text{ dB}$$

Where $R = R_a \times R_b' / R_a = R_b'$

For most ferrite broadband transformer designs, the only elements that are likely to effect the transmission at the mid-band frequency range are the winding resistances. The insertion loss for the mid-band frequency region due to the winding resistance may be expressed as:

$$A_i = 20 \log_{10} \left(1 + \frac{R_c}{R_a + R_b'} \right) \text{ dB}$$

Where $R_c = R_1 + R_2'$

In the higher frequency region the transmission characteristics are mainly a function of the leakage inductance or the shunt capacitance. It is often necessary to consider the effect of both of these reactances, depending upon the circuit impedance. In a low impedance circuit the high frequency droop due to leakage inductance is:

$$A_i = 10 \log_{10} \left(1 + \left(\frac{\omega L_l}{R_a + R_b'} \right)^2 \right) \text{ dB}$$

This high frequency droop in a high impedance circuit, due to the shunt capacitance, is as follows:

$$A_i = 10 \log_{10} \left(1 + (\omega CR)^2 \right) \text{ dB}$$

Reviewing the insertion loss characteristics for the three frequency regions, it can be concluded that the selection of ferrite material and core shape should result in a transformer design that yields the highest inductance per turn at the low frequency cutoff f_1 . This will result in the required shunt inductance for the low frequency region with the least number of turns. The low number of turns are desirable for low insertion loss at the mid-band region and also for low winding parasitics needed for good response at the high frequency cutoff f_2 .

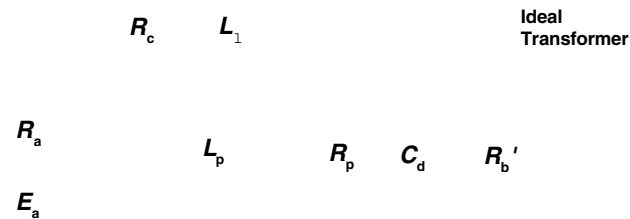

Figure 3 Simplified equivalent transformer circuit

$$C_d = C_1 + C_2'$$

$$R_c = R_1 + R_2'$$

$$L_l = L_{l1} + L_{l2}'$$

For other circuit parameters see Figure 2.

Technical Information

Low and Medium Frequency Broadband Transformers

For broadband transformer applications the optimum ferrite is the material that has the highest initial permeability at the lower cutoff frequency f_1 . Manganese zinc ferrites, such as Fair-Rite 77 or 78 material, are very suitable for low and medium frequency broadband transformers designs. As stated before, the transformer parameter that is most critical is the shunt reactance (ωL), which will increase with frequency as long as the material permeability is constant or diminishing at a rate less than the increase in frequency. This holds true even if a transformer is designed using a manganese zinc ferrite where f_1 is at the higher end of the flat portion of the permeability vs. frequency curve. Although the whole bandpass lies in the area where the initial permeability is decreasing, yet the bandpass characteristics will be virtually unaffected. For broadband transformers that use a manganese zinc ferrite material the core geometry should be such as to minimize the R_{dc}/L ratio. In other words, the ratio of dc resistance to the inductance for a single turn should be a minimum. The range of pot cores, standardized by the International Electrotechnical Commission in document IEC 60133, has been designed for this minimum R_{dc}/L ratio. Other core shapes such as the E cores and toroids can also be used in the design of these broadband transformers. Often the final core selection will also be influenced by such considerations as ease of winding, terminating and other mechanical design constraints of the transformer.

Broadband Transformers with a Superimposed Static Field

In transformer designs that have a superimposed direct current, gapped cores can be employed to overcome the decrease in the shunt inductance. Hanna curves can be used to aid in the design of inductive devices that carry a direct current. For more information see section "The Effect of Direct Current on the Inductance of a Ferrite Core" on page 130.

High Frequency Broadband Transformers.

Although there is no clear division between the frequency regions, for this article it is assumed that the high frequency broadband transformer designs use nickel zinc ferrites as the preferred core material. This will typically occur for transformer

designs where the bandpass lies wholly above 500 kHz. At these higher operating frequencies it becomes more important to consider the complex magnetic parameters of the core material, rather than use the simple core constants, such as A_L , recommended for low frequency designs.

Another important consideration is that high frequency transformers are generally used in low impedance circuits, which means that these designs require low shunt impedances. This can often be accomplished with a few turns, hence winding resistances are no longer an issue, and the design concept of minimizing R_{dc}/L is no longer required. The design will instead become focused on core shape and material for the required shunt impedance at f_1 along with reducing leakage inductance of the winding. Since the material characteristics permeability and losses affect the shunt impedance these parameters need to be considered in high frequency broadband transformer designs. Figures 4, 5 and 6 are typical curves of impedance Z , equivalent parallel reactance X_p and equivalent parallel loss resistance R_p as a function of frequency. They are measured on the same multi-aperture core 28—002302, in 73, 43, 61 & 67 material, wound with a single turn through both holes. For high frequency broadband transformers the toroidal core shape becomes an attractive core geometry. The few turns that are often required can easily be wound on the toroid. However, windings that require only a few turns may give rise to problems in obtaining the desired impedance ratios. To minimize leakage inductance it is suggested that the primary and secondary windings be tightly coupled and where possible a bifilar winding be used.

An improvement in core performance over toroids can be obtained by the use of multi-aperture cores, which can be considered as two toroidal cores side by side. This core shape has a lower single turn winding length than the equivalent toroidal core with the same core constant C_1 , and will result in a wider bandwidth of the transformer design. Many broadband transformers have been designed utilizing nickel zinc ferrite toroids with good results. If bandwidth requirements cannot be met using toroids, multi-aperture nickel zinc cores should be considered.

The multi-aperture cores listed in this catalog on page 44, are available in the nickel zinc ferrite materials 67, 61 and 43 as well as the manganese zinc ferrite 73 material.

Fair-Rite Products Corp.

Phone: (888) FAIR RITE / (845) 895-2055 • FAX: (888) FERRITE / (845) 895-2629
(888) 324-7748 (888) 337-7483

PO Box J, One Commercial Row, Wallkill, NY 12589-0288

• www.fair-rite.com
• E-Mail: ferrites@fair-rite.com

Technical Information

Summary

The low cutoff frequency f_1 is the single most important factor in the ferrite material selection. The material with the highest initial permeability at f_1 is the recommended choice.

Manganese zinc ferrites, 77 and 78, can be used to a cutoff frequency f_1 of 500 kHz. Above this frequency use a nickel zinc ferrite, again depending upon the frequency f_1 , select 43, 61 or 67 material.

For low and medium frequency transformers the optimum core shape should provide the lowest DC resistance per unit of inductance. If there is a superimposed dc present the use of gapped cores and Hanna curves is suggested. For high frequency designs, use nickel zinc ferrite. The toroidal and multi-aperture cores are the recommended core configurations.

The number of turns should be kept to a minimum to reduce leakage inductance and self-capacitance of the windings. Wind primary and secondary windings tightly coupled or as bifilar windings to lower leakage inductance.

The "Multi-Aperature Core Kit", (part number 0199000036), contains a variety of components suited for broadband transformer design evaluations, see page 68.

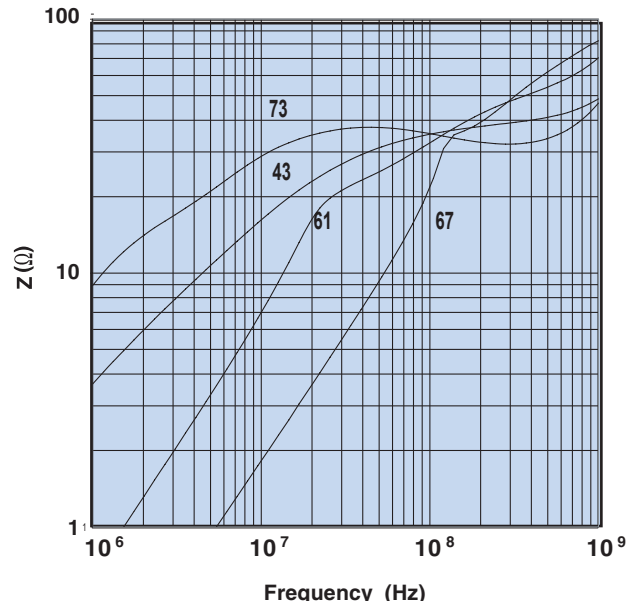

Figure 4 Impedance vs. frequency for part number 28—002302 in 73, 43, 61 & 67 material.

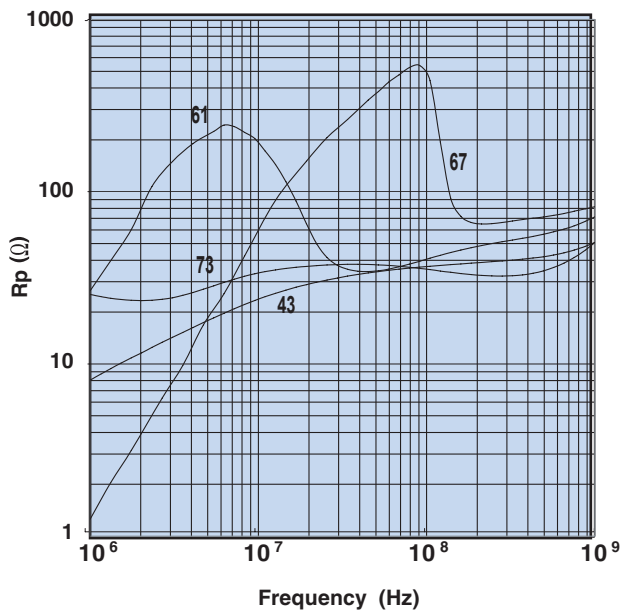

Figure 5 Parallel resistance vs. frequency for part number 28—002302 in 73, 43, 61 & 67 material.

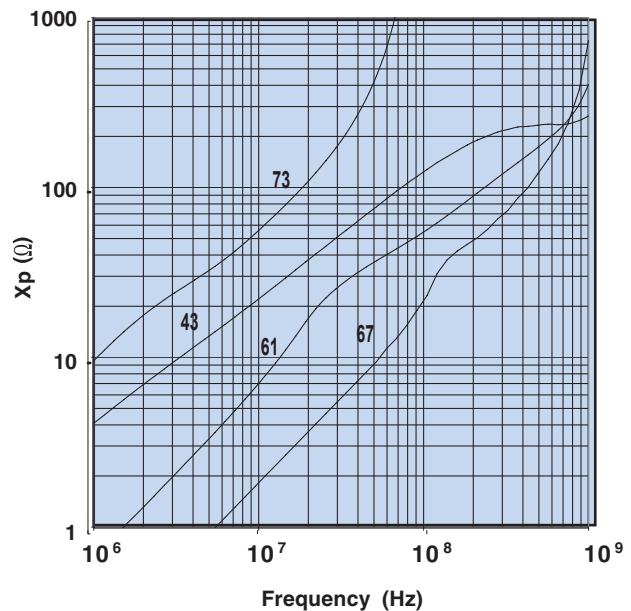

Figure 6 Parallel reactance vs. frequency for part number 28—002302 in 73, 43, 61 & 67 material.

Fair-Rite Products Corp.

Phone: (888) FAIR RITE / (845) 895-2055 • FAX: (888) FERRITE / (845) 895-2629
(888) 324-7748 (888) 337 -7483

PO Box J, One Commercial Row, Wallkill, NY 12589-0288
• www.fair-rite.com
• E-Mail: ferrites@fair-rite.com

Technical Information

How to Choose Ferrite Components for EMI Suppression

Introduction

The following pages will focus on Soft Ferrites used in the application of electromagnetic interference (EMI) suppression. Although the end use is an important issue and some applications are mentioned, this technical section is not intended to be a design manual, but rather, an aid to the designer in understanding and choosing the optimum ferrite material and component for their particular application. Ferrite suppressor cores are simple to use, in either initial designs or retrofits, and are comparatively economical in both price and space. Ferrite suppressors have been successfully employed for attenuating EMI in computers and related products, switching power supplies, electronic automotive ignition systems, and garage doors openers, to name just a few.

Use of Ferrite Suppressor Cores

The United States was one of the first countries to recognize the potential problems caused by electromagnetic pollution. As a result the FCC was charged with the responsibility of promulgating rules and regulations to control and enforce limits on high frequency interference.

Figure 1 shows the current radiation limits as defined by FCC Rules Part 15, for class A (industrial) and class B (mass-market) equipment.

Contrary to the times when these regulations were first enforced and designing for EMI protection was often an afterthought rather than a forethought, a major portion of today's circuitry is incorporating EMI safeguards in its initial design. Many approaches can be used to comply with design or specification limits for EMI. Attention to basic circuit design, component layout, shielded enclosures and other use of shielding materials may be considered. For reducing or eliminating conducted EMI on printed circuit boards in wiring and cables, ferrite components have been used very successfully for decades. The ferrite core introduces into the circuit a frequency variable impedance, see Figure 2. The core will not affect the lower frequency operating signals but does block the conduction of the EMI noise frequencies. The Figures 3 and 4 are photographs of a representative sampling of the Fair-Rite Products Corp. product line of suppressor cores.

Conducted Limits*		
Frequency	Class A	Class B
450 kHz – 1.6 MHz	60 dBuV	50 dBuV
1.6 MHz – 30 MHz	70 dBuV	60 dBuV

*Measured using a 50-ohm LISN

Radiated Limits**		
Frequency	Class A	Class B
30 MHz – 88 MHz	50 dBuV/m	40 dBuV/m
88 MHz – 216 MHz	53 dBuV/m	43 dBuV/m
216 MHz – 960 MHz	56 dBuV/m	46 dBuV/m
above 960 MHz	64 dBuV/m	54 dBuV/m

**Measured at a 3-meter distance

Figure 1 FCC Radiation Limits for class A & B equipment.

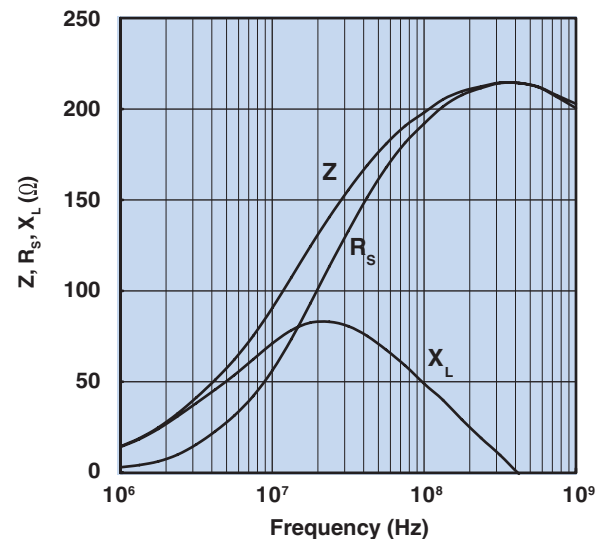

Figure 2 Impedance, reactance, and resistance vs. frequency for a ferrite core in 43 material.

Technical Information

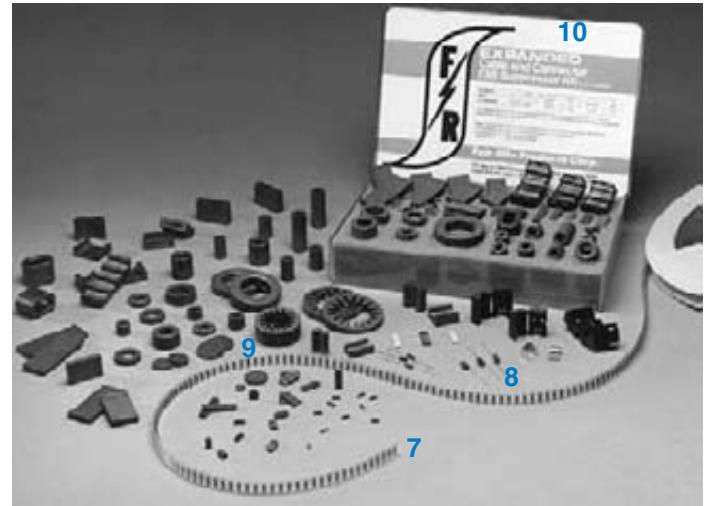
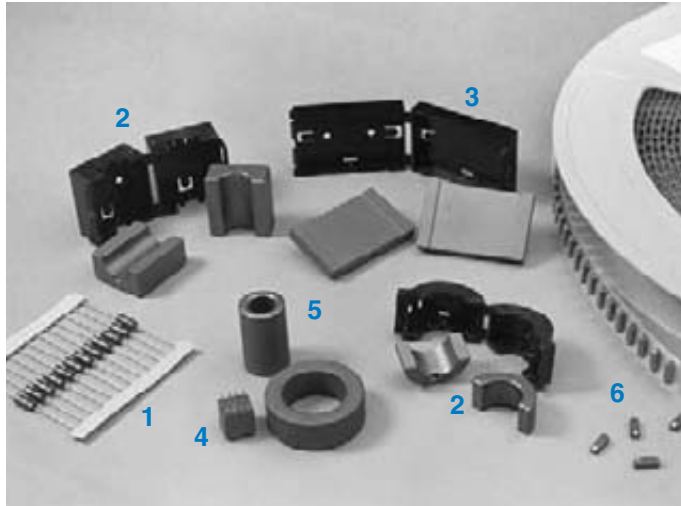

Figure 3, 4 Variety of EMI Suppression Cores including: (1) Beads on Leads, (2) Split Round Cable Suppression Cores and Cases, (3) Split Flat Cable Suppression Cores and Cases, (4) Printed Circuit (PC) Beads, (5) Round Cable Suppression Cores (6) Surface-Mount (SM) Beads, (7) on Reel, (8) Wound Beads, (9) Connector Suppression Discs and Plates and (10) One of our Engineering Kits containing a Large Variety of Samples of EMI Suppressor Cores.

The Magnetics

The permeability of a ferrite material is a complex parameter consisting of a real and an imaginary part. The real component represents the reactive portion and the imaginary component represents the losses. These may be expressed as series components (μ_s', μ_s'') or parallel components (μ_p', μ_p'').

Figure 5 is the vector representation of the series equivalent circuit of a ferrite suppression core; the loss free inductor (L_s) is in series with the equivalent loss resistor (R_s). The following equations relate the series impedance and the complex permeability:

$$Z = j\omega L_s + R_s = j\omega L_o(\mu_s' - j\mu_s'') \text{ ohm}$$

so that

$$\omega L_s = \omega L_o \mu_s' \text{ ohm}$$

$$R_s = \omega L_o \mu_s'' \text{ ohm}$$

where: $L_o = \frac{4\pi N^2 10^{-9}}{C_1}$ (H) is the air core inductance.

C_1 = core factor

The impedance of a ferrite suppressor core is a combination of the intrinsic material characteristics μ_s' and μ_s'' , the square of the turns and of the ferrite core. The complex permeability components μ_s' and μ_s'' vary as a function of frequency. The core geometry and the number of turns are frequency independent contributors to the overall impedance.

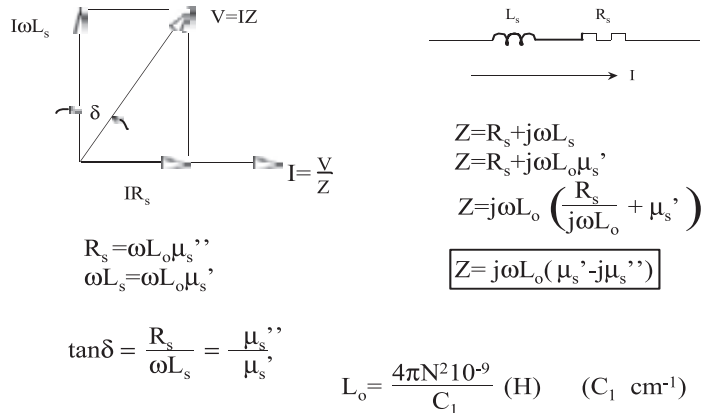

Figure 5

Material Selection

Conducted EMI can occur over a wide range of frequencies, from as low as 1 MHz to several GHz. To provide protection over such a wide frequency range a number of ferrite materials will have to be made available.

Fair-Rite offers a complete line of suppression ferrites that cover a gamut of frequencies. Starting at 1 MHz MnZn ferrites 73 and 31 are used. Beginning around 20 MHz up to 200/300 MHz the NiZn materials 43 and 44 and the MgZn 46 material are recommended. For the highest frequencies the NiZn 61 material is the choice.

Fair-Rite Products Corp.

Phone: (888) FAIR RITE / (845) 895-2055 • FAX: (888) FERRITE / (845) 895-2629
(888) 324-7748 (888) 337-7483

PO Box J, One Commercial Row, Wallkill, NY 12589-0288

• www.fair-rite.com
• E-Mail: ferrites@fair-rite.com

Technical Information

Figures 6 through 11 show for these six suppression materials the complex permeabilities μ'_s and μ''_s as a function of frequency. For all these materials at low frequencies μ'_s is highest but as the frequency increases μ''_s becomes the dominant material parameter whence the biggest contributor to the overall impedance. At the low frequencies where μ'_s is highest the suppression core is mostly inductive and rejects EMI signals. At the higher frequencies where μ''_s becomes the more significant parameter the impedance will become more and more resistive and absorbs the conducted EMI.

Table 1 lists Fair-Rite's suppression materials, suggested operating frequency ranges and the test frequencies for the six suppression materials. The recommended materials will provide the highest combination of the primary material characteristics μ'_s and μ''_s over that frequency range.

Table 1

Material	Frequency Range	Test Frequencies	Comments
73	1 - 25 MHz	10 - 25 MHz	Small parts only
31	1 - 300 MHz	10 - 25 - 100 MHz	Large parts only
43	20 - 300 MHz	25 - 100 MHz	Wide range of parts
44	20 - 300 MHz	25 - 100 MHz	High resistivity
46	20 - 300 MHz	100 MHz	Large Parts
61	200+ MHz	250 - 500 MHz	For VHF designs

Making the material selection is the first step in eliminating conducted EMI problems. To make this material selection it is imperative that the frequency or frequencies of the unwanted noise are known. This needs not be an exact figure; an approximation will be sufficient. From the EMI frequency the material can be selected. It should be made clear that several environmental conditions will have to be addressed before this selection becomes final.

Environmental Conditions

As shown in Figures 6 through 11, the μ'_s and μ''_s will vary as a function of frequency. However, several environmental conditions will also affect these primary material parameters. The most significant ones are temperature and dc bias.

Changes in the combination of μ'_s and μ''_s due to temperature is strictly a material characteristic which is not affected by the core geometry. The graphs in Figures 12 through 17 show the percentage change in impedance as a function of temperature when compared to room temperature. These typical changes in impedance will be applicable for all components made from these materials. Designers can use these graphs to evaluate performance of specific components versus temperature.

73 Material

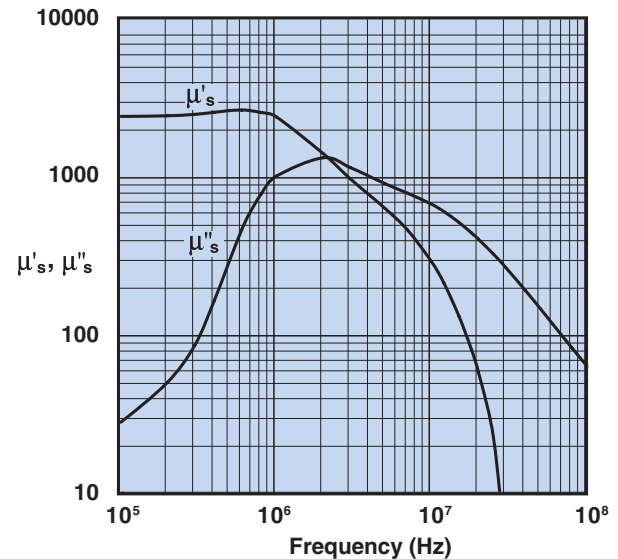

Figure 6 Complex Permeability vs. Frequency Measured on a 2673000301 bead using the HP 4284A and the HP 4291A.

31 Material

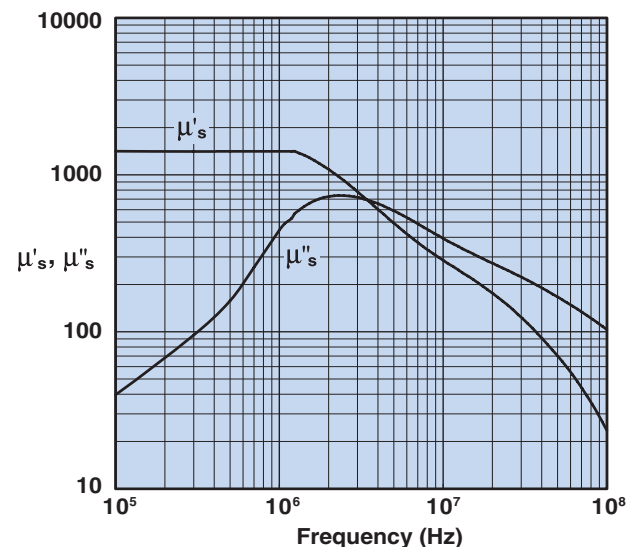

Figure 7 Complex Permeability vs. Frequency Measured on a 17/10/6mm toroid using the HP 4284A and the HP 4291A.

Fair-Rite Products Corp.

Phone: (888) FAIR RITE / (845) 895-2055 • FAX: (888) FERRITE / (845) 895-2629
(888) 324-7748 (888) 337-7483

PO Box J, One Commercial Row, Wallkill, NY 12589-0288

• www.fair-rite.com
• E-Mail: ferrites@fair-rite.com

Technical Information

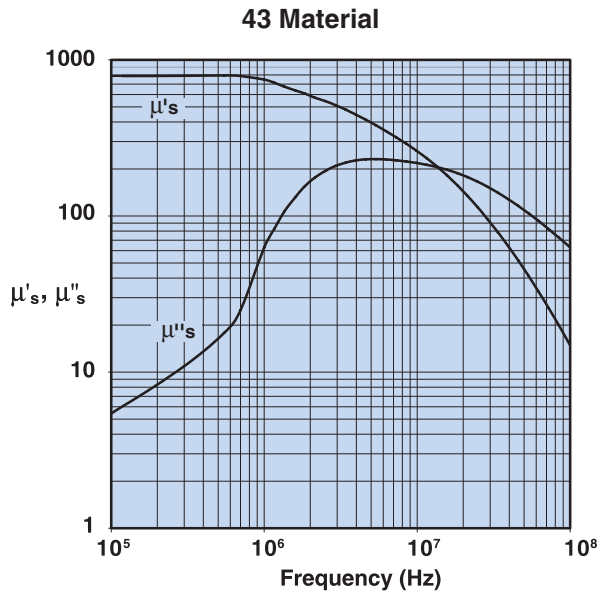

Figure 8 Complex Permeability vs. Frequency Measured on a 17/10/6mm toroid using the HP 4284A and the HP 4291A.

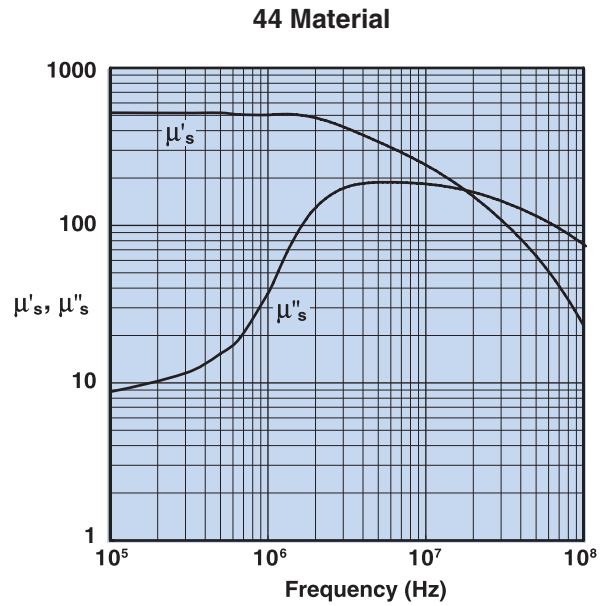

Figure 9 Complex Permeability vs. Frequency Measured on a 17/10/6mm toroid using the HP 4284A and the HP 4291A.

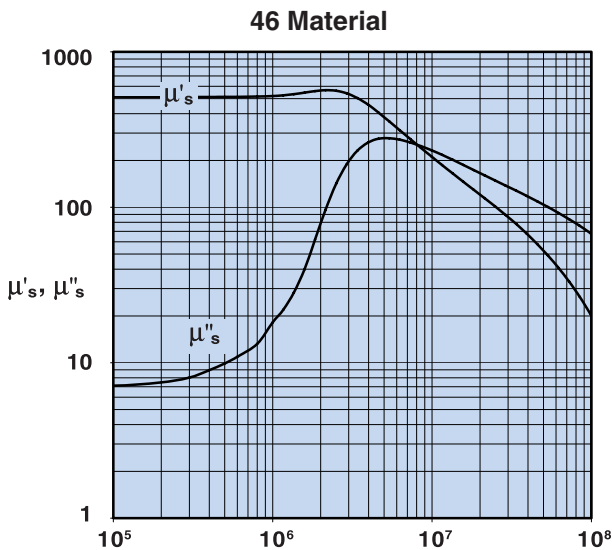

Figure 10 Complex Permeability vs. Frequency Measured on a 17/10/6mm toroid using the HP 4284A and the HP 4291A.

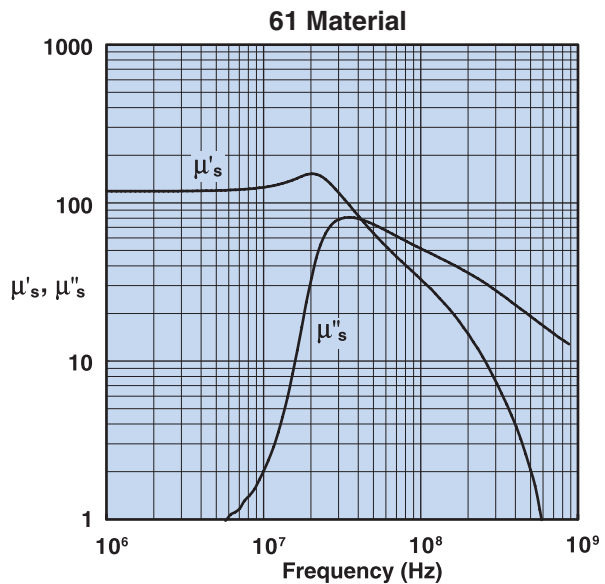

Figure 11 Complex Permeability vs. Frequency Measured on a 17/10/6mm toroid using the HP 4284A and the HP 4291A.

Fair-Rite Products Corp.

PO Box J, One Commercial Row, Wallkill, NY 12589-0288

Phone: (888) FAIR RITE / (845) 895-2055 • FAX: (888) FERRITE / (845) 895-2629
(888) 324-7748 (888) 337-7483

• www.fair-rite.com
• E-Mail: ferrites@fair-rite.com

Technical Information

The dc bias is more complex. The dc bias will affect both the μ'_s and μ''_s , but this is also influenced by the core geometry, specifically the magnetic path length. Therefore Fair-Rite provides dc bias information based on a dc H field in oersted for many of its suppression components. For all EMI suppression beads and round cable suppression cores listed in the catalog a calculated H value ($H=1.256/I_m$) that is based on a single turn and one Amp direct current is shown. This calculated value of H should be modified if more turns are used or if the current is not 1 A. A 2 Amp current will of course double the value listed for the part. Once the true dc H field is calculated, graphs in Figures 18 through 23 will provide the change in impedance information for the appropriate material, frequency and true H value.

Dc bias curves are included on the Fair-Rite CD-ROM. Also those components for which the magnetic path length cannot easily be calculated the dc bias curves are on the CD-ROM as well. Again, this will provide the designer with a quick evaluation on how the dc bias affects the performance of these components.

73 Material

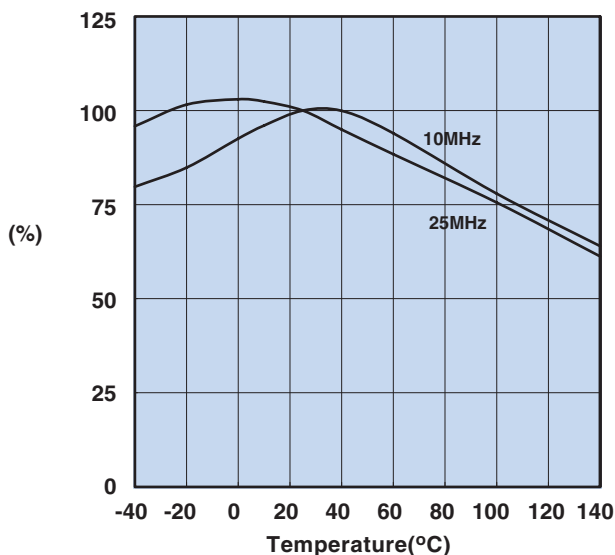

Figure 12 Percent of Original Impedance vs. Temperature Measured on a 2673000301 using the HP4291A.

31 Material

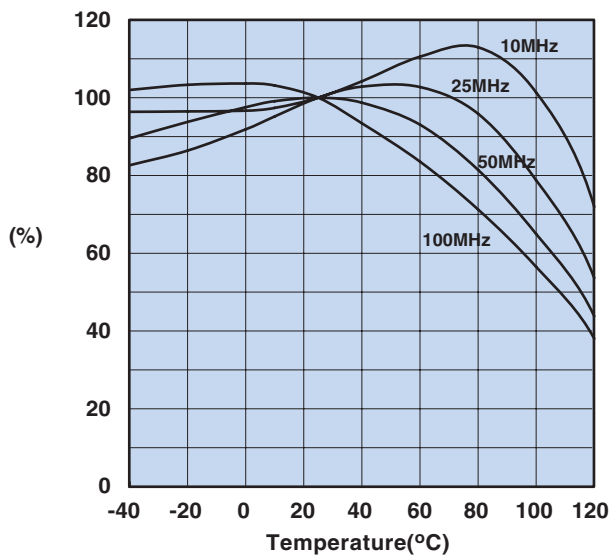

Figure 13 Percent of Original Impedance vs. Temperature Measured on a 2631000301 using the HP4291A.

43 Material

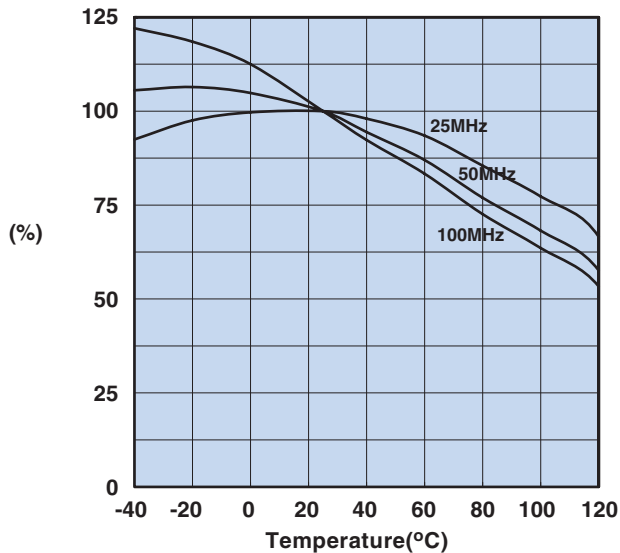

Figure 14 Percent of Original Impedance vs. Temperature Measured on a 2643000301 using the HP4291A.

Fair-Rite Products Corp.

PO Box J, One Commercial Row, Wallkill, NY 12589-0288

Phone: (888) FAIR RITE / (845) 895-2055 • FAX: (888) FERRITE / (845) 895-2629 • www.fair-rite.com
 (888) 324-7748 (888) 337-7483 • E-Mail: ferrites@fair-rite.com

Technical Information

44 Material

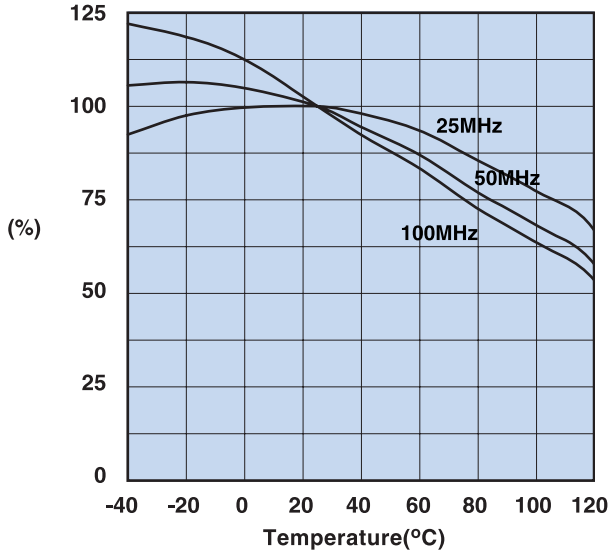

46 Material

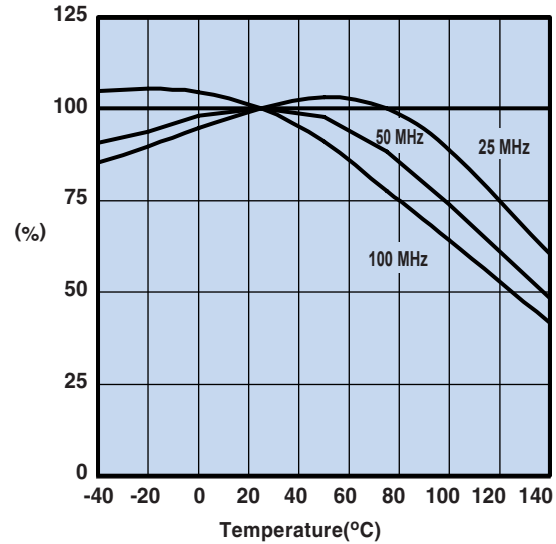

Figure 15 Percent of Original Impedance vs. Temperature Measured on a 2644000301 using the HP4291A.

Figure 16 Percent of Original Impedance vs. Temperature Measured on a 2646000301 using the HP4291A.

61 Material

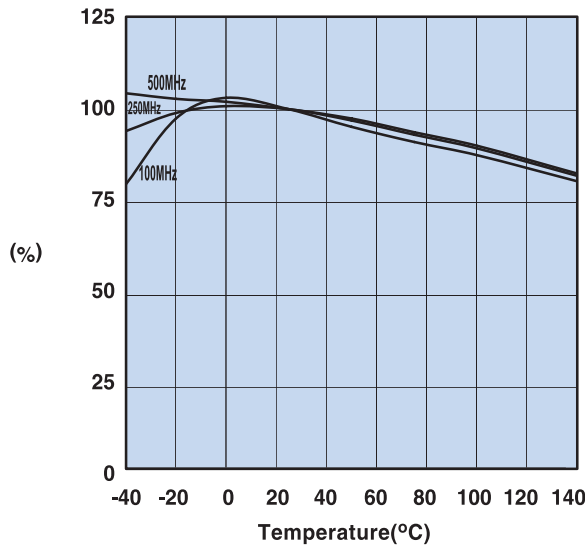

Figure 17 Percent of Original Impedance vs. Temperature Measured on a 2661000301 using the HP4291A.

Secondary Material Parameters

Although μ'_s and μ''_s are the most critical material characteristics for suppression applications, resistivity and Curie temperature are ferrite material parameters that should be considered as well.

The Curie temperature is the transition temperature above which the ferrite loses its magnetic properties. At this temperature the component is no longer performing its intended function. Once the material cools down below this temperature it will again perform as before. For all Fair-Rite materials a minimum Curie temperature is specified.

As mentioned previously, Fair-Rite manufactures three classes of ferrite materials, MnZn, NiZn and MgZn ferrites. The manganese zinc materials have low resistivities whereas the nickel zinc and magnesium zinc materials have high resistivities. For applications that use non-insulated wires or for use as connector suppression plates, a ferrite material with the highest resistivity is recommended. Fair-Rite's 44 material is an improved 43 material by providing both increased resistivity and Curie temperature. Components in the 44 NiZn material are catalog standard parts for connector plates and wound parts such as PC beads and wound beads.

Technical Information

73 Material

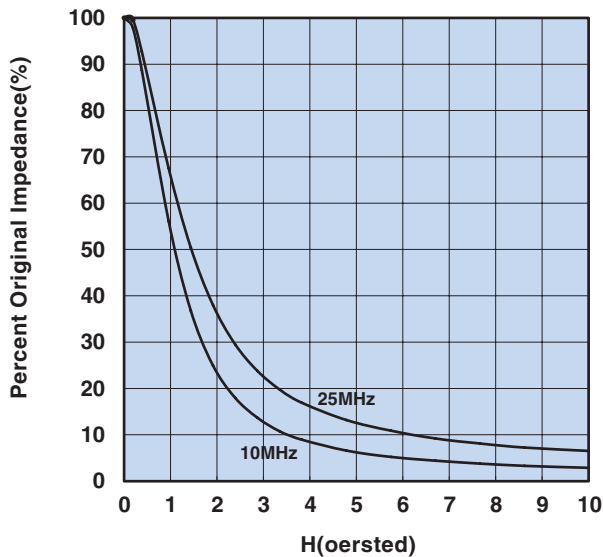

Figure 18 Percent of Original Impedance vs. Magnetic Field Strength. Measured on a 2673000301 using the HP4291A.

31 Material

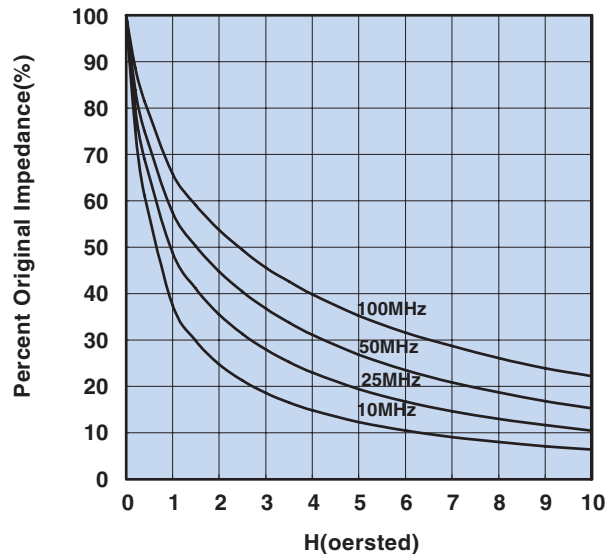

Figure 19 Percent of Original Impedance vs. Magnetic Field Strength. Measured on a 2631000301 using the HP4291A.

43 Material

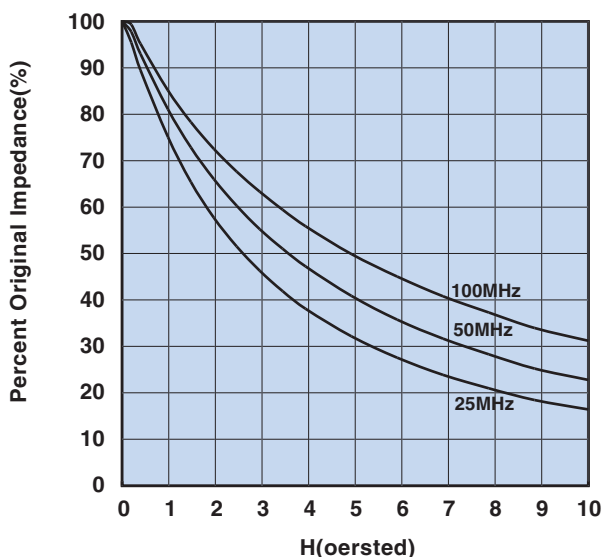

Figure 20 Percent of Original Impedance vs. Magnetic Field Strength. Measured on a 2643000301 using the HP4291A.

44 Material

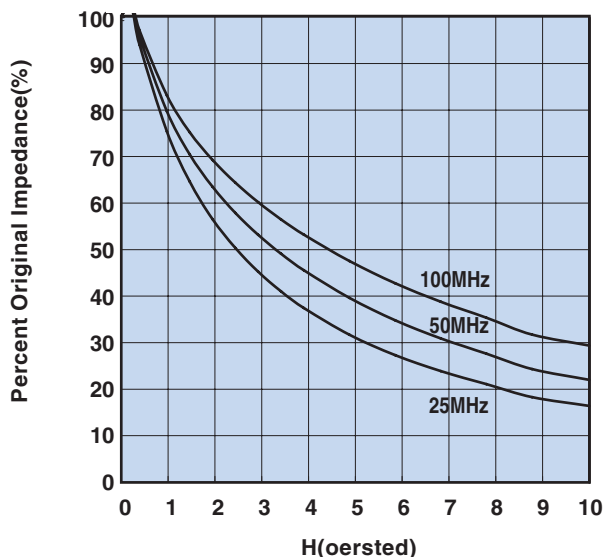

Figure 21 Percent of Original Impedance vs. Magnetic Field Strength. Measured on a 2644000301 using the HP 4291A.

Fair-Rite Products Corp.

PO Box J, One Commercial Row, Wallkill, NY 12589-0288

Phone: (888) FAIR RITE / (845) 895-2055 • FAX: (888) FERRITE / (845) 895-2629 • www.fair-rite.com
 (888) 324-7748 (888) 337-7483 • E-Mail: ferrites@fair-rite.com

Technical Information

46 Material

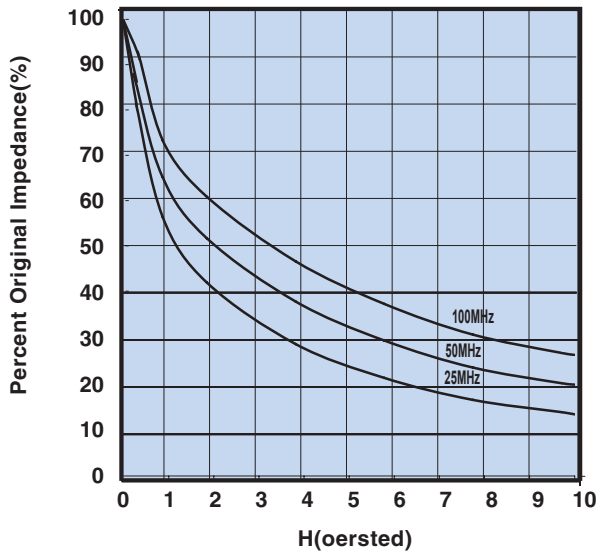

Figure 22 Percent of Original Impedance vs. Magnetic Field Strength. Measured on a 2646000301 using the HP4291A.

61 Material

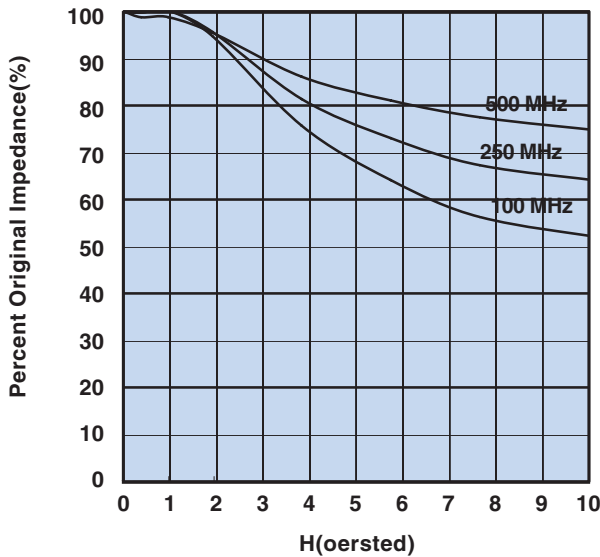

Figure 23 Percent of Original Impedance vs. Magnetic Field Strength. Measured on a 2661000301 using the HP4291A.

Common-Mode Design

If the dc currents are so high that the resulting impedances are not sufficient to suppress the conducted noise, the common-mode approach might solve the problem. As shown in Figure 24, in a common-mode design both current-carrying conductors will pass through the same hole in the core. The dc fields will cancel and the common-mode noise that is picked-up on both lines will be attenuated. It should be pointed out that an EMI signal that is on the line to the load and then returns from the load will not "see" the core and will not be attenuated.

In applications with a large direct current in a single conductor, the solution might be the use of an open magnetic circuit core such as a wound ferrite rod. In automotive designs where the ground is used as the return path, this often is the only option.

When high frequency operating signals, typically above 1 MHz, are susceptible to EMI, the common-mode approach might be used to solve that problem. In this instance common-mode is not used for the current compensation, but rather for the compensation of the high frequency signals. These signal pairs will be not be suppressed, yet any common-mode EMI will be attenuated. The use of round or flat cable cores is a good example of this application of this type of common-mode suppression.

Common-Mode Design

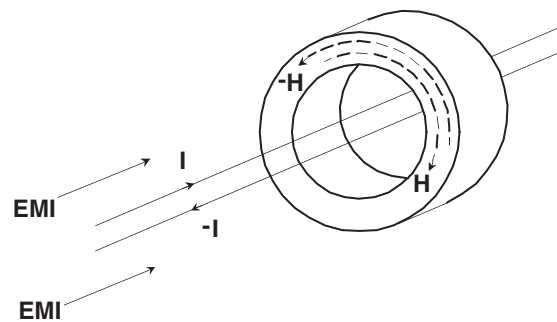

Figure 24

Technical Information

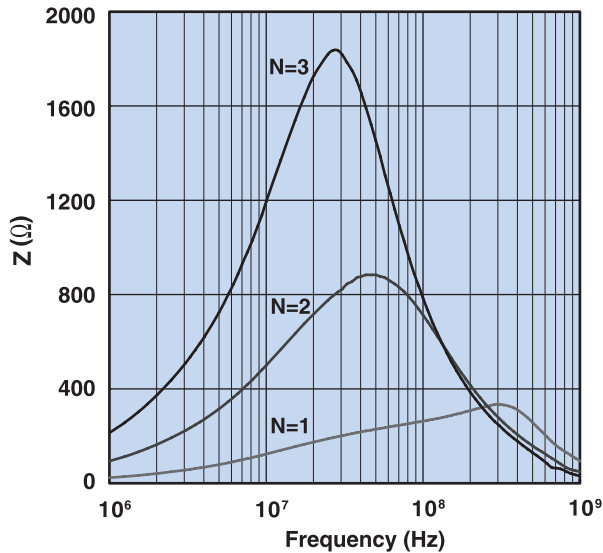

Figure 25 Impedance vs. frequency for a 14/6/28mm cable core in 43 material wound with one, two, and three turns.

Core Selection

Once the proper ferrite material for a specific suppression application has been decided the required ferrite core is the next step in solving the EMI problem. The core contribution to the impedance is expressed in the formula

$$L_o = \frac{4\pi N^2 10^{-9}}{C_1} \text{ (H)}$$

From this formula it is evident that the impedance is proportional to the square of the number of turns and the core geometry shown by the core factor C_1 . The advantage of the proportionality of N^2 is often overlooked and yet can enhance the overall impedance significantly for a rather minor cost. Figure 25 shows the impedance versus frequency curves for one of Fair-Rite's 43 material cable cores wound with one, two and three turns. By increasing the number of turns the winding capacitance is increased resulting in a shift in the maximum impedance to lower frequencies. If an improvement of the low frequency impedance performance is needed, this increase in turns can be very beneficial for the 43 material applications.

The core geometry most often used in suppression applications is the toroidal core. When the dimensions are in inches, the L_o for the toroidal core shape is $1.17 N^2 H \log_{10} OD/ID 10^{-8}$ (H). Of the three core dimensions OD, ID and H (height), the H is the most significant. This dimension is proportional to the toroidal L_o and hence of the impedance of the core. Doubling H will double the volume and also the impedance. Doubling the core volume by changing the OD and or the ID will only increase the impedance by approximately 40%.

Overall the process of selecting a bead or cable core that fits the wire or cable is mainly a mechanical evaluation, but the longer the selected core the higher the impedance for a given volume of ferrite material.

Suppression Materials

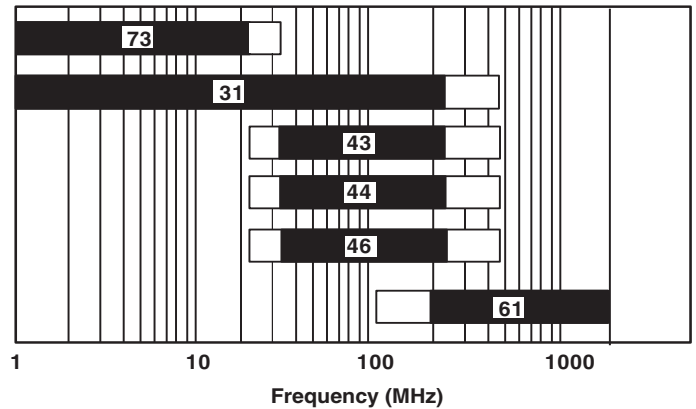

Figure 26 Available Fair-Rite Suppression Materials vs. Frequency

Suppressing Common-Mode Noise

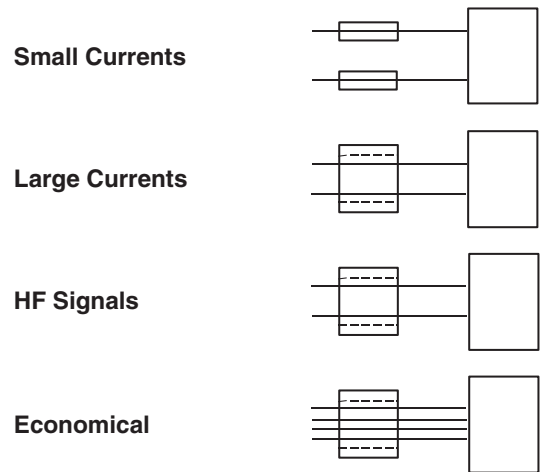

Figure 27

Fair-Rite Products Corp.

PO Box J, One Commercial Row, Wallkill, NY 12589-0288

Phone: (888) FAIR RITE / (845) 895-2055 • FAX: (888) FERRITE / (845) 895-2629 • www.fair-rite.com
 (888) 324-7748 (888) 337-7483 • E-Mail: ferrites@fair-rite.com

Technical Information

Suppressing Differential-Mode Noise

Small Currents

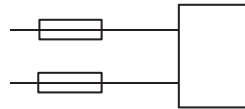

Large Currents

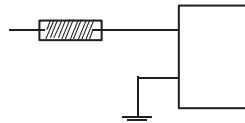

Figure 28

Summary

1. Material Selection

The graph in Figure 26 aids in the initial material selection for suppressing conducted EMI frequencies.

DC bias, core size, operating temperature and resistance requirements might affect this choice.

2. Core Selection

To make a final core selection, the type of EMI, common-mode or differential-mode, will affect the choice of the core configuration.

Figures 27 and 28 provide an overview of the available core shape options for different levels of input currents.

Although the catalog lists hundreds of suppression components, we at Fair-Rite Products Corp. will manufacture parts to fit customer specific applications. Contact one of our representatives or our sales office in Wallkill, NY with your requirements.

Fair-Rite Products Corp.

PO Box J, One Commercial Row, Wallkill, NY 12589-0288

Phone: (888) FAIR RITE / (845) 895-2055 • FAX: (888) FERRITE / (845) 895-2629
(888) 324-7748 (888) 337-7483

• www.fair-rite.com
• E-Mail: ferrites@fair-rite.com

Ferrite Tile Absorbers

for EMC Test Chamber Applications



Introduction

Fair-Rite's tile absorbers provide an attractive alternative to traditional large, foam-type absorber materials for new anechoic chambers or for upgrading older rooms for radiated emission and immunity measurements. While ferrite tiles are a relatively recent development, they have come into use wherever high absorption (-15 to -25 dB at <100 MHz) and compact size (6mm vs 2400mm for foam absorbers) are required. There are now hundreds of installations worldwide in compact and 3/10 meter FCC certified chambers. Ferrites themselves are inherently immune to fire, humidity and chemicals providing a reliable and compact solution for attenuating plane wave reflections in shielded enclosures.

Theory of Operation

The basic physics of operation for any planar electromagnetic absorber involves fundamental concepts as shown in Figure 1. When an electromagnetic wave traveling through free-space encounters a different medium (at $Z=0$), the wave will be reflected, transmitted, and/or absorbed. It is of course, the magnitude of the reflected signal which is usually of interest in this application. For ferrite tiles, the thickness is tuned so that the relative phases of the reflected and exiting wave cancel to form a resonant condition. This resonant condition appears as a deep "null" in the return loss response. This resonance is also a function of the frequency dependent electrical properties of the ferrite material such as relative permeability (μ_r) and permittivity (ϵ_r) which interact to determine the reflection coefficient (Γ), impedance (Z) and return loss (RL) according to the following formulas:

$$Z_f = \sqrt{\frac{\mu_r}{\epsilon_r}} \cdot \tanh \left[\left(\frac{j2\pi d}{\lambda} \right) \left(\sqrt{\mu_r \epsilon_r} \right) \right] \quad (\text{ohm})$$

$$\Gamma = \frac{Z_f - Z_0}{Z_f + Z_0}$$

$$RL = 20 \log_{10} (|\Gamma|) \quad (\text{dB})$$

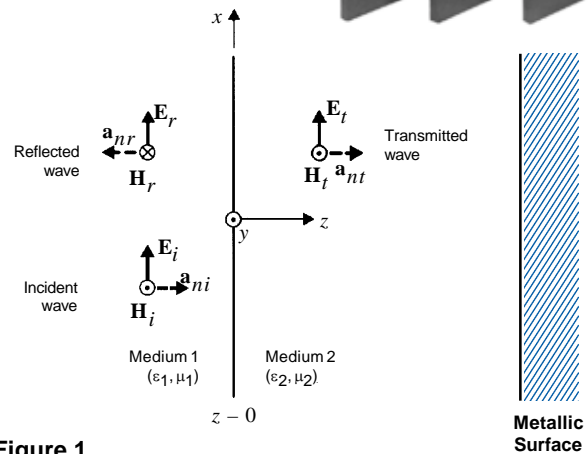

Figure 1

Where :

μ_1 = relative permeability of medium 1 (air)

ϵ_1 = relative permittivity of medium 1 (air)

μ_2 = relative permeability of medium 2 (ferrite)

ϵ_2 = relative permittivity of medium 2 (ferrite)

Γ = reflection coefficient of metal backed ferrite tile

Z_f = input impedance of metal backed ferrite tile

Z_0 = impedance of free space (air)

E_i, H_i = components of incident plane wave

E_r, H_r = reflected components of incident plane wave

E_t, H_t = transmitted components of incident plane wave

d = thickness of medium 2 (ferrite)

Increasing Bandwidth

For some chamber applications increased absorber bandwidth may be desired to comply with high frequency testing needs. One technique shown in Figure 2 increases the bandwidth of ferrite tile installations by mounting the tile over a dielectric spacer (typically wood) of appropriate thickness. When both tile and spacer thicknesses are optimized, the frequency response is shifted upward to improve return loss performance from 600-1500 MHz (see Figure 3). Of course, if increased bandwidth up to 20 GHz is desired, several absorber vendors provide completely engineered hybrid absorbers using specially designed pyramidal and wedge shaped dielectric absorbers matched to ferrite tiles.

Technical Information

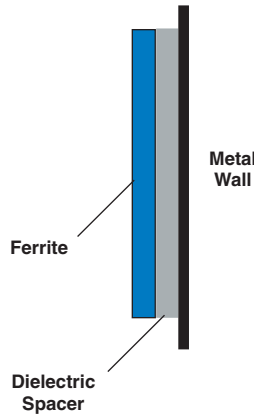

Figure 2

Typical Return Loss vs. Tile Thickness

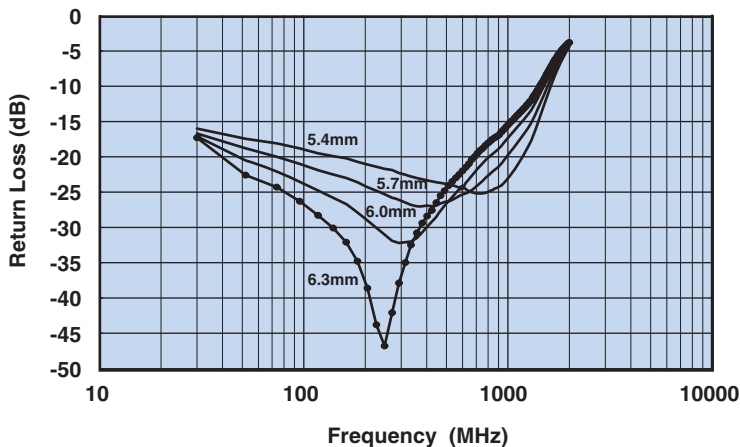

Figure 3
Spacer Thickness = 13mm

Wide Angle Absorption

One of the most overlooked aspects of using any absorber is the rolloff of absorption with increasing angle of incidence. Most published absorber data contains only normal incidence return loss (dB) which is typically where the maximum absorption is obtained. Normal incidence is defined as plane wave radiation arriving perpendicular (0°) to the plane of the absorbing surface. The curves in Figure 4 were generated using equations described in IEEE document "Recommended Practice for RF Absorber Evaluation in the range 30 MHz to 5 GHz". Since the reflections occurring in anechoic chambers seldom illuminate absorber materials at 0°, it is important to consider the reflection angles generated by each chamber geometry and size for best results. For most chambers, the range of angles is in the 40-60° range, however it is usually desirable to operate at < 50°.

Return loss vs angle of incidence for TM polarization is shown in Figure 4. Return loss curves for TE polarization (not shown) are similar.

Wide-Angle Return Loss – TM Polarization

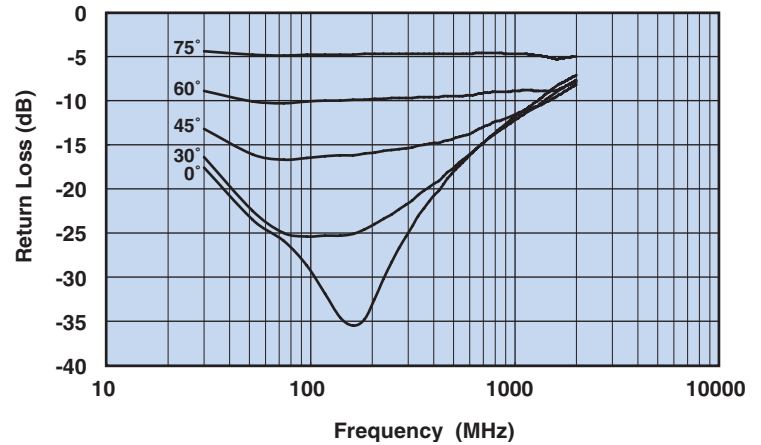

Figure 4

Precision Dimensions

Studies have shown that maximum low-frequency performance is obtained when tile to tile gaps are minimized. Fair-Rite precisely machines each of the six surfaces to $\pm 0.13\text{mm}$ (.005") to ensure a tight tile to tile fit for easier installation with less cutting required. Figure 5 illustrates the effect of gaps on tile performance when installed with: no gap (0mm), 0.25mm and 1.0mm. It is critical to maintain contact between tiles for best results. The final results of the completed test chamber will also be degraded by other factors such as lights, gaps around door openings, and exposed metallic conduit.

Reflectivity vs. Tile – Tile Gap Size

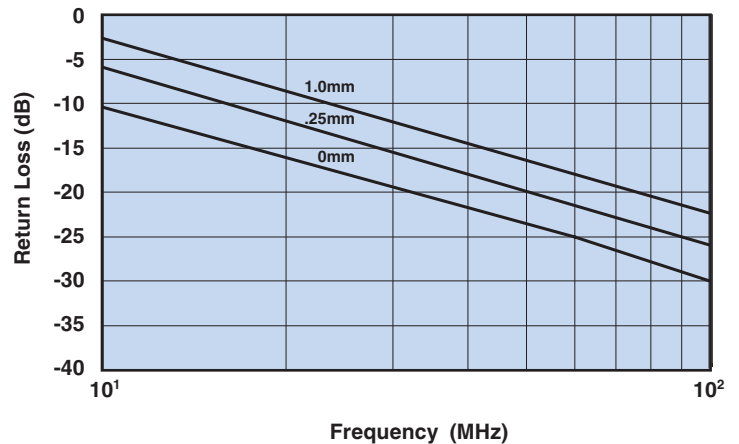

Figure 5

Fair-Rite Products Corp.

Phone: (888) FAIR RITE / (845) 895-2055 • FAX: (888) FERRITE / (845) 895-2629
(888) 324-7748 (888) 337 -7483

PO Box J, One Commercial Row, Wallkill, NY 12589-0288

• www.fair-rite.com
• E-Mail: ferrites@fair-rite.com

Part Number Index

Part Number	Page	Part Number	Page	Part Number	Page	Part Number	Page	Part Number	Page
0199000005	67	0443166651	88	22040210NJ7C	65	2206031N2S7C	66	220603R10J7C	66
0199000018	67	0443167251	77	22040212NJ7C	65	2206031N5S7C	66	220603R10K7F	62
0199000019	67	0443178181	76	22040215NJ7C	65	2206031N8S7C	66	220603R12J7C	66
0199000024	67	0443178281	76	22040218NJ7C	65	2206031R0K7F	62	220603R12K7F	62
0199000025	67	0443625006	76	2204021N0S7C	65	2206031R2K7F	62	220603R15J7C	66
0199000027	67	0443665806	76	2204021N2S7C	65	2206031R5K7F	62	220603R15K7F	62
0199000028	67	0443800506	77	2204021N5S7C	65	2206031R8K7F	62	220603R18J7C	66
0199000029	68	0443806406	77	2204021N8S7C	65	22060322NJ7C	66	220603R18K7F	62
0199000030	68	0444164181	77	22040222NJ7C	65	22060327NJ7C	66	220603R22J7C	66
0199000031	68	0444164281	76	22040227NJ7C	65	2206032N2S7C	66	220603R22K7F	62
0199000032	68	0444164951	76	2204022N2S7C	65	2206032N7S7C	66	220603R27K7F	62
0199000033	68	0444167281	77	2204022N7S7C	65	2206032R2K7F	62	220603R33K7F	62
0199000035	68	0444173551	77	22040233NJ7C	65	2206032R7K7F	62	220603R39K7F	62
0199000036	68	0444173951	76	22040239NJ7C	65	22060333NJ7C	66	220603R47K7F	62
0199001401	86	0444176451	77	2204023N3S7C	65	22060339NJ7C	66	220603R56K7F	62
0199010301	86	0444177081	77	2204023N9S7C	65	2206033N3S7C	66	220603R68K7F	62
0199016051	86	0446164151	77	22040247NJ7C	65	2206033N9S7C	66	220603R82K7F	62
0199016551	86	0446164181	77	2204024N7S7C	65	2206033R3K7F	62	22080510RK7F	63
0431163951	88	0446164251	77	22040256NJ7C	65	2206033R9K7F	62	22080512RK7F	63
0431164051	88	0446164281	77	2204025N6S7C	65	22060347NJ7C	66	22080515RK7F	63
0431164181	76	0446164951	77	22040268NJ7C	65	22060347NM7F	62	22080518RK7F	63
0431164281	76	0446167251	77	2204026N8J7C	65	2206034N7S7C	66	2208051R0K7F	63
0431164951	76	0446167281	77	22040282NJ7C	65	2206034R7K7F	62	2208051R2K7F	63
0431167281	76	0446173551	77	2204028N2J7C	65	22060356NJ7C	66	2208051R5K7F	63
0431173551	76	0446173951	77	220402R10J7C	65	2206035N6S7C	66	2208051R8K7F	63
0431173951	76	0446176451	77	220402R12J7C	65	2206035R6K7F	62	22080522RK7F	63
0431176451	76	0446177081	77	22060310NJ7C	66	22060368NJ7C	66	22080527RK7F	63
0431177081	76	0461164181	78	22060310RK7F	62	22060368NM7F	62	2208052R2K7F	63
0431178181	76	0461164281	78	22060312NJ7C	66	2206036N8J7C	66	2208052R7K7F	63
0431178281	76	0461164951	78	22060312RK7F	62	2206036R8K7F	62	22080533RK7F	63
0443163951	88	0461167281	78	22060315NJ7C	66	22060382NJ7C	66	22080539RK7F	63
0443164051	88	0461176451	78	22060315RK7F	62	22060382NM7F	62	2208053R3K7F	63
0443164151	77	0461178181	78	22060318NJ7C	66	2206038N2J7C	66	2208053R9K7F	63
0443164251	76	0461178281	78	2206031N0S7C	66	2206038R2K7F	62	22080547NM7F	63

Fair-Rite Products Corp.

PO Box J, One Commercial Row, Wallkill, NY 12589-0288

Phone: (888) FAIR RITE / (845) 895-2055 • FAX: (888) FERRITE / (845) 895-2629
(888) 324-7748

• www.fair-rite.com
• E-Mail: ferrites@fair-rite.com

Part Number Index

Part Number	Page	Part Number	Page	Part Number	Page	Part Number	Page	Part Number	Page
22080522RK7F	63	2212061R5K7F	64	2504026017Y0	56	2508053007Y0	56	2512067007Y0	57
22080527RK7F	63	2212061R8K7F	64	2506030707H0	56	2508053007Y3	57	2512067007Y3	57
2208052R2K7F	63	22120622RK7F	64	2506031007H0	56	2508053017Y0	56	2512069007Y0	57
2208052R7K7F	63	22120627RK7F	64	2506031017Y0	56	2508053017Y3	57	2518061017Y0	57
22080533RK7F	63	2212062R2K7F	64	2506031027Y0	56	2508053017Z0	56	2518061017Y6	57
22080539RK7F	63	2212062R7K7F	64	2506031217Y0	56	2508055007Y0	56	2518061517Y0	57
2208053R3K7F	63	22120633RK7F	64	2506031217Y2	57	2508056007Y0	56	2518065007Y6	57
2208053R9K7F	63	22120639RK7F	64	2506031217H0	56	2508056007Y3	57	2518066007Y3	57
22080547NM7F	63	2212063R3K7F	64	2506031217Z0	56	2508056007Y6	57	2518068007Y3	57
22080547RK7F	63	2212063R9K7F	64	2506031517Y0	56	2508056007Z0	56	2518121217Y3	57
2208054R7K7F	63	22120647NM7F	64	2506032217H0	56	2508056017Y0	56	2518121217Y6	57
2208055R6K7F	63	22120647RK7F	64	2506033007Y0	56	2508056017Y2	57	2518127007Y3	57
22080568NM7F	63	2212064R7K7F	64	2506033007Y3	57	2508059007Y0	56	2631023002	70
2208056R8K7F	63	2212065R6K7F	64	2506033017Y0	56	2512061017Y0	57	2631101902	71
22080582NM7F	63	22120668NM7F	64	2506033017Z0	56	2512061027Y0	57	2631102002	71
2208058R2K7F	63	2212066R8K7F	64	2506033317H0	56	2512061027Y0A4	59	2631103002	71
220805R10K7F	63	22120682NM7F	64	2506036007Y0	56	2512061027Y1	57	2631163851	84
220805R12K7F	63	2212068R2K7F	64	2506036007Y3	57	2512061217Y0	57	2631163951	84
220805R15K7F	63	221206R10K7F	64	2506036007Z0	56	2512061217Y0A4	59	2631164051	84
220805R18K7F	63	221206R12K7F	64	2506036017Y0	56	2512061217Y5	57	2631164181	80
220805R22K7F	63	221206R15K7F	64	2506038007Y0	56	2512061517Y3	57	2631164281	80
220805R27K7F	63	221206R18K7F	64	2508050507H0	56	2512061527Y0	57	2631164951	80
220805R33K7F	63	221206R22K7F	64	2508051017Y0	56	2512063007Y0	57	2631167281	80
220805R39K7F	63	221206R27K7F	64	2508051027Y0	56	2512063007Y3	57	2631173551	80
220805R47K7F	63	221206R33K7F	64	2508051027Y1	57	2512063017Y0	57	2631173951	80
220805R56K7F	63	221206R39K7F	64	2508051107Y0	56	2512063017Y0A4	59	2631176451	80
220805R68K7F	63	221206R47K7F	64	2508051217Y0	56	2512063017Y3	57	2631177081	80
220805R82K7F	63	221206R56K7F	64	2508051217Y3	57	2512065007Y0	57	2631178181	80
22120610RK7F	64	221206R68K7F	64	2508051217Y6	57	2512065007Y3	57	2631178281	80
22120612RK7F	64	221206R82K7F	64	2508051217Z0	56	2512065007Y6	57	2631250202	70
22120615RK7F	64	2504021007Y0	56	2508051527Y0	56	2512066007Y0A4	59	2631480002	70
22120618RK7F	64	2504021217Y0	56	2508051817Y0	56	2512066017Y0	57	2631480102	70
2212061R0K7F	64	2504023017Y0	56	2508052027Y1	57	2512066017Y0A4	59	2631540002	70
2212061R2K7F	64	2504026007Y0	56	2508052027Z0	56	2512066017Y1	57	2631540202	70

Fair-Rite Products Corp.

PO Box J, One Commercial Row, Wallkill, NY 12589-0288

Phone: (888) FAIR RITE / (845) 895-2055 • FAX: (888) FERRITE / (845) 895-2629
(888) 324-7748

• www.fair-rite.com
• E-Mail: ferrites@fair-rite.com

Part Number Index

Part Number	Page	Part Number	Page	Part Number	Page	Part Number	Page	Part Number	Page
2631625002	70	2643023402	32	2643171051	84	2643626102	73	2644236001	90
2631625102	70	2643023801	31	2643172551	85	2643626202	73	2644236101	90
2631626202	71	2643025601	31	2643173351	84	2643626302	72	2644236301	90
2631626302	71	2643101902	72	2643175451	91	2643626402	72	2644236401	90
2631626402	71	2643102002	72	2643178181	80	2643626502	72	2644236501	90
2631665702	70	2643102402	72	2643178281	80	2643665702	72	2644236601	90
2631665802	70	2643103002	73	2643178351	84	2643665802	72	2644245701	90
2631801202	71	2643103102	72	2643178451	84	2643665806	80	2644246201	90
2631803802	71	2643163851	85	2643178551	84	2643665902	72	2644246701	90
2643000101	31	2643163951	85	2643178651	84	2643706001	31	2644247001	90
2643000201	31	2643164051	85	2643178751	85	2643800302	71	2644247101	90
2643000301	31	2643164151	81	2643178851	85	2643800502	72	2644373841	90
2643000501	31	2643164251	80	2643200101	31	2643800506	81	2644373941	90
2643000701	31	2643164551	84	2643250202	32	2643800602	72	2644666611	43
2643000801	31	2643165151	91	2643250302	32	2643801002	72	2644777711	43
2643001301	31	2643165451	80	2643250402	32	2643801102	71	2646101902	73
2643001501	31	2643166451	85	2643251002	72	2643801202	72	2646102002	73
2643001601	31	2643166551	85	2643300101	32	2643801402	72	2646102402	73
2643002201	31	2643166651	85	2643375002	32	2643801502	72	2646103002	74
2643002402	32	2643166751	80	2643375102	32	2643801802	72	2646164151	81
2643003201	32	2643166851	85	2643480002	71	2643801902	71	2646164181	81
2643004101	31	2643167251	81	2643480102	71	2643802702	73	2646164251	81
2643004601	31	2643167551	85	2643540002	71	2643803802	73	2646164281	81
2643004701	31	2643167751	85	2643540102	71	2643804502	73	2646164951	81
2643004801	31	2643167851	91	2643540202	71	2643806402	72	2646167251	81
2643005701	31	2643168051	85	2643540302	71	2643806406	81	2646167281	81
2643006302	32	2643168251	85	2643540402	71	2644164181	81	2646173551	81
2643012702	32	2643168351	85	2643540702	71	2644164281	80	2646173951	81
2643013801	31	2643168651	84	2643625002	72	2644164951	80	2646176451	81
2643020501	31	2643168751	84	2643625006	80	2644167281	81	2646177081	81
2643021801	31	2643169351	85	2643625102	72	2644173551	81	2646480002	73
2643022401	31	2643169552	84	2643625202	72	2644173951	80	2646480102	73
2643023002	32	2643170251	84	2643625902	73	2644176451	81	2646540002	73
2643023201	31	2643170951	85	2643626002	73	2644177081	81	2646540202	73

Fair-Rite Products Corp.

PO Box J, One Commercial Row, Wallkill, NY 12589-0288

Phone: (888) FAIR RITE / (845) 895-2055 • FAX: (888) FERRITE / (845) 895-2629
(888) 324-7748 (888) 337-7483

• www.fair-rite.com
• E-Mail: ferrites@fair-rite.com

Part Number Index

Part Number	Page	Part Number	Page	Part Number	Page	Part Number	Page	Part Number	Page
2646625002	73	2661626302	74	2743002112	35	2752555567	48	2843000102	45
2646625102	73	2661626402	74	2743003112	35	2752555577	48	2843000202	45
2646625202	73	2661665702	74	2743004112	35	2752770347	40	2843000302	45
2646626202	74	2661665802	74	2743005112	35	2752776147	40	2843001502	45
2646665702	73	2661666611	43	2743007112	35	2752778147	40	2843001702	45
2646665802	73	2661801902	74	2743008112	35	2752778347	40	2843001802	45
2646803802	74	2673000101	30	2743009112	35	2752780347	40	2843002302	45
2646804502	74	2673000201	30	2743012201	35	2752786147	40	2843002402	45
2661000101	33	2673000301	30	2743013211	35	2752788147	40	2843002702	45
2661000301	33	2673000501	30	2743014221	35	2752788347	40	2843006802	45
2661000701	33	2673000701	30	2743015112	35	2761001112	35	2843009902	45
2661000801	33	2673000801	30	2743019447	48	2761002112	35	2843010302	45
2661002201	33	2673001601	30	2743021447	48	2761003112	35	2843010402	45
2661002402	33	2673002201	30	2743037447	48	2761004112	35	2861000102	46
2661005701	33	2673002402	30	2744040447	48	2761005112	35	2861000202	46
2661021801	33	2673003201	30	2744041447	52	2761007112	35	2861000302	46
2661022401	33	2673004601	29	2744044447	48	2761008112	35	2861001502	46
2661023801	33	2673004701	29	2744045447	52	2761009112	35	2861001702	46
2661030101	33	2673004801	30	2744051447	52	2761015112	35	2861001802	46
2661102002	74	2673004901	30	2744065447	52	2761019447	48	2861002302	46
2661102402	74	2673010101	29	2744555567	48	2761021447	48	2861002402	46
2661164181	82	2673012401	30	2744555577	48	2773001112	34	2861002702	46
2661164281	82	2673015301	30	2744770347	40	2773002112	34	2861006802	46
2661164951	82	2673018001	30	2744776147	40	2773003112	34	2861010002	46
2661167281	82	2673021801	30	2744778147	40	2773004112	34	2867000102	46
2661176451	82	2673022401	30	2744778347	40	2773005112	34	2867000202	46
2661178181	82	2673025301	29	2744780347	40	2773007112	34	2867000302	46
2661178281	82	2673028602	30	2744786147	40	2773008112	34	2867001502	46
2661250202	33	2673030101	29	2744788147	40	2773009112	34	2867001702	46
2661250402	33	2673200201	30	2744788347	40	2773015112	34	2867001802	46
2661375102	33	2673901301	29	2752041447	52	2773019447	48	2867002302	46
2661480002	74	2677006302	91	2752045447	52	2773021447	48	2867002402	46
2661540002	74	2677102402	91	2752051447	52	2773037447	48	2867002702	46
2661540202	74	2743001112	35	2752065447	52	2773044447	48	2867006802	46

Fair-Rite Products Corp.

PO Box J, One Commercial Row, Wallkill, NY 12589-0288

Phone: (888) FAIR RITE / (845) 895-2055 • FAX: (888) FERRITE / (845) 895-2629
(888) 324-7748

• www.fair-rite.com
• E-Mail: ferrites@fair-rite.com

Part Number Index

Part Number	Page	Part Number	Page	Part Number	Page	Part Number	Page	Part Number	Page
2873000102	45	2961666651	43	3742011901	94	4277182209	97	5943005101	107
2873000202	45	2961666661	43	4033122011	97	4277242409	97	5943006401	108
2873000302	45	2961666671	43	4033129021	97	4277352509	97	5943007601	108
2873001502	45	2961666681	43	4033266011	97	4277353509	97	5943011101	108
2873001702	45	3061990821	100	4033276011	97	4278282509	97	5943015901	108
2873001802	45	3061990831	100	4052077111	96	4278453509	97	5943017301	108
2873002302	45	3061990841	100	4052098411	96	5678090521	114	5943017501	108
2873002402	45	3061990851	100	4052111011	96	5678110721	114	5943018601	108
2873002702	45	3061990861	100	4052155611	96	5678140821	114	5943018701	108
2873006802	45	3061990871	100	4052195211	96	5678181121	114	5961000101	106
2944666631	43	3061990881	101	4052235211	96	5678221321	114	5961000201	106
2944666651	43	3061990891	101	4052251111	96	5678261621	114	5961000301	106
2944666661	43	3061990901	101	4061129011	96	5678301921	114	5961000501	107
2944666671	43	3061990911	101	4061266011	96	5678362221	114	5961000601	106
2944666681	43	3067990821	100	4061272011	96	5678422921	114	5961001001	107
2944770301	36	3067990831	100	4061276011	96	5943000101	107	5961001101	106
2944776101	36	3067990841	100	4061287011	96	5943000201	107	5961001201	107
2944777721	43	3067990851	100	4061378111	96	5943000301	107	5961001701	107
2944777741	43	3067990861	100	4077122011	97	5943000501	107	5961001801	107
2944778101	36	3067990871	100	4077172011	97	5943000601	107	5961001901	106
2944778301	36	3067990881	101	4077266011	97	5943000801	107	5961002701	107
2944780301	36	3078990821	101	4077272011	97	5943001001	108	5961003801	107
2944786101	36	3078990831	101	4077276011	97	5943001101	107	5961004901	106
2944788101	36	3078990841	101	4077292011	97	5943001201	108	5967000201	106
2944788301	36	3078990851	101	4077296011	97	5943001301	108	5967000301	106
2952770301	37	3078990861	101	4077312911	97	5943001401	108	5967000601	106
2952776101	37	3078990871	101	4077374711	97	5943001601	108	5967001101	106
2952778101	37	3078990881	101	4077375211	97	5943001701	108	5967001801	107
2952778301	37	3078990891	101	4077375411	97	5943001801	108	5967001901	106
2952780301	37	3078990901	101	4077484611	97	5943001901	107	5967002701	107
2952786101	37	3078990911	101	4077485111	97	5943002101	107	5967003801	107
2952788101	37	3642011601	94	4078375111	97	5943002701	108	5975000101	111
2952788301	37	3642012401	94	4078377511	97	5943003801	108	5975000201	111
2961666631	43	3642014000	93	4277142009	97	5943004901	107	5975000301	112

Fair-Rite Products Corp.

PO Box J, One Commercial Row, Wallkill, NY 12589-0288

Phone: (888) FAIR RITE / (845) 895-2055 • FAX: (888) FERRITE / (845) 895-2629
(888) 324-7748

• www.fair-rite.com
• E-Mail: ferrites@fair-rite.com

Part Number Index

Part Number	Page	Part Number	Page	Part Number	Page	Part Number	Page	Part Number	Page
5975000501	112	5977001301	110	5978004901	109	9077025002	122	9477625002	118
5975000601	112	5977001401	110	5978005101	109	9077026002	122	9478012002	116
5975000801	111	5977001601	110	5978006401	110	9277002002	122	9478014002	118
5975001001	112	5977001701	110	5978007601	110	9277008002	122	9478015002	116
5975001101	112	5977001801	109	5978008001	111	9277010002	122	9478016002	116
5975001301	112	5977001901	109	5978011101	111	9277012002	122	9478017002	118
5975001401	112	5977002101	109	5978014001	111	9277023002	122	9478019002	116
5975001601	112	5977002701	110	5978015901	111	9277024002	122	9478020002	116
5975001701	112	5977003801	111	5978017301	111	9375020002	120	9478034002	118
5975001801	112	5977004901	109	5978017501	111	9377020002	120	9478036002	118
5975001901	112	5977005101	109	5978018601	111	9377024002	120	9478375002	118
5975002101	111	5977006401	110	5978018701	111	9377036002	120	9478500002	118
5975002701	112	5977007601	110	5985000101	113	9378020002	120	9478625002	118
5975003801	112	5977011101	111	5985000201	113	9378024002	120	9643001015	104
5975004901	112	5978000101	109	5985000801	113	9378036002	120	9643001165	104
5975005101	112	5978000201	109	5985001101	113	9475012002	116	9677001015	104
5975006401	112	5978000301	109	5985001301	113	9475014002	118	9677001165	104
5975007601	112	5978000501	109	5985001801	113	9475015002	118	9677142089	104
5975011101	112	5978000601	109	5985002101	113	9475016002	116	9677182089	104
5976000101	111	5978000801	108	5985004901	113	9475019002	116	9677182289	104
5976000201	111	5978001001	110	5985010101	113	9475020002	116	9677242089	104
5976000801	111	5978001101	109	5985010201	113	9477012002	116	9677242489	104
5976002101	111	5978001201	110	5985013501	113	9477014002	118	9677282009	104
5977000101	109	5978001301	110	5985015501	113	9477015002	116	9677282509	104
5977000201	109	5978001401	110	5985016001	113	9477016002	116	9677352509	104
5977000301	109	5978001601	110	7177141009	103	9477017002	118	9677353509	104
5977000501	109	5978001701	110	7177181009	103	9477019002	116	9677453509	104
5977000601	109	5978001801	109	7177181109	103	9477020002	116	9843000104	104
5977000801	108	5978001901	109	7177241009	103	9477034002	118	9877000104	104
5977001001	110	5978002101	109	7177241209	103	9477036002	118	9877000204	104
5977001101	109	5978002701	110	9077002002	122	9477375002	118		
5977001201	110	5978003801	111	9077024002	122	9477500002	118		

Fair-Rite Products Corp.

PO Box J, One Commercial Row, Wallkill, NY 12589-0288

Phone: (888) FAIR RITE / (845) 895-2055 • FAX: (888) FERRITE / (845) 895-2629
(888) 324-7748

• www.fair-rite.com
• E-Mail: ferrites@fair-rite.com

Our Position on Quality and the Environment

Fair-Rite Products Corp. is committed to be “Your Signal Solution”. Management and employees continue to apply our certified QS-9000 / ISO 9000 quality system while preparing for TS 16949 registration providing continuous improvement towards defect prevention, variation reduction and customer satisfaction. We are committed to offering high quality products and services while maintaining an environmentally friendly and sustainable manufacturing process. As a responsible member of the corporate and local community, Fair-Rite continues to stay proactive in compliance with local, national and international environmental regulations regarding manufacturing, emissions and documentation.

Modern value enhancement tools, including Controls Plans, Advanced Product Quality Planning (APQP), Production Part Approval Process (PPAP), Failure Mode and Effects Analysis (FMEA) and Feasibility Assessments, are available for the quality planning process. Contract review, design control, and the purchasing function all meet the new requirements of TS 16949. Process and product control, including measurement, traceability, handling and delivery, meet the highest quality standards. Any nonconforming or suspect product is tracked. Corrective and preventive actions, statistical methods, and internal audits are applied to guarantee continuous improvement. Extensive training is provided to all employees to support the system. Product inspection, tests and records verify that specified requirements are met. Critical characteristics are monitored by statistical methods, including pre-control, control charts, and SPC. Process capability indices, Cpk's, are targeted to exceed 1.33. When sampling plans are employed, zero defects are allowed in any sample. Visual inspection criteria for chips, cracks and surface finish are documented. IEC Standard 60424 is used as a guide for evaluation of visual imperfections.

All Fair-Rite Products Corp. standard components are RoHS compliant. Plastic cases used to assemble Fair-Rite “Snap-It” cores do not contain PBB or PBDE as a flame retardant. Termination wire used on board level components has 100% matte tin plating with a nickel barrier and is Pb free. All multi-layer chip components are terminated with RoHS compliant 100% tin plating. Both these types are forward and backwards compatible with standard soldering processes.

Preferred parts, printed bold, are recommended for new designs. Samples are readily available and orders can be shipped with shorter lead times than other standard catalog parts.

Fair-Rite Products Corp. adheres to the practice of continuous improvement. Therefore, in order to offer our customers optimized designs, the company reserves the right to change materials, designs, dimensions, etc. at any time without notice.

Fair-Rite Products Corp.

PO Box J, One Commercial Row, Wallkill, NY 12589-0288

Phone: **(888) FAIR RITE / (845) 895-2055** • FAX: (888) FERRITE / (845) 895-2629
(888) 324-7748 (888) 337 -7483

• www.fair-rite.com
 • E-Mail: ferrites@fair-rite.com

0431163951

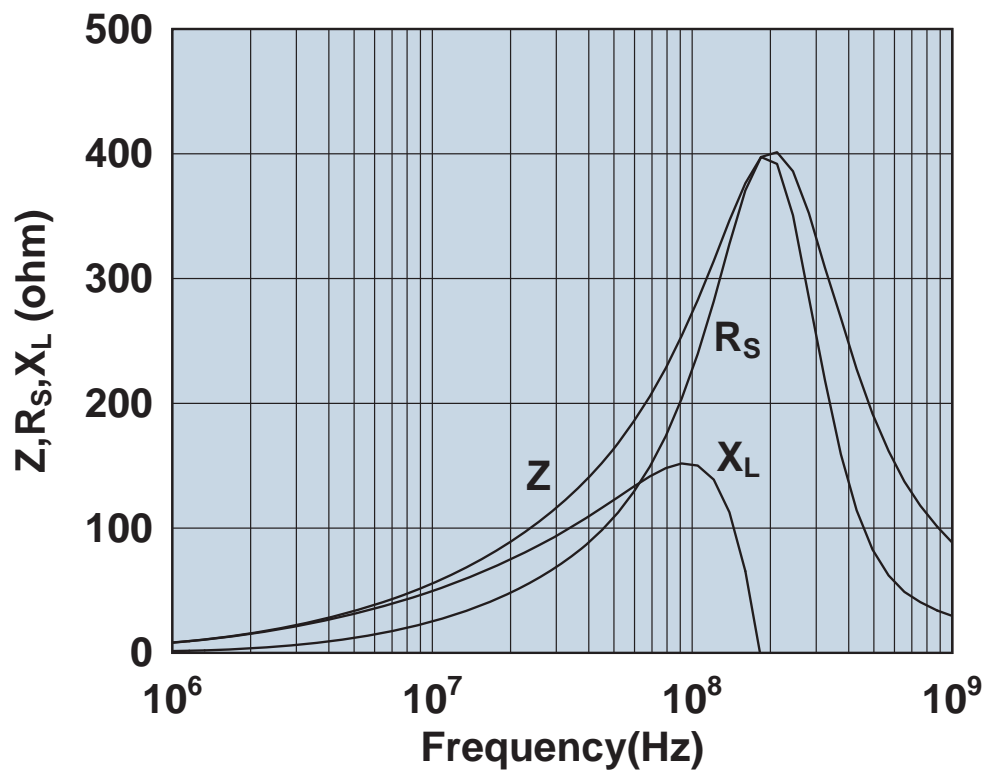

Impedance, reactance, and resistance vs. frequency.

0431164051

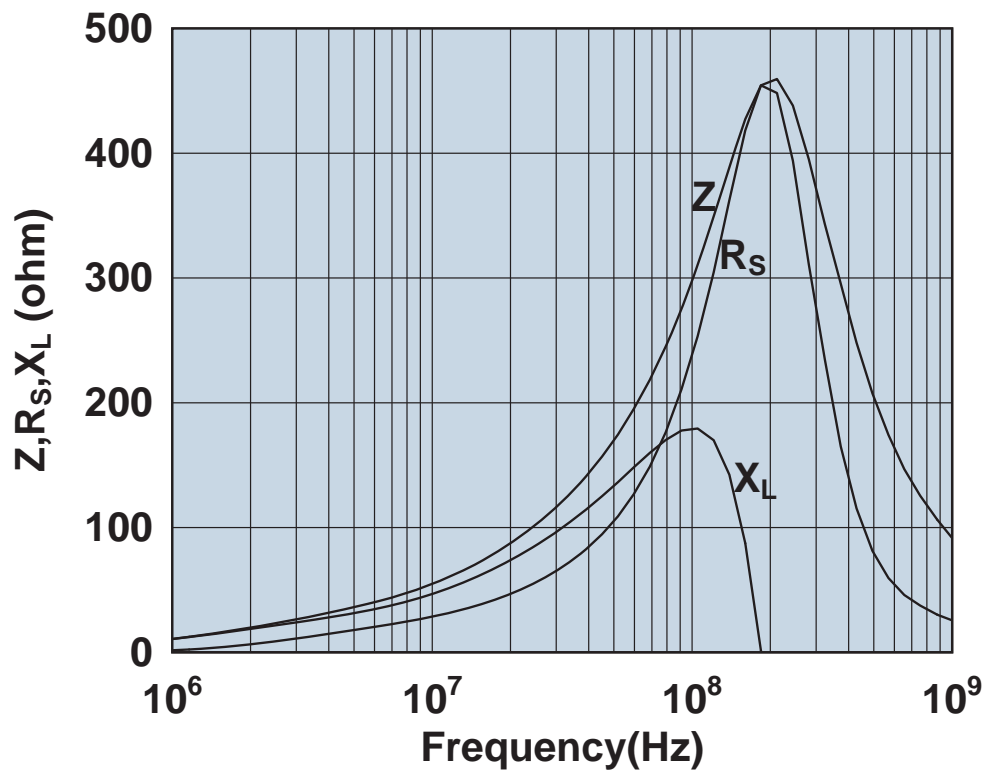

Impedance, reactance, and resistance vs. frequency.

0431164181

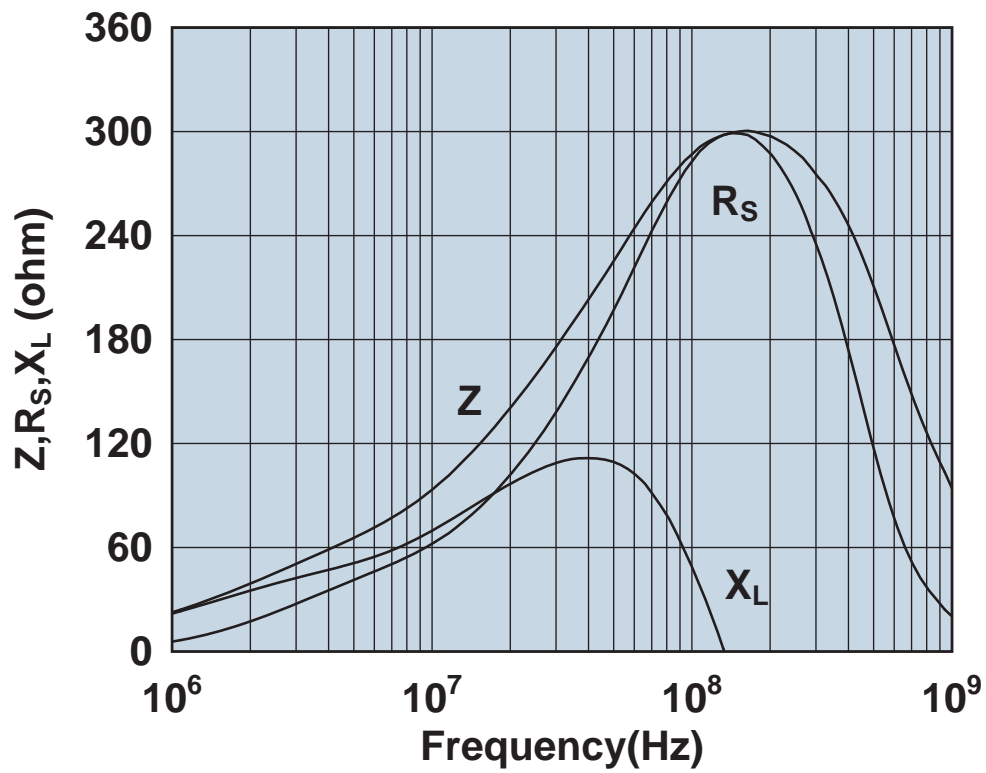

Impedance, reactance, and resistance vs. frequency.

0431164281

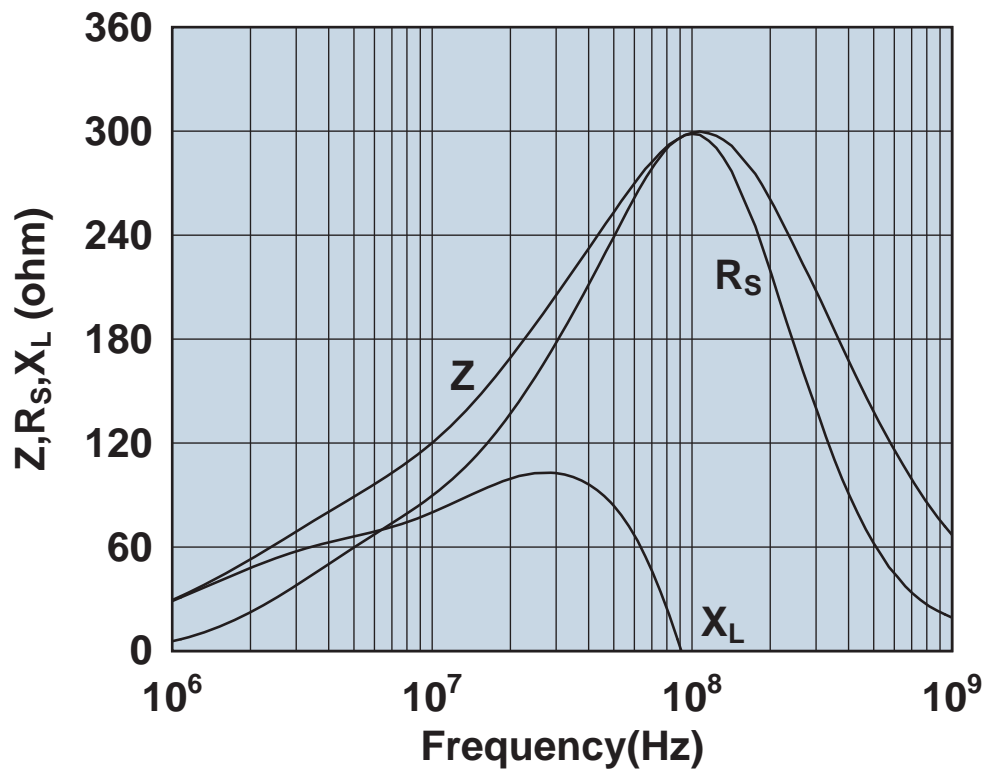

Impedance, reactance, and resistance vs. frequency.

0431164951

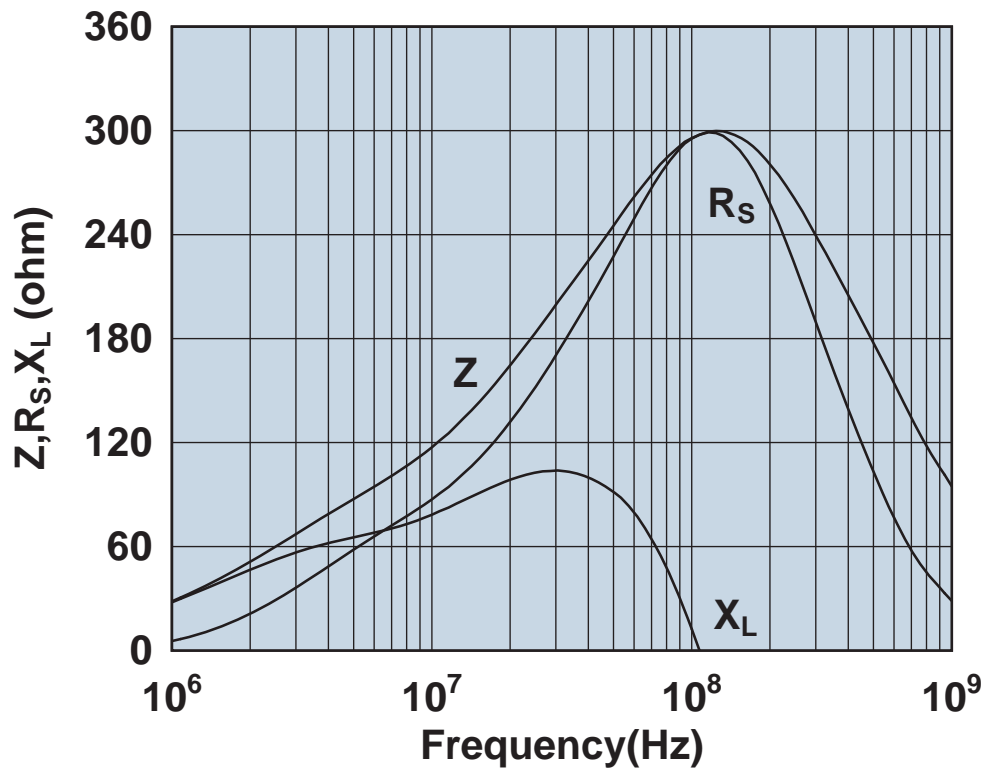

Impedance, reactance, and resistance vs. frequency.

0431167281

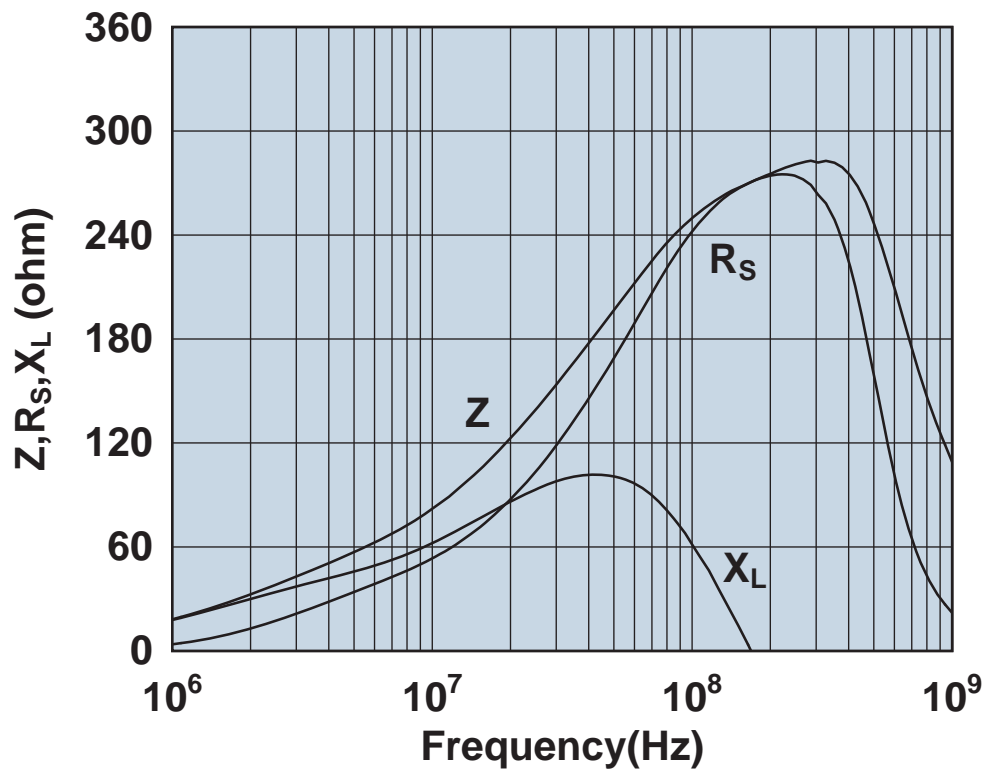

Impedance, reactance, and resistance vs. frequency.

0431173551

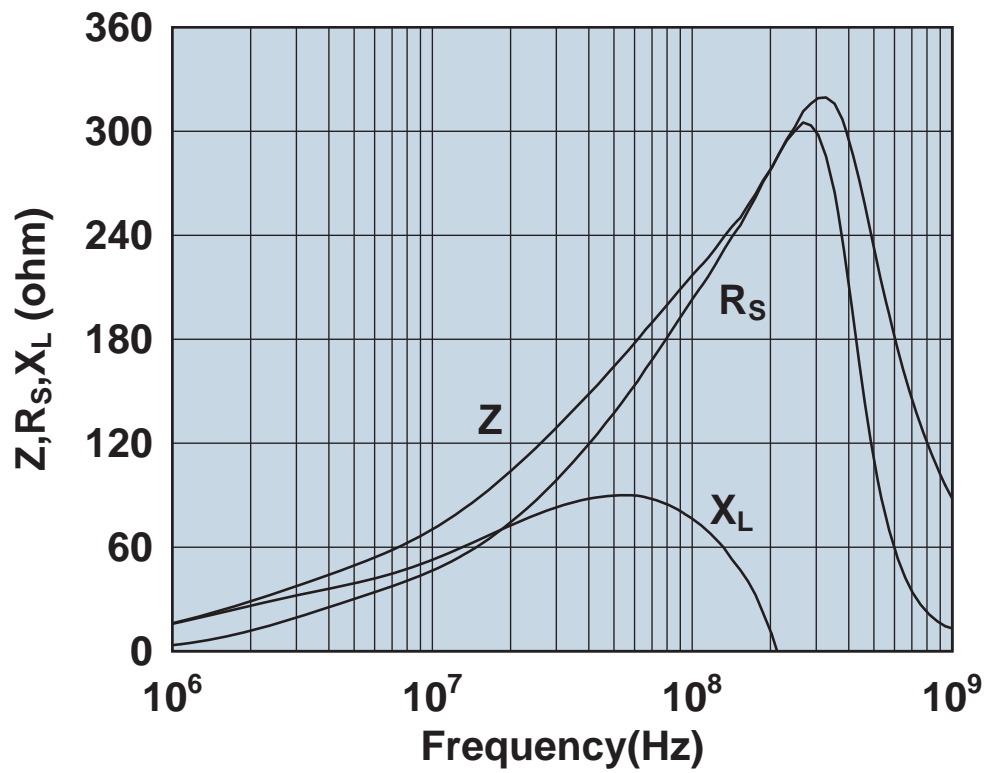

Impedance, reactance, and resistance vs. frequency.

0431173951

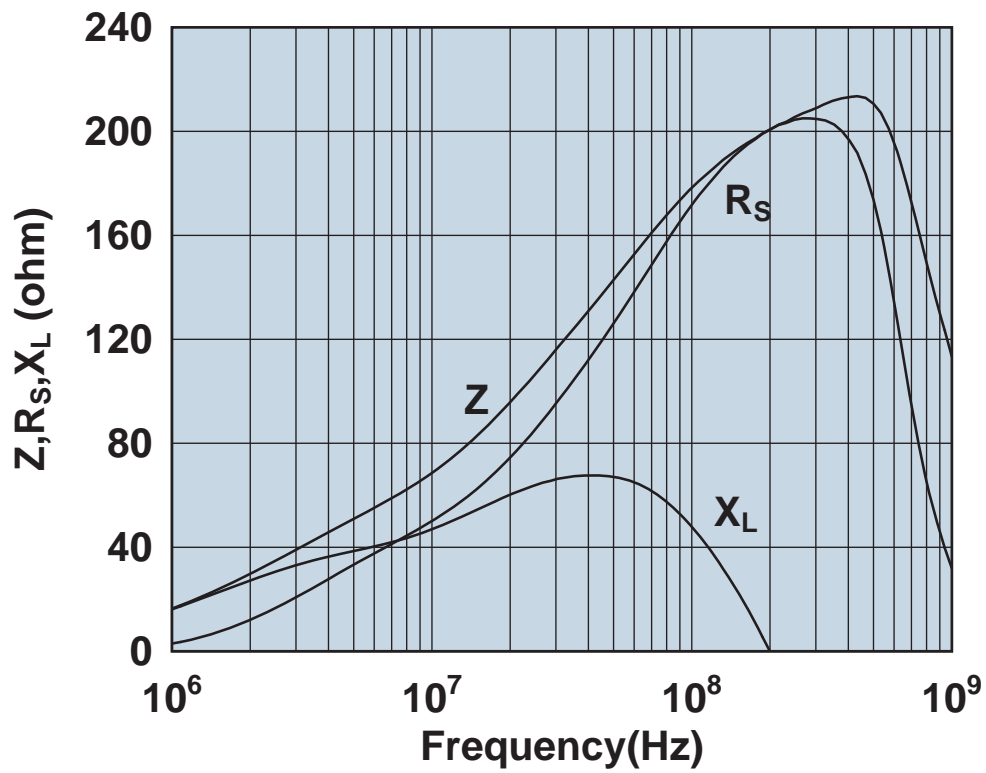

Impedance, reactance, and resistance vs. frequency.

0431176451

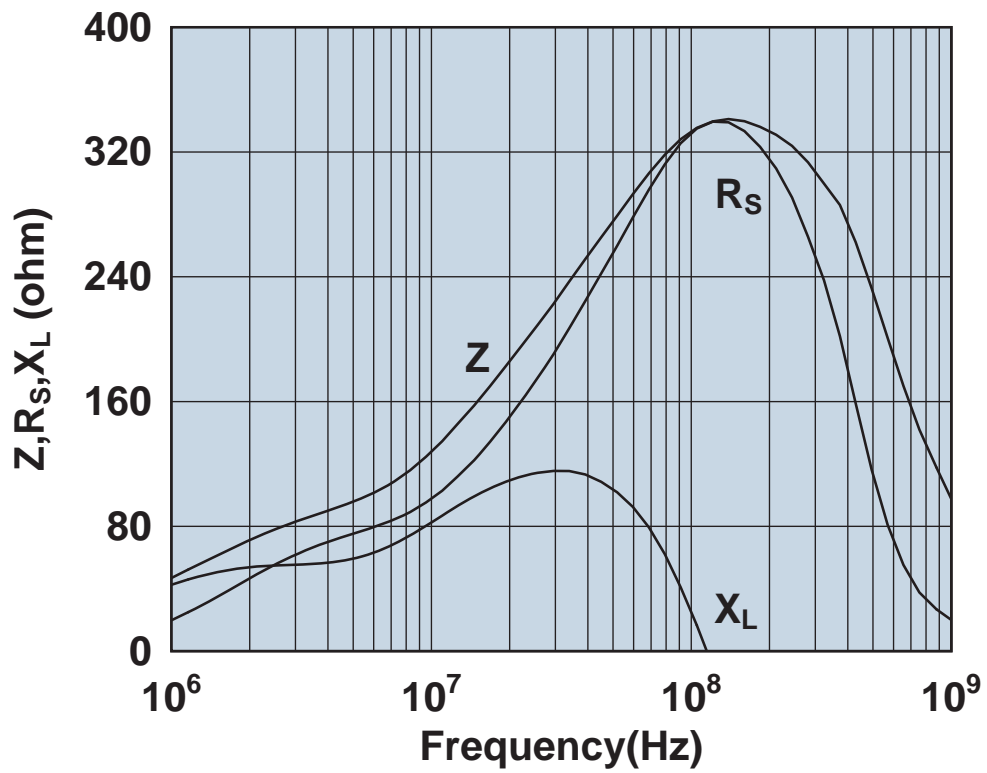

Impedance, reactance, and resistance vs. frequency.

0431177081

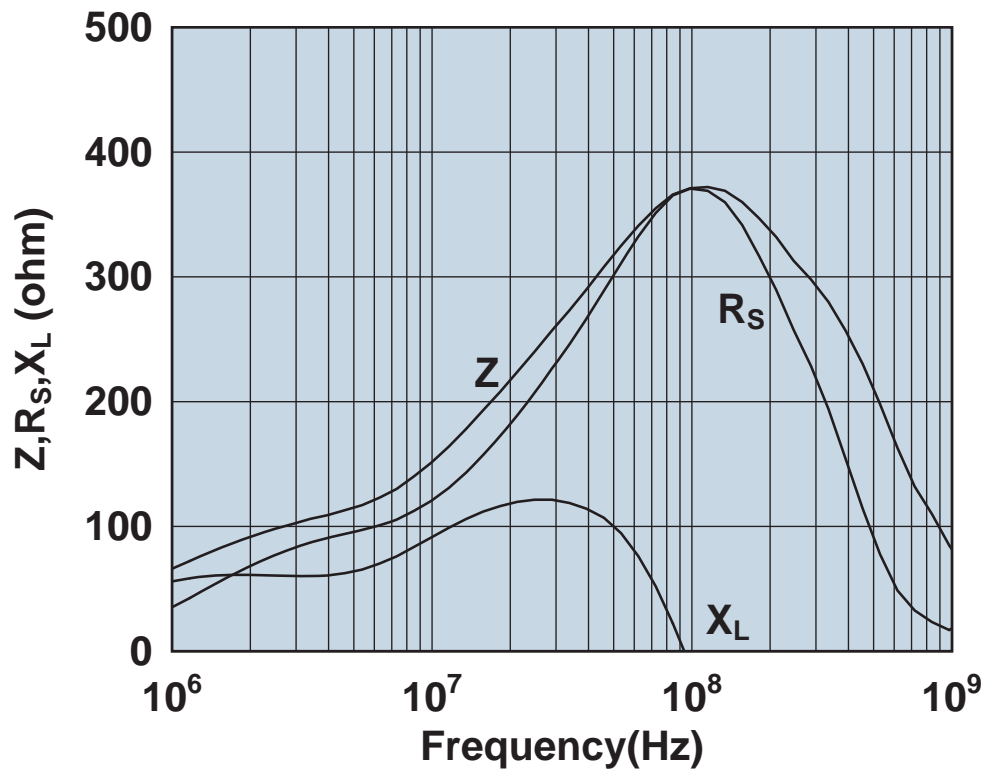

Impedance, reactance, and resistance vs. frequency.

0431178181

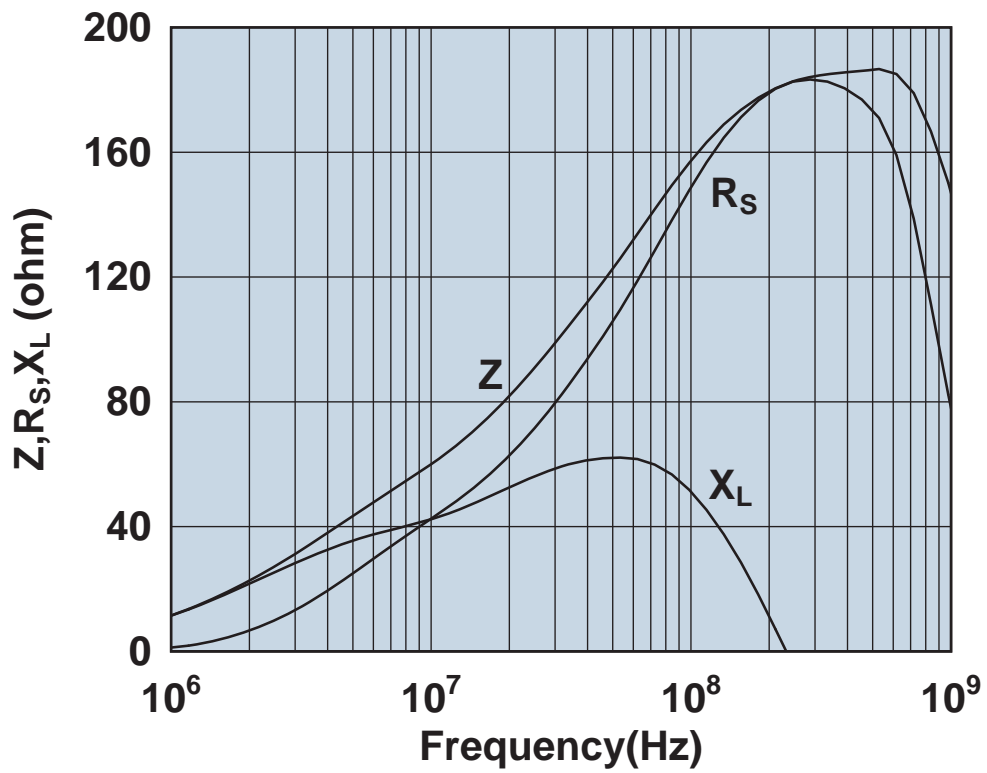

Impedance, reactance, and resistance vs. frequency.

0431178281

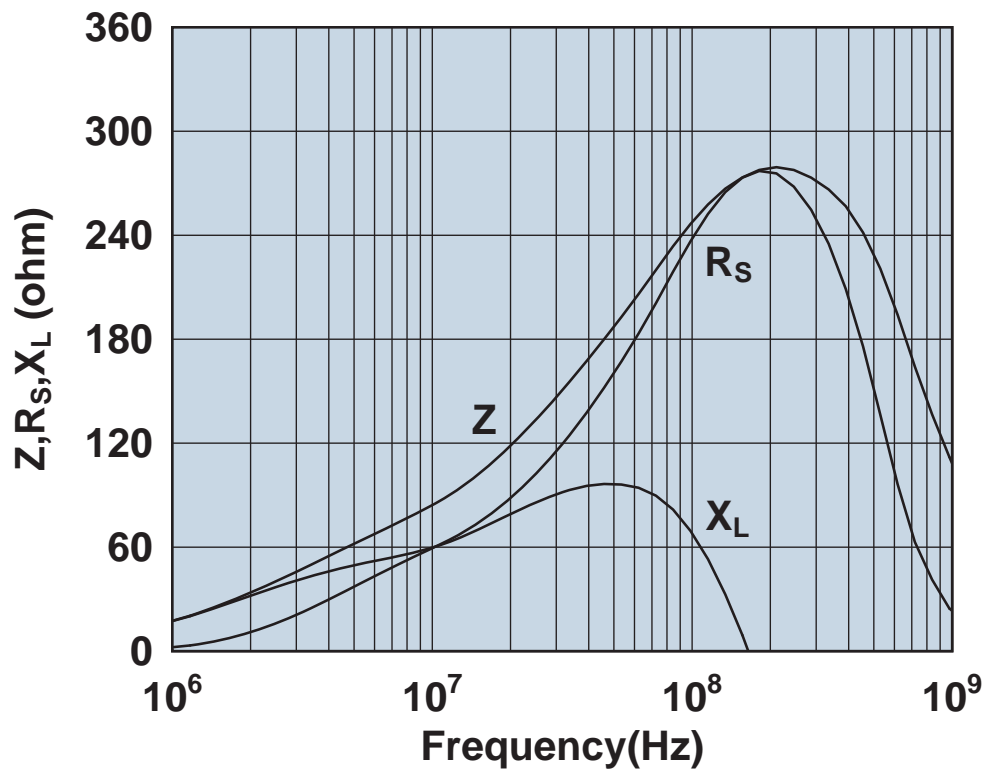

Impedance, reactance, and resistance vs. frequency.

0443163951

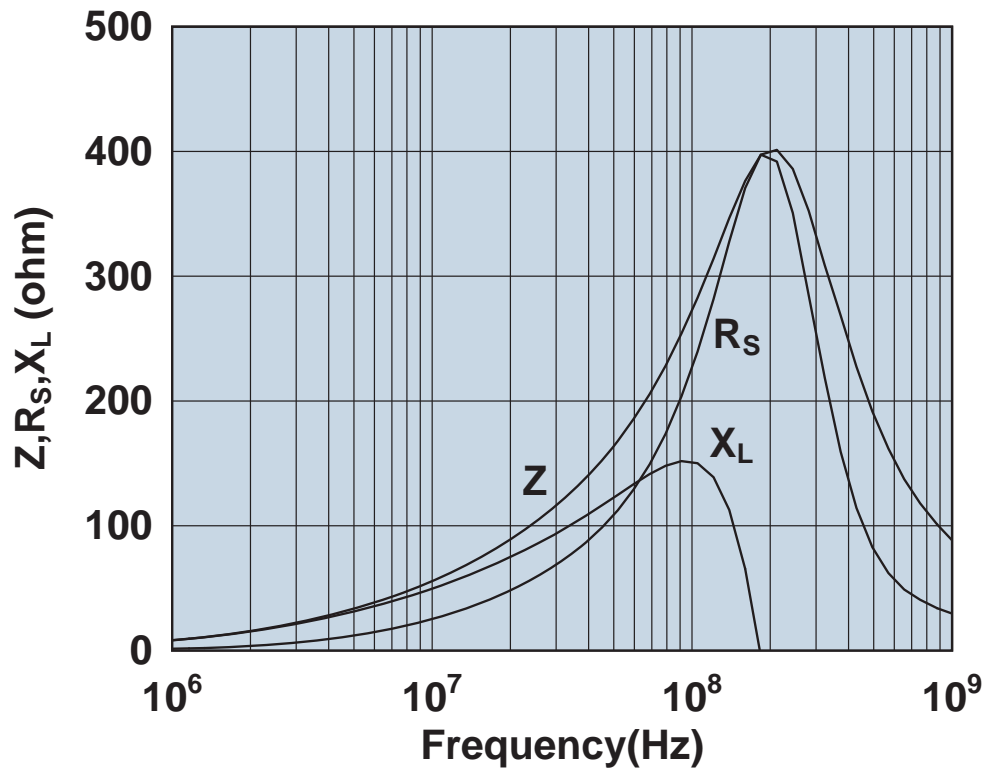

Impedance, reactance, and resistance vs. frequency.

0443164051

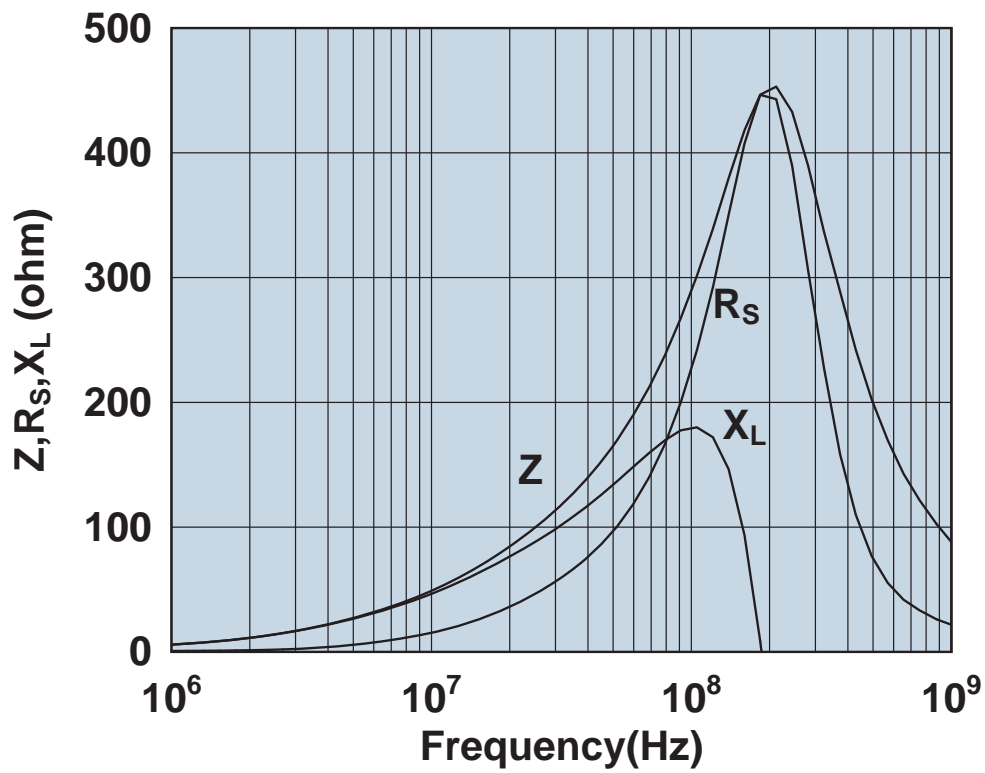

Impedance, reactance, and resistance vs. frequency.

0443164151

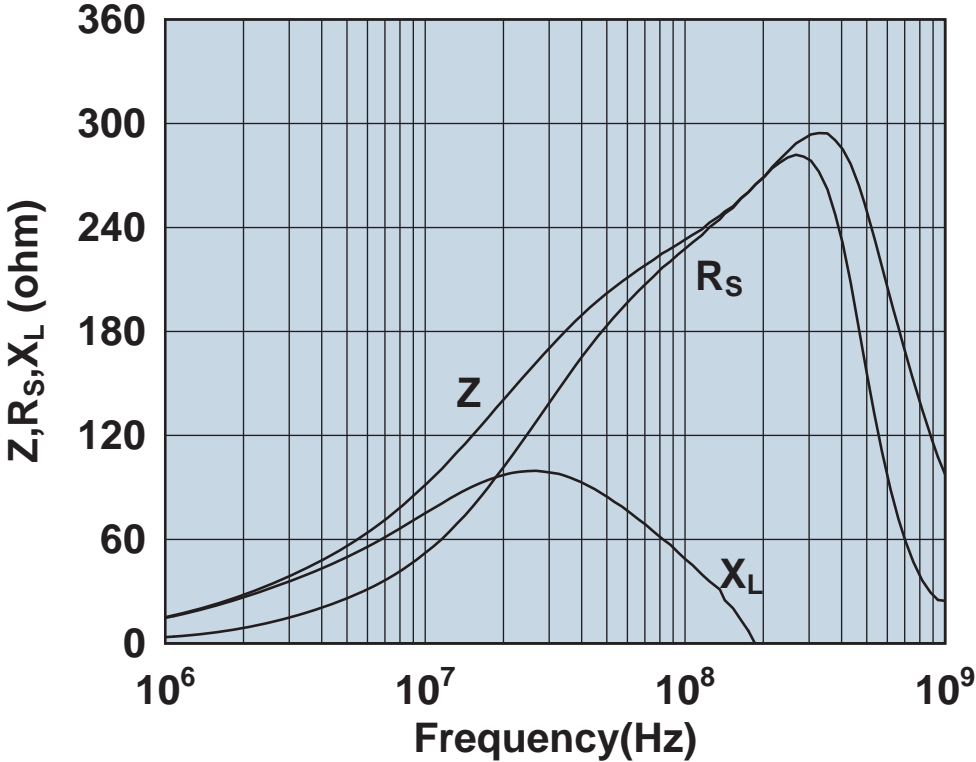

Impedance, reactance, and resistance vs. frequency.

0443164251

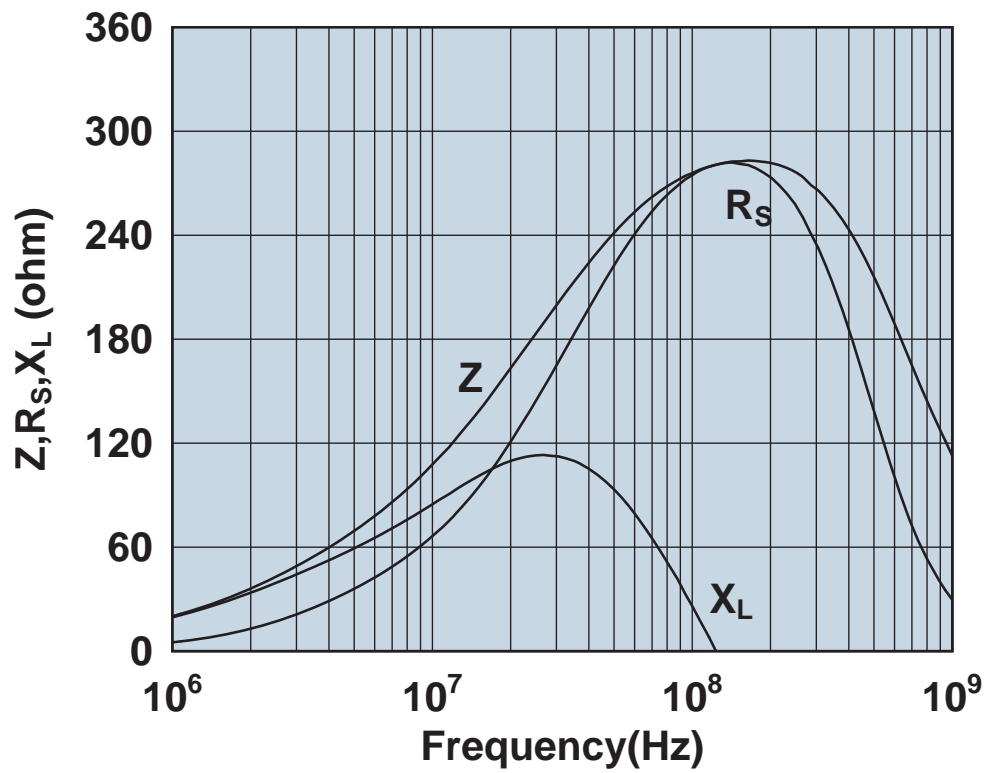

Impedance, reactance, and resistance vs. frequency.

0443166651

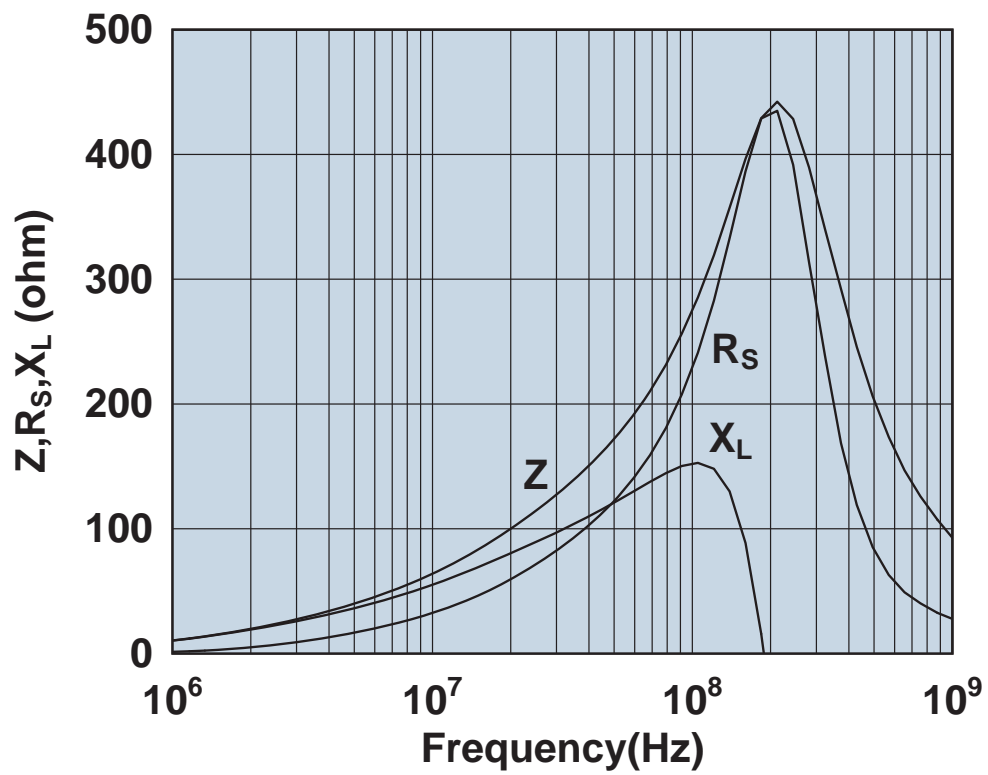

Impedance, reactance, and resistance vs. frequency.

0443167251

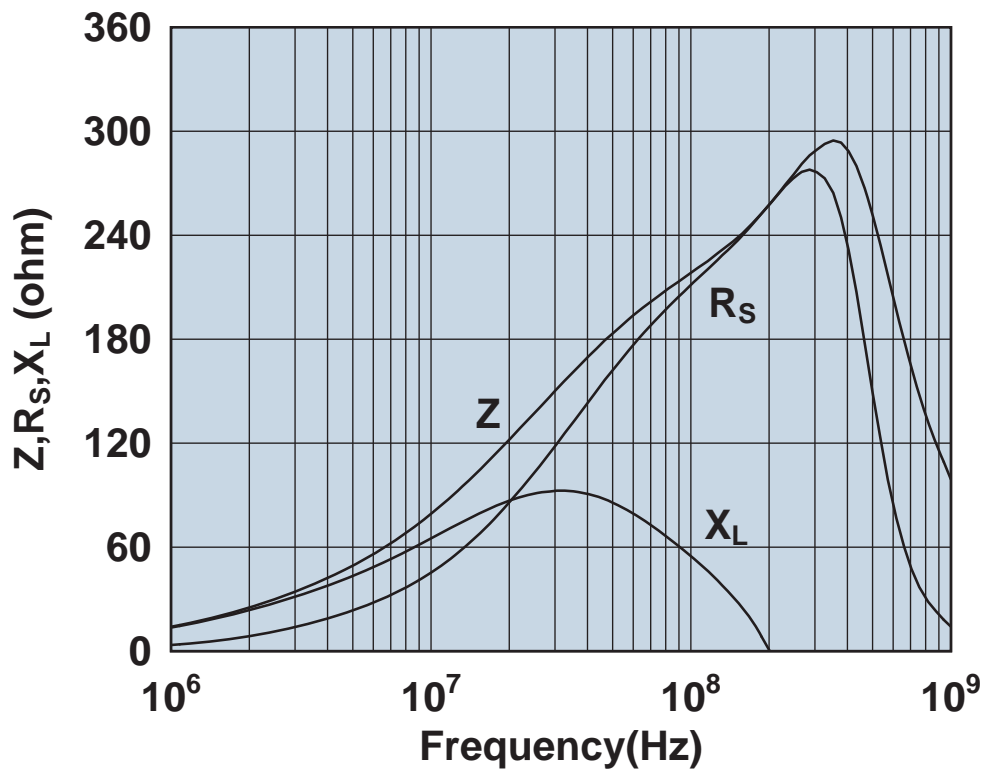

Impedance, reactance, and resistance vs. frequency.

0443178181

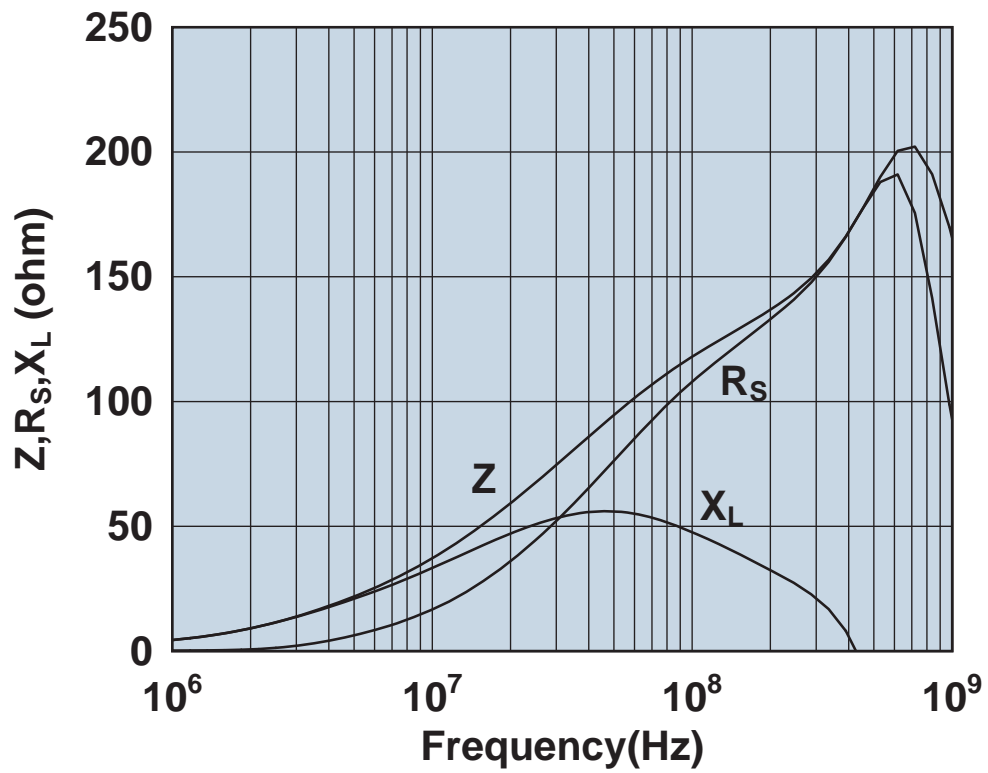

Impedance, reactance, and resistance vs. frequency.

0443178281

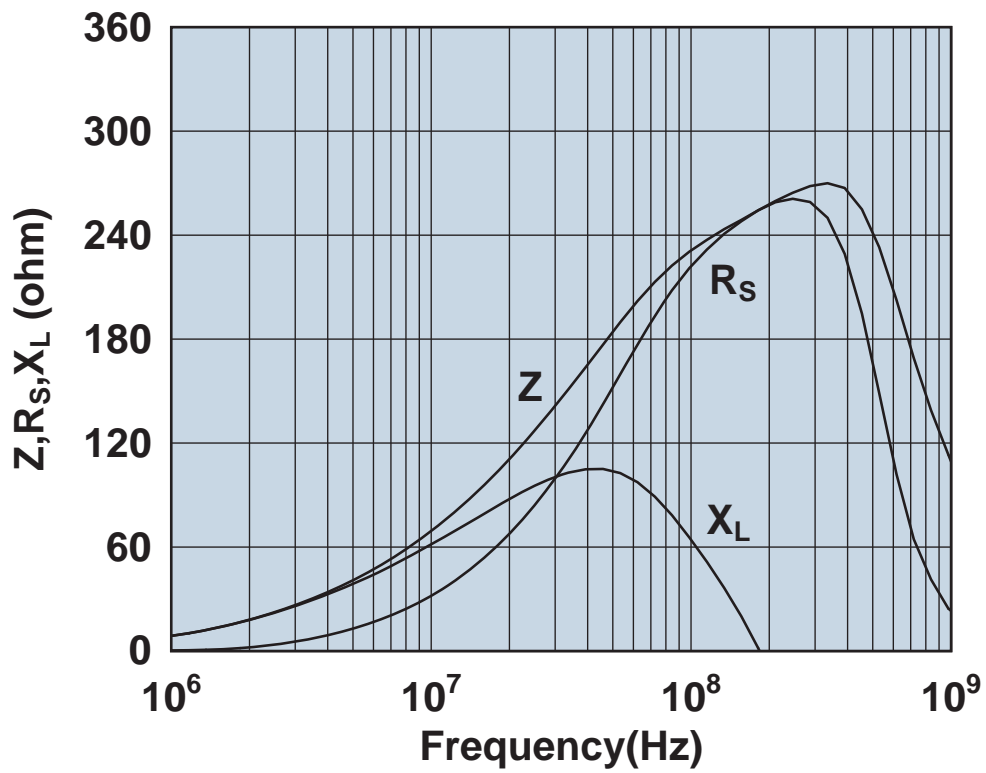

Impedance, reactance, and resistance vs. frequency.

0443625006

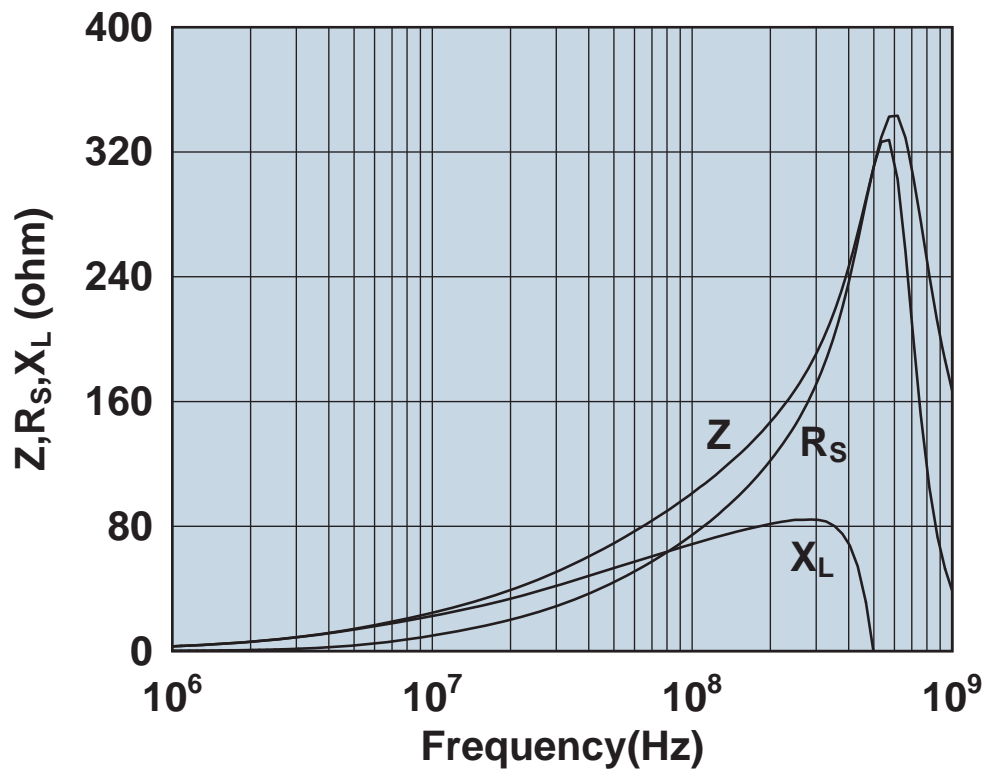

Impedance, reactance, and resistance vs. frequency.

0443665806

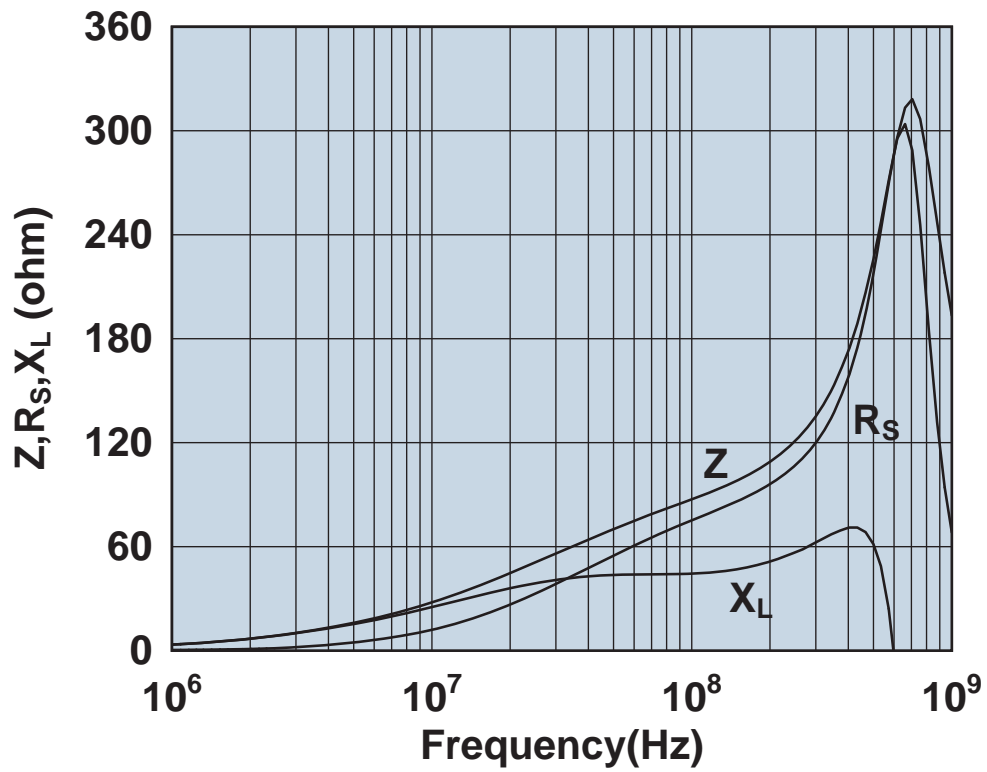

Impedance, reactance, and resistance vs. frequency.

0443800506

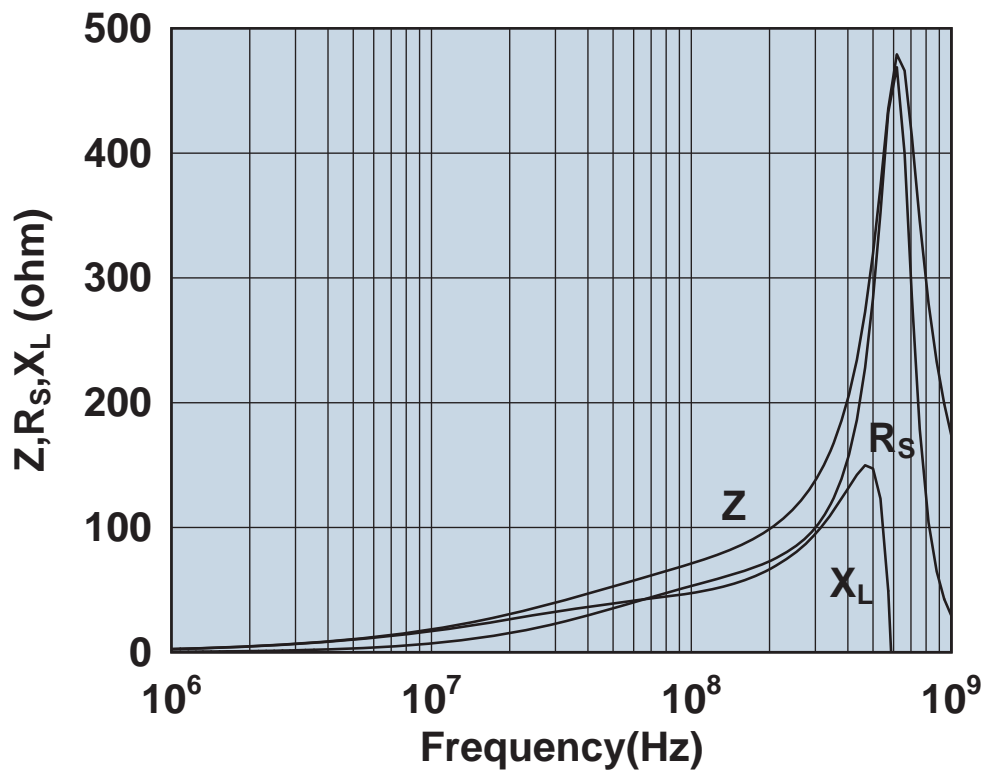

Impedance, reactance, and resistance vs. frequency.

0443806406

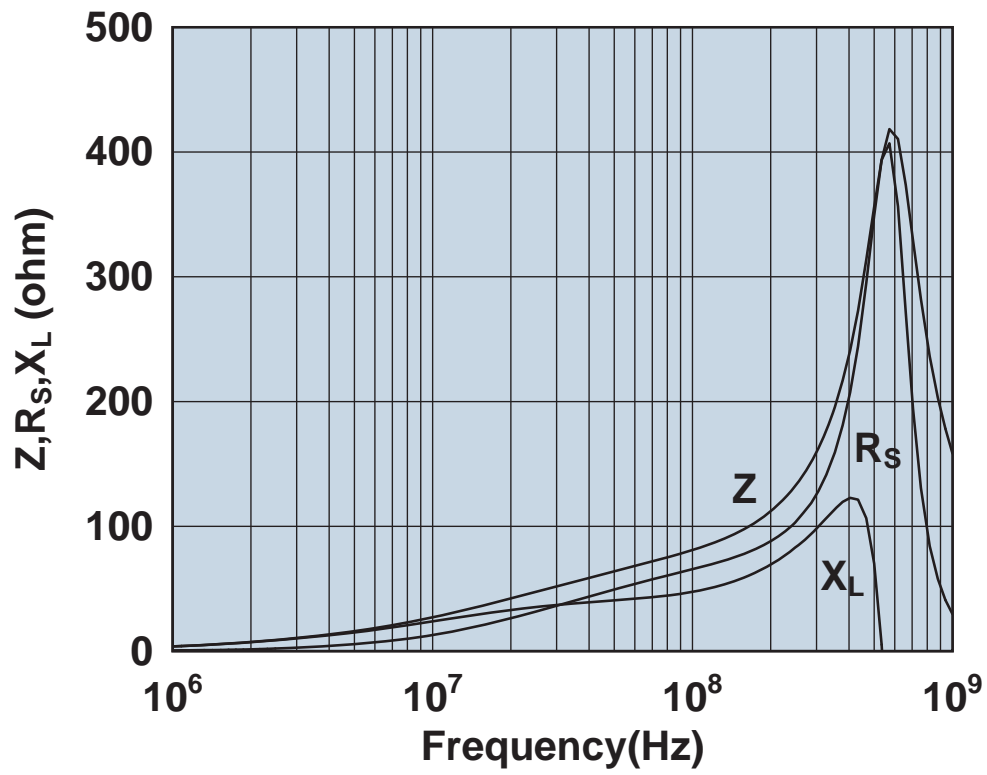

Impedance, reactance, and resistance vs. frequency.

0444164181

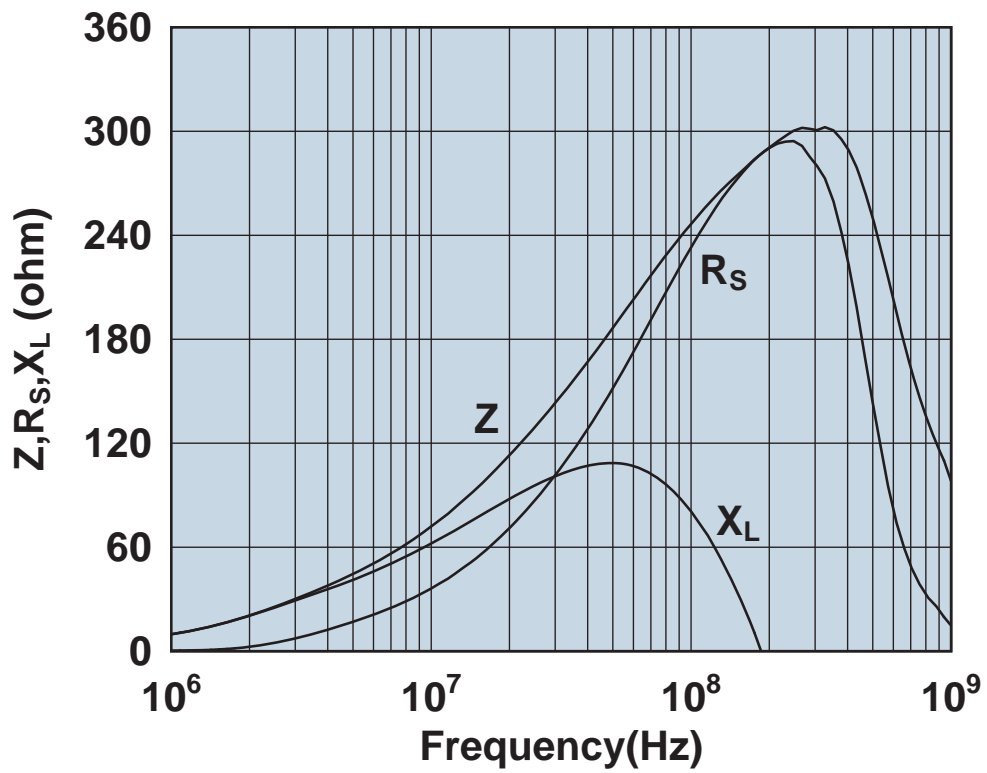

Impedance, reactance, and resistance vs. frequency.

0444164281

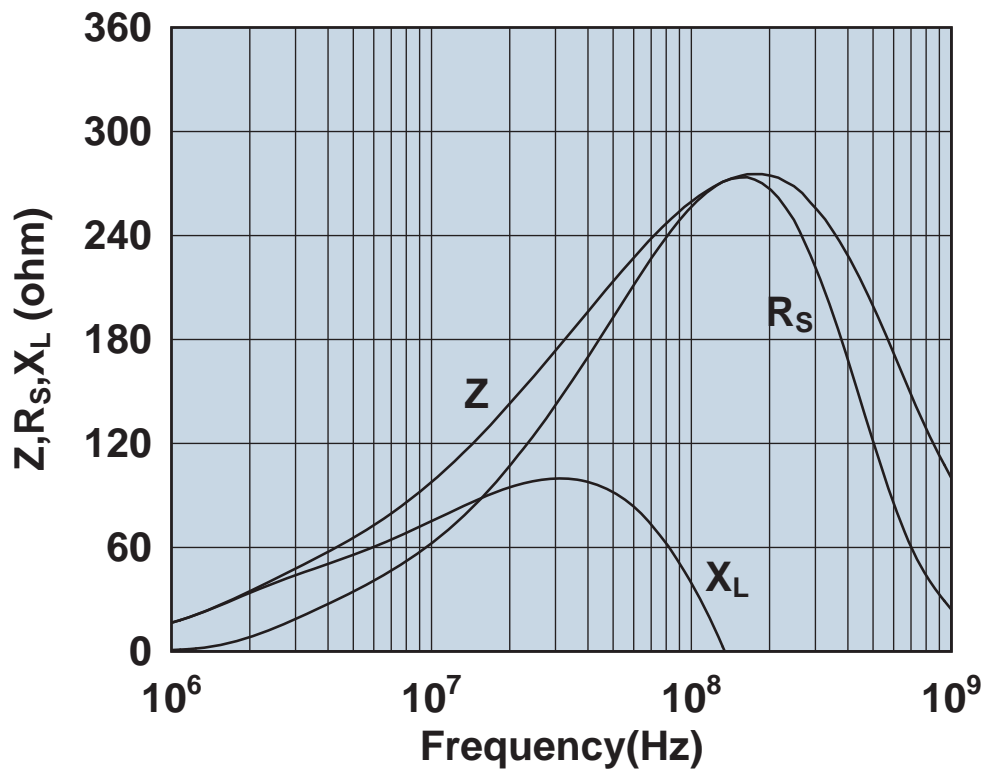

Impedance, reactance, and resistance vs. frequency.

0444164951

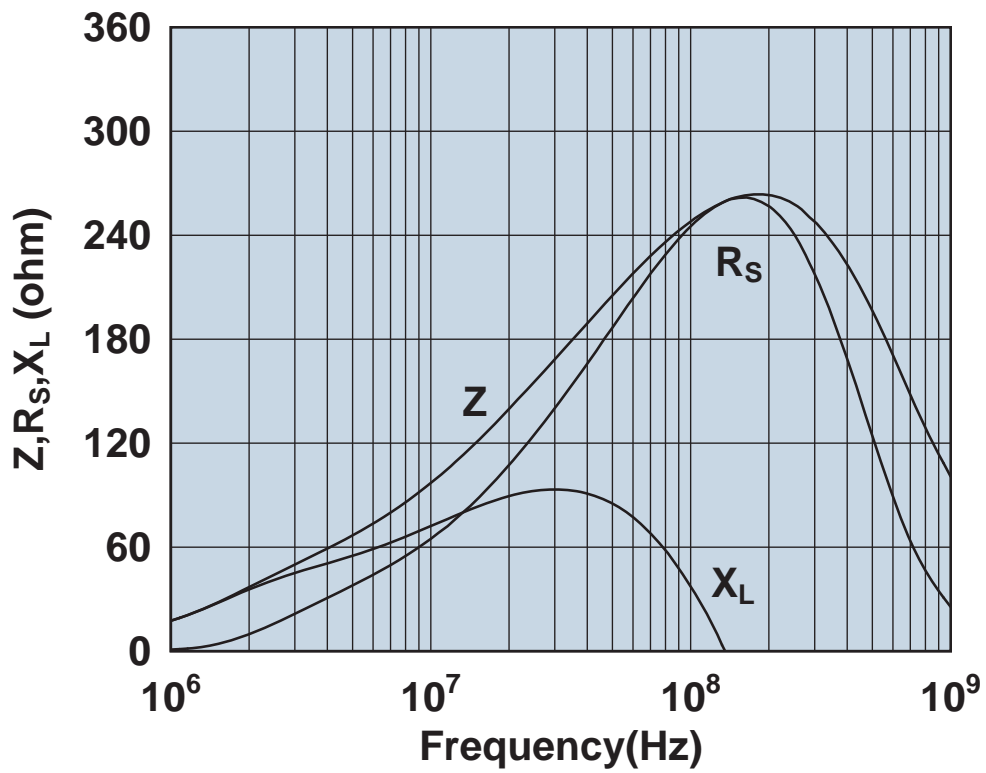

Impedance, reactance, and resistance vs. frequency.

0444167281

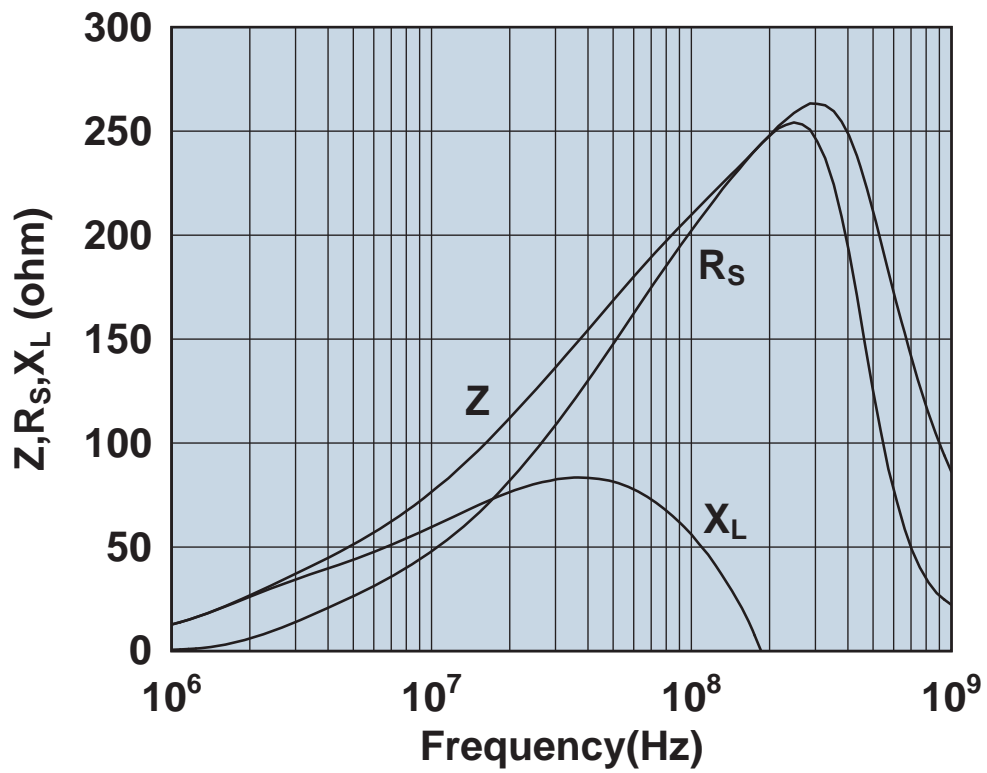

Impedance, reactance, and resistance vs. frequency.

0444173551

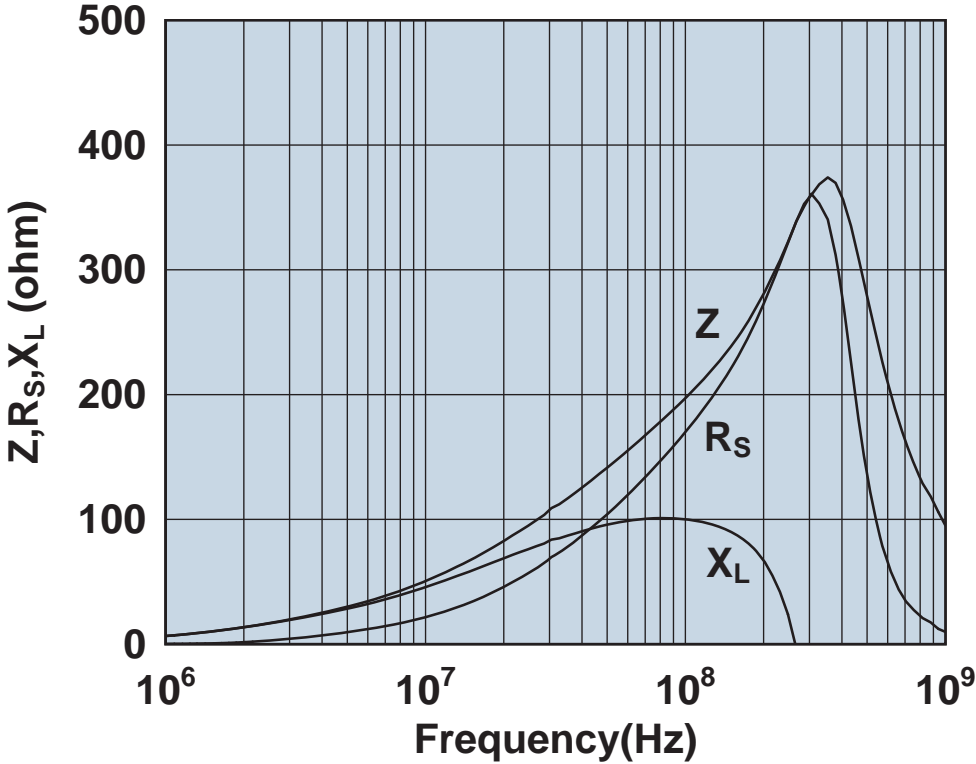

Impedance, reactance, and resistance vs. frequency.

0444173951

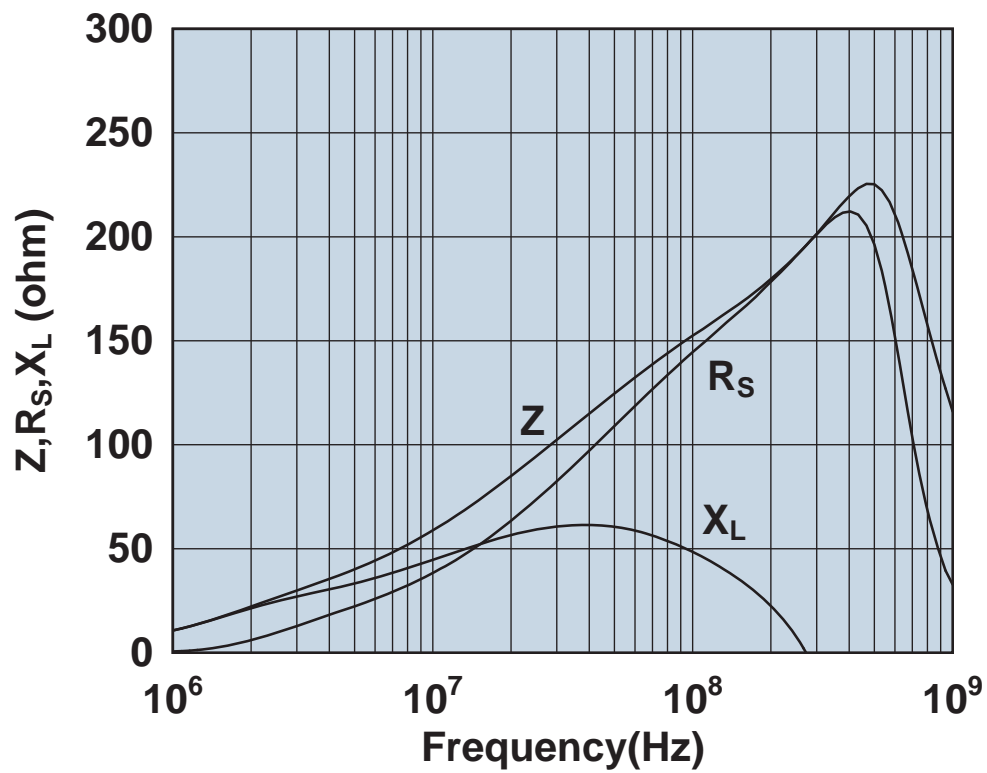

Impedance, reactance, and resistance vs. frequency.

0444176451

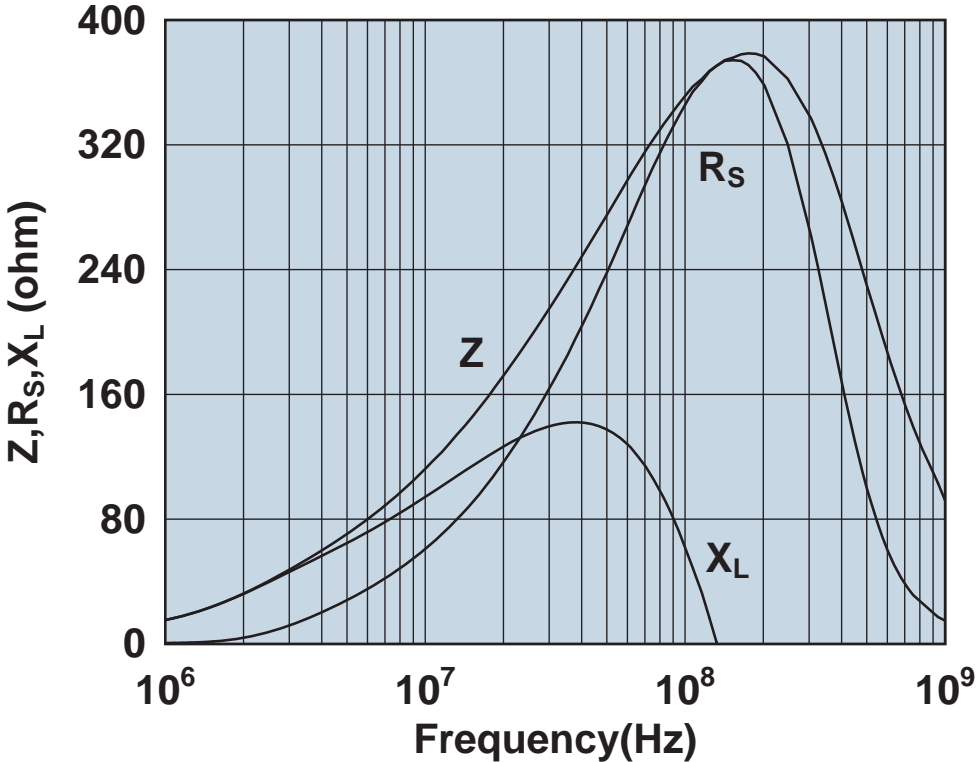

Impedance, reactance, and resistance vs. frequency.

0444177081

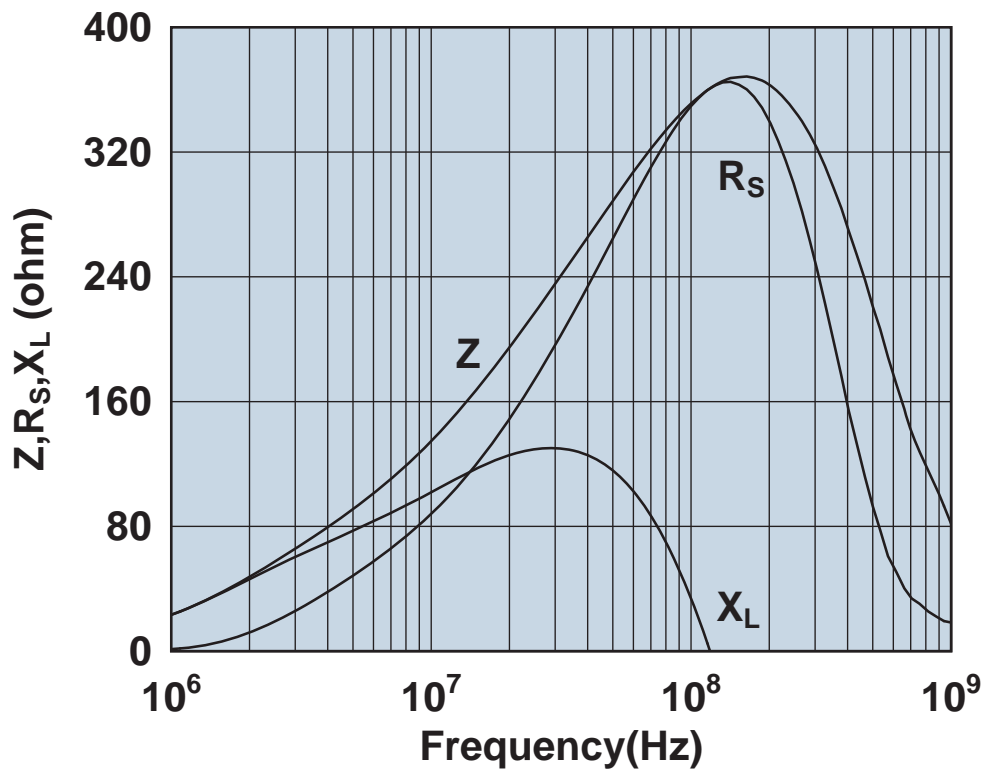

Impedance, reactance, and resistance vs. frequency.

0446164151

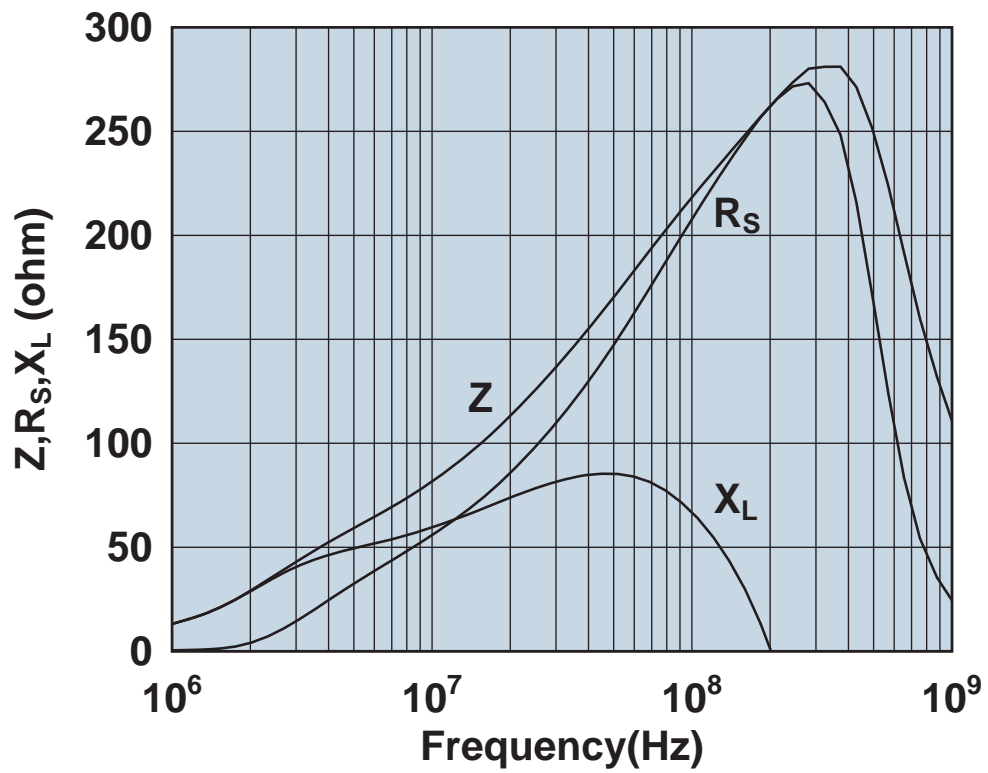

Impedance, reactance, and resistance vs. frequency.

0446164181

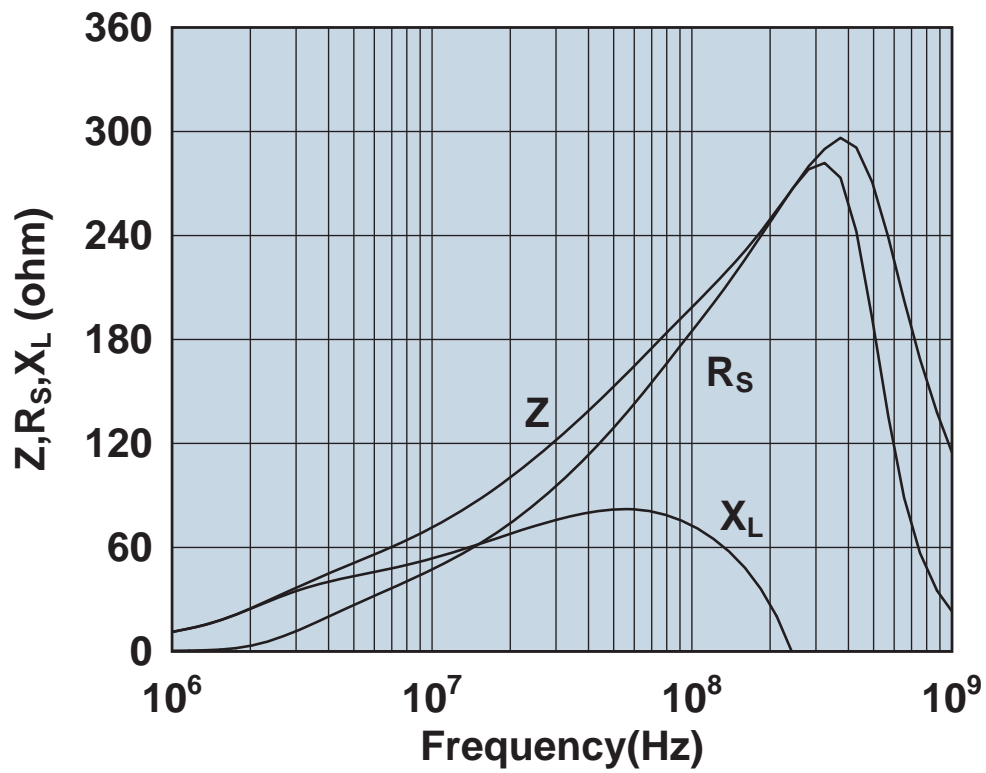

Impedance, reactance, and resistance vs. frequency.

0446164251

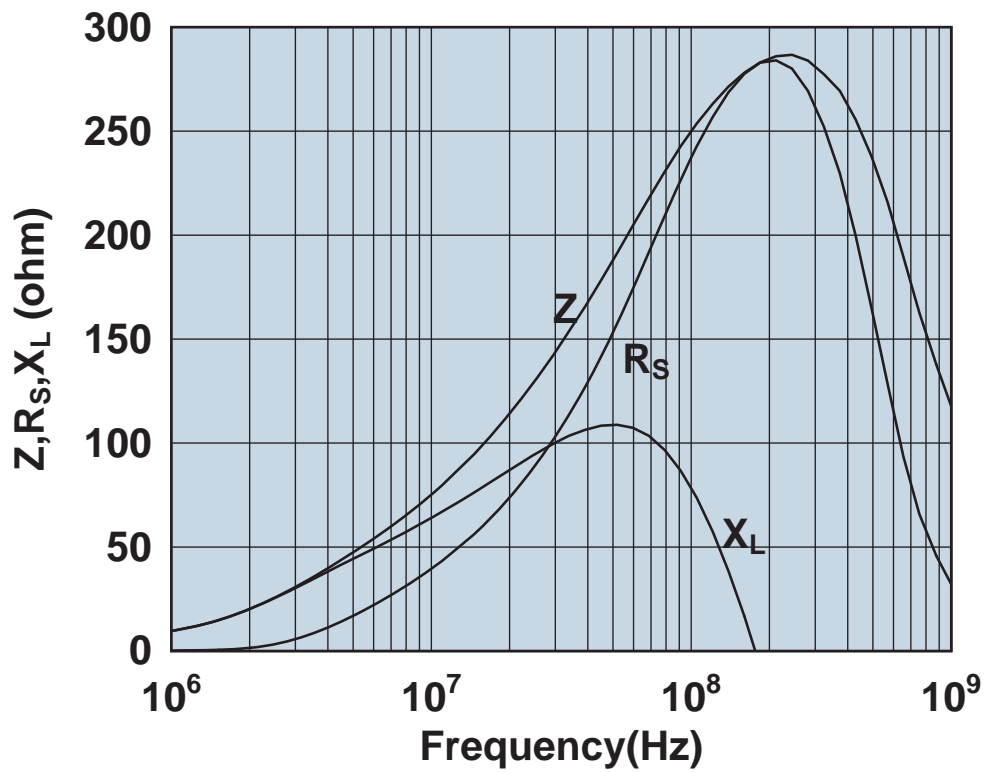

Impedance, reactance, and resistance vs. frequency.

0446164281

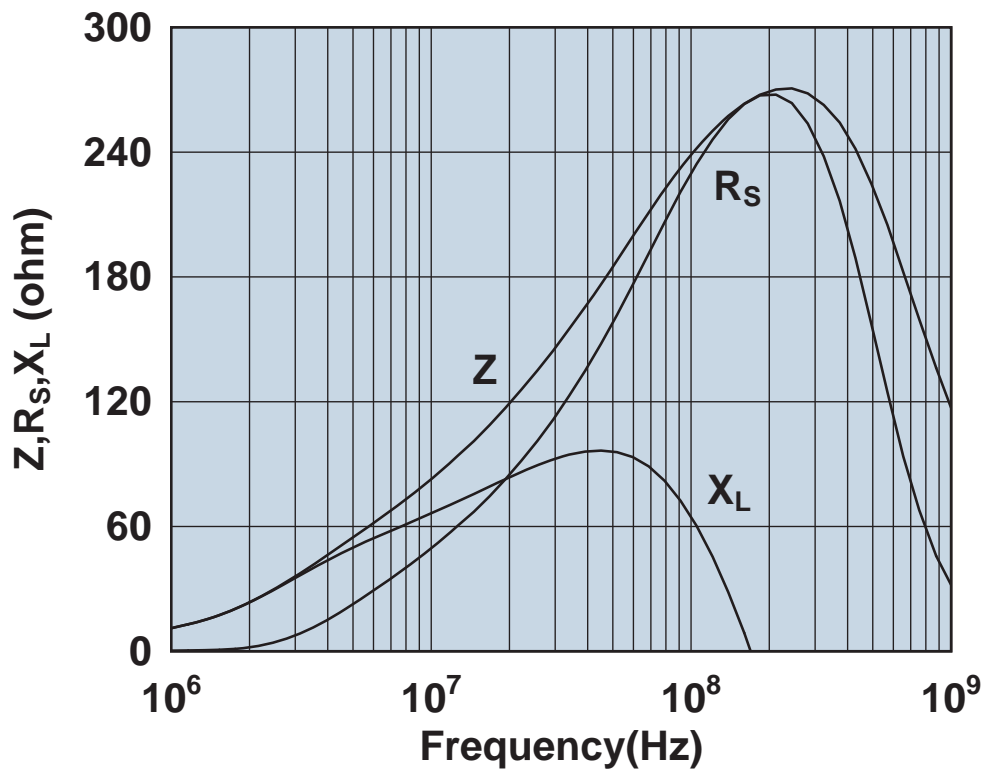

Impedance, reactance, and resistance vs. frequency.

0446164951

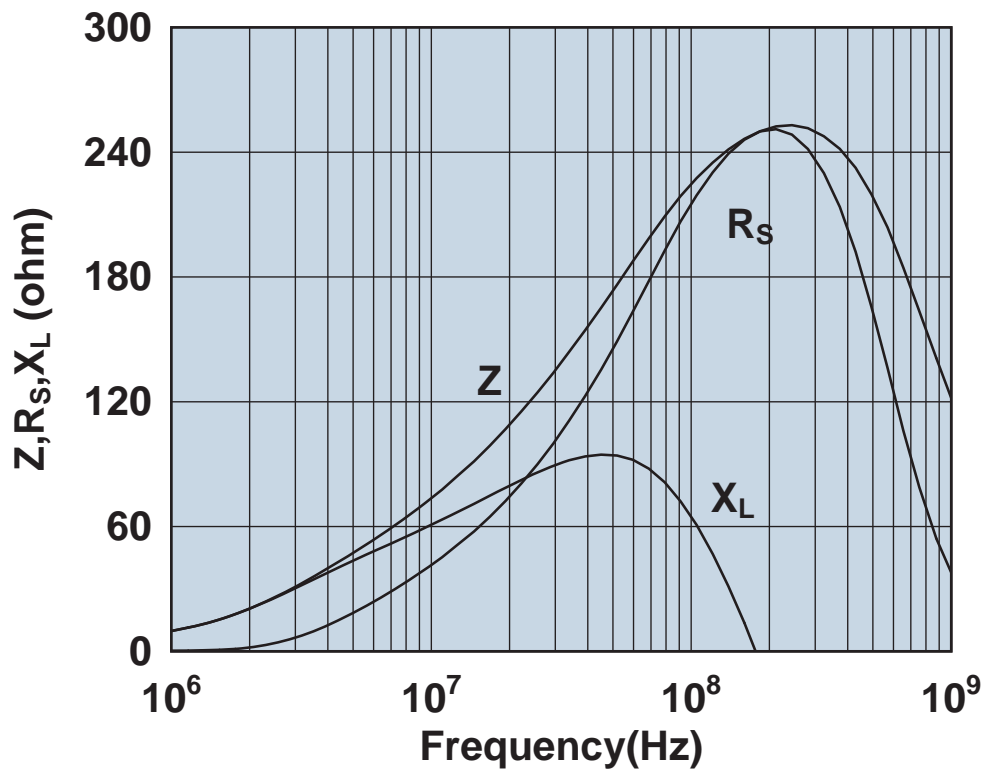

Impedance, reactance, and resistance vs. frequency.

0446167251

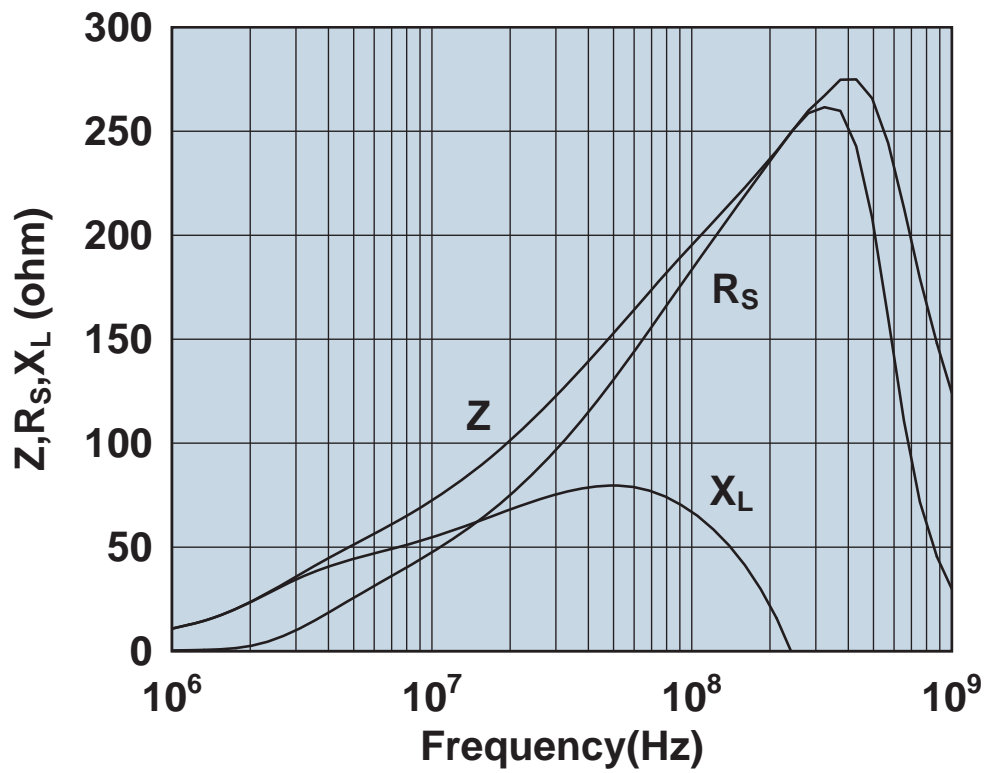

Impedance, reactance, and resistance vs. frequency.

0446167281

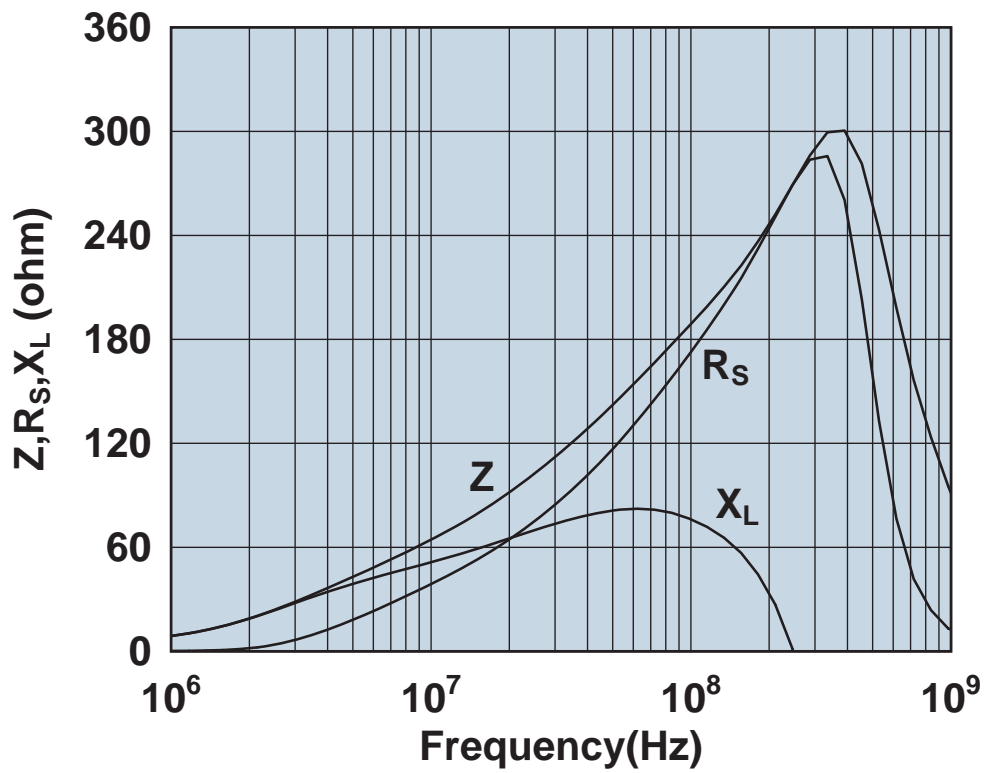

Impedance, reactance, and resistance vs. frequency.

0446173551

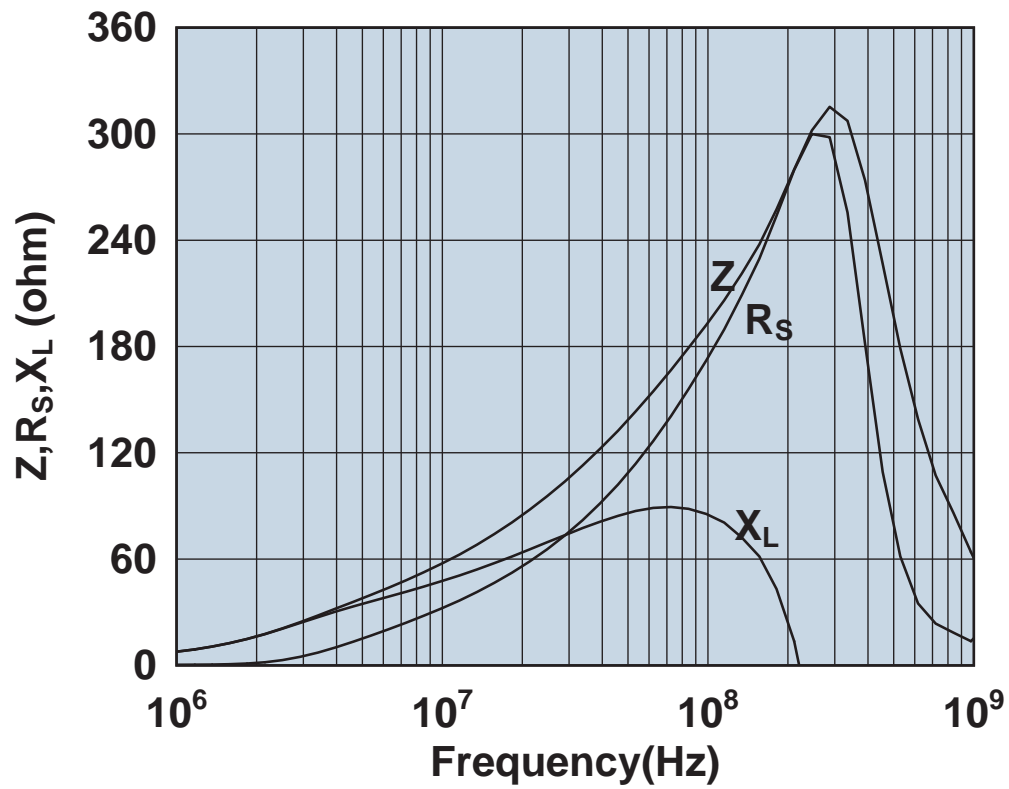

Impedance, reactance, and resistance vs. frequency.

0446173951

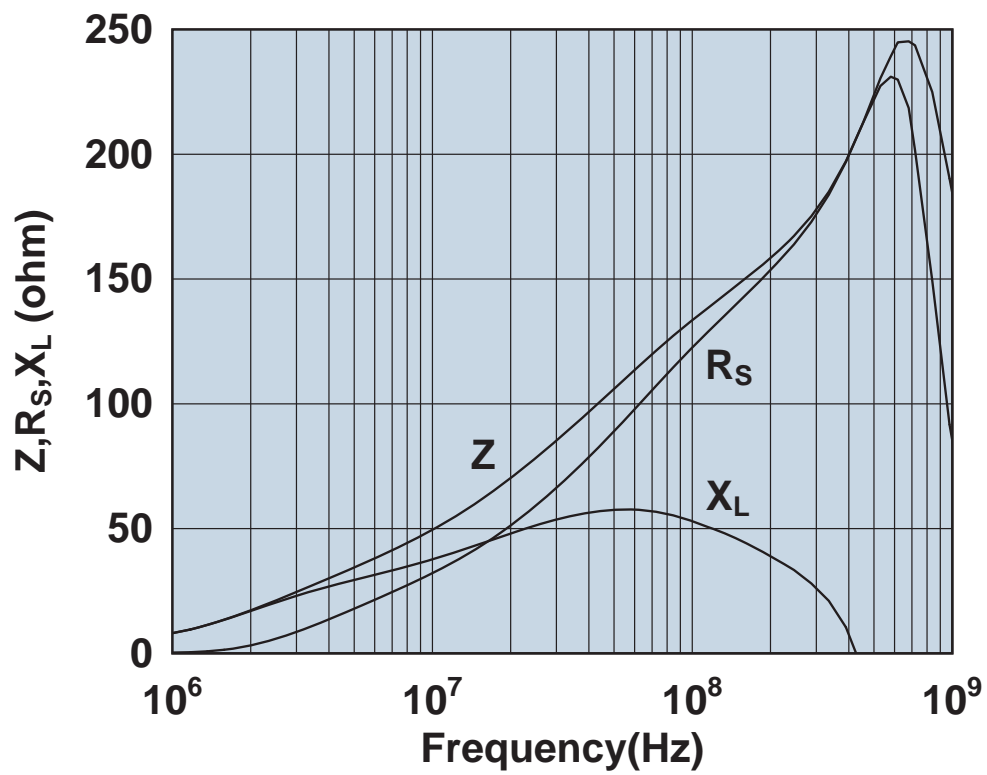

Impedance, reactance, and resistance vs. frequency.

0446176451

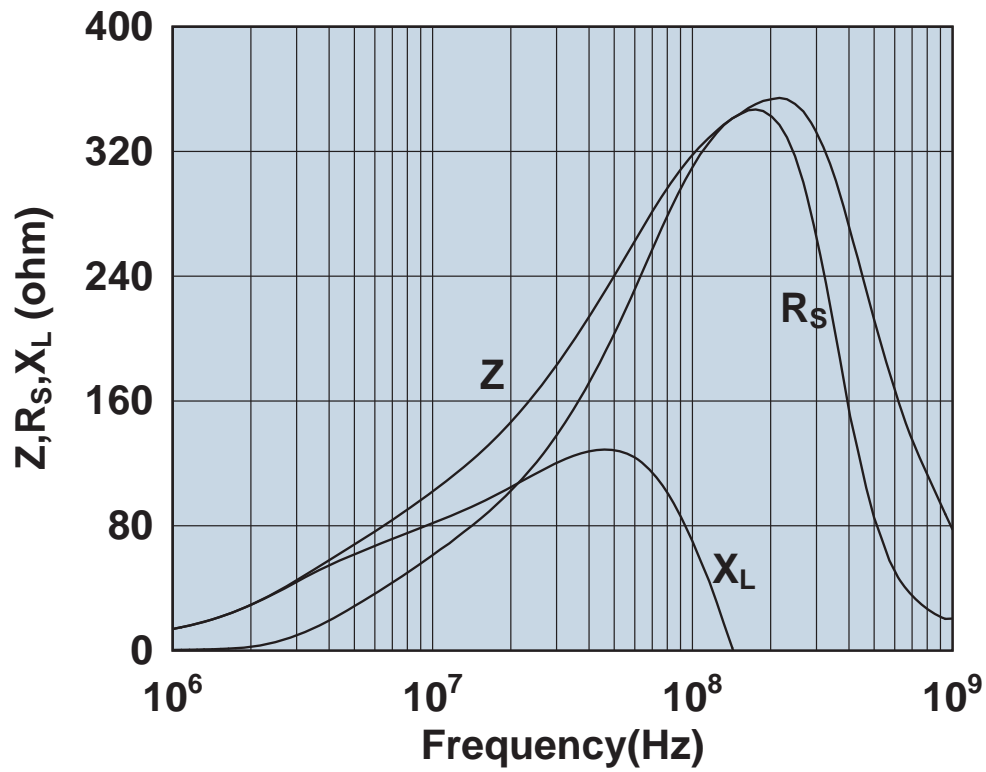

Impedance, reactance, and resistance vs. frequency.

0446177081

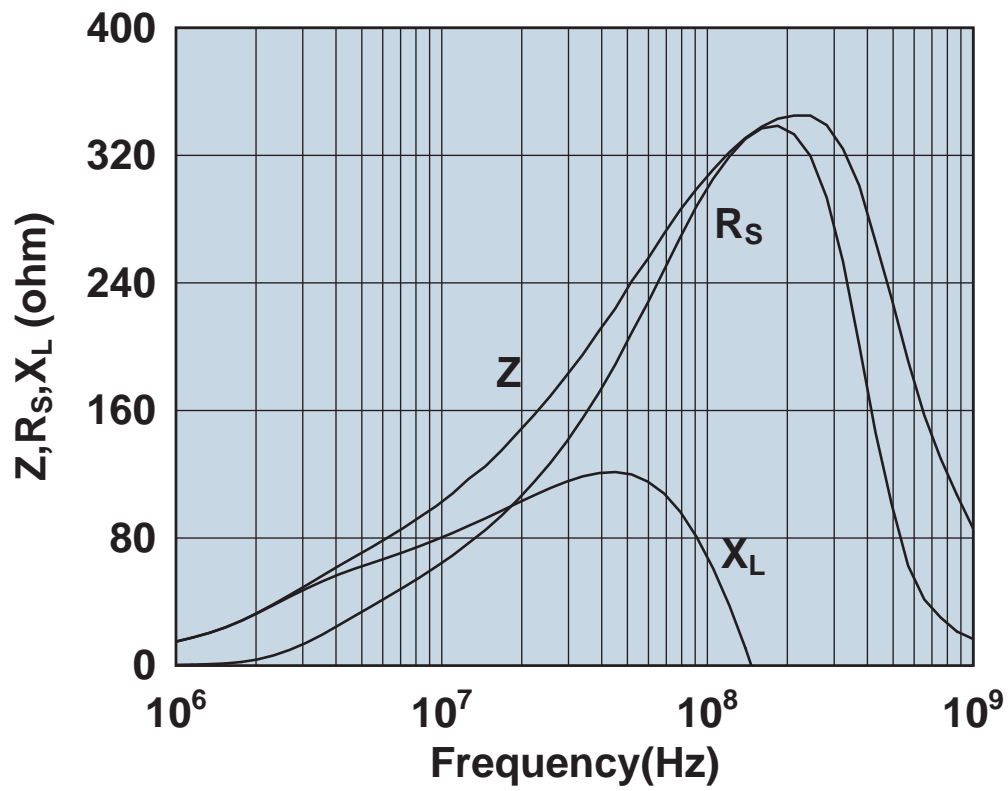

Impedance, reactance, and resistance vs. frequency.

0461164181

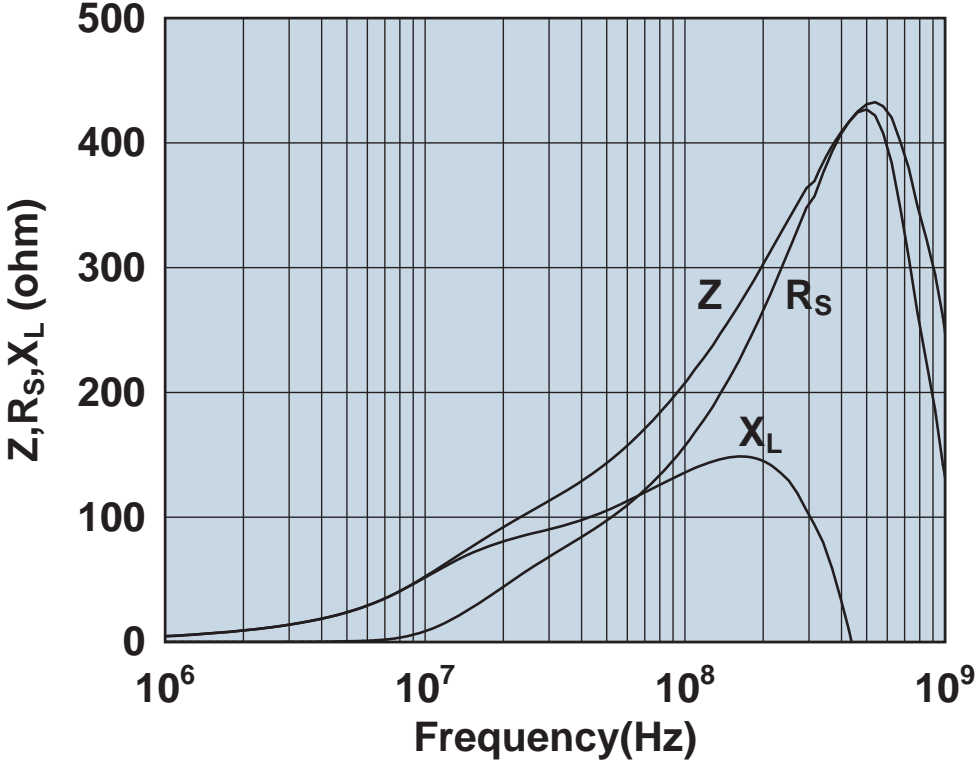

Impedance, reactance, and resistance vs. frequency.

0461164281

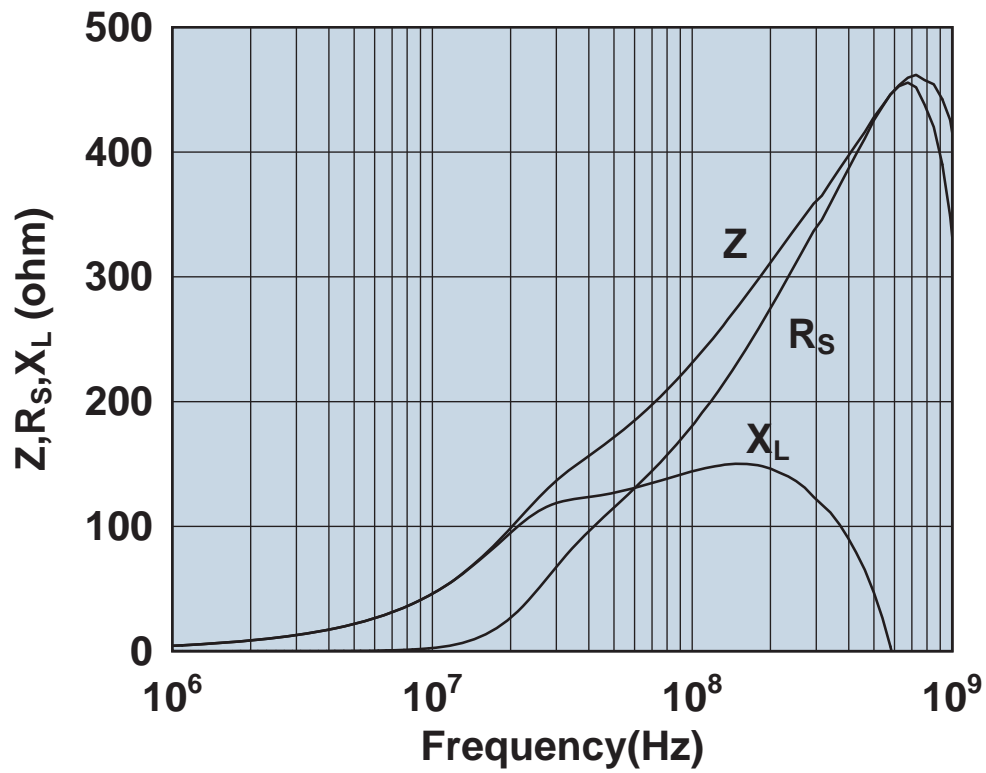

Impedance, reactance, and resistance vs. frequency.

0461164951

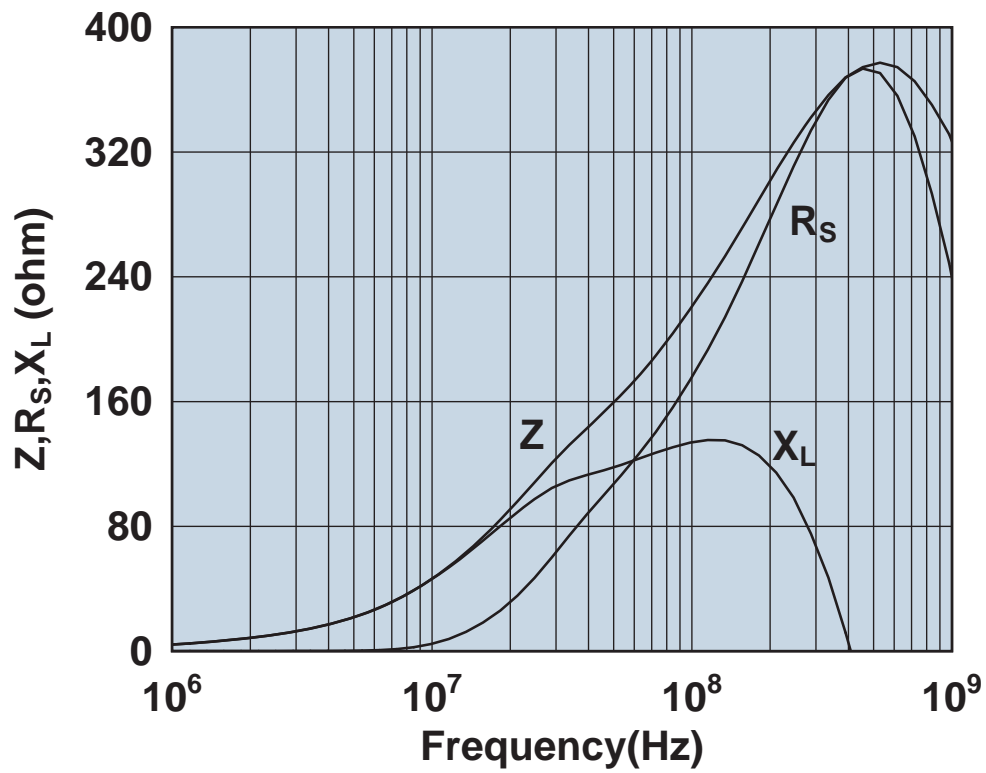

Impedance, reactance, and resistance vs. frequency.

0461167281

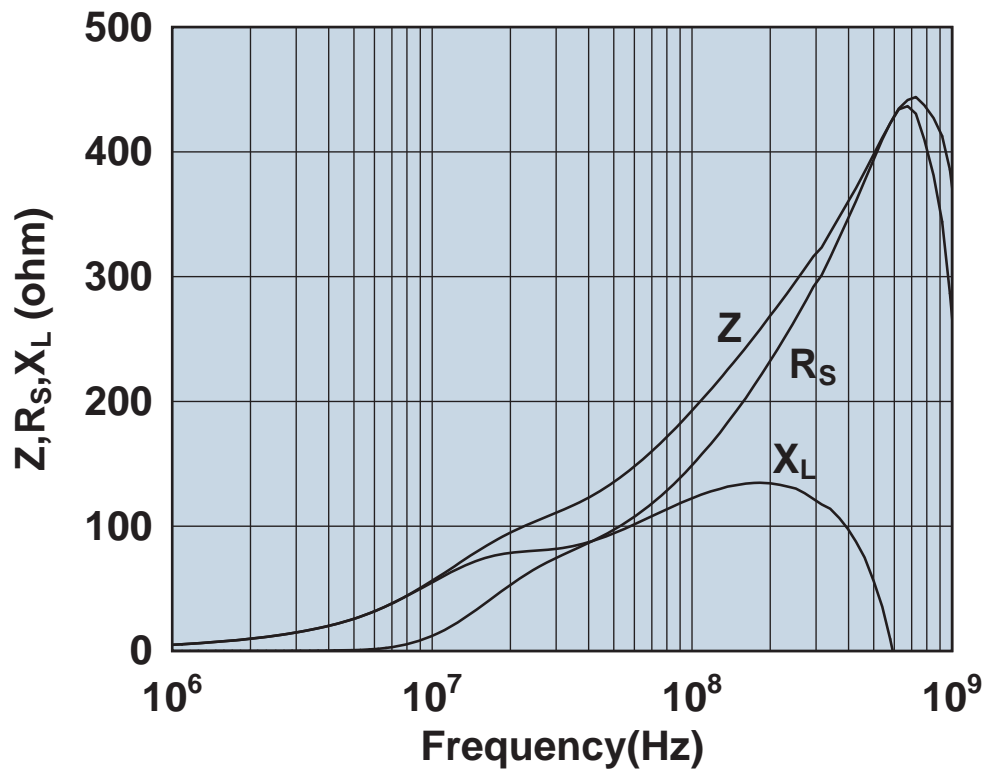

Impedance, reactance, and resistance vs. frequency.

0461176451

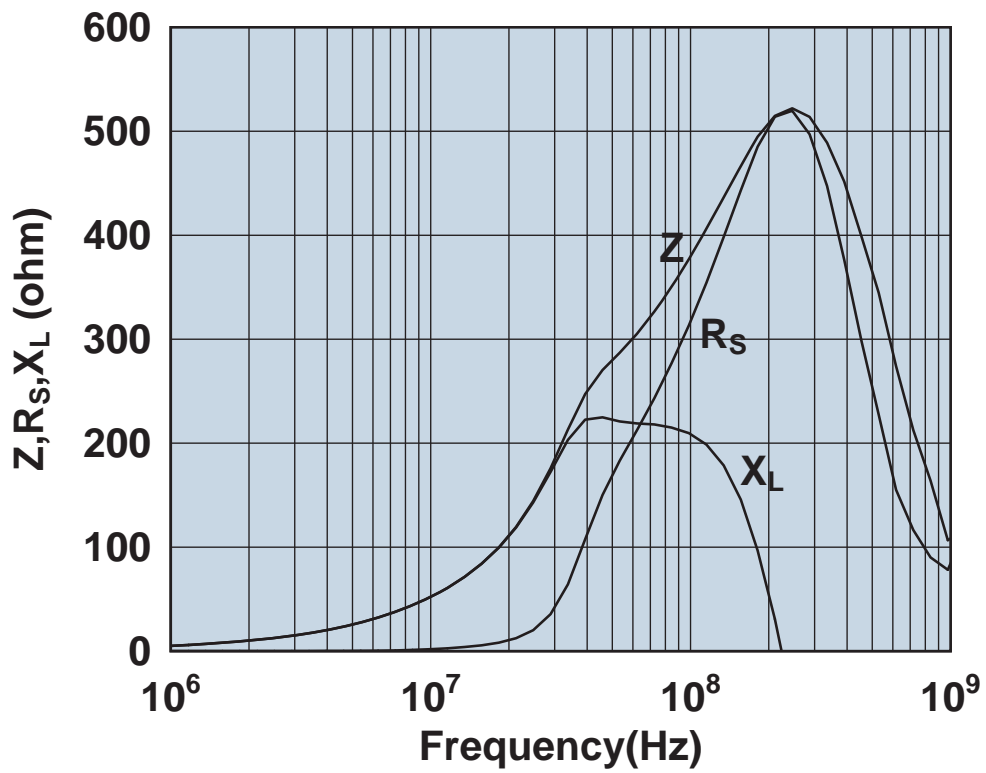

Impedance, reactance, and resistance vs. frequency.

0461178181

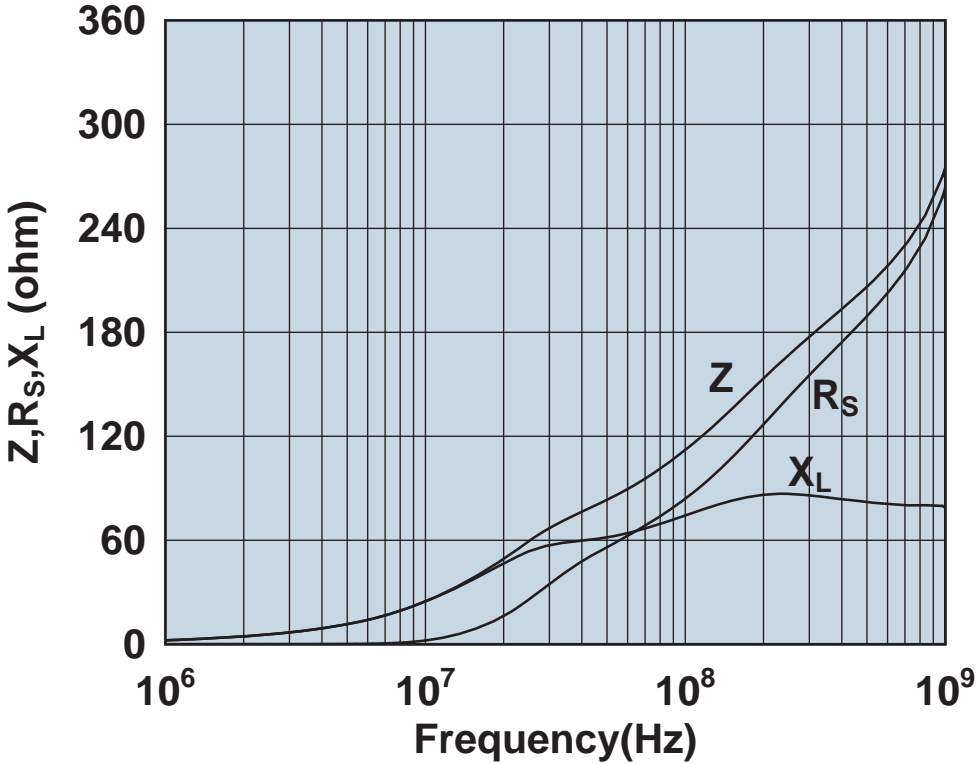

Impedance, reactance, and resistance vs. frequency.

0461178281

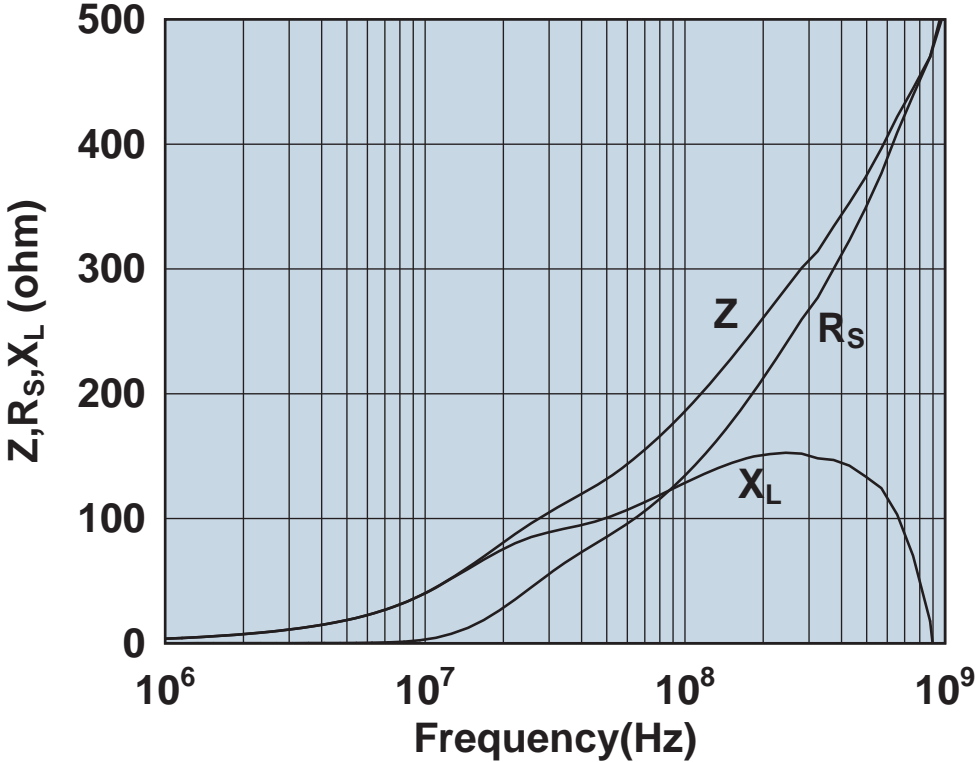

Impedance, reactance, and resistance vs. frequency.

2504021007Y0

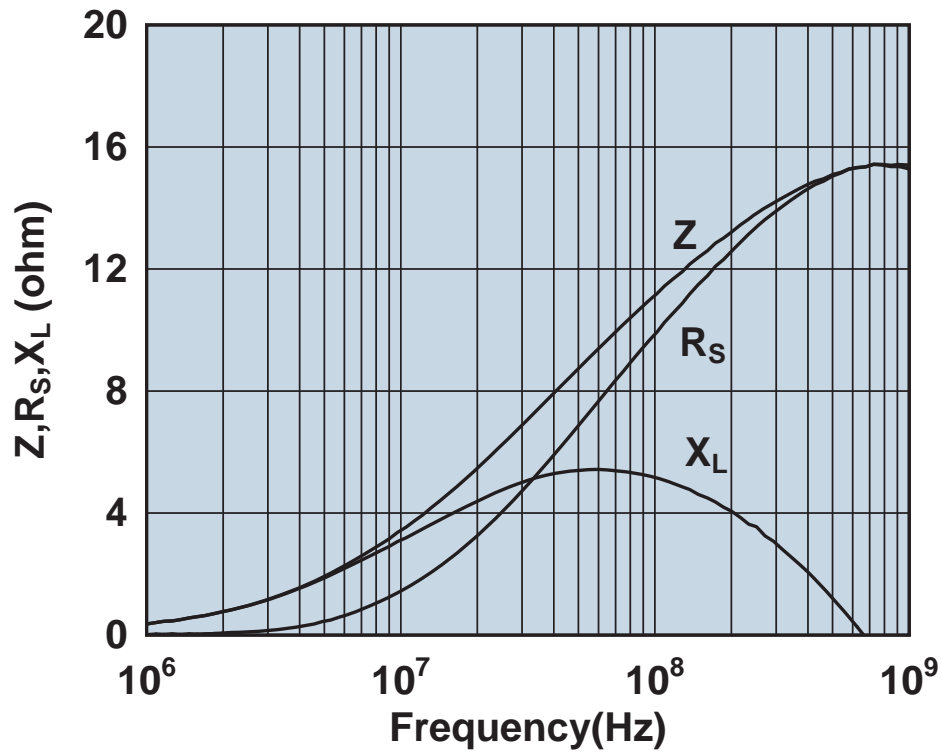

Impedance, reactance, and resistance vs. frequency.

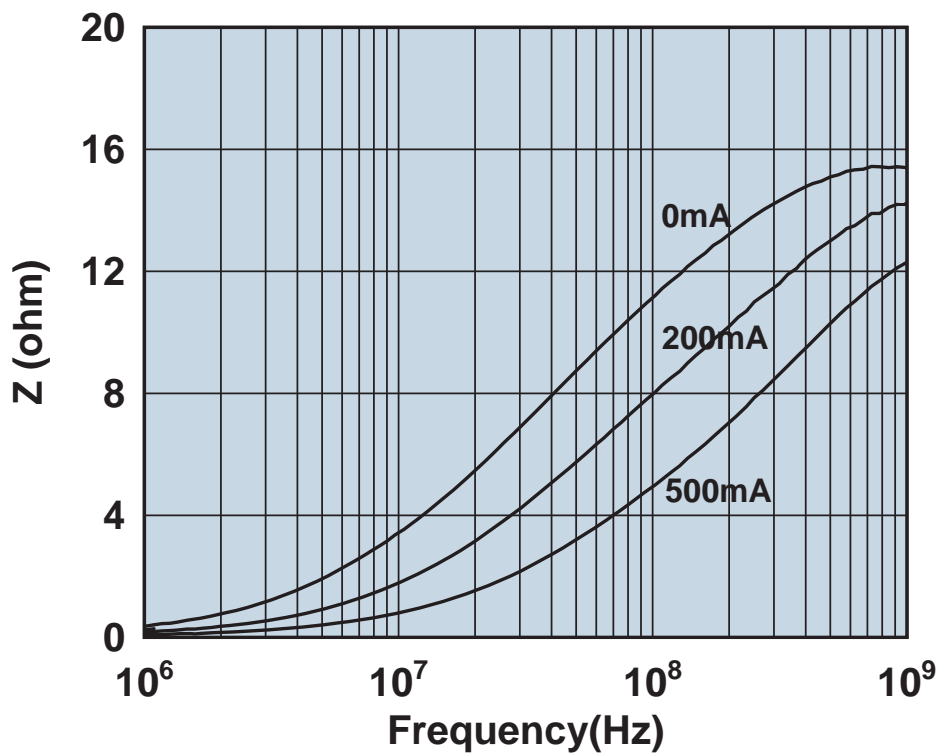

Impedance vs. frequency with dc bias.

2504021217Y0

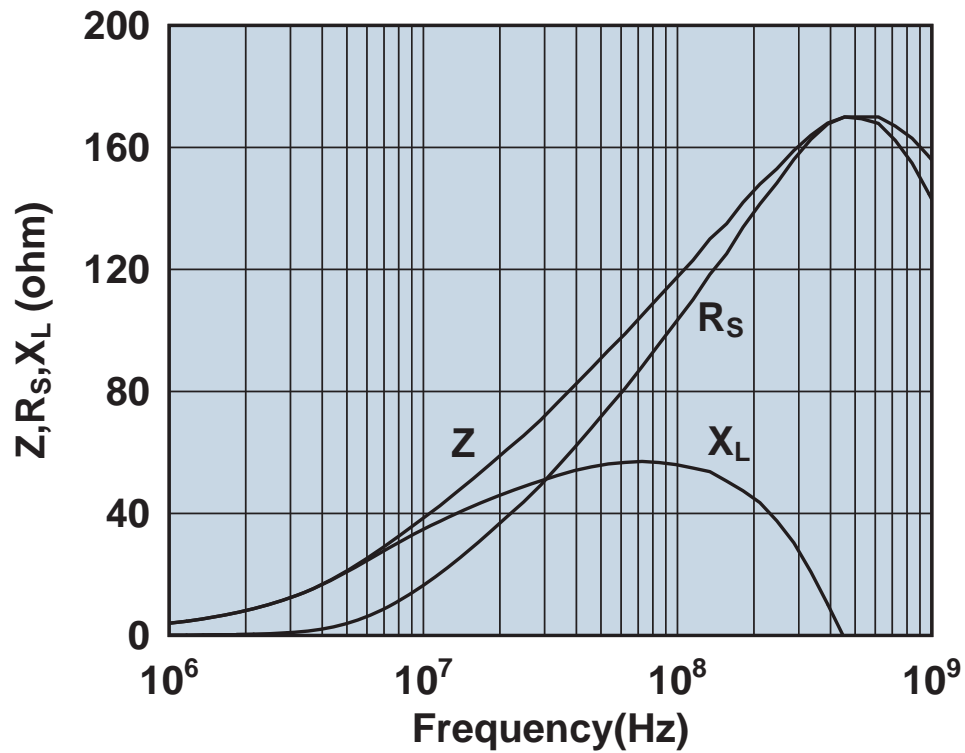

Impedance, reactance, and resistance vs. frequency.

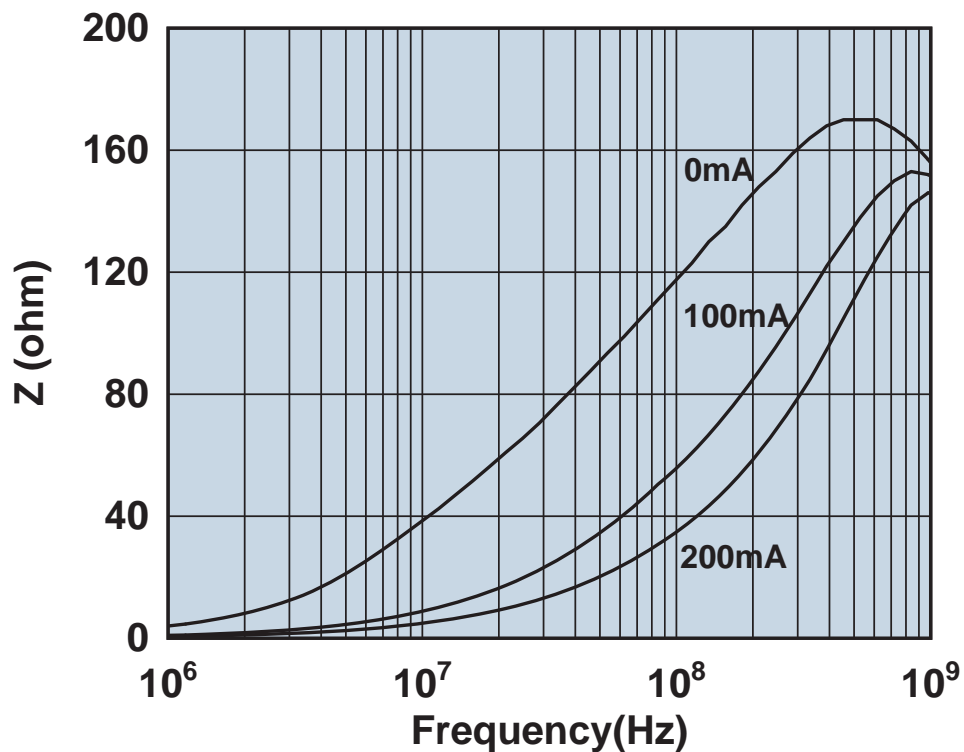

Impedance vs. frequency with dc bias.

2504023017Y0

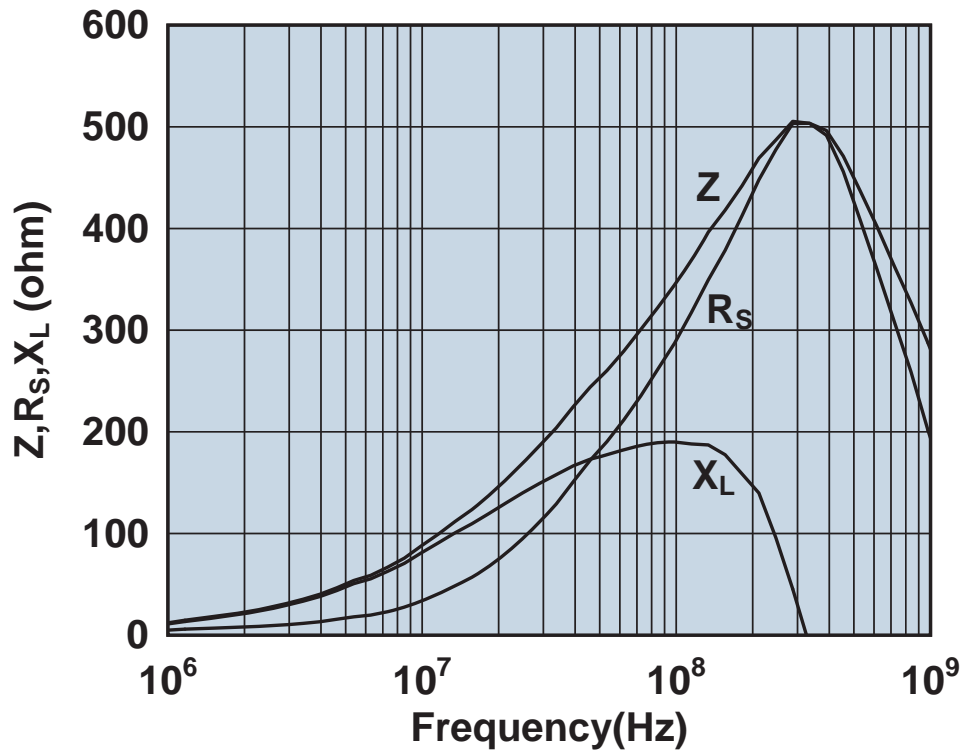

Impedance, reactance, and resistance vs. frequency.

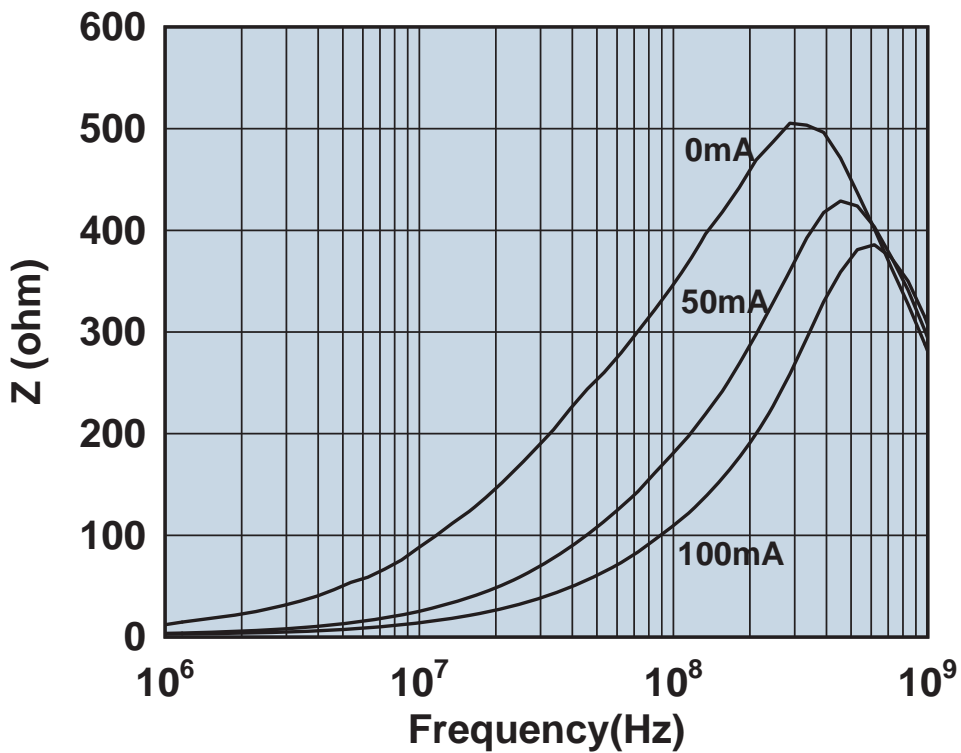

Impedance vs. frequency with dc bias.

2504026007Y0

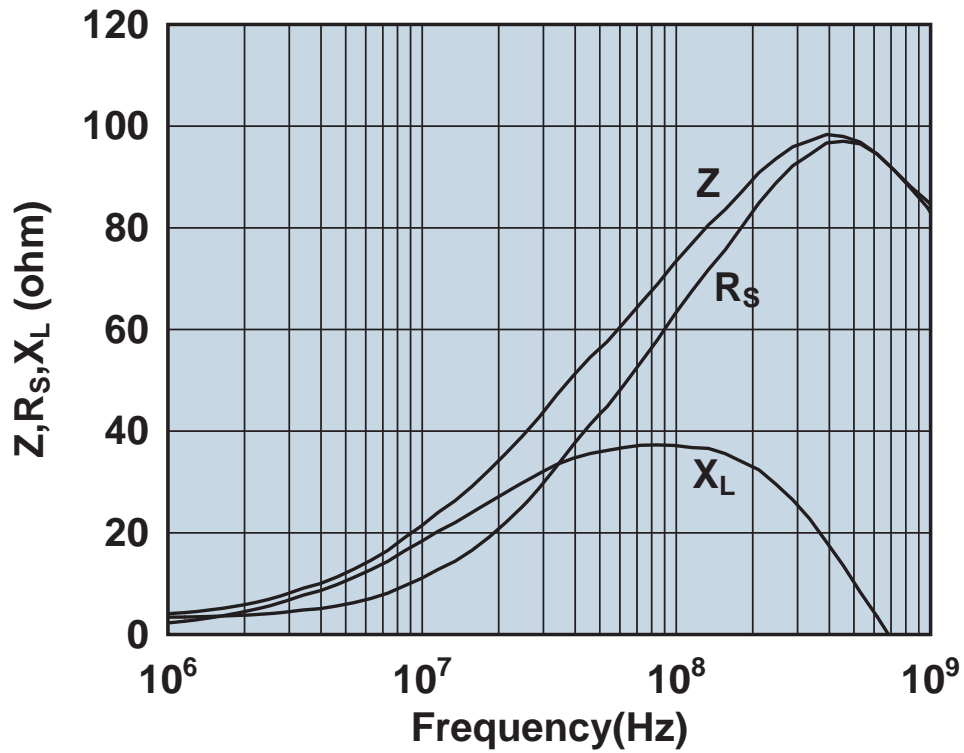

Impedance, reactance, and resistance vs. frequency.

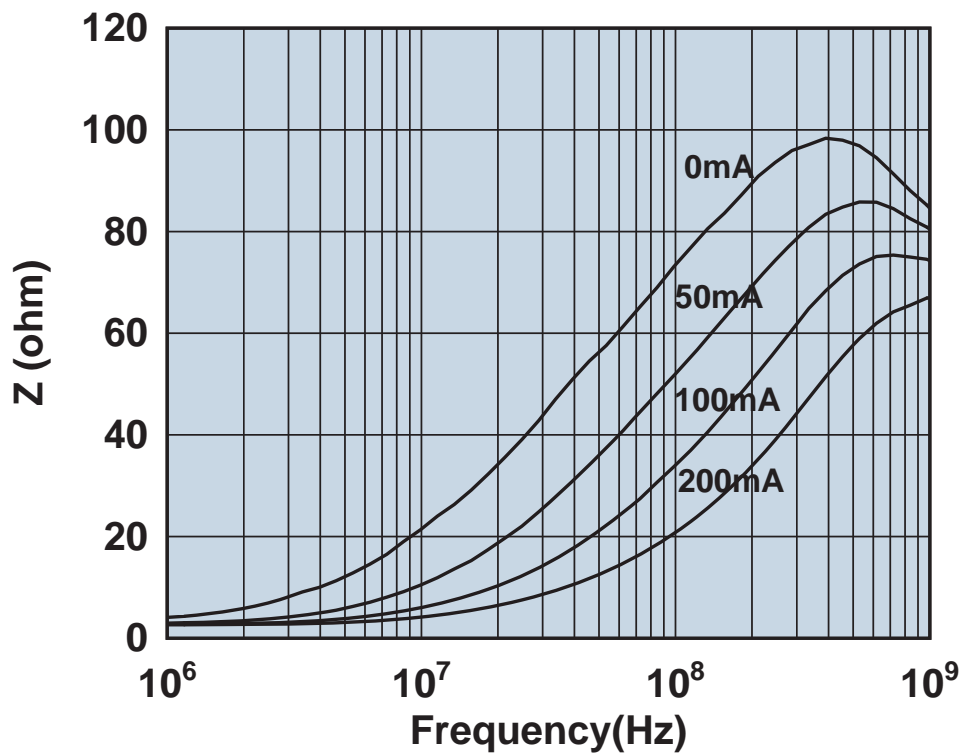

Impedance vs. frequency with dc bias.

2504026017Y0

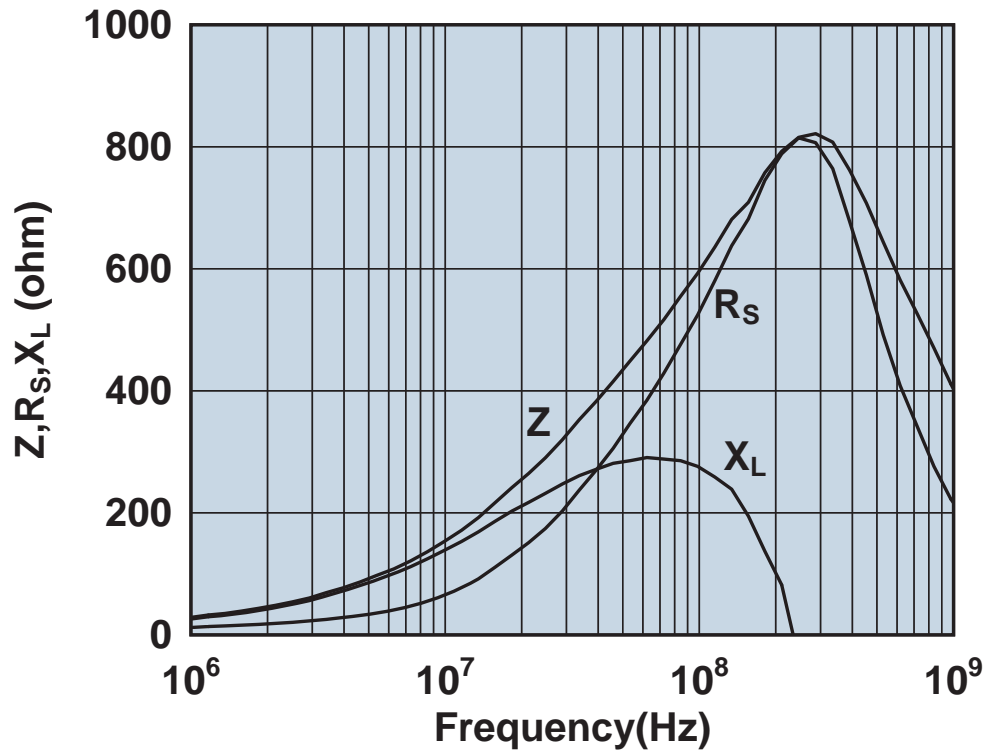

Impedance, reactance, and resistance vs. frequency.

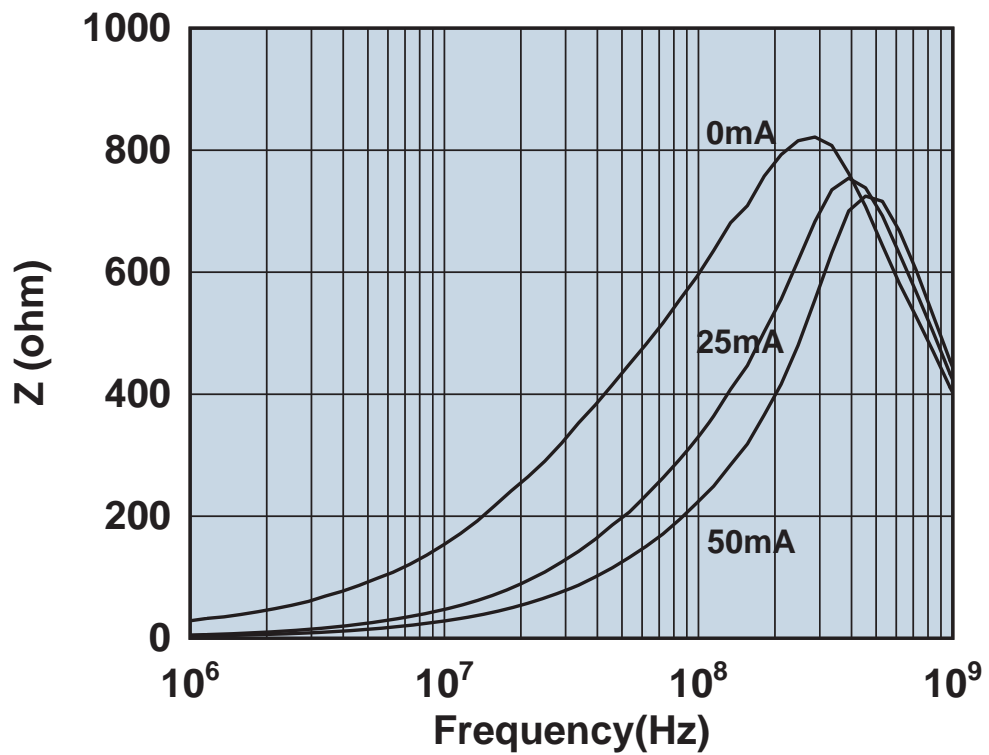

Impedance vs. frequency with dc bias.

2506030707H0

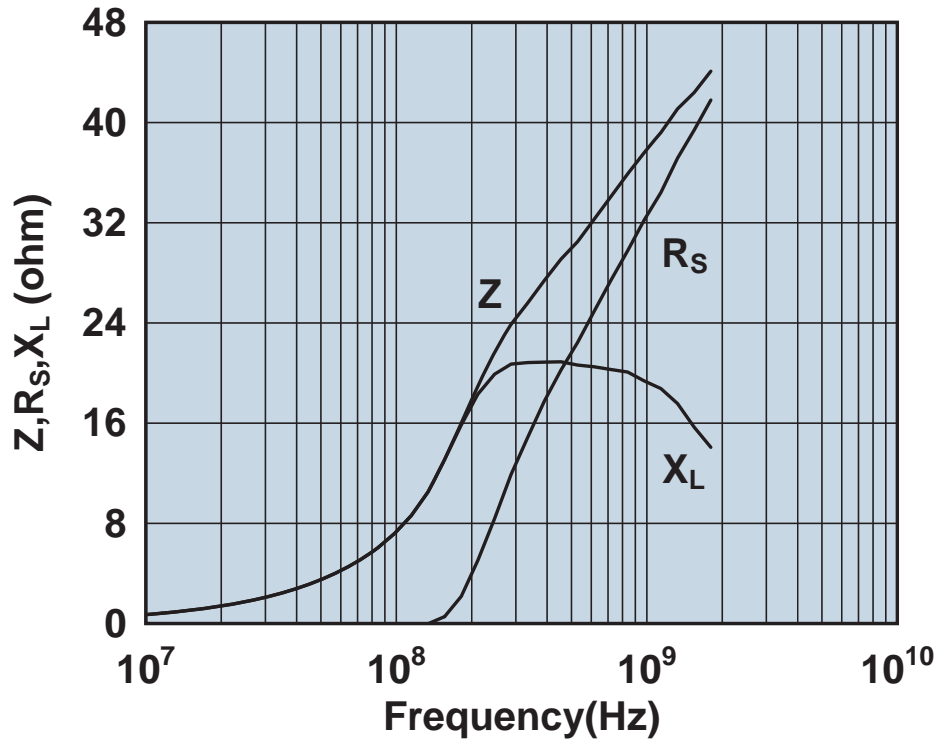

Impedance, reactance, and resistance vs. frequency.

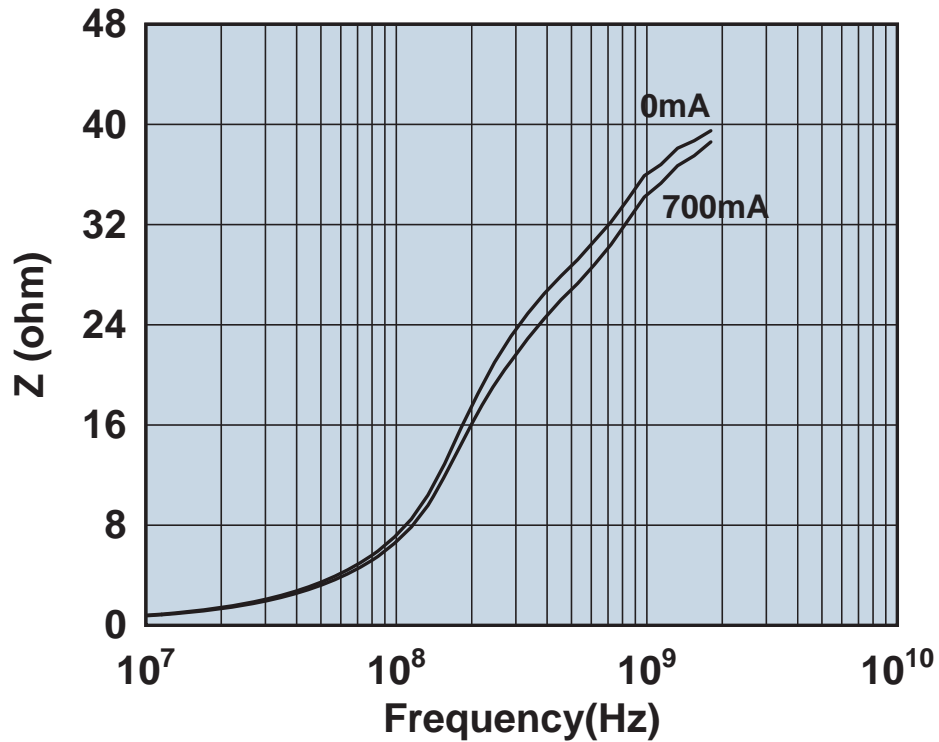

Impedance vs. frequency with dc bias.

2506031007H0

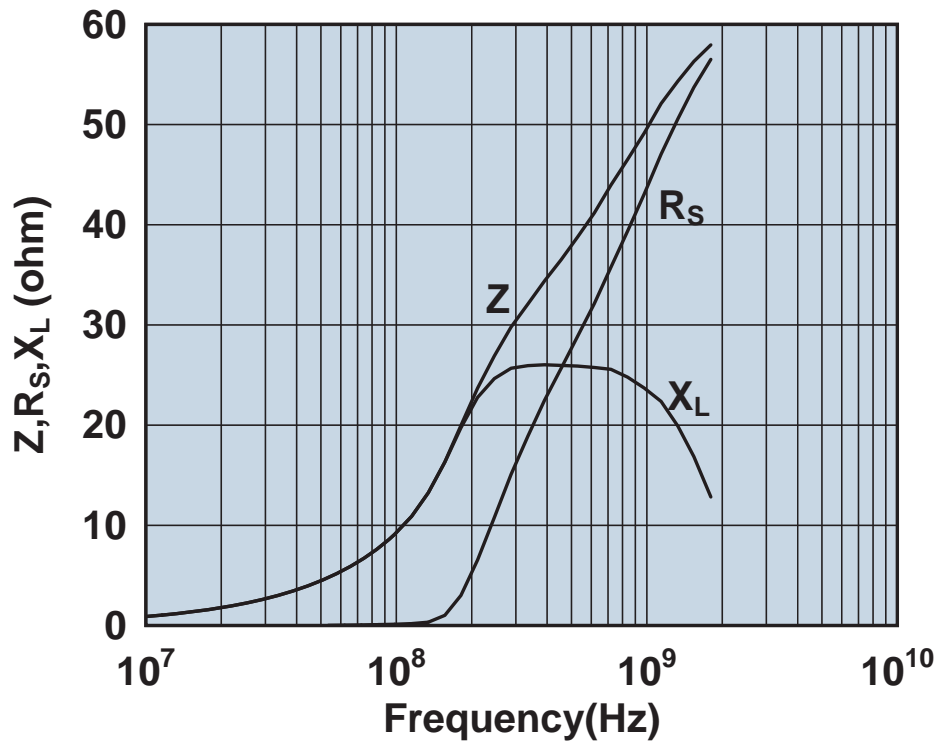

Impedance, reactance, and resistance vs. frequency.

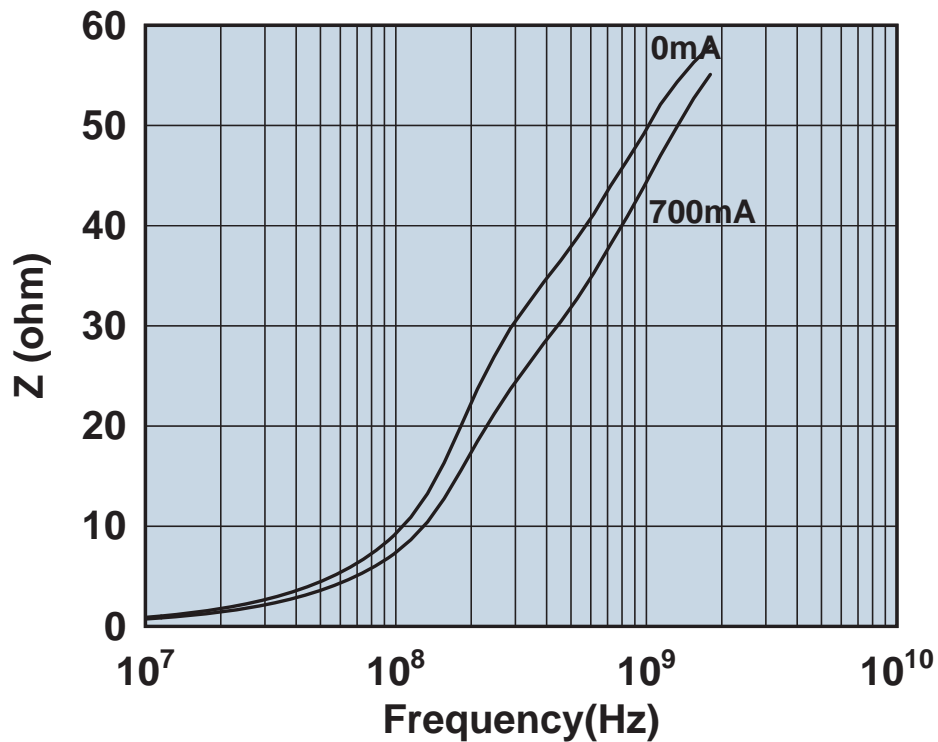

Impedance vs. frequency with dc bias.

2506031017Y0

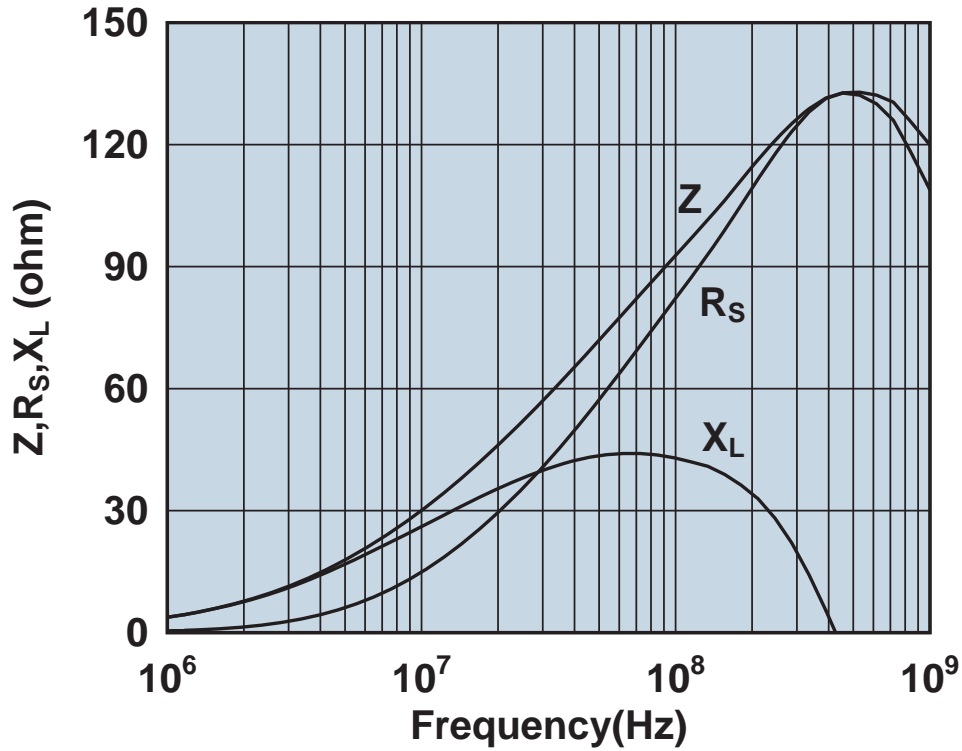

Impedance, reactance, and resistance vs. frequency.

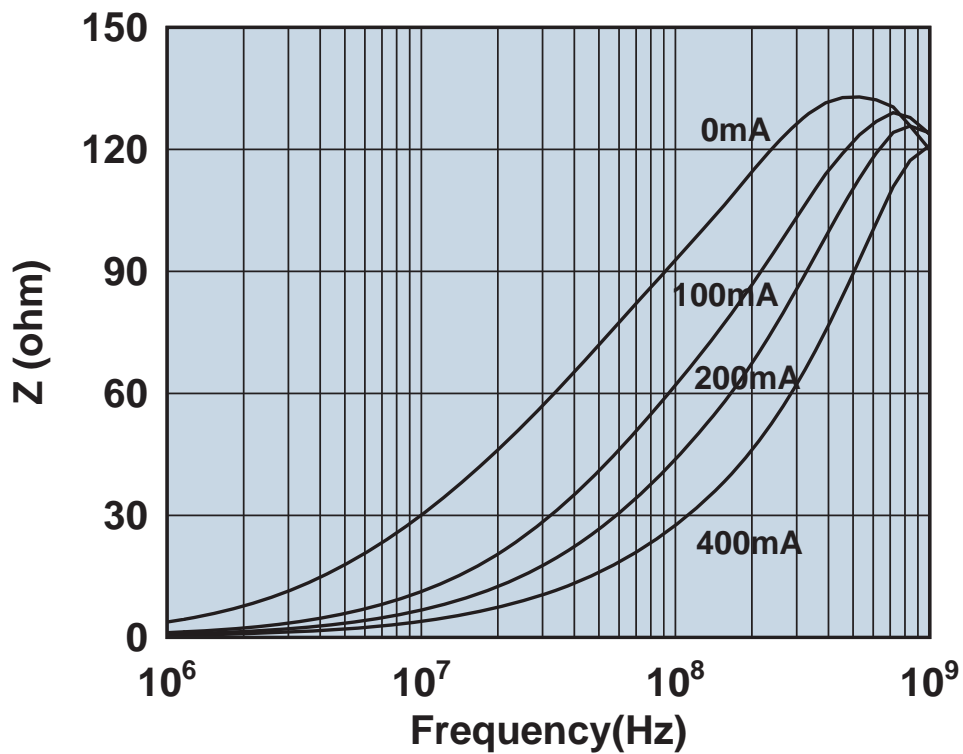

Impedance vs. frequency with dc bias.

2506031027Y0

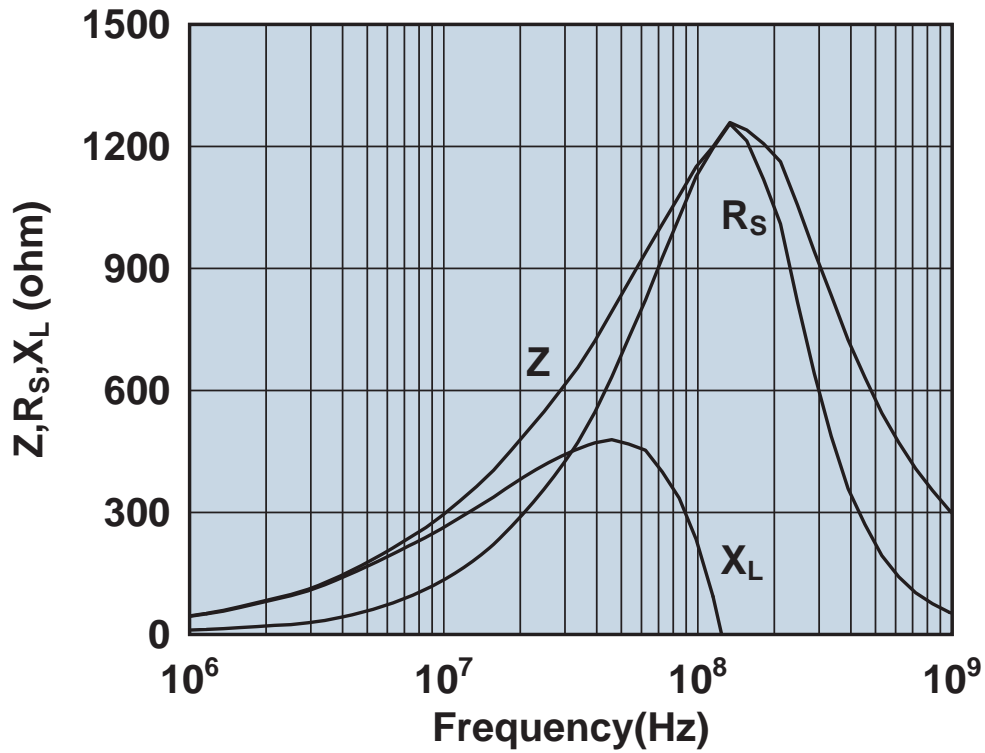

Impedance, reactance, and resistance vs. frequency.

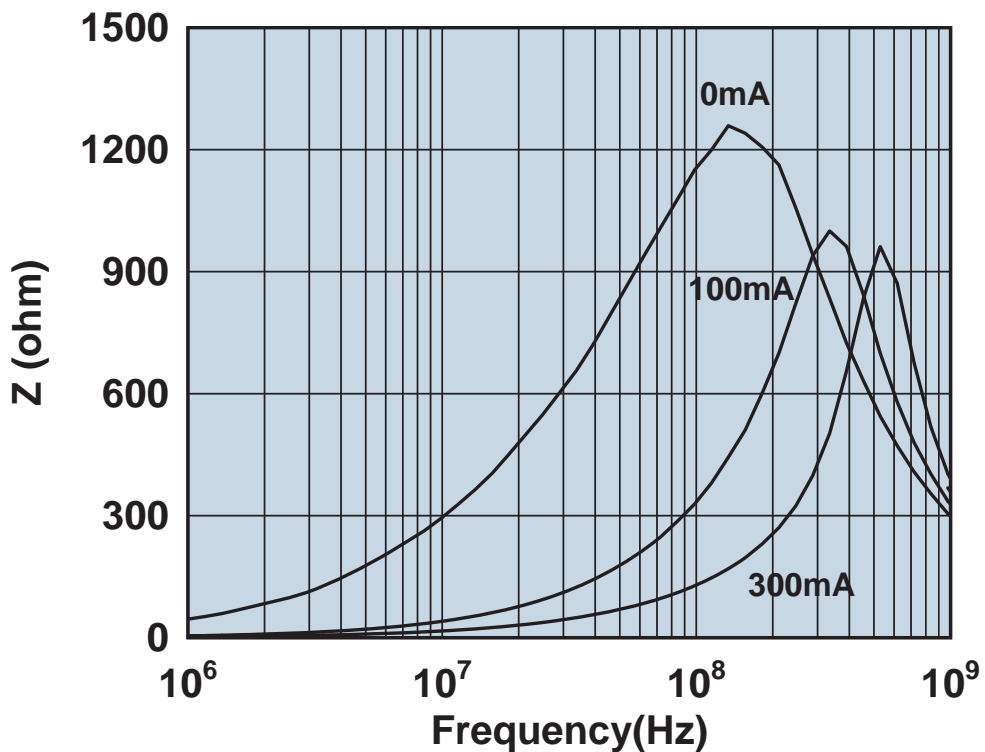

Impedance vs. frequency with dc bias.

2506031217H0

Not yet available.

Impedance, reactance, and resistance vs. frequency.

Not yet available.

Impedance vs. frequency with dc bias.

2506031217Y0

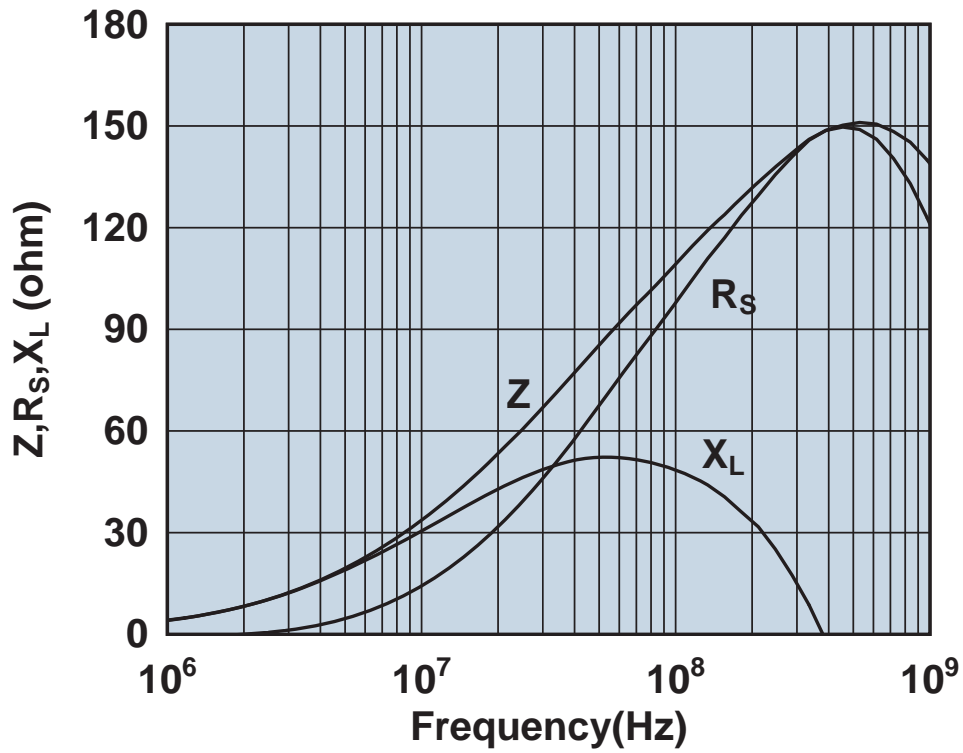

Impedance, reactance, and resistance vs. frequency.

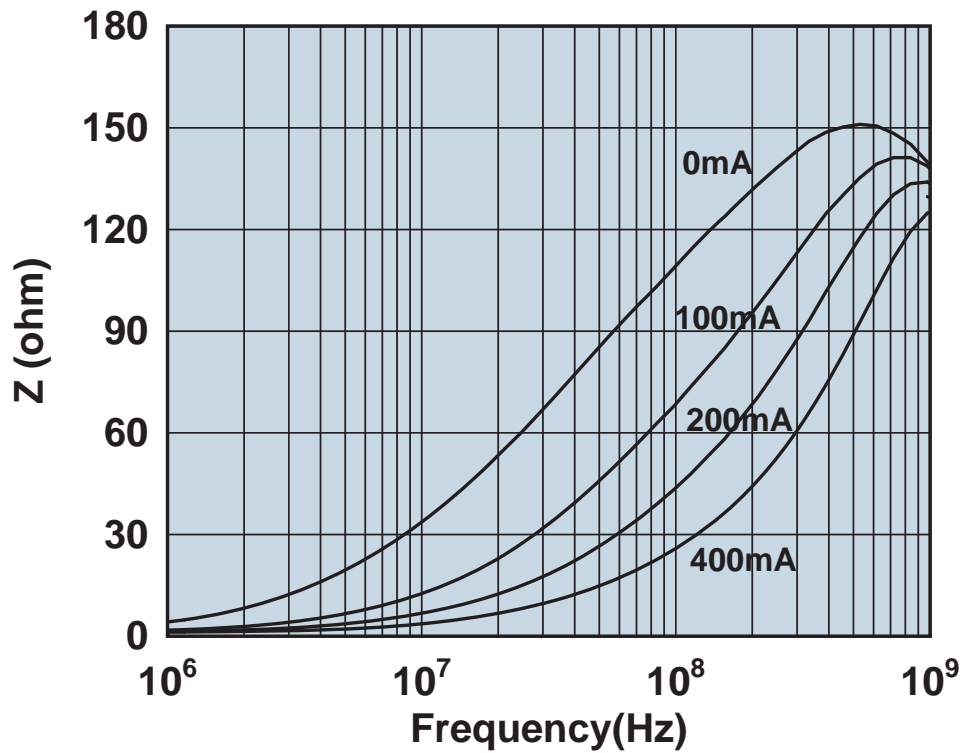

Impedance vs. frequency with dc bias.

2506031217Y2

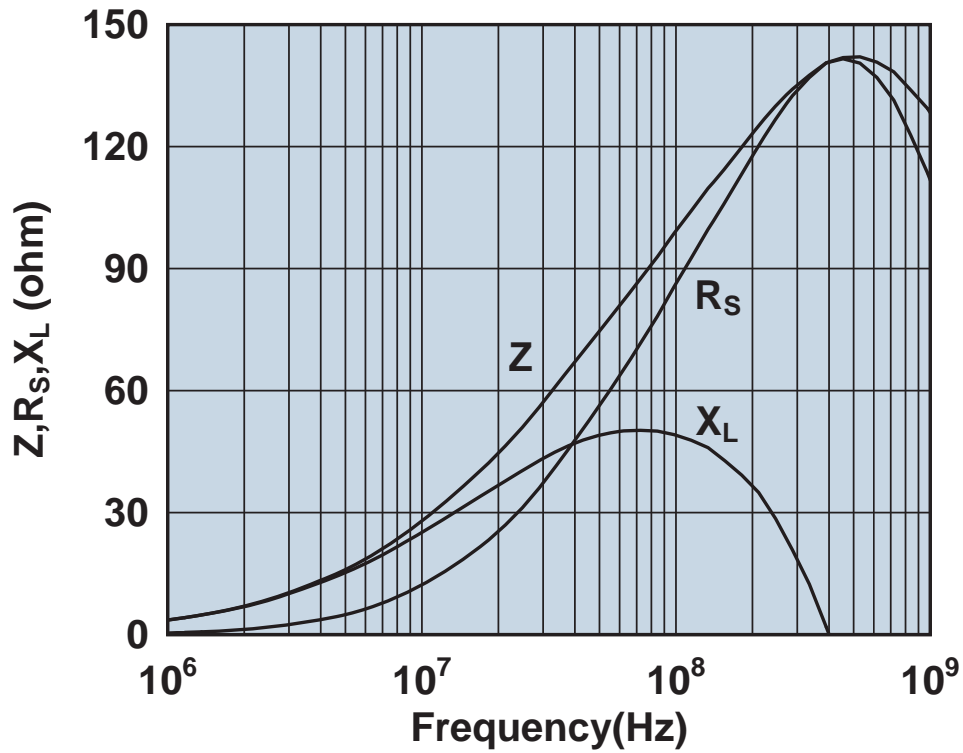

Impedance, reactance, and resistance vs. frequency.

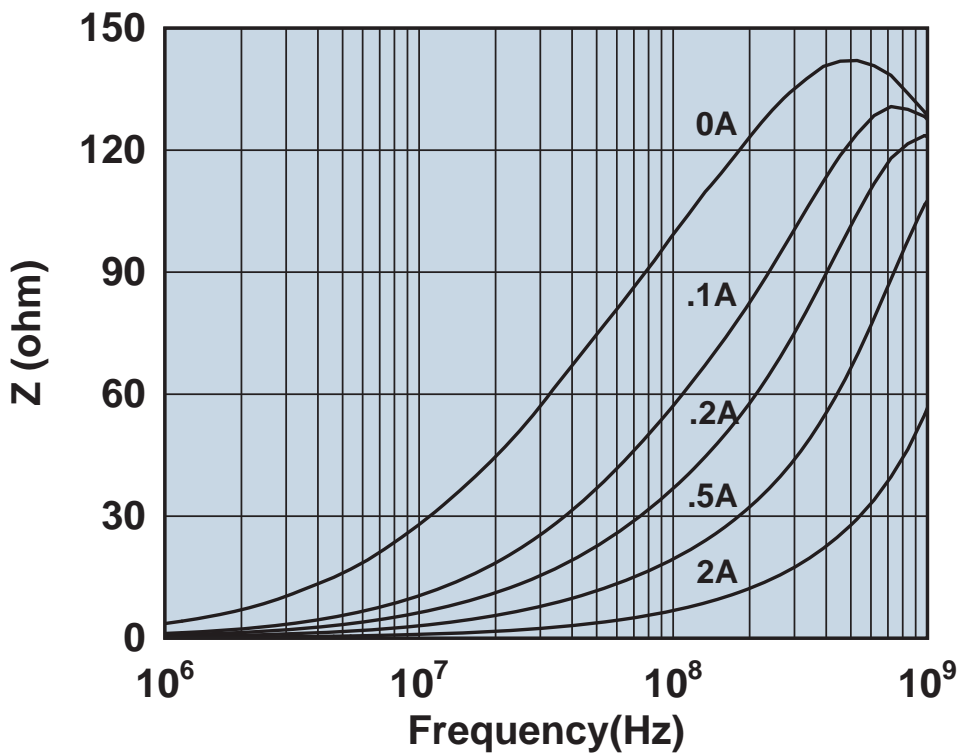

Impedance vs. frequency with dc bias.

2506031217Z0

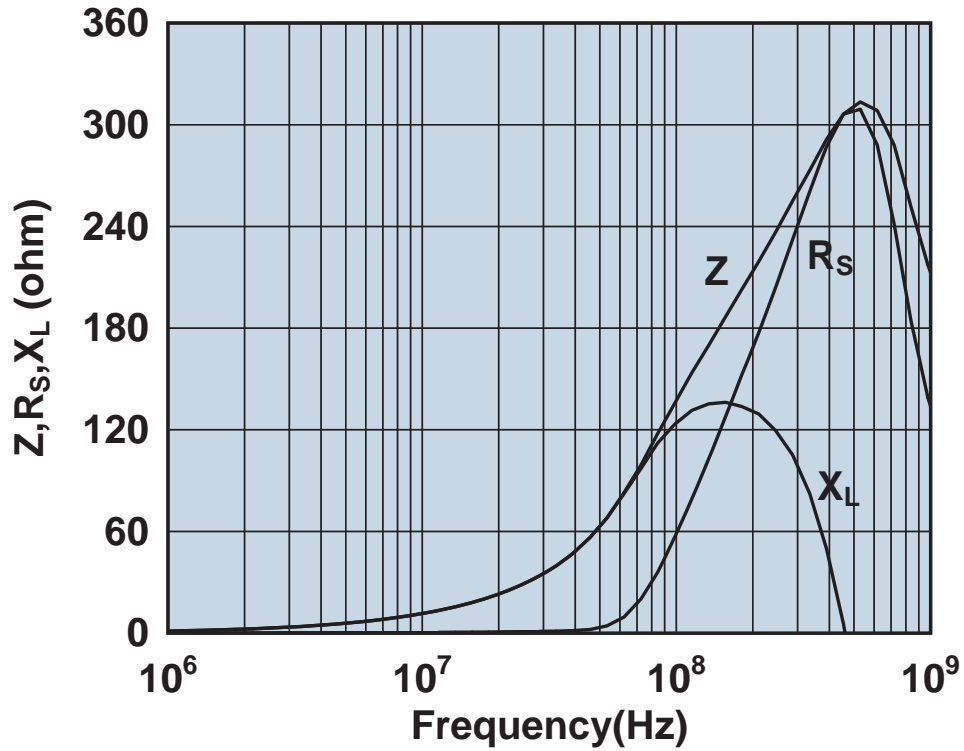

Impedance, reactance, and resistance vs. frequency.

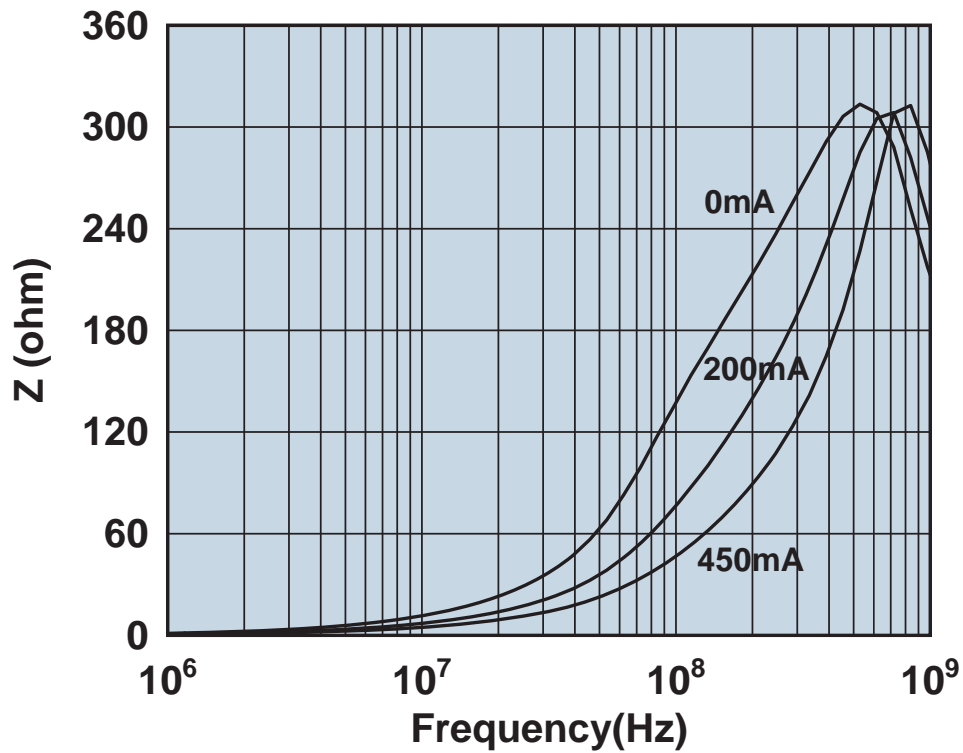

Impedance vs. frequency with dc bias.

2506031517Y0

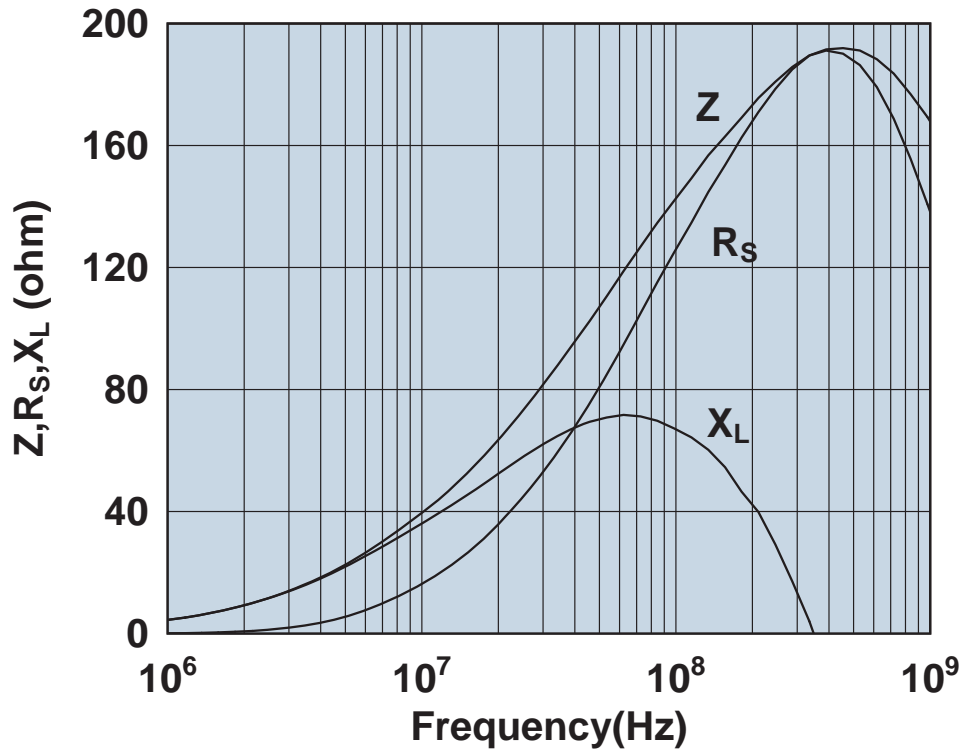

Impedance, reactance, and resistance vs. frequency.

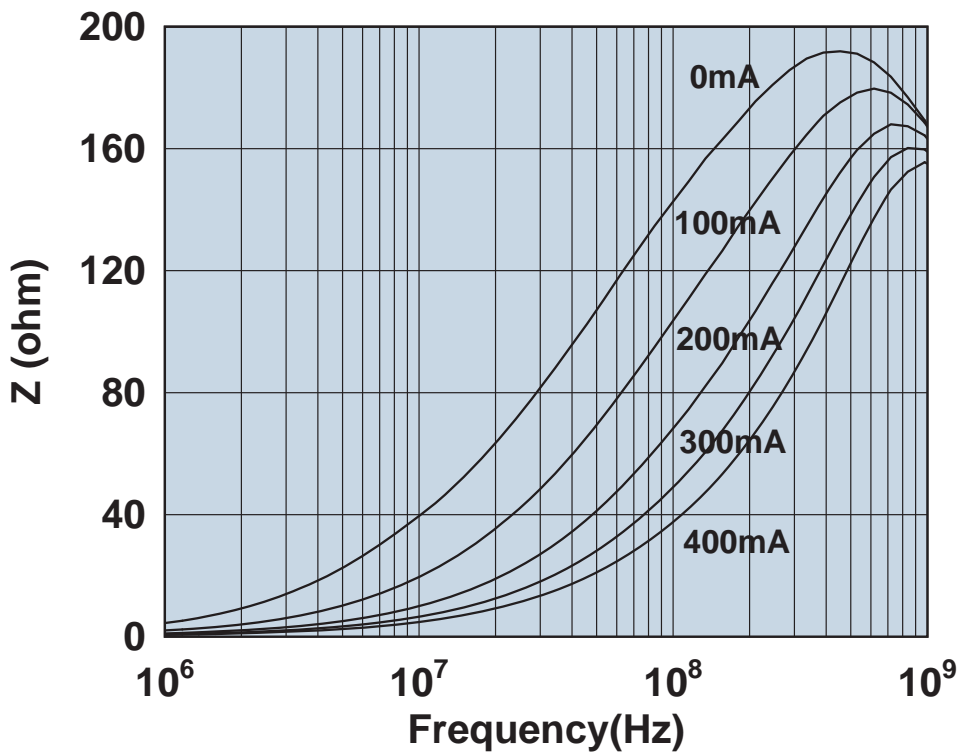

Impedance vs. frequency with dc bias.

2506032217H0

Not yet available.

Impedance, reactance, and resistance vs. frequency.

Not yet available.

Impedance vs. frequency with dc bias.

2506033007Y0

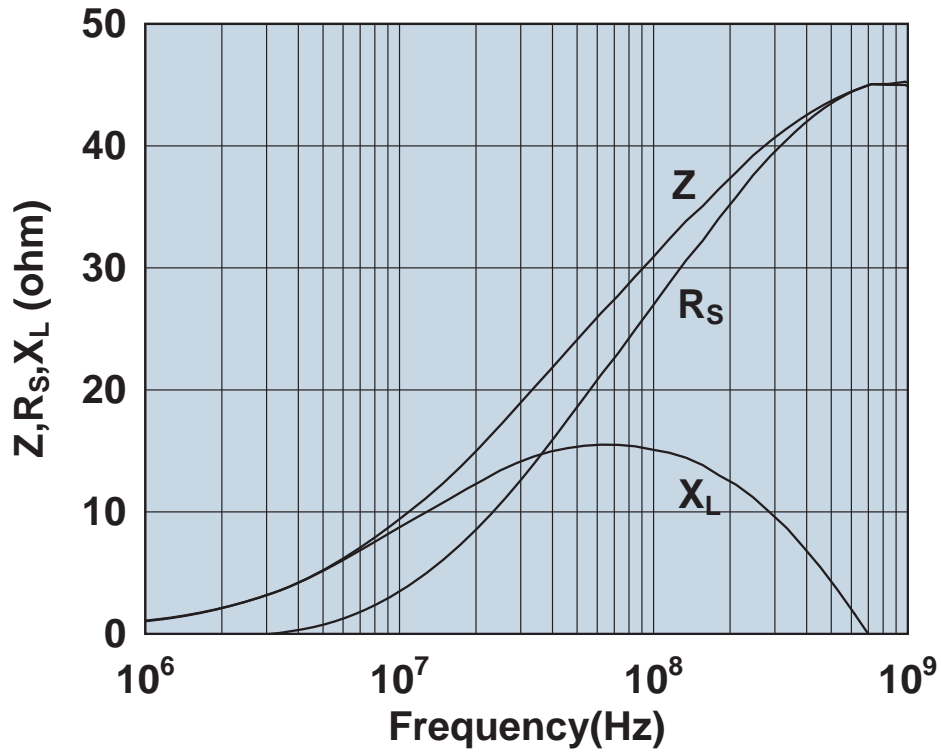

Impedance, reactance, and resistance vs. frequency.

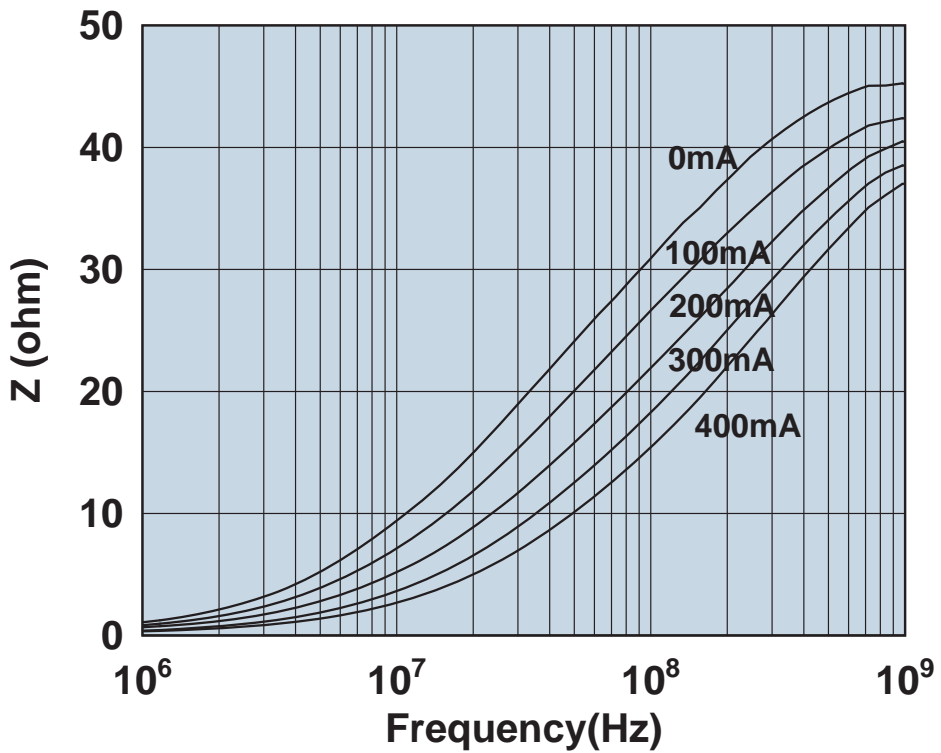

Impedance vs. frequency with dc bias.

2506033007Y3

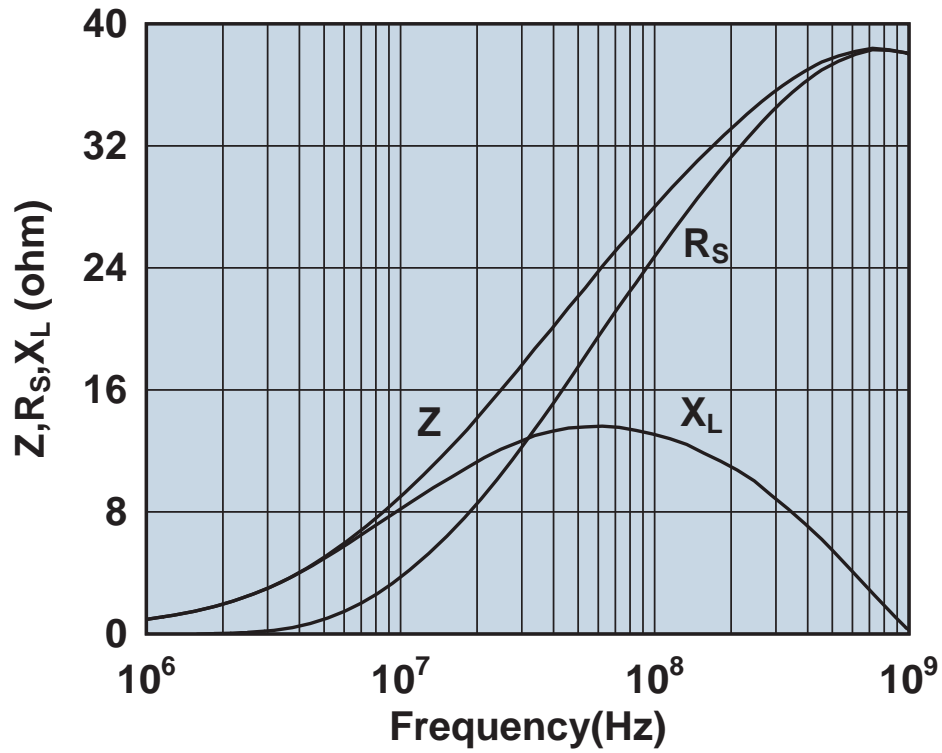

Impedance, reactance, and resistance vs. frequency.

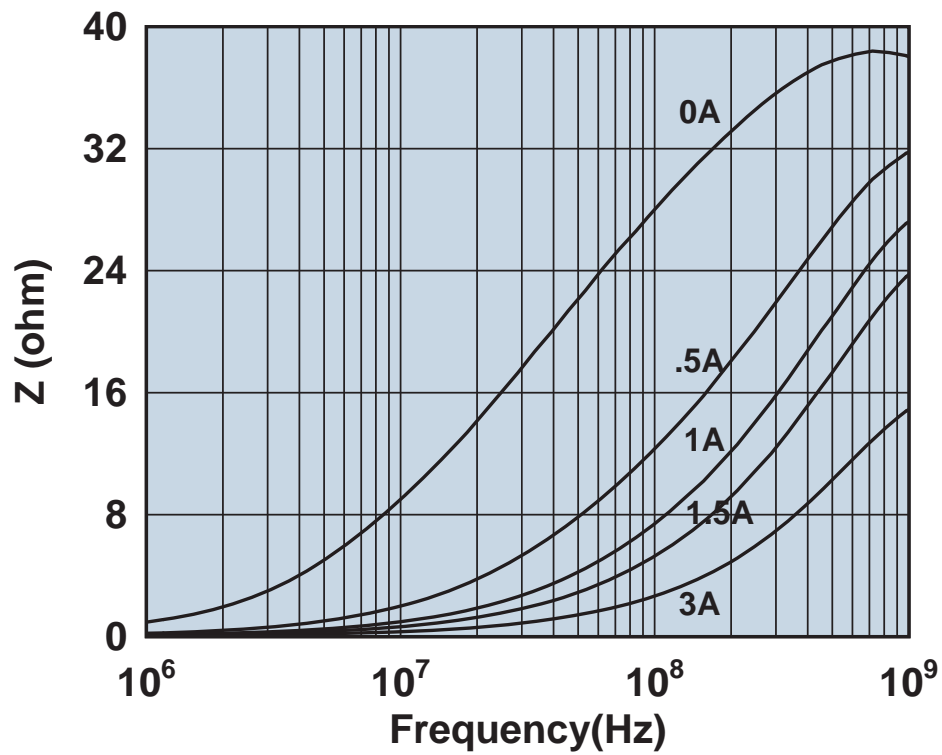

Impedance vs. frequency with dc bias.

2506033017Y0

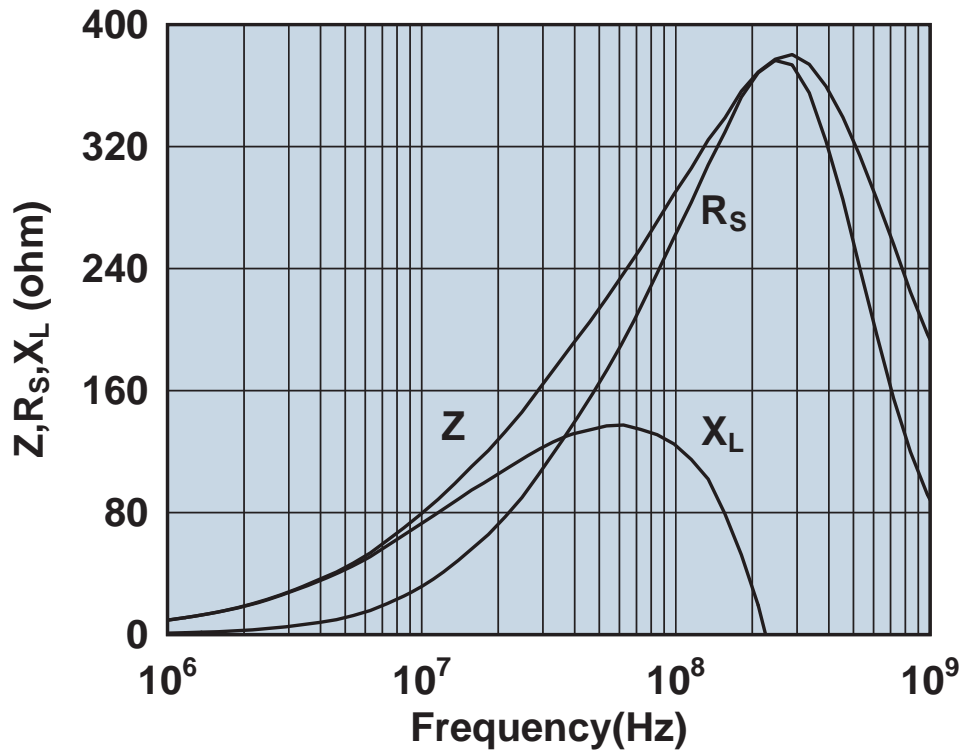

Impedance, reactance, and resistance vs. frequency.

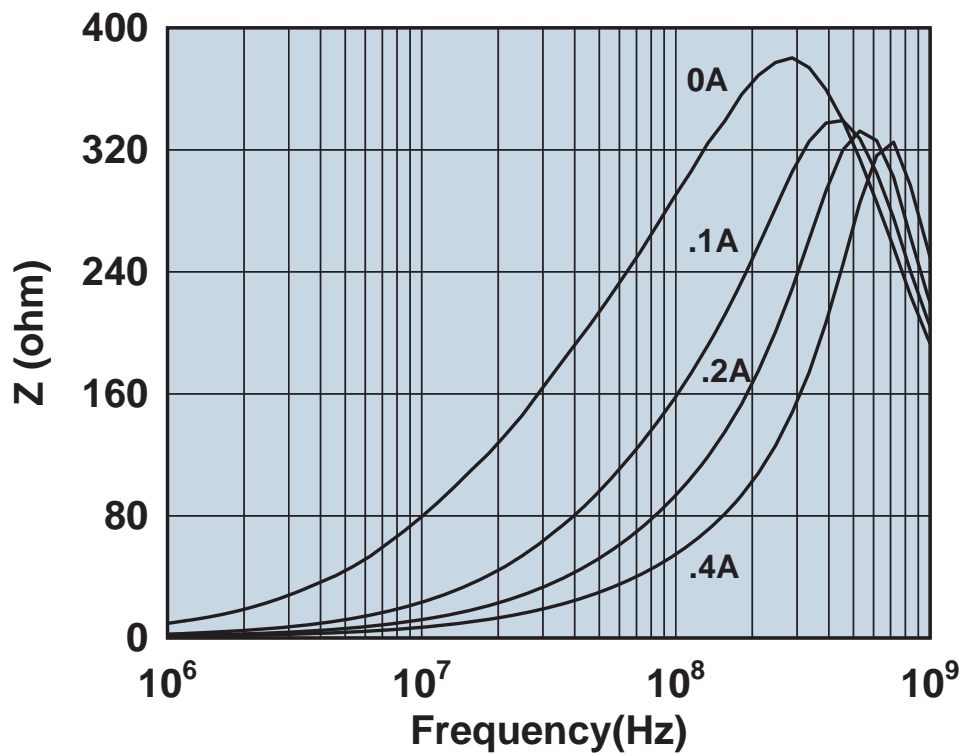

Impedance vs. frequency with dc bias.

2506033017Z0

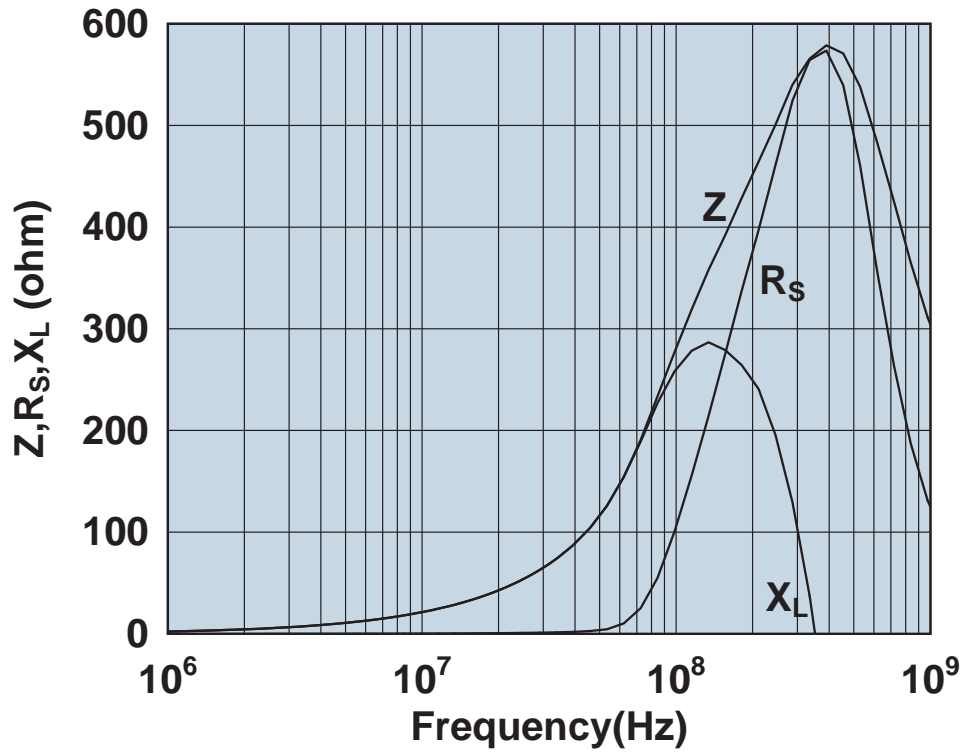

Impedance, reactance, and resistance vs. frequency.

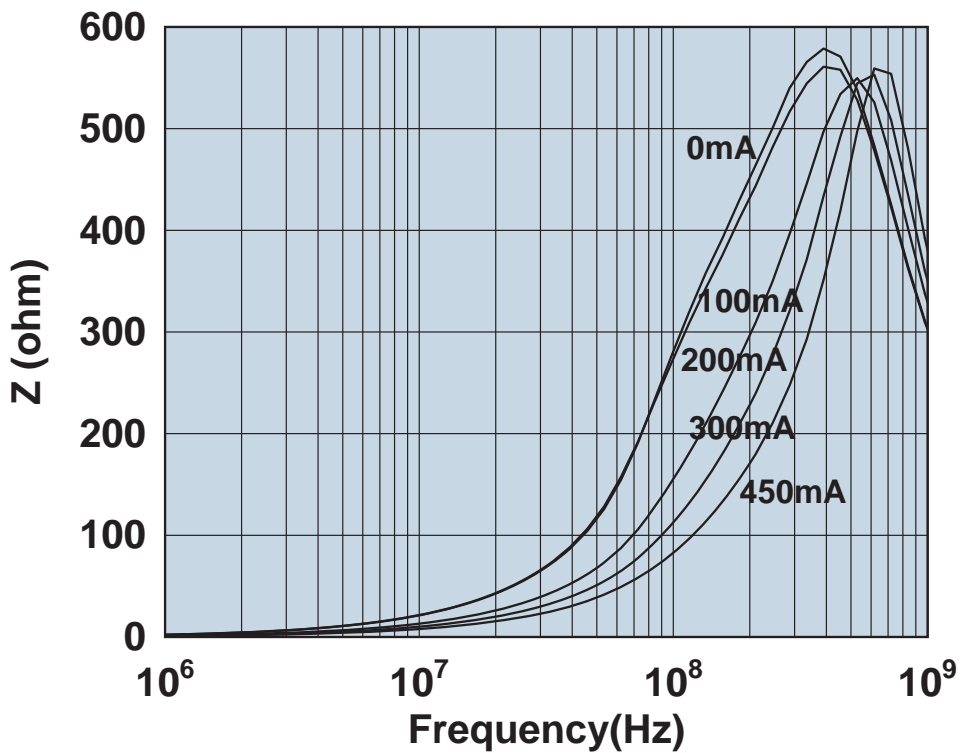

Impedance vs. frequency with dc bias.

2506033317H0

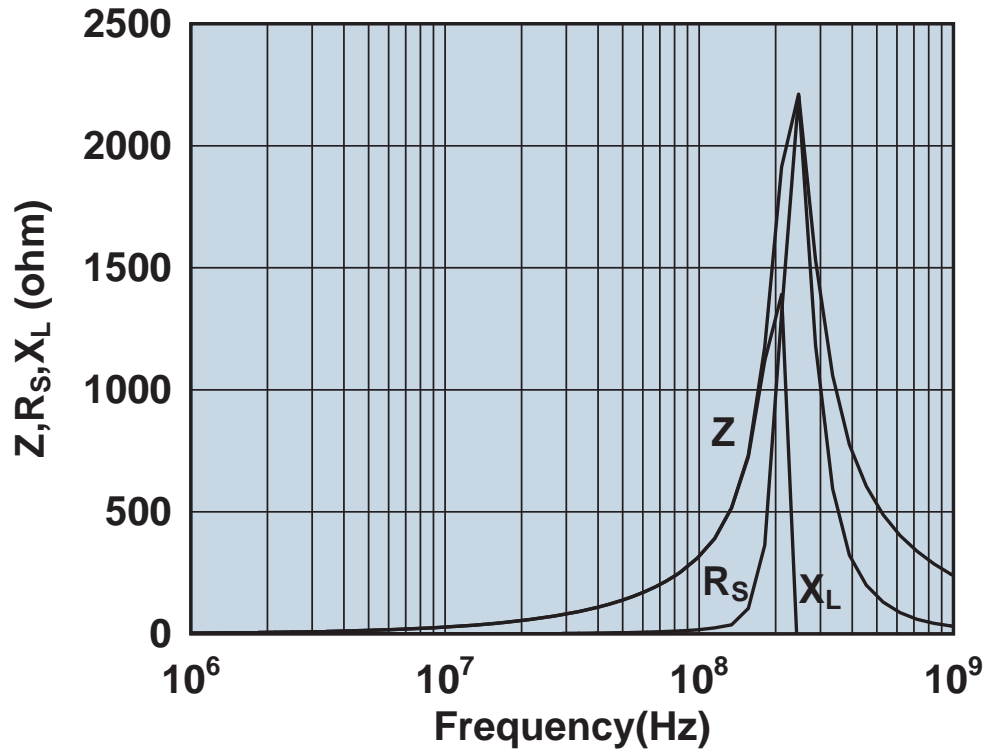

Impedance, reactance, and resistance vs. frequency.

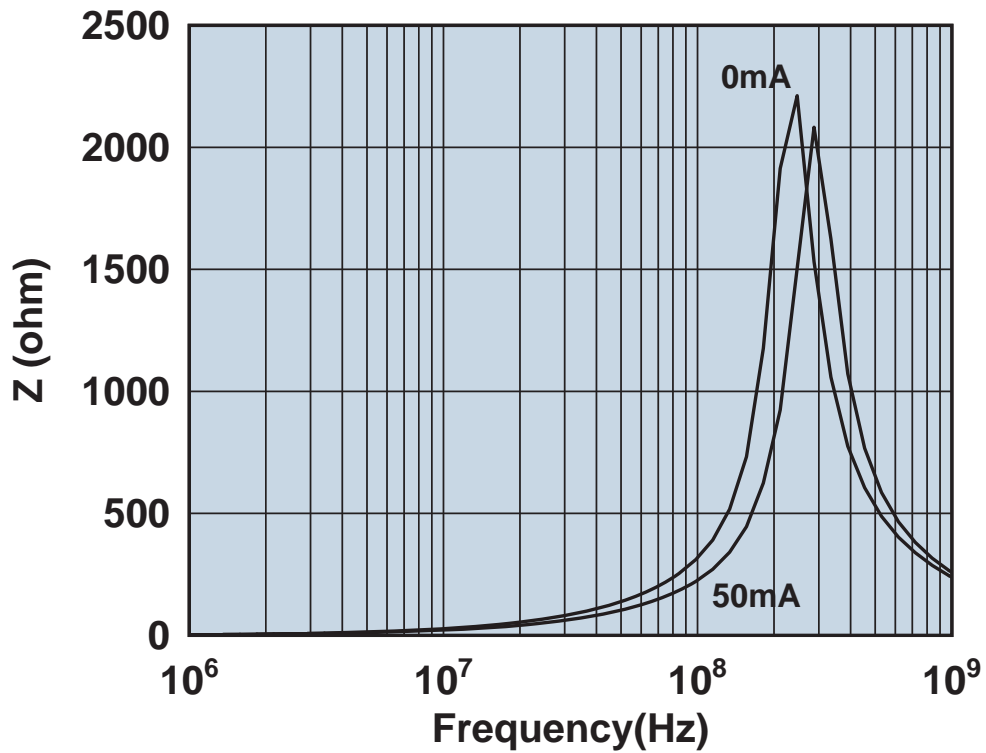

Impedance vs. frequency with dc bias.

2506036007Y0

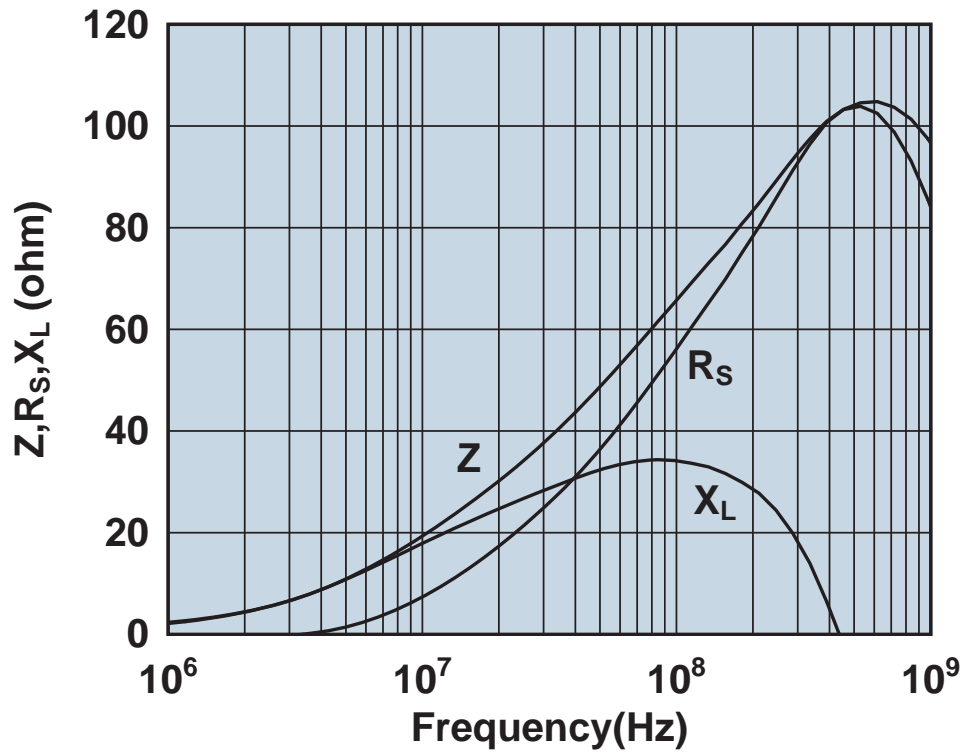

Impedance, reactance, and resistance vs. frequency.

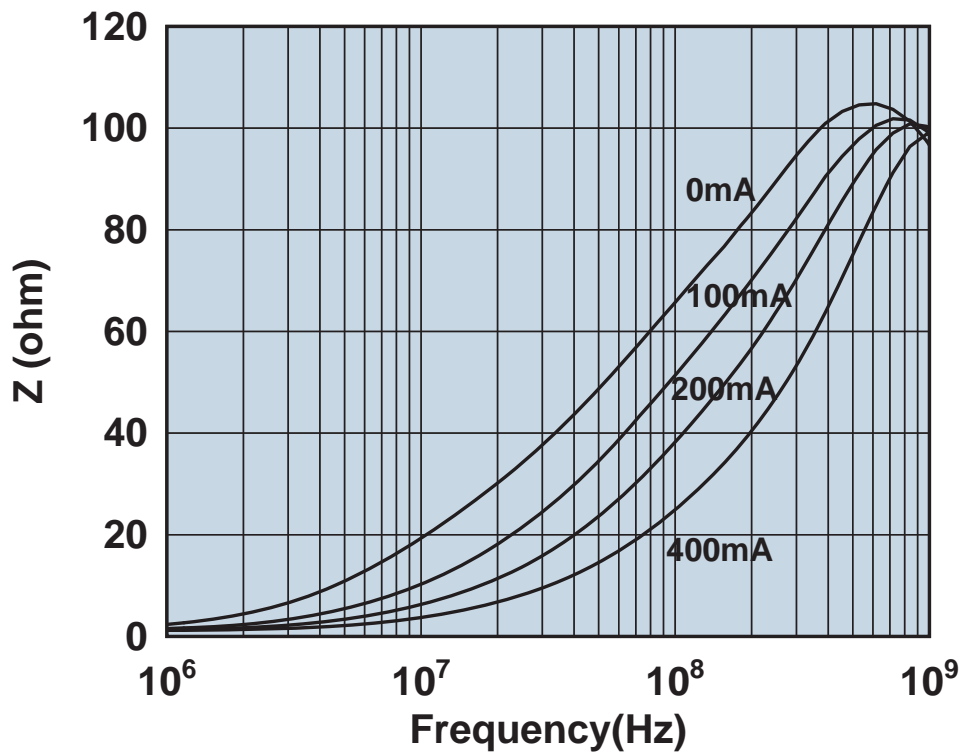

Impedance vs. frequency with dc bias.

2506036007Y3

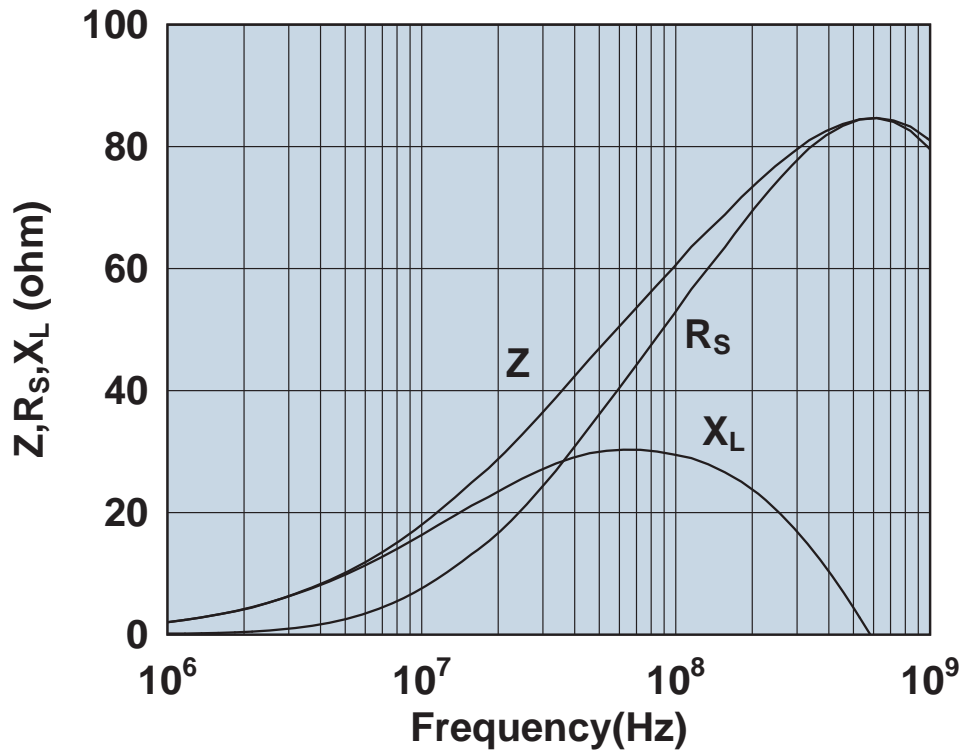

Impedance, reactance, and resistance vs. frequency.

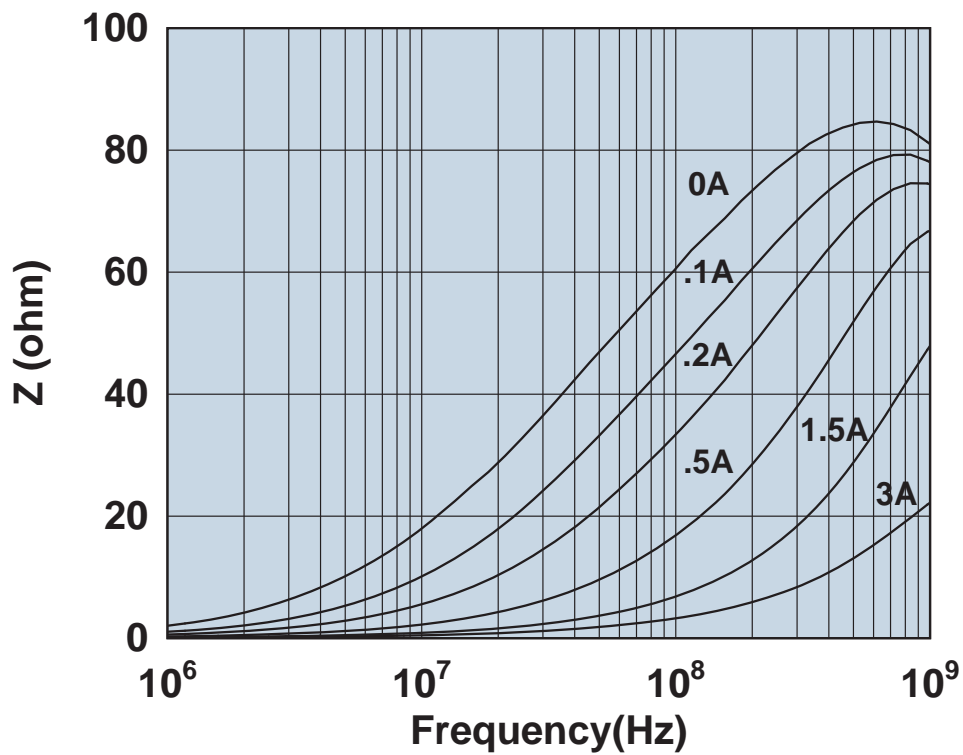

Impedance vs. frequency with dc bias.

2506036007Z0

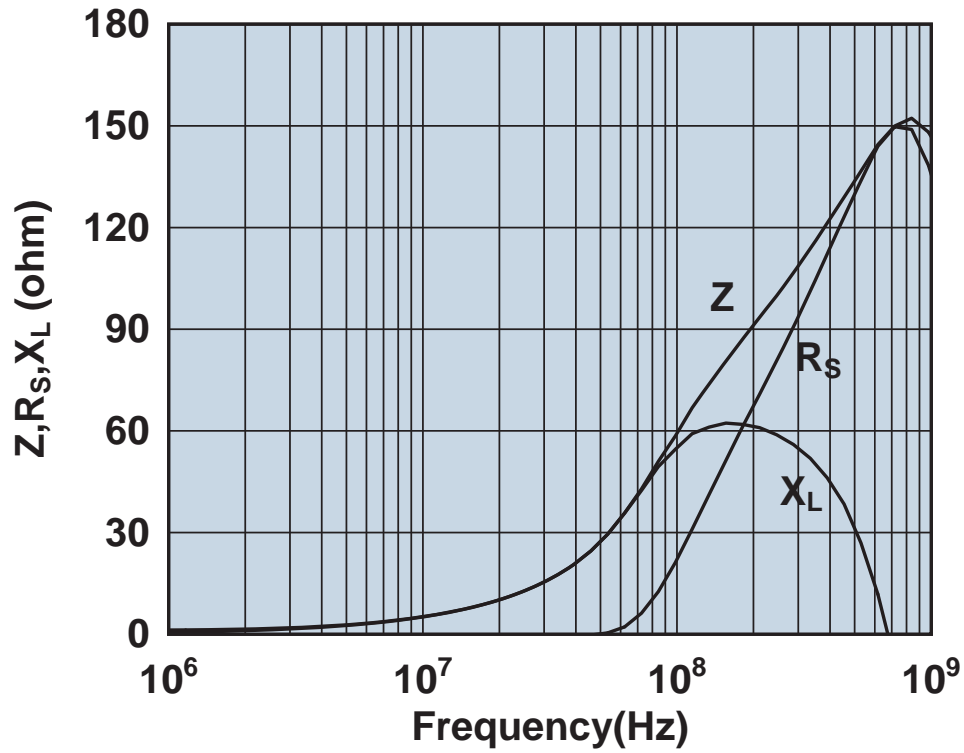

Impedance, reactance, and resistance vs. frequency.

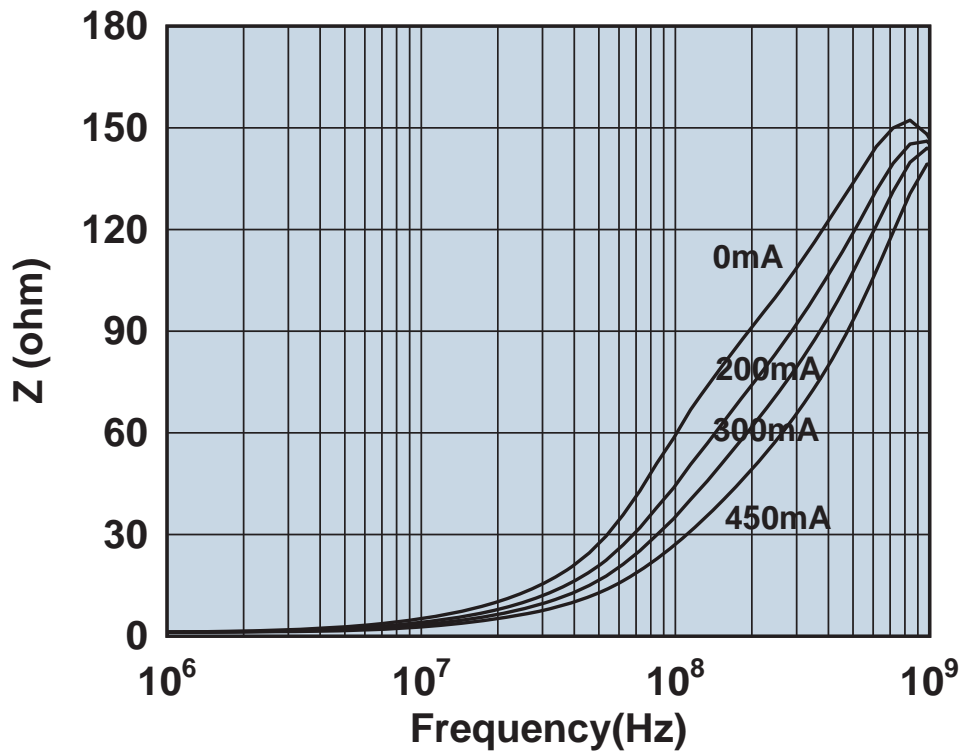

Impedance vs. frequency with dc bias.

2506036017Y0

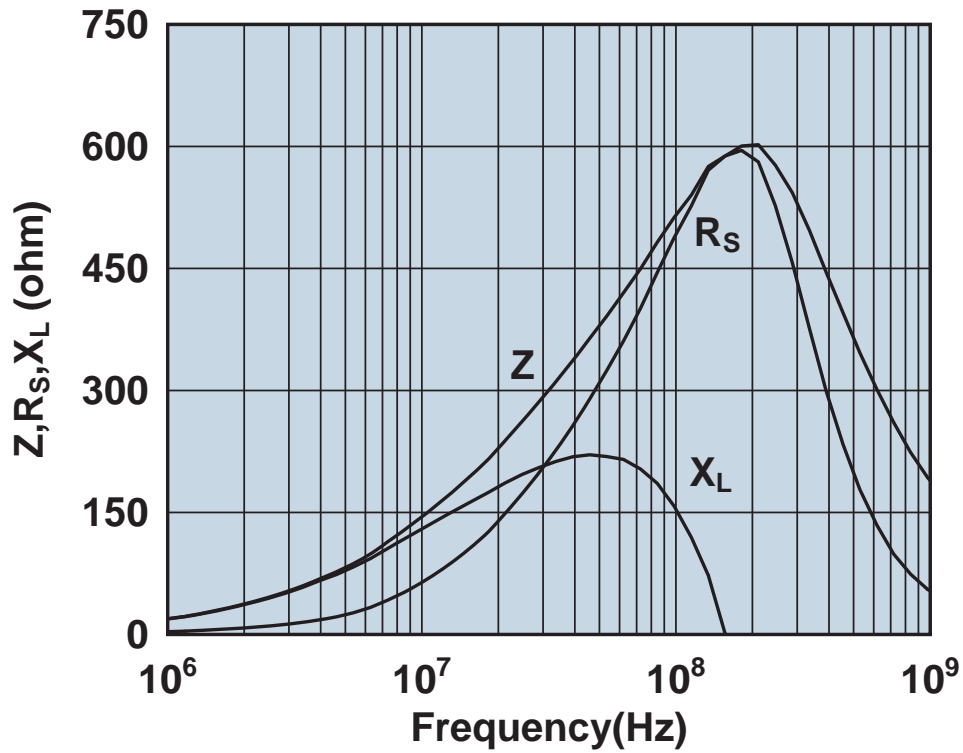

Impedance, reactance, and resistance vs. frequency.

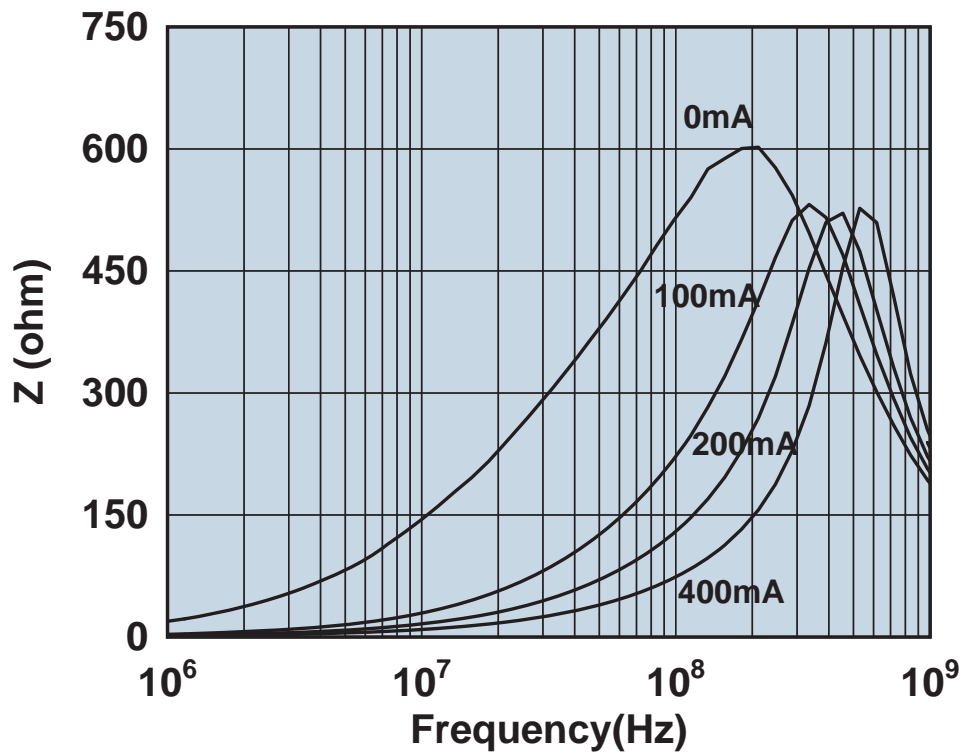

Impedance vs. frequency with dc bias.

2506038007Y0

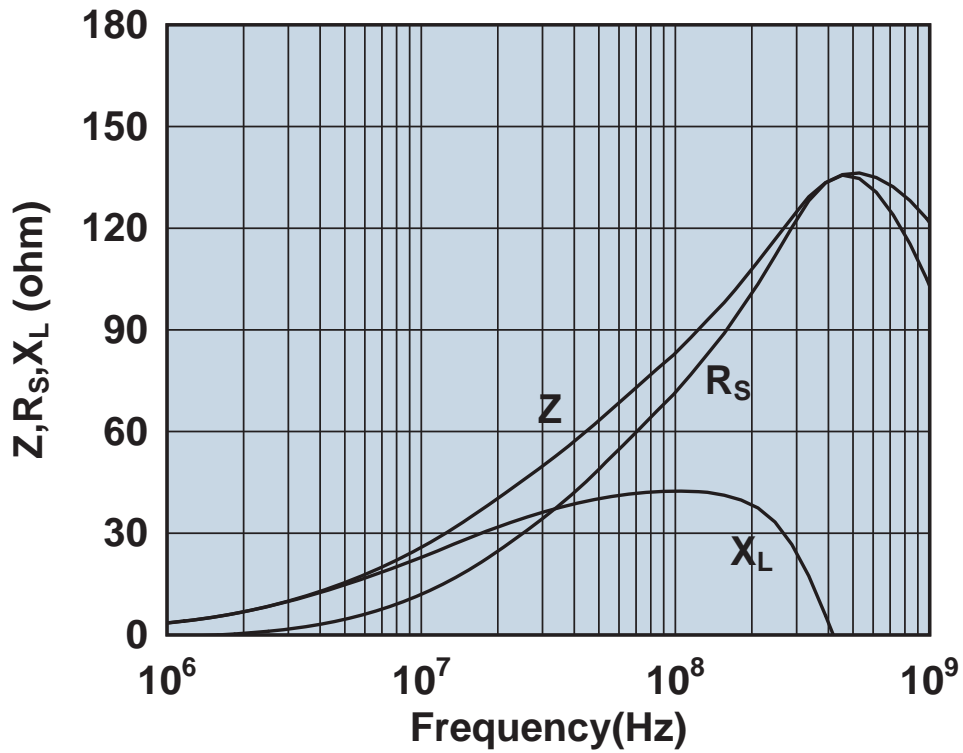

Impedance, reactance, and resistance vs. frequency.

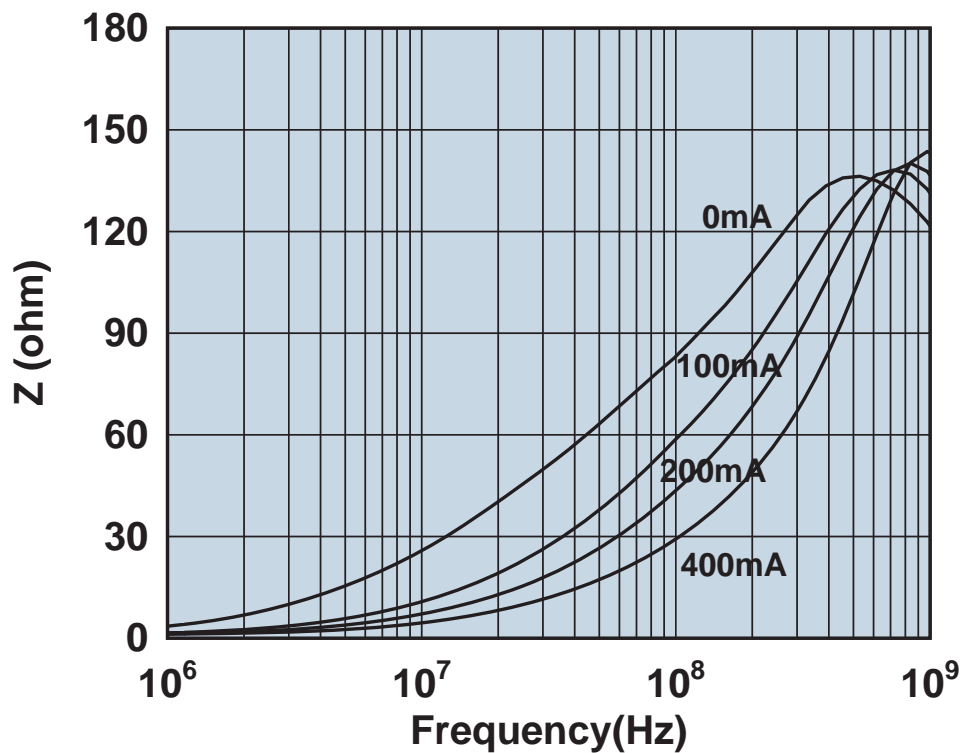

Impedance vs. frequency with dc bias.

2508050507H0

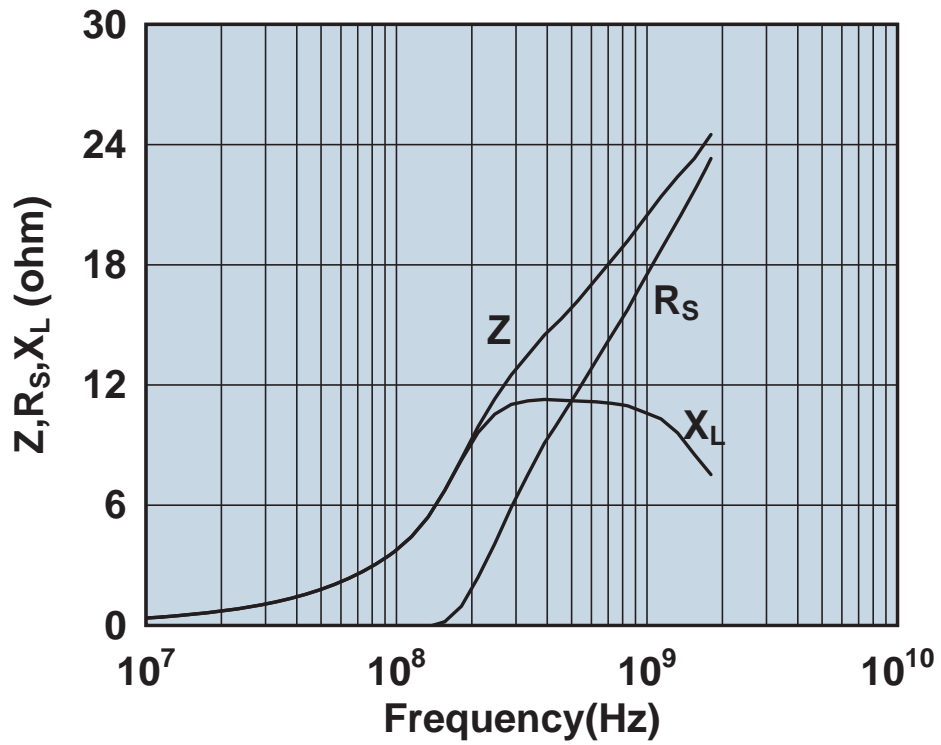

Impedance, reactance, and resistance vs. frequency.

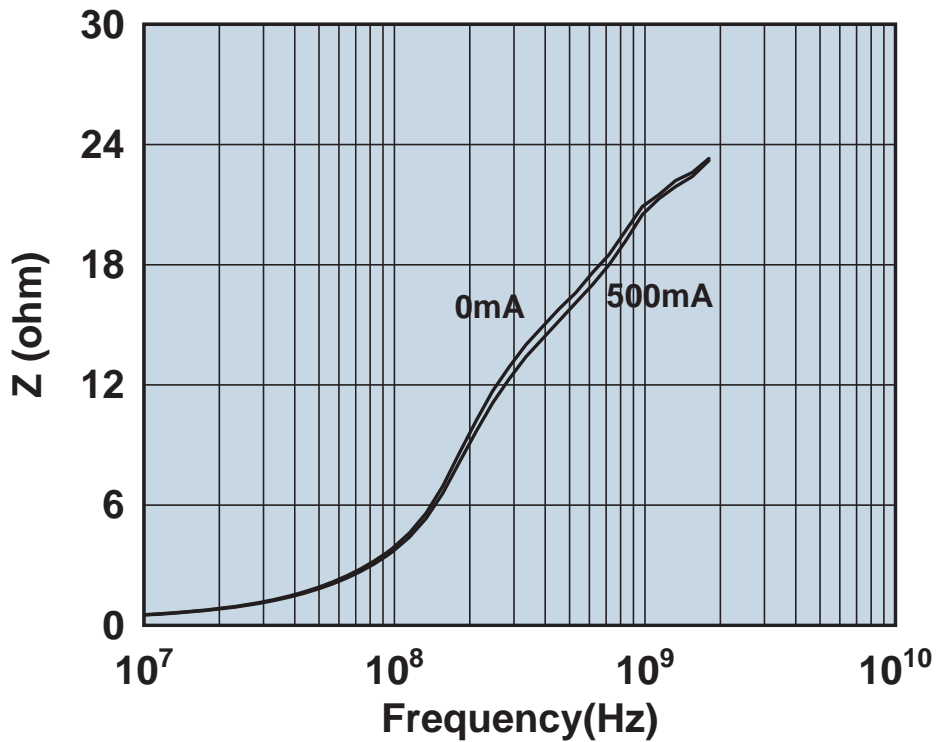

Impedance vs. frequency with dc bias.

2508051017Y0

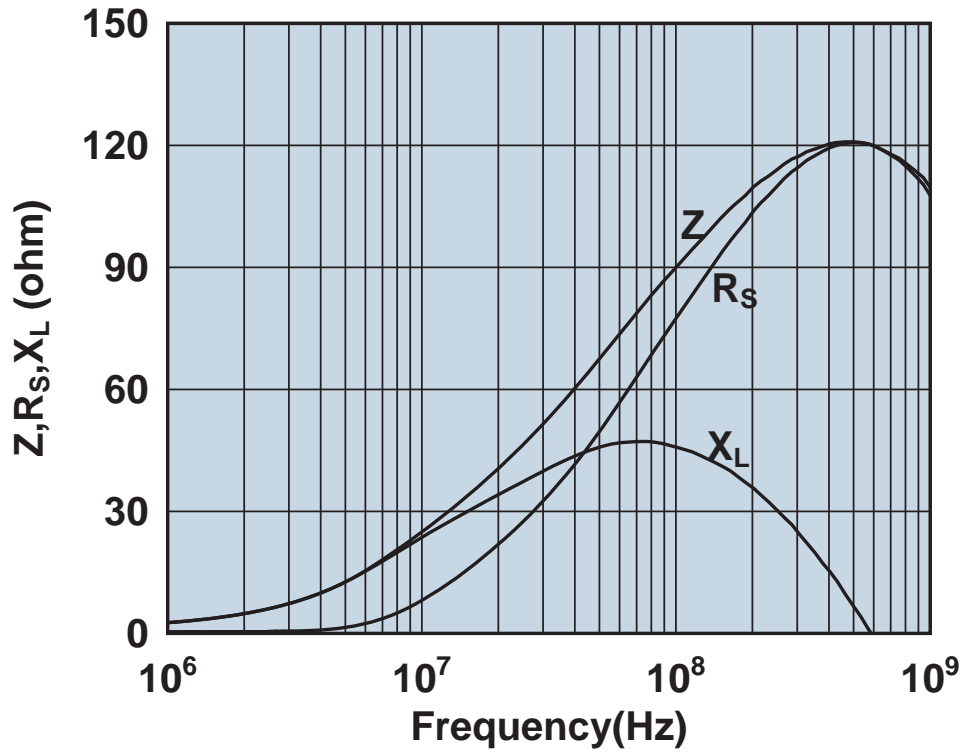

Impedance, reactance, and resistance vs. frequency.

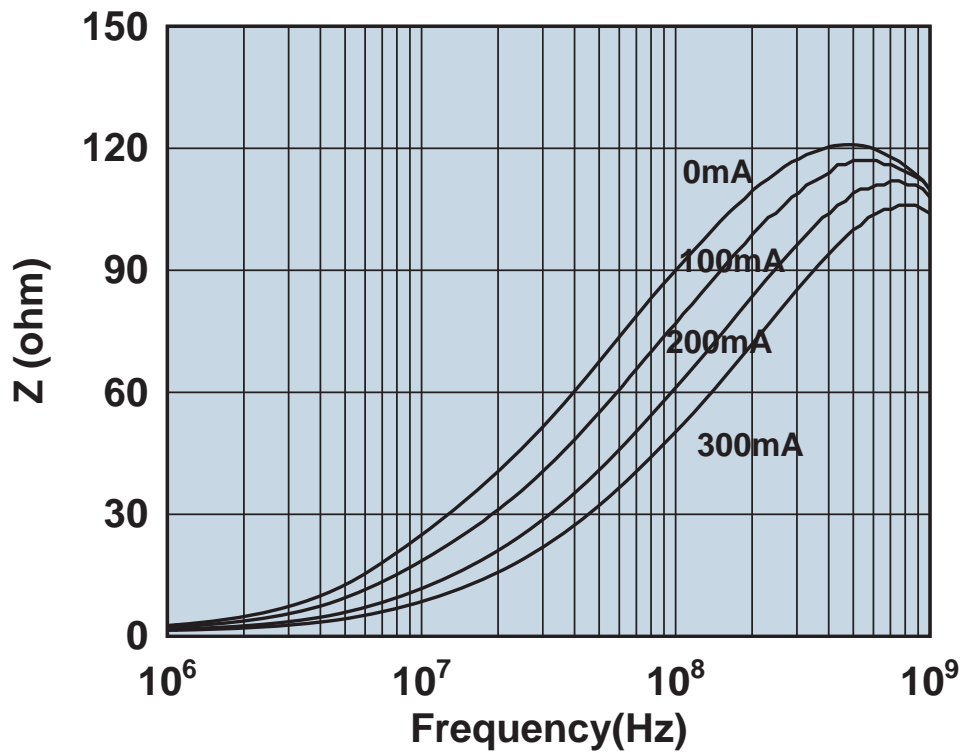

Impedance vs. frequency with dc bias.

2508051027Y0

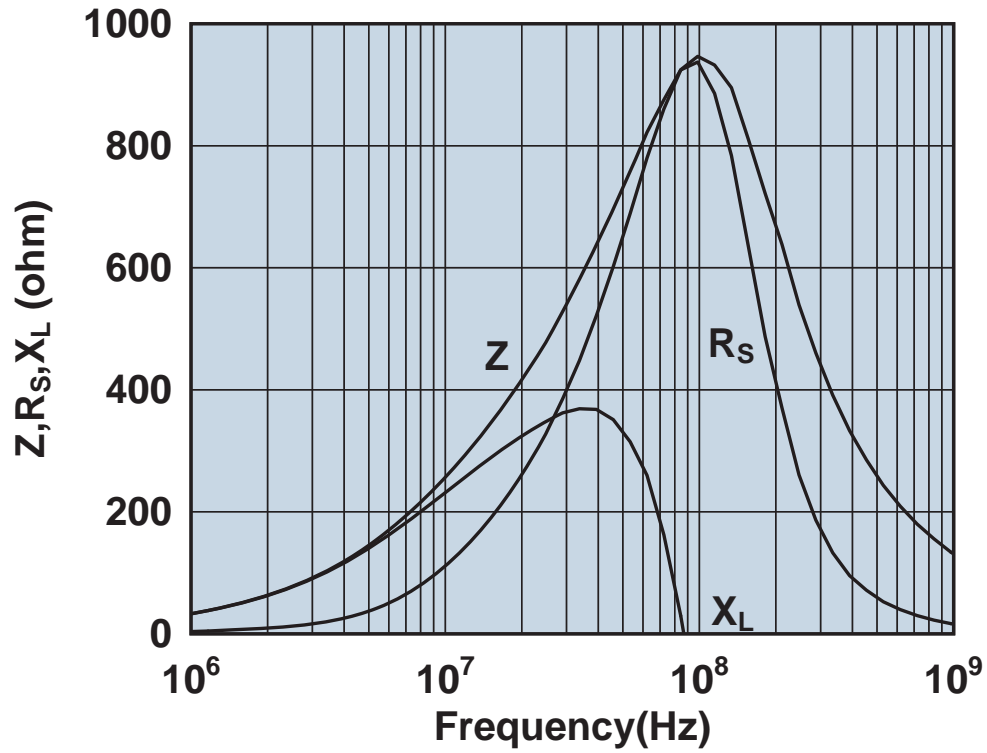

Impedance, reactance, and resistance vs. frequency.

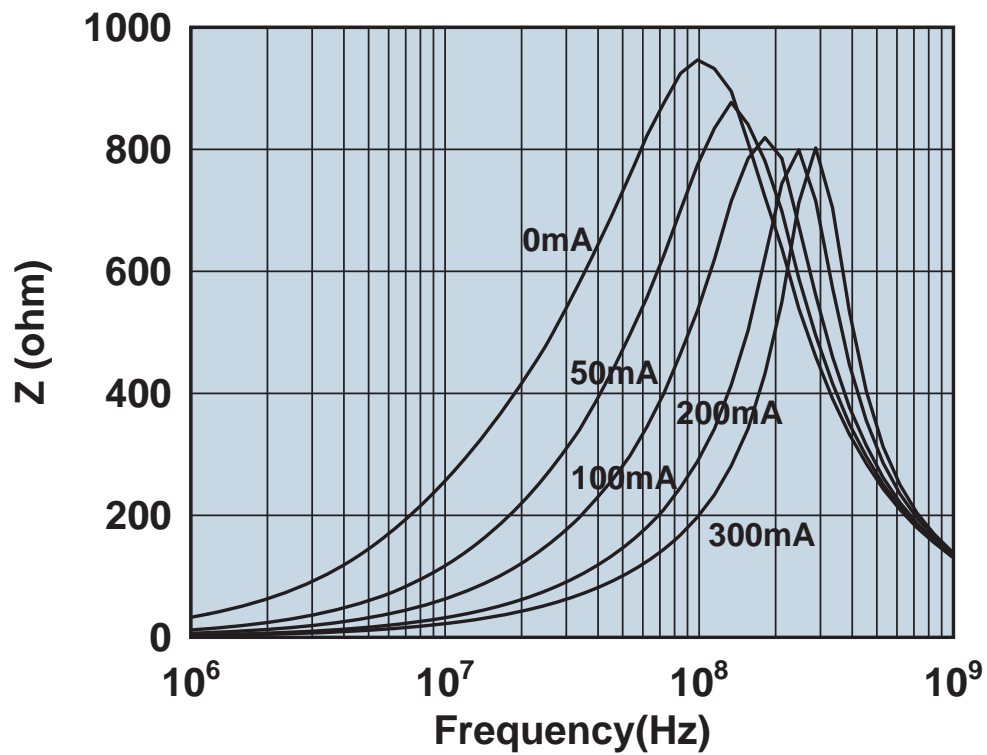

Impedance vs. frequency with dc bias.

2508051027Y1

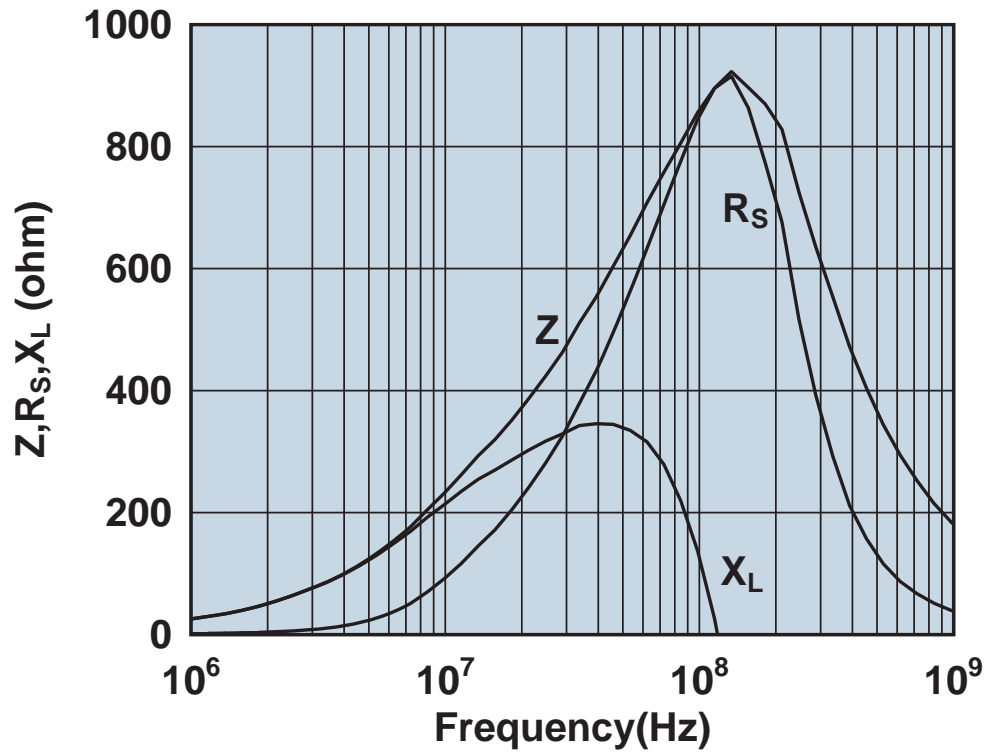

Impedance, reactance, and resistance vs. frequency.

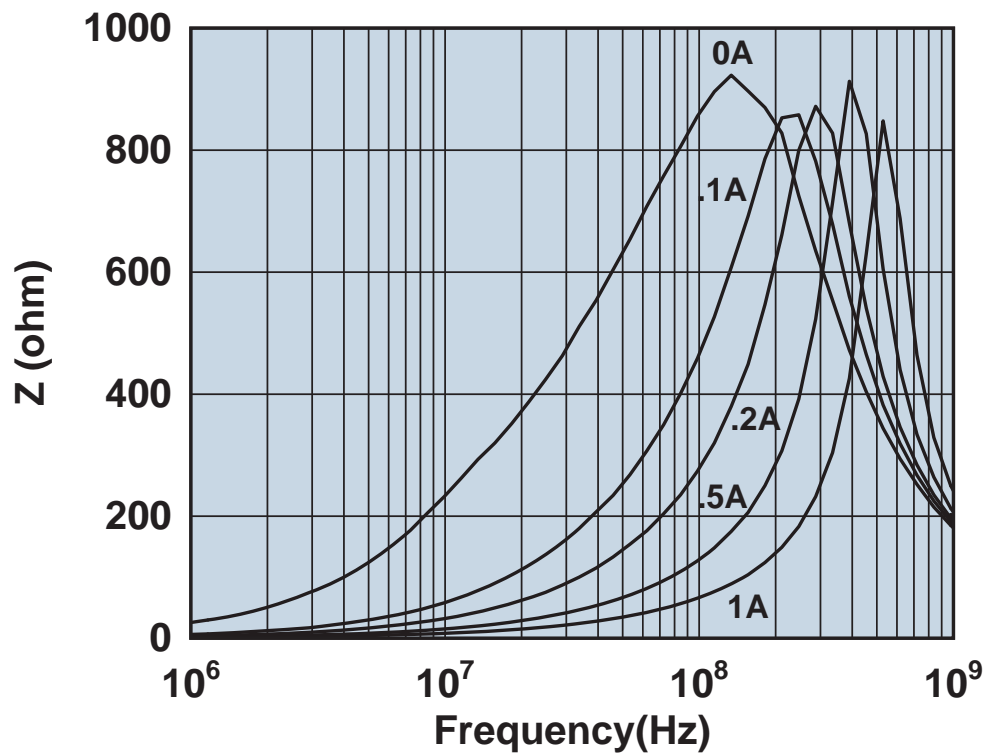

Impedance vs. frequency with dc bias.

2508051107Y0

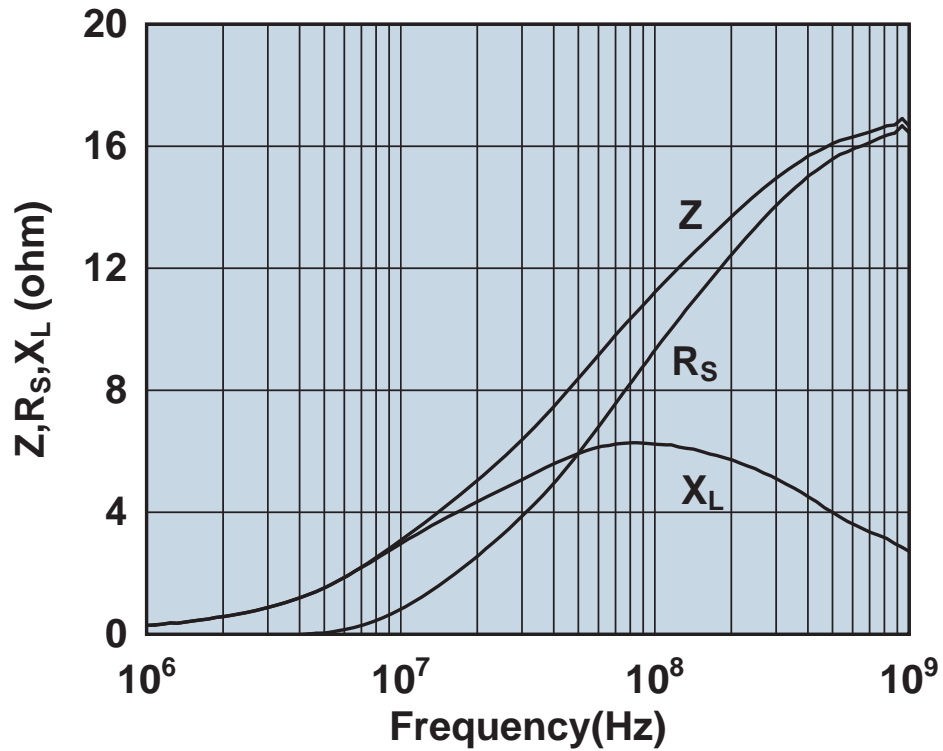

Impedance, reactance, and resistance vs. frequency.

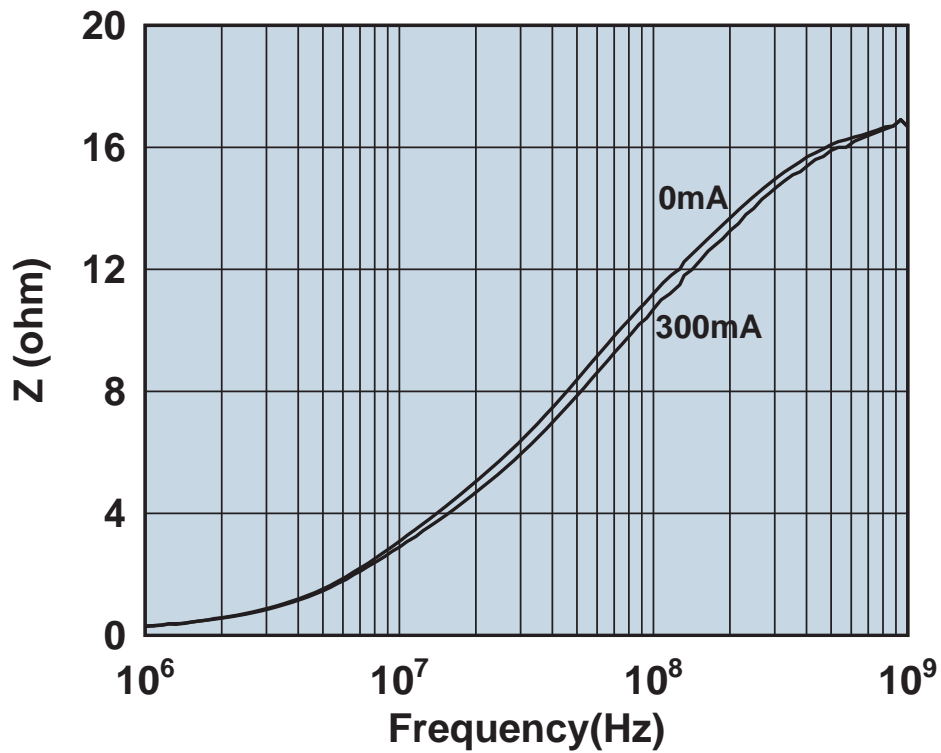

Impedance vs. frequency with dc bias.

2508051217Y0

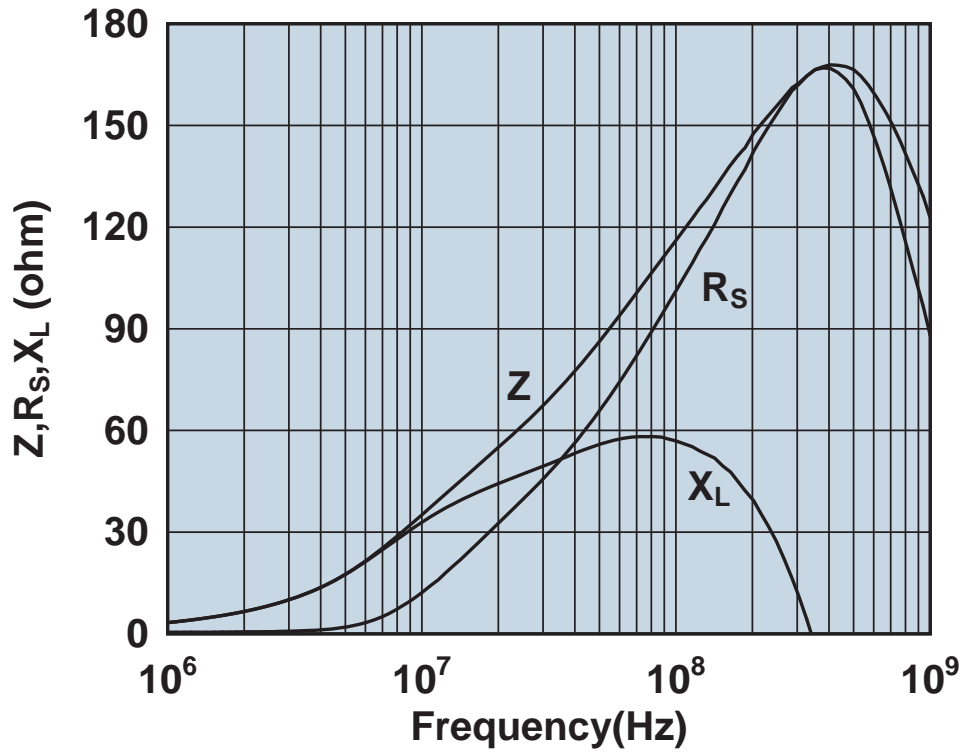

Impedance, reactance, and resistance vs. frequency.

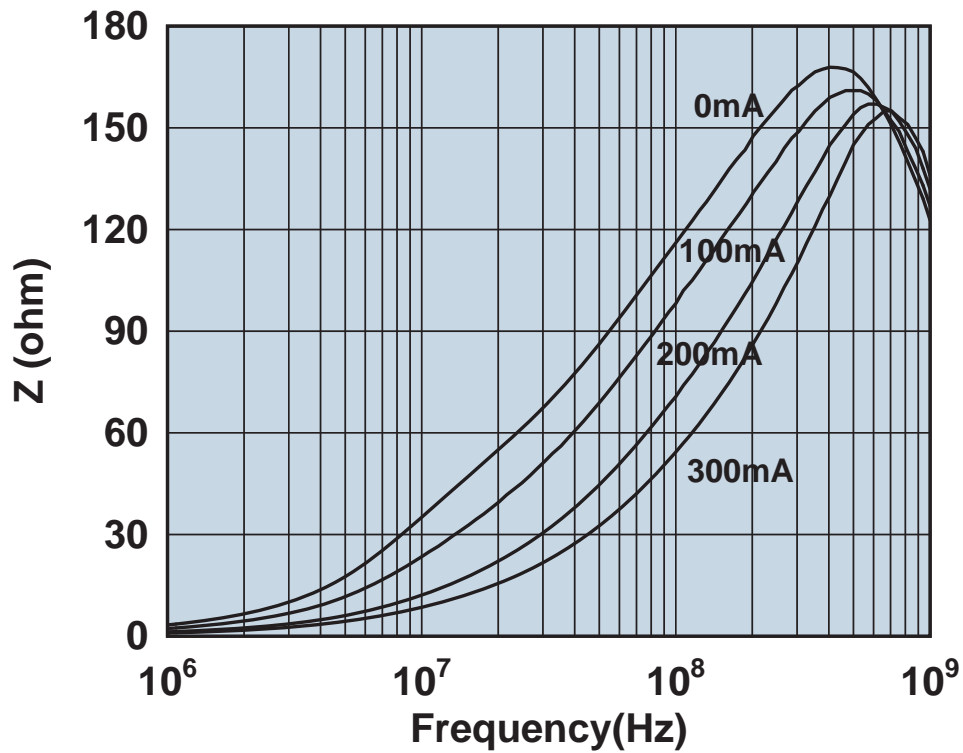

Impedance vs. frequency with dc bias.

2508051217Y3

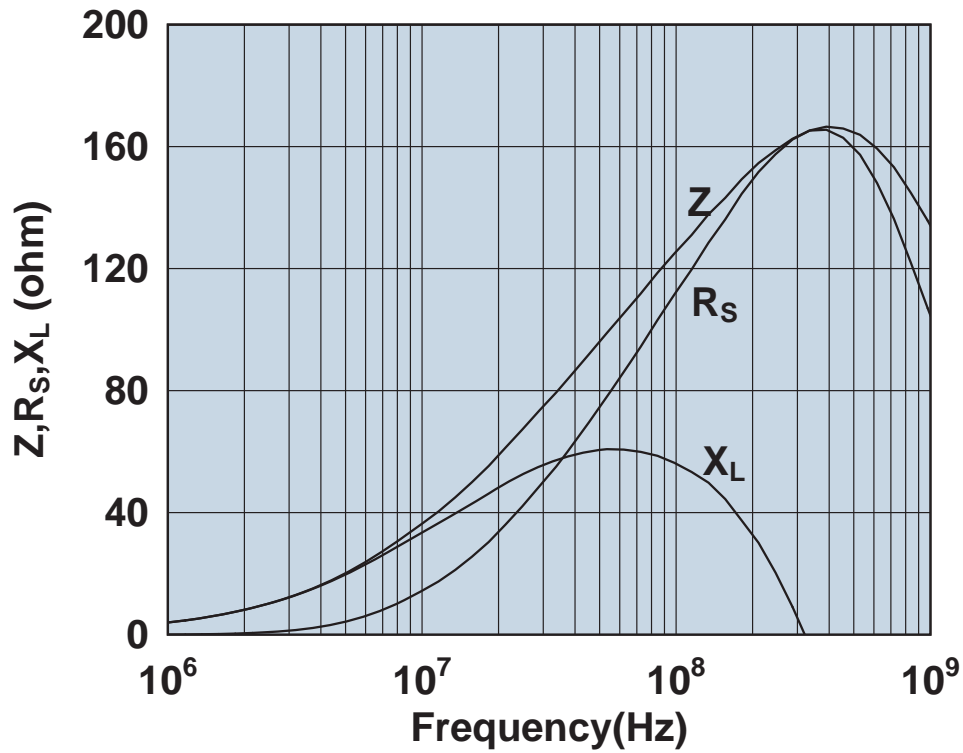

Impedance, reactance, and resistance vs. frequency.

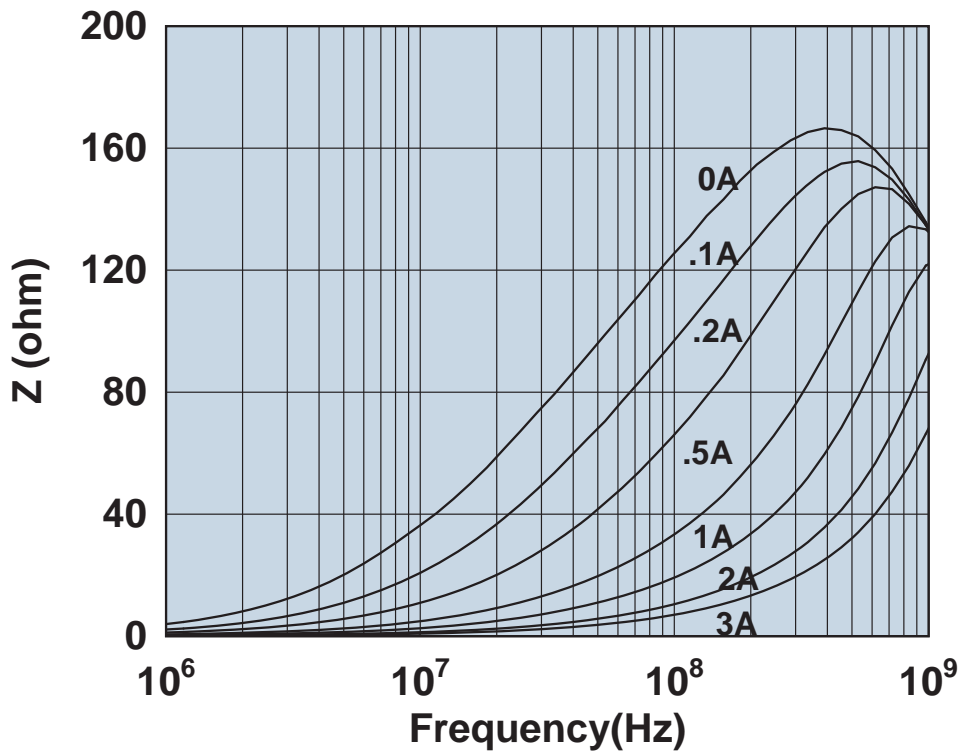

Impedance vs. frequency with dc bias.

2508051217Y6

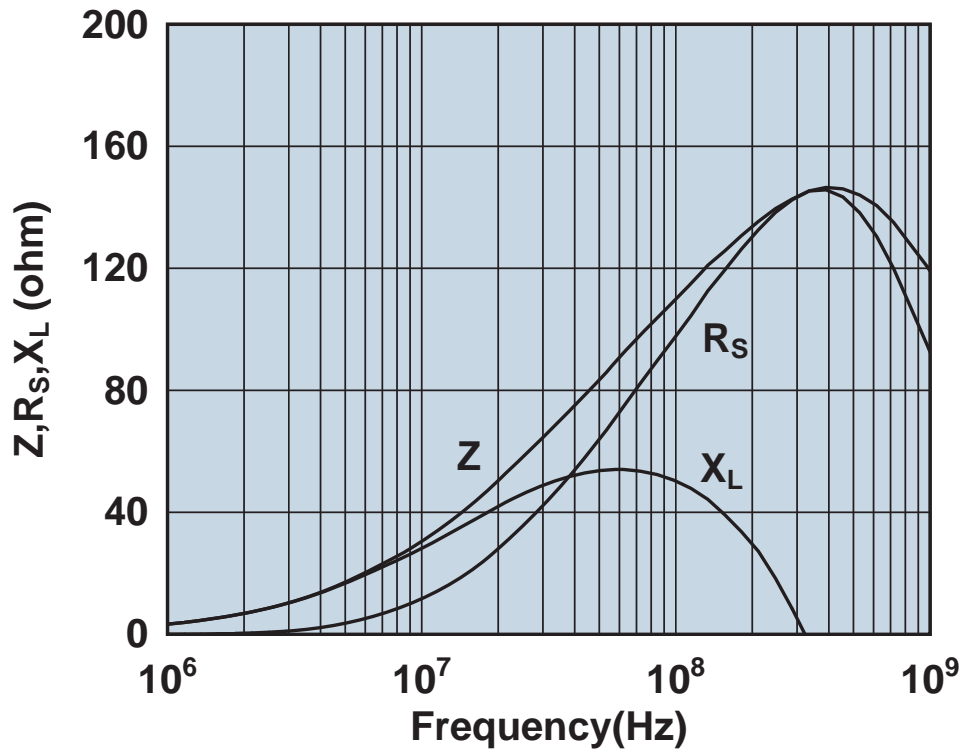

Impedance, reactance, and resistance vs. frequency.

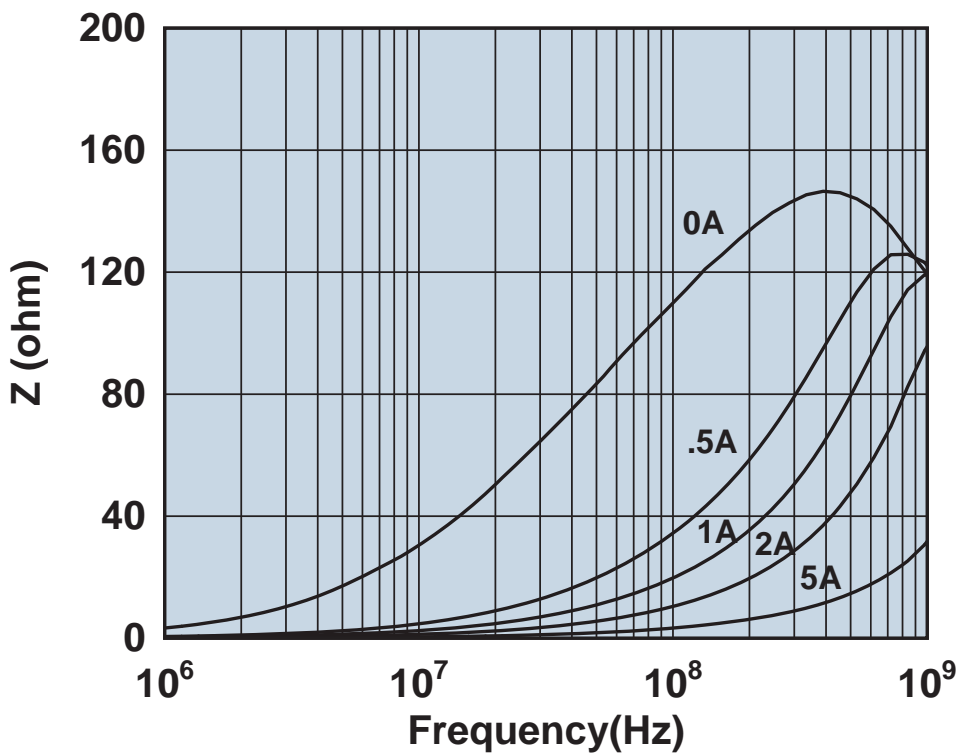

Impedance vs. frequency with dc bias.

2508051217Z0

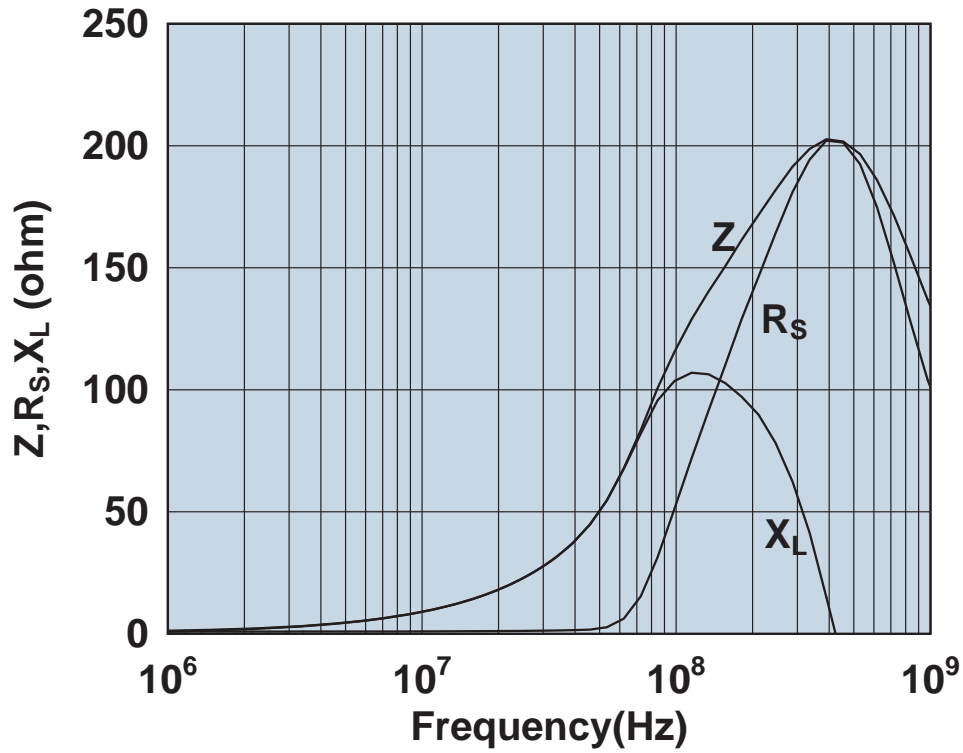

Impedance, reactance, and resistance vs. frequency.

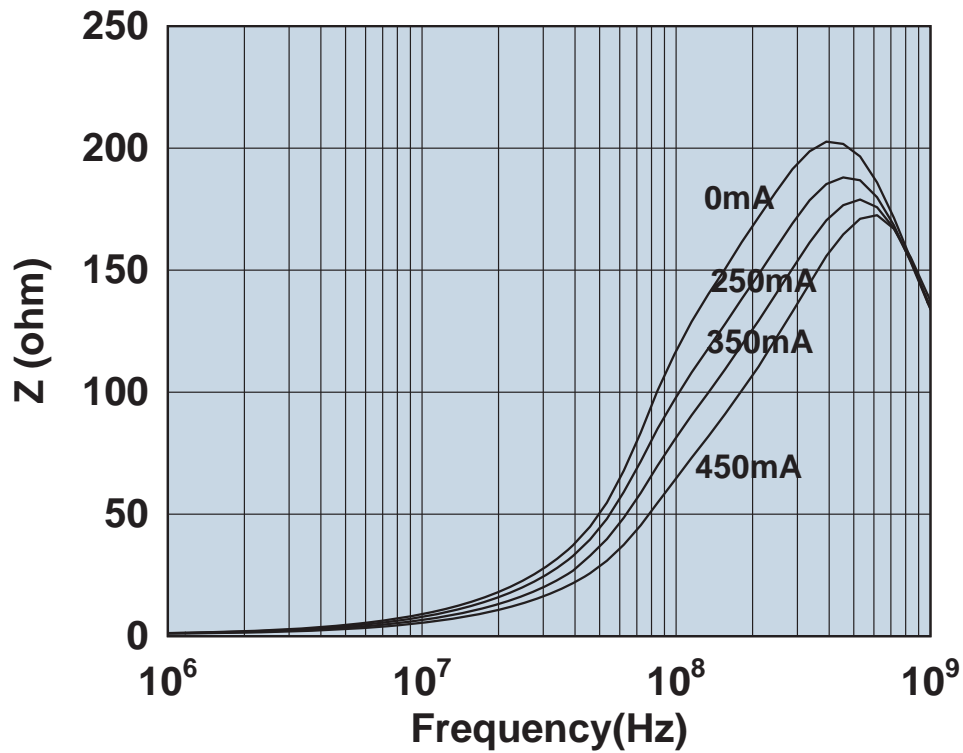

Impedance vs. frequency with dc bias.

2508051527Y0

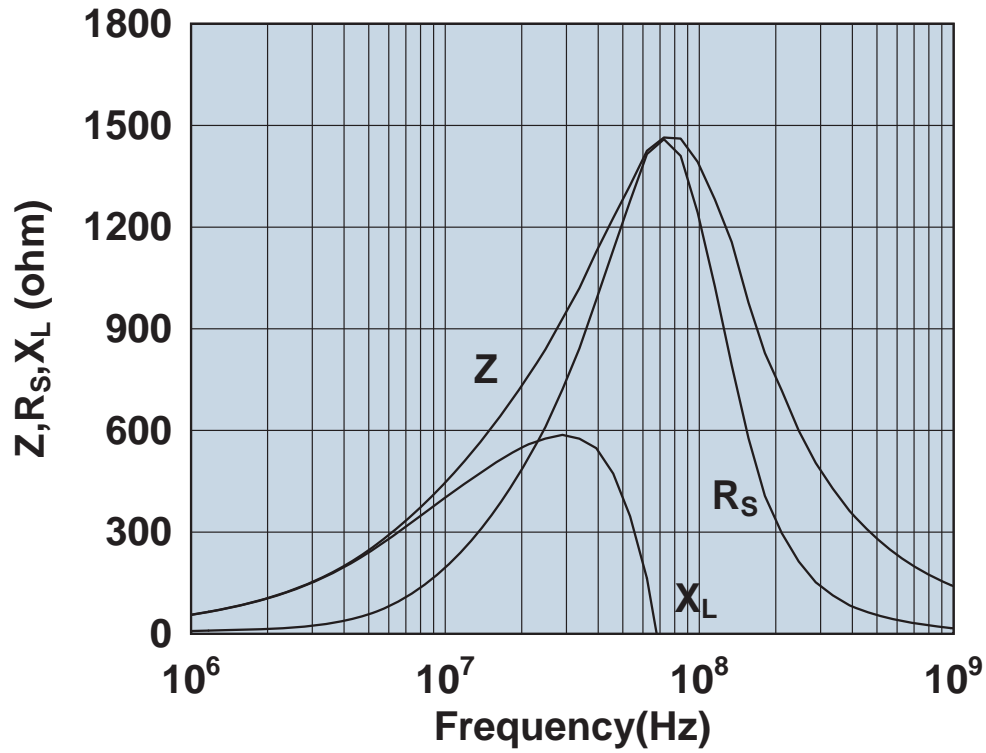

Impedance, reactance, and resistance vs. frequency.

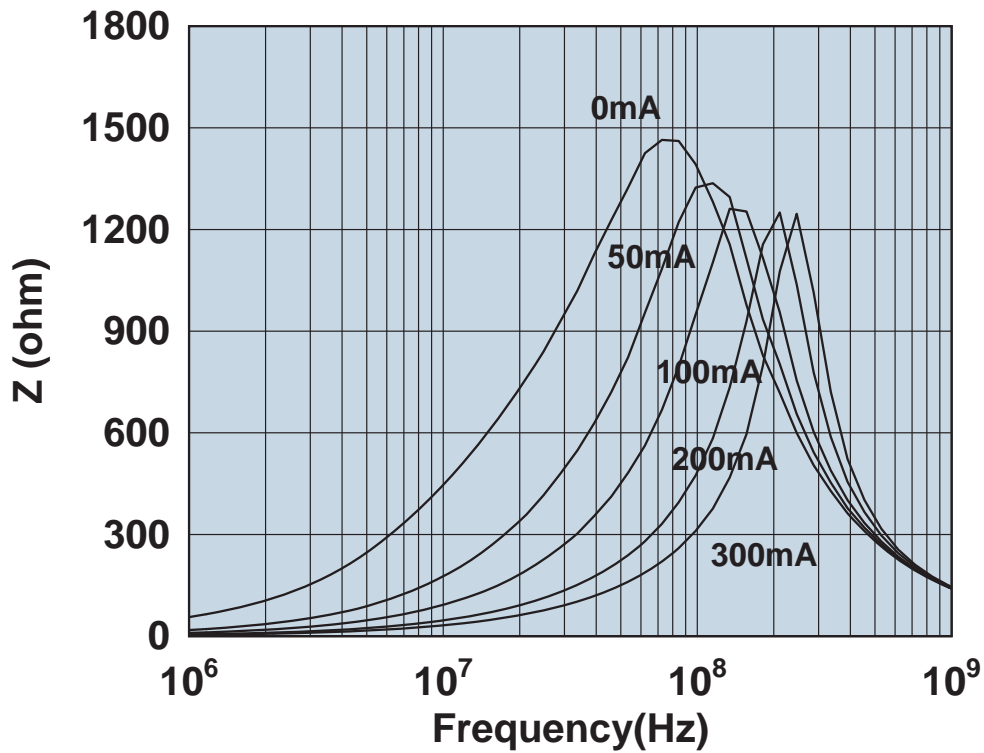

Impedance vs. frequency with dc bias.

2508051817Y0

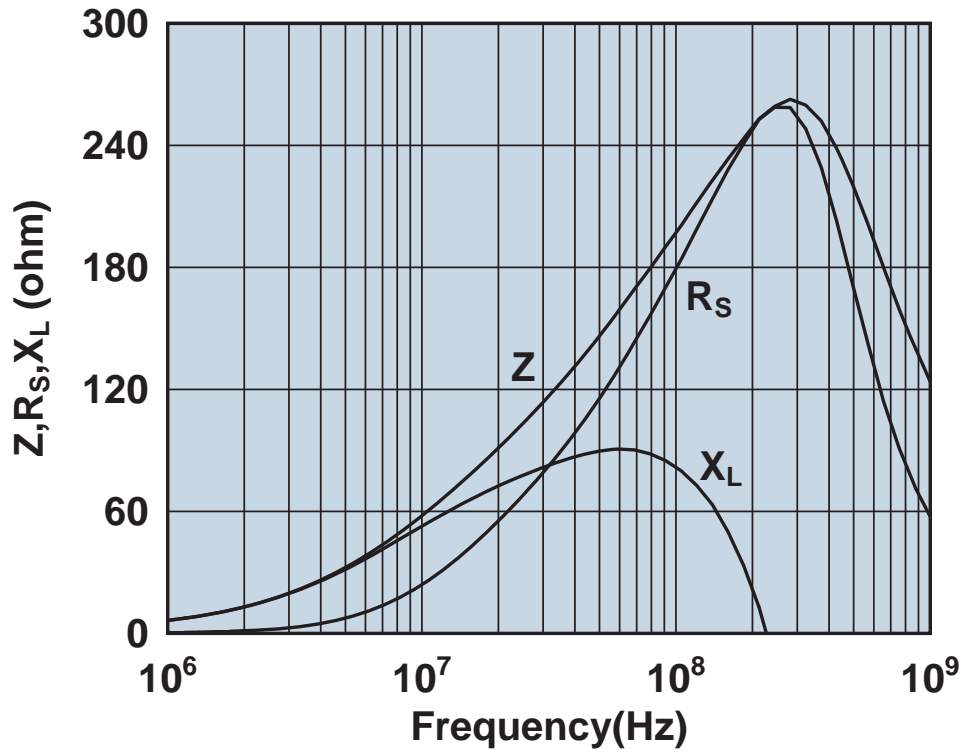

Impedance, reactance, and resistance vs. frequency.

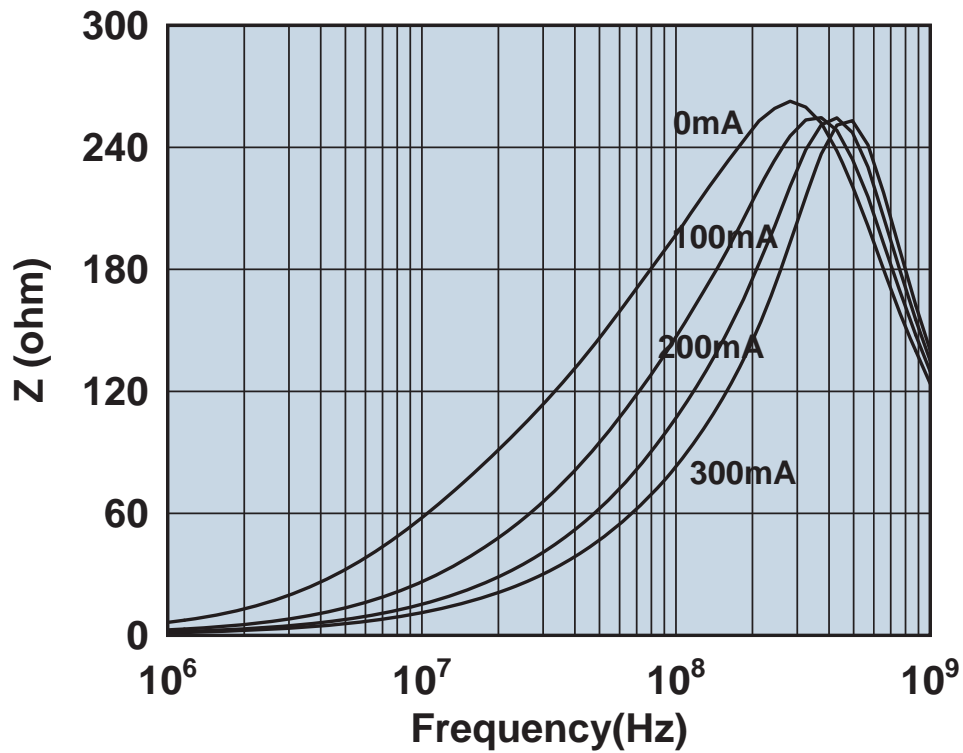

Impedance vs. frequency with dc bias.

2508052027Y1

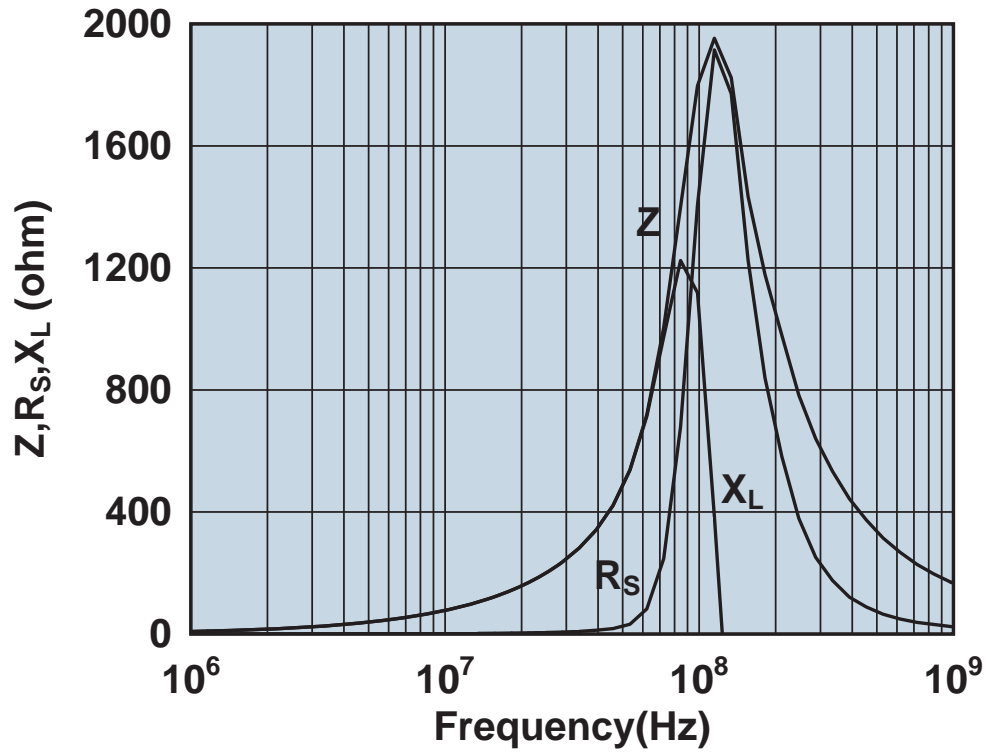

Impedance, reactance, and resistance vs. frequency.

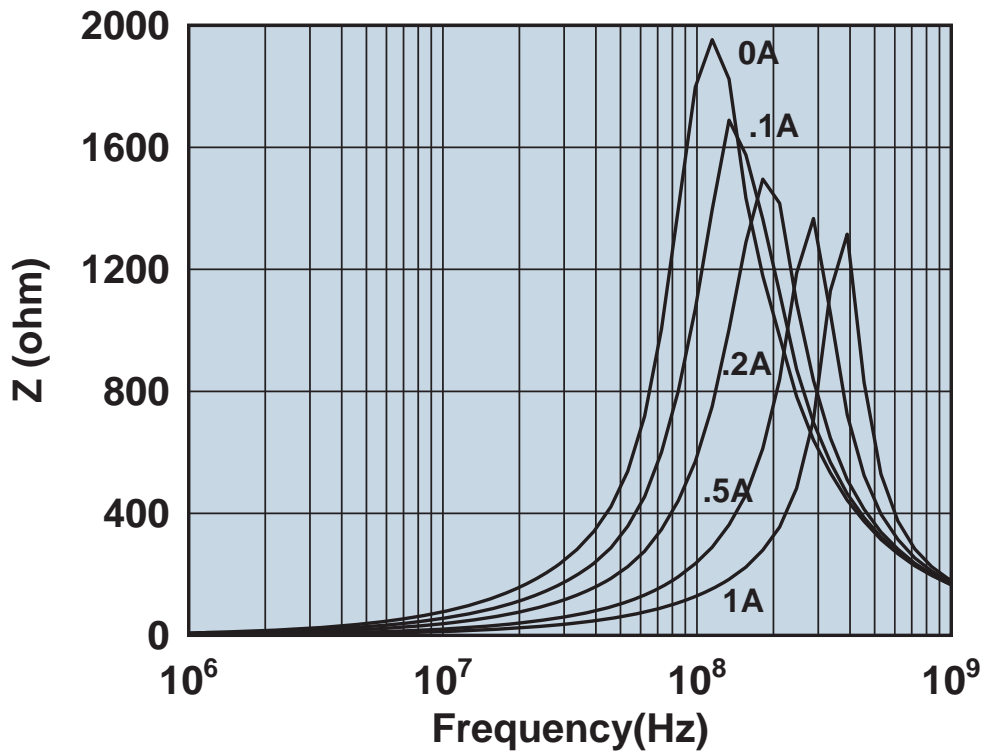

Impedance vs. frequency with dc bias.

2508052027Z0

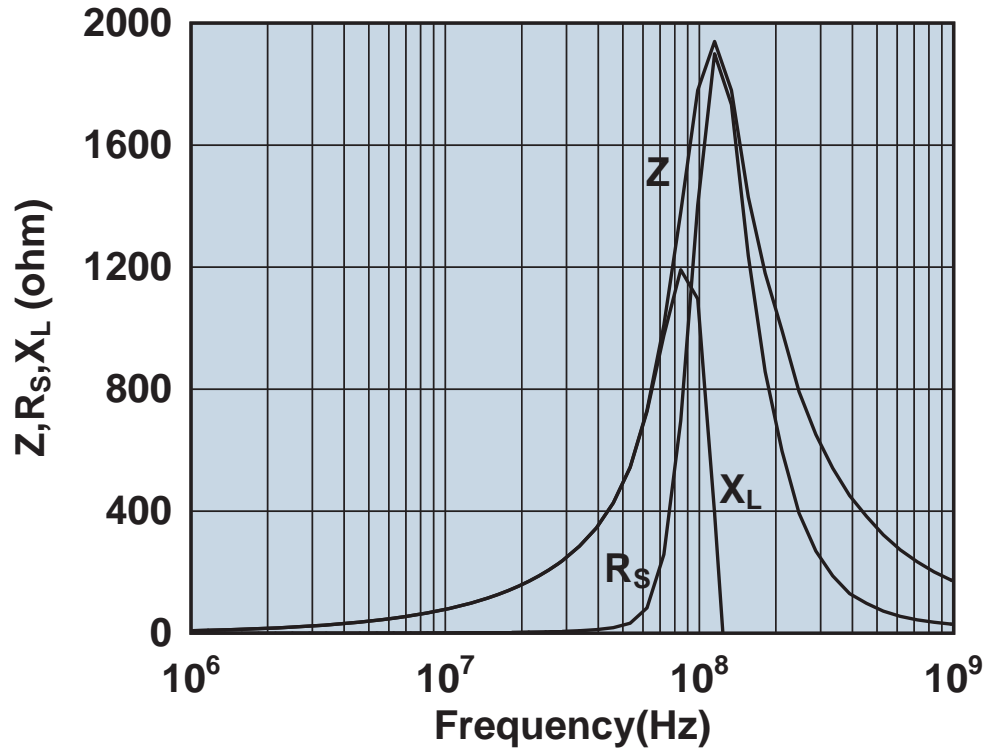

Impedance, reactance, and resistance vs. frequency.

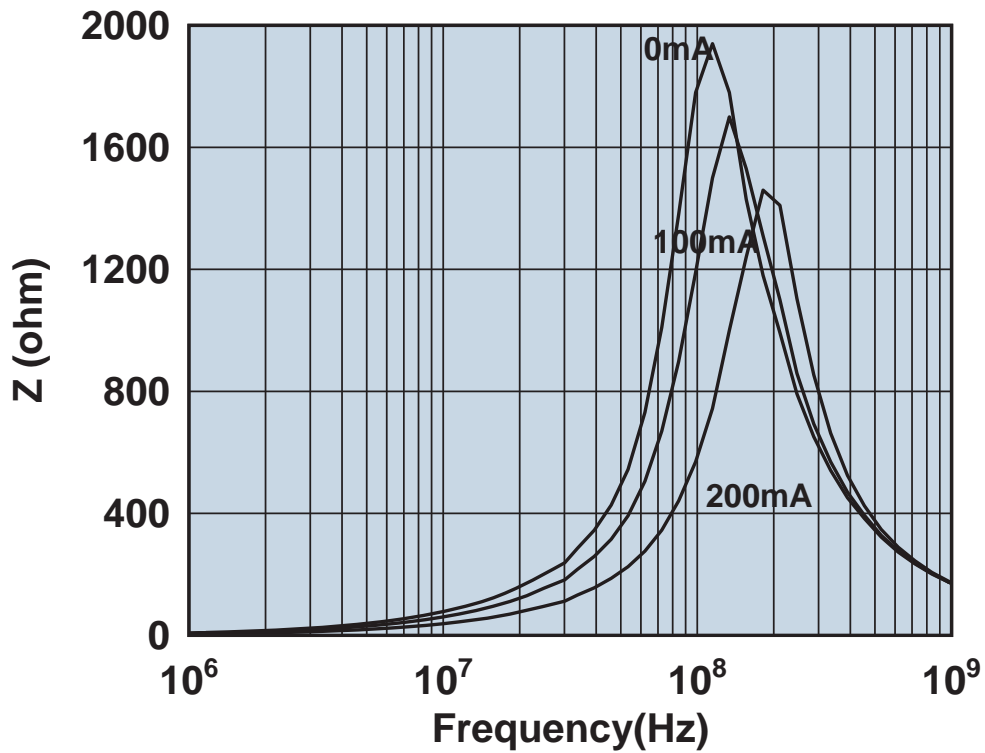

Impedance vs. frequency with dc bias.

2508053007Y0

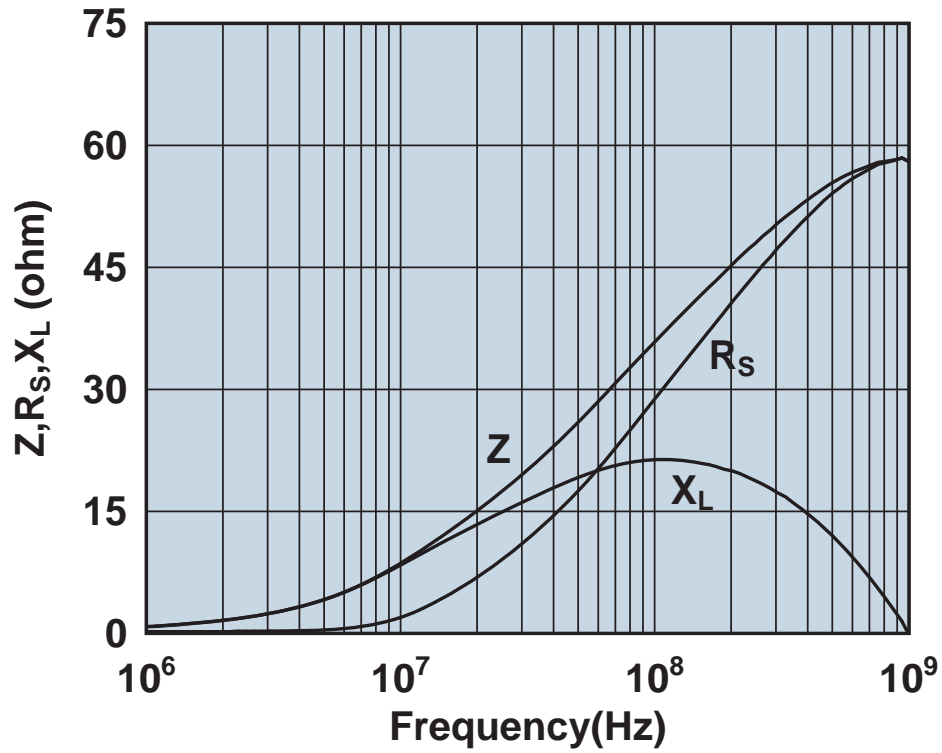

Impedance, reactance, and resistance vs. frequency.

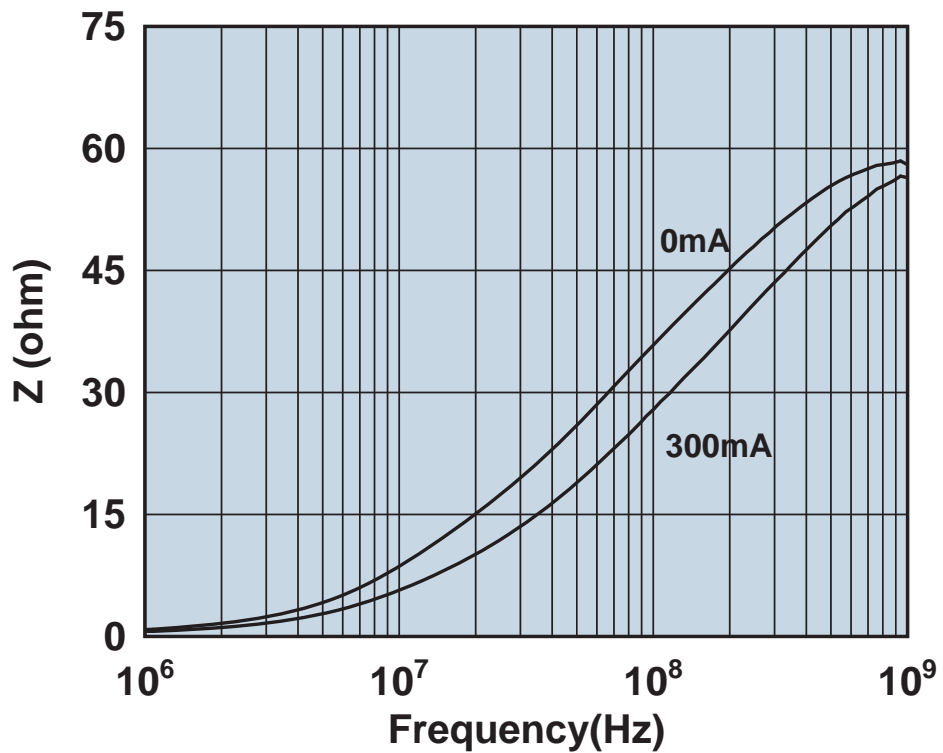

Impedance vs. frequency with dc bias.

2508053007Y3

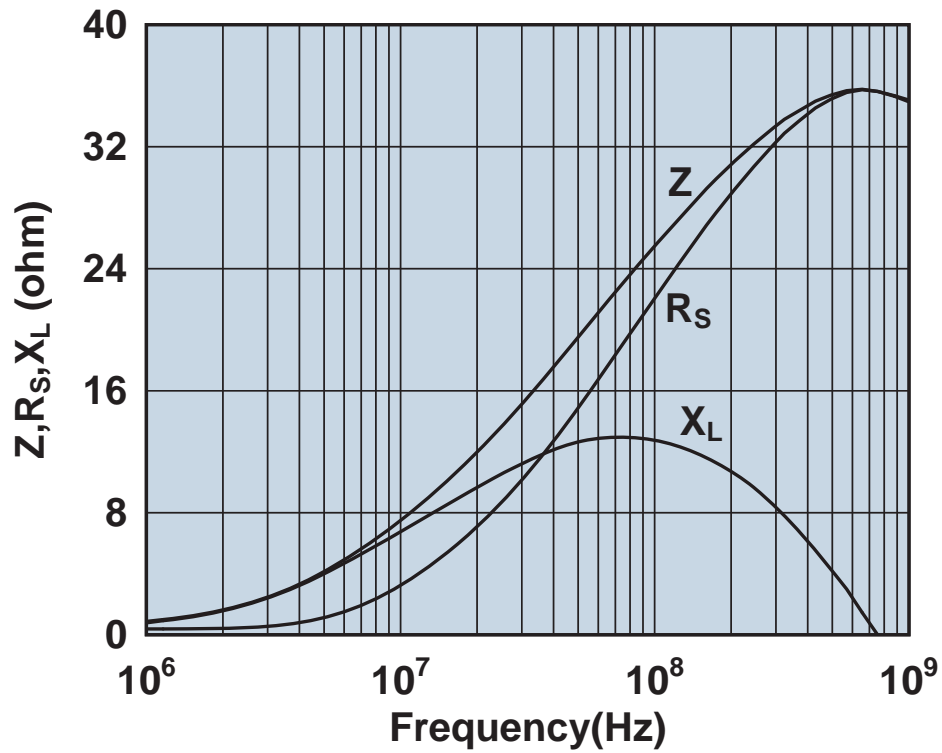

Impedance, reactance, and resistance vs. frequency.

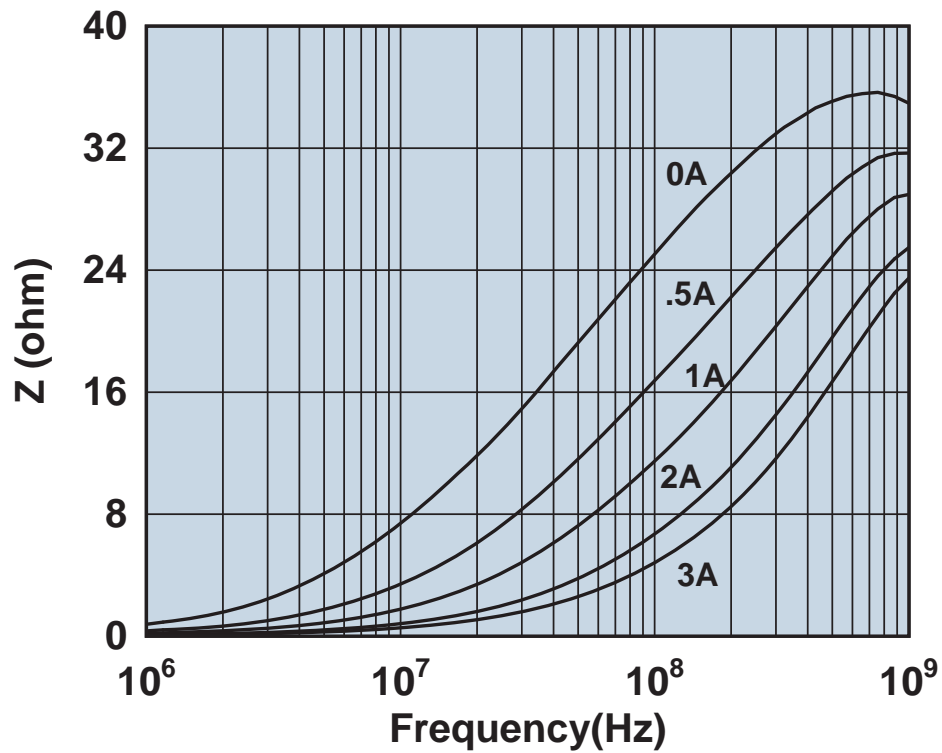

Impedance vs. frequency with dc bias.

2508053017Y0

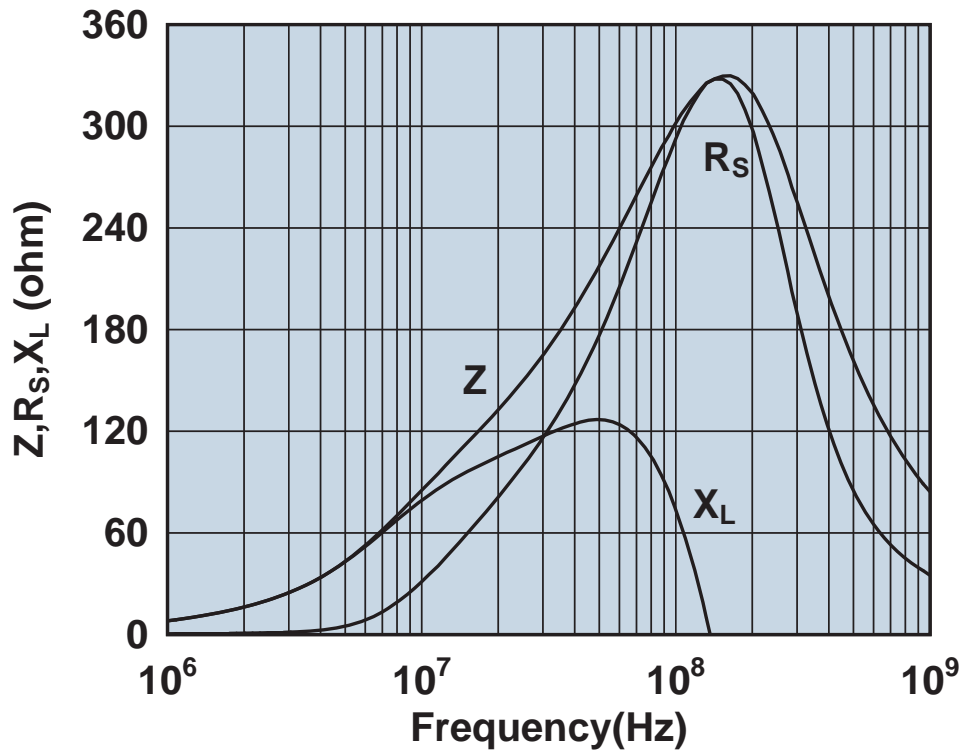

Impedance, reactance, and resistance vs. frequency.

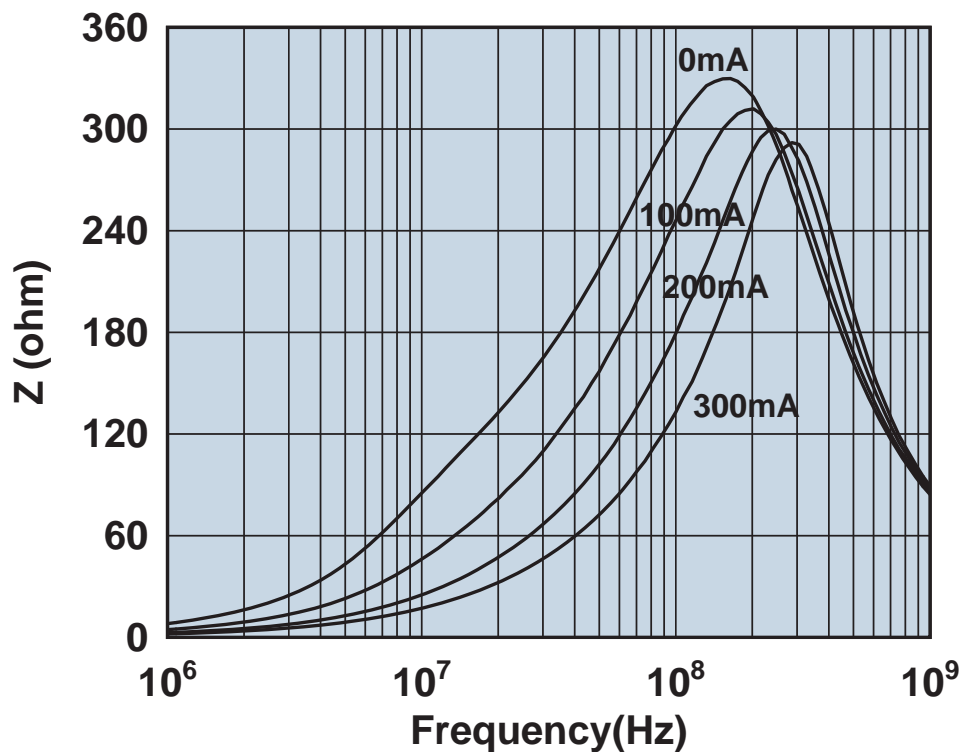

Impedance vs. frequency with dc bias.

2508053017Y3

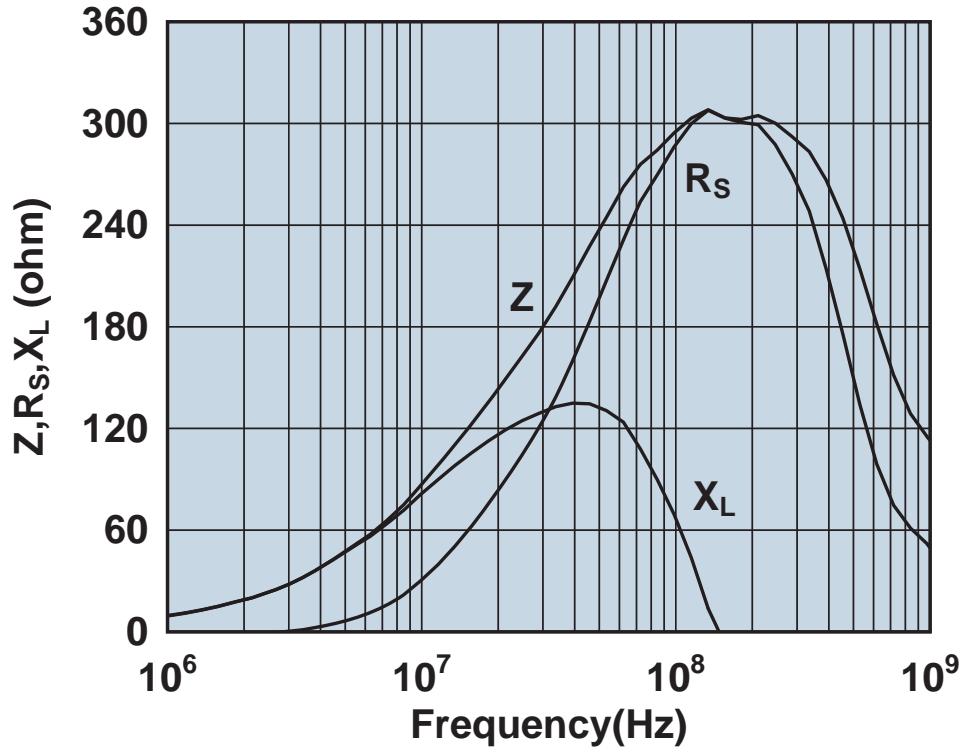

Impedance, reactance, and resistance vs. frequency.

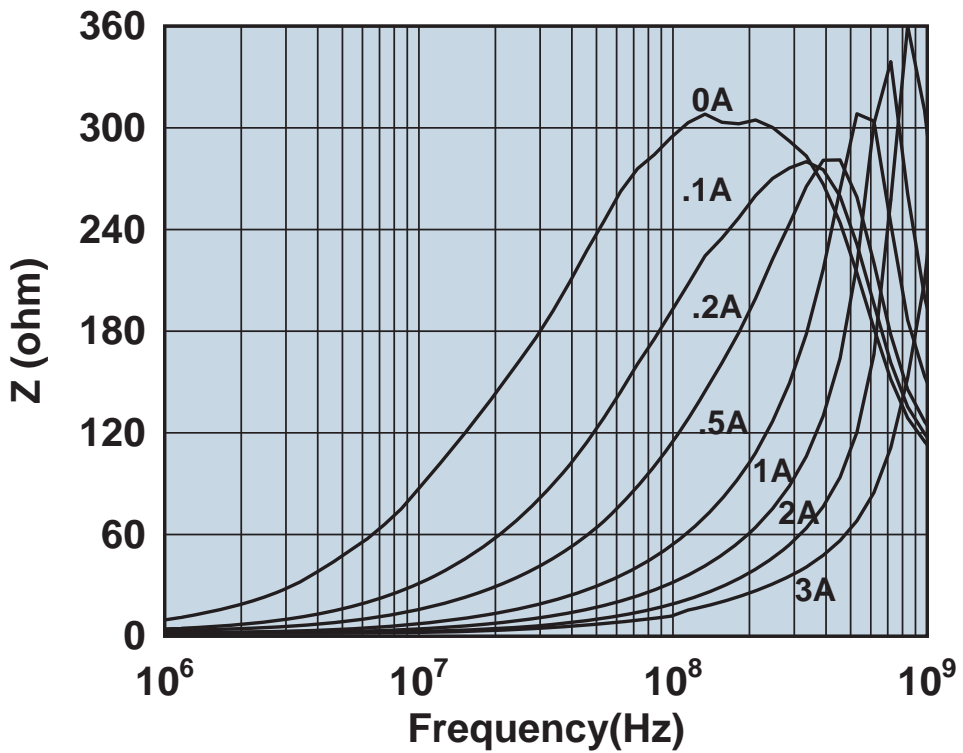

Impedance vs. frequency with dc bias.

2508053017Z0

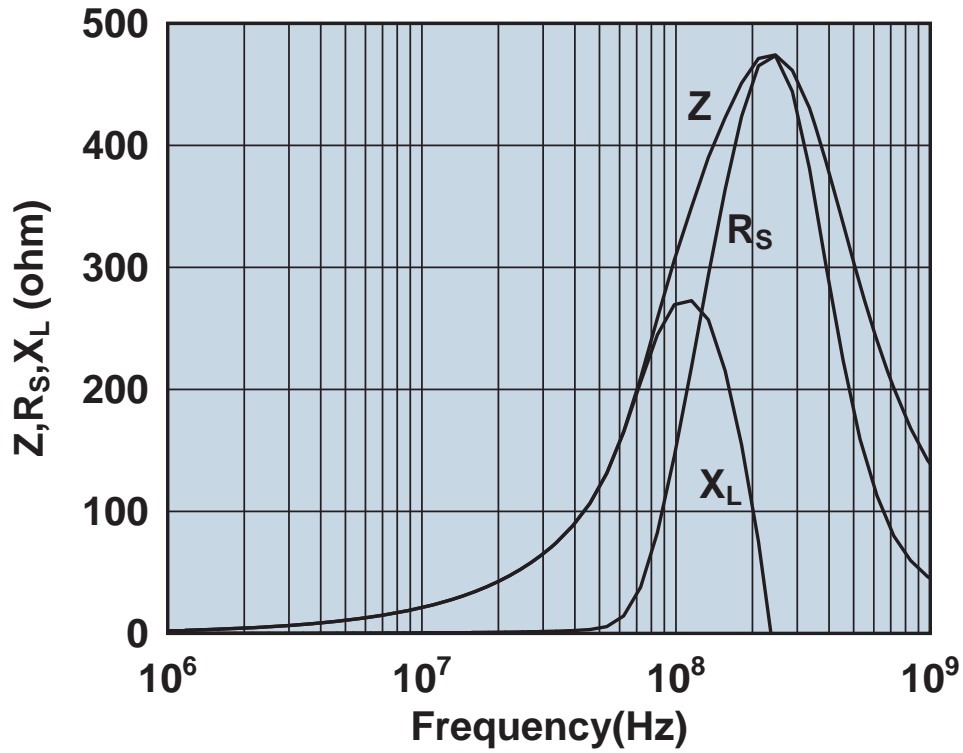

Impedance, reactance, and resistance vs. frequency.

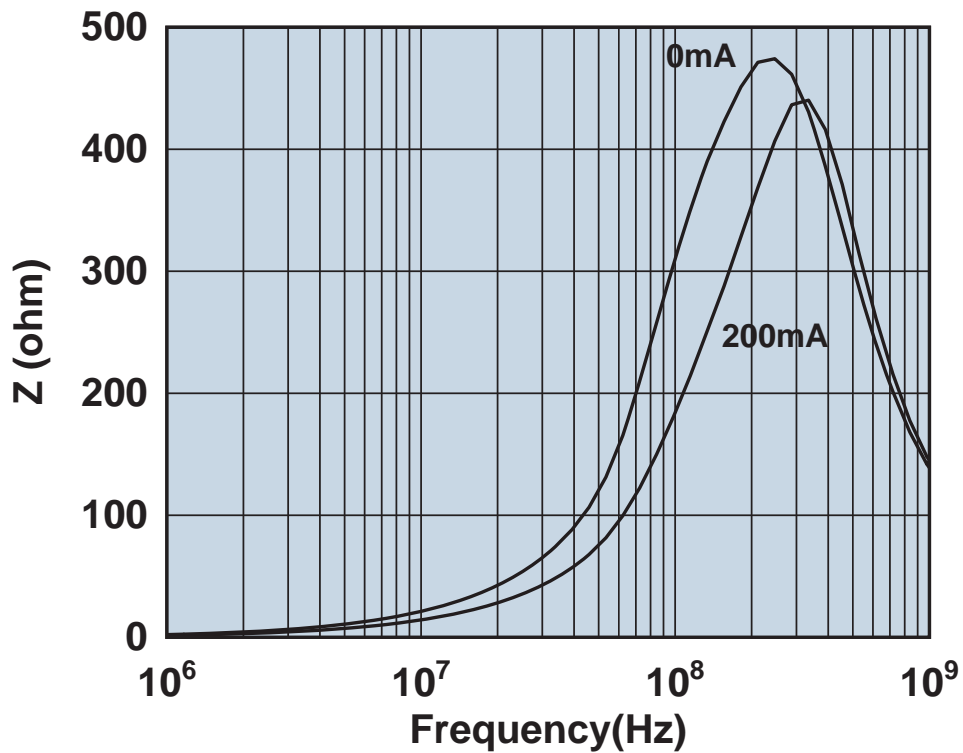

Impedance vs. frequency with dc bias.

2508055007Y0

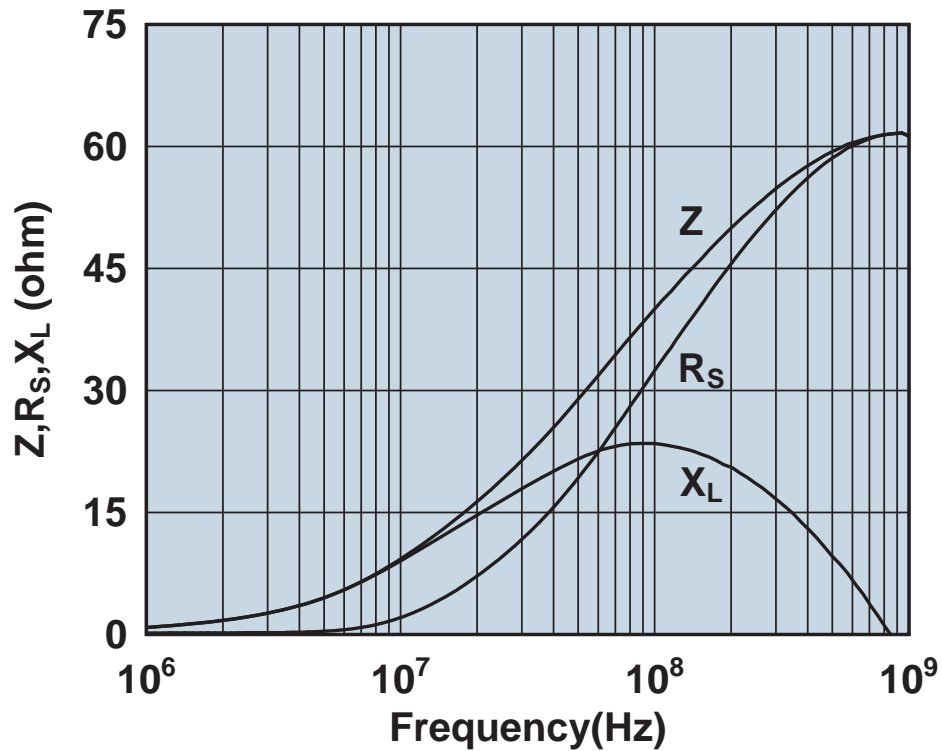

Impedance, reactance, and resistance vs. frequency.

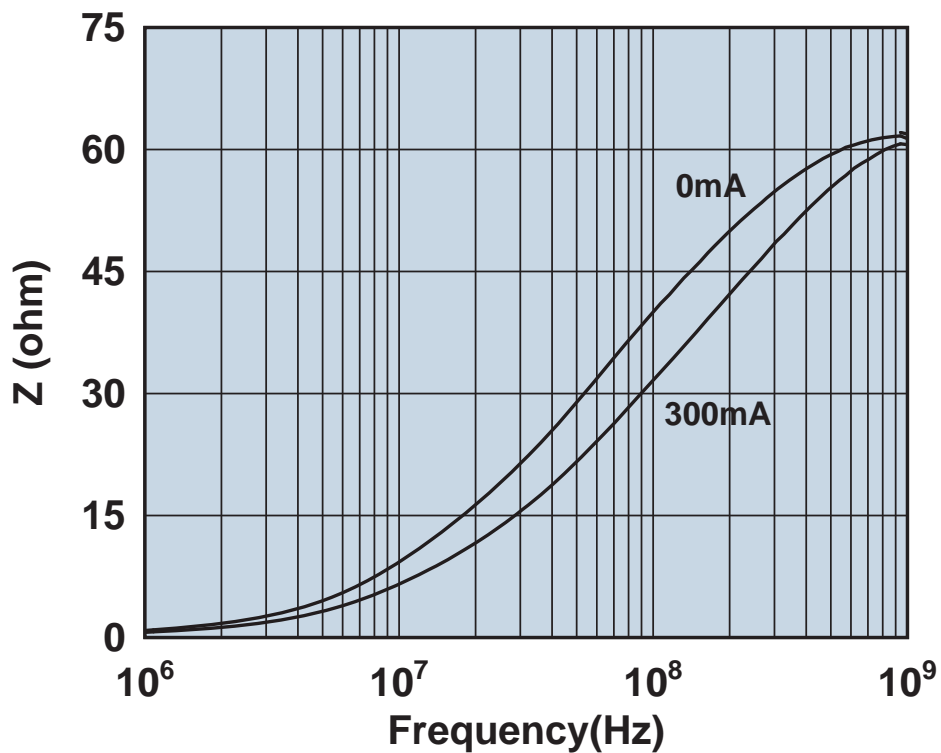

Impedance vs. frequency with dc bias.

2508056007Y0

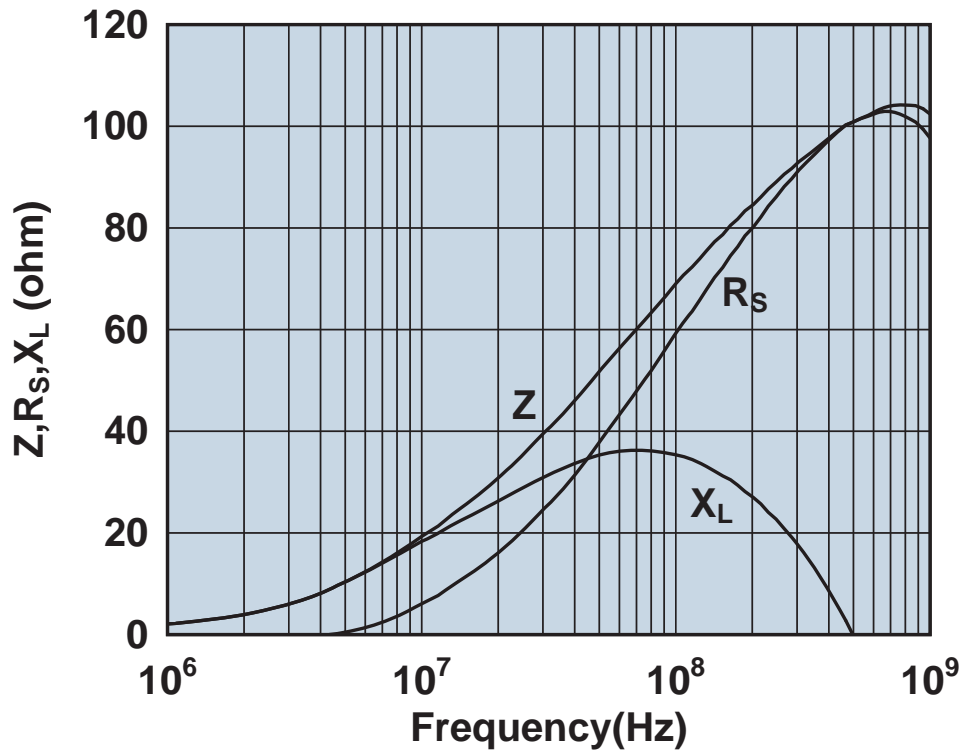

Impedance, reactance, and resistance vs. frequency.

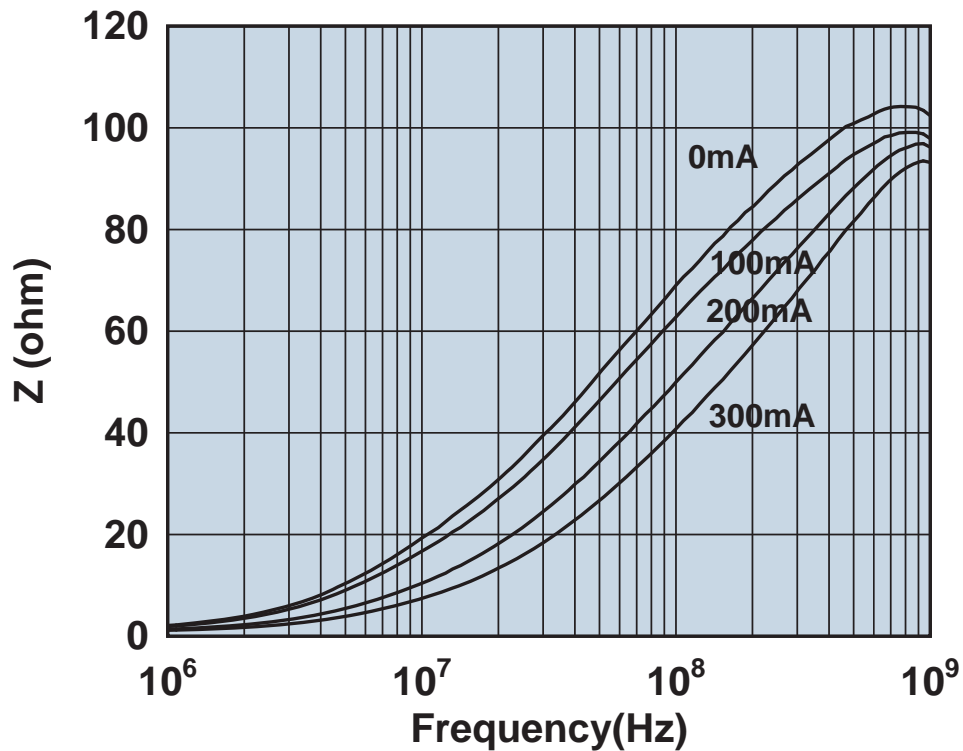

Impedance vs. frequency with dc bias.

2508056007Y3

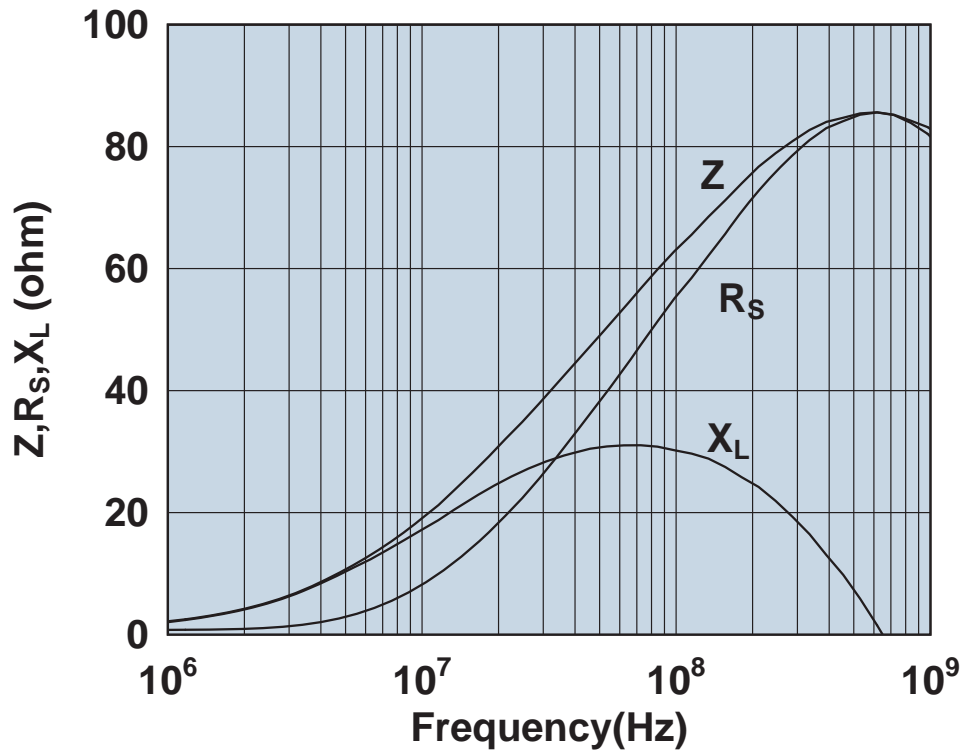

Impedance, reactance, and resistance vs. frequency.

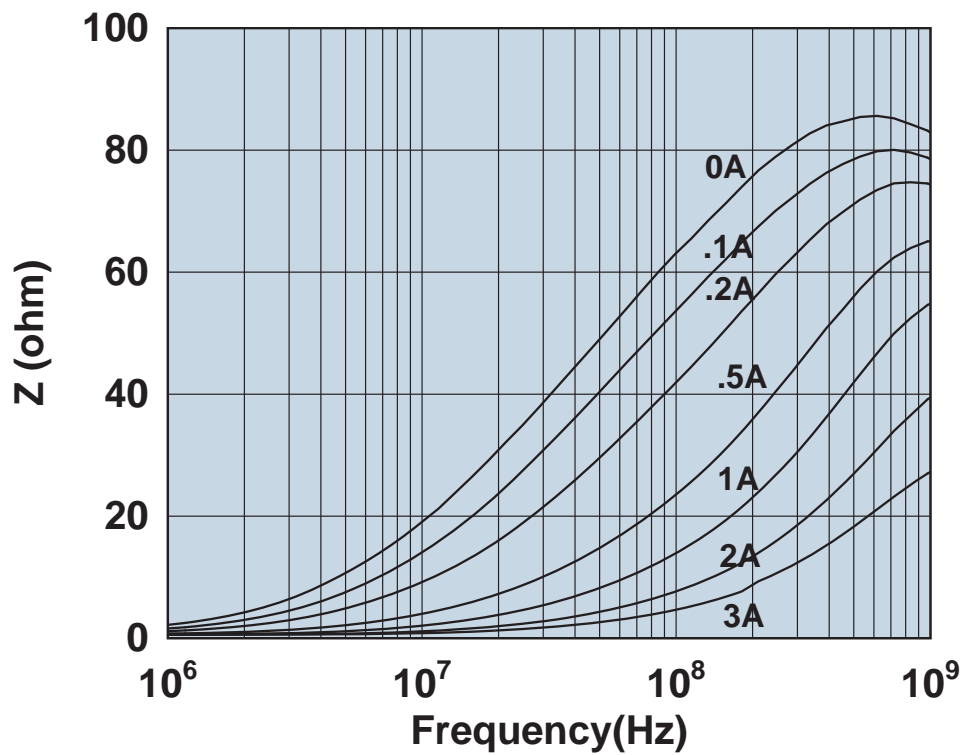

Impedance vs. frequency with dc bias.

2508056007Y6

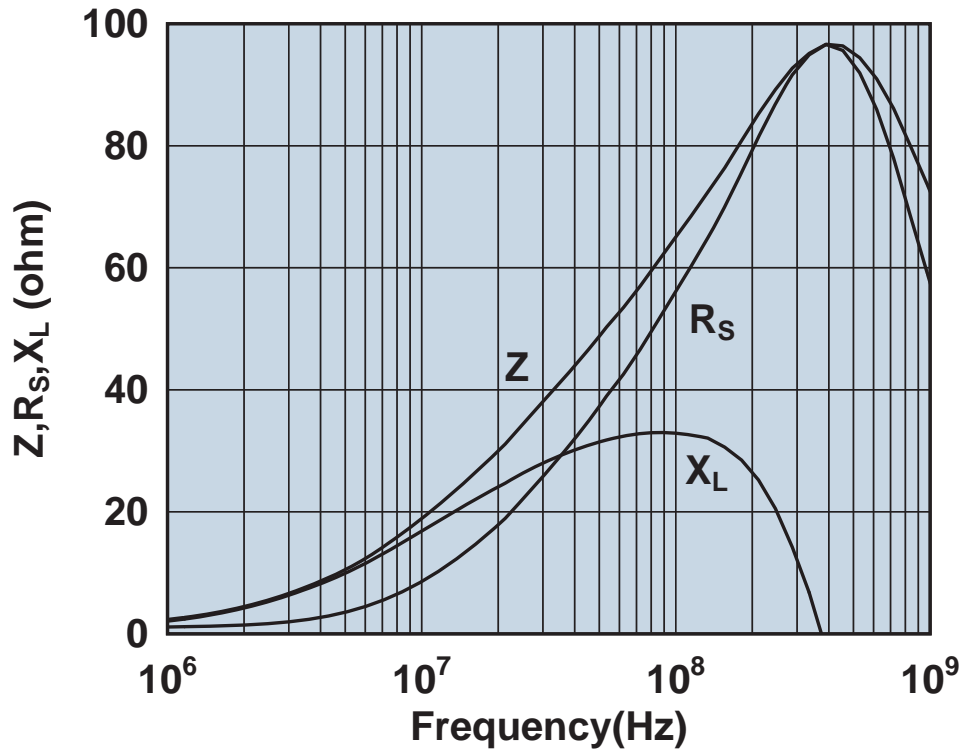

Impedance, reactance, and resistance vs. frequency.

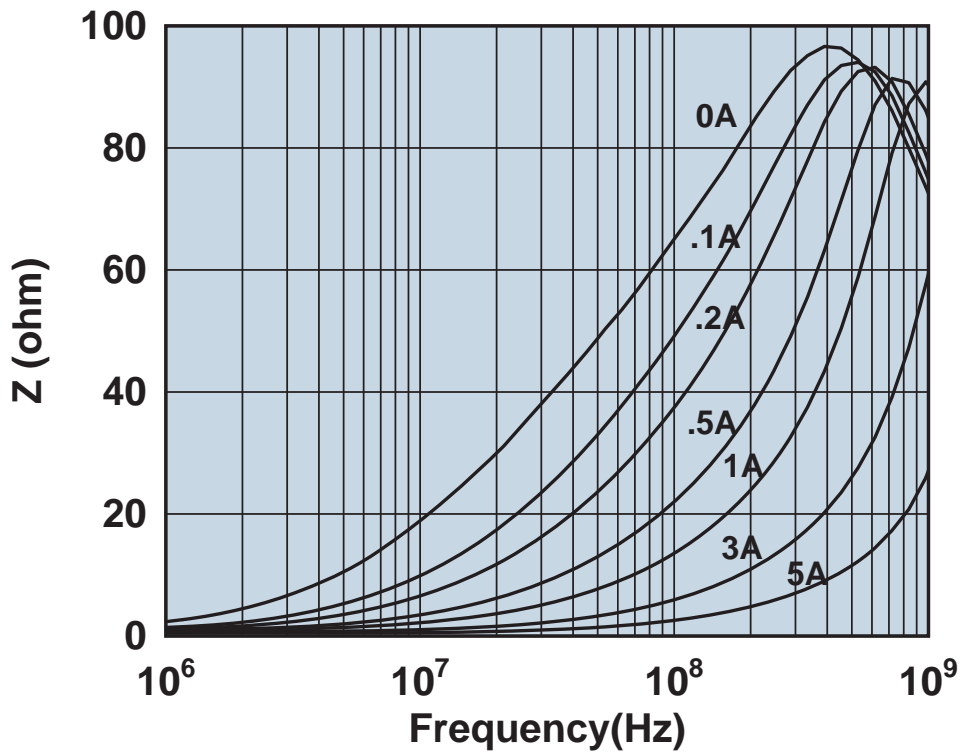

Impedance vs. frequency with dc bias.

2508056007Z0

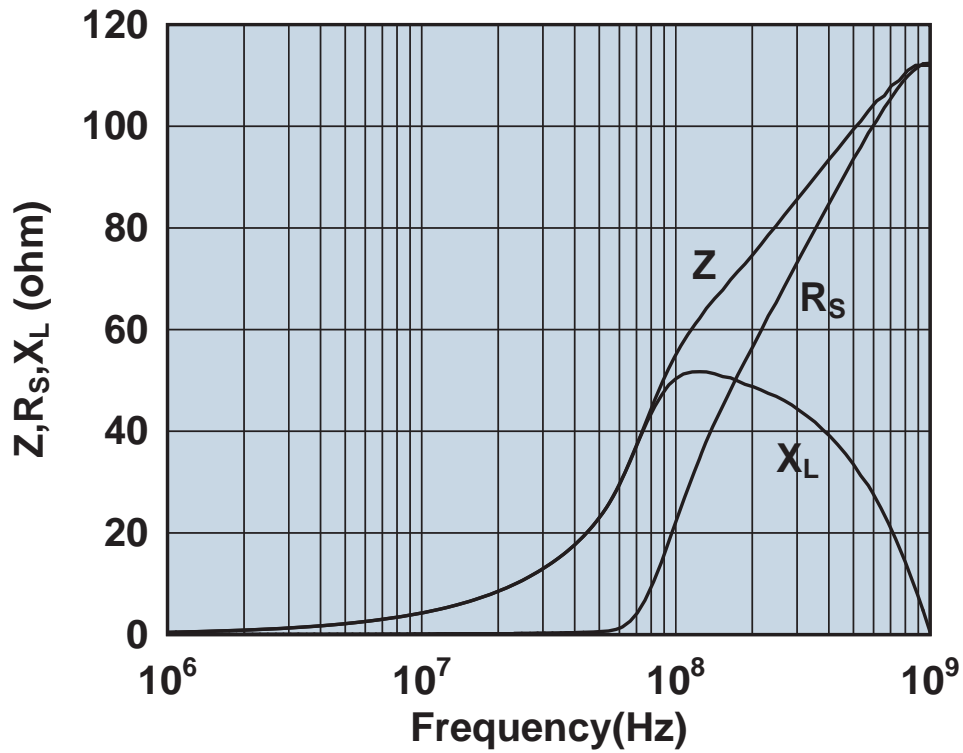

Impedance, reactance, and resistance vs. frequency.

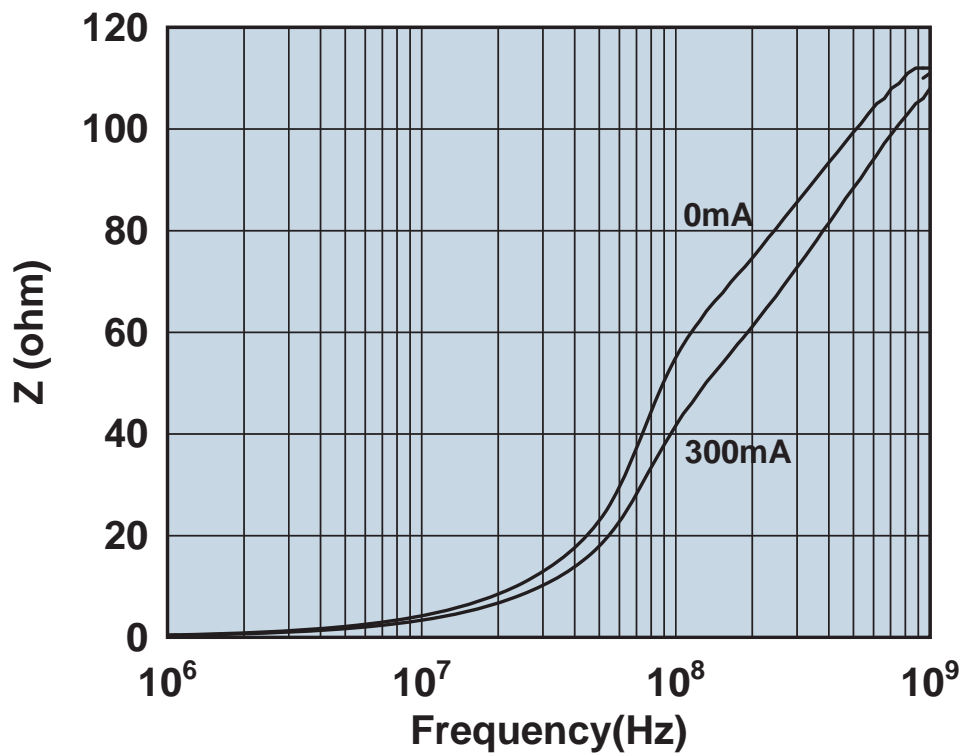

Impedance vs. frequency with dc bias.

2508056017Y0

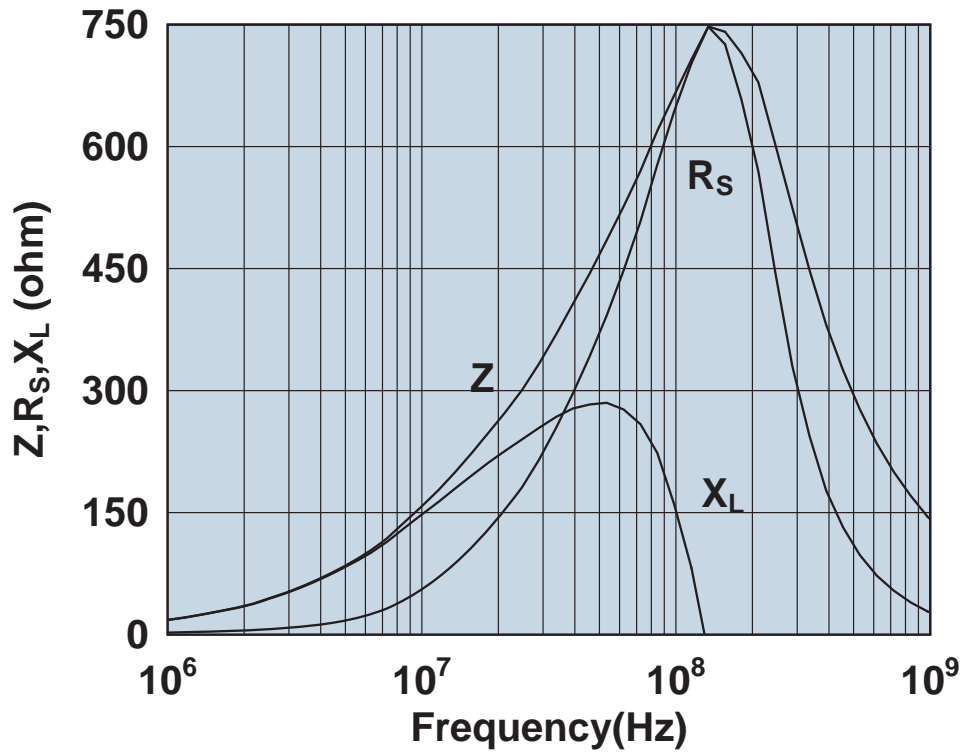

Impedance, reactance, and resistance vs. frequency.

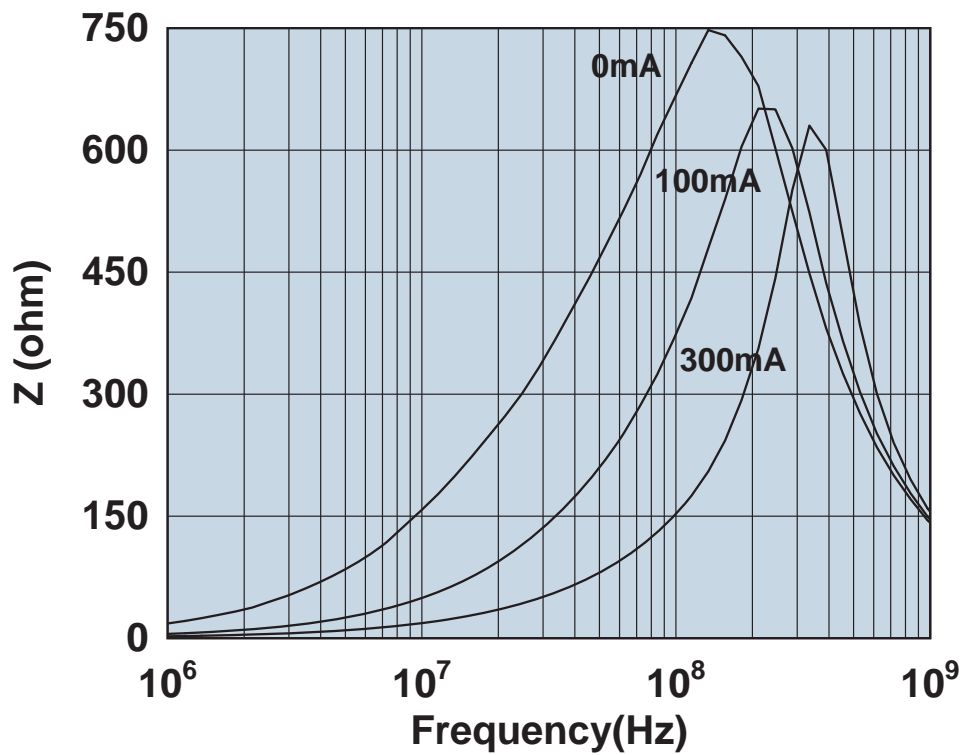

Impedance vs. frequency with dc bias.

2508056017Y2

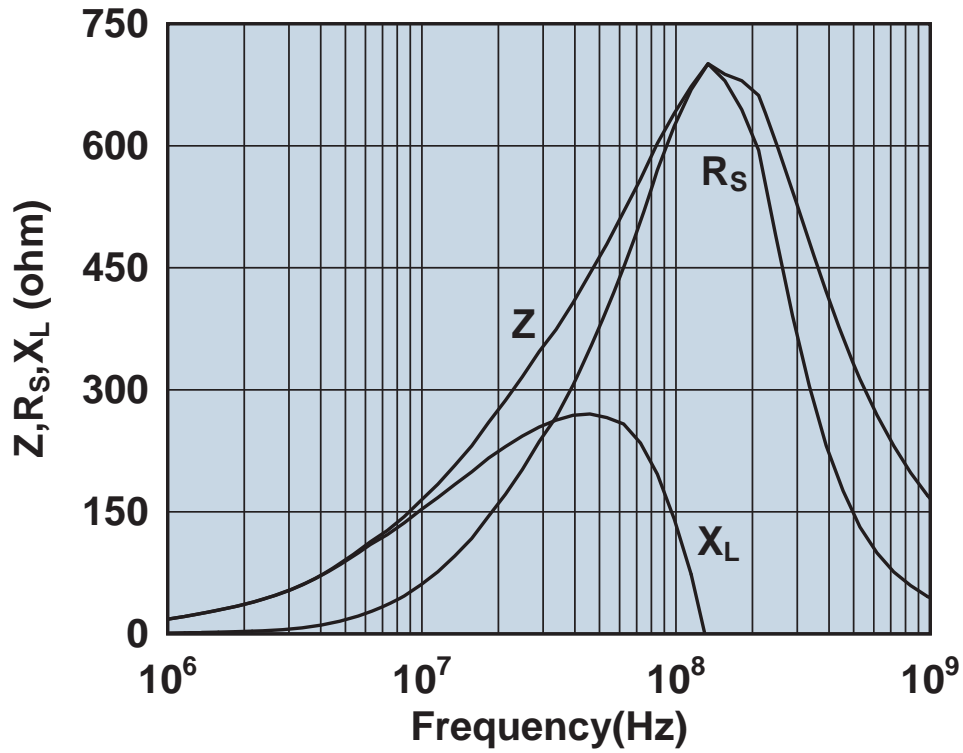

Impedance, reactance, and resistance vs. frequency.

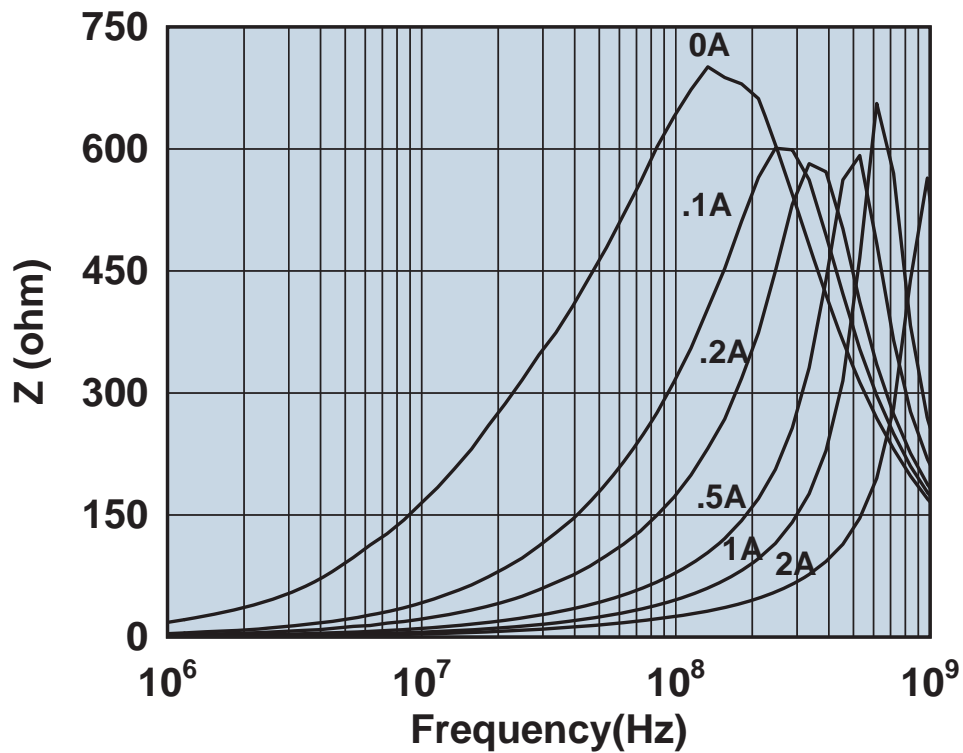

Impedance vs. frequency with dc bias.

2508059007Y0

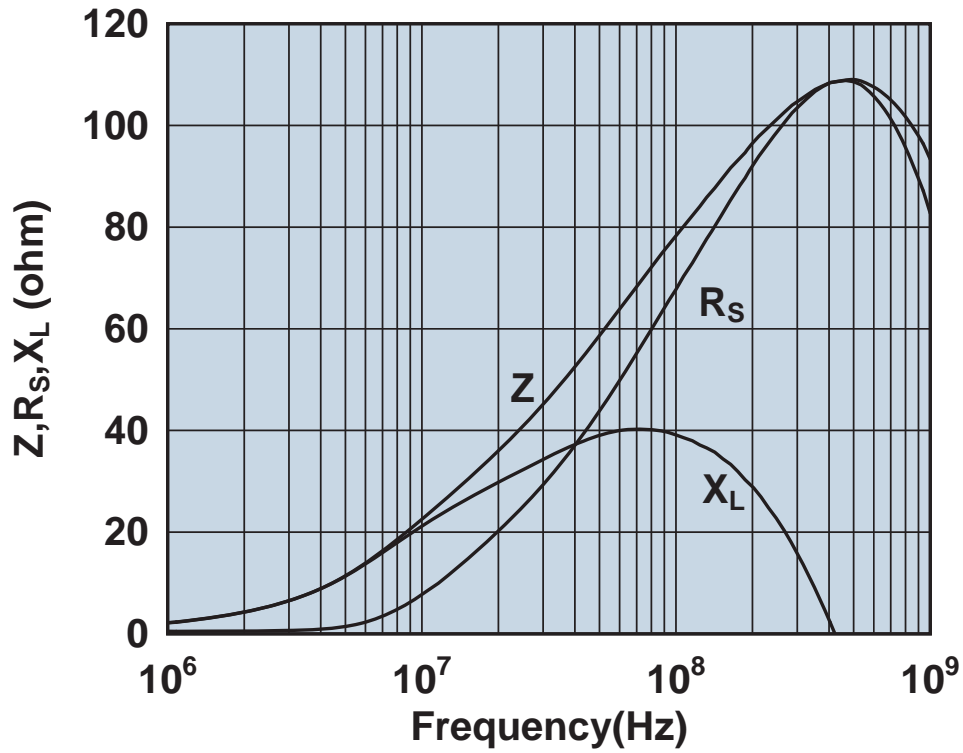

Impedance, reactance, and resistance vs. frequency.

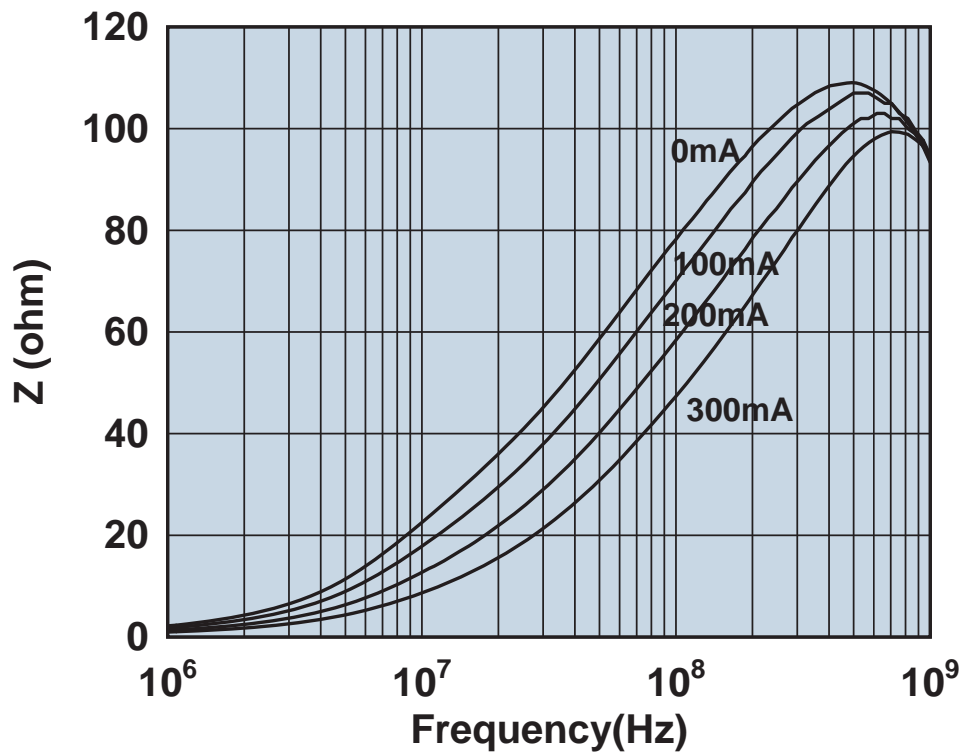

Impedance vs. frequency with dc bias.

2512061017Y0

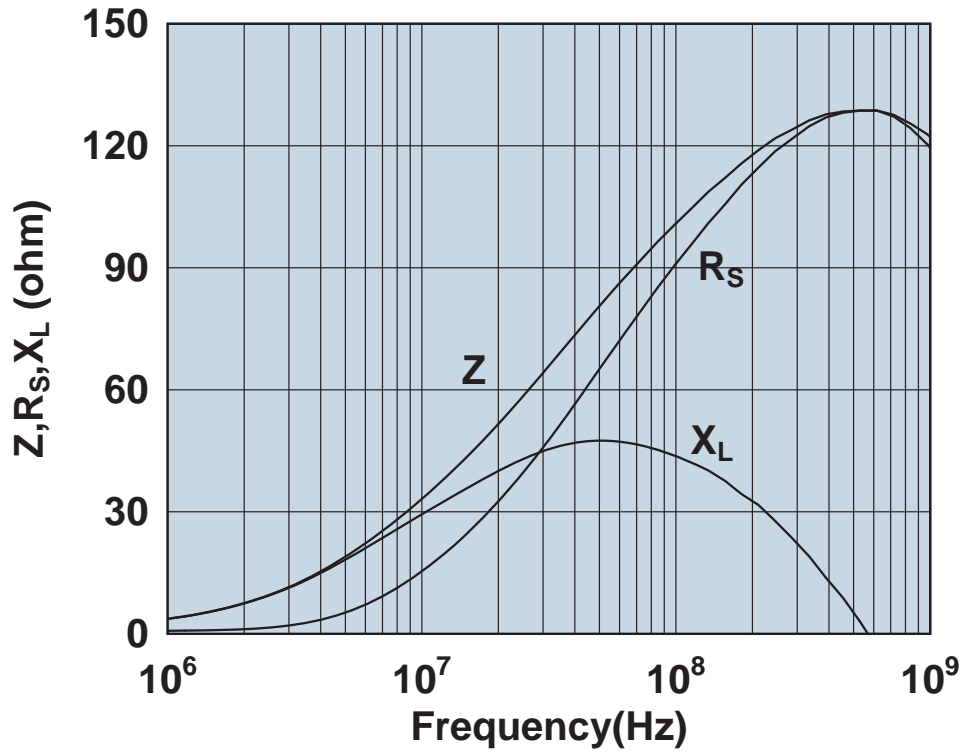

Impedance, reactance, and resistance vs. frequency.

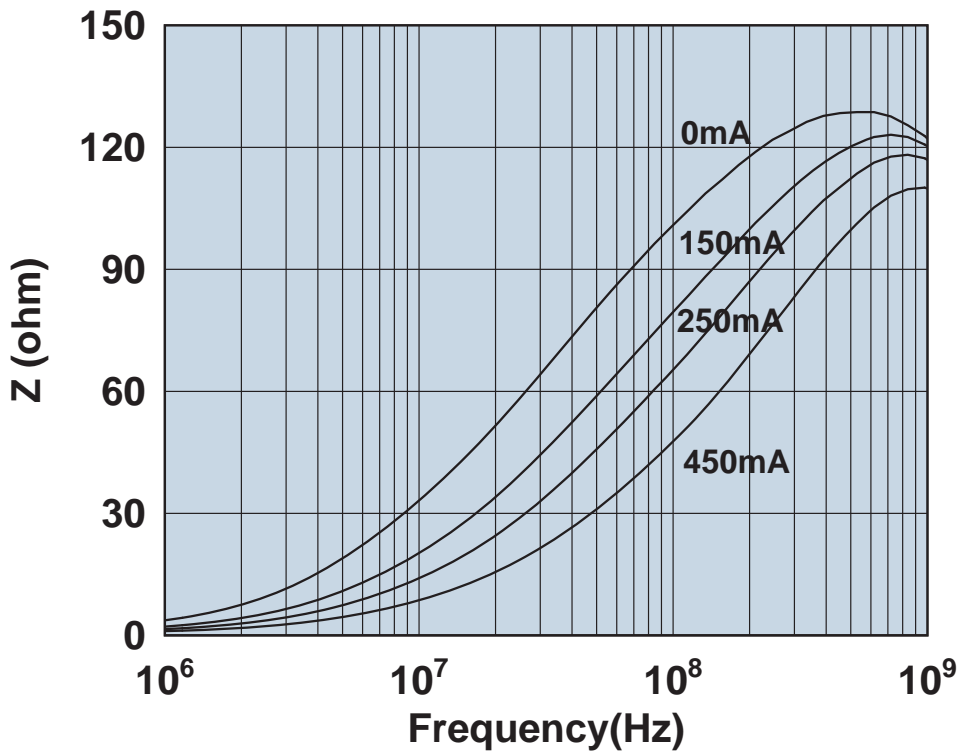

Impedance vs. frequency with dc bias.

2512061027Y0

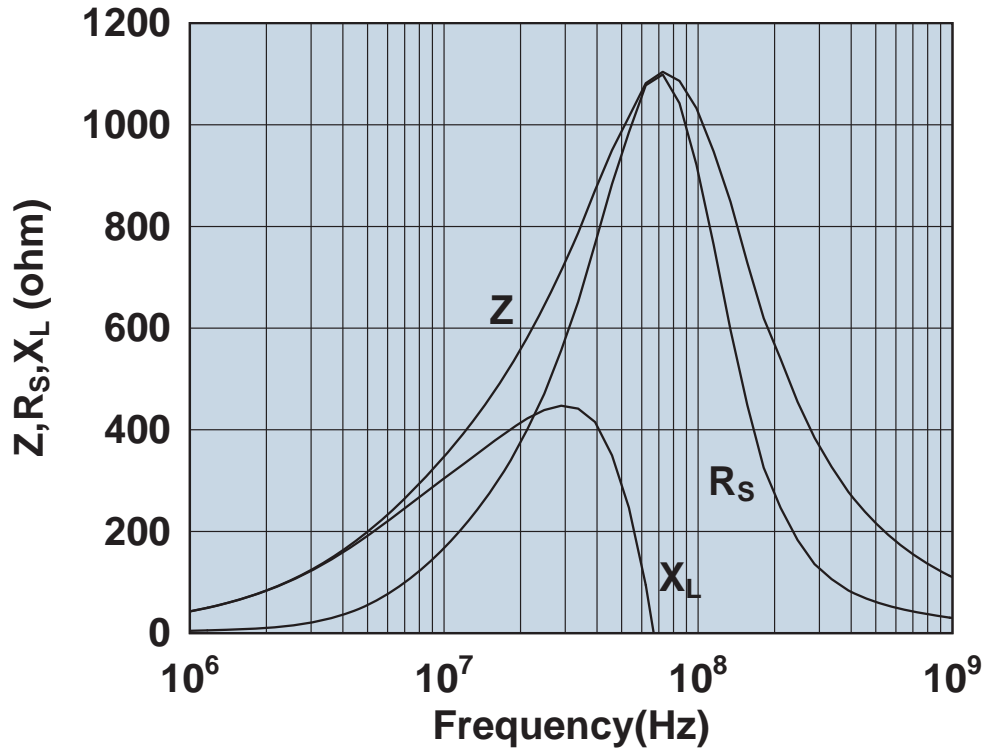

Impedance, reactance, and resistance vs. frequency.

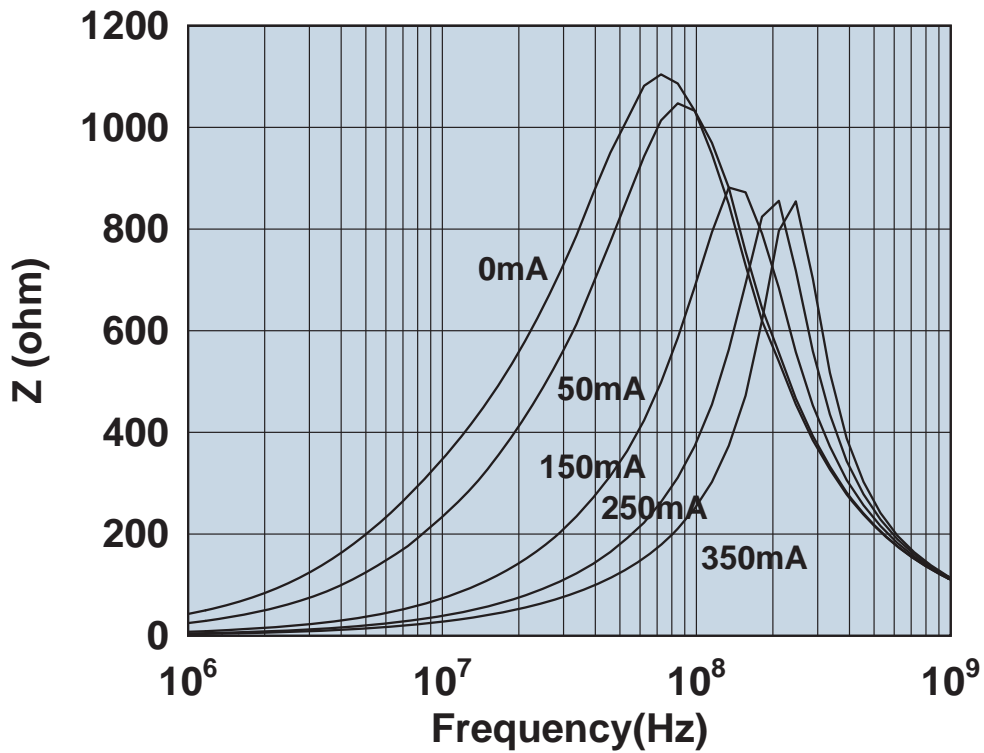

Impedance vs. frequency with dc bias.

2512061027Y0A4

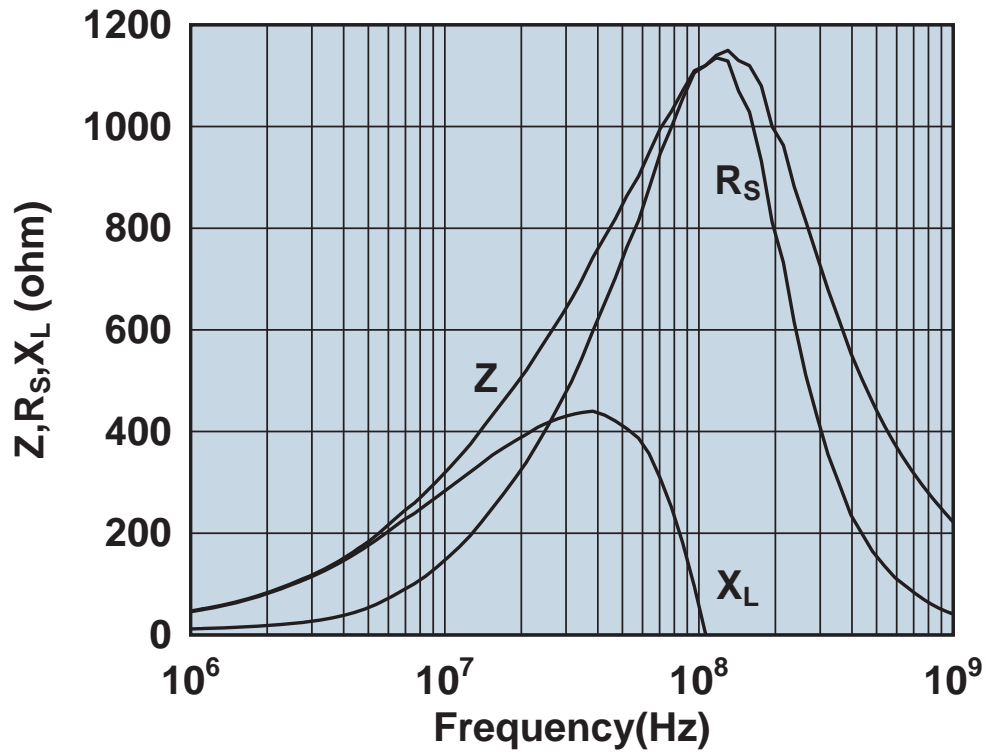

Impedance, reactance, and resistance vs. frequency.

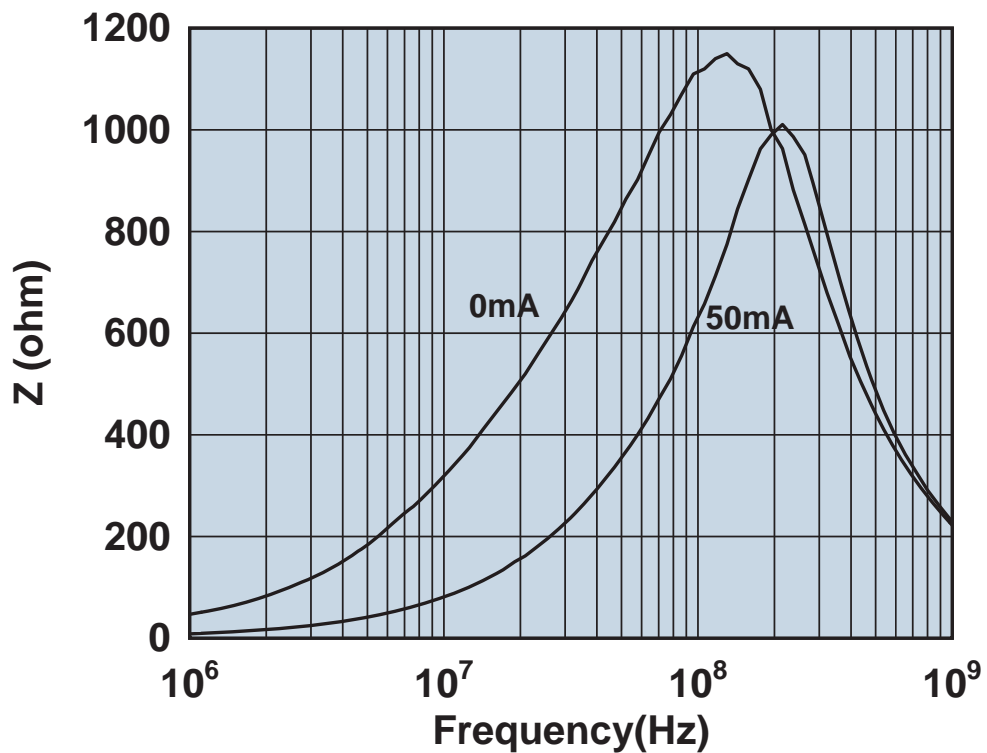

Impedance vs. frequency with dc bias.

2512061027Y1

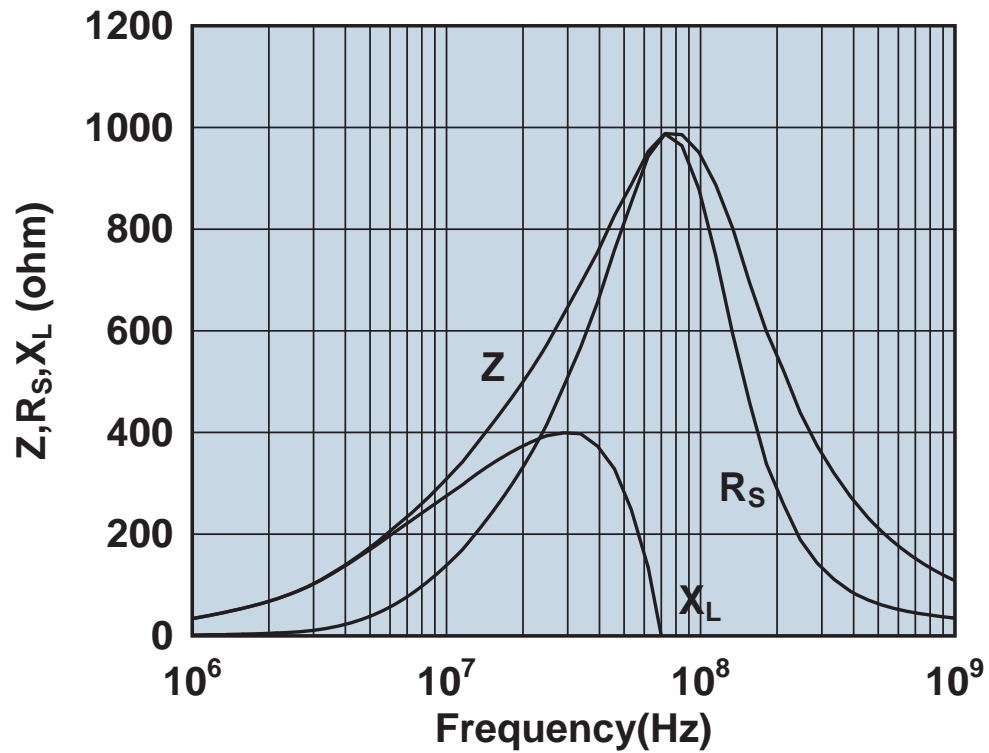

Impedance, reactance, and resistance vs. frequency.

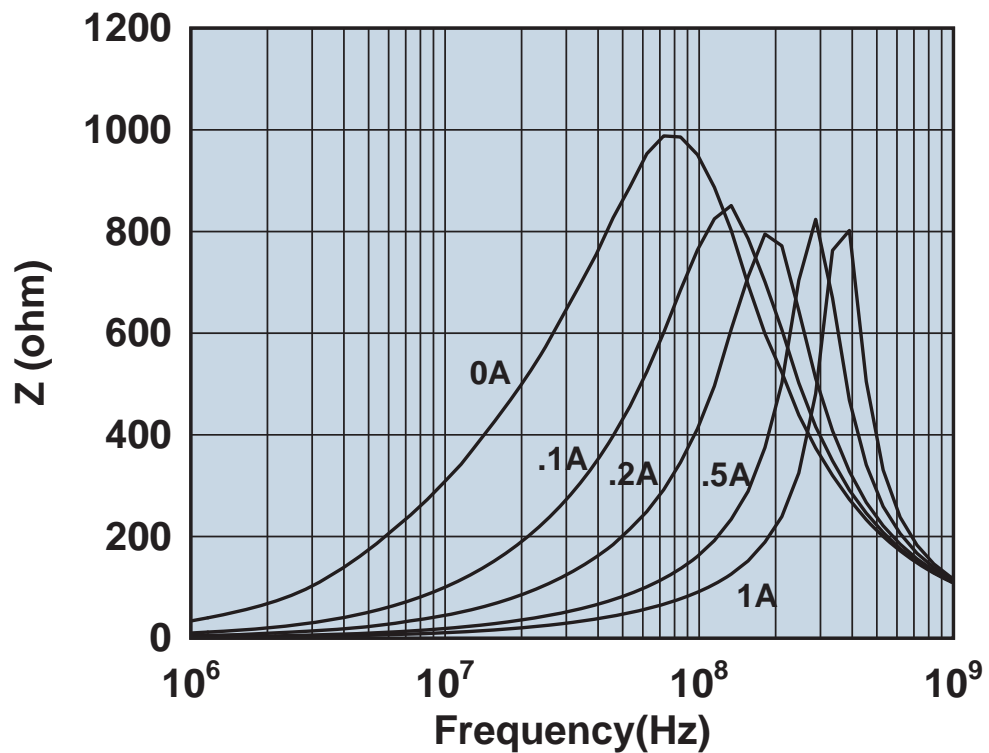

Impedance vs. frequency with dc bias.

2512061217Y0

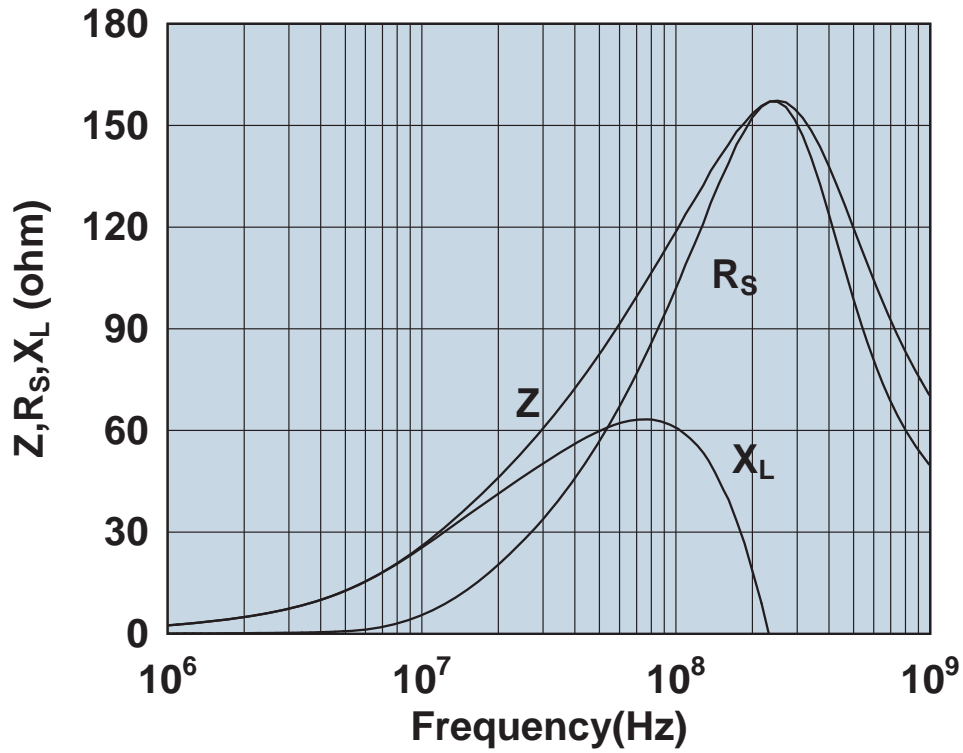

Impedance, reactance, and resistance vs. frequency.

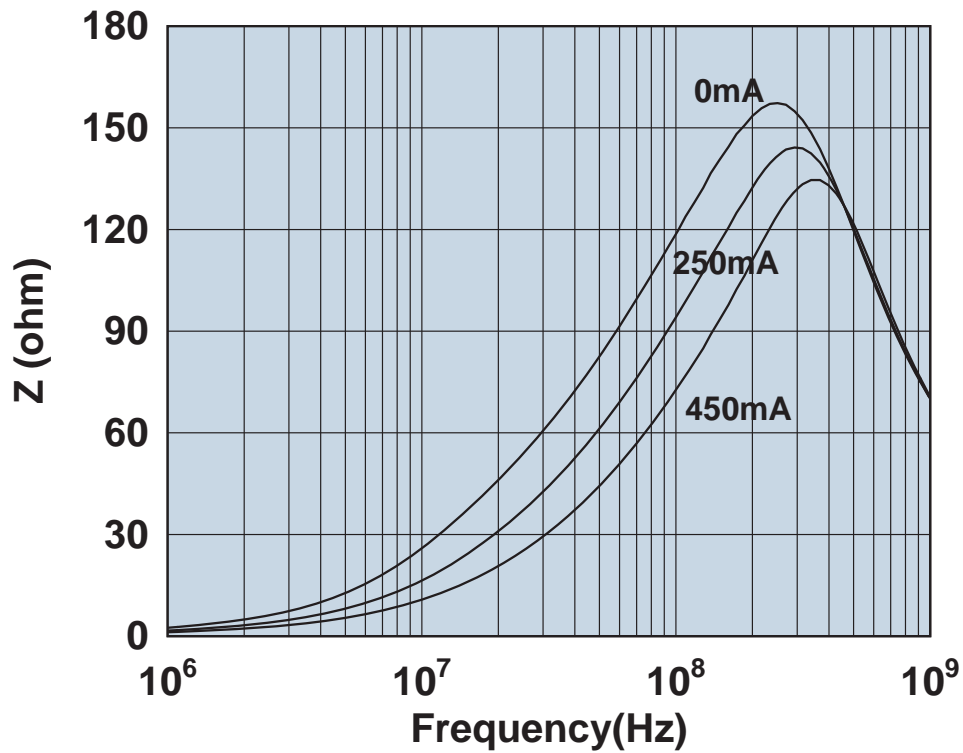

Impedance vs. frequency with dc bias.

2512061217Y0A4

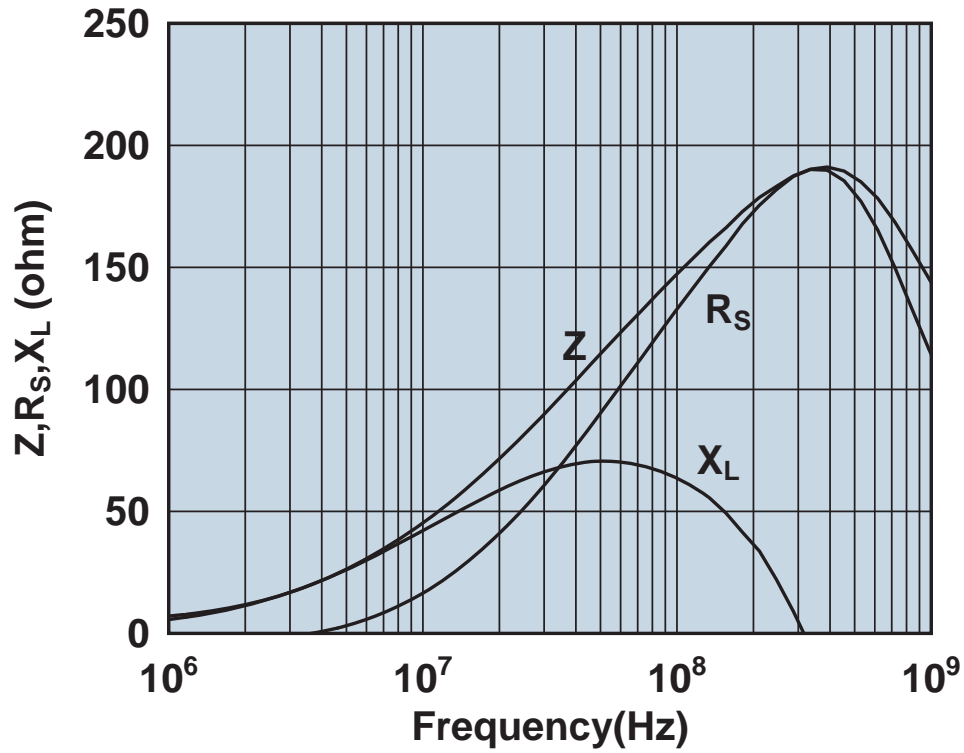

Impedance, reactance, and resistance vs. frequency.

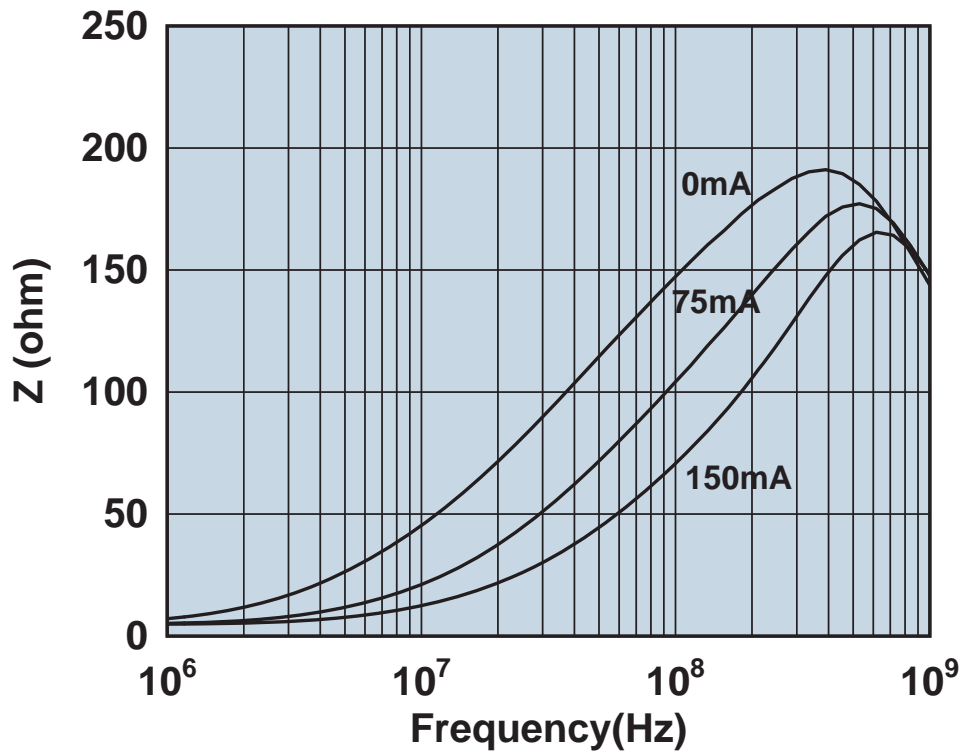

Impedance vs. frequency with dc bias.

2512061217Y5

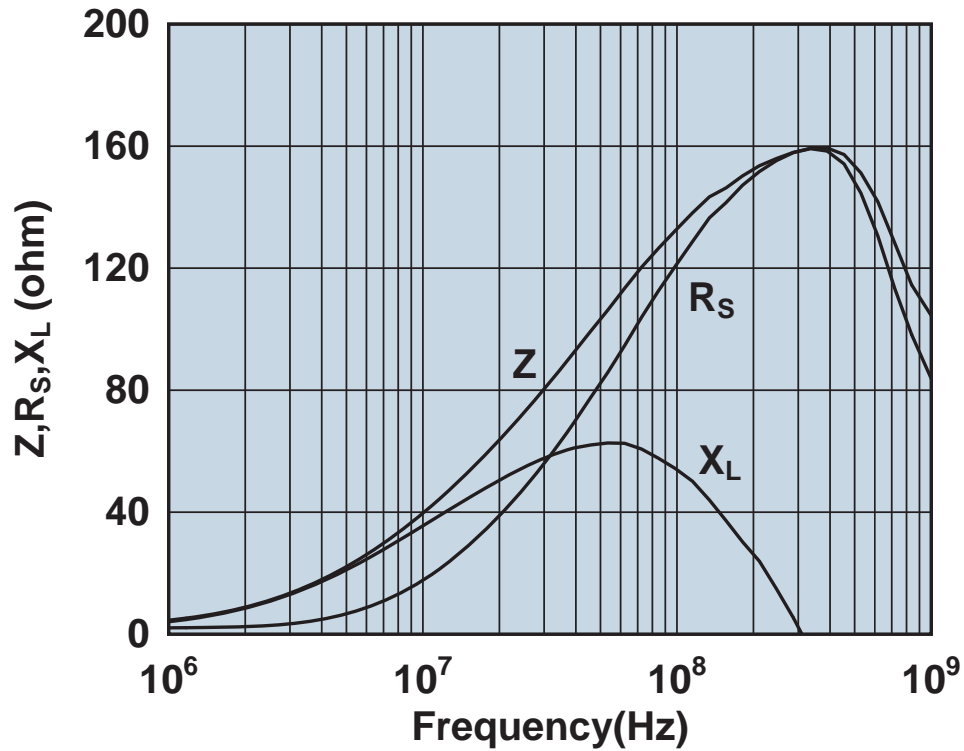

Impedance, reactance, and resistance vs. frequency.

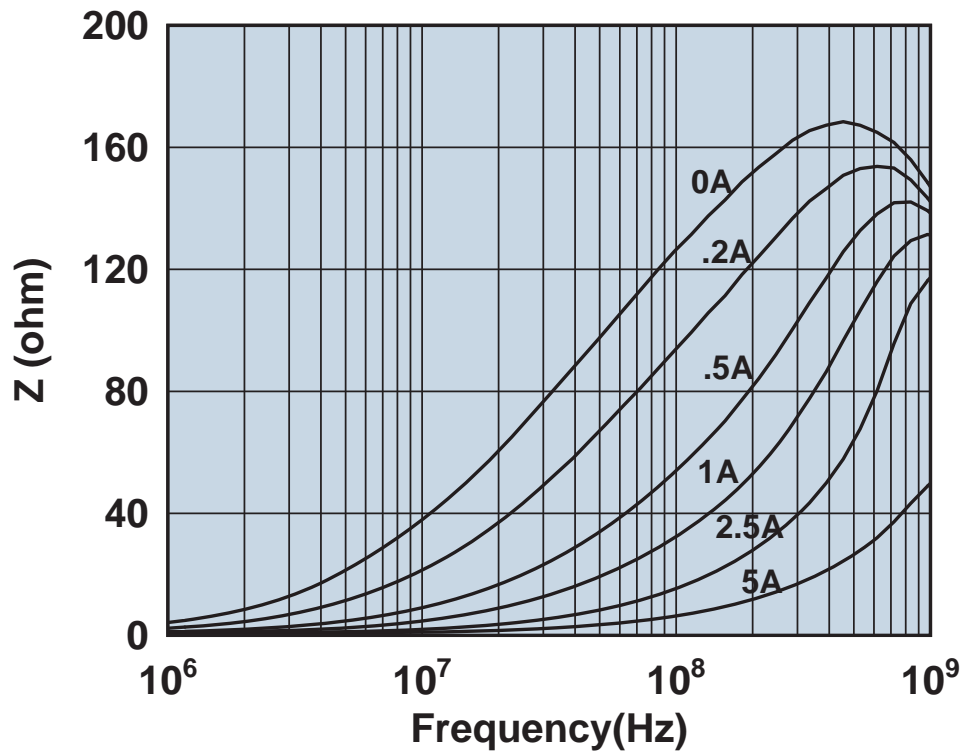

Impedance vs. frequency with dc bias.

2512061217Z0A4

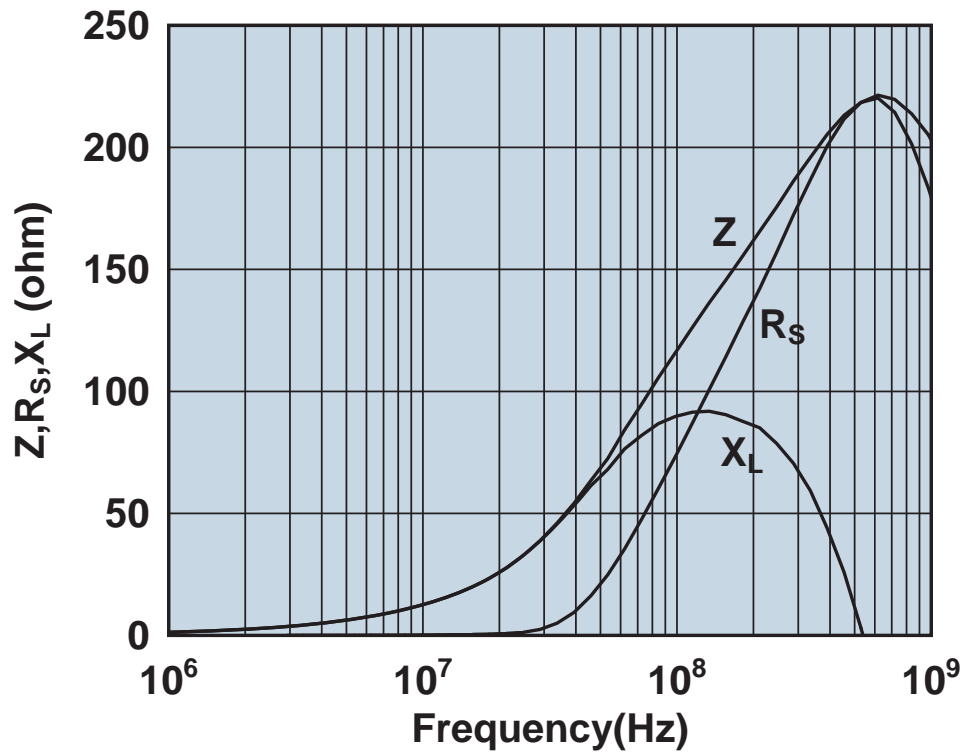

Impedance, reactance, and resistance vs. frequency.

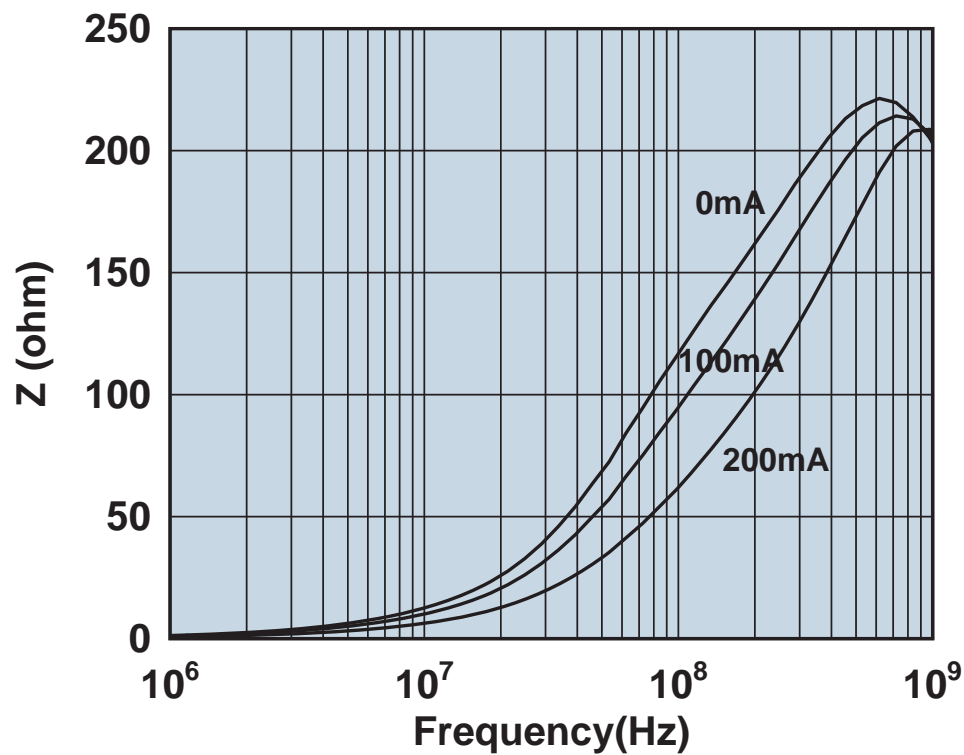

Impedance vs. frequency with dc bias.

2512061517Y3

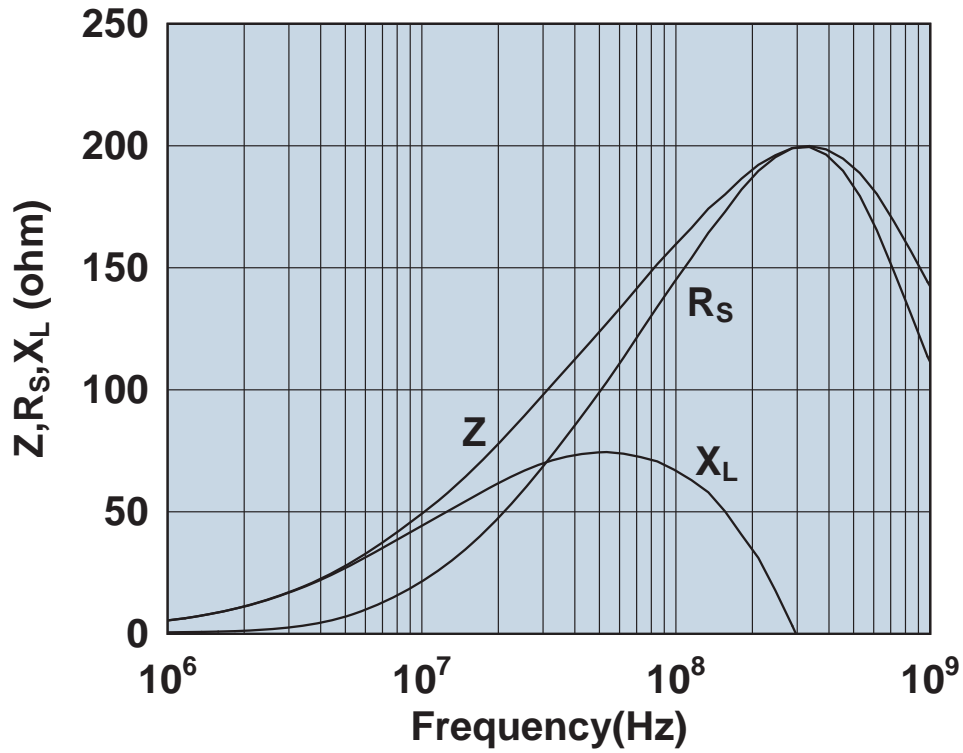

Impedance, reactance, and resistance vs. frequency.

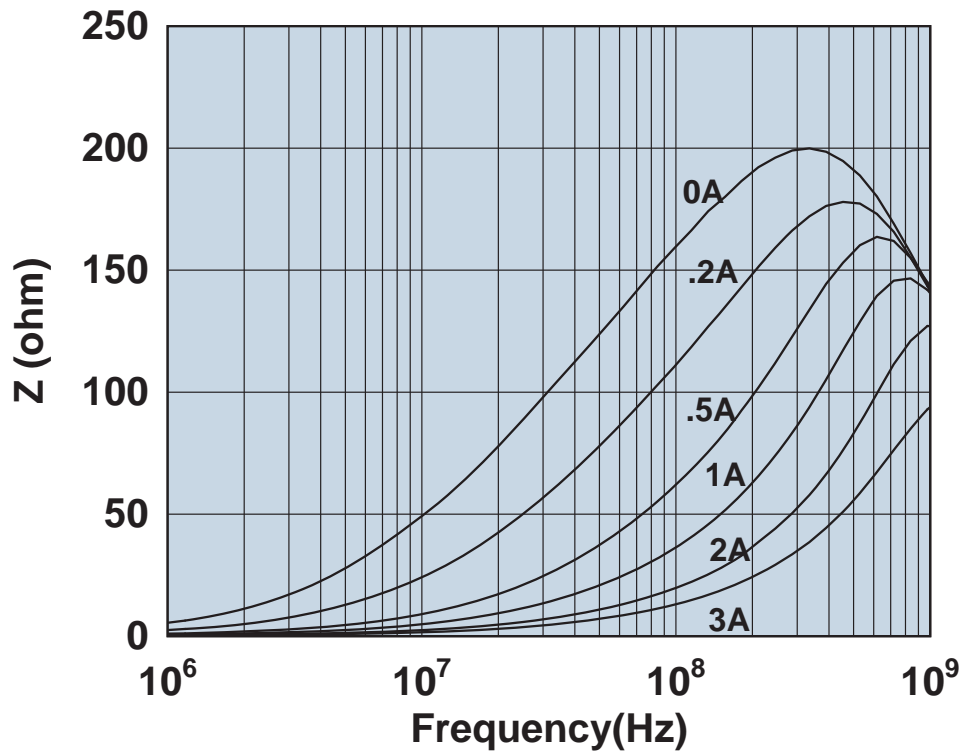

Impedance vs. frequency with dc bias.

2512061527Y0

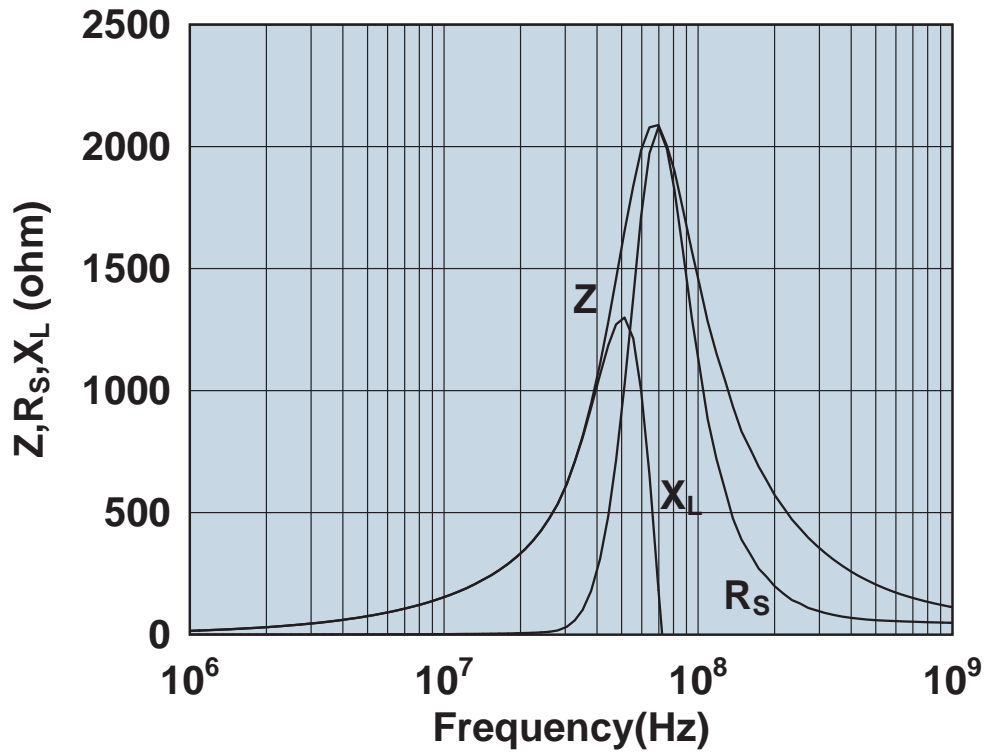

Impedance, reactance, and resistance vs. frequency.

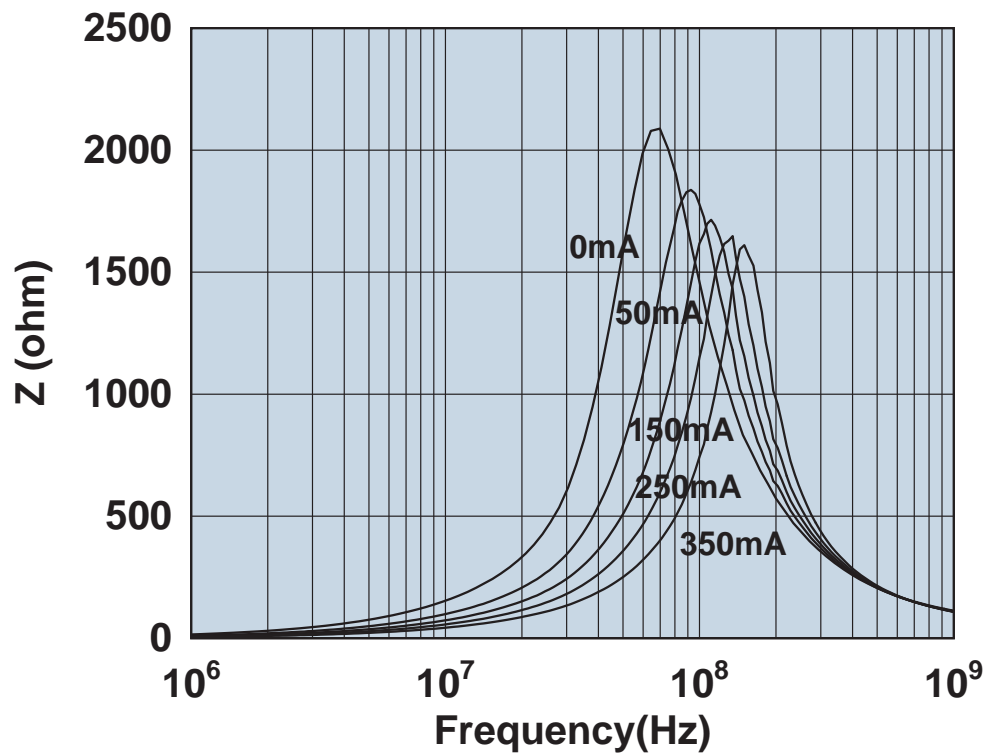

Impedance vs. frequency with dc bias.

2512062217Z0A4

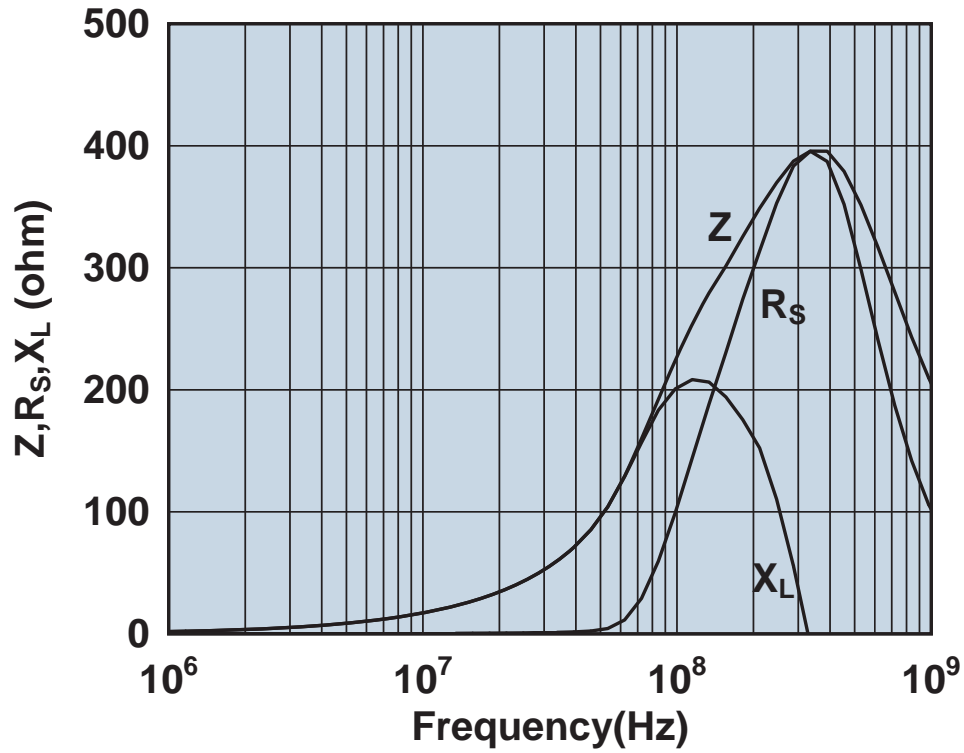

Impedance, reactance, and resistance vs. frequency.

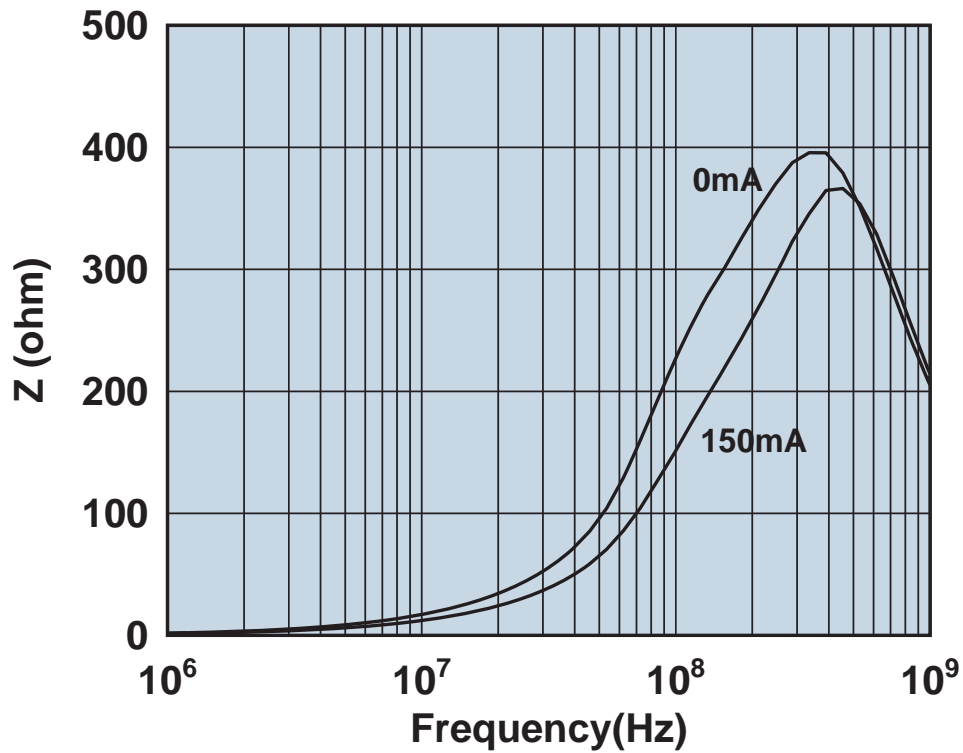

Impedance vs. frequency with dc bias.

2512063007Y0

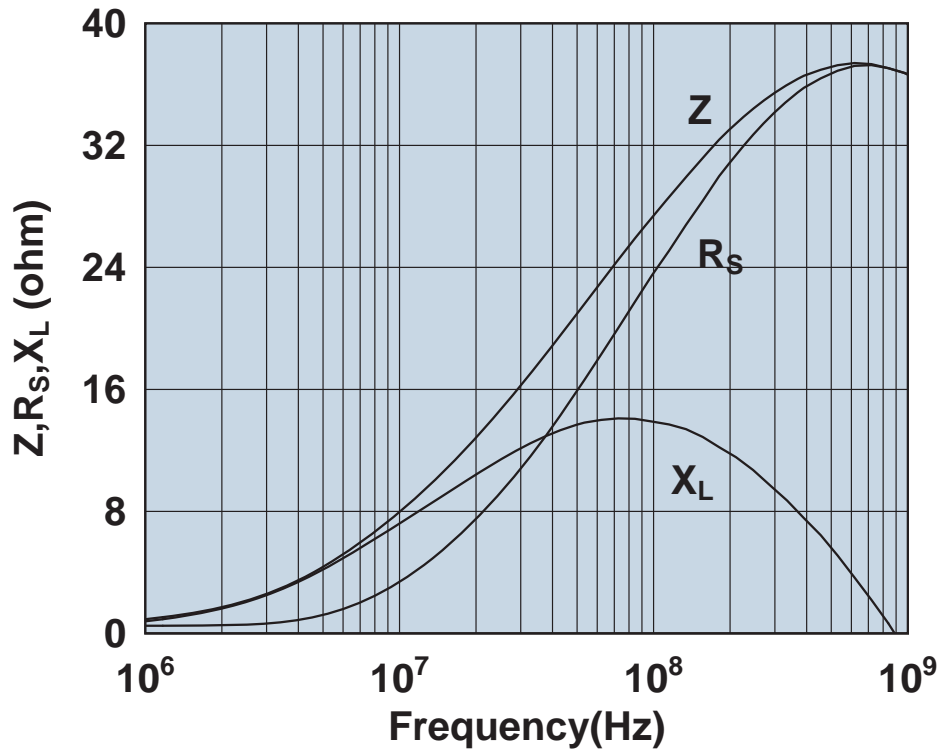

Impedance, reactance, and resistance vs. frequency.

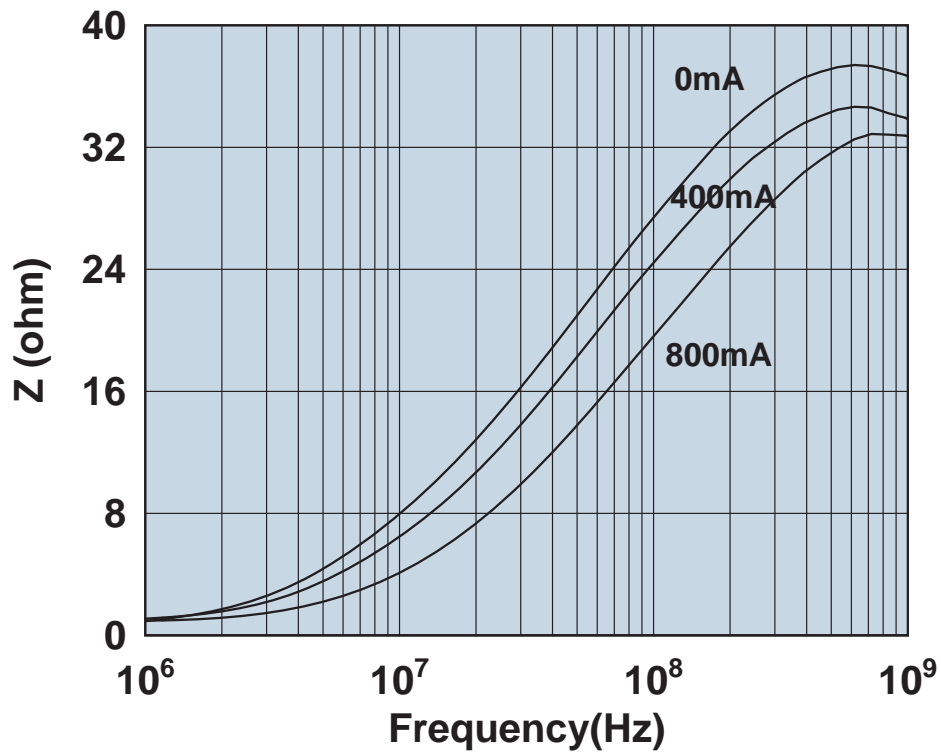

Impedance vs. frequency with dc bias.

2512063007Y3

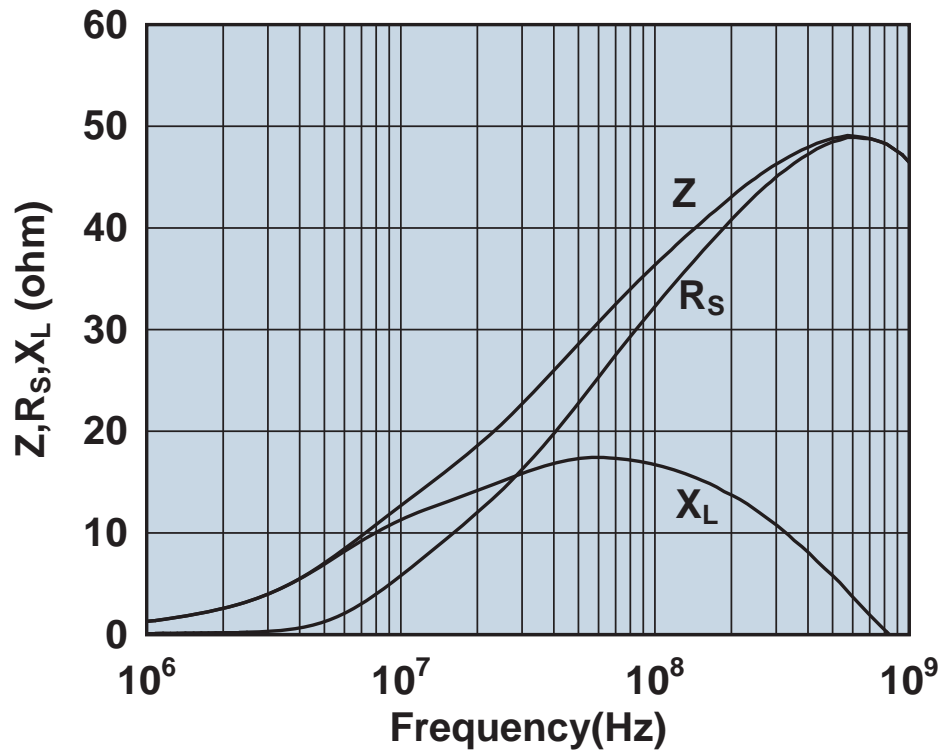

Impedance, reactance, and resistance vs. frequency.

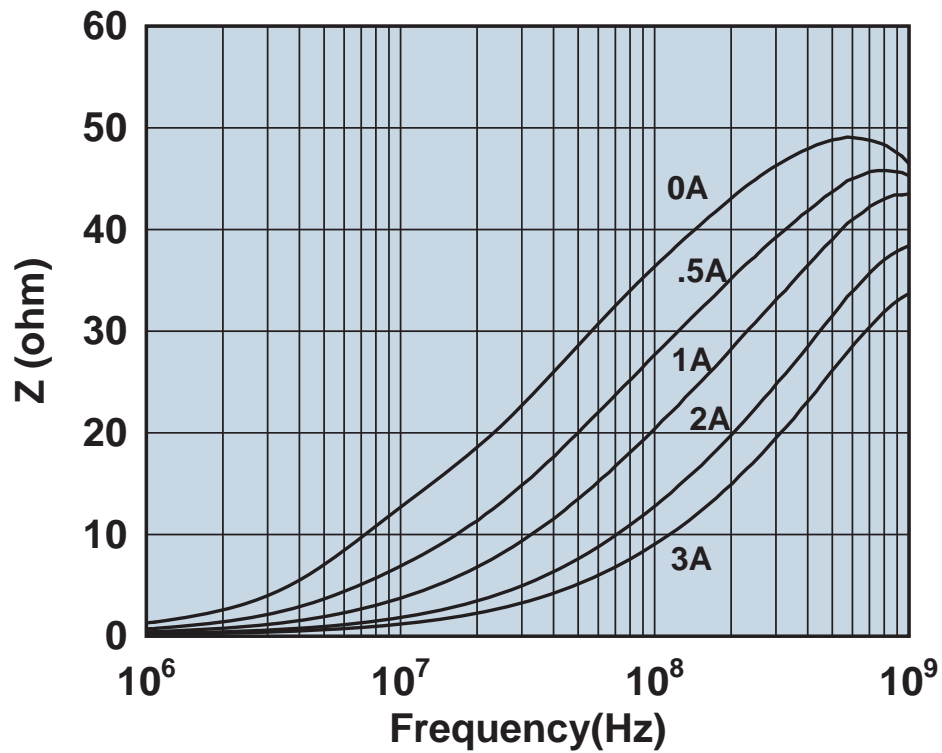

Impedance vs. frequency with dc bias.

2512063017Y0

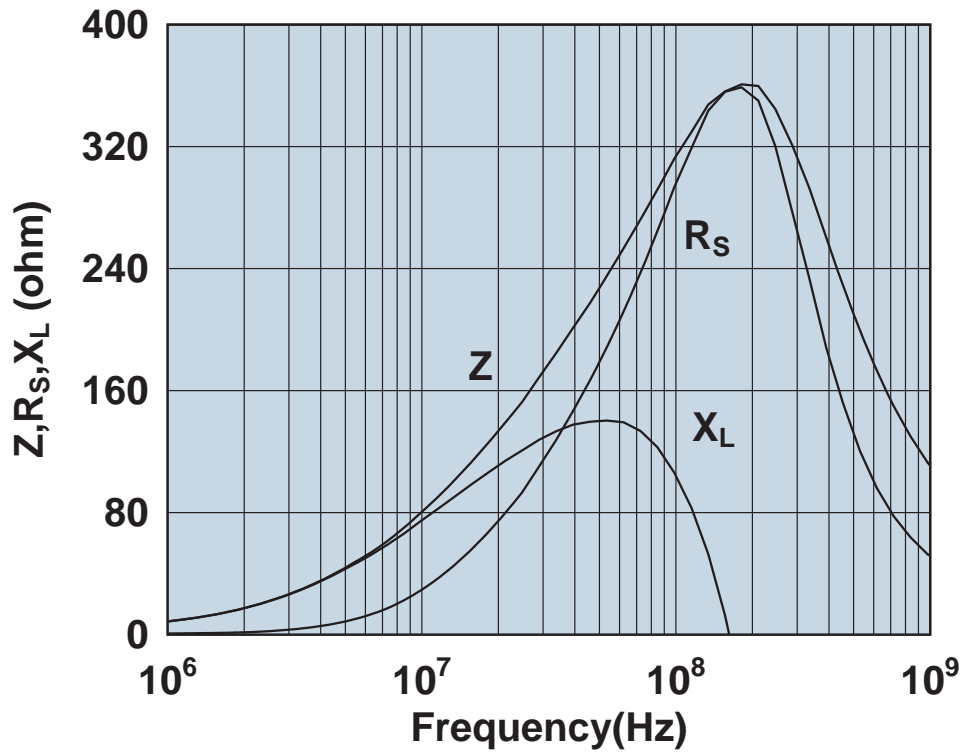

Impedance, reactance, and resistance vs. frequency.

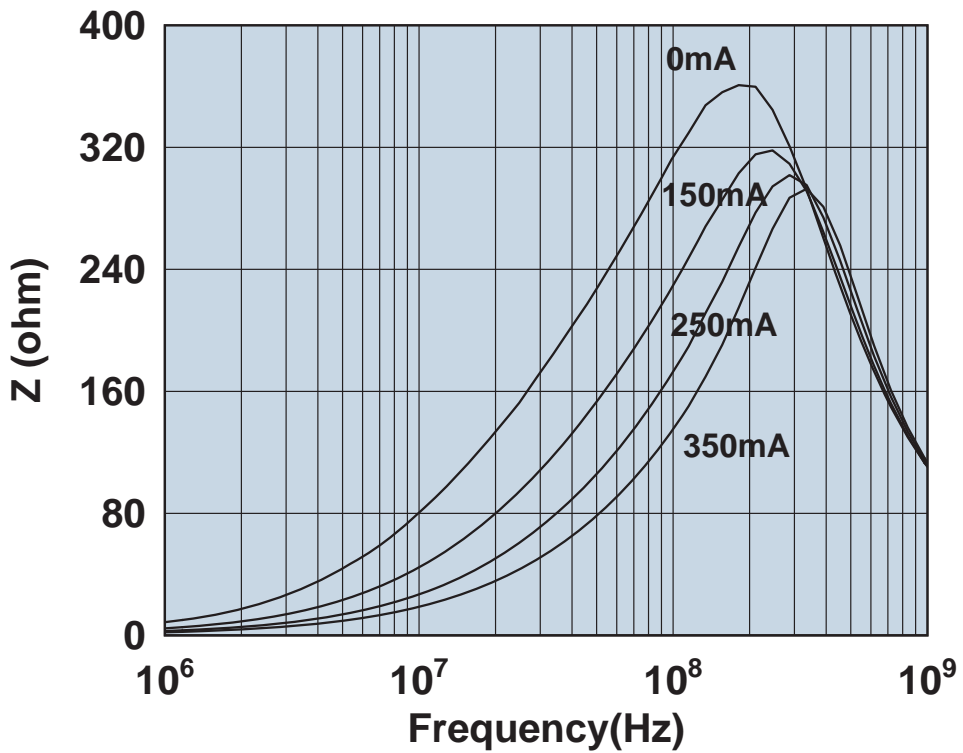

Impedance vs. frequency with dc bias.

2512063017Y0A4

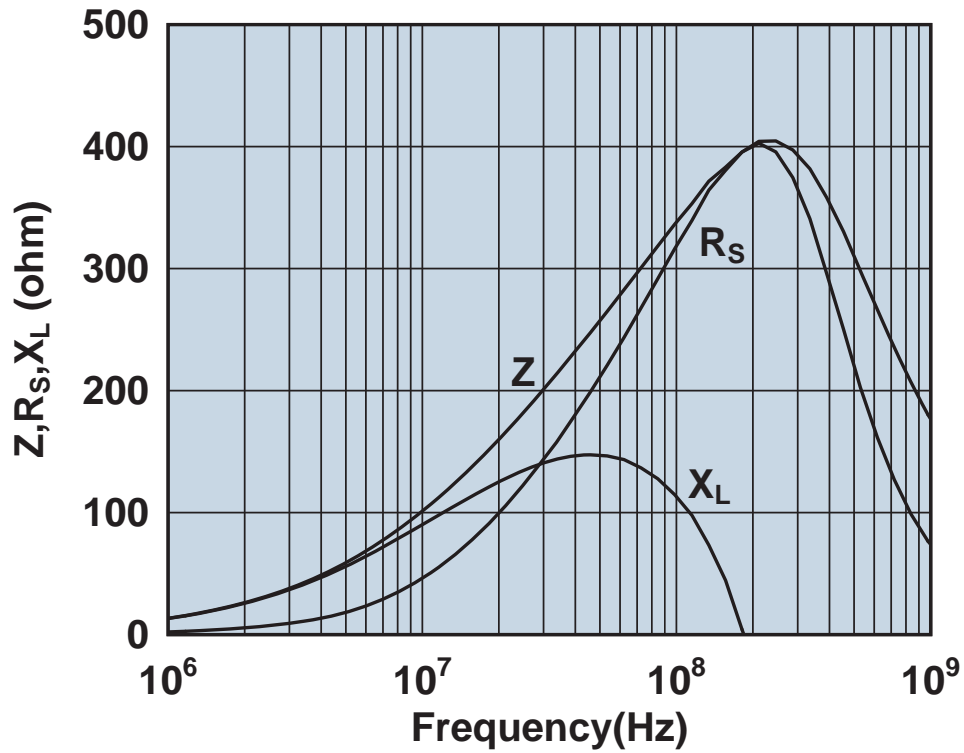

Impedance, reactance, and resistance vs. frequency.

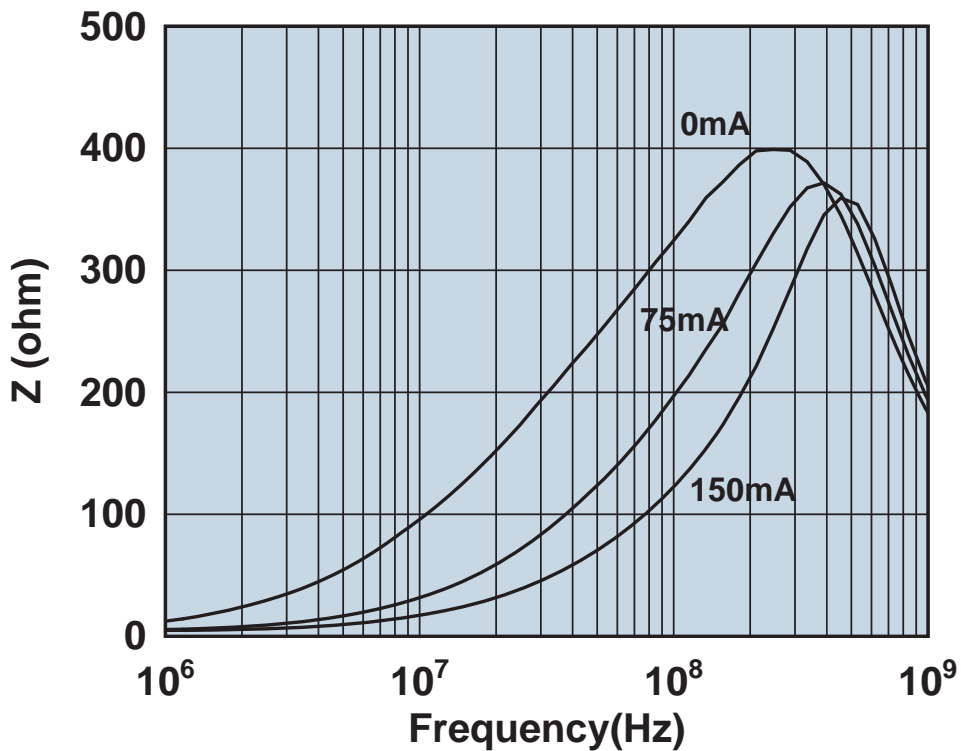

Impedance vs. frequency with dc bias.

2512063017Y3

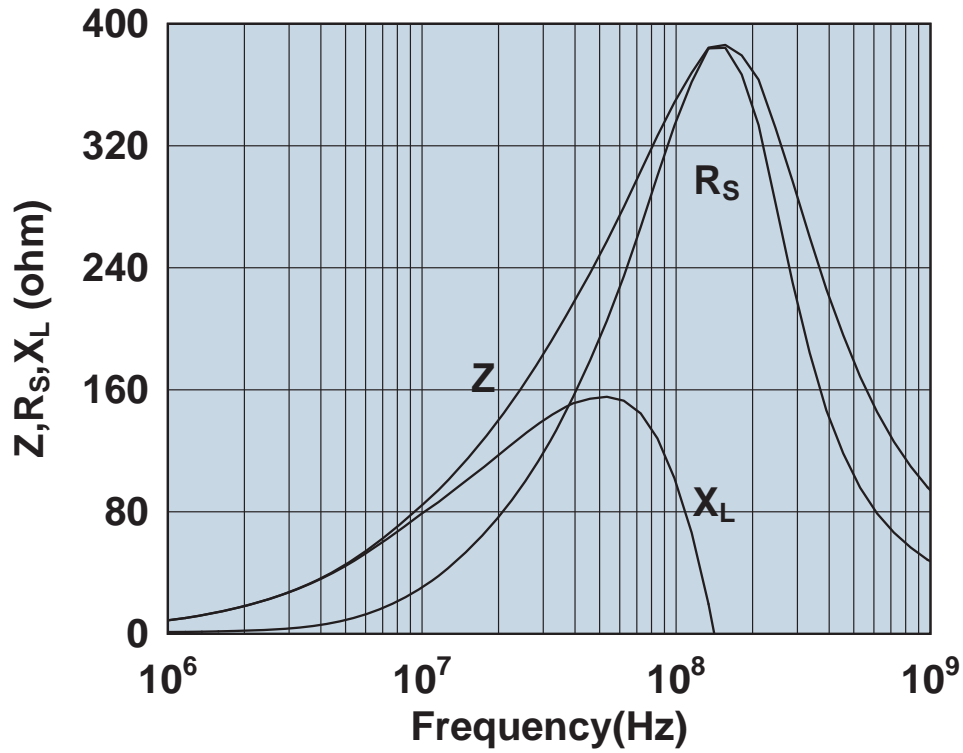

Impedance, reactance, and resistance vs. frequency.

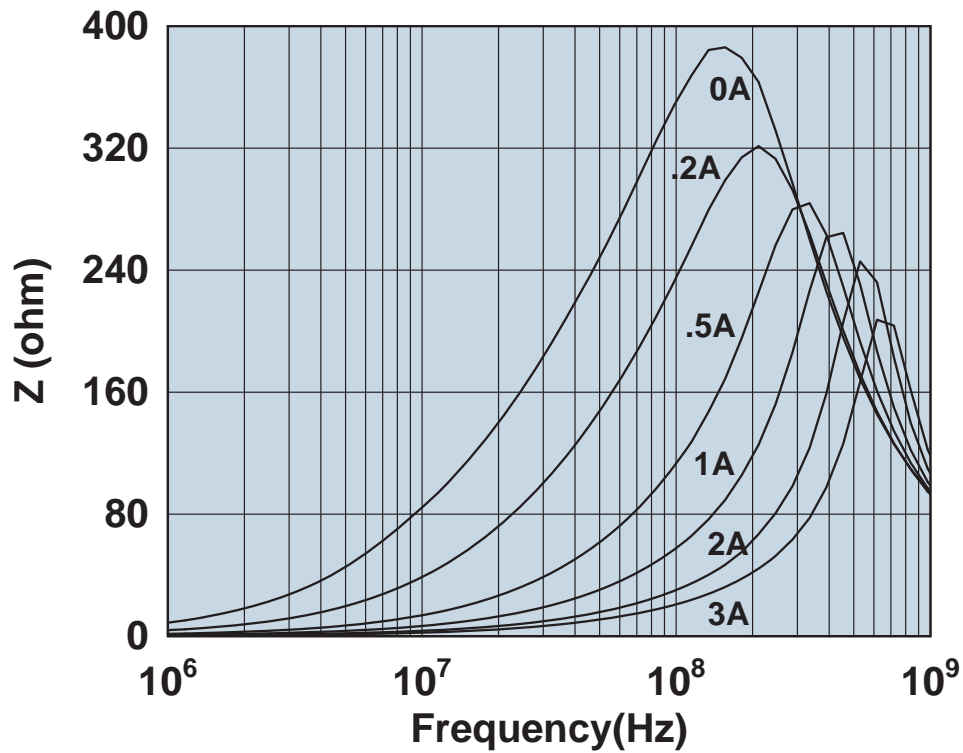

Impedance vs. frequency with dc bias.

2512065007Y0

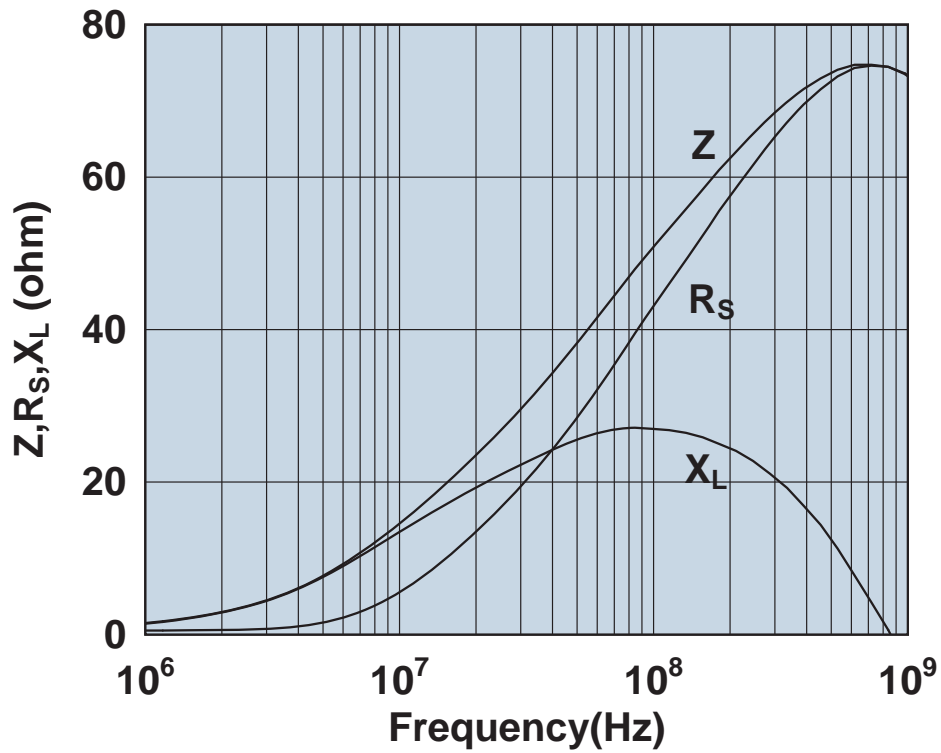

Impedance, reactance, and resistance vs. frequency.

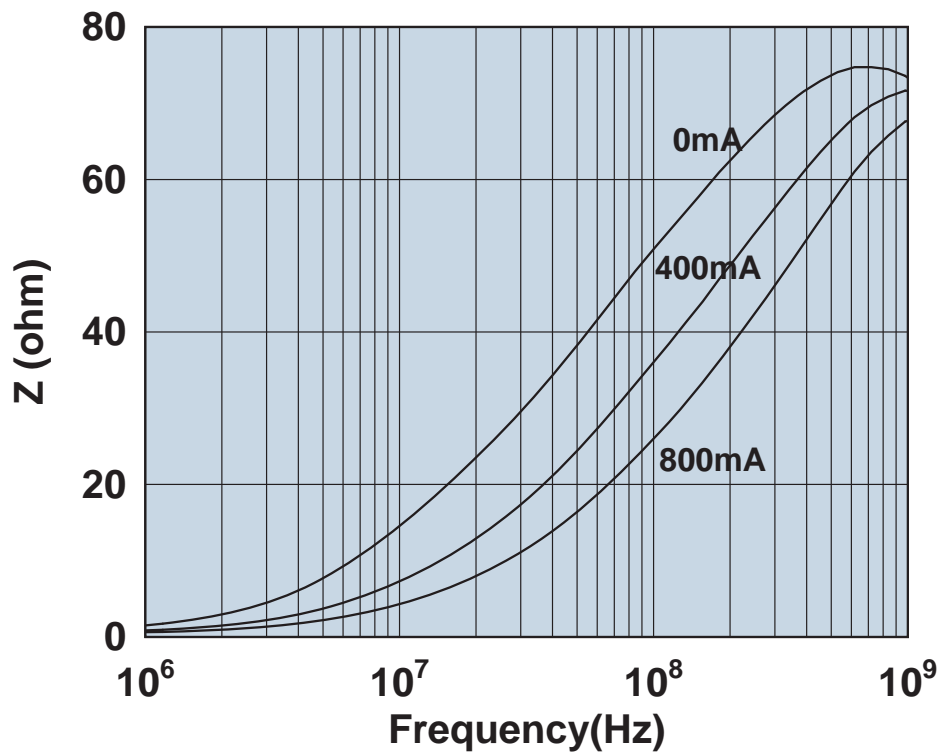

Impedance vs. frequency with dc bias.

2512065007Y0

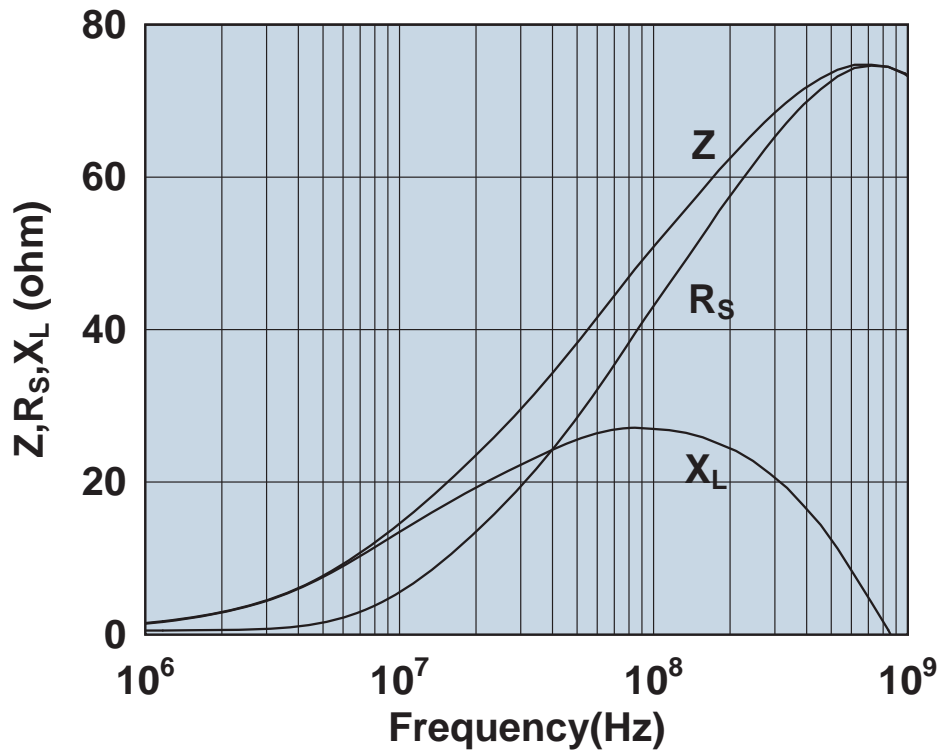

Impedance, reactance, and resistance vs. frequency.

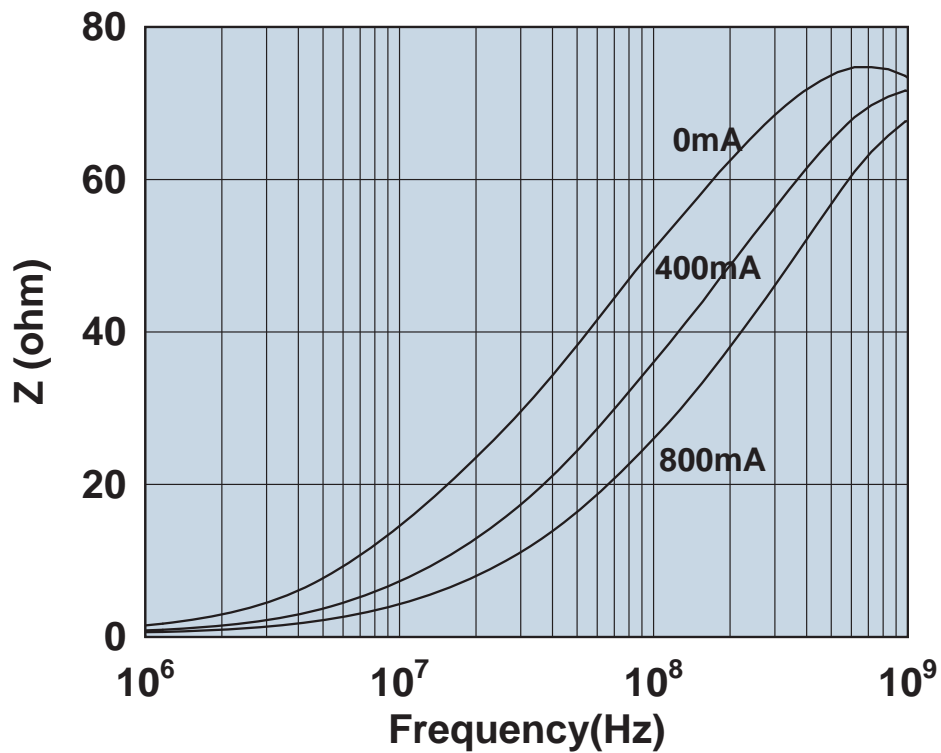

Impedance vs. frequency with dc bias.

2512065007Y3

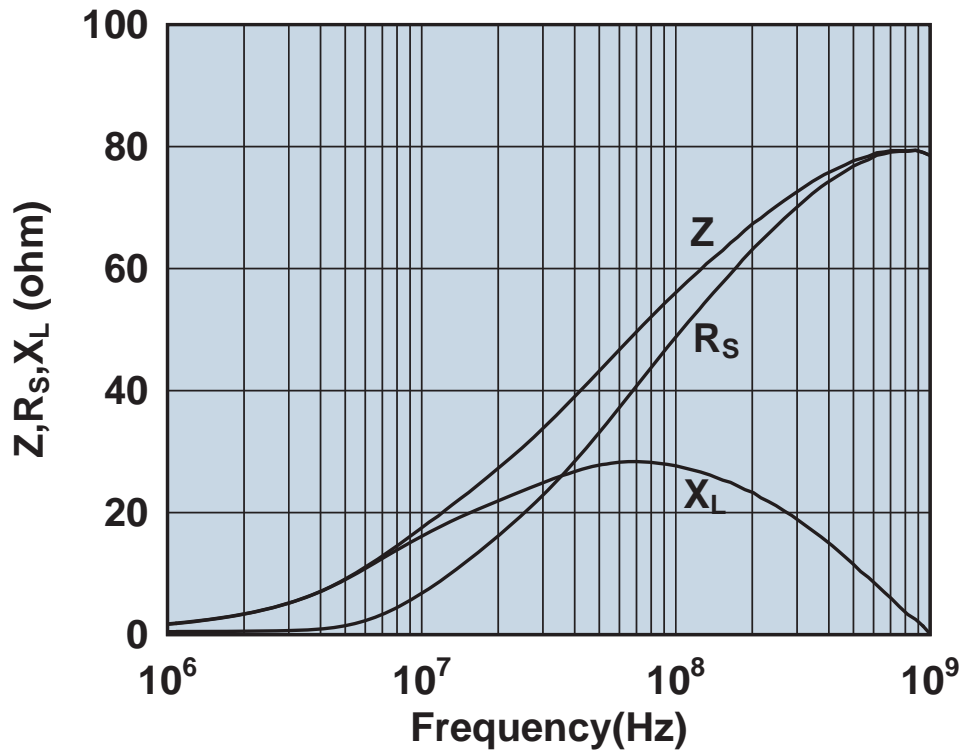

Impedance, reactance, and resistance vs. frequency.

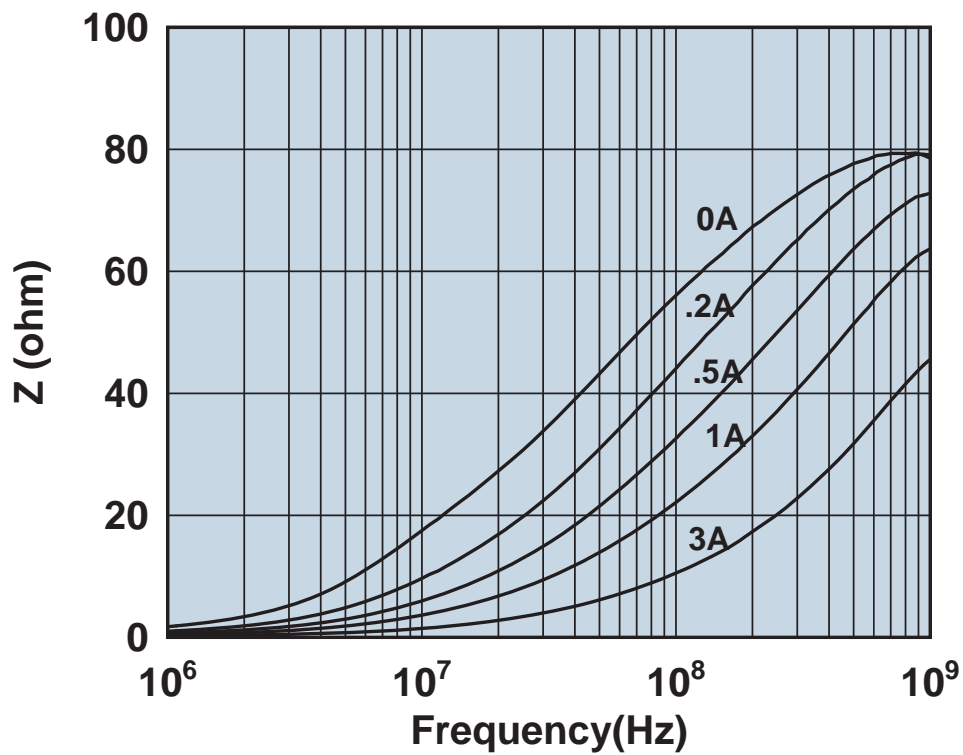

Impedance vs. frequency with dc bias.

2512065007Y6

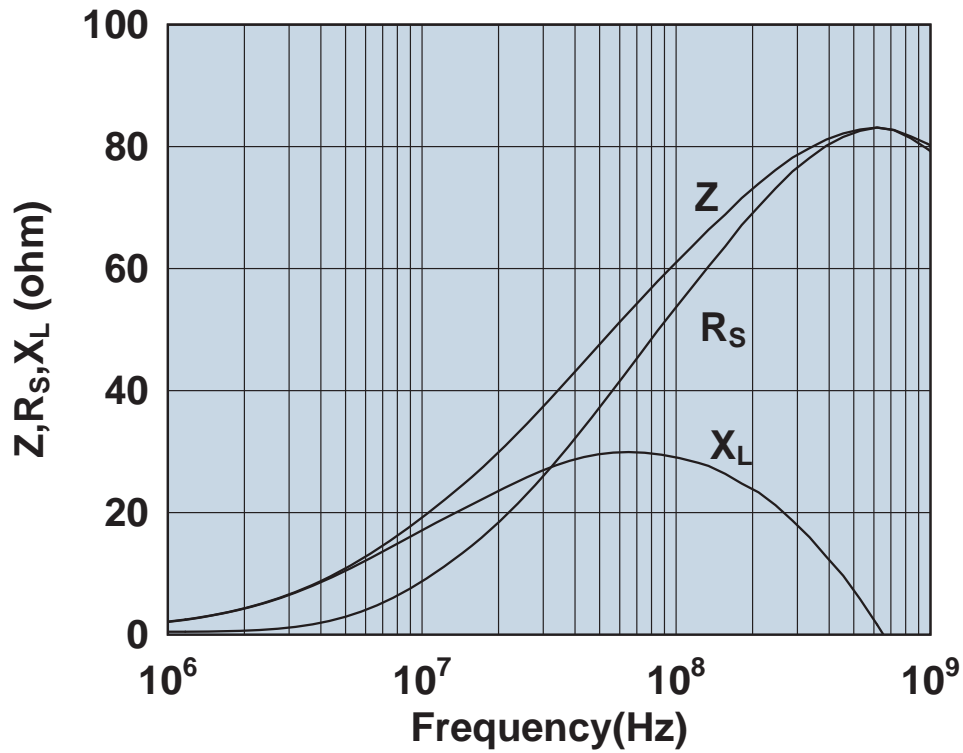

Impedance, reactance, and resistance vs. frequency.

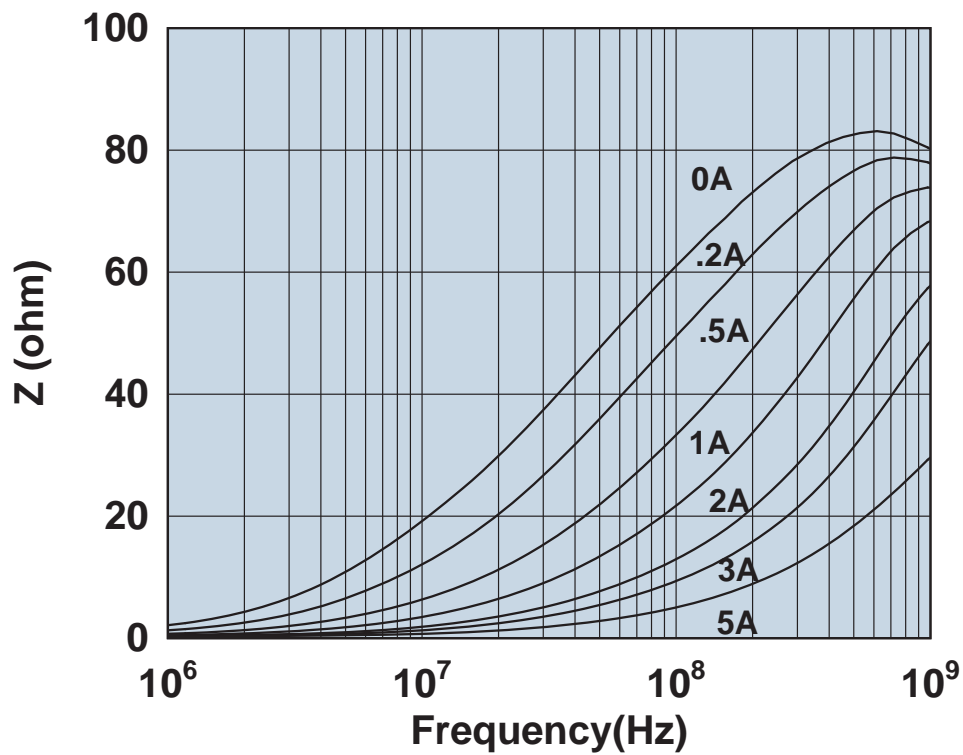

Impedance vs. frequency with dc bias.

2512066007Y0A4

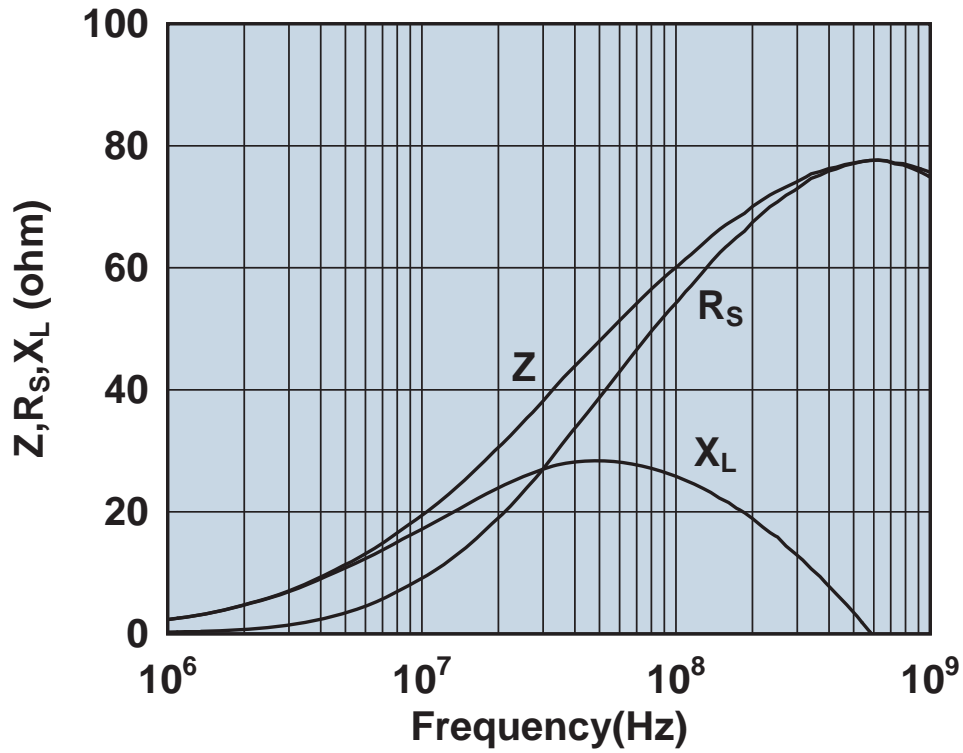

Impedance, reactance, and resistance vs. frequency.

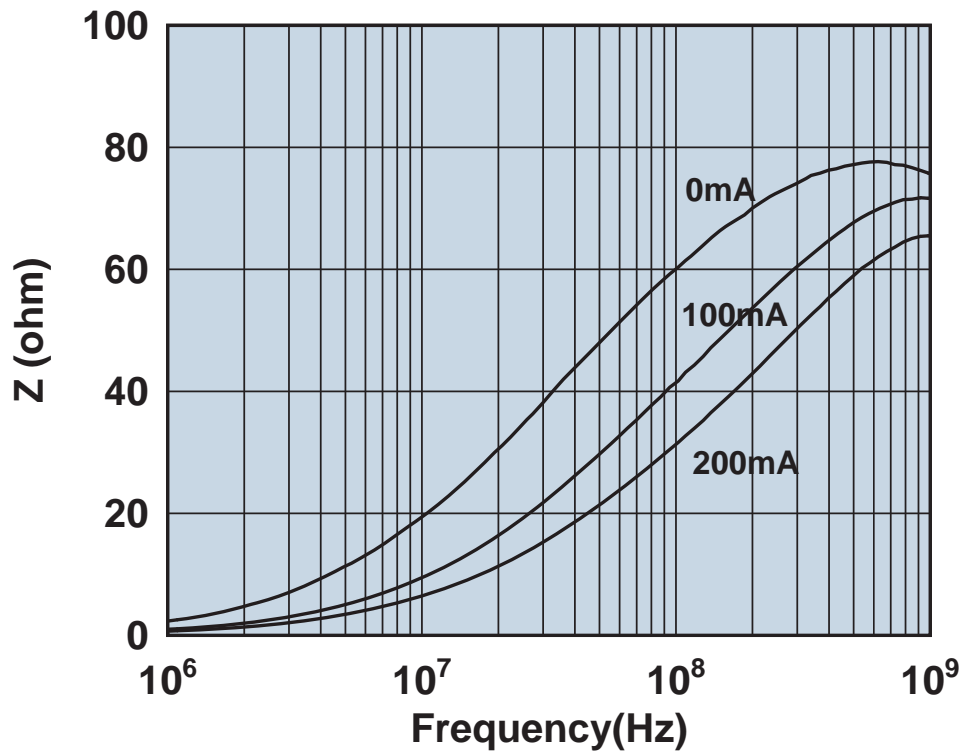

Impedance vs. frequency with dc bias.

2512066017Y0

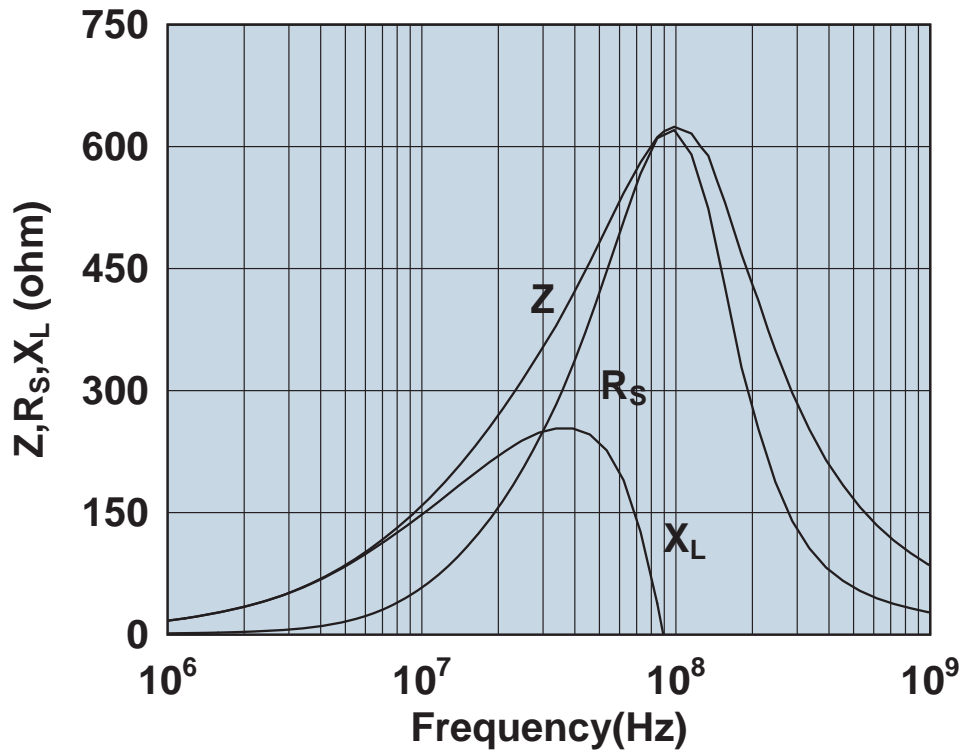

Impedance, reactance, and resistance vs. frequency.

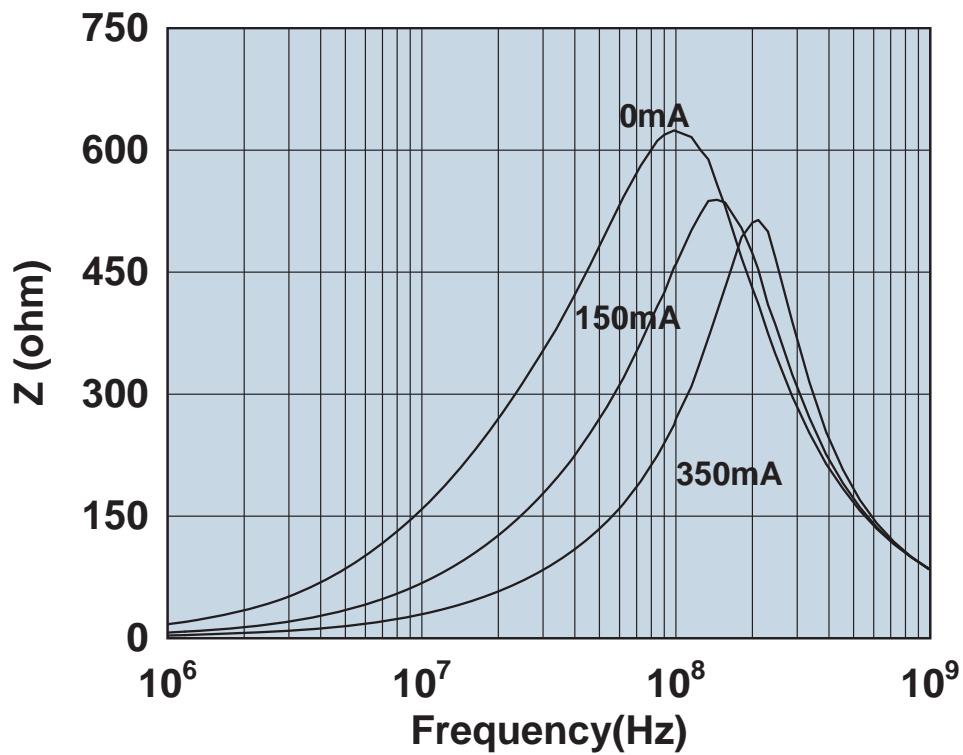

Impedance vs. frequency with dc bias.

2512066017Y0A4

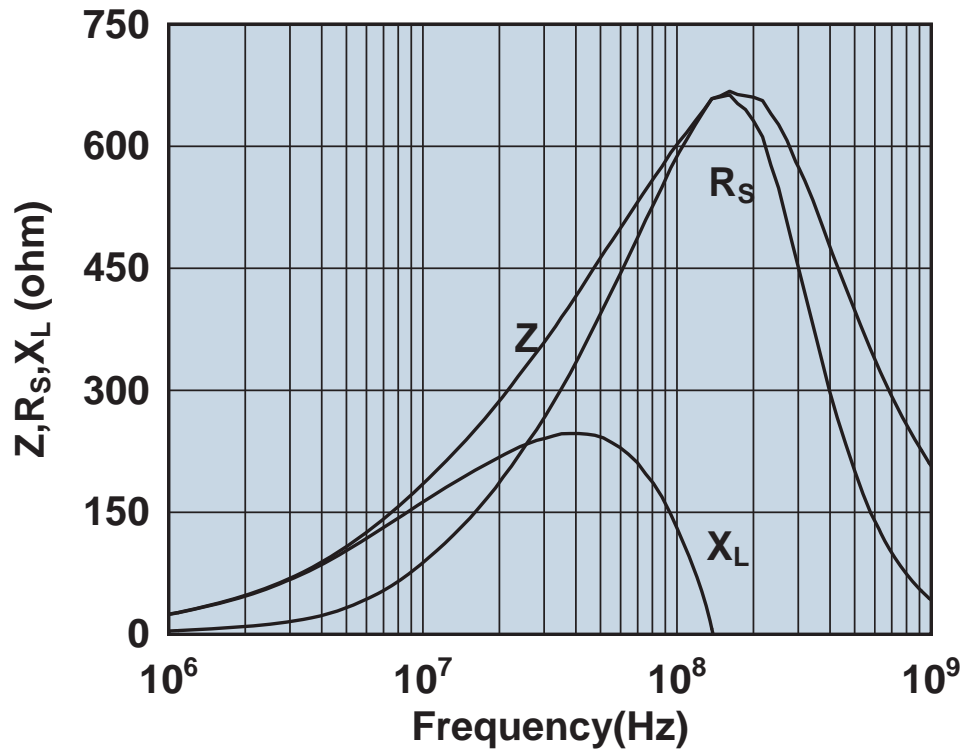

Impedance, reactance, and resistance vs. frequency.

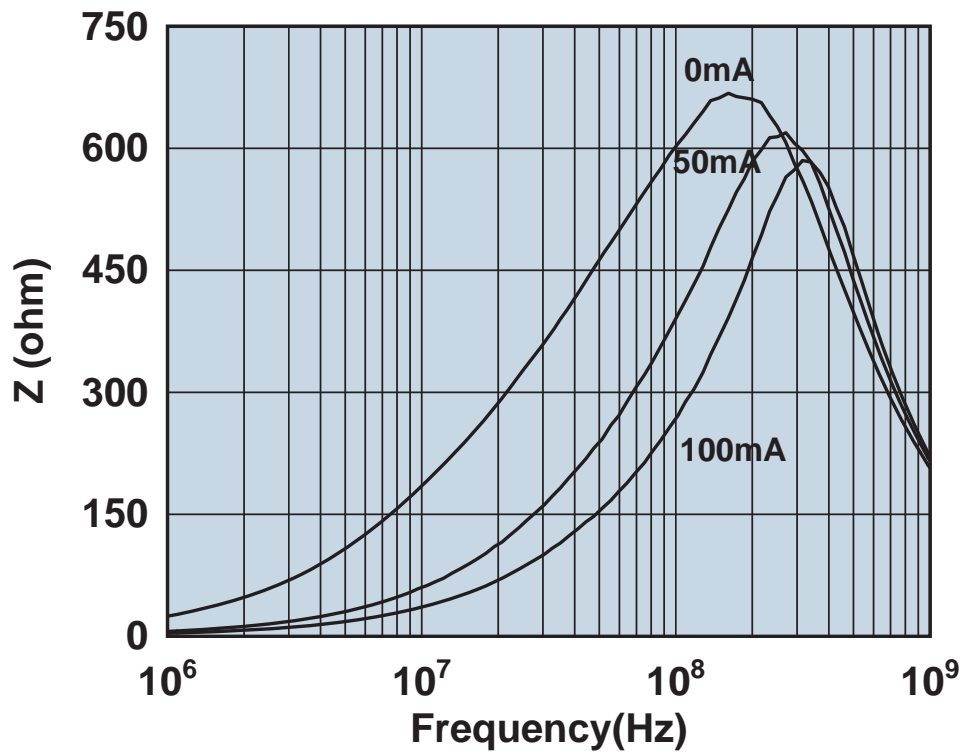

Impedance vs. frequency with dc bias.

2512066017Y1

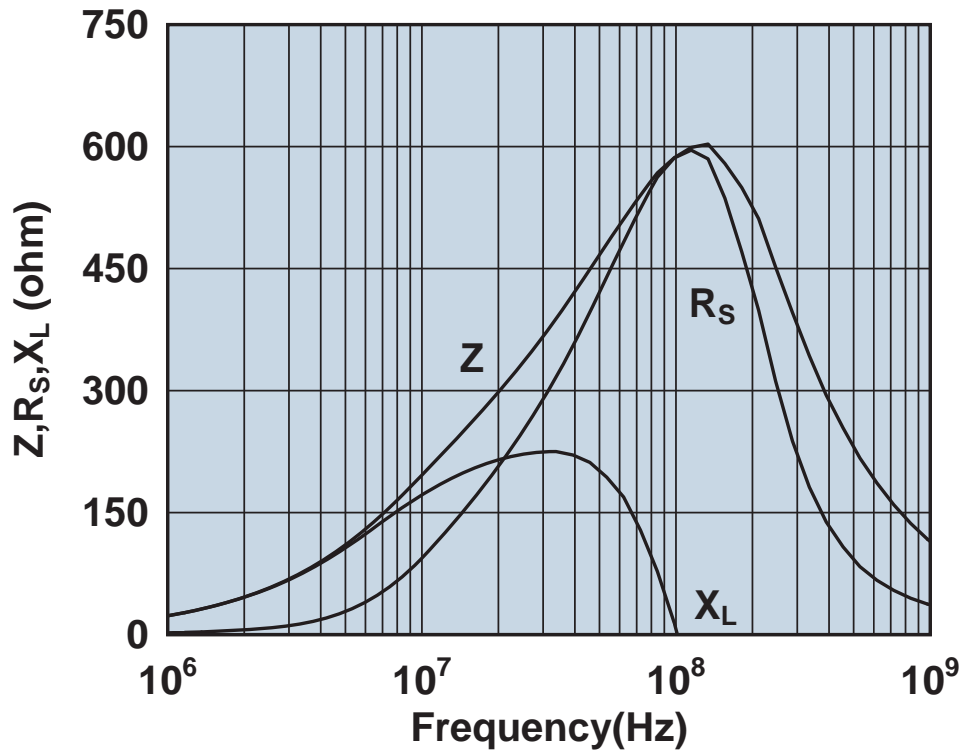

Impedance, reactance, and resistance vs. frequency.

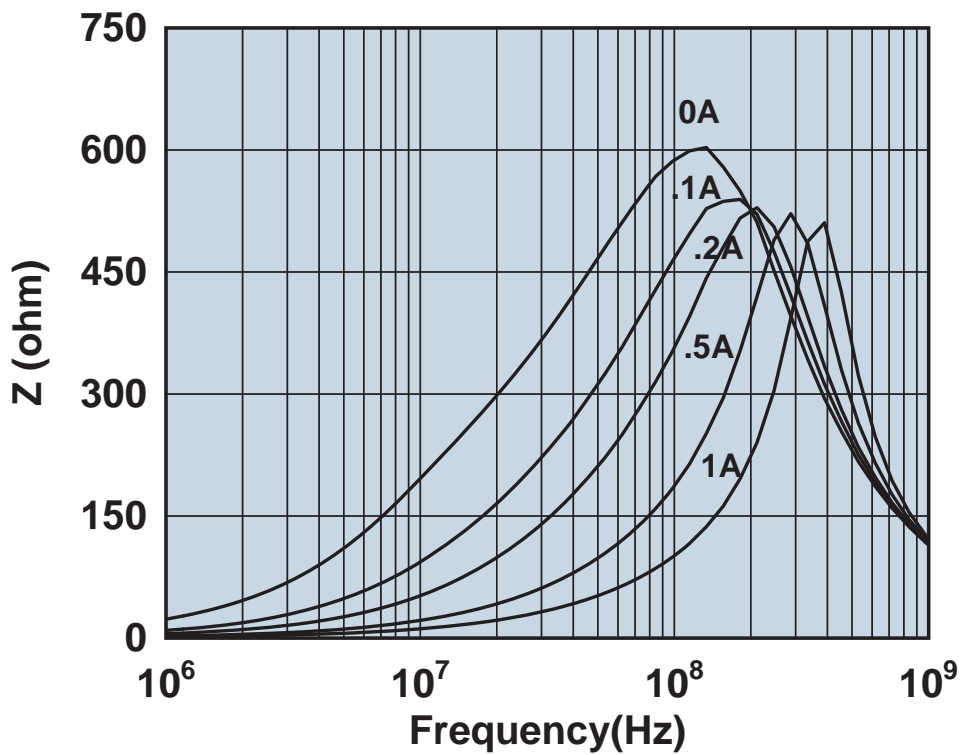

Impedance vs. frequency with dc bias.

2512067007Y0

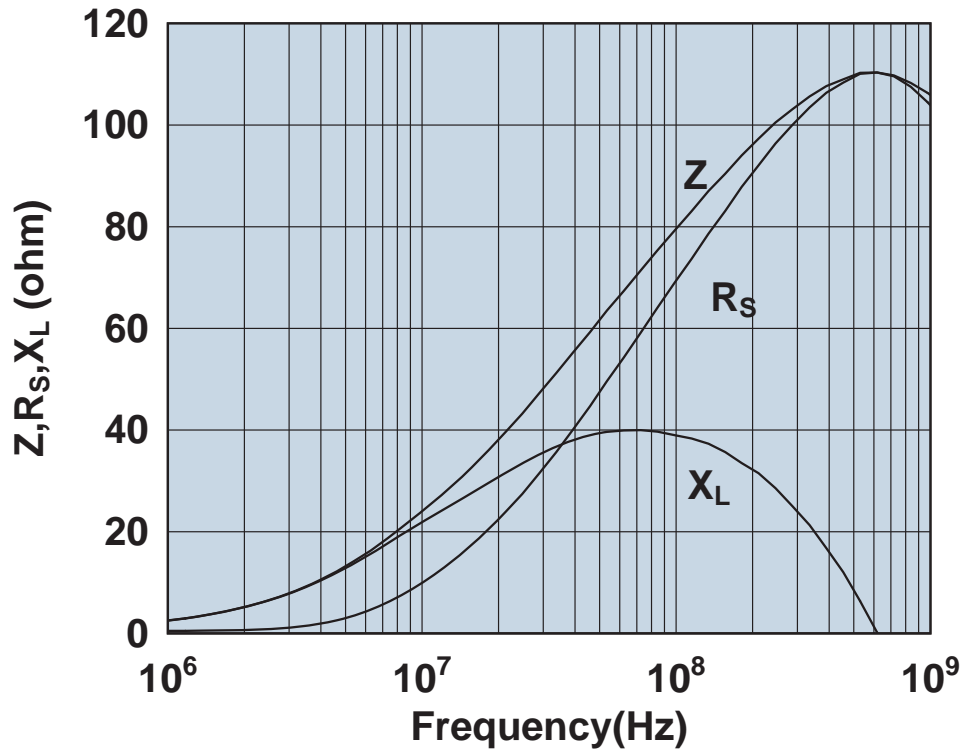

Impedance, reactance, and resistance vs. frequency.

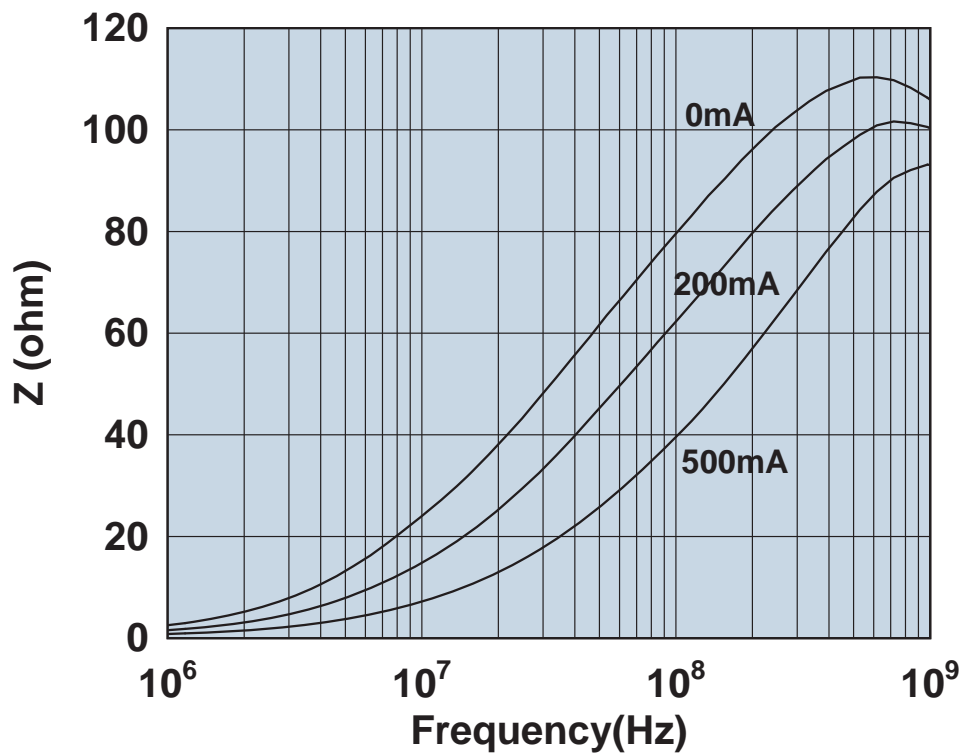

Impedance vs. frequency with dc bias.

2512067007Y3

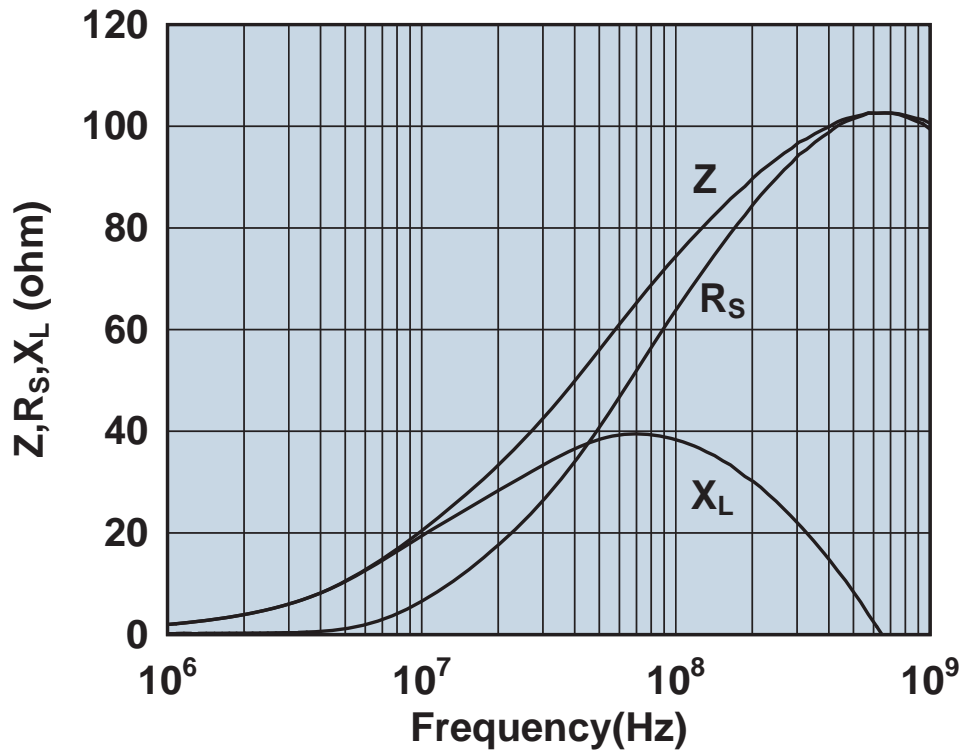

Impedance, reactance, and resistance vs. frequency.

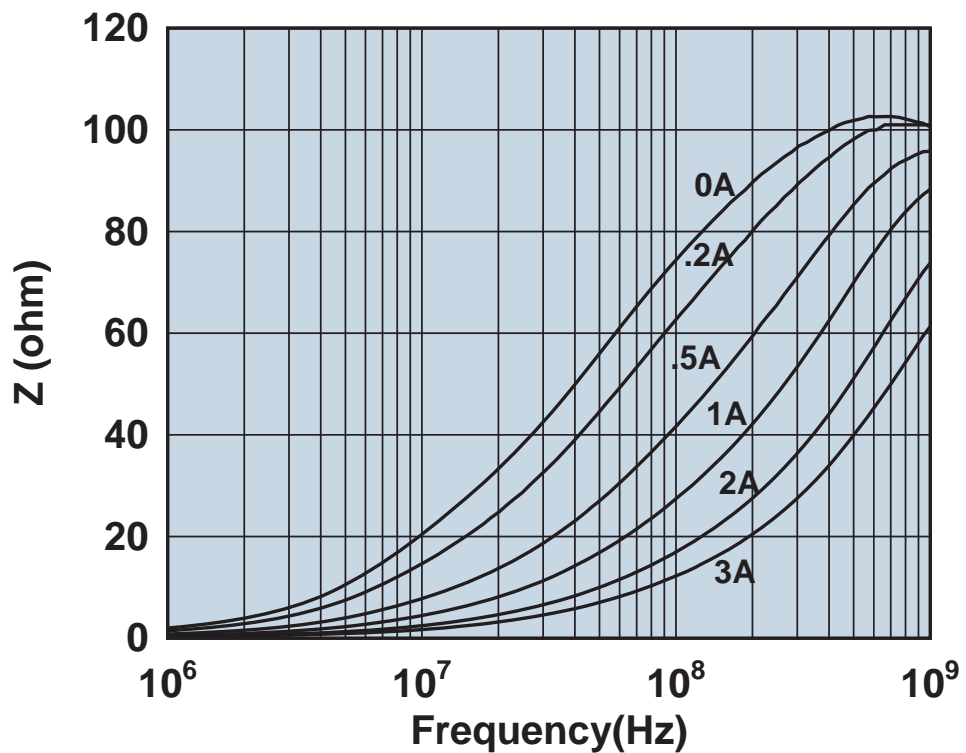

Impedance vs. frequency with dc bias.

2512069007Y0

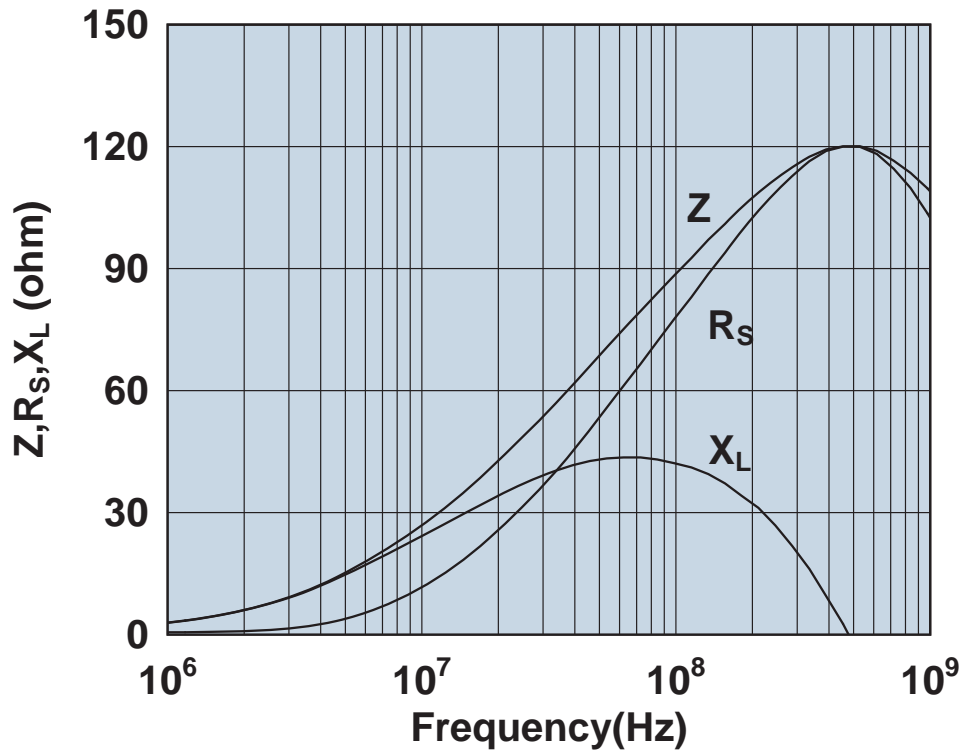

Impedance, reactance, and resistance vs. frequency.

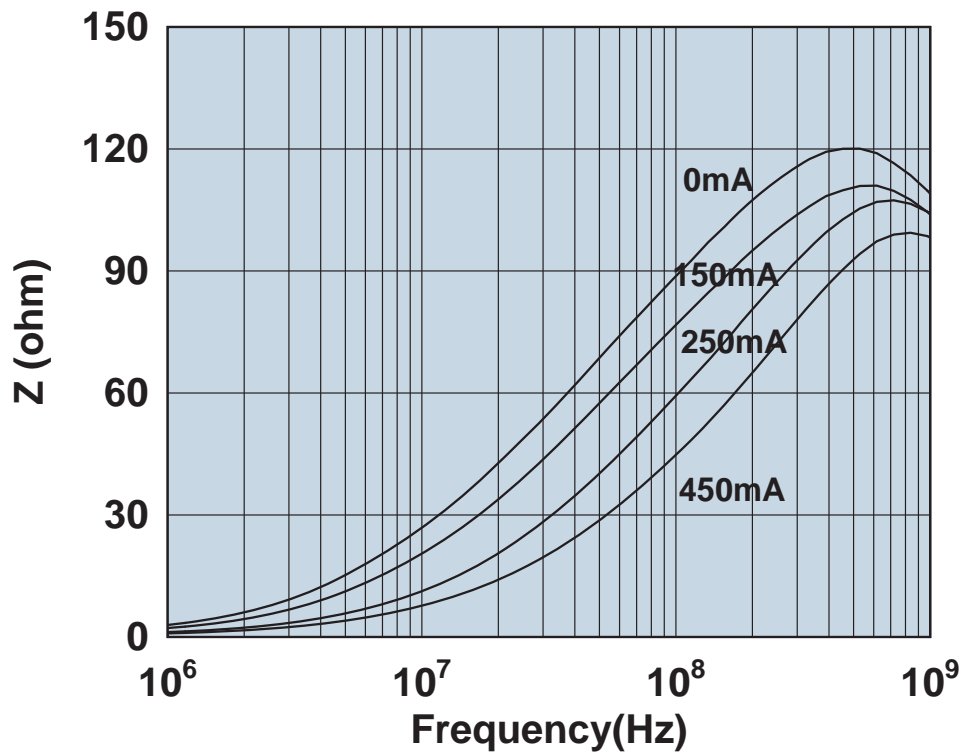

Impedance vs. frequency with dc bias.

2518061017Y0

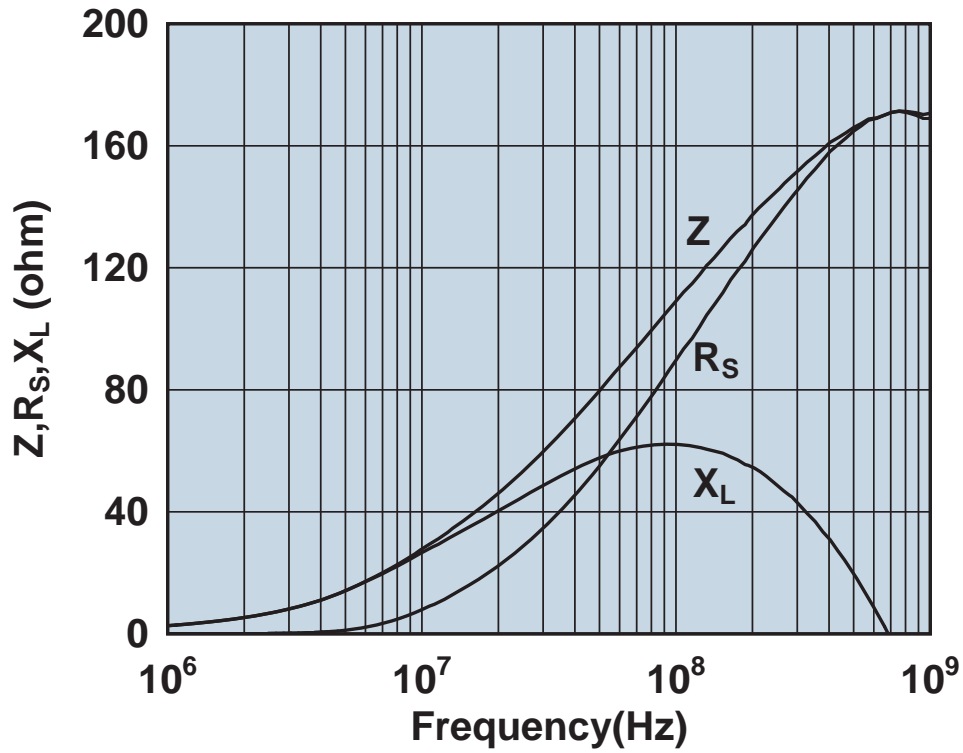

Impedance, reactance, and resistance vs. frequency.

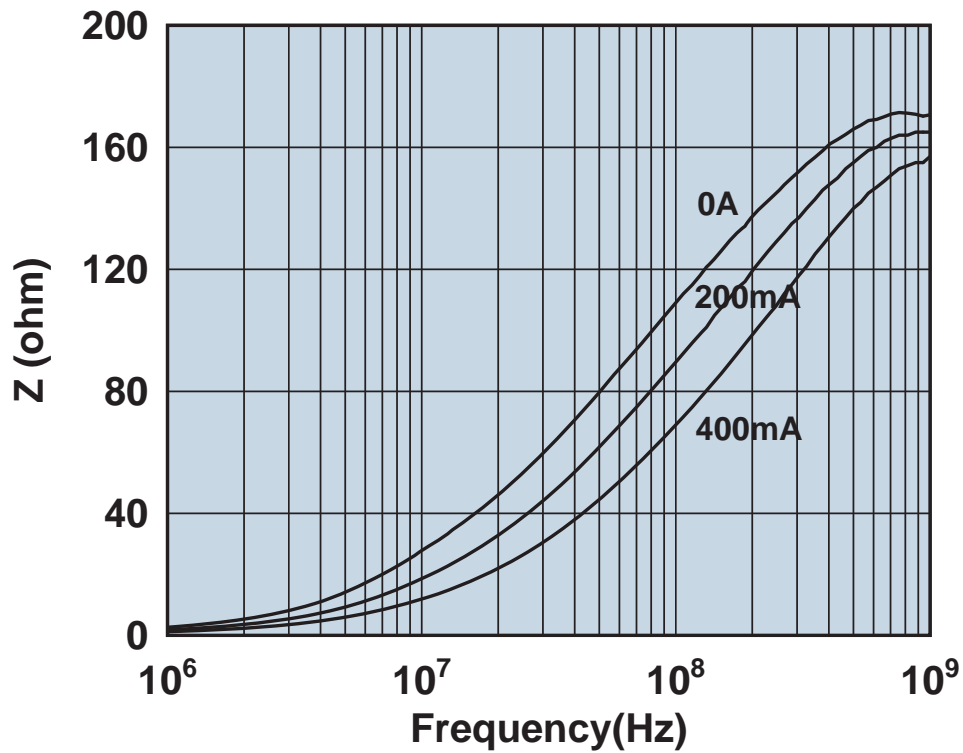

Impedance vs. frequency with dc bias.

2518061017Y6

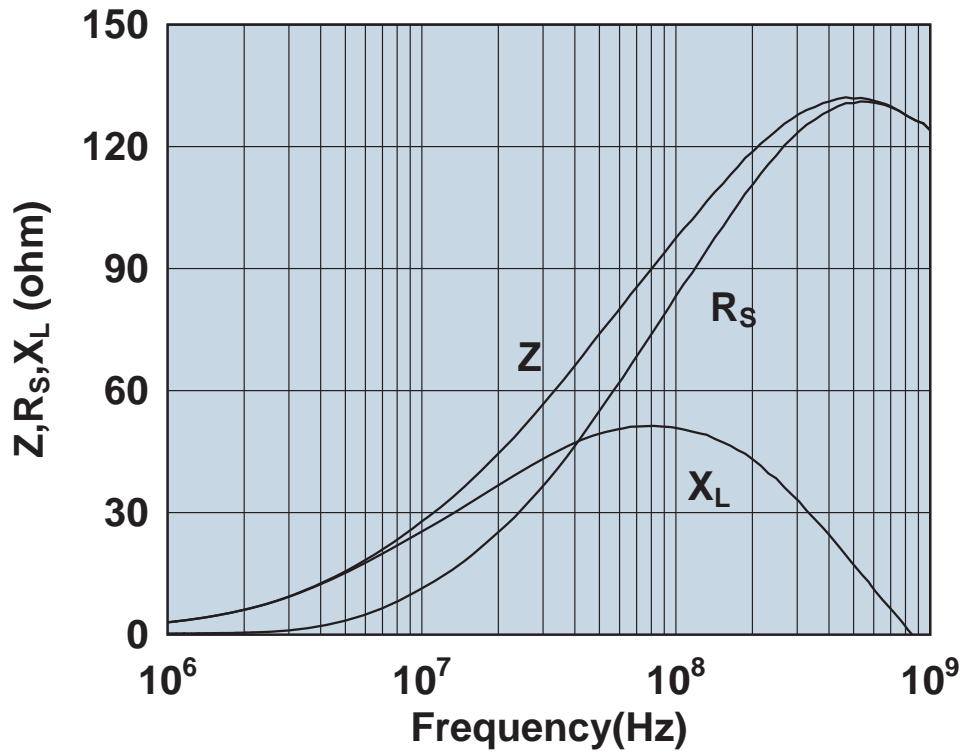

Impedance, reactance, and resistance vs. frequency.

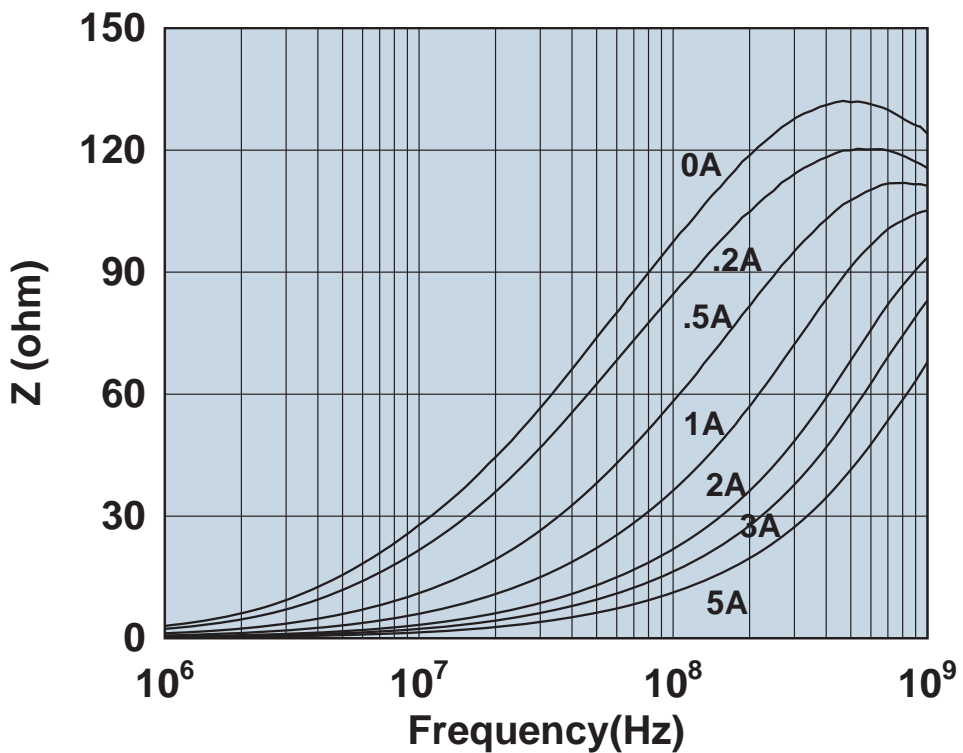

Impedance vs. frequency with dc bias.

2518061517Y0

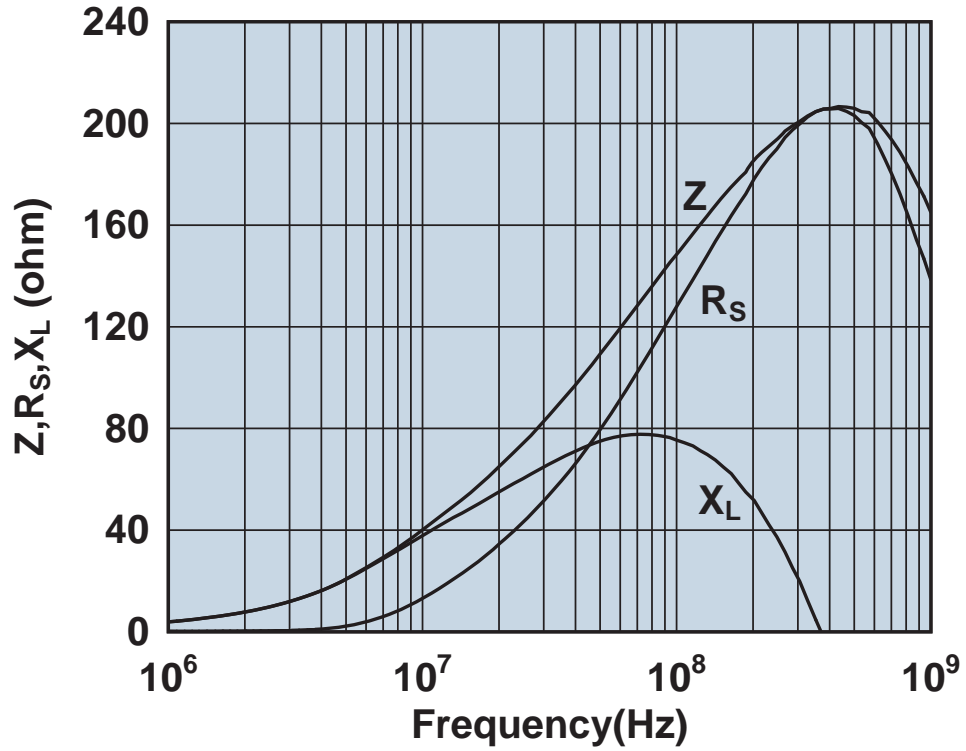

Impedance, reactance, and resistance vs. frequency.

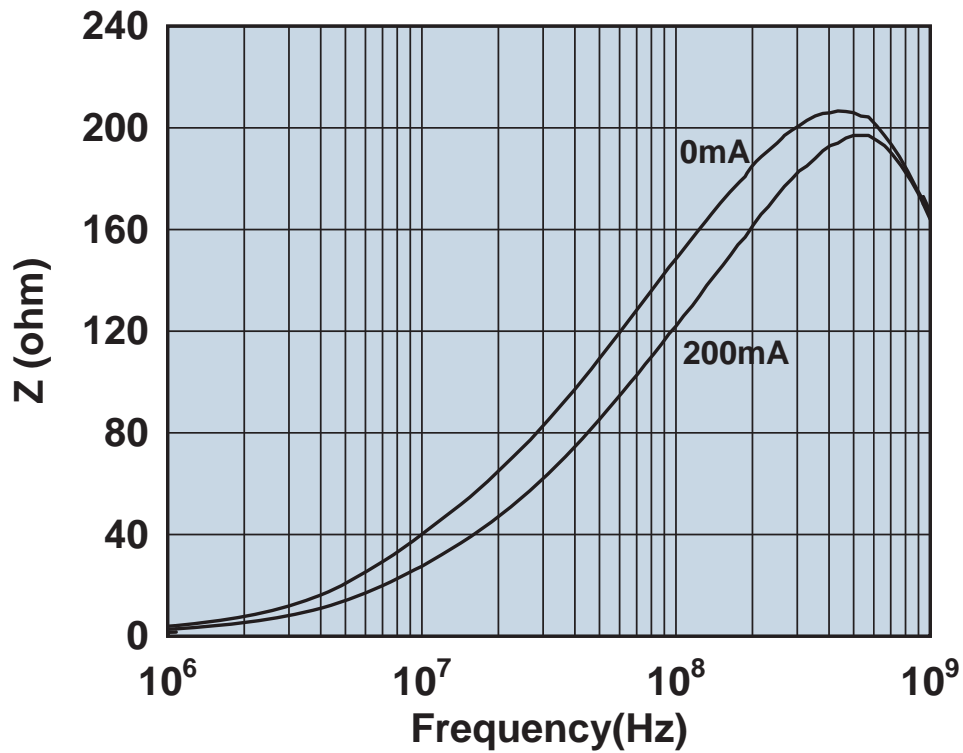

Impedance vs. frequency with dc bias.

2518065007Y6

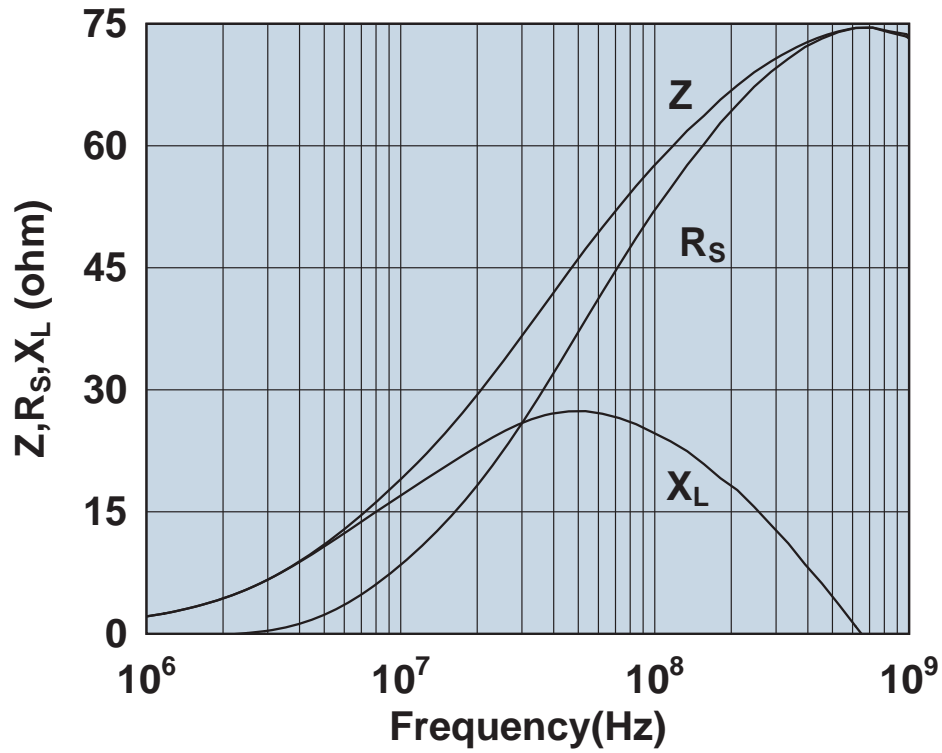

Impedance, reactance, and resistance vs. frequency.

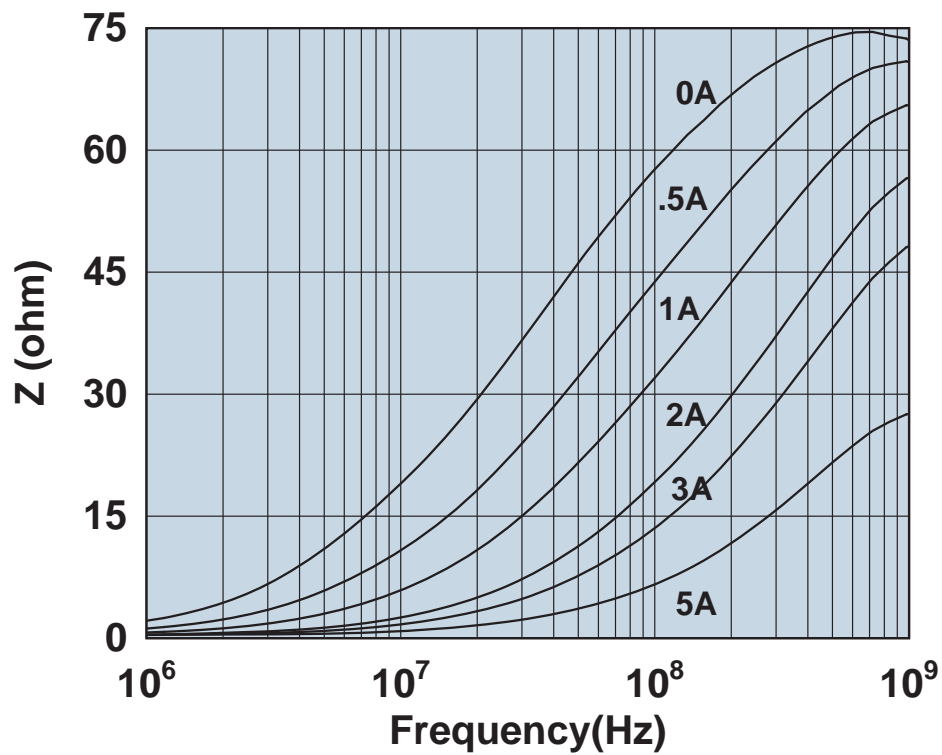

Impedance vs. frequency with dc bias.

2518066007Y3

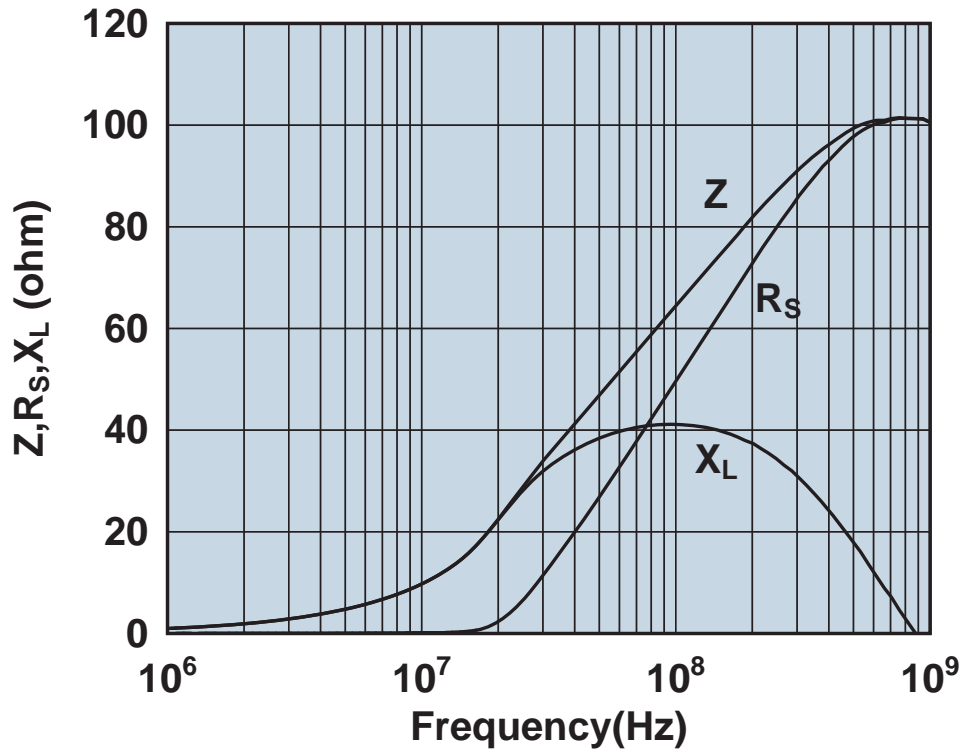

Impedance, reactance, and resistance vs. frequency.

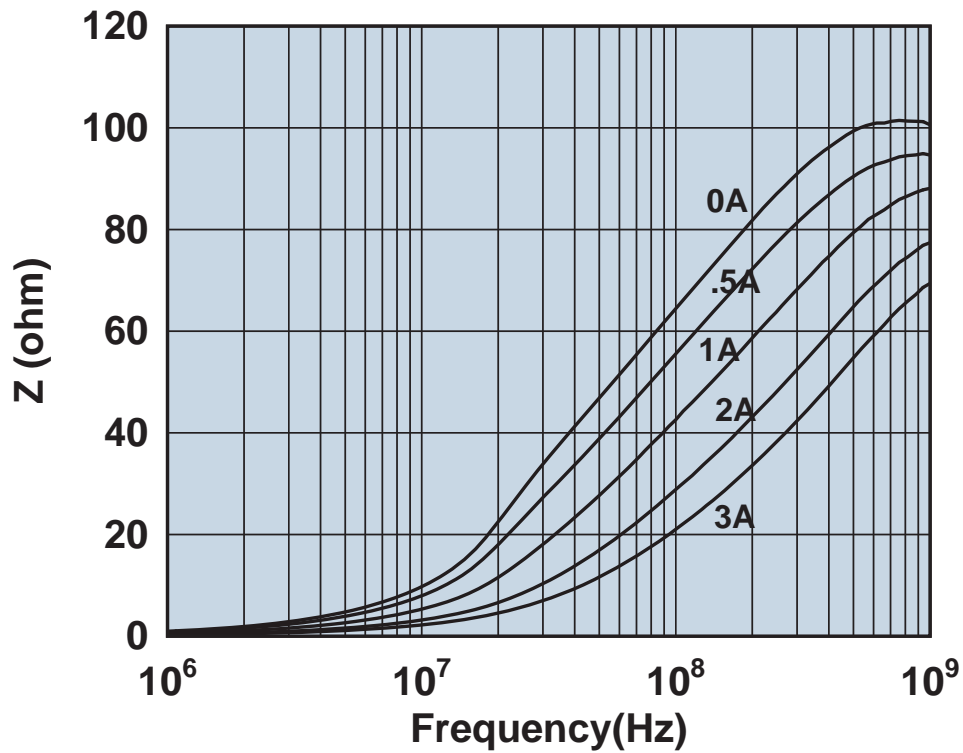

Impedance vs. frequency with dc bias.

2518068007Y3

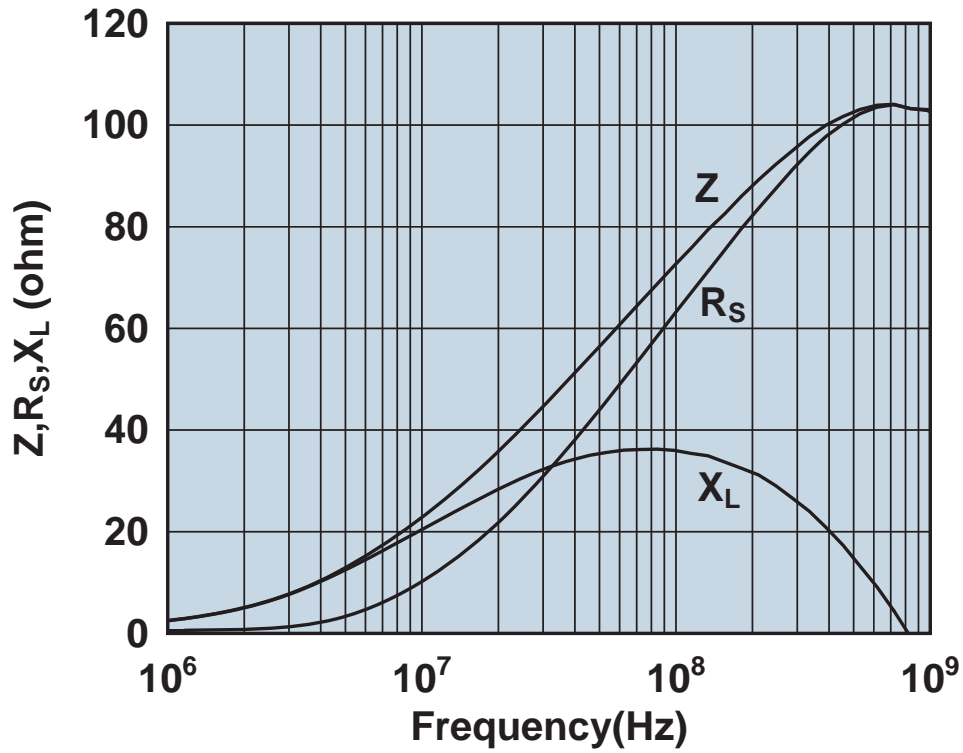

Impedance, reactance, and resistance vs. frequency.

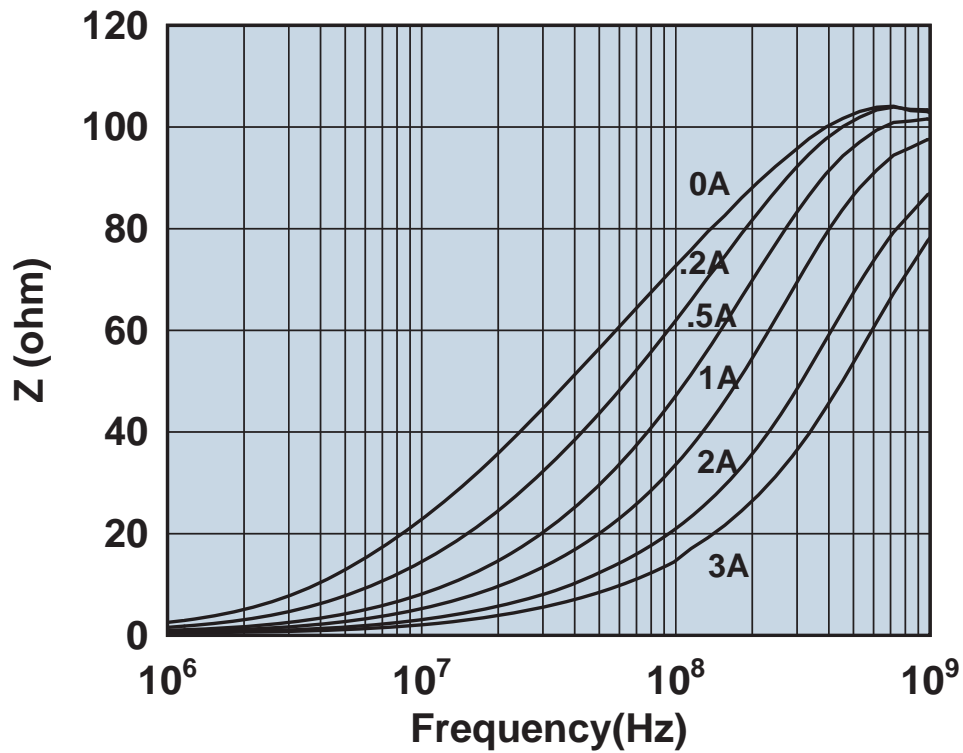

Impedance vs. frequency with dc bias.

2518121217Y3

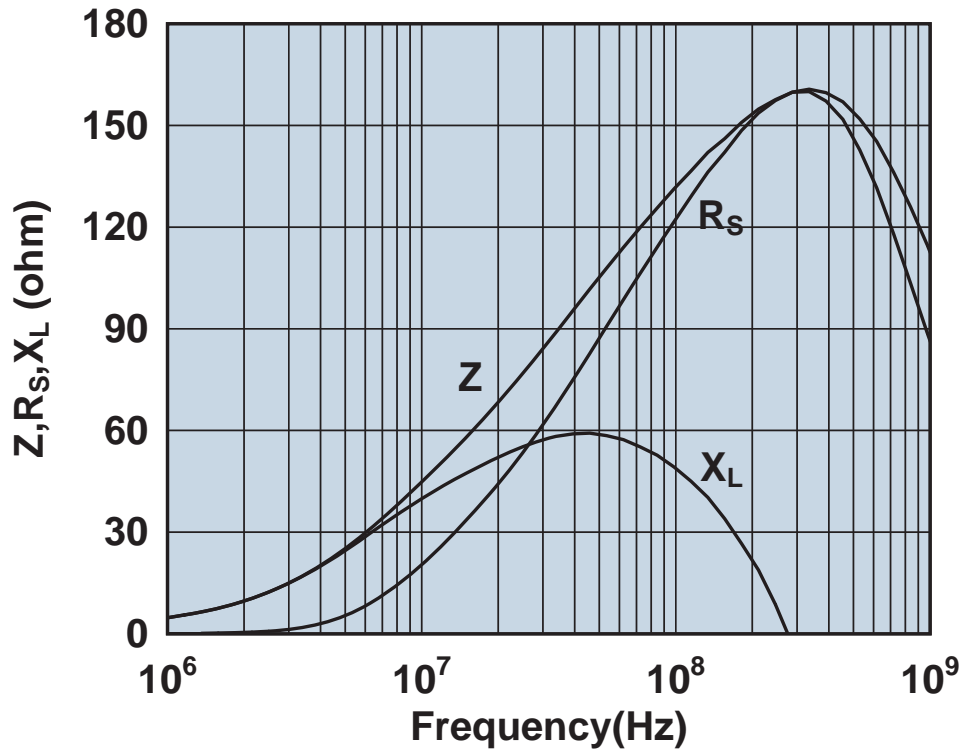

Impedance, reactance, and resistance vs. frequency.

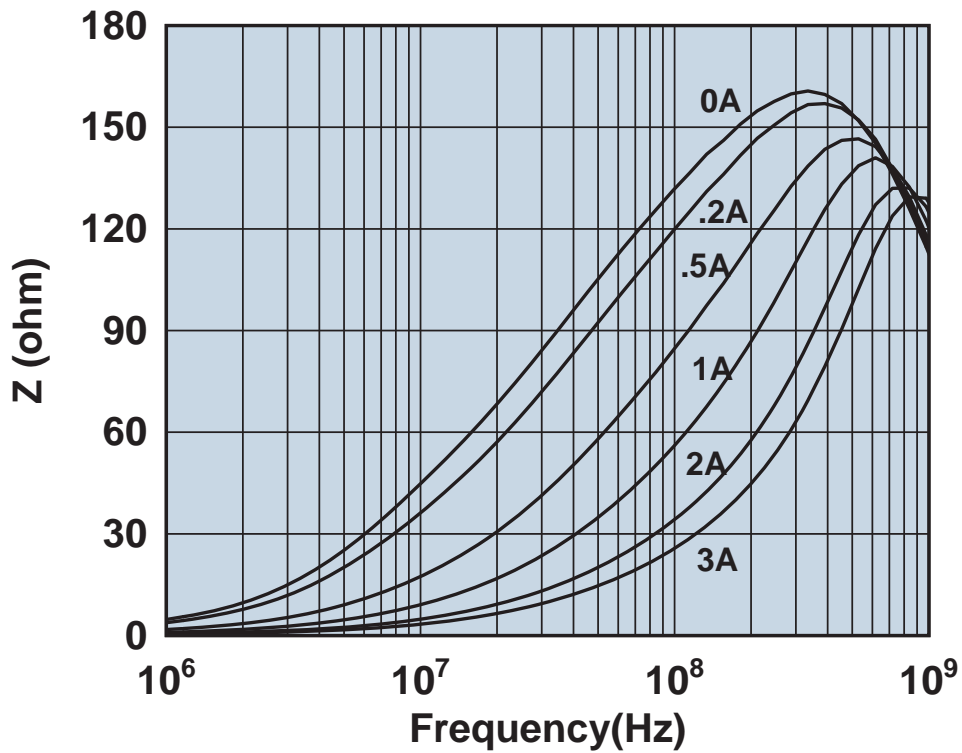

Impedance vs. frequency with dc bias.

2518121217Y6

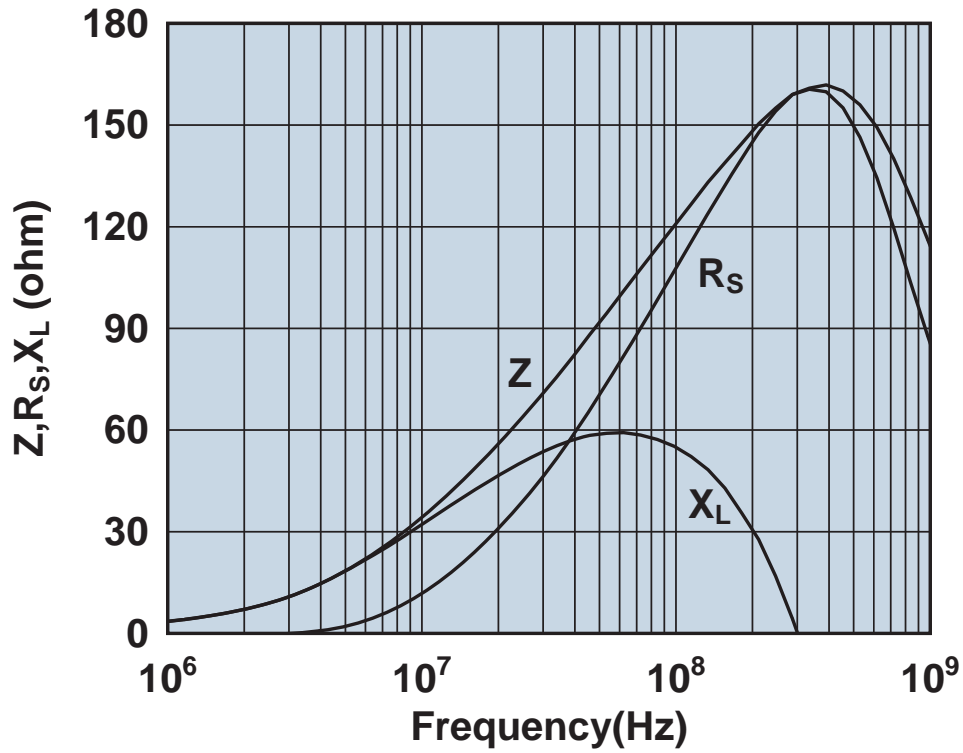

Impedance, reactance, and resistance vs. frequency.

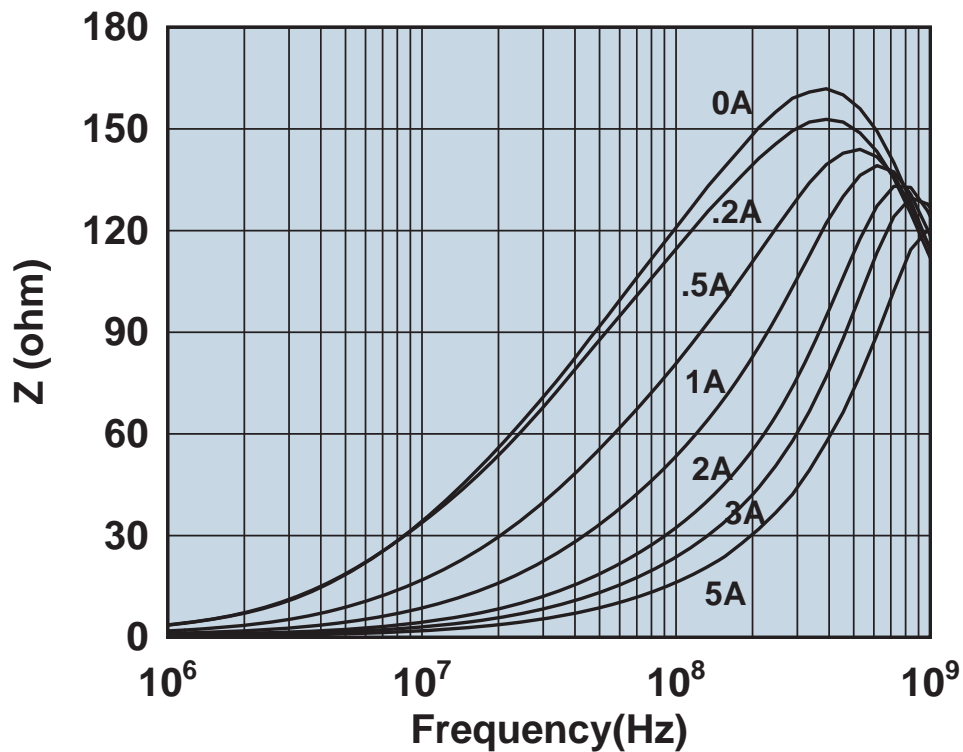

Impedance vs. frequency with dc bias.

2518127007Y3

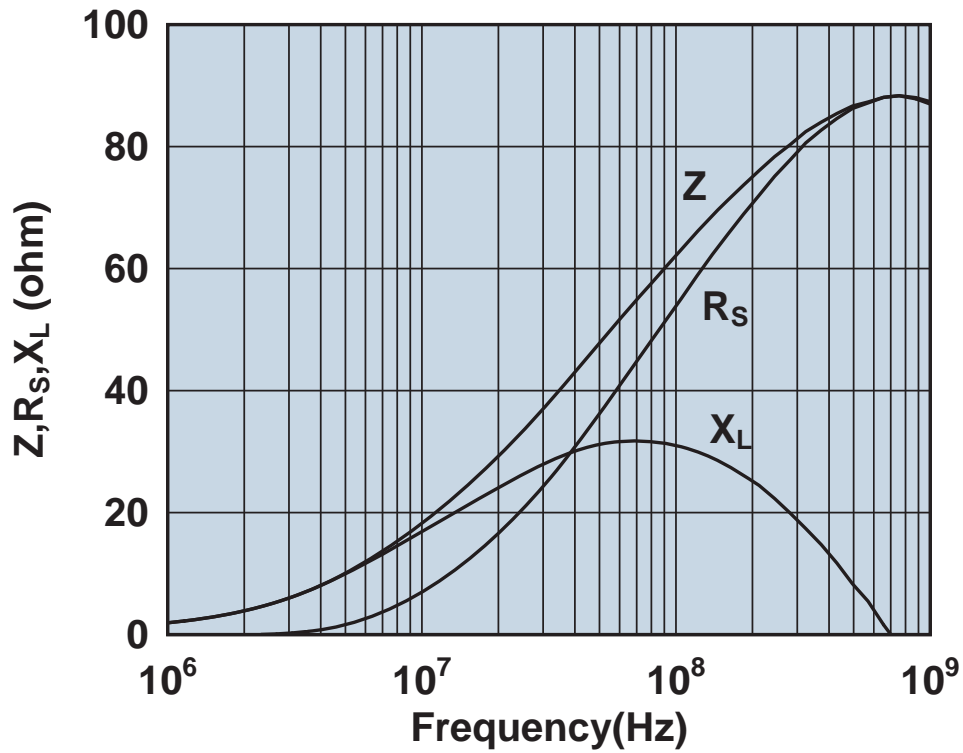

Impedance, reactance, and resistance vs. frequency.

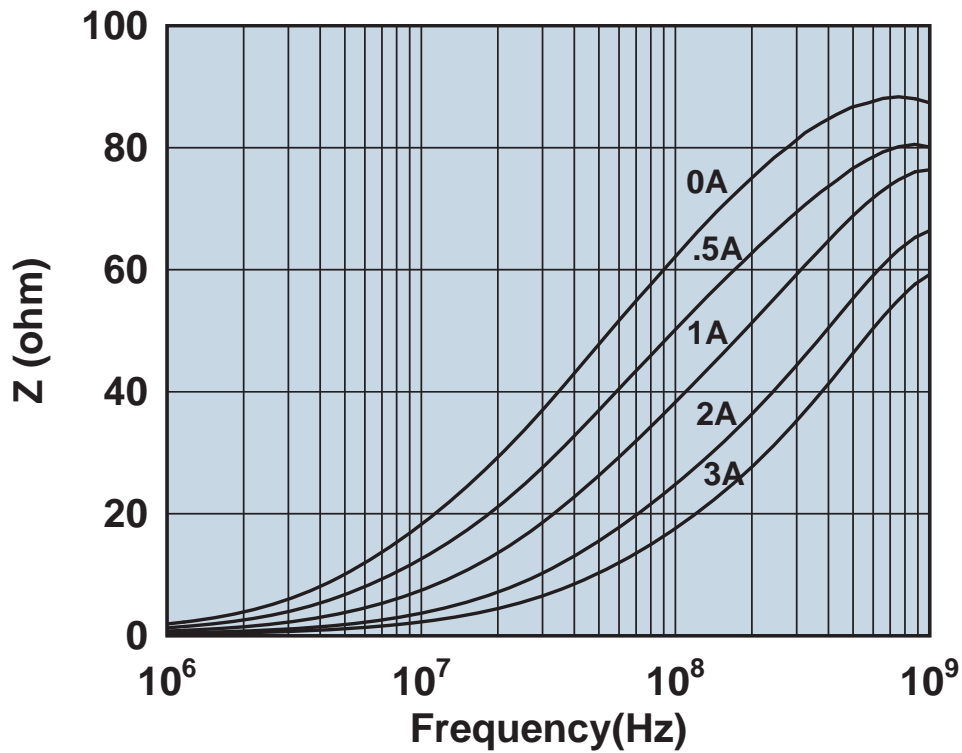

Impedance vs. frequency with dc bias.

2631023002

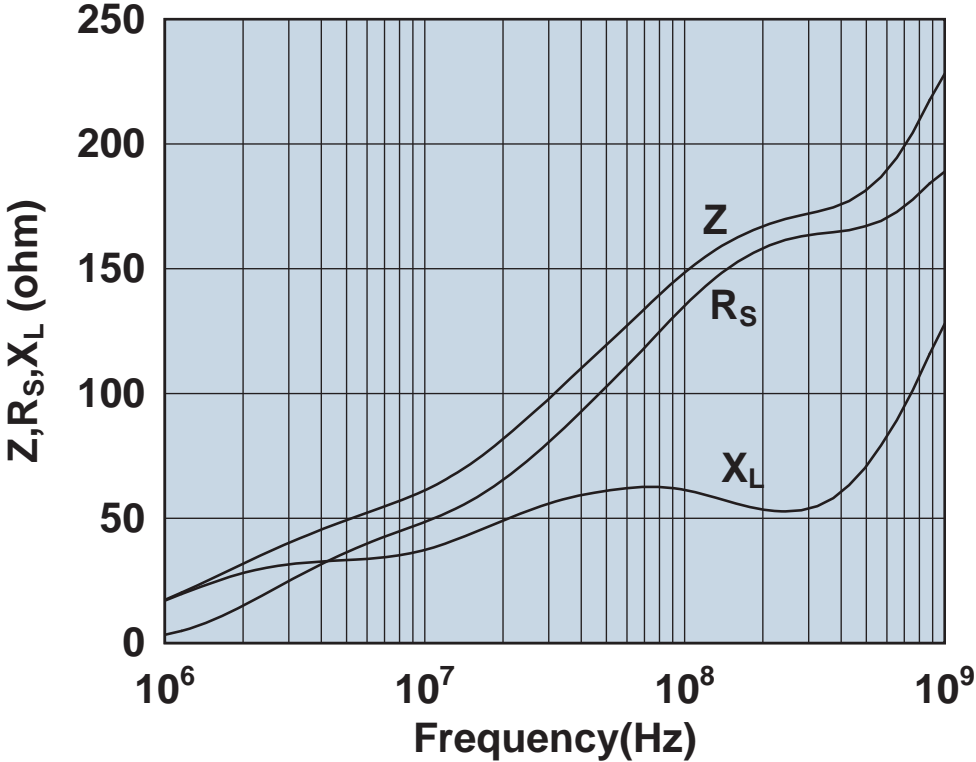

Impedance, reactance, and resistance vs. frequency.

2631101902

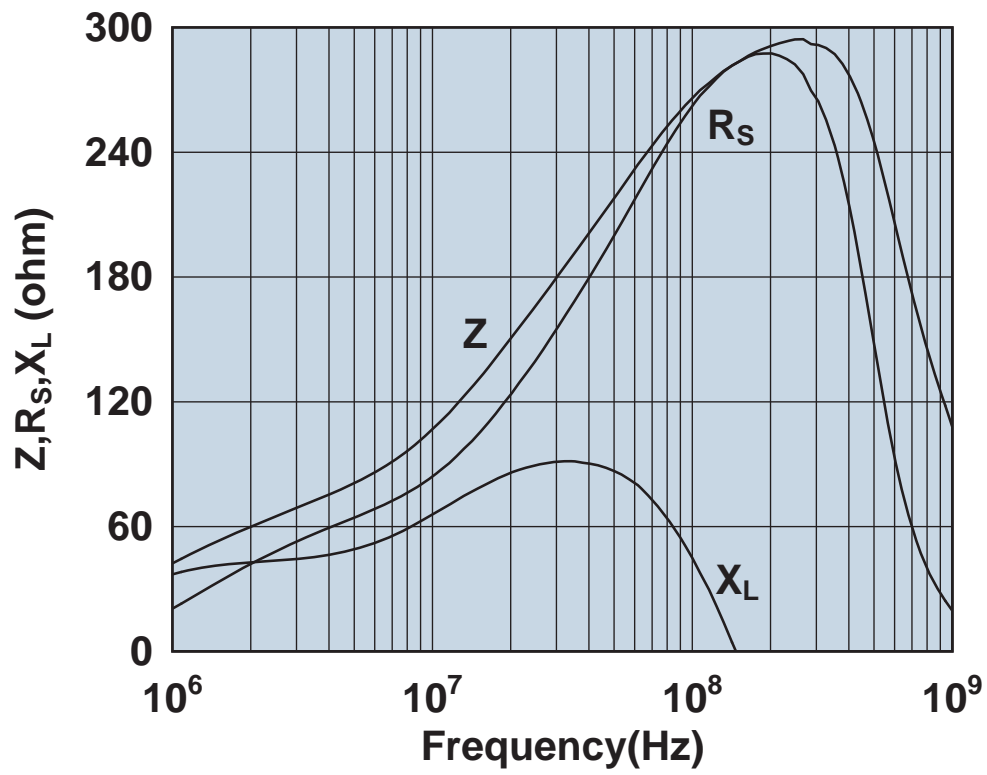

Impedance, reactance, and resistance vs. frequency.

2631102002

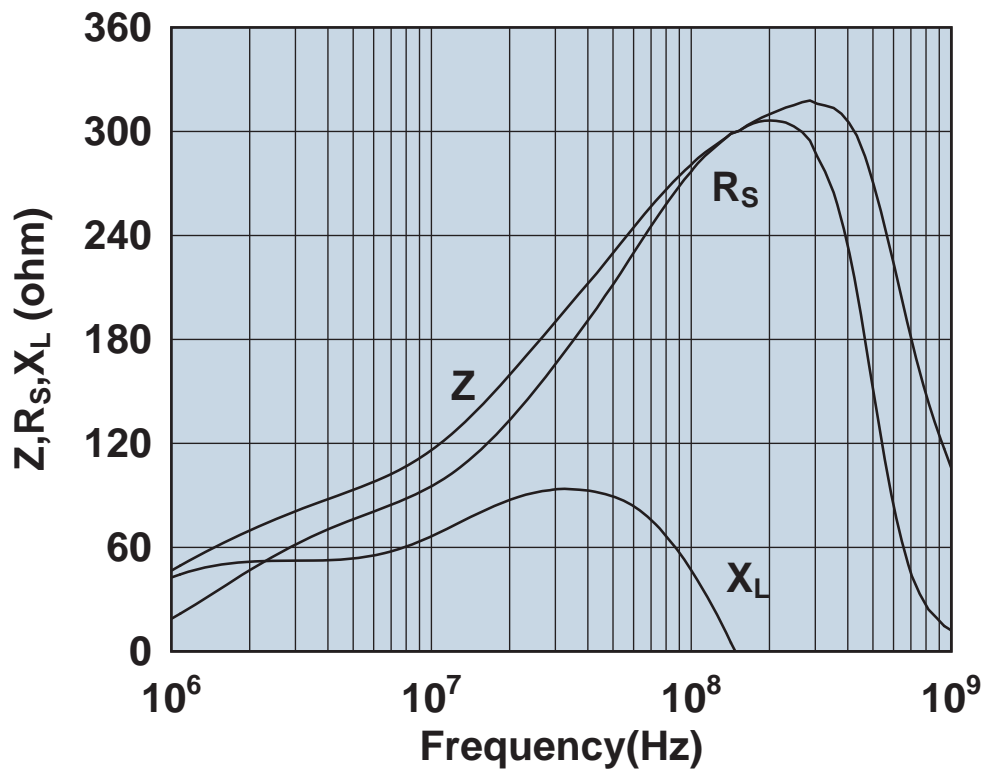

Impedance, reactance, and resistance vs. frequency.

2631103002

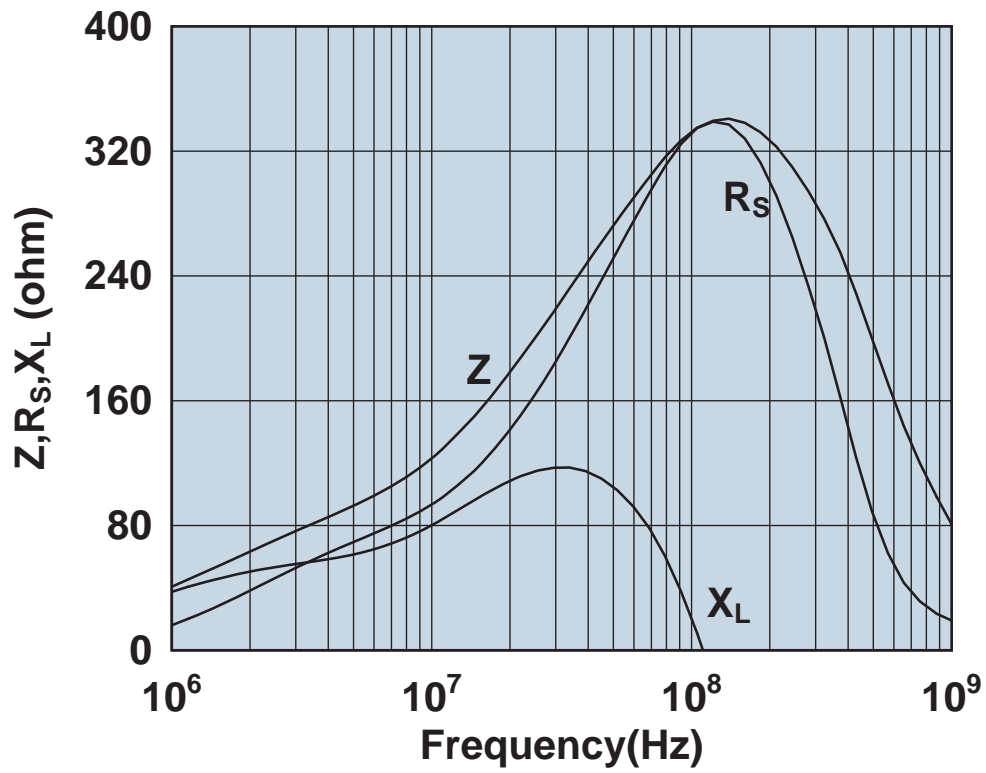

Impedance, reactance, and resistance vs. frequency.

2631163851

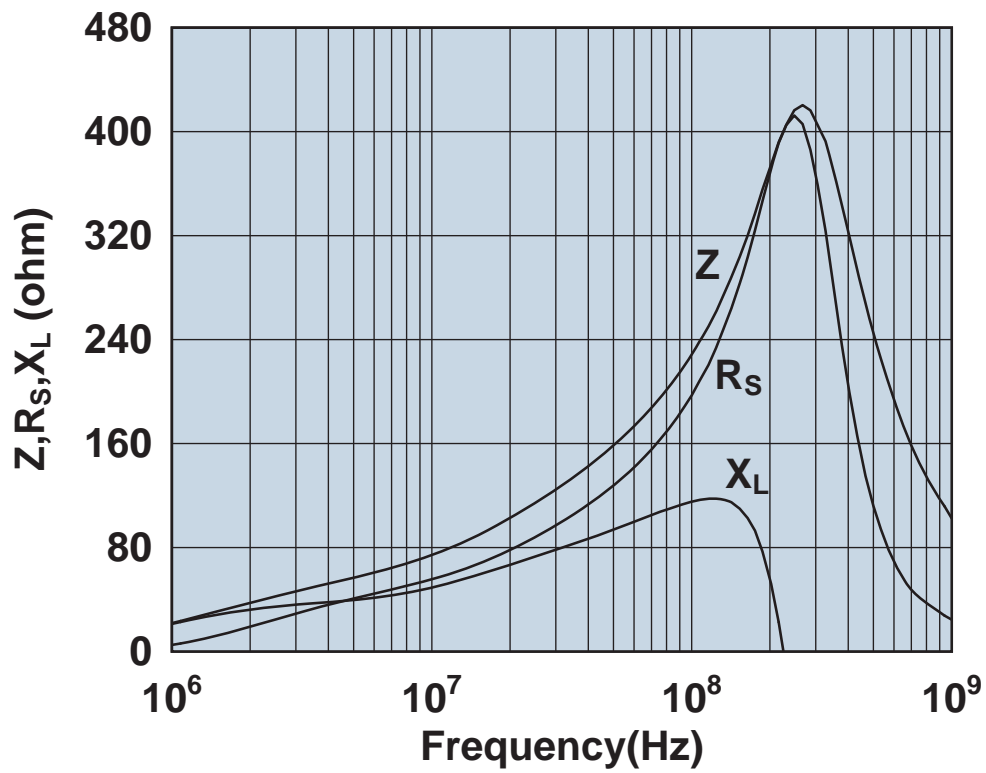

Impedance, reactance, and resistance vs. frequency.

2631163951

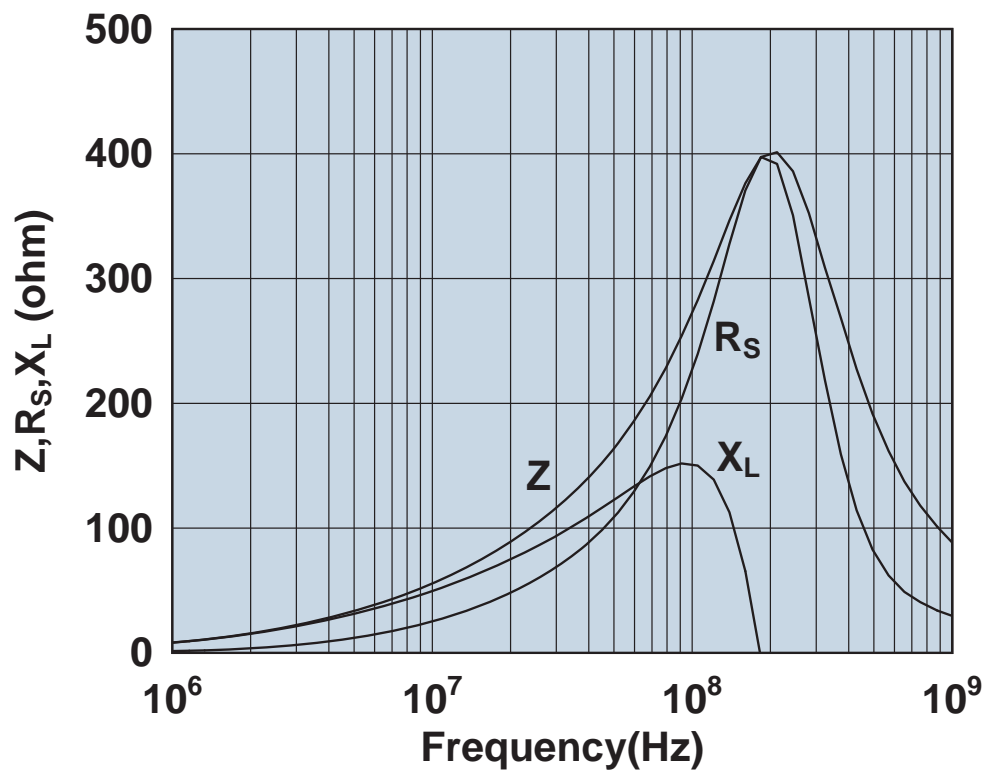

Impedance, reactance, and resistance vs. frequency.

2631164051

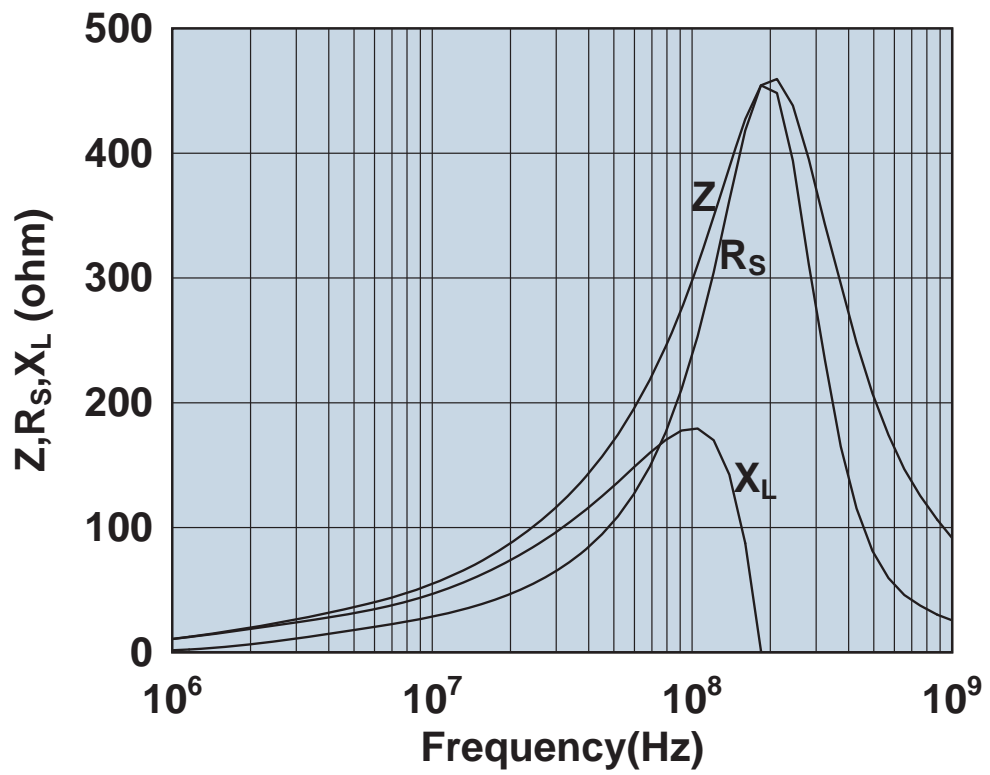

Impedance, reactance, and resistance vs. frequency.

2631164181

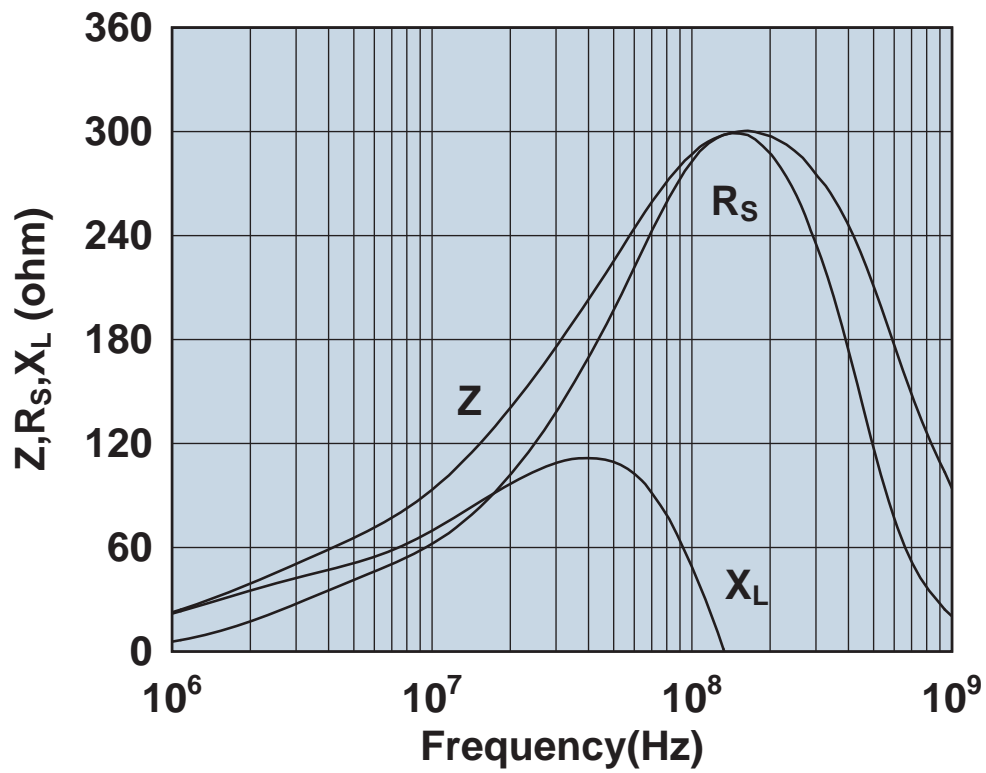

Impedance, reactance, and resistance vs. frequency.

2631164281

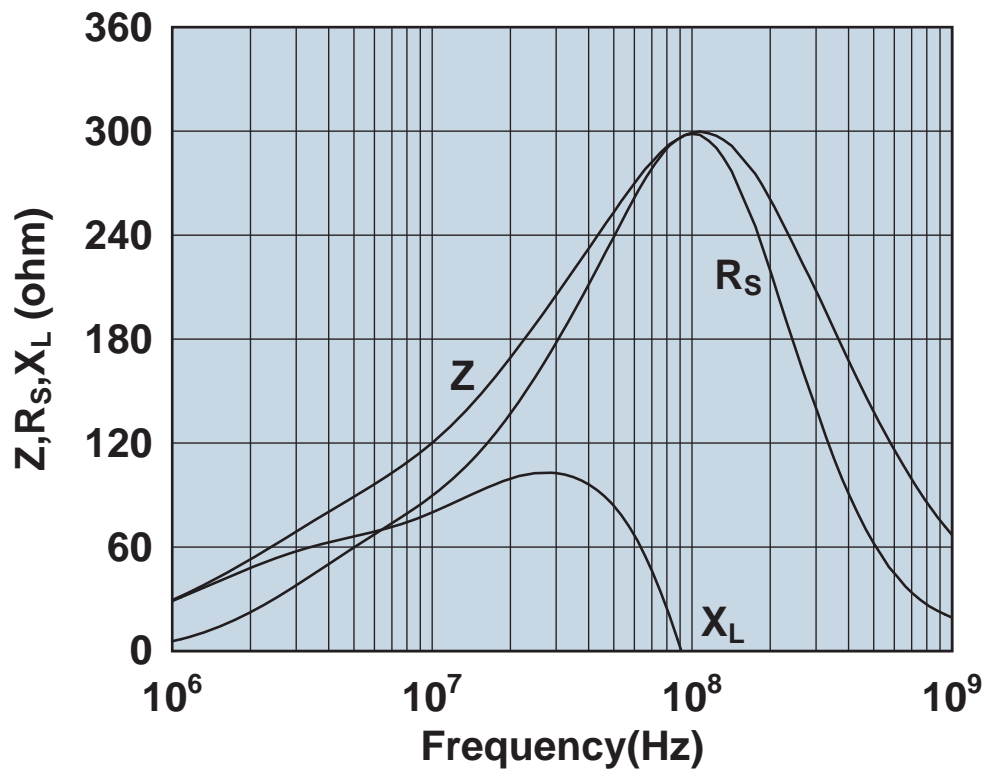

Impedance, reactance, and resistance vs. frequency.

2631164951

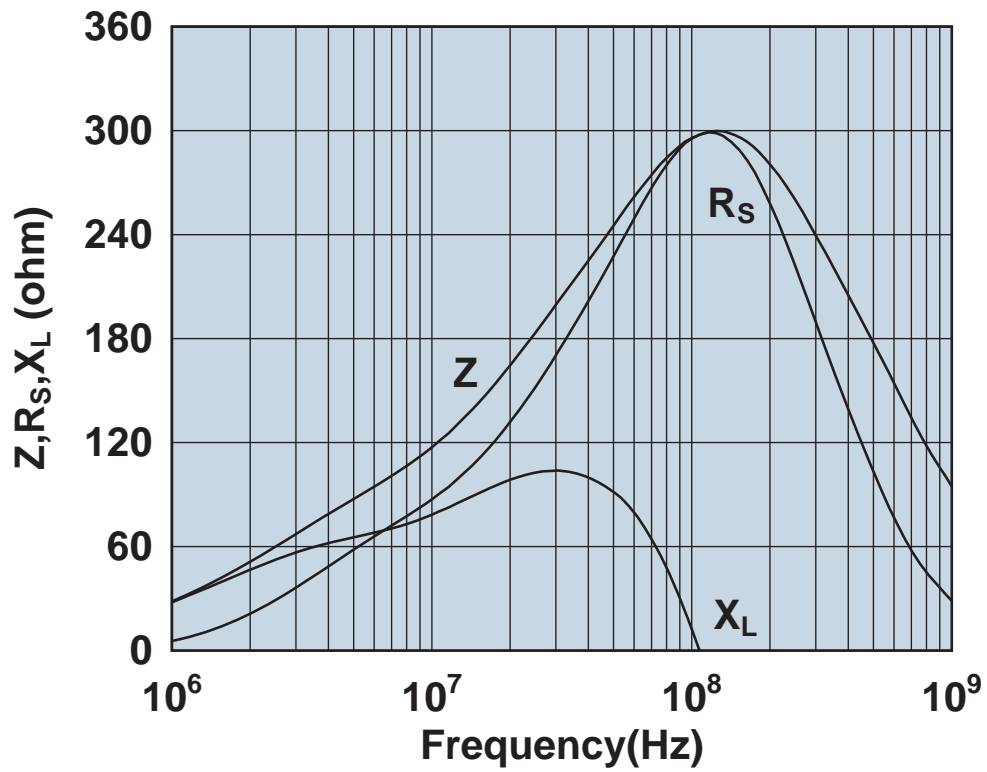

Impedance, reactance, and resistance vs. frequency.

2631167281

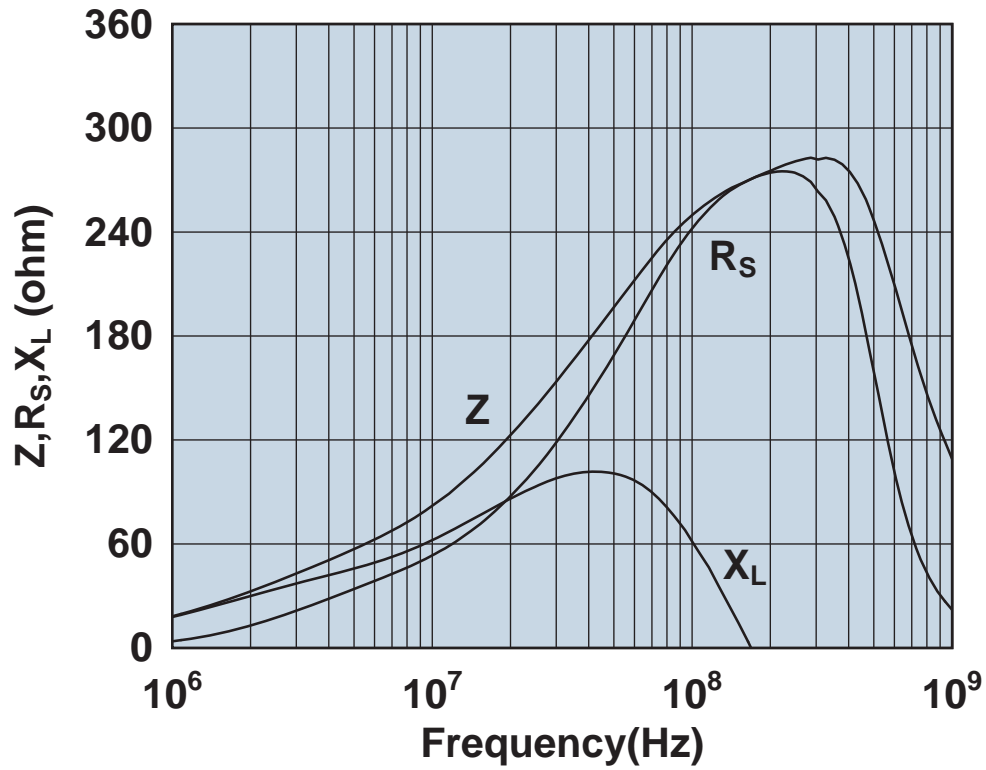

Impedance, reactance, and resistance vs. frequency.

2631173551

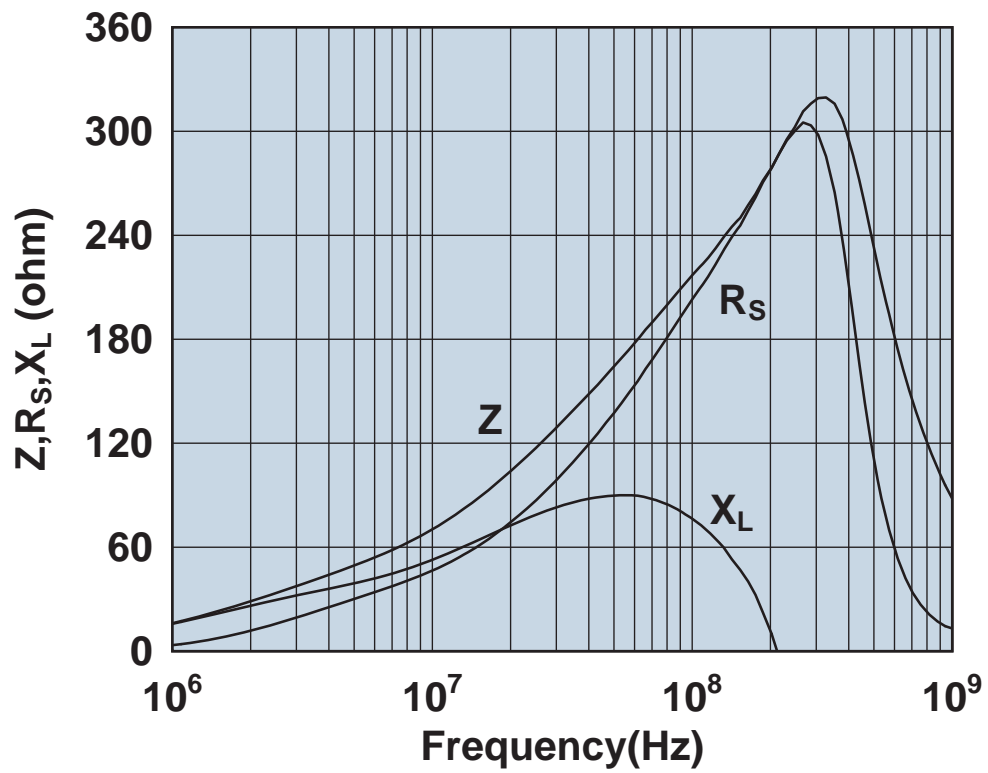

Impedance, reactance, and resistance vs. frequency.

2631173951

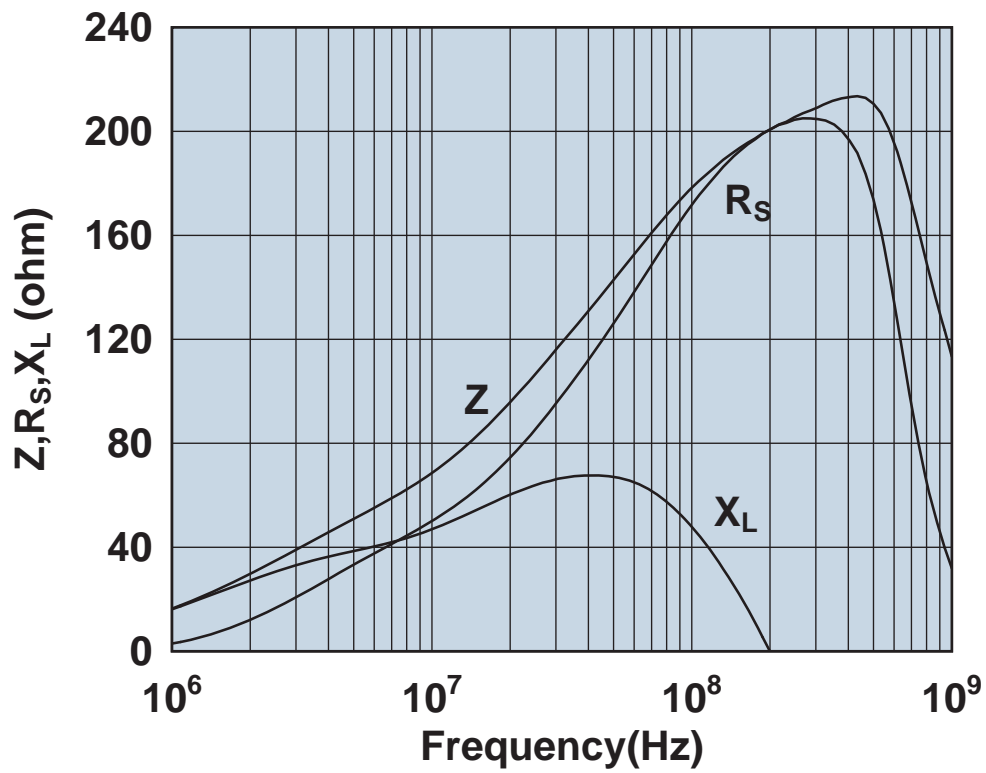

Impedance, reactance, and resistance vs. frequency.

2631176451

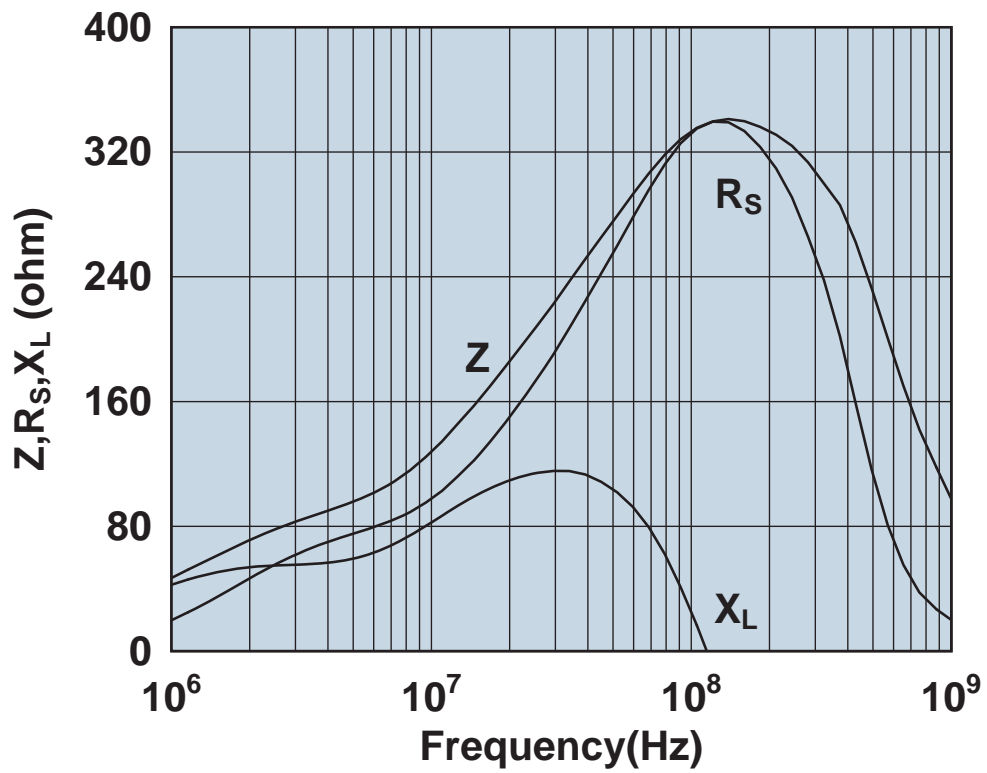

Impedance, reactance, and resistance vs. frequency.

2631177081

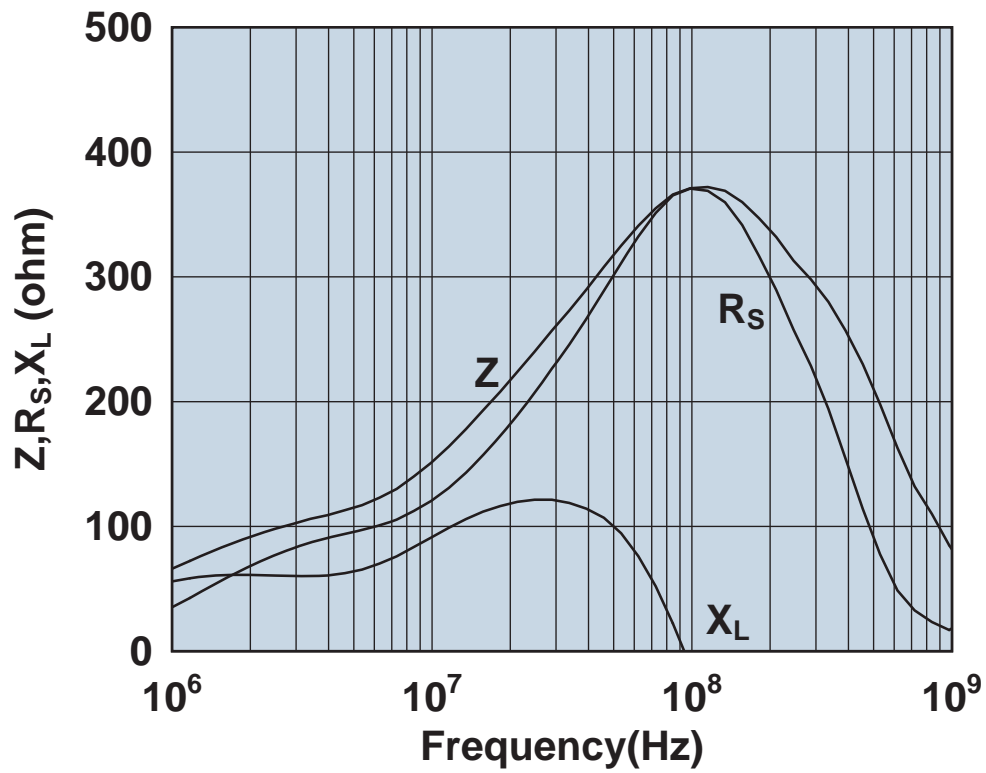

Impedance, reactance, and resistance vs. frequency.

2631178181

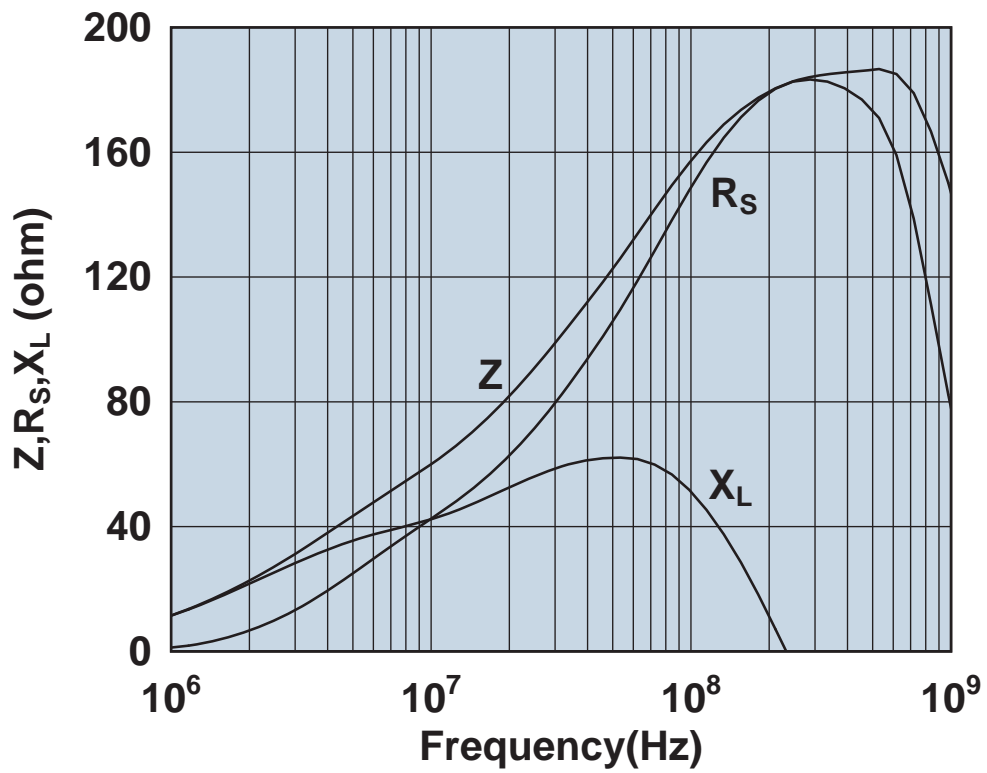

Impedance, reactance, and resistance vs. frequency.

2631178281

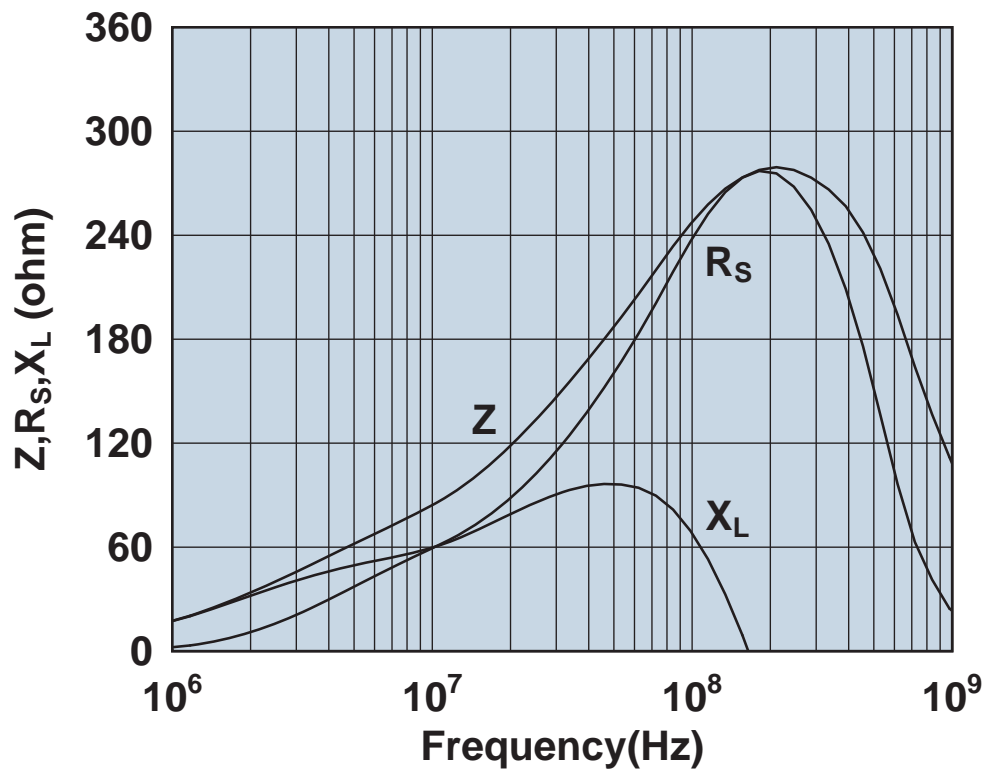

Impedance, reactance, and resistance vs. frequency.

2631250202

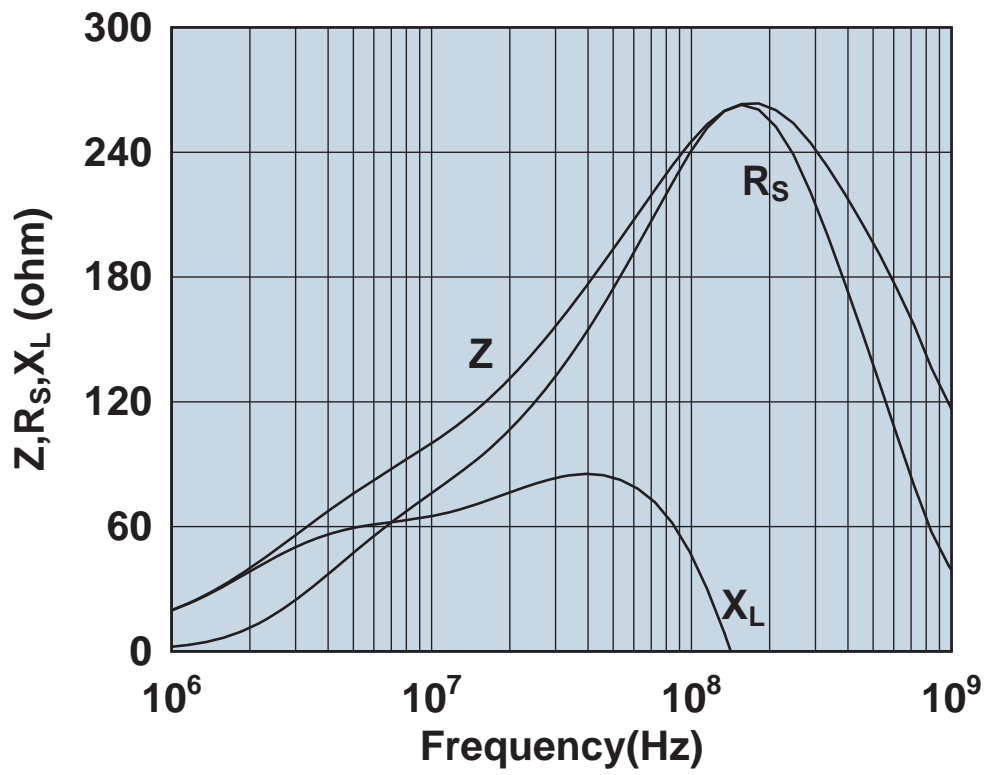

Impedance, reactance, and resistance vs. frequency.

2631480002

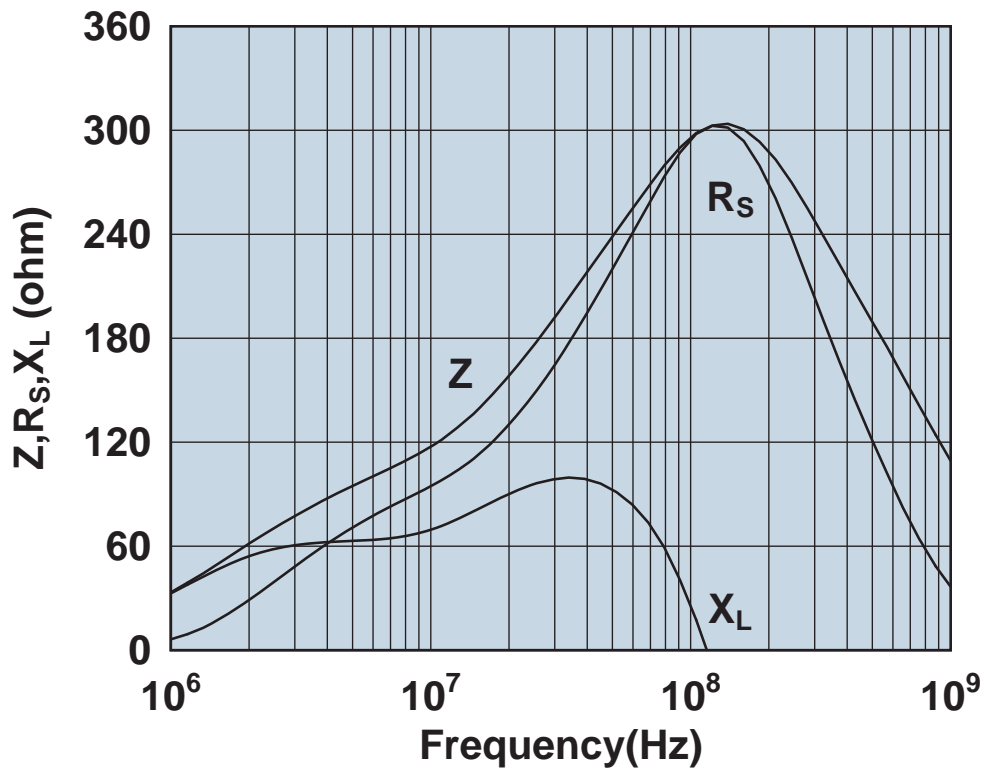

Impedance, reactance, and resistance vs. frequency.

2631480102

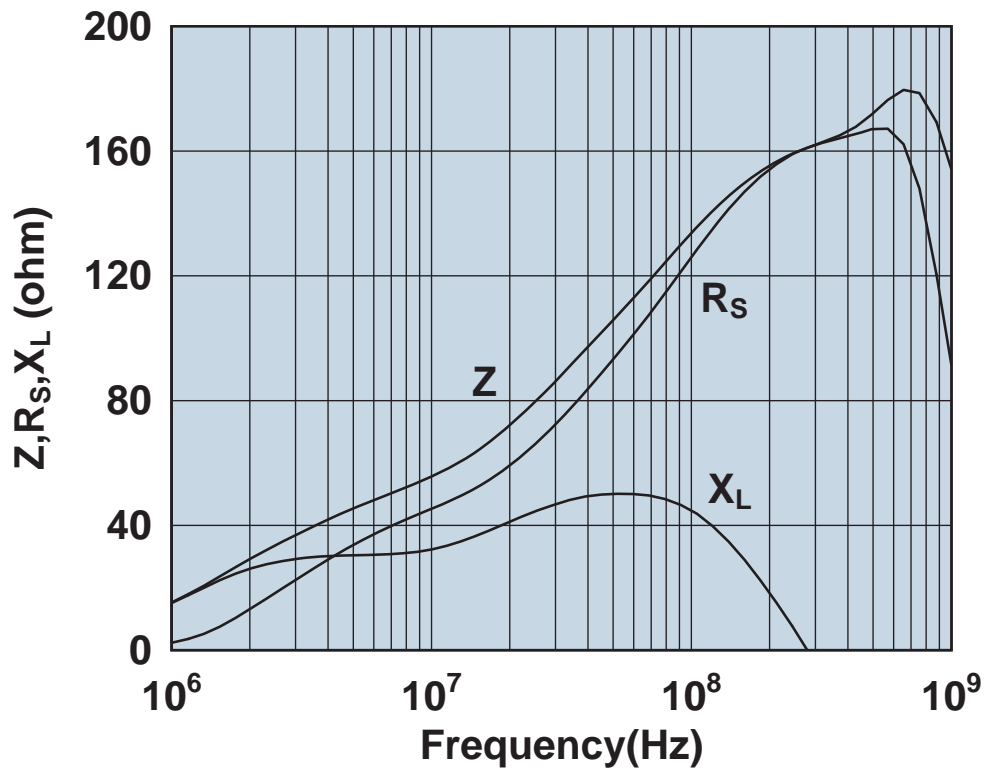

Impedance, reactance, and resistance vs. frequency.

2631540002

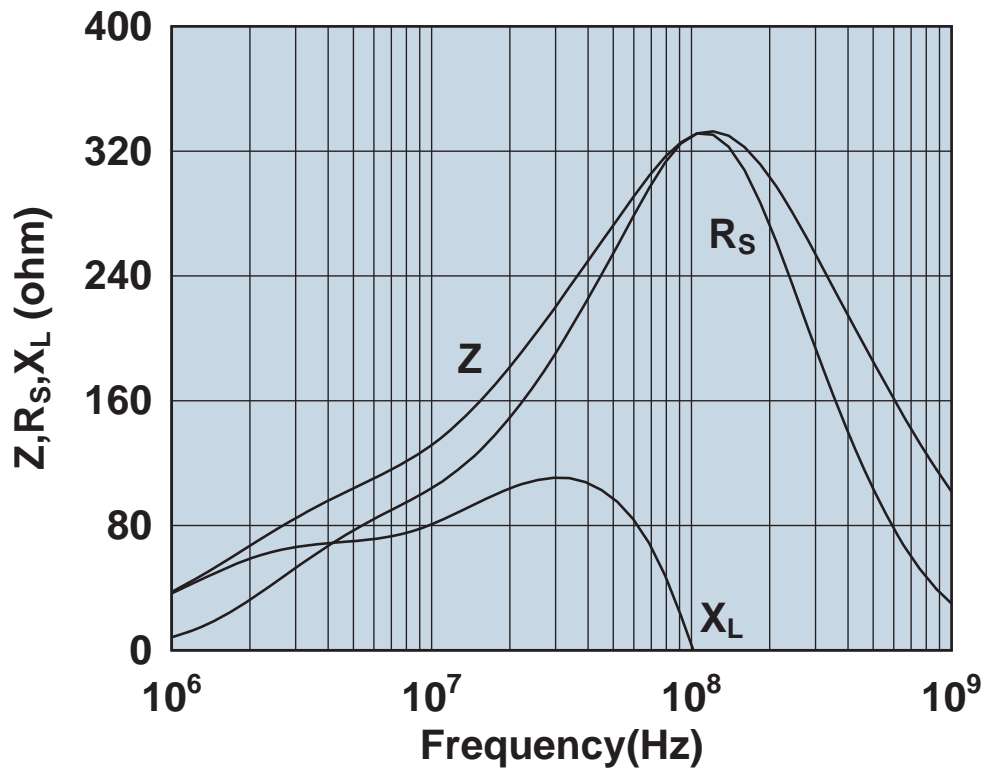

Impedance, reactance, and resistance vs. frequency.

2631540202

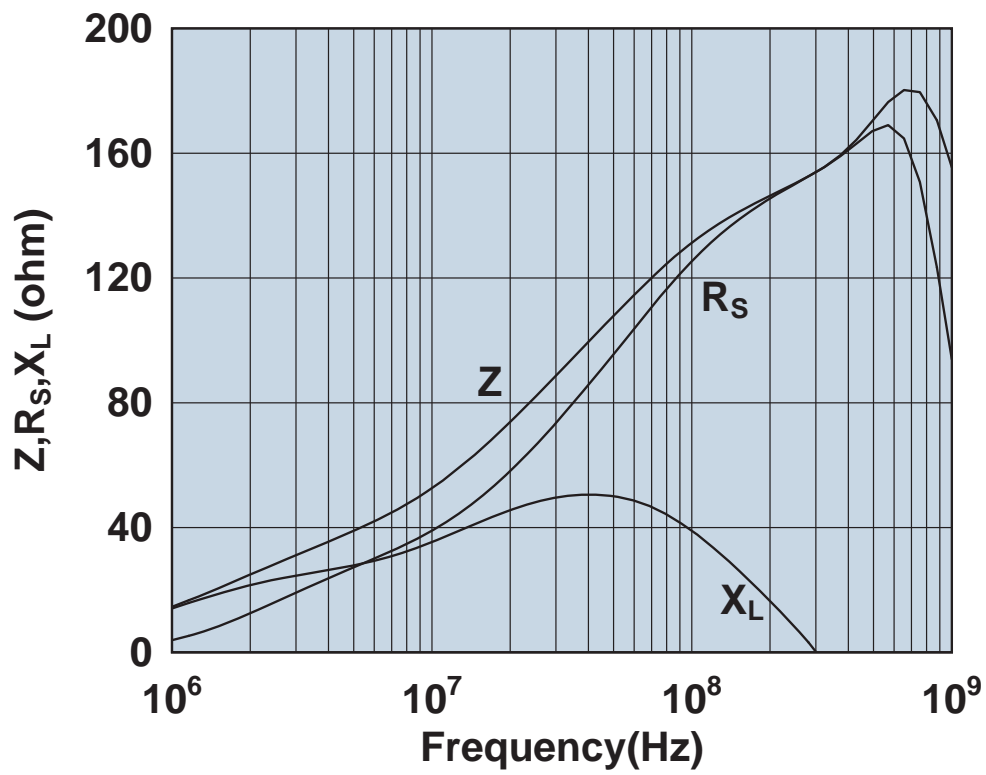

Impedance, reactance, and resistance vs. frequency.

2631625002

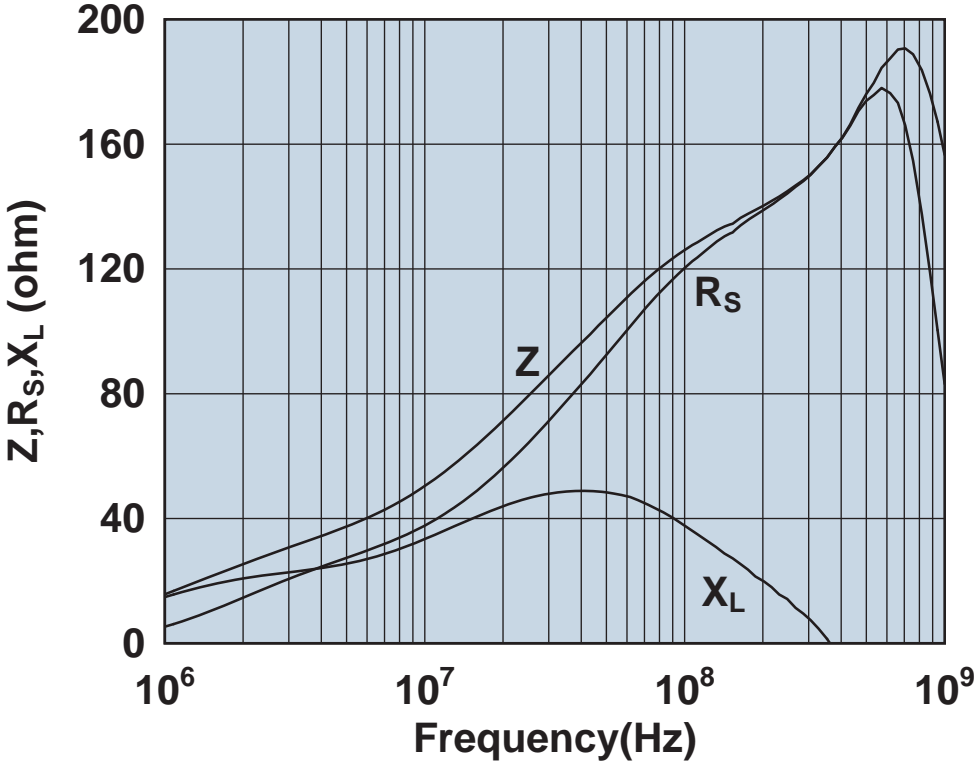

Impedance, reactance, and resistance vs. frequency.

2631625102

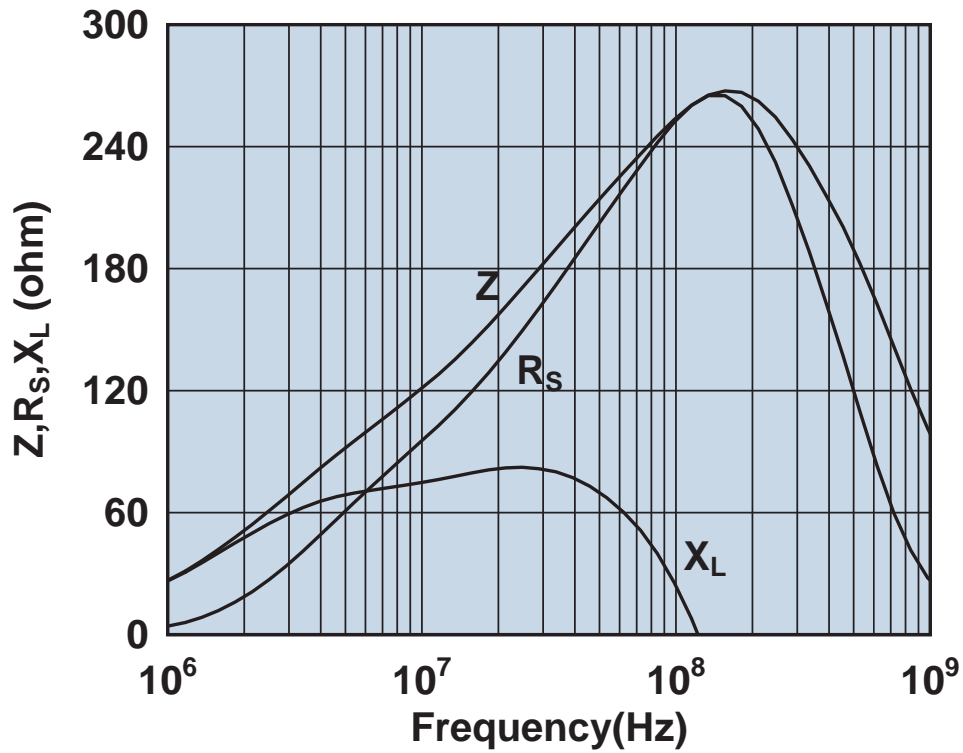

Impedance, reactance, and resistance vs. frequency.

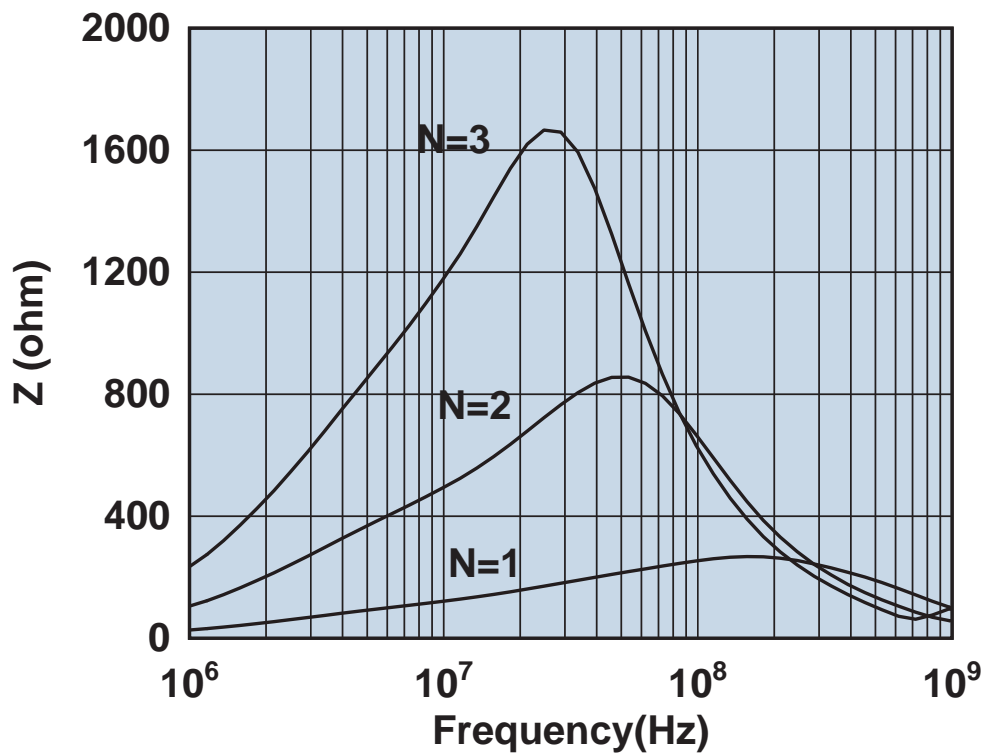

Impedance vs. frequency with one, two, and three turns.

2631626202

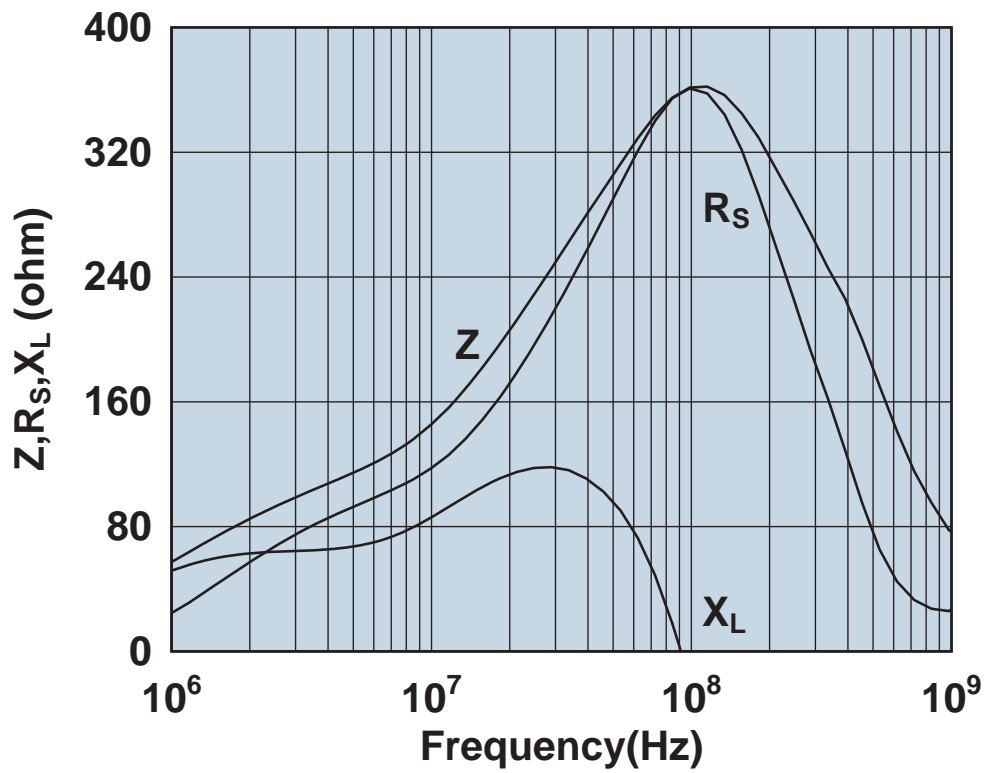

Impedance, reactance, and resistance vs. frequency.

2631626302

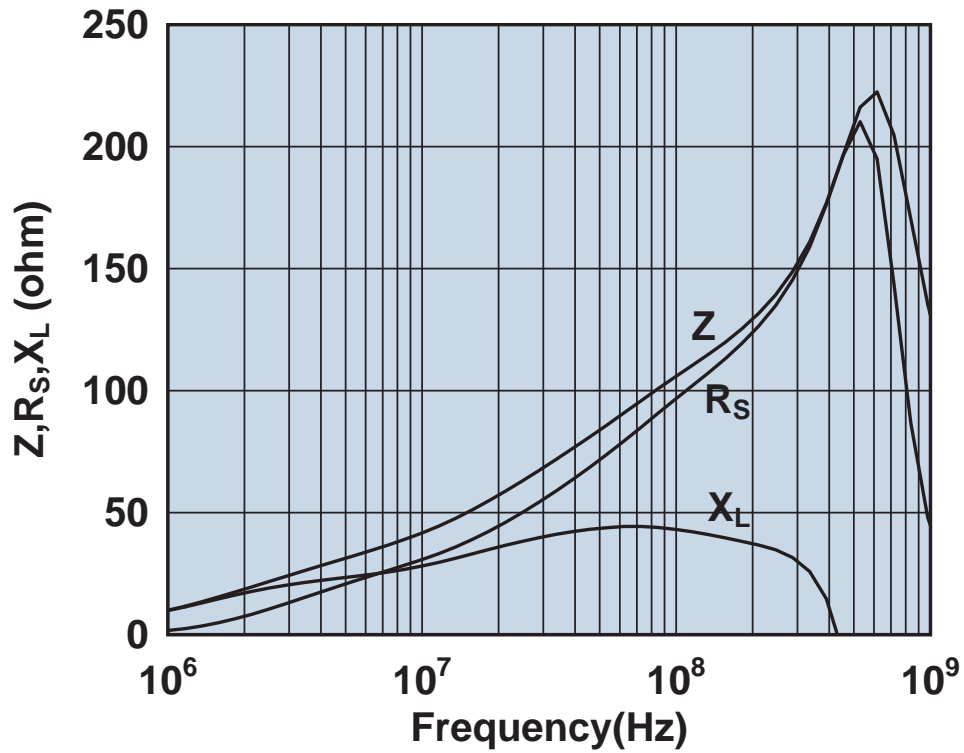

Impedance, reactance, and resistance vs. frequency.

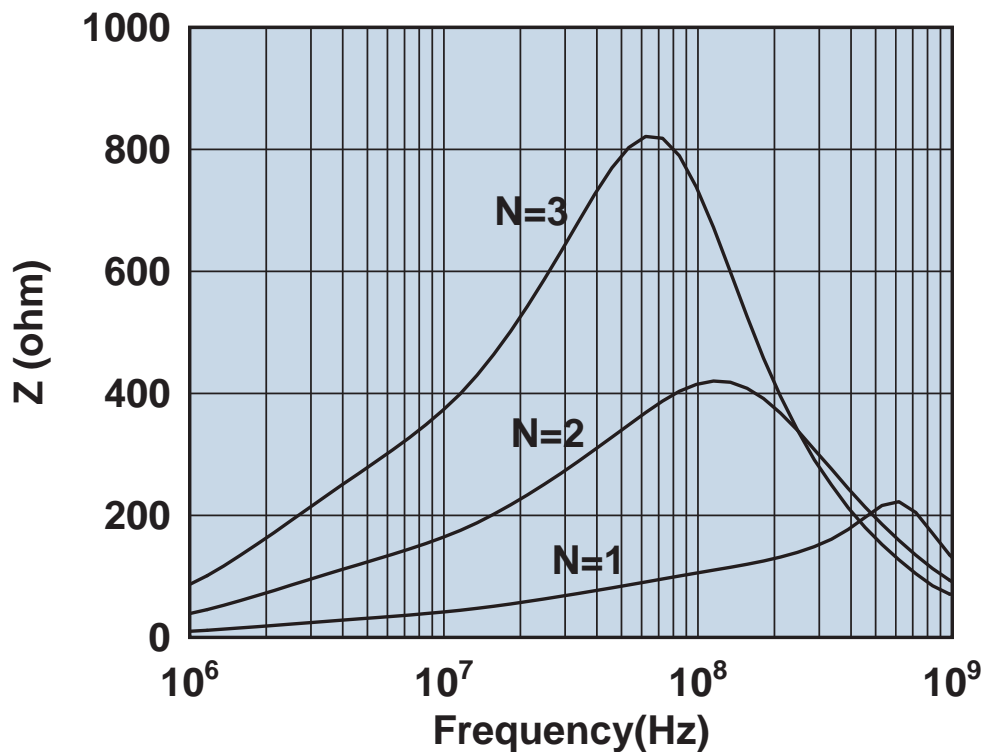

Impedance vs. frequency with one, two, and three turns.

2631626402

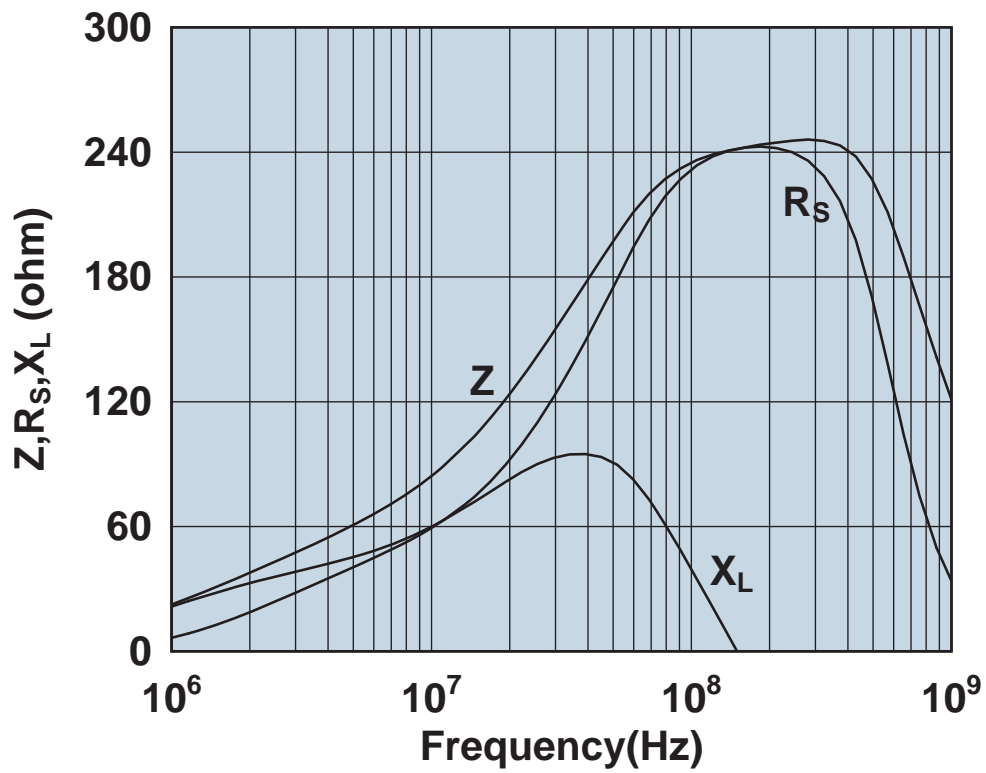

Impedance, reactance, and resistance vs. frequency.

2631665702

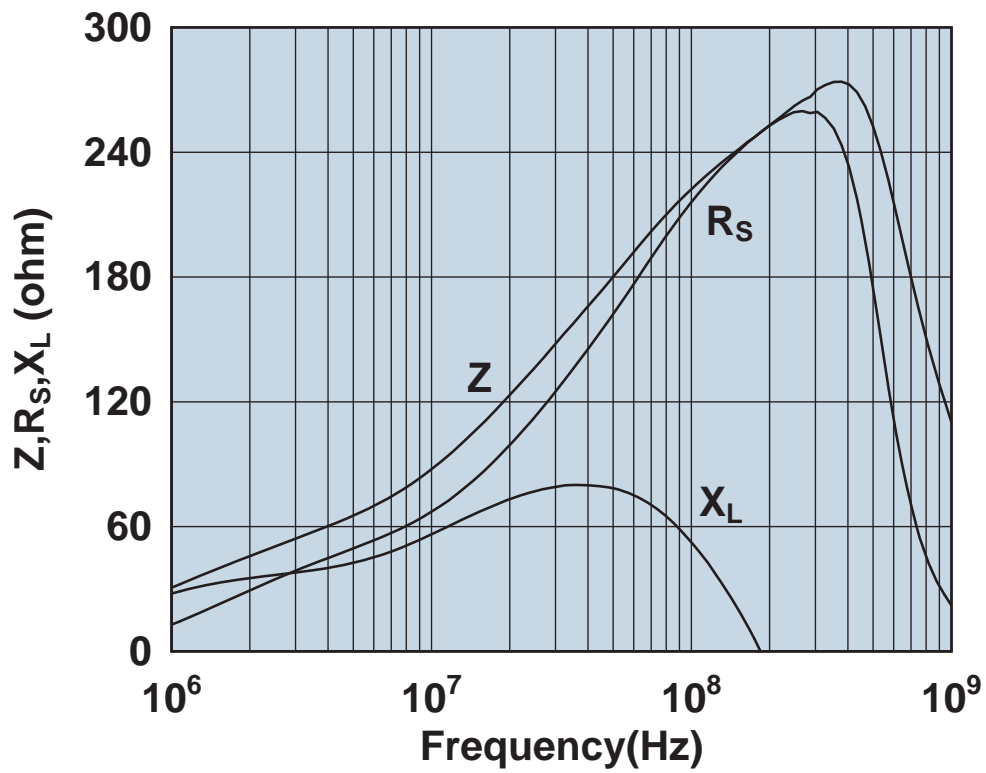

Impedance, reactance, and resistance vs. frequency.

2631665802

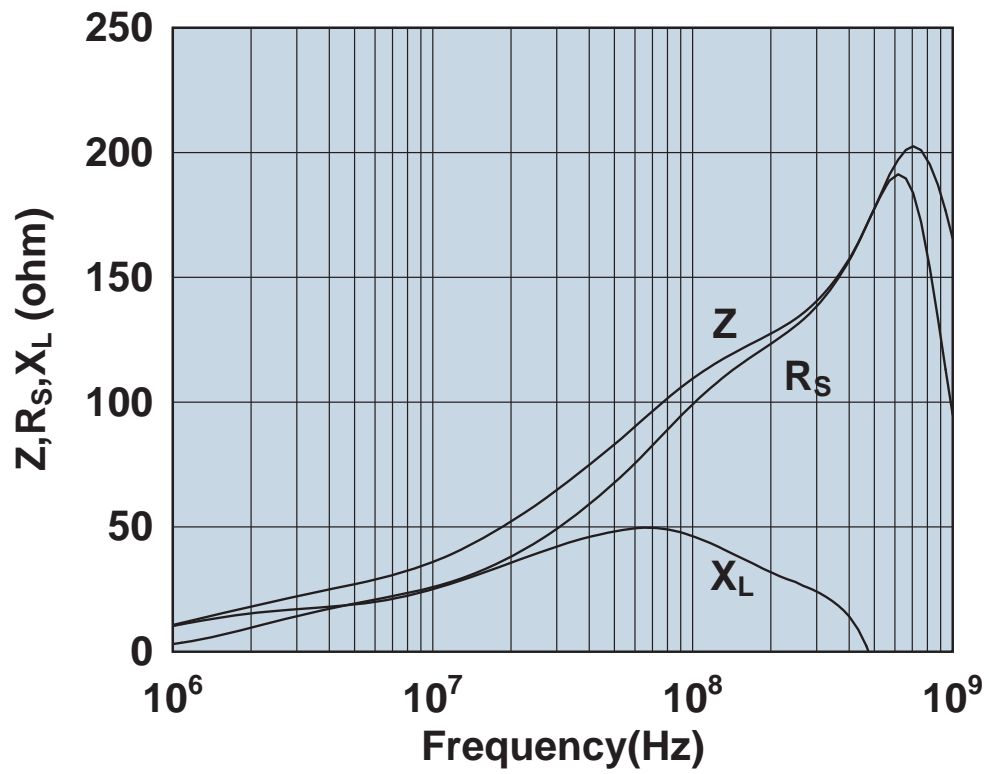

Impedance, reactance, and resistance vs. frequency.

2631801202

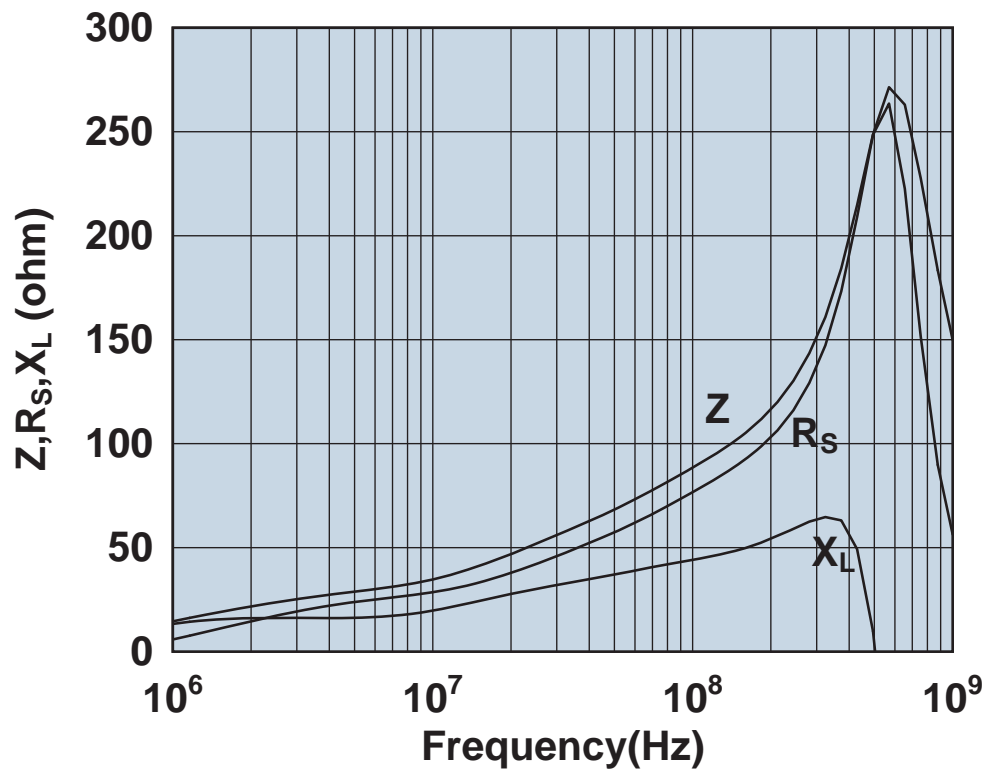

Impedance, reactance, and resistance vs. frequency.

2631803802

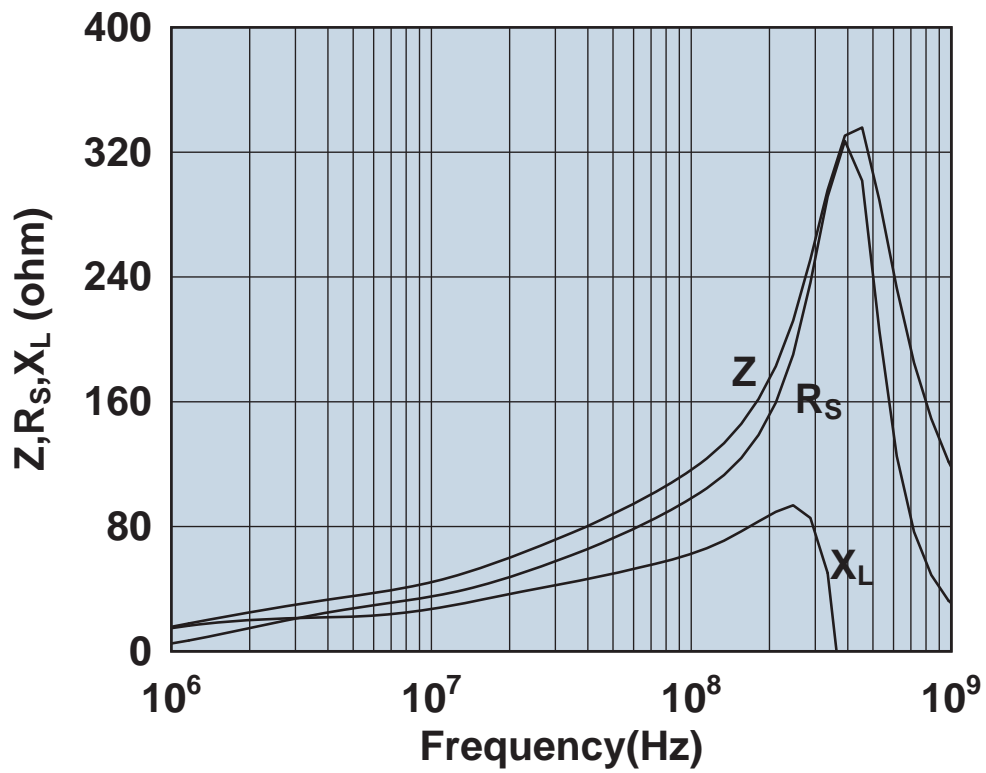

Impedance, reactance, and resistance vs. frequency.

2643000101

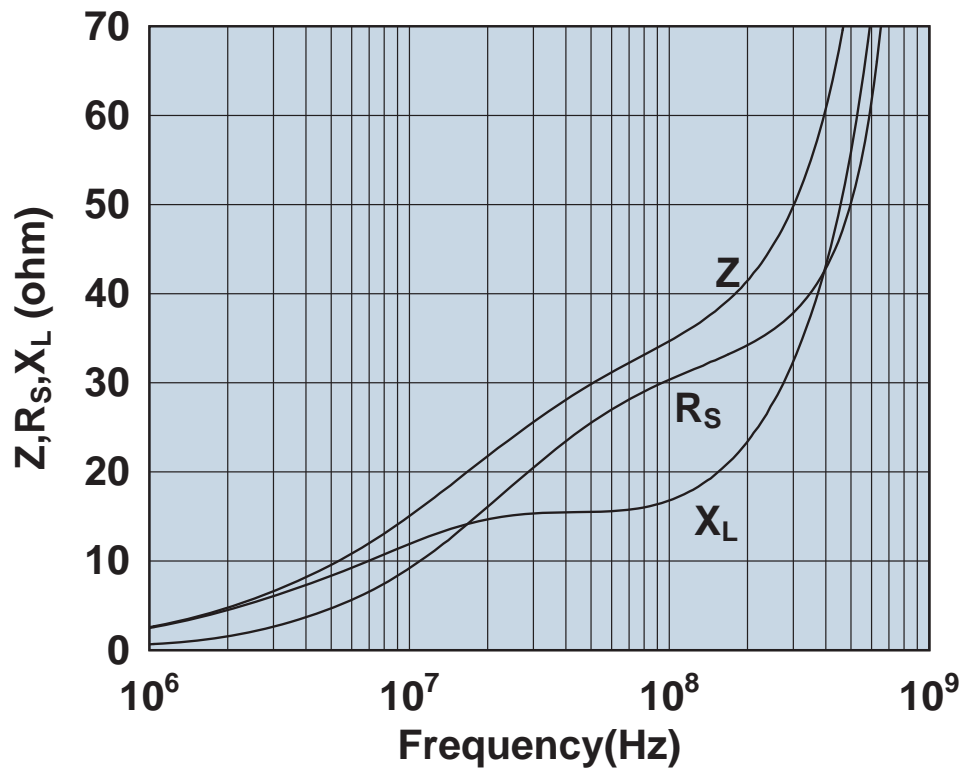

Impedance, reactance, and resistance vs. frequency.

2643000201

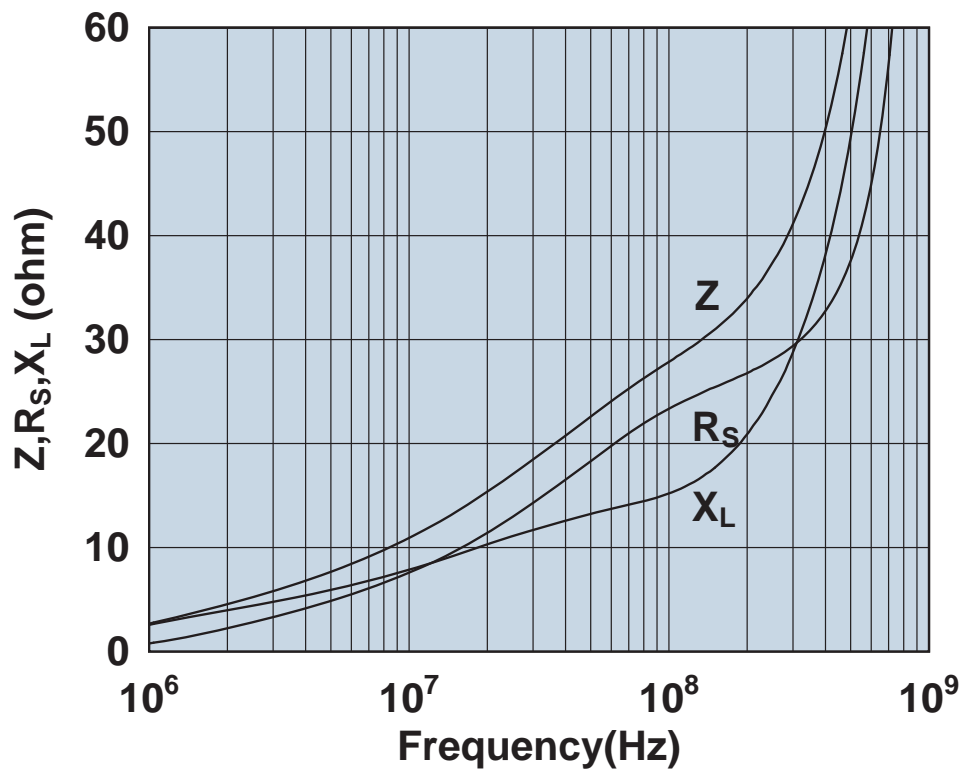

Impedance, reactance, and resistance vs. frequency.

2643000301

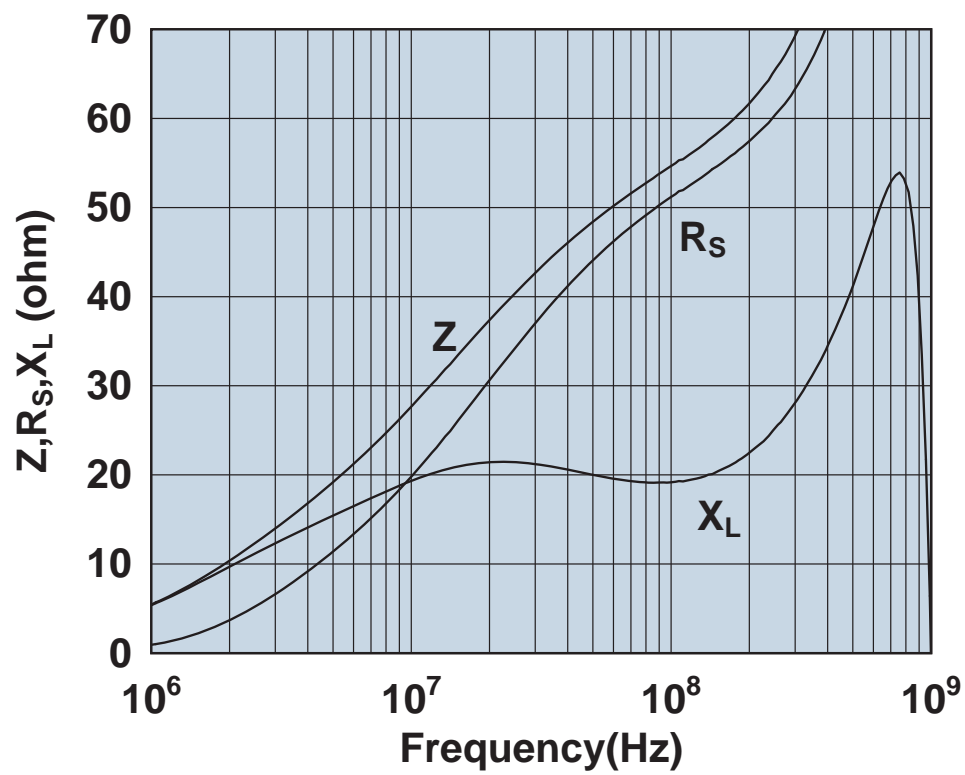

Impedance, reactance, and resistance vs. frequency.

2643000501

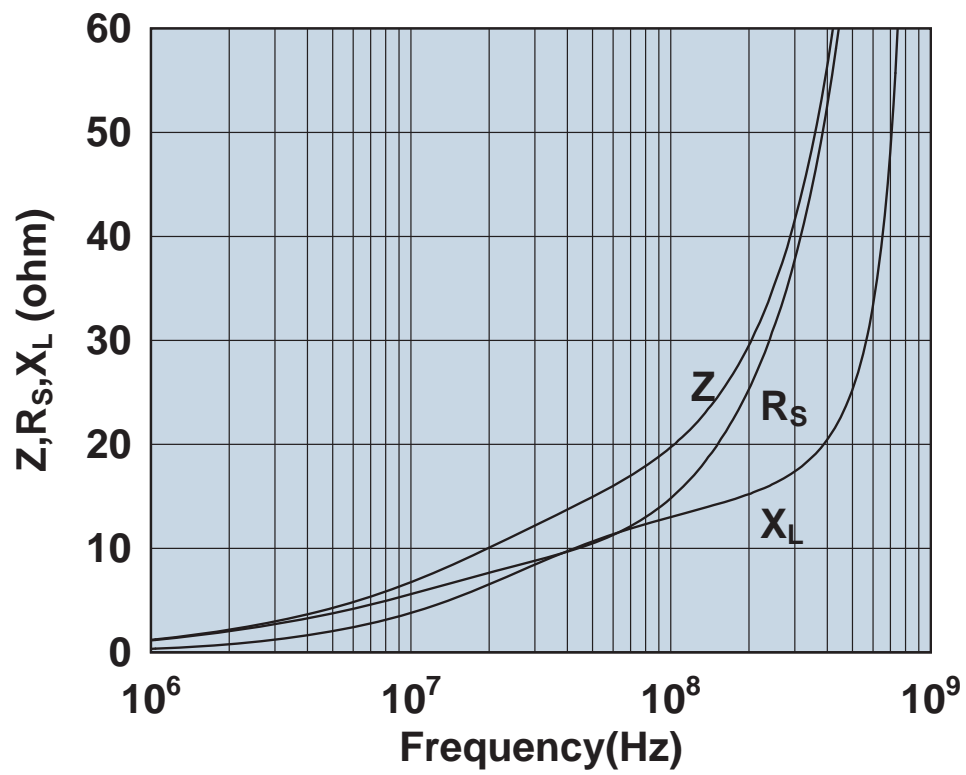

Impedance, reactance, and resistance vs. frequency.

2643000701

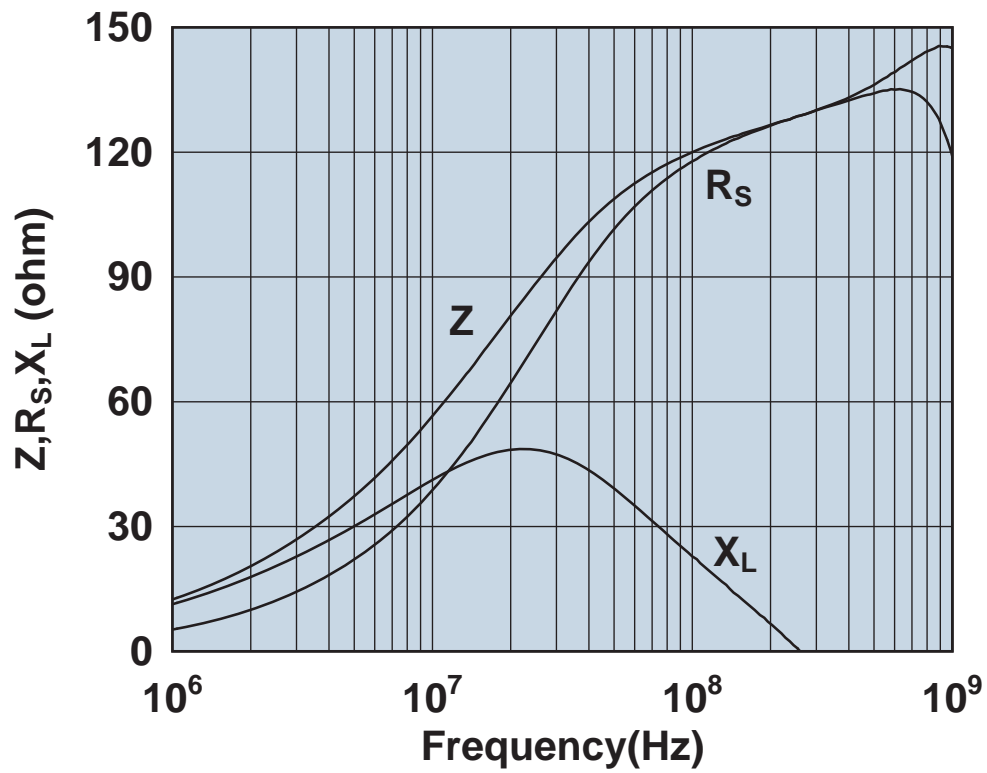

Impedance, reactance, and resistance vs. frequency.

2643000801

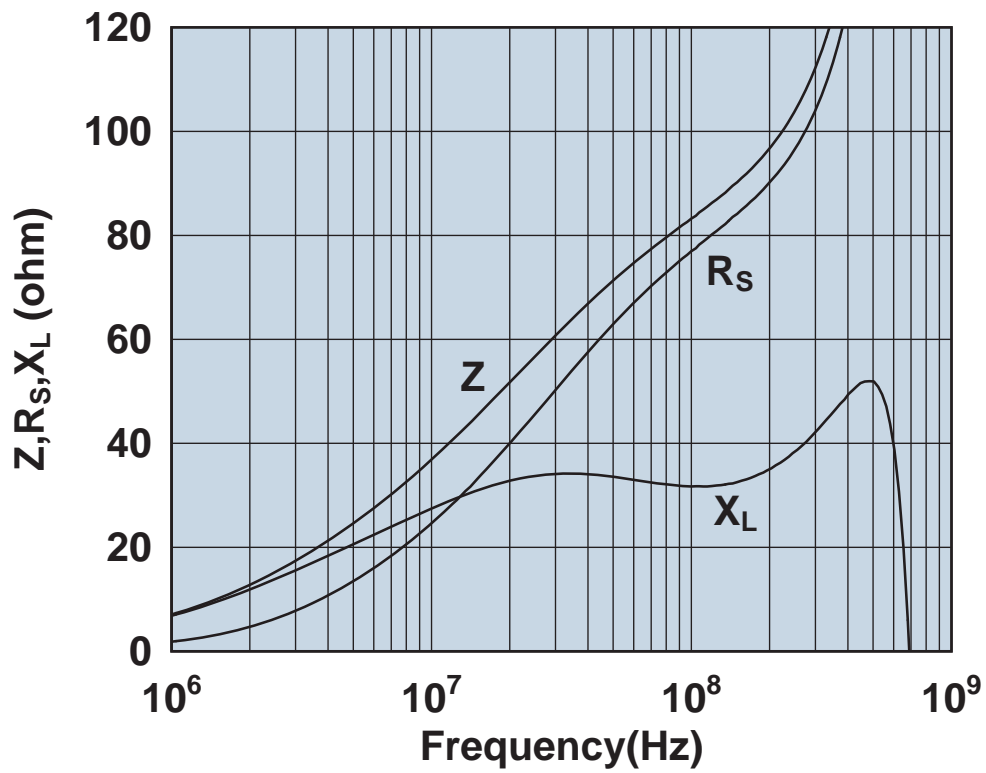

Impedance, reactance, and resistance vs. frequency.

2643001301

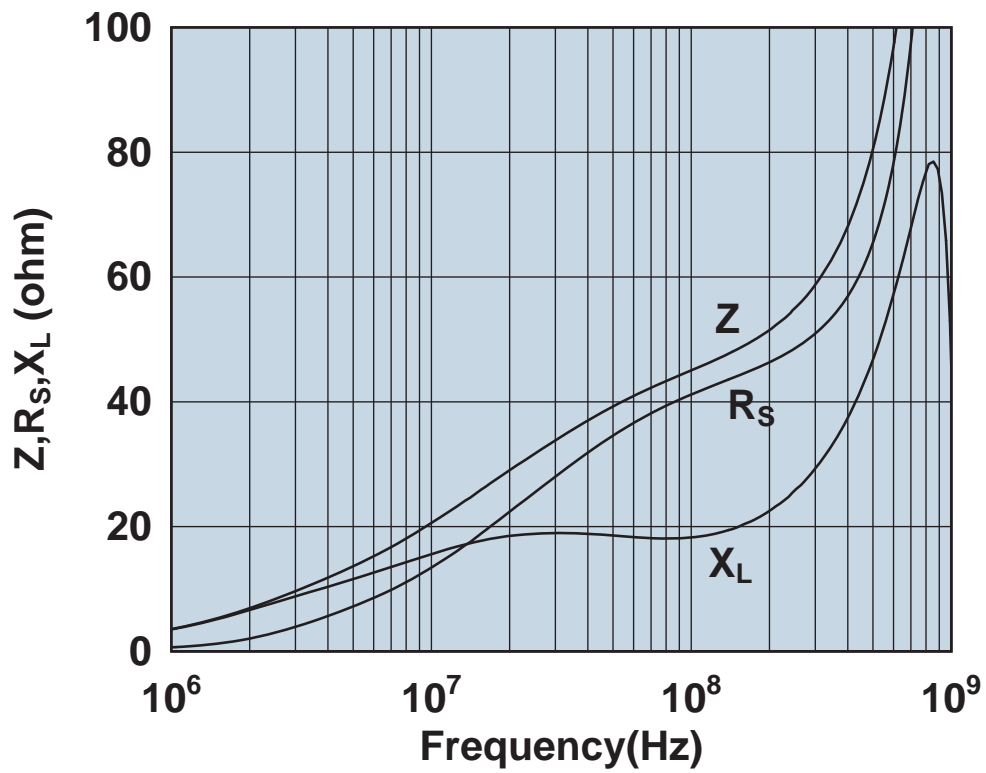

Impedance, reactance, and resistance vs. frequency.

2643001501

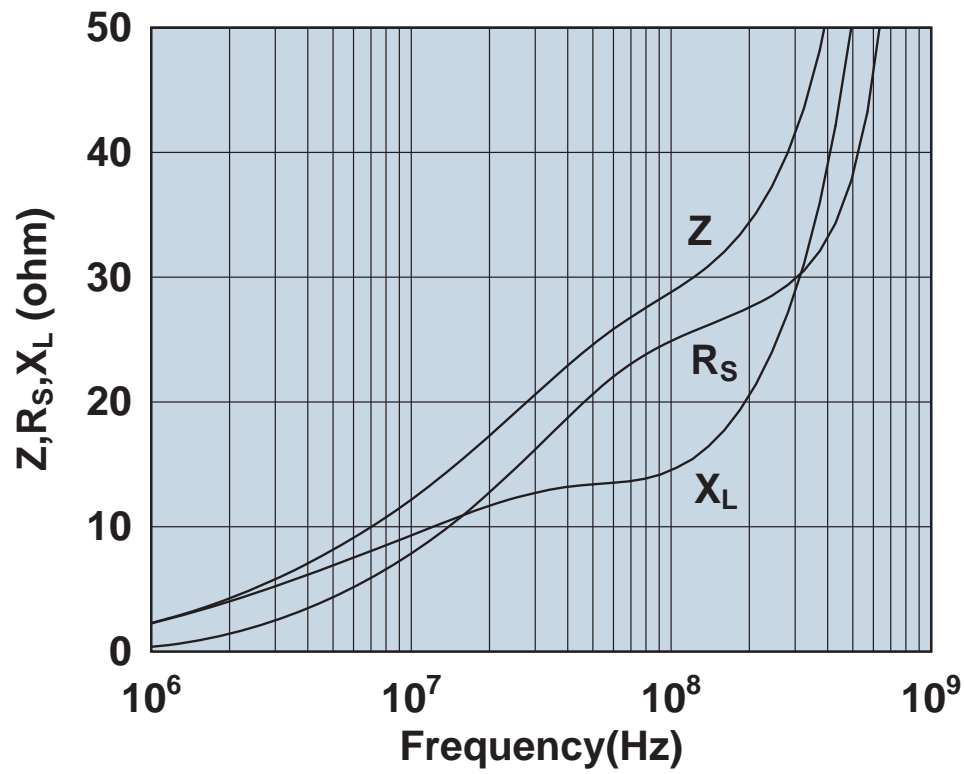

Impedance, reactance, and resistance vs. frequency.

2643001601

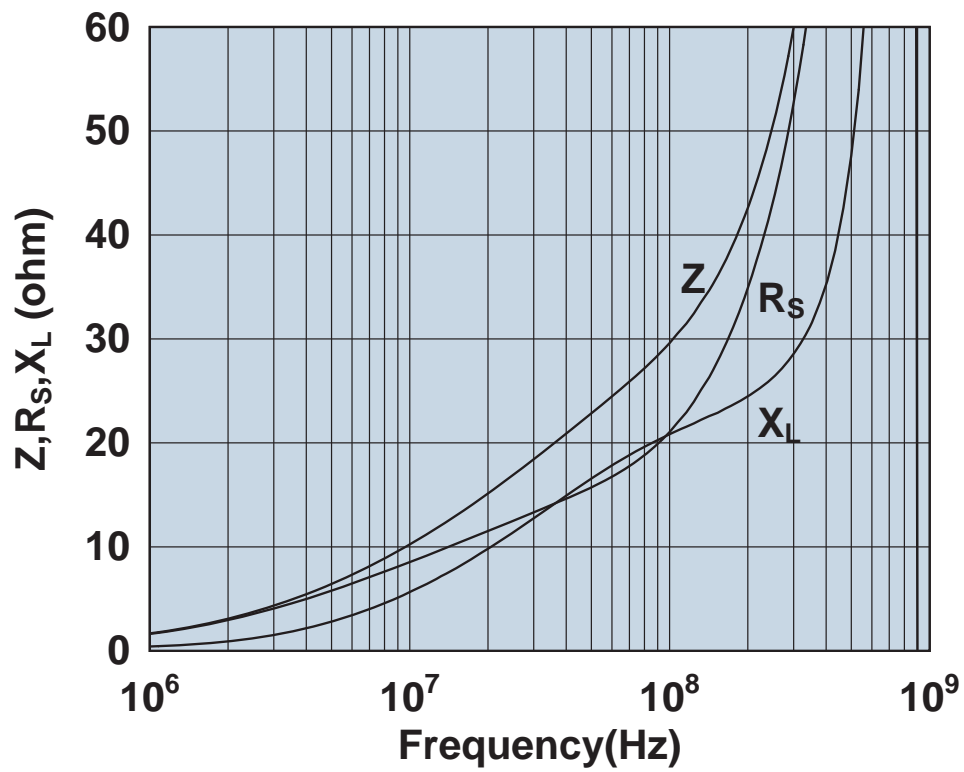

Impedance, reactance, and resistance vs. frequency.

2643002201

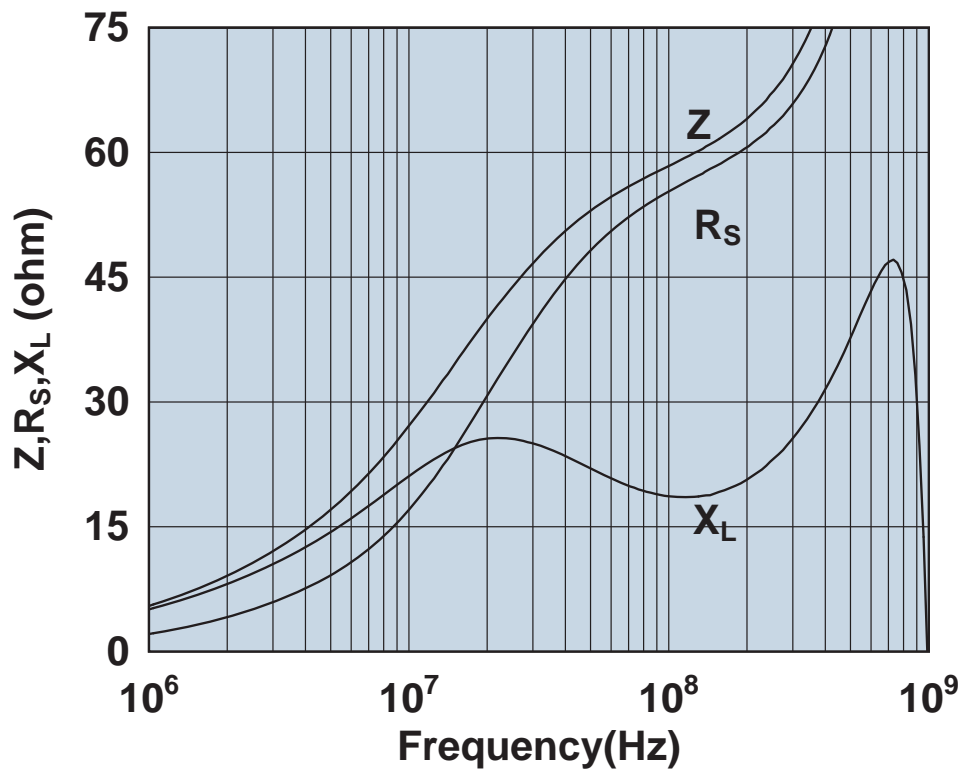

Impedance, reactance, and resistance vs. frequency.

2643002402

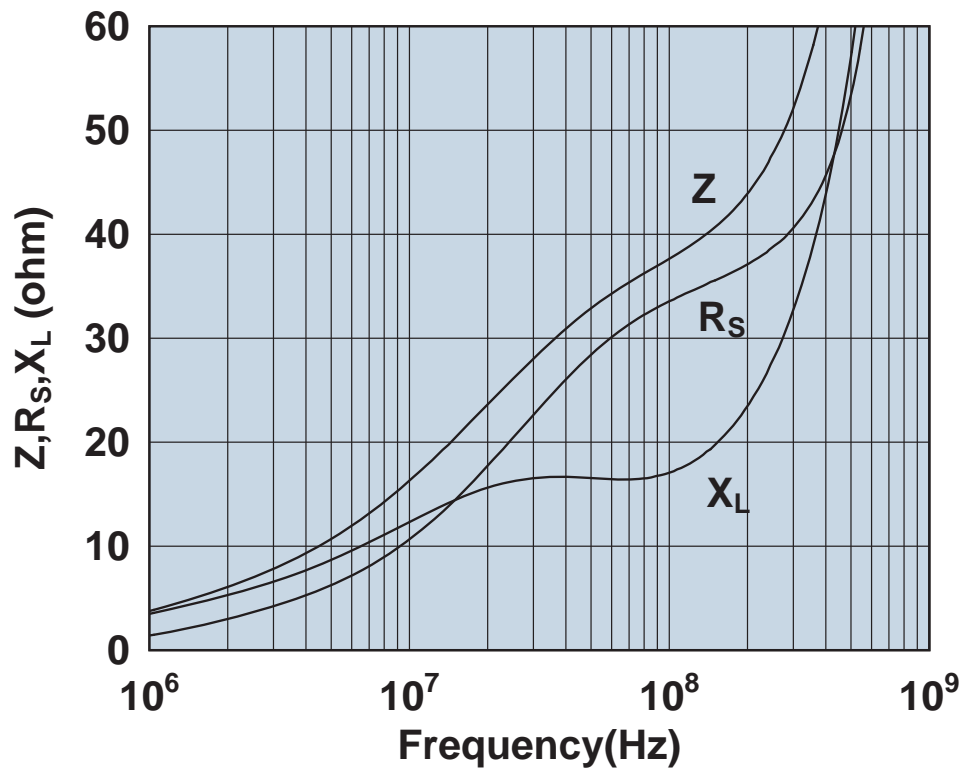

Impedance, reactance, and resistance vs. frequency.

2643003201

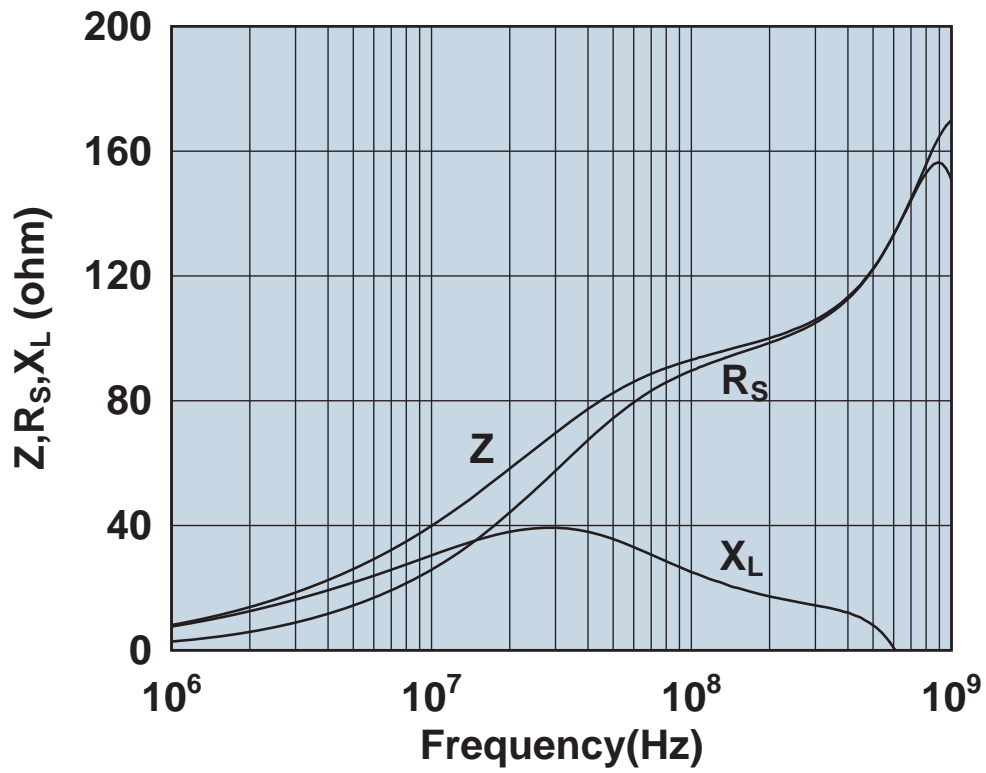

Impedance, reactance, and resistance vs. frequency.

2643004101

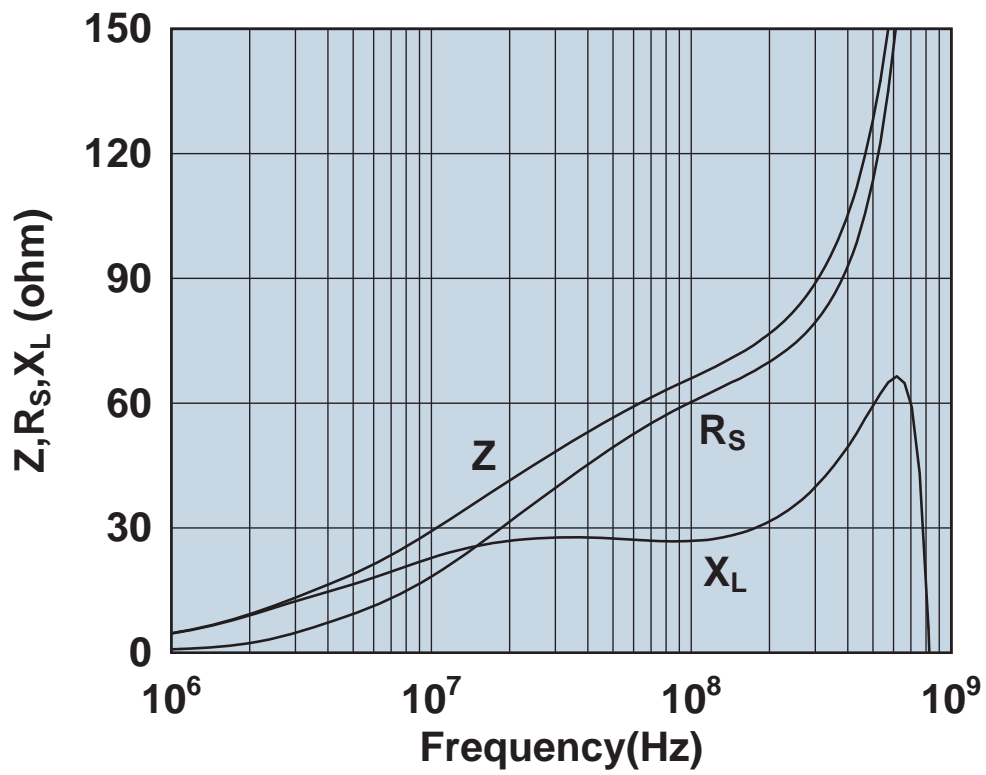

Impedance, reactance, and resistance vs. frequency.

2643004601

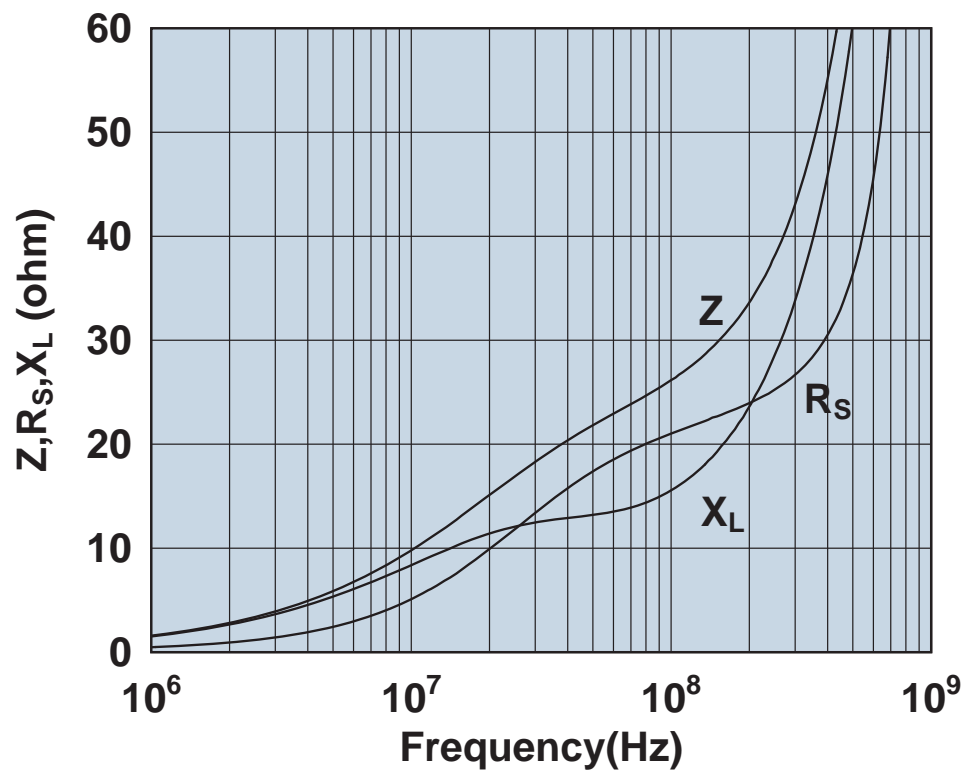

Impedance, reactance, and resistance vs. frequency.

2643004701

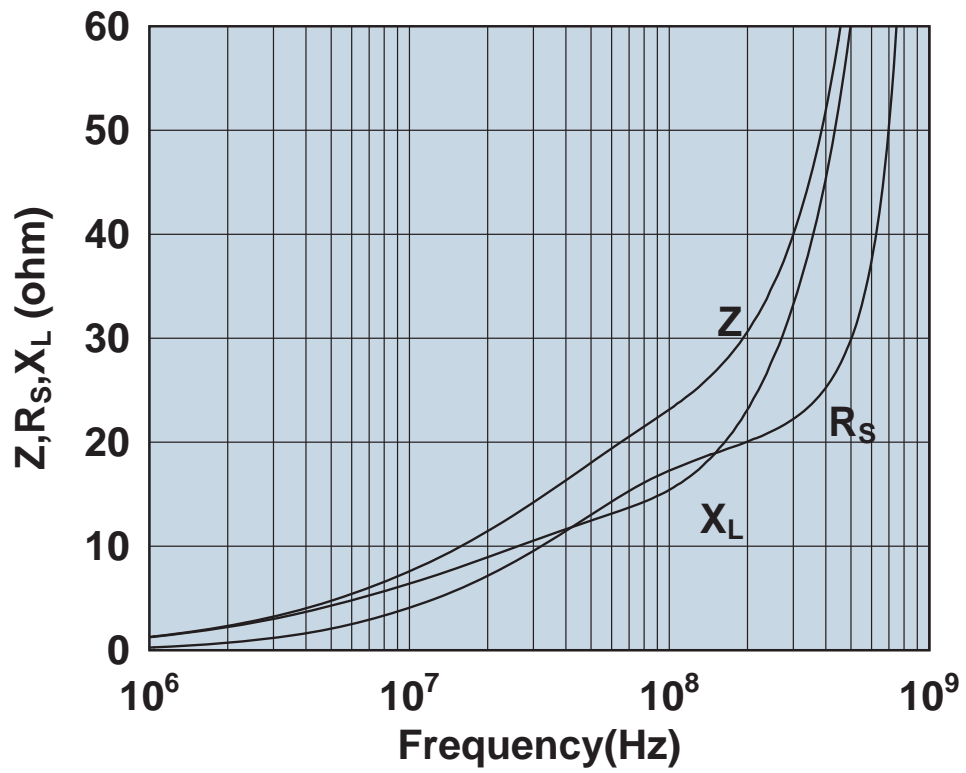

Impedance, reactance, and resistance vs. frequency.

2643004801

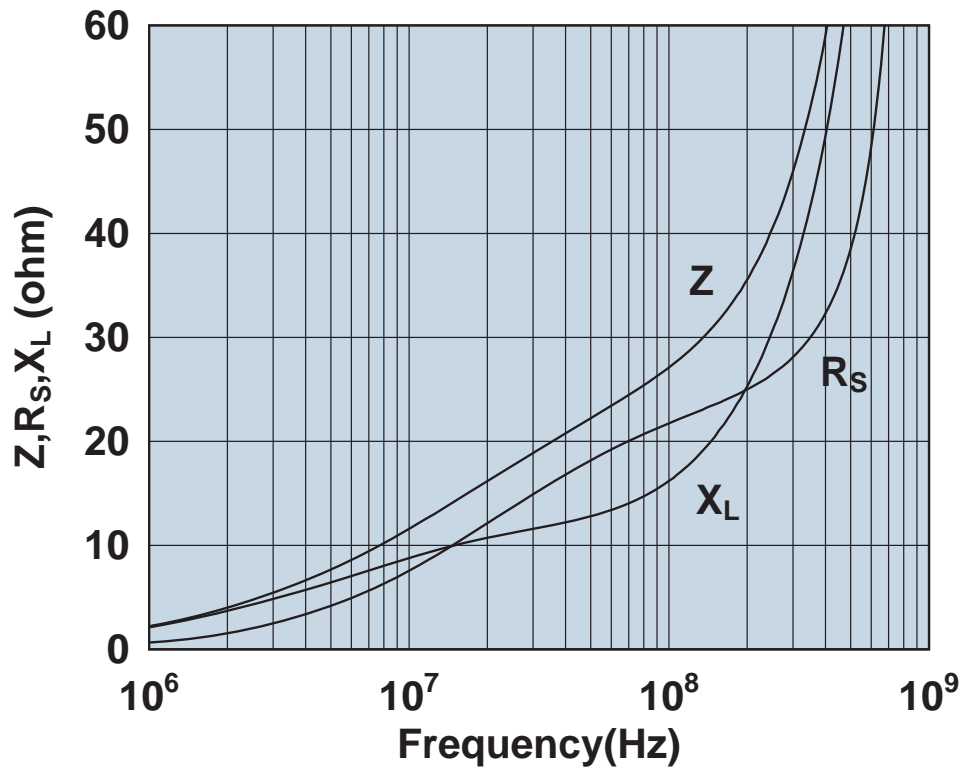

Impedance, reactance, and resistance vs. frequency.

2643005701

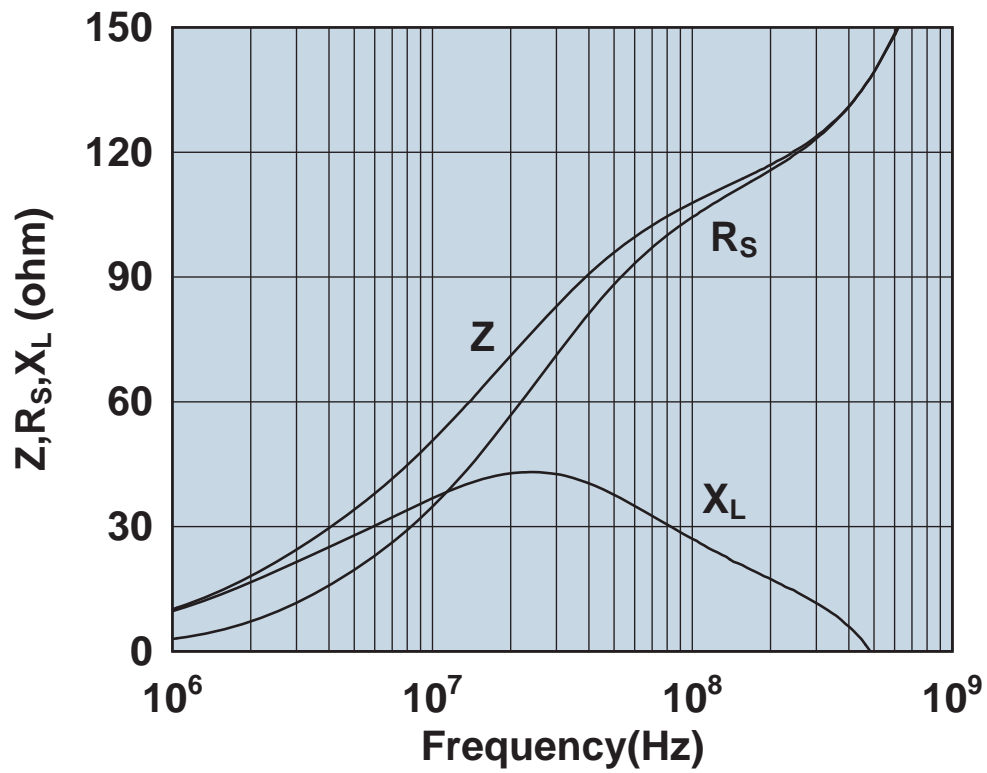

Impedance, reactance, and resistance vs. frequency.

2643006302

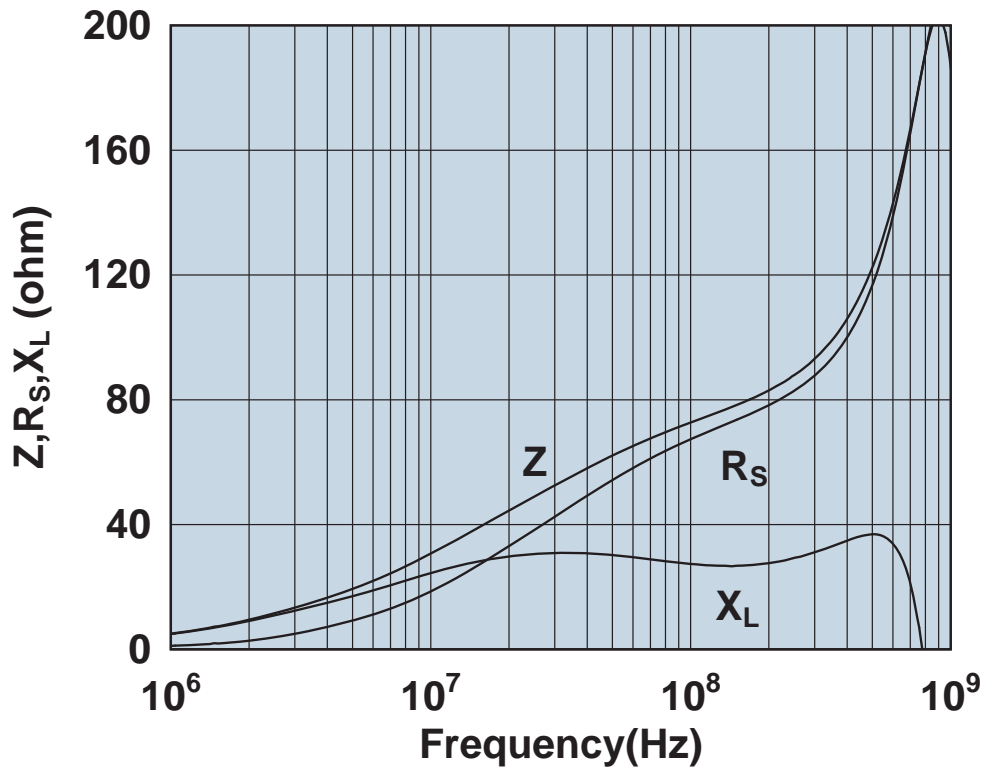

Impedance, reactance, and resistance vs. frequency.

2643012702

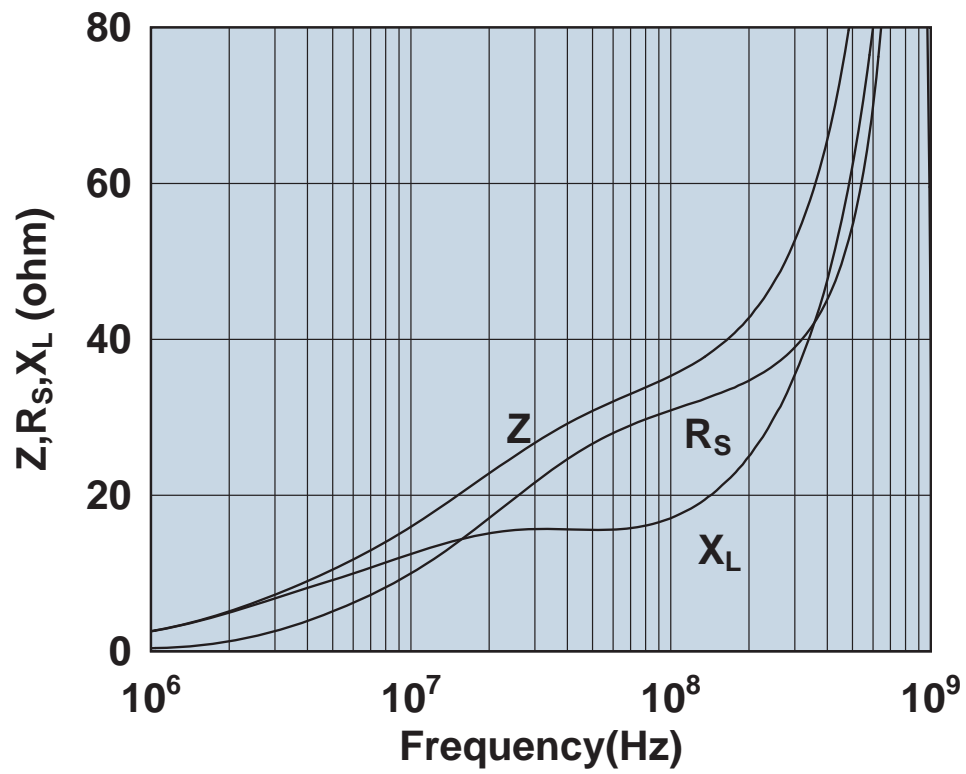

Impedance, reactance, and resistance vs. frequency.

2643013801

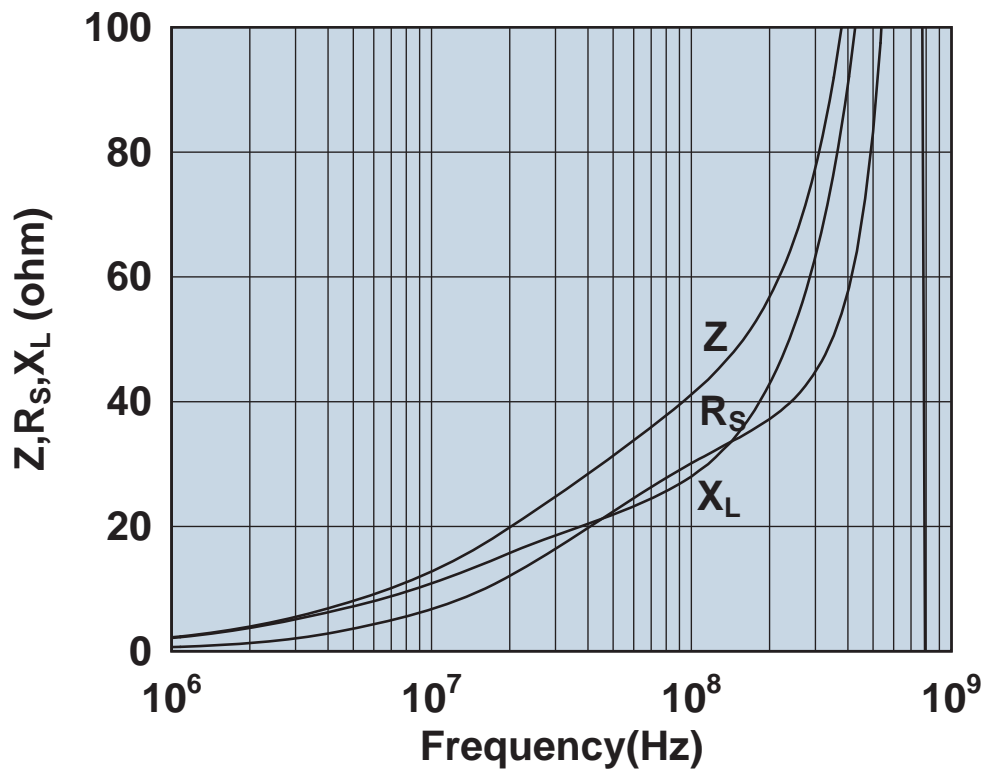

Impedance, reactance, and resistance vs. frequency.

2643020501

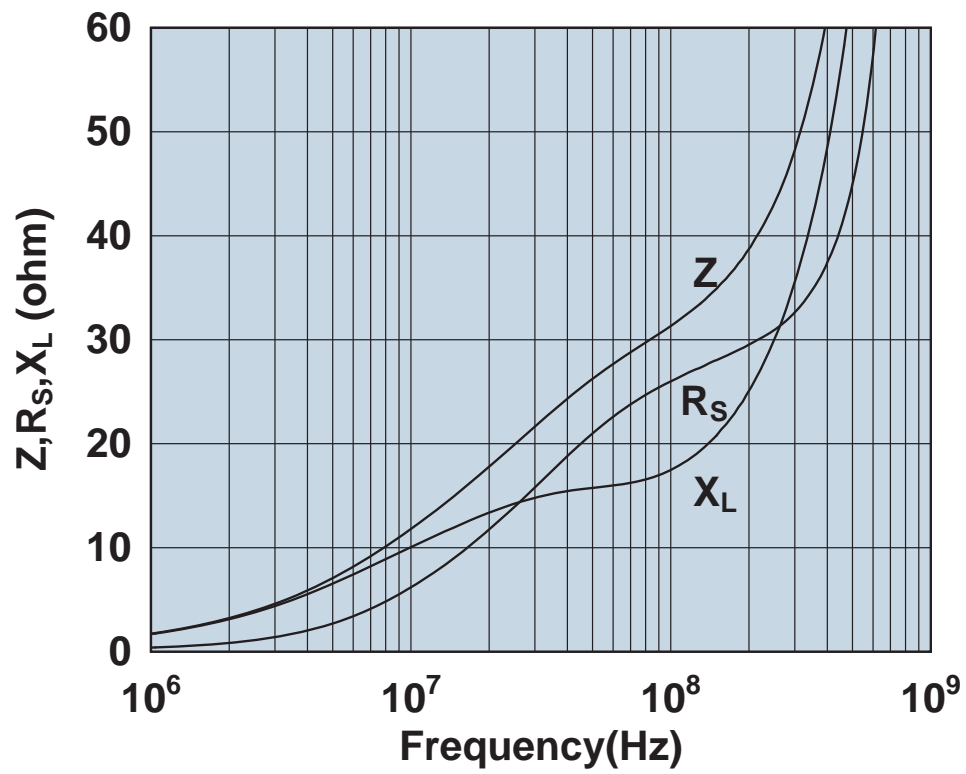

Impedance, reactance, and resistance vs. frequency.

2643021801

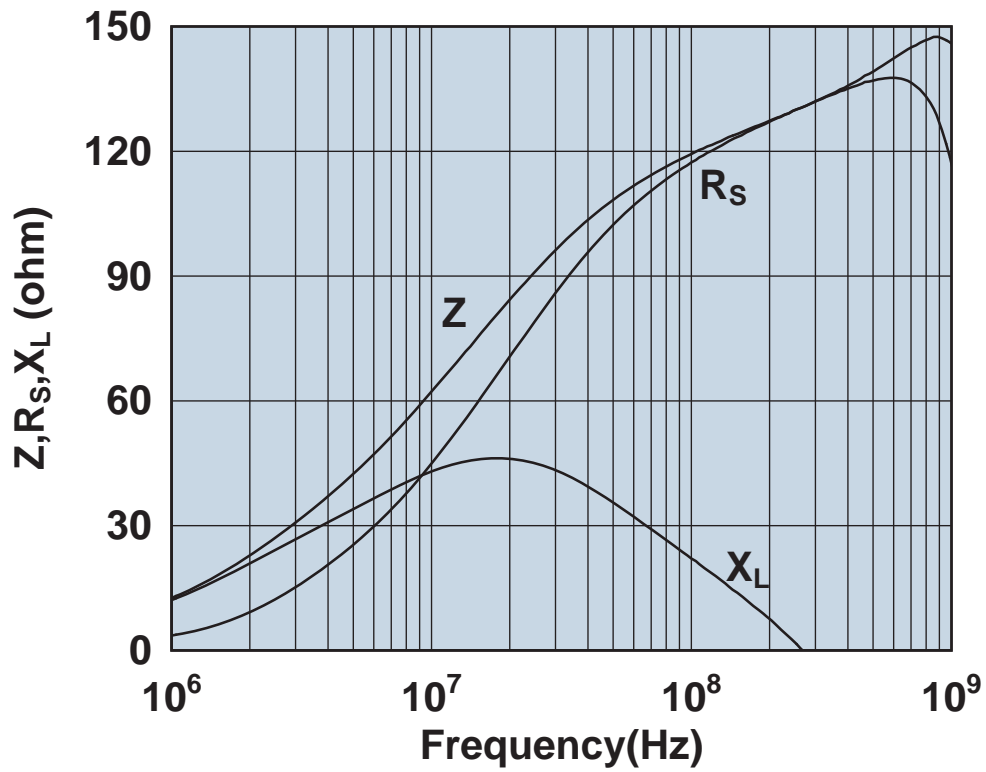

Impedance, reactance, and resistance vs. frequency.

2643022401

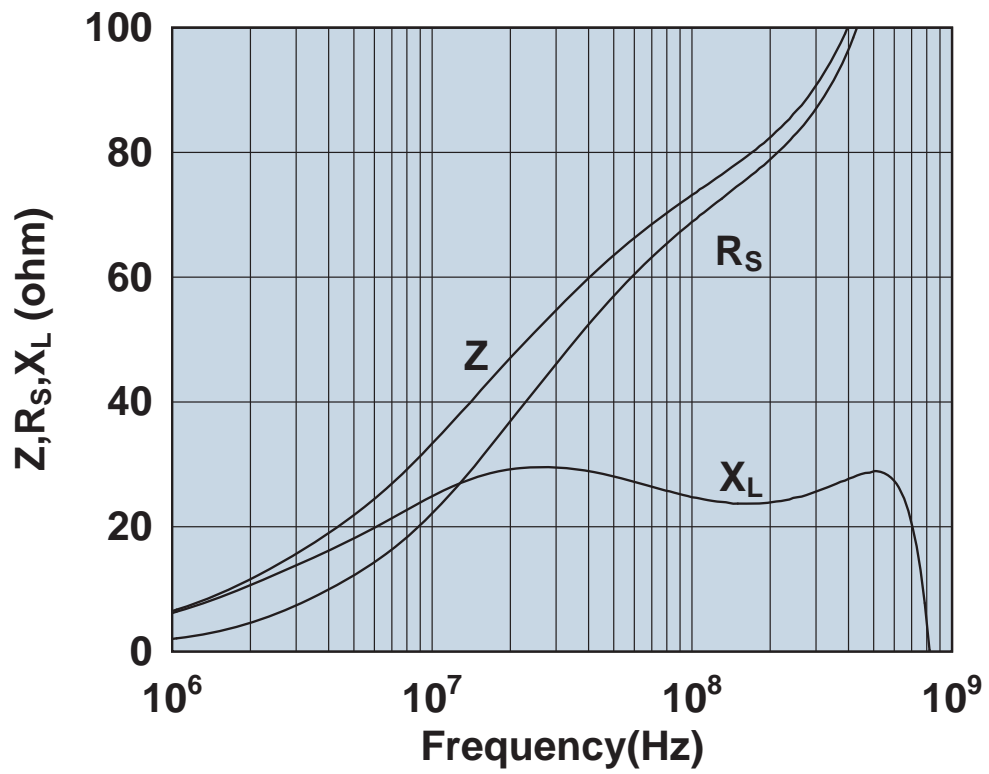

Impedance, reactance, and resistance vs. frequency.

2643022401

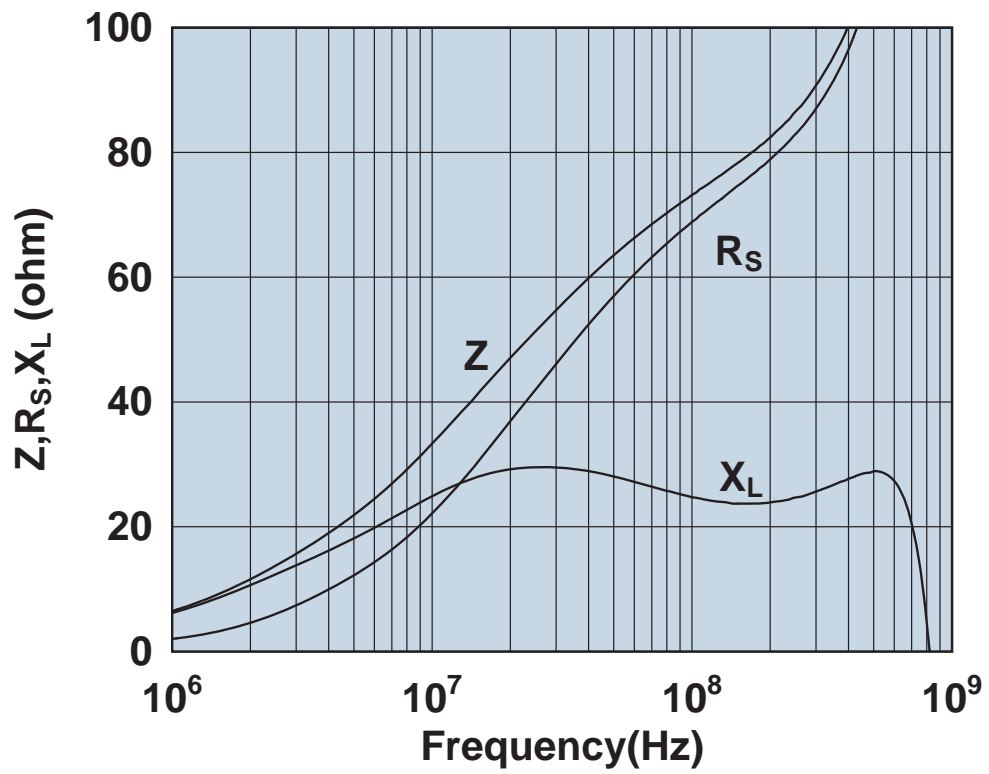

Impedance, reactance, and resistance vs. frequency.

2643023002

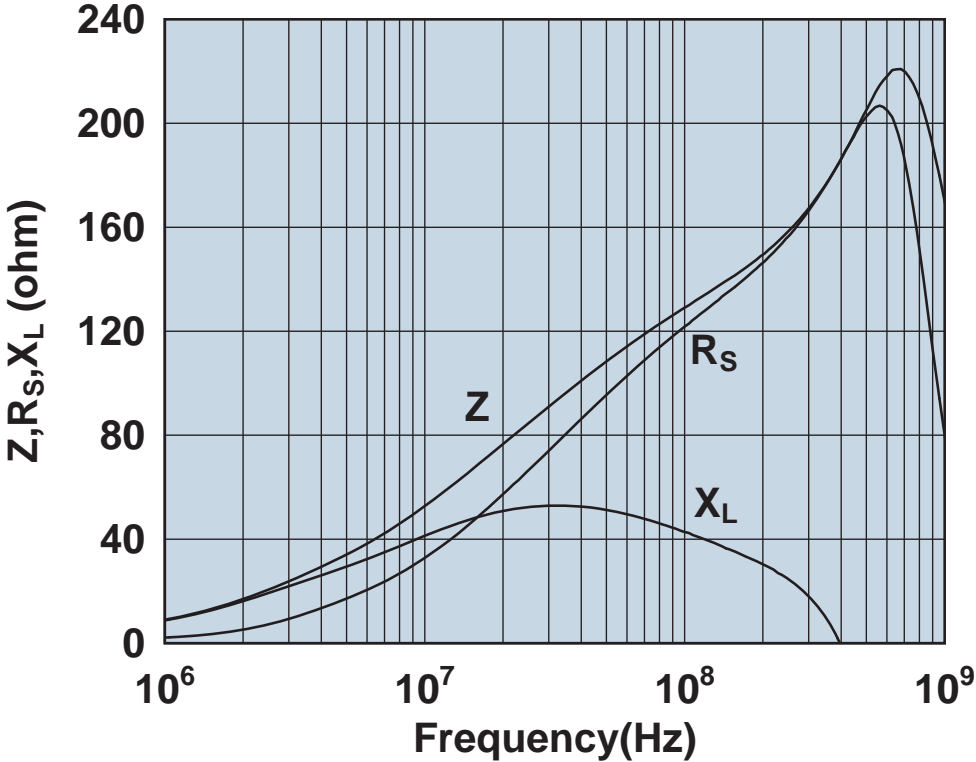

Impedance, reactance, and resistance vs. frequency.

2643023201

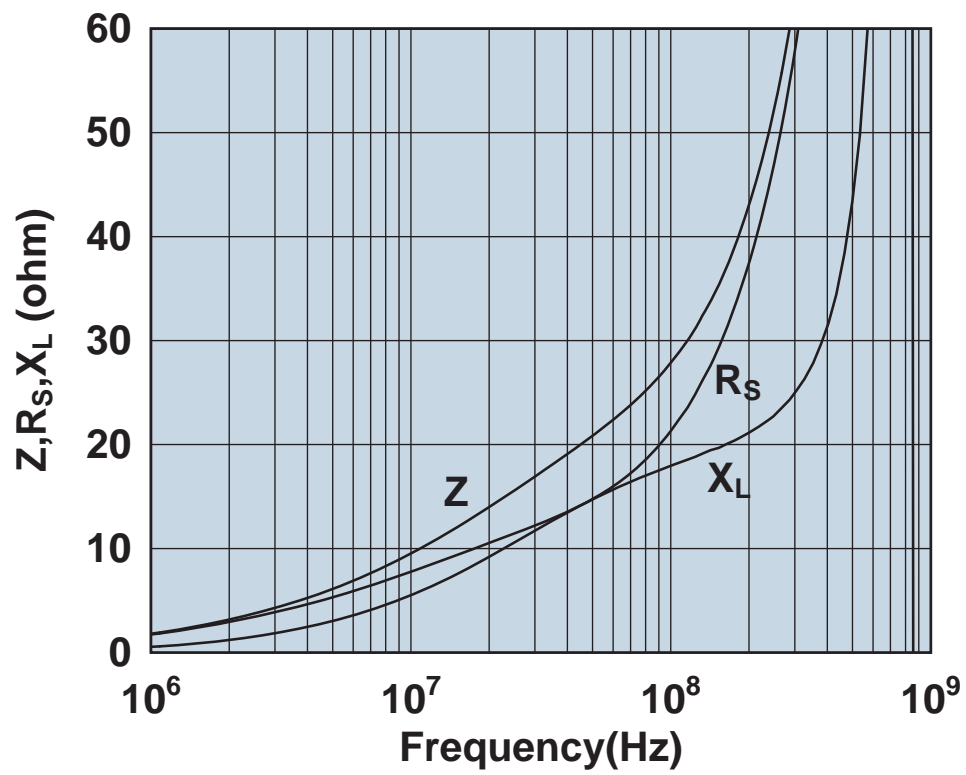

Impedance, reactance, and resistance vs. frequency.

2643023402

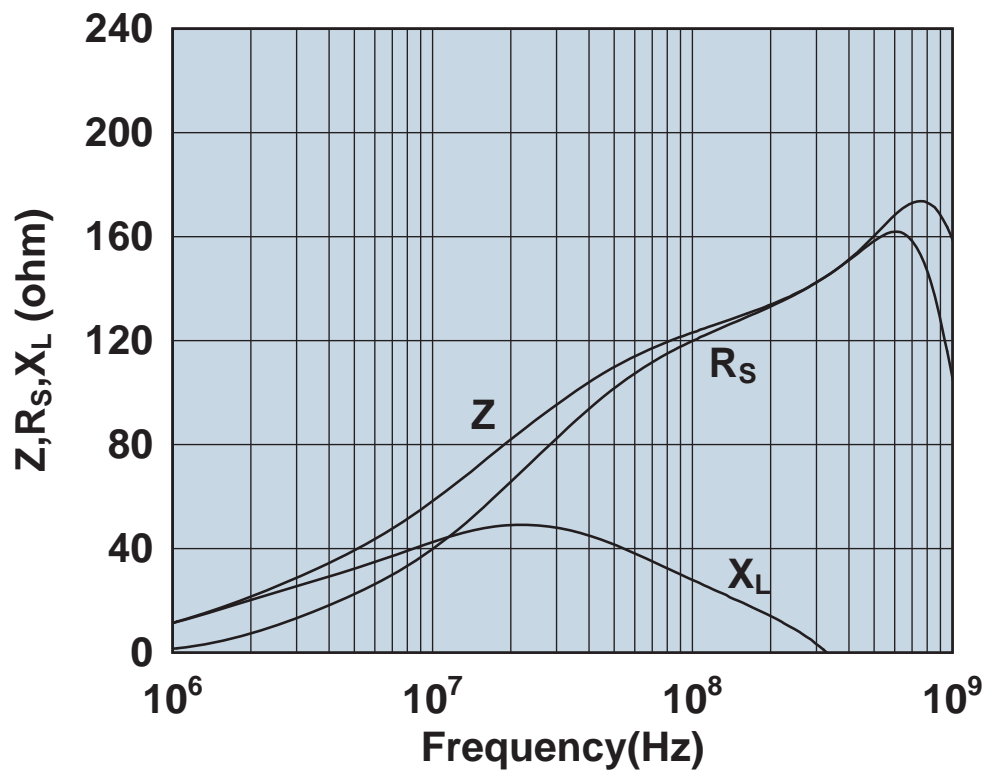

Impedance, reactance, and resistance vs. frequency.

2643023801

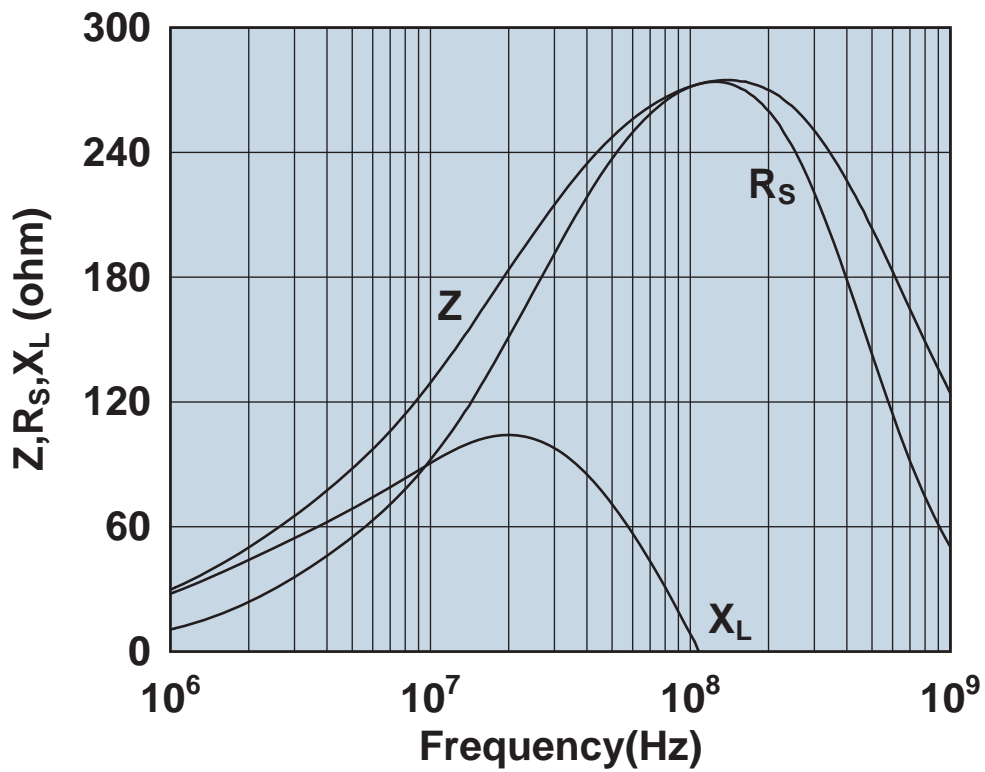

Impedance, reactance, and resistance vs. frequency.

2643025601

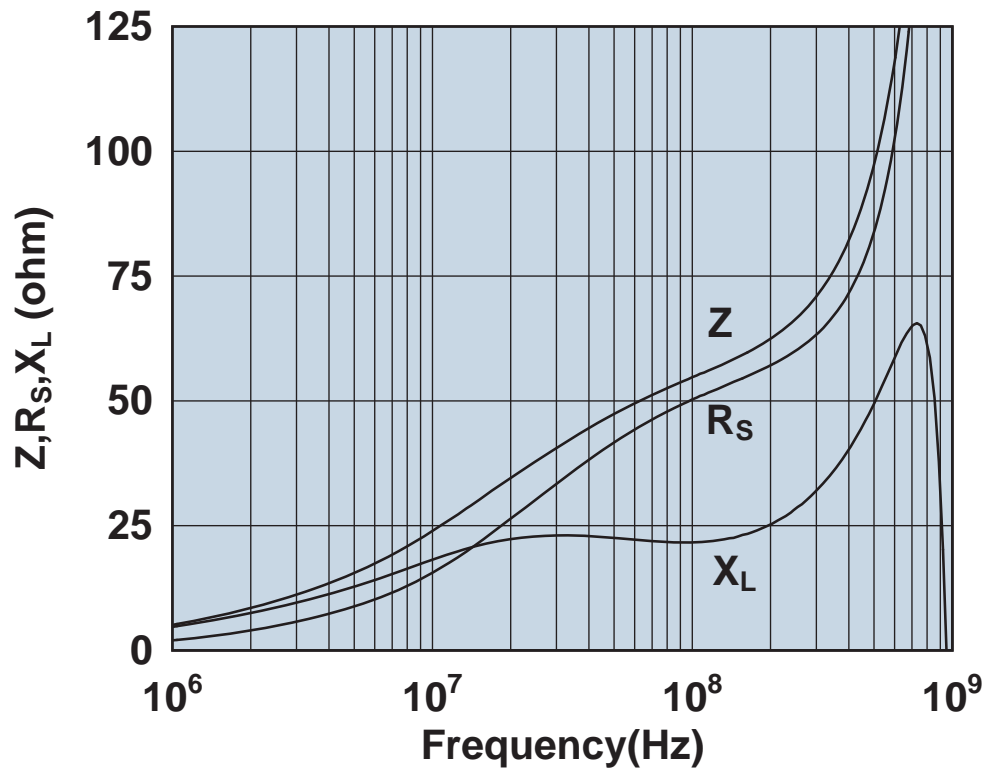

Impedance, reactance, and resistance vs. frequency.

2643101902

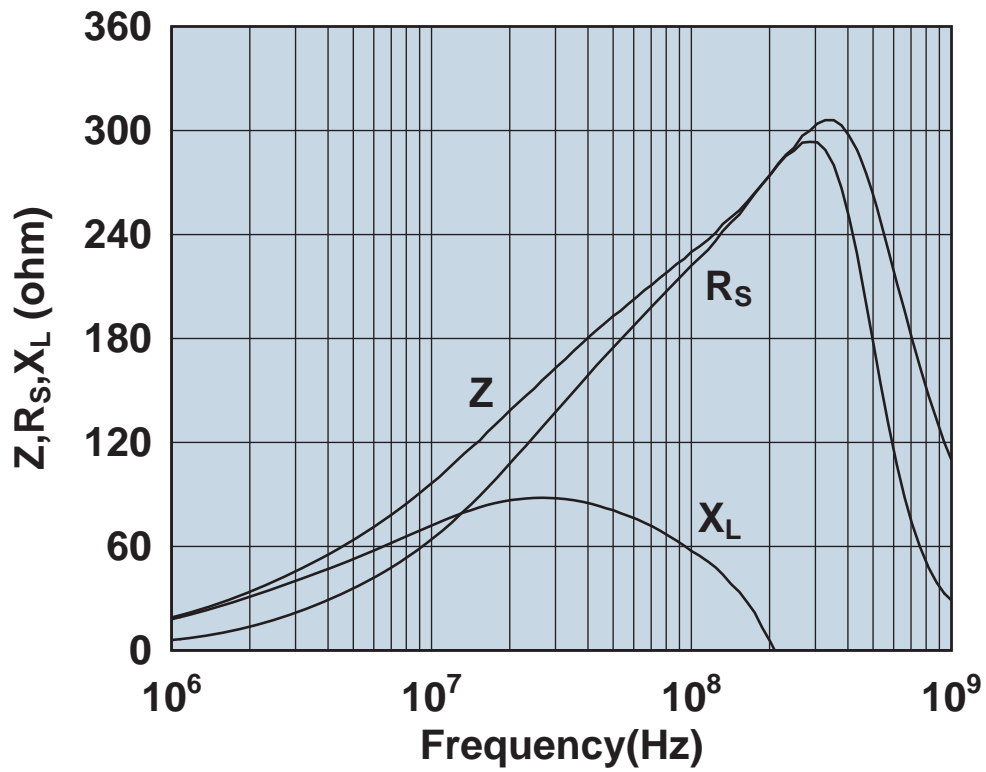

Impedance, reactance, and resistance vs. frequency.

2643102002

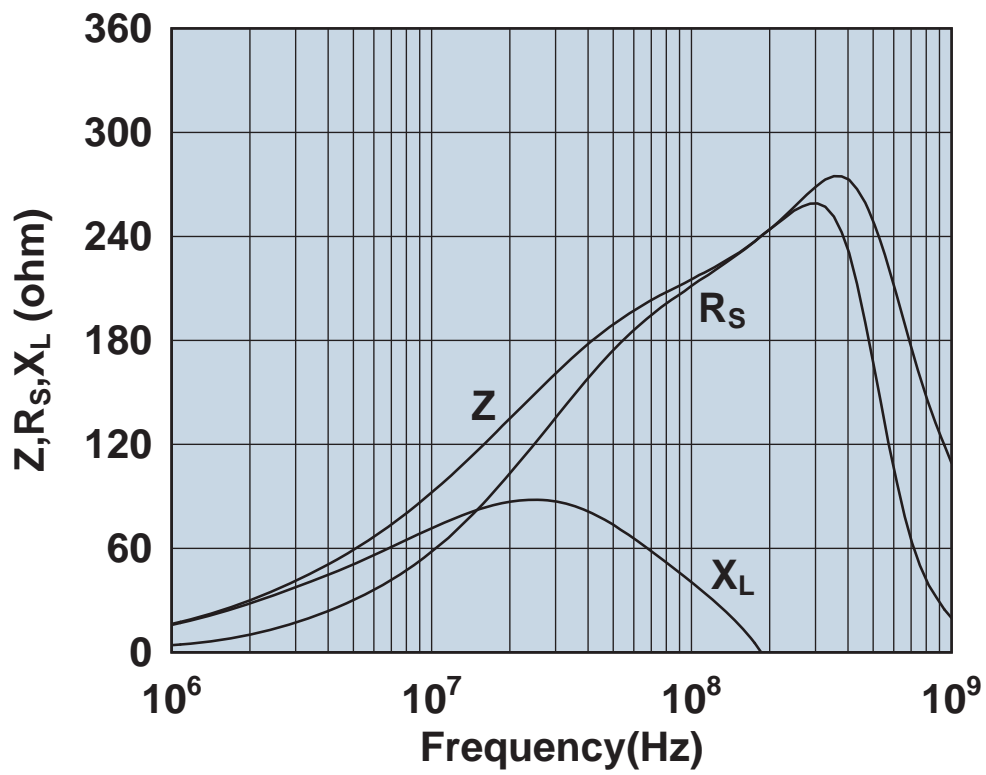

Impedance, reactance, and resistance vs. frequency.

2643102402

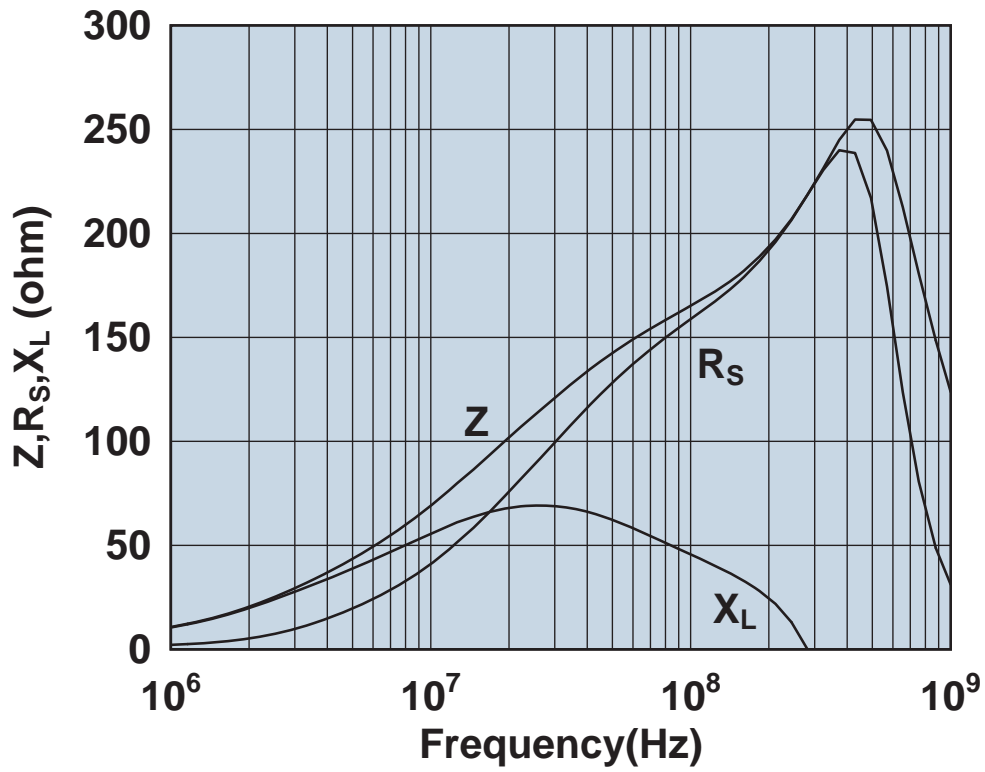

Impedance, reactance, and resistance vs. frequency.

2643103002

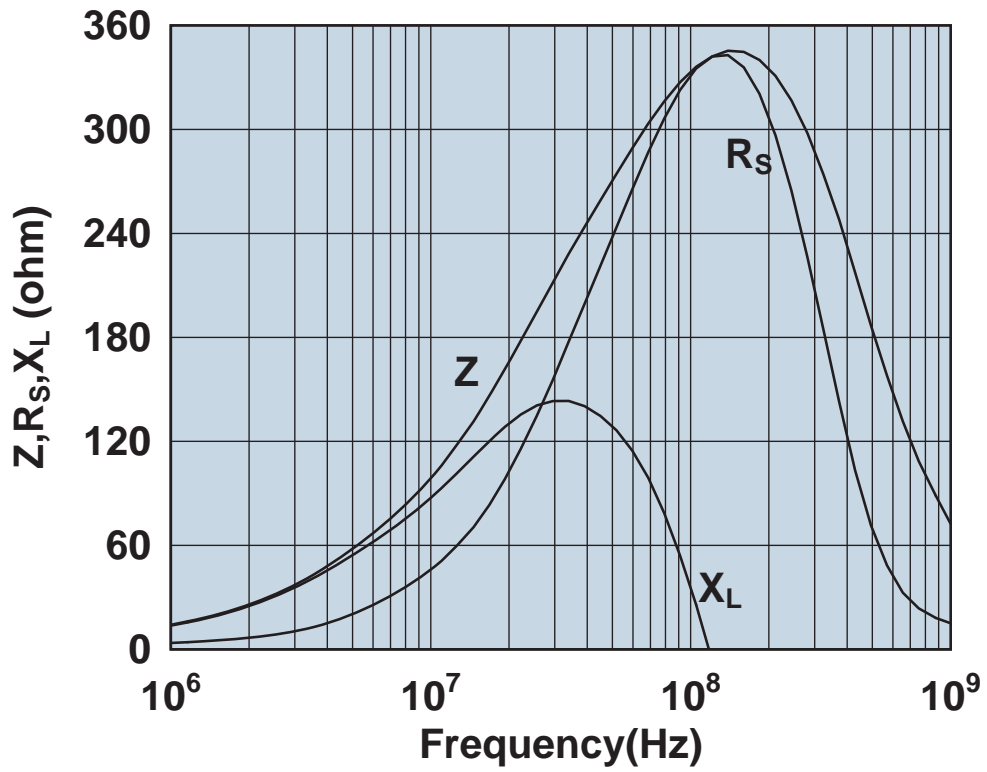

Impedance, reactance, and resistance vs. frequency.

2643103102

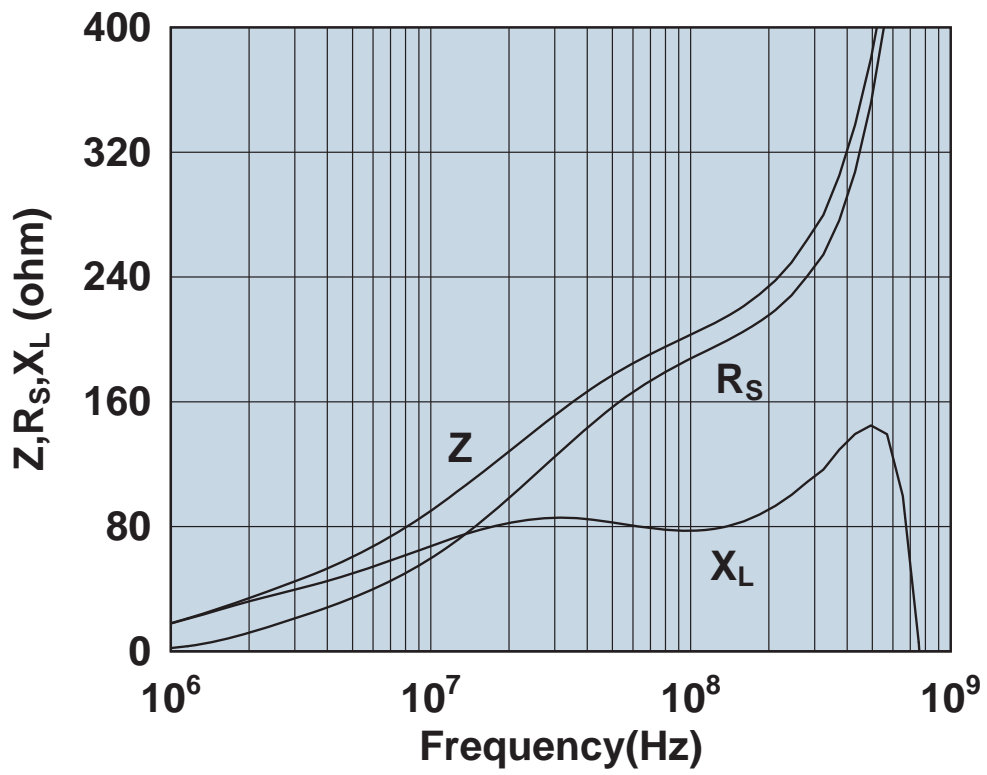

Impedance, reactance, and resistance vs. frequency.

2643163851

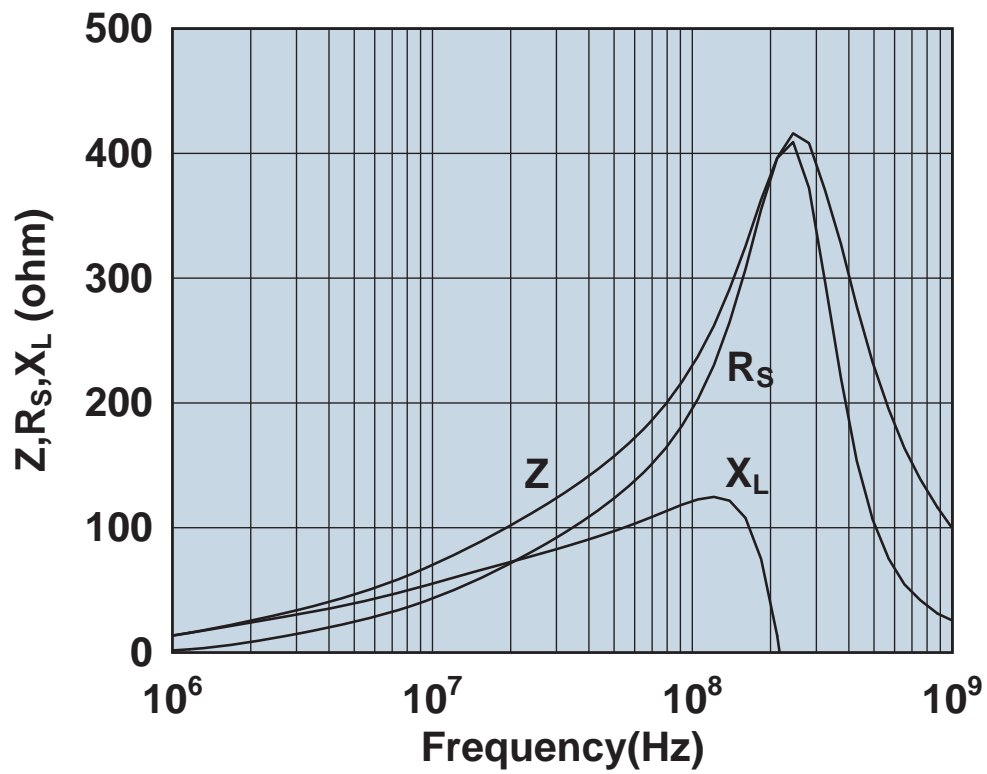

Impedance, reactance, and resistance vs. frequency.

2643163951

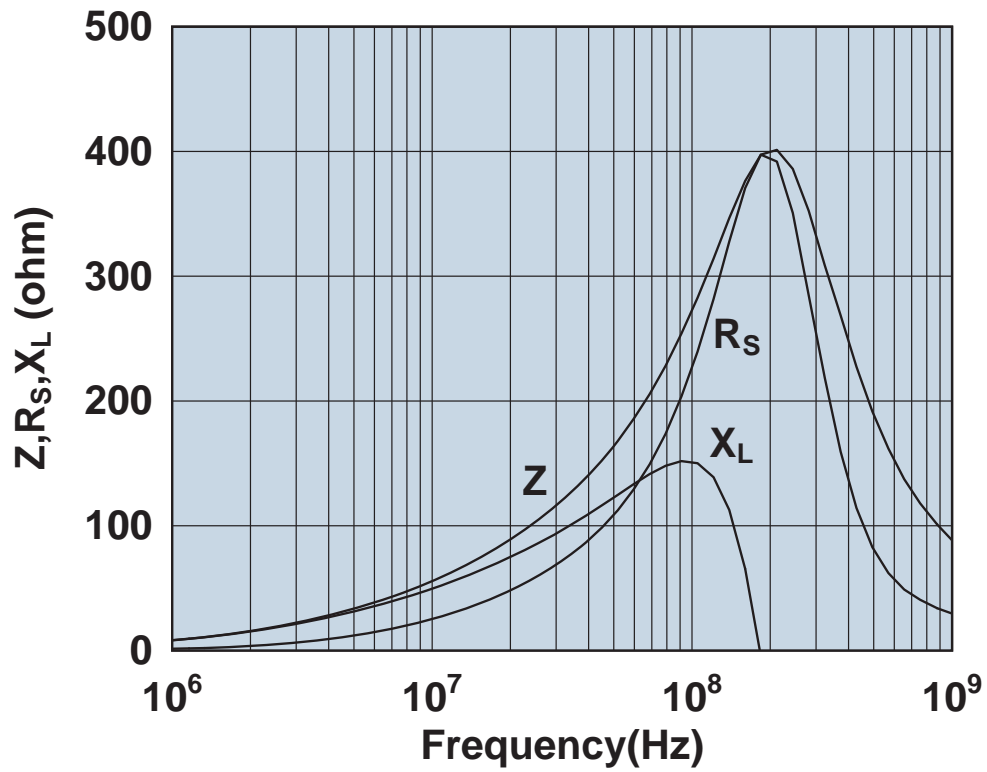

Impedance, reactance, and resistance vs. frequency.

2643164051

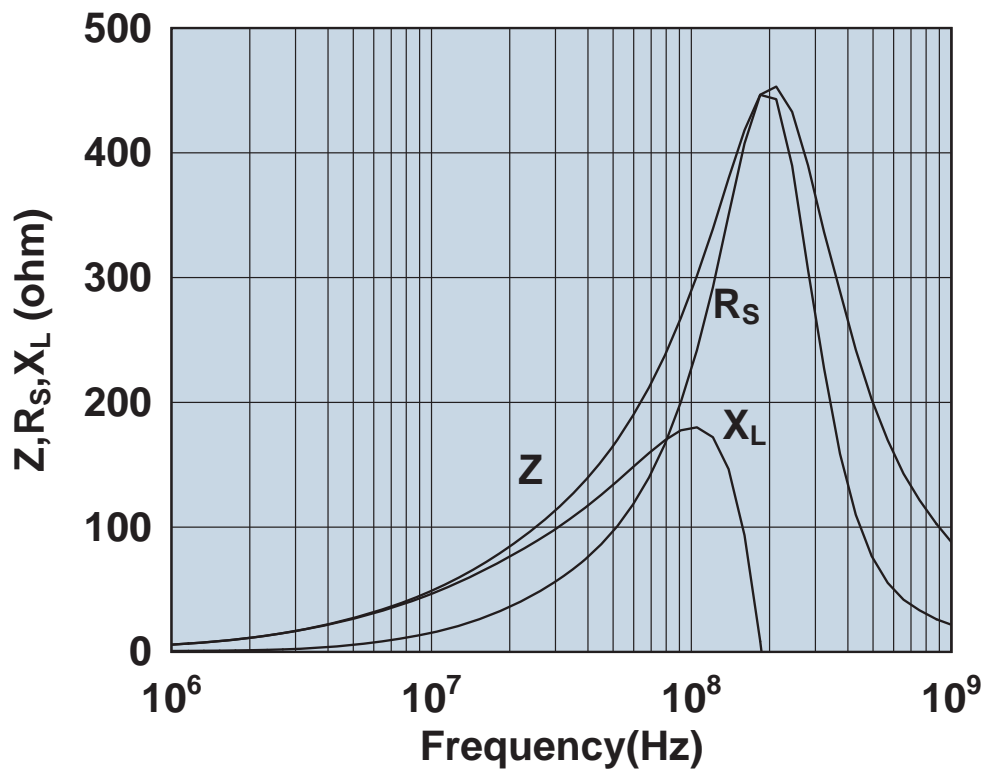

Impedance, reactance, and resistance vs. frequency.

2643164151

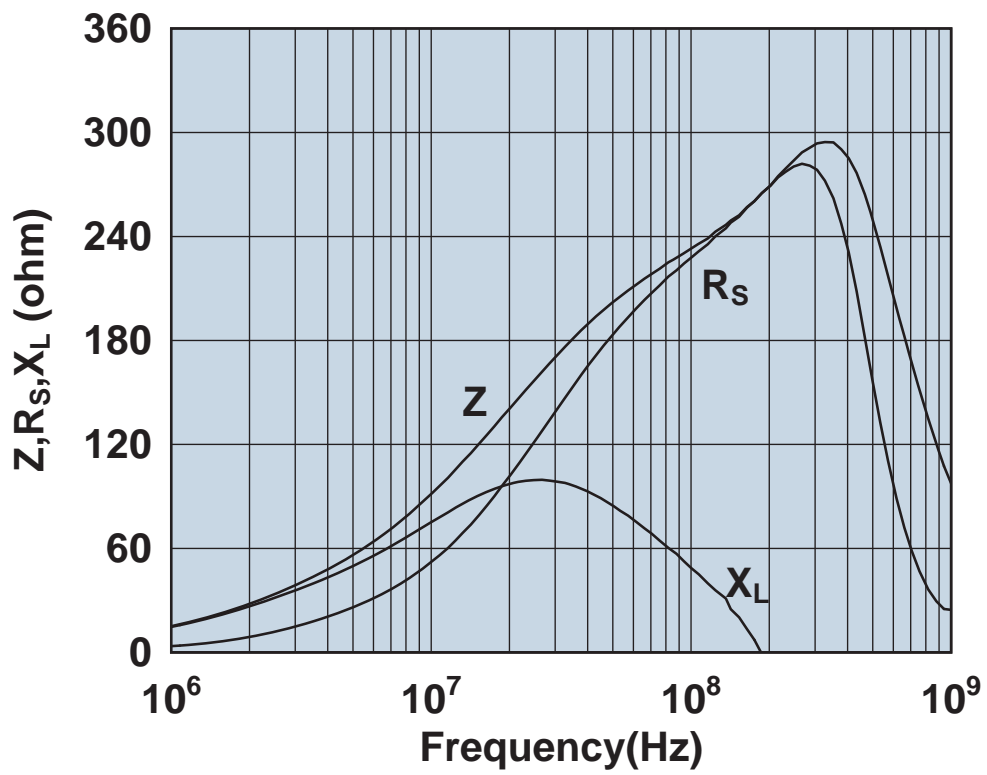

Impedance, reactance, and resistance vs. frequency.

2643164251

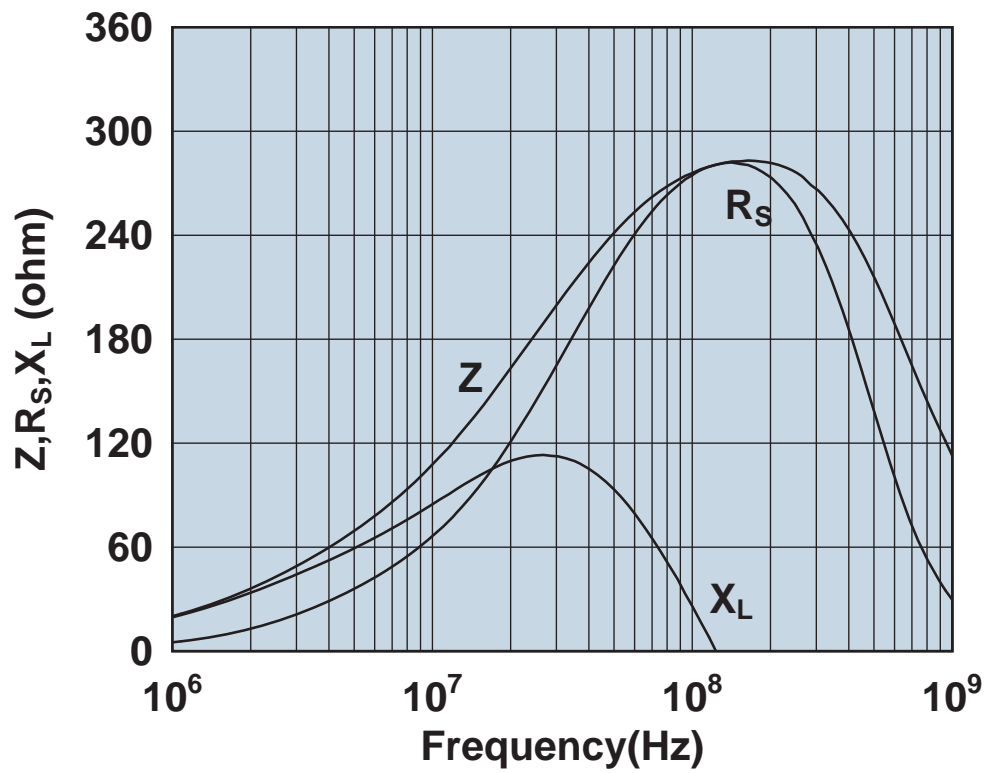

Impedance, reactance, and resistance vs. frequency.

2643164551

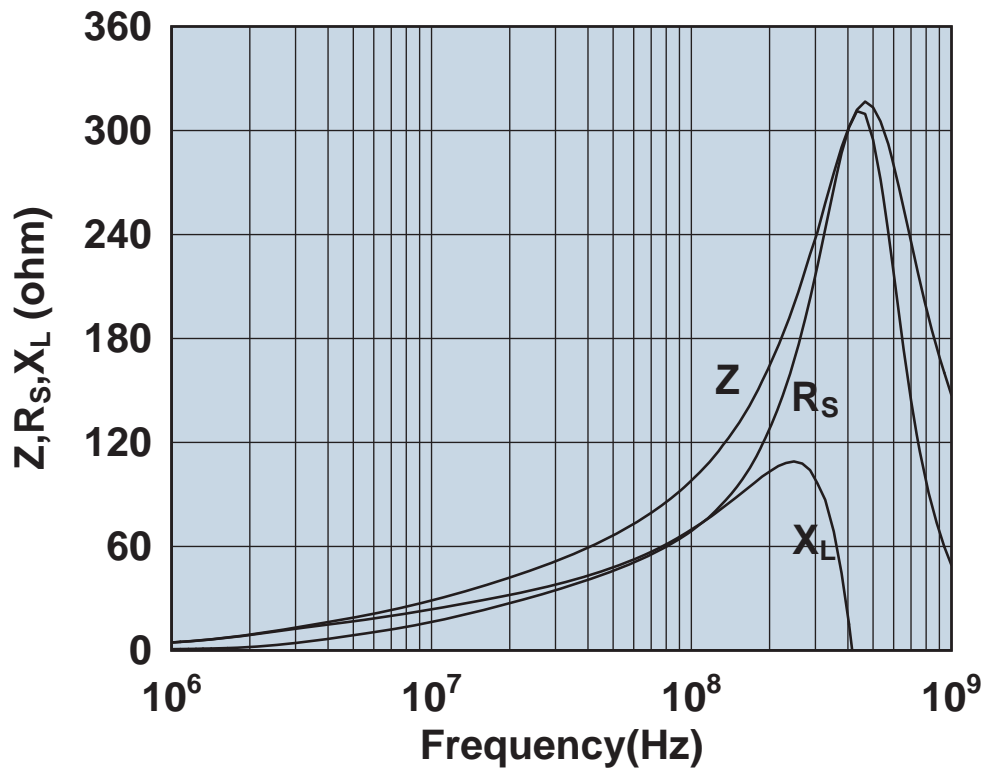

Impedance, reactance, and resistance vs. frequency.

2643165151

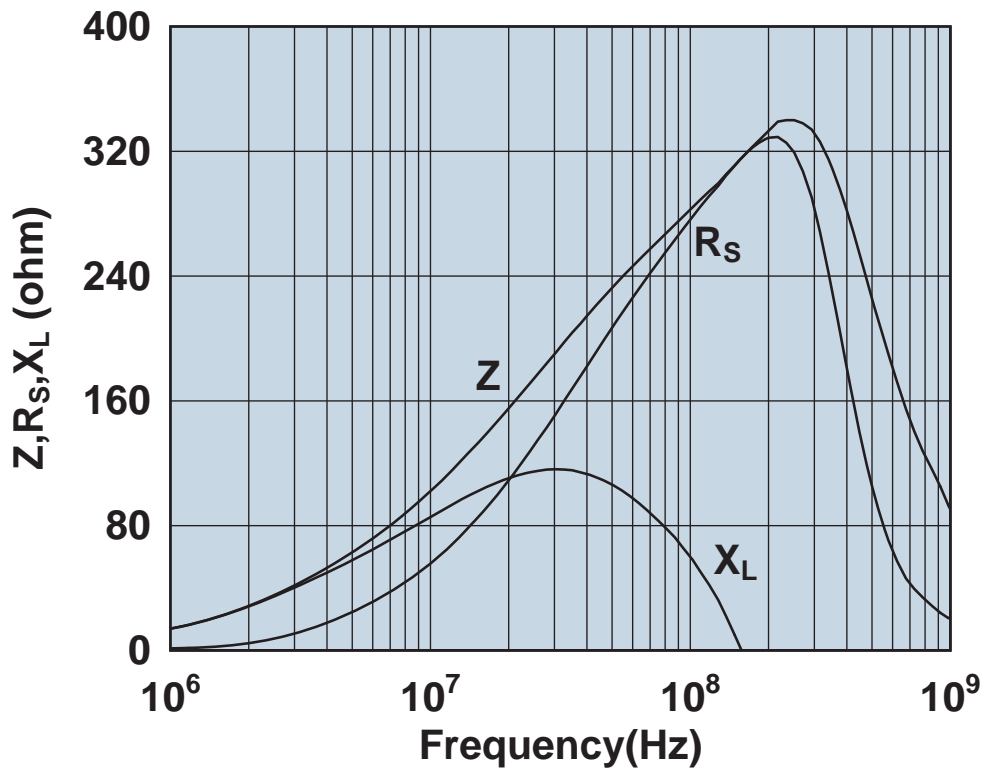

Impedance, reactance, and resistance vs. frequency.

2643165451

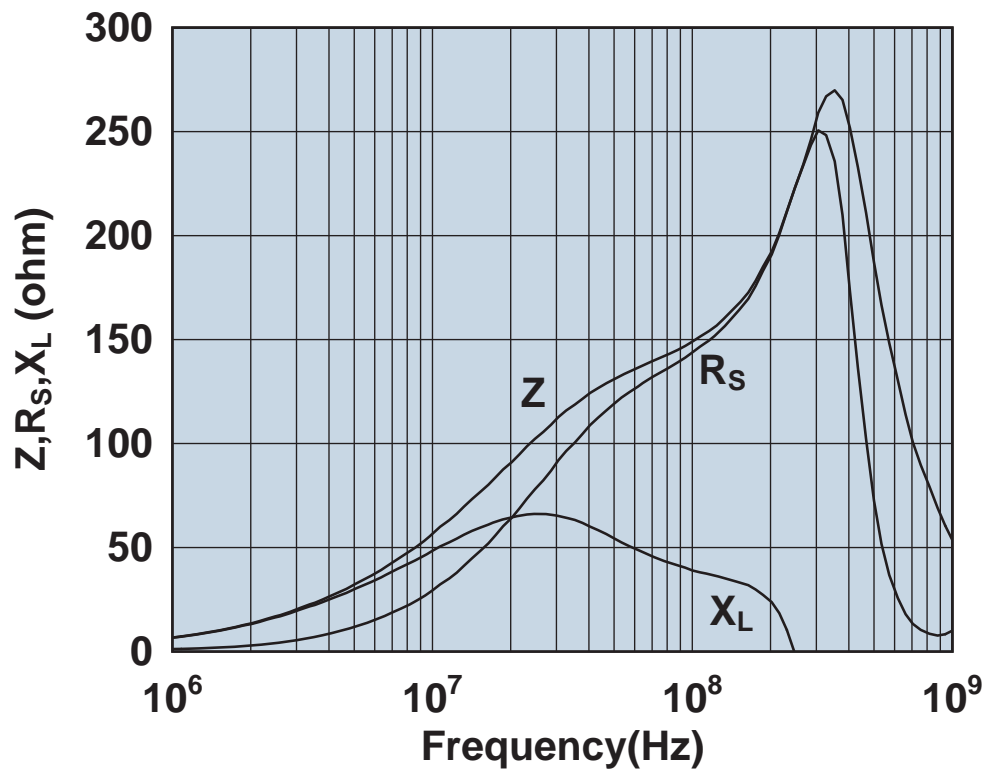

Impedance, reactance, and resistance vs. frequency.

2643166251

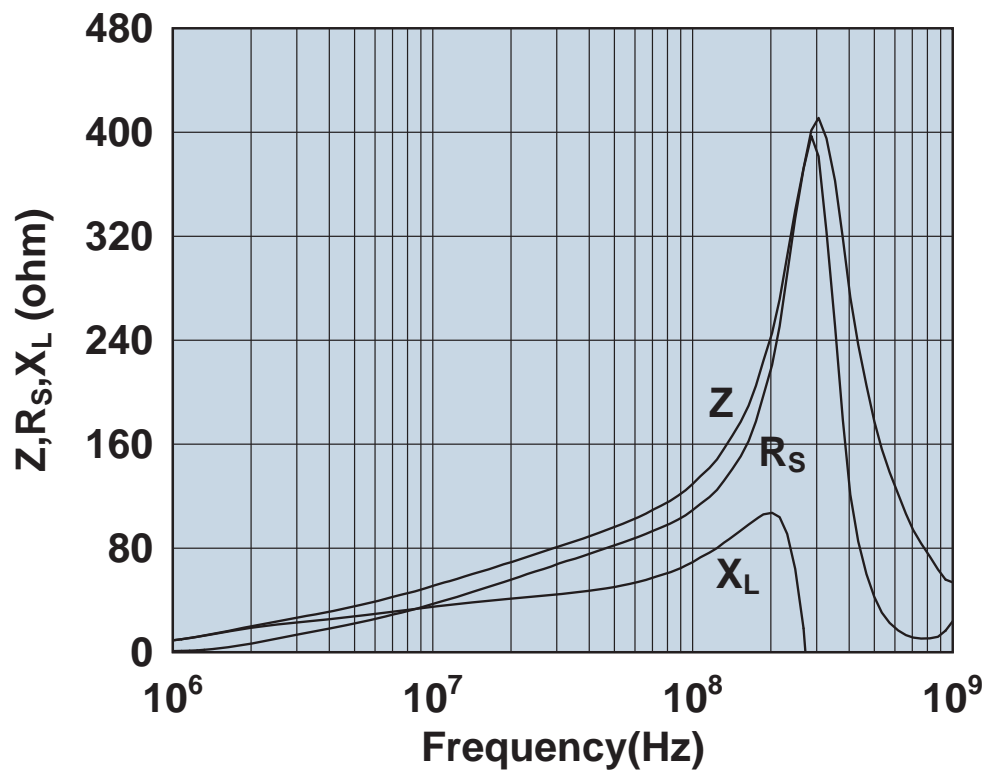

Impedance, reactance, and resistance vs. frequency.

2643166451

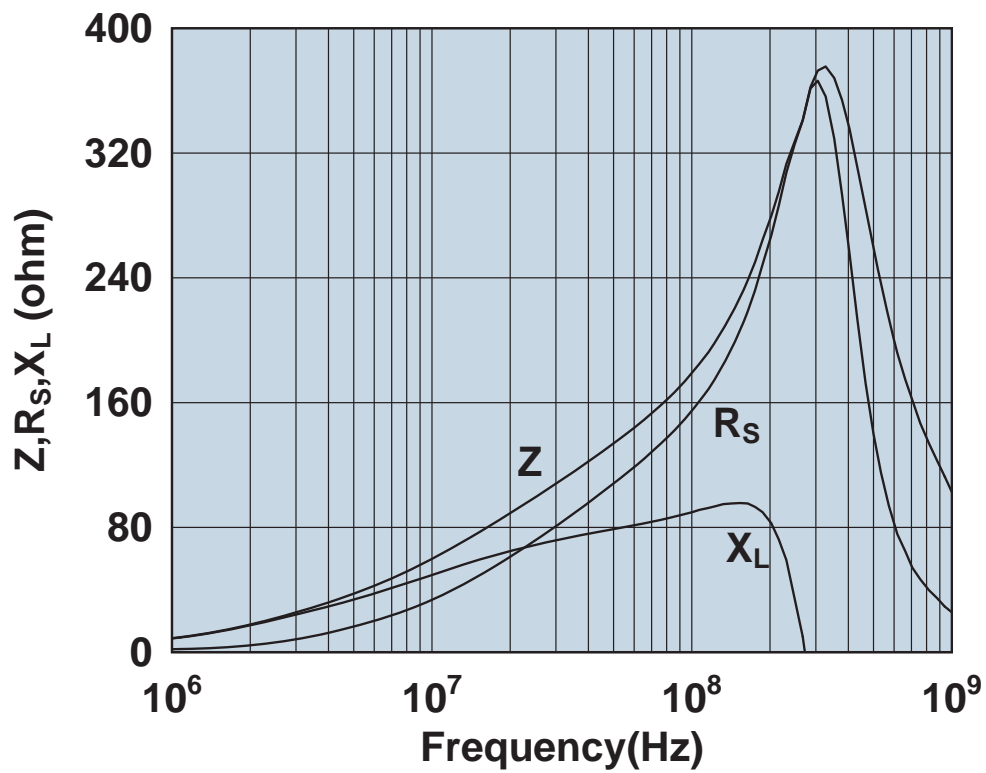

Impedance, reactance, and resistance vs. frequency.

2643166551

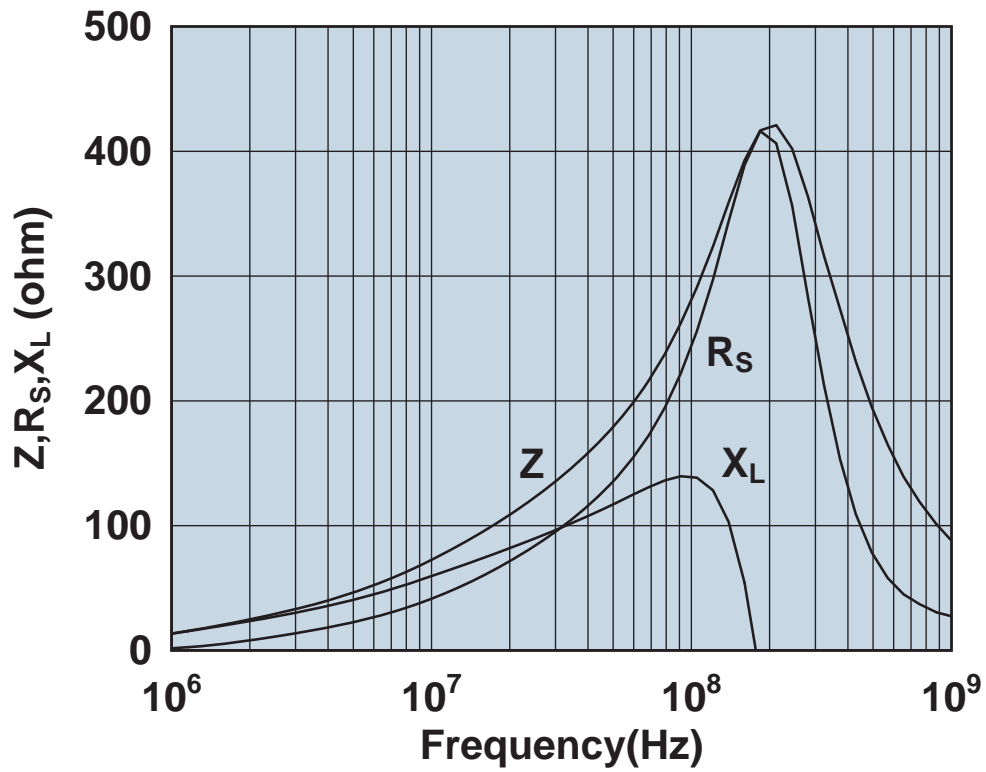

Impedance, reactance, and resistance vs. frequency.

2643166651

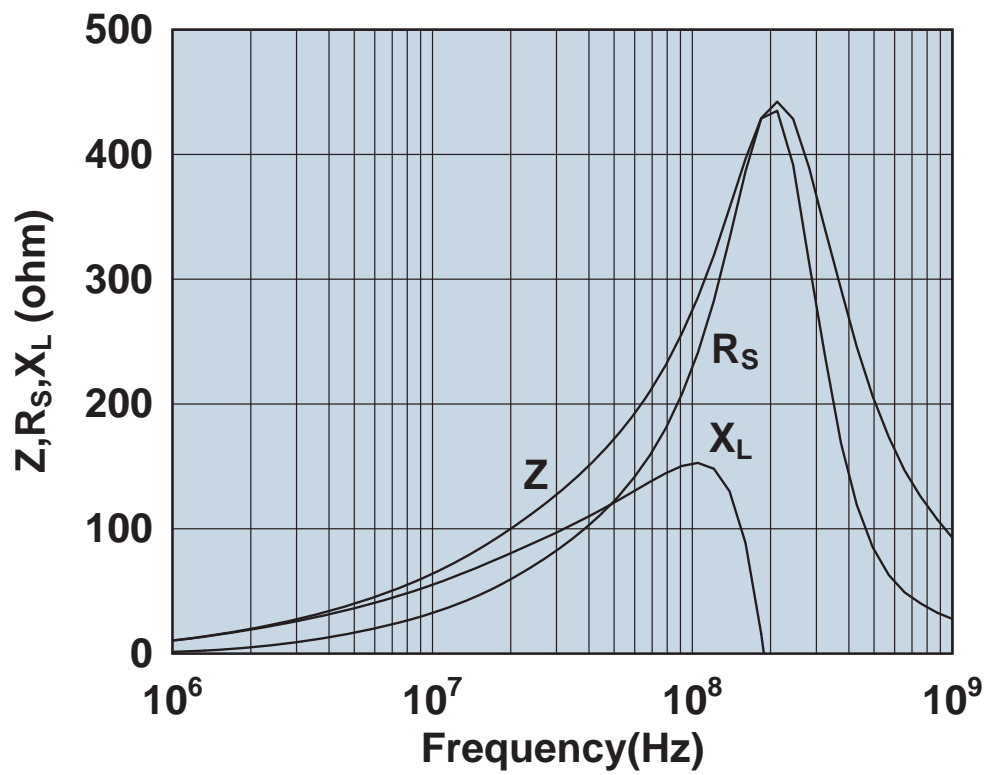

Impedance, reactance, and resistance vs. frequency.

2643166751

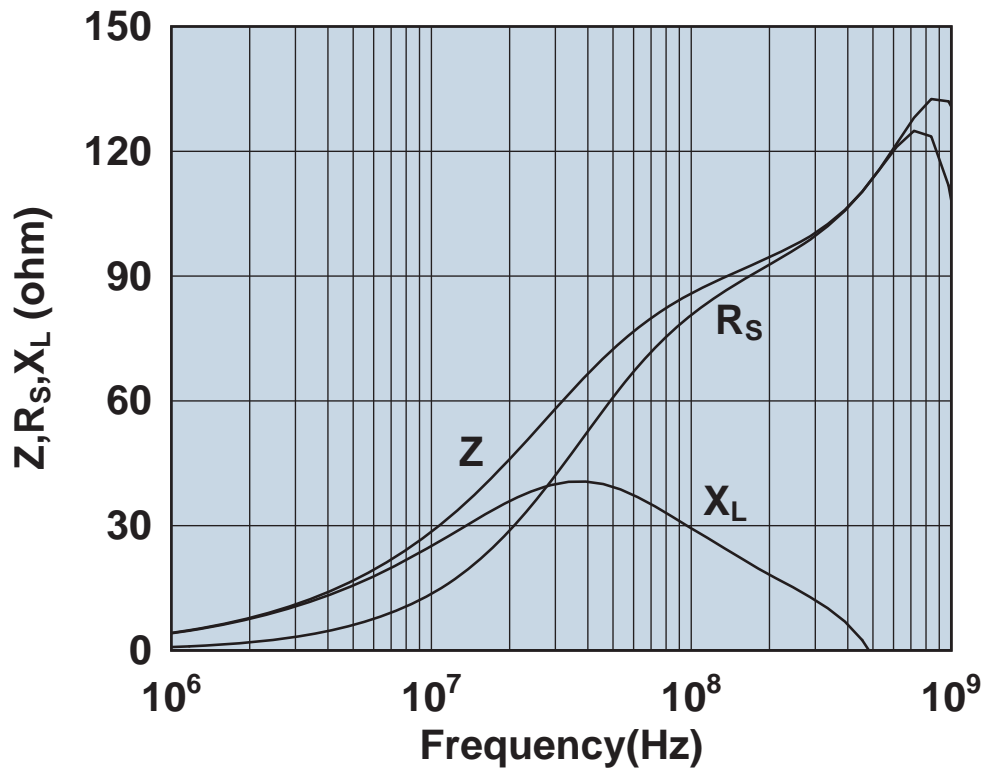

Impedance, reactance, and resistance vs. frequency.

2643166851

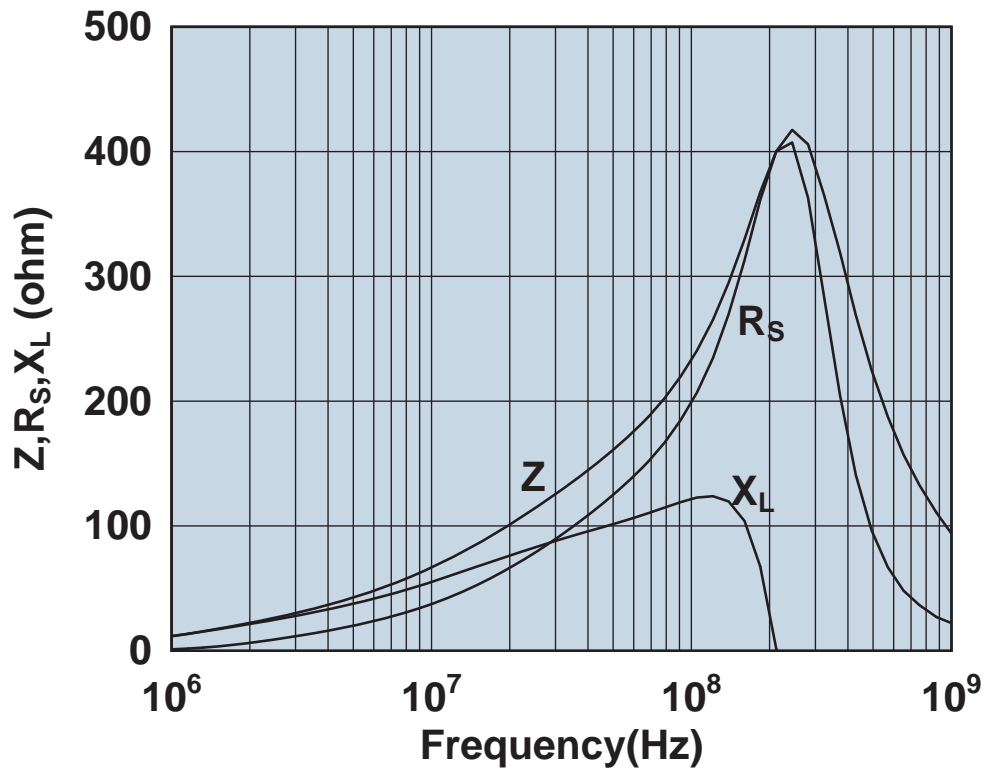

Impedance, reactance, and resistance vs. frequency.

2643167251

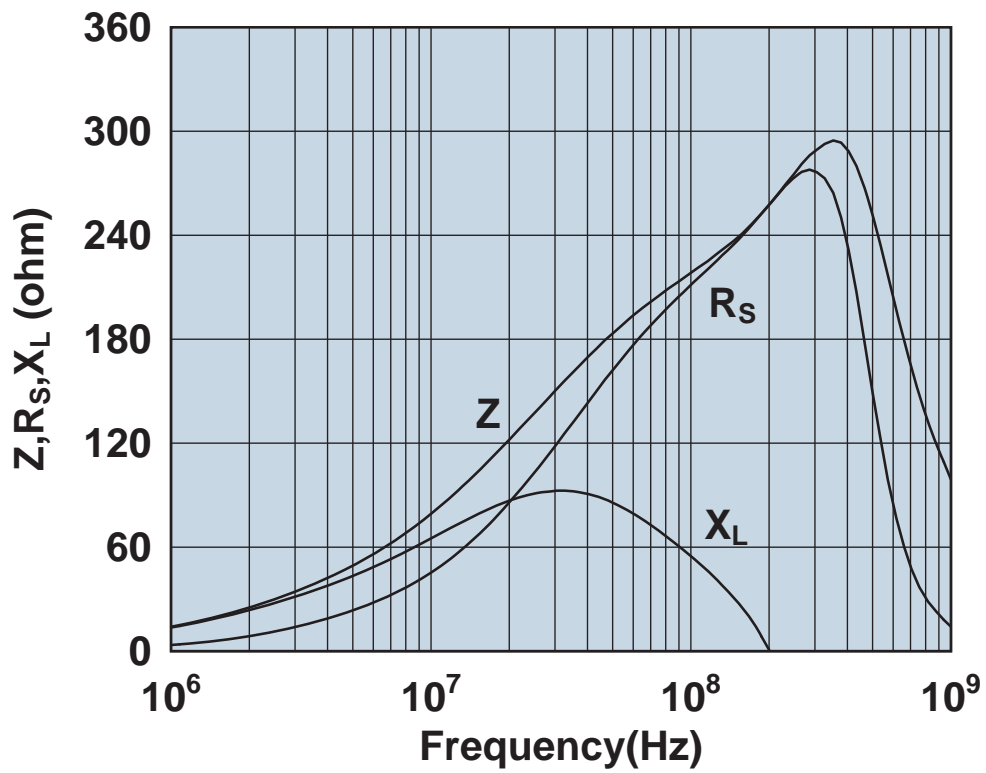

Impedance, reactance, and resistance vs. frequency.

2643167551

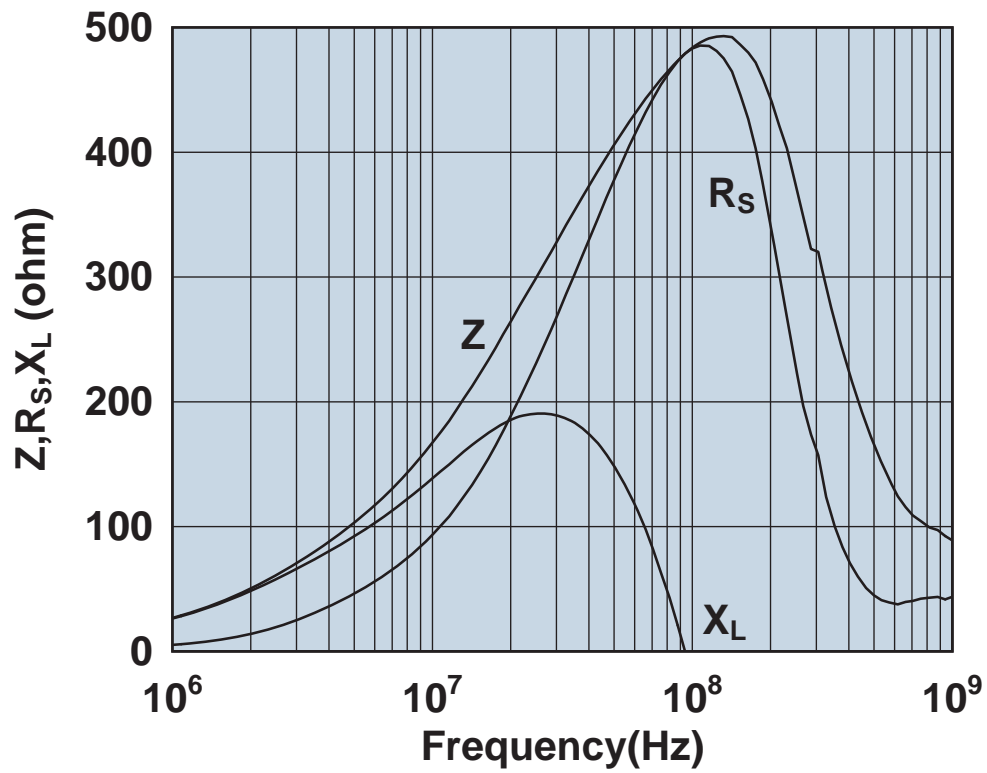

Impedance, reactance, and resistance vs. frequency.

2643167751

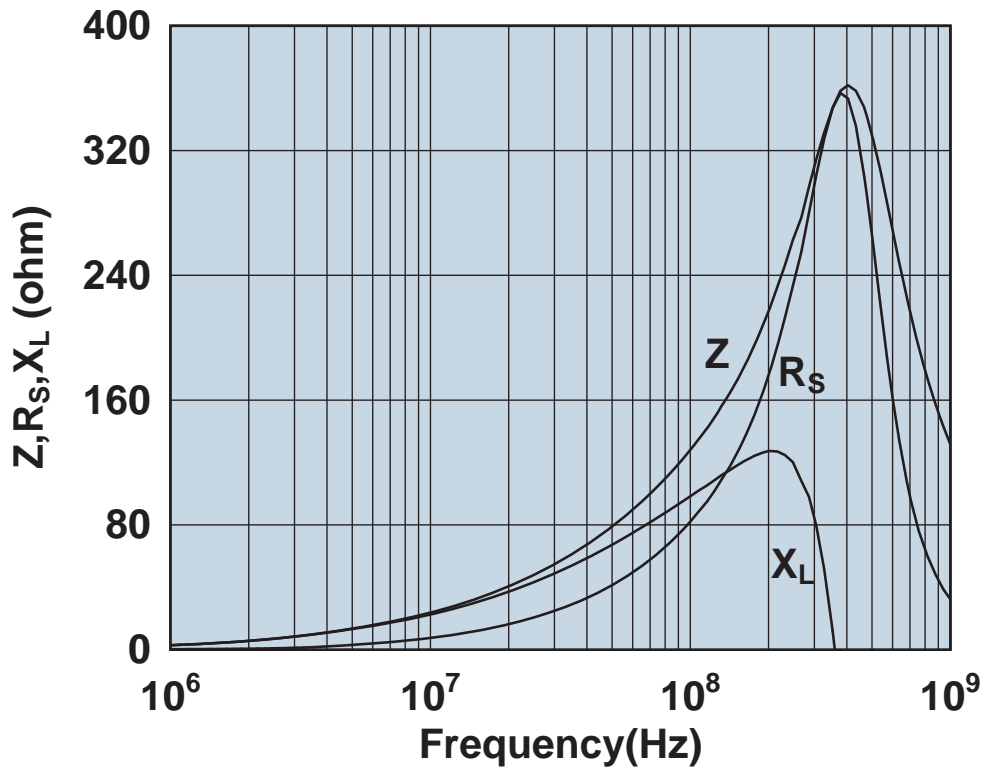

Impedance, reactance, and resistance vs. frequency.

2643167851

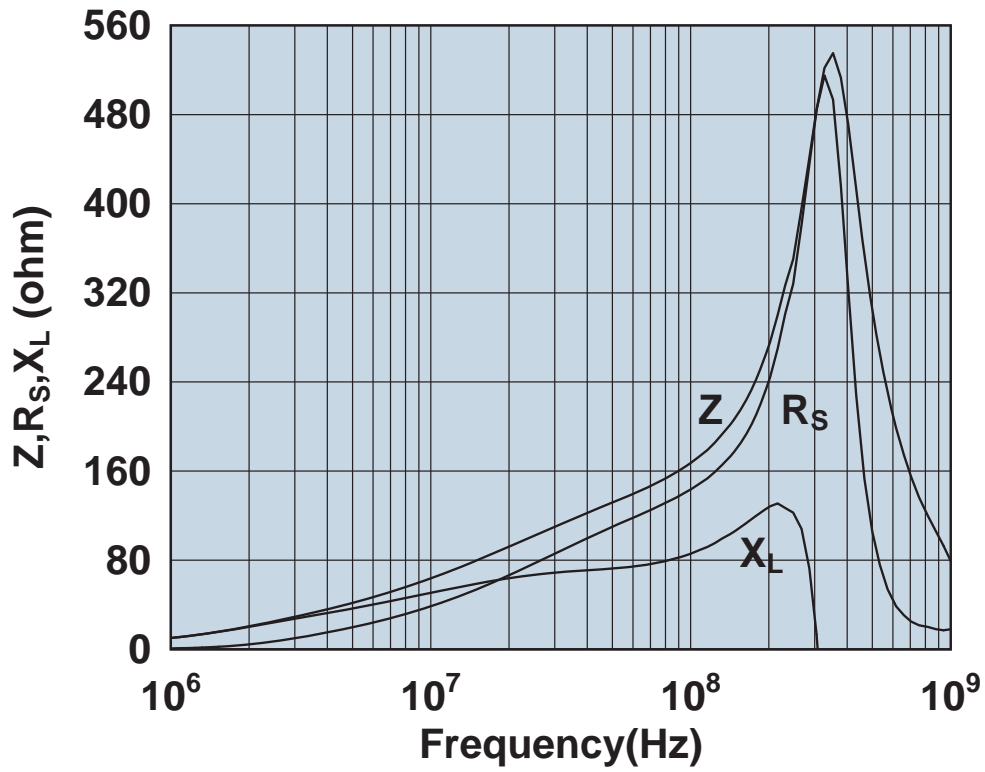

Impedance, reactance, and resistance vs. frequency.

2643168051

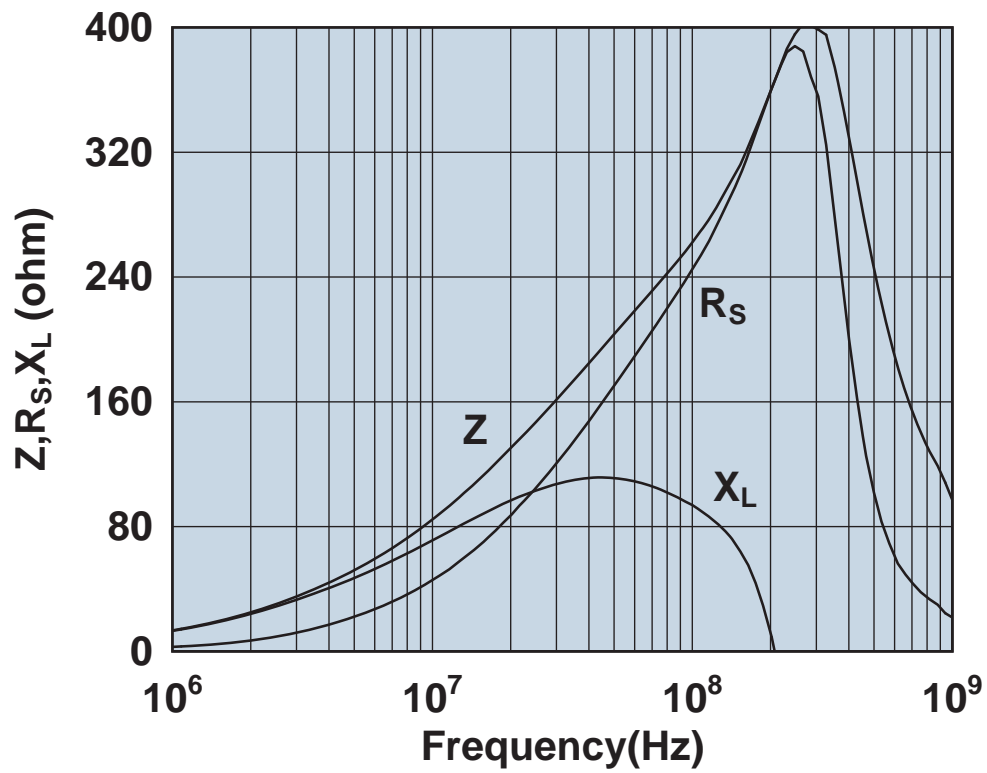

Impedance, reactance, and resistance vs. frequency.

2643168251

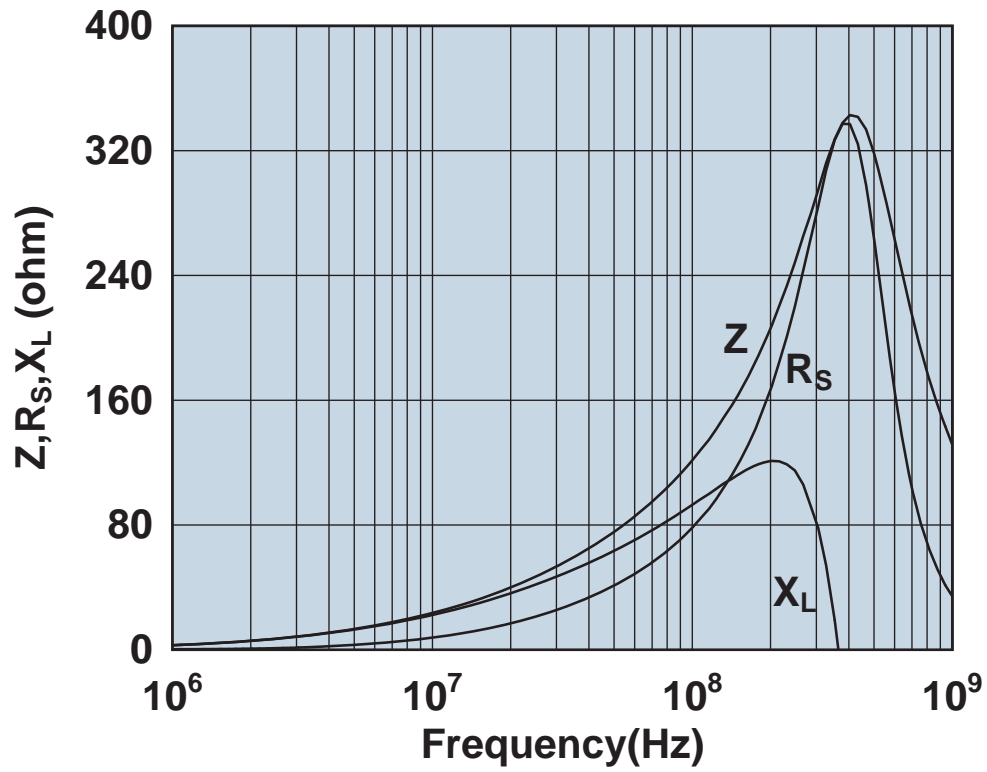

Impedance, reactance, and resistance vs. frequency.

2643168351

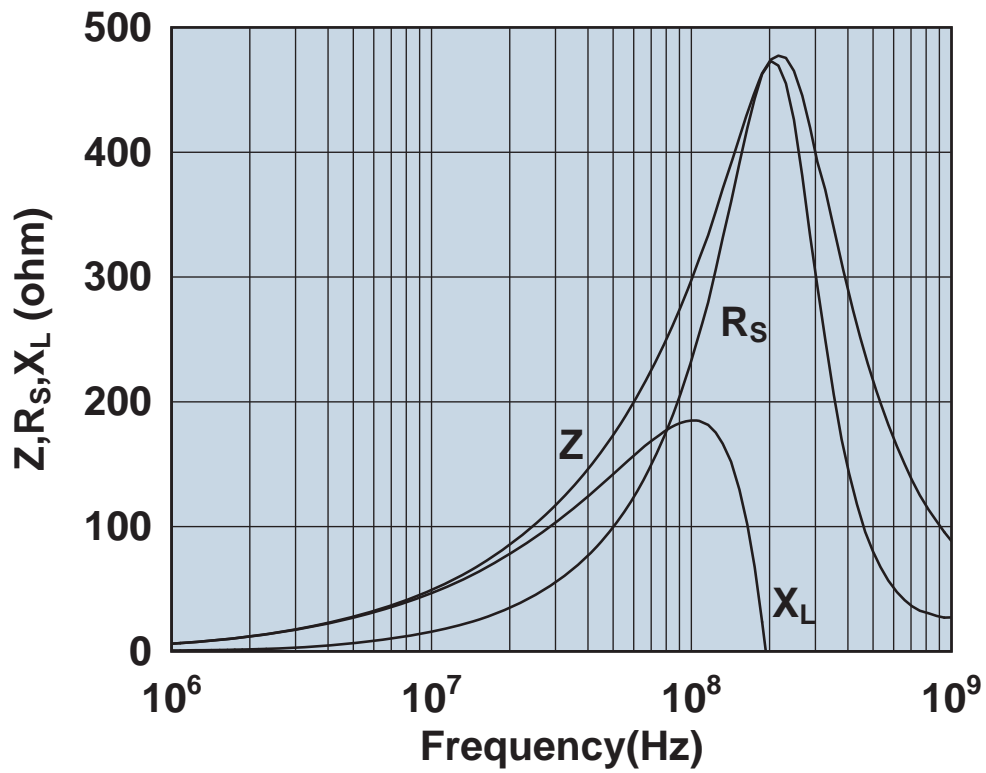

Impedance, reactance, and resistance vs. frequency.

2643168651

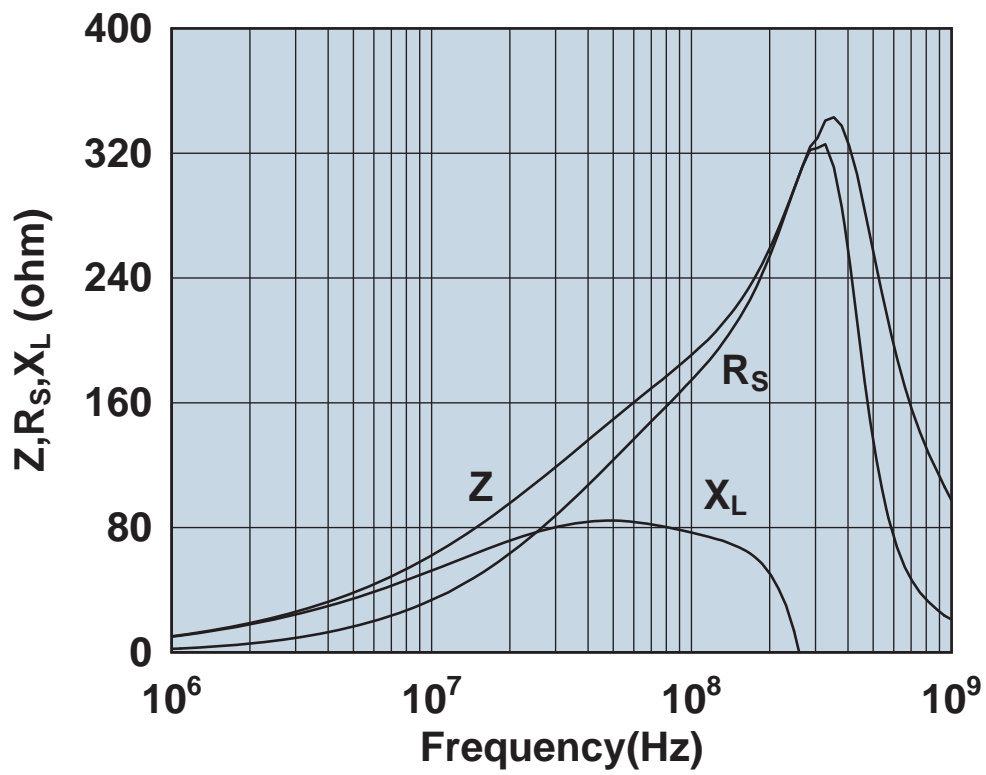

Impedance, reactance, and resistance vs. frequency.

2643168751

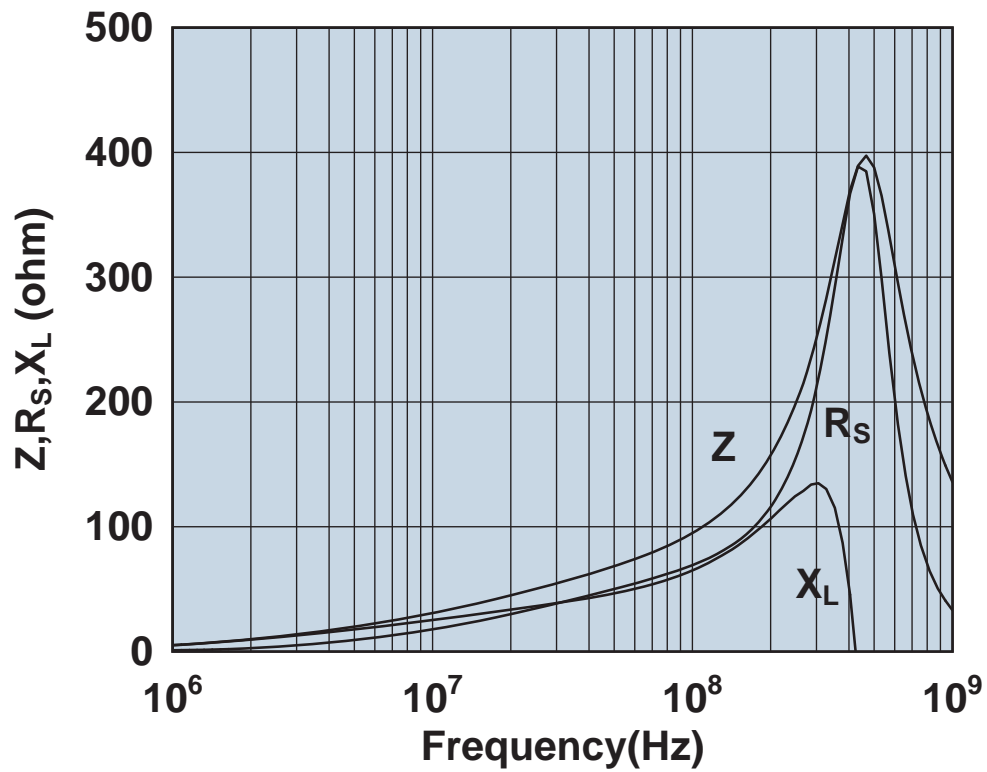

Impedance, reactance, and resistance vs. frequency.

2643169351

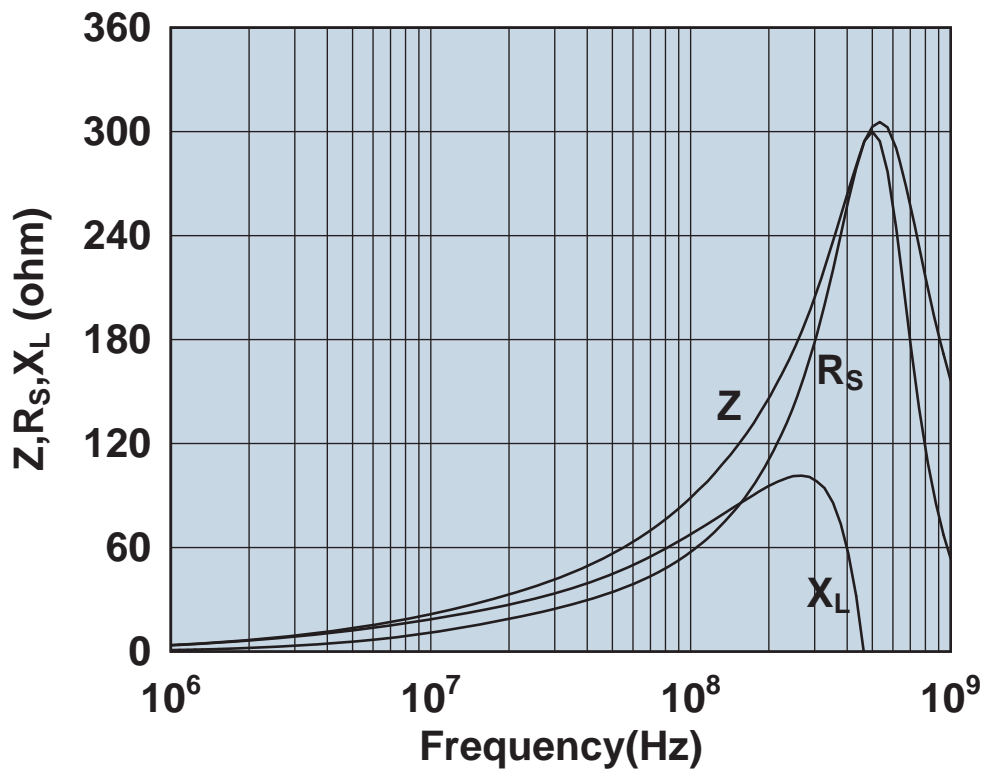

Impedance, reactance, and resistance vs. frequency.

2643169552

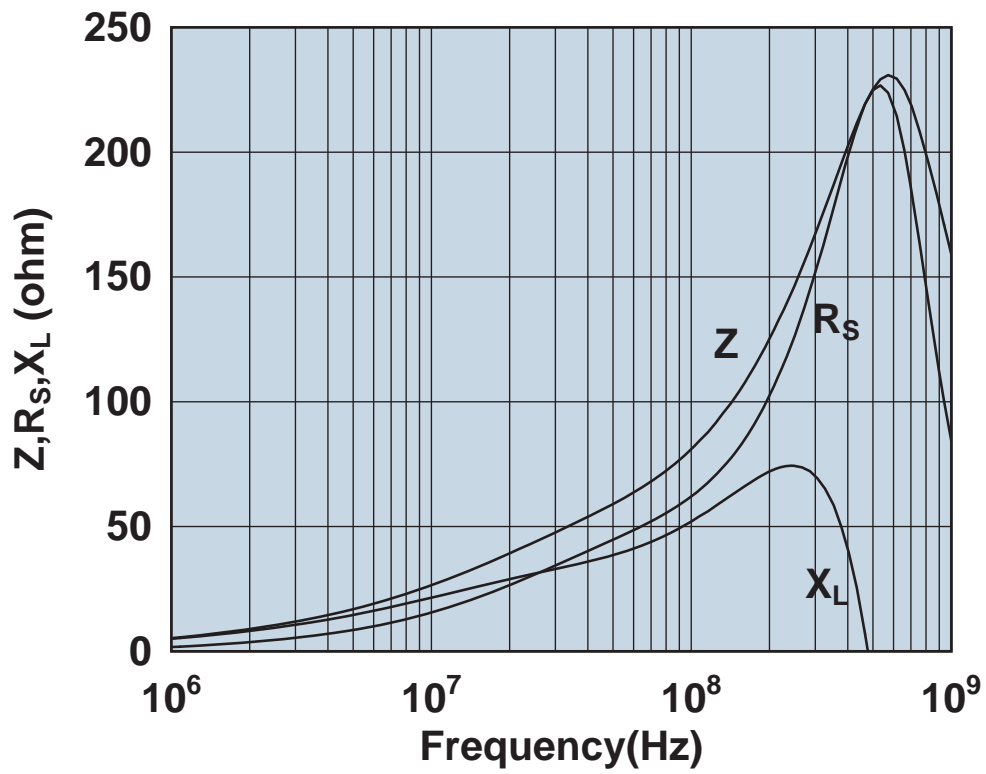

Impedance, reactance, and resistance vs. frequency.

2643170251

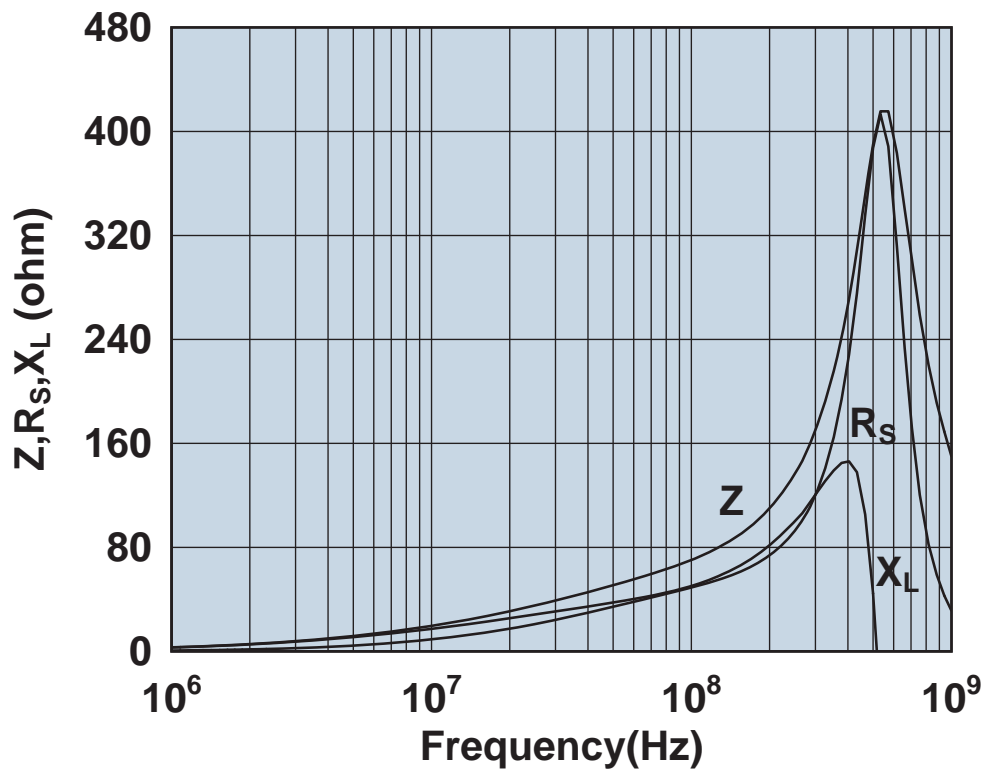

Impedance, reactance, and resistance vs. frequency.

2643170951

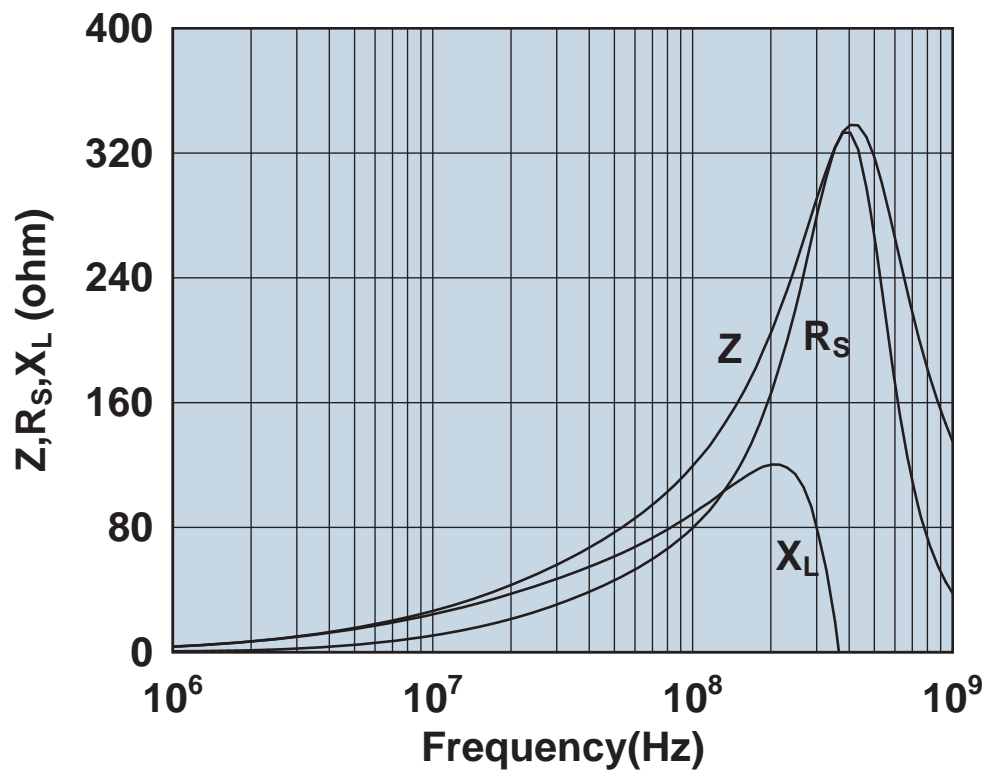

Impedance, reactance, and resistance vs. frequency.

2643171051

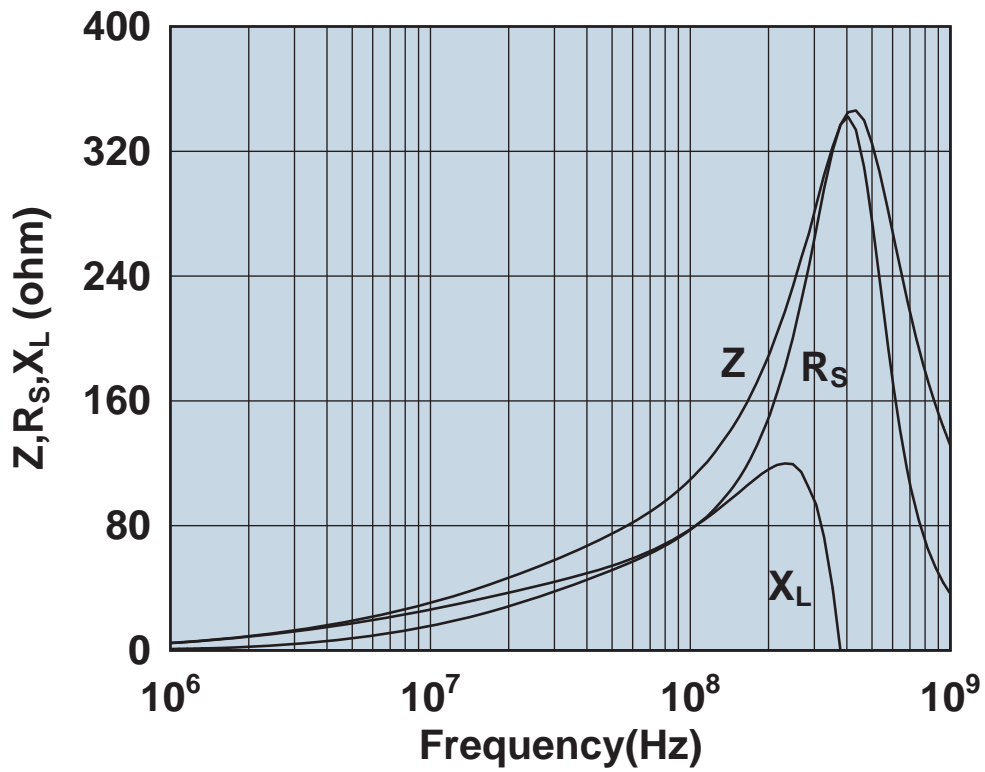

Impedance, reactance, and resistance vs. frequency.

2643172551

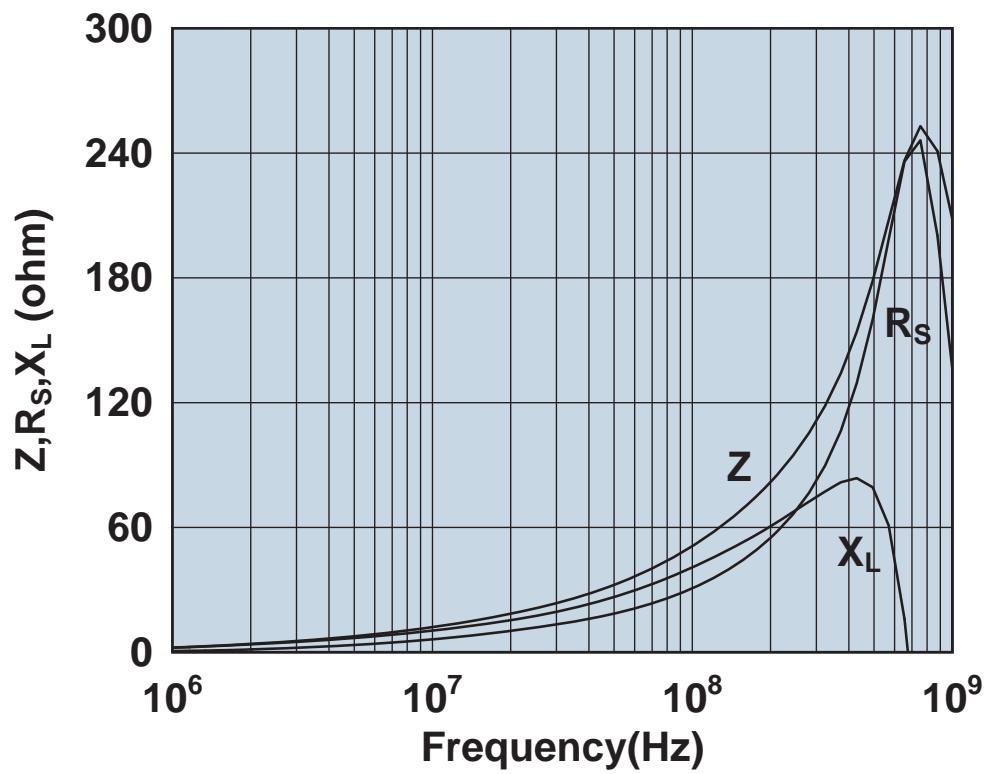

Impedance, reactance, and resistance vs. frequency.

2643173351

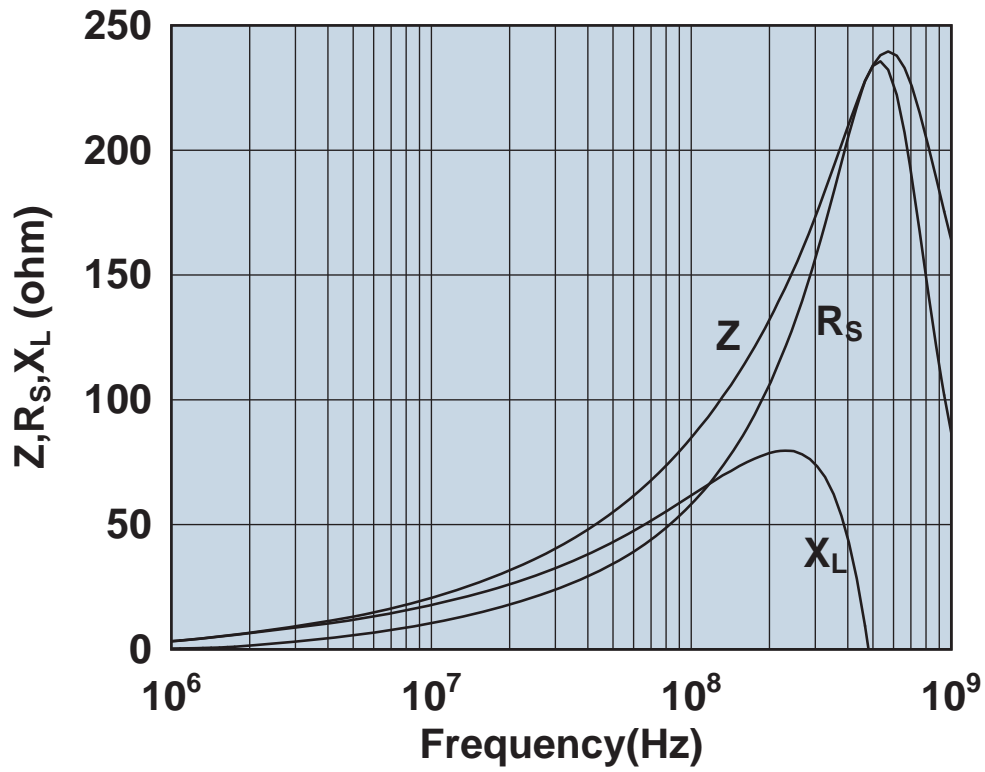

Impedance, reactance, and resistance vs. frequency.

2643175451

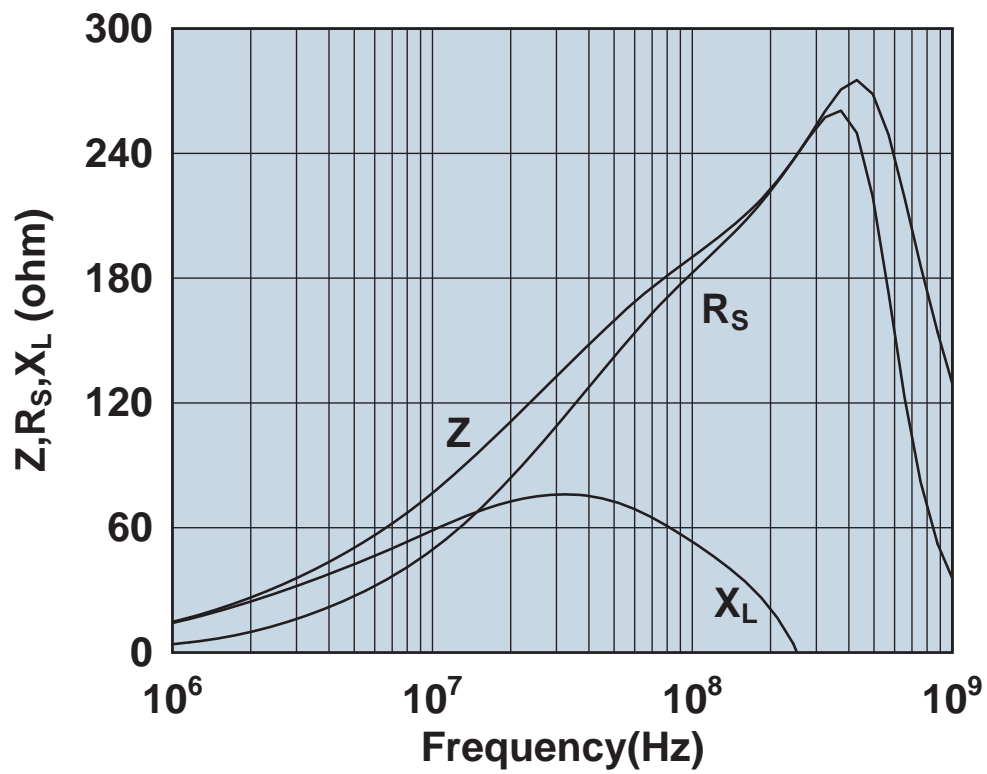

Impedance, reactance, and resistance vs. frequency.

2643178181

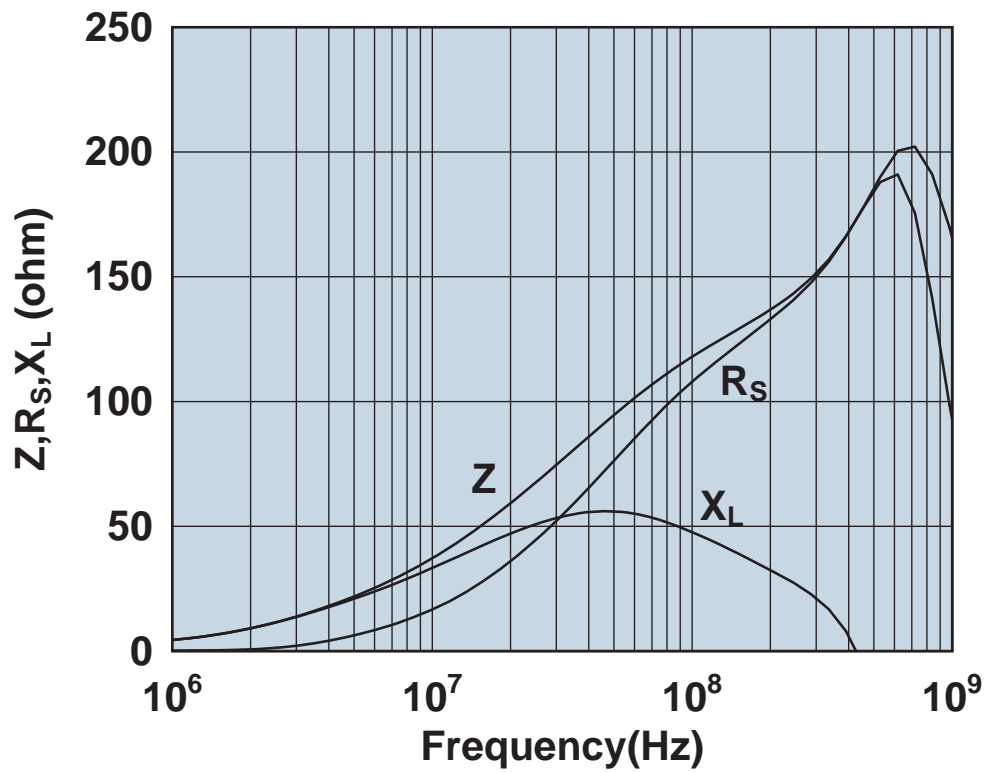

Impedance, reactance, and resistance vs. frequency.

2643178281

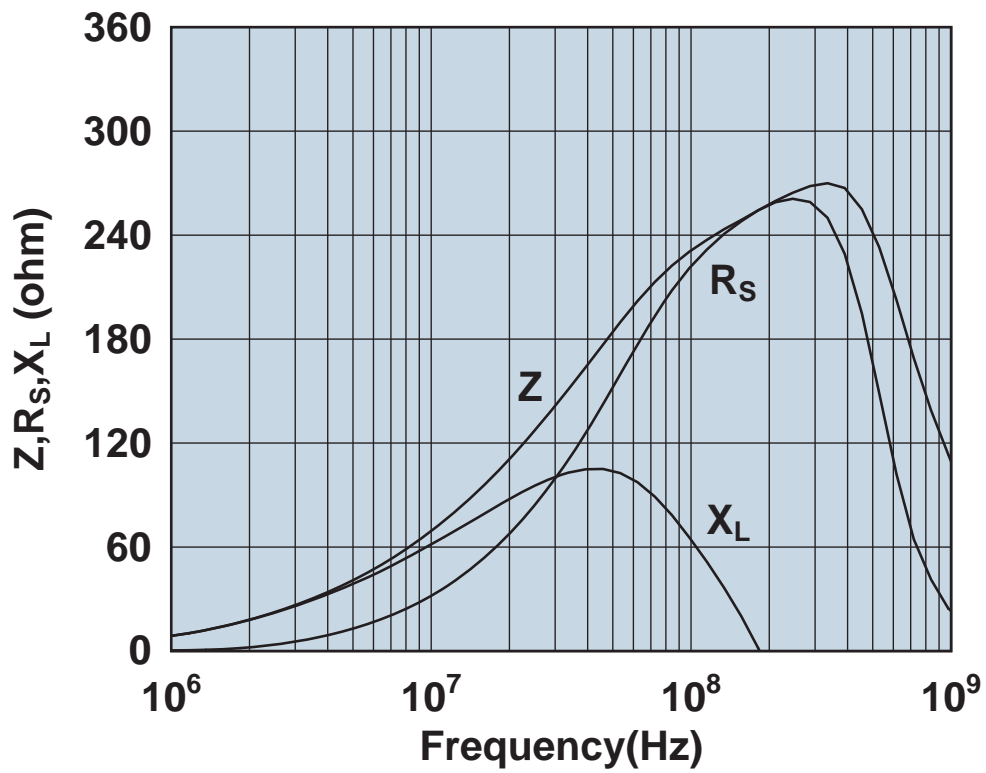

Impedance, reactance, and resistance vs. frequency.

2643178351

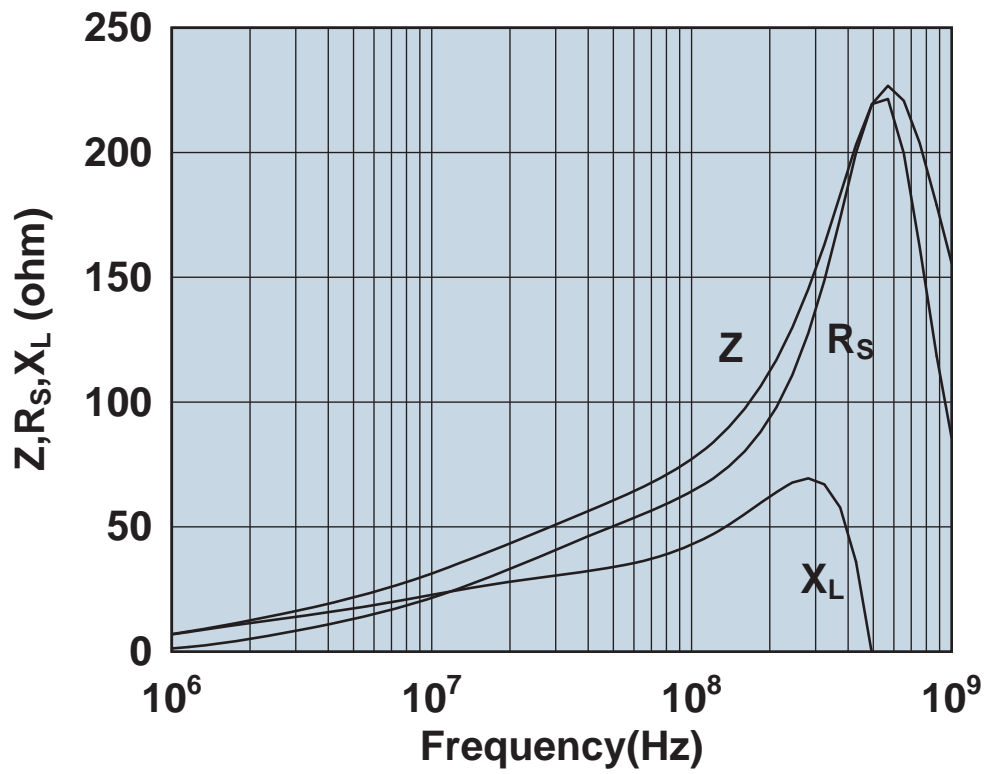

Impedance, reactance, and resistance vs. frequency.

2643178451

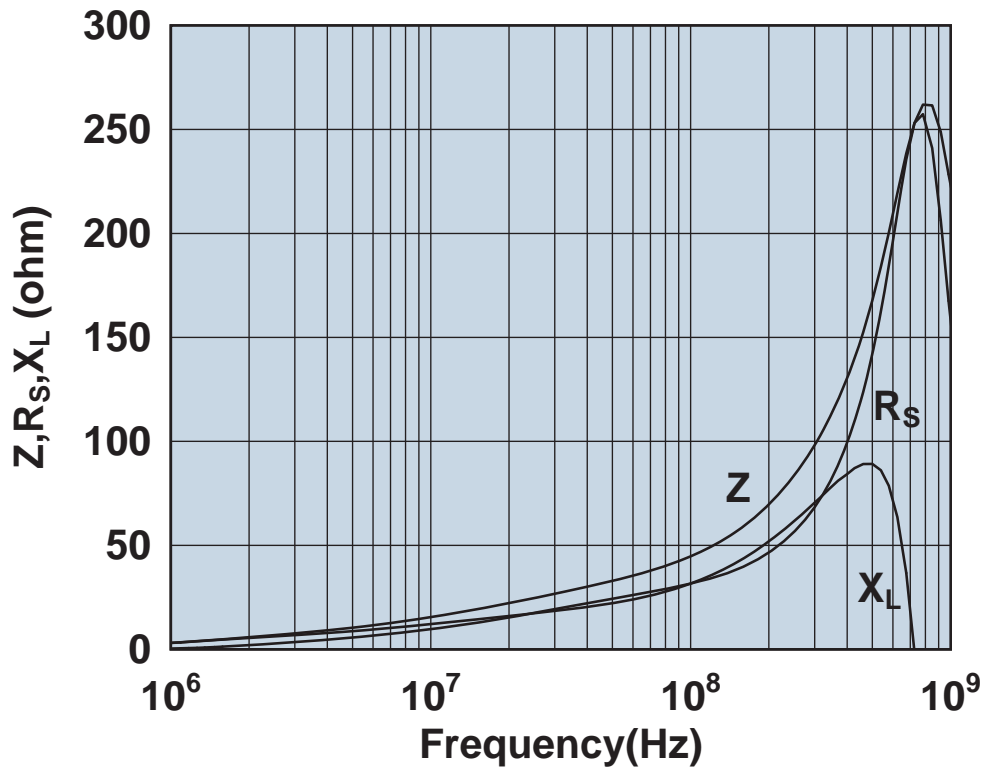

Impedance, reactance, and resistance vs. frequency.

2643178551

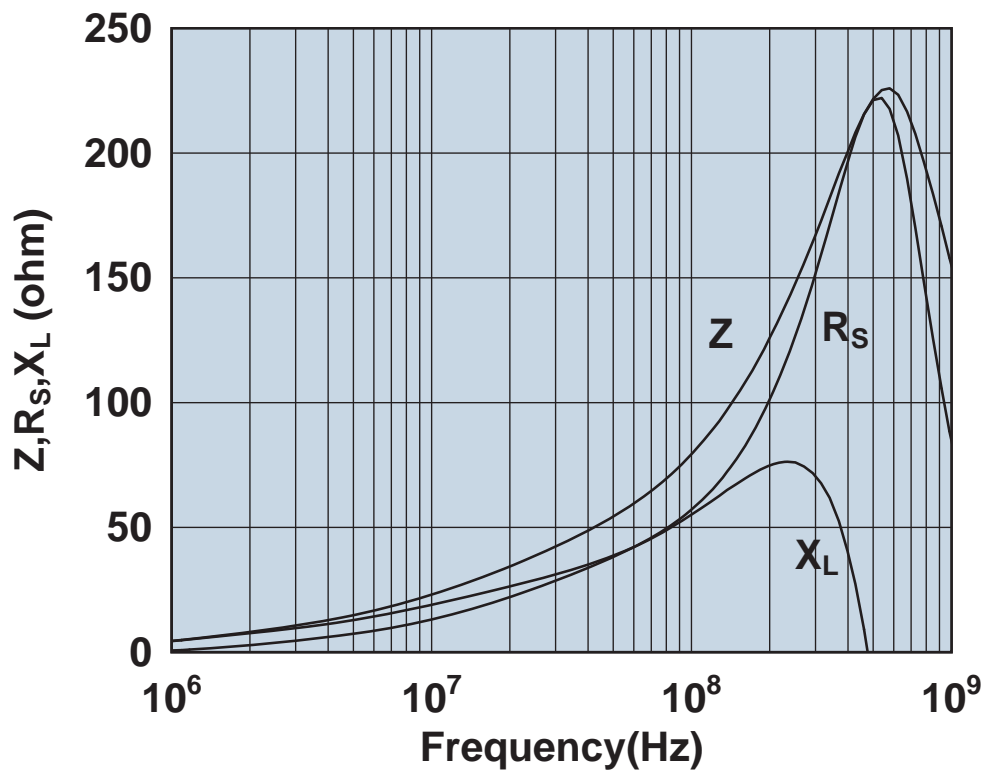

Impedance, reactance, and resistance vs. frequency.

2643178651

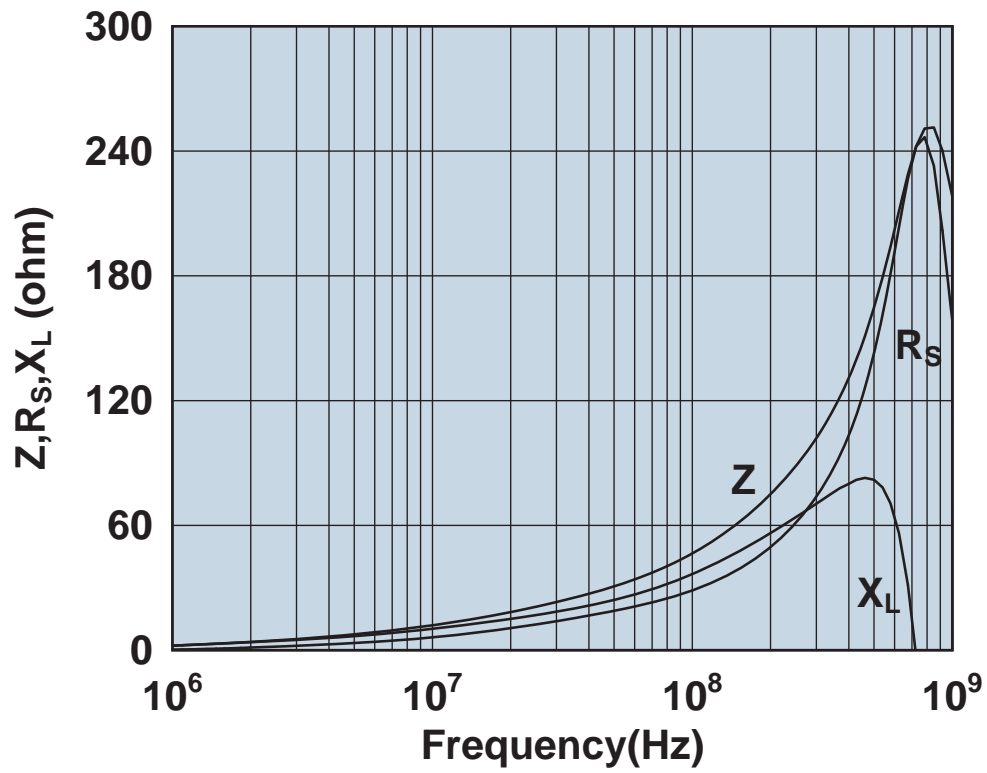

Impedance, reactance, and resistance vs. frequency.

2643178751

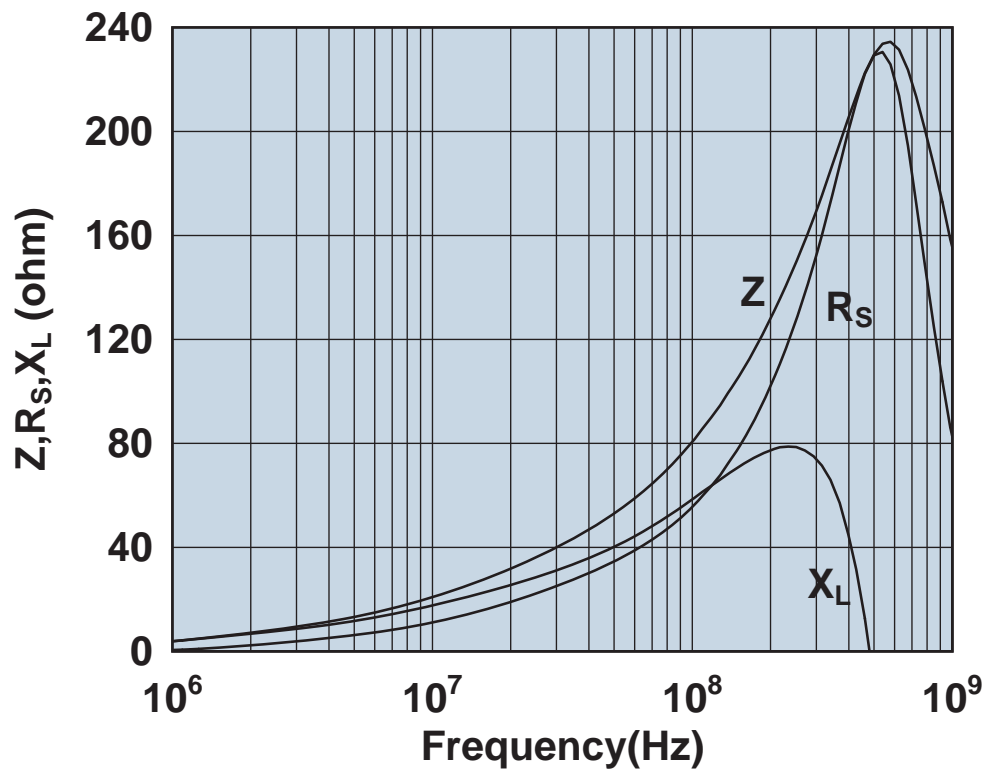

Impedance, reactance, and resistance vs. frequency.

2643178851

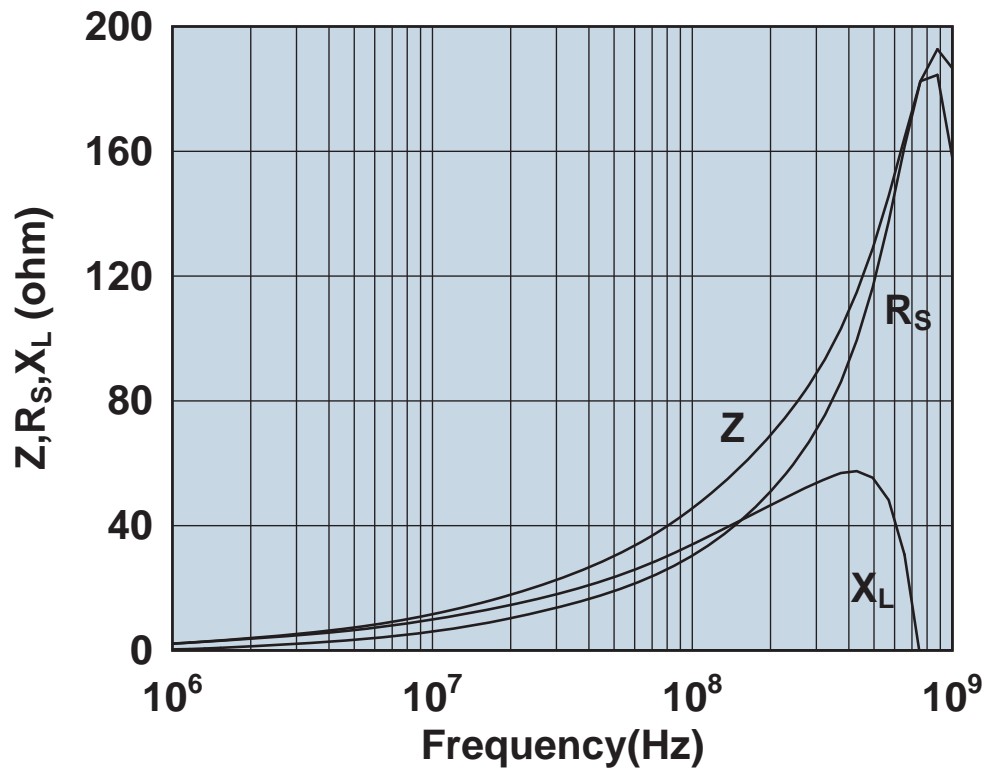

Impedance, reactance, and resistance vs. frequency.

2643200101

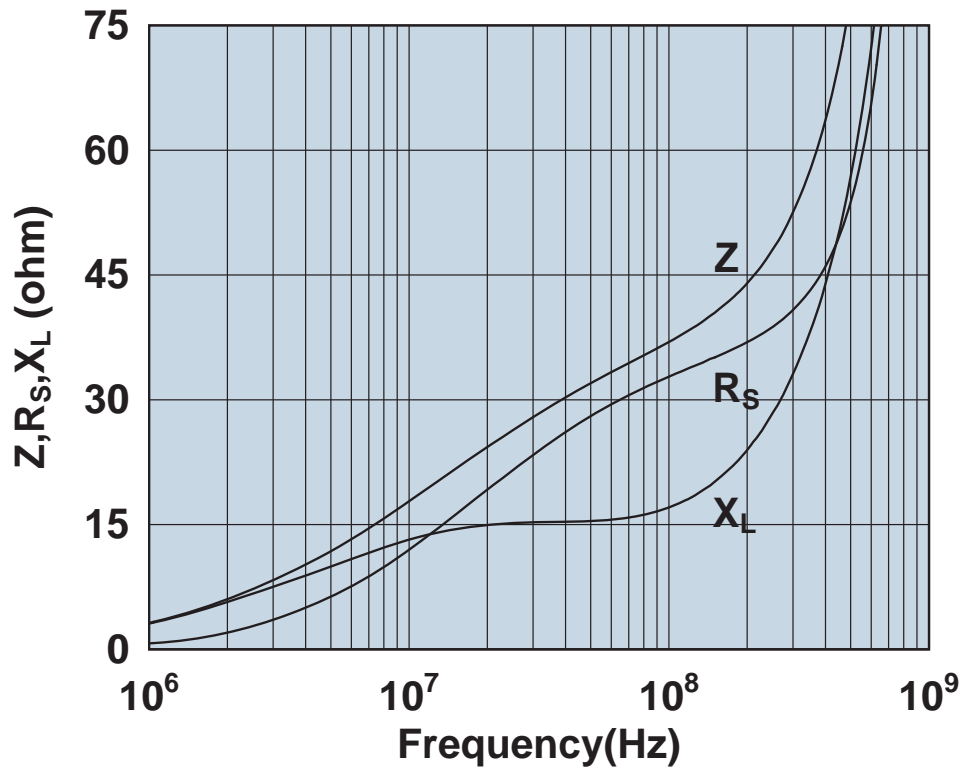

Impedance, reactance, and resistance vs. frequency.

2643250202

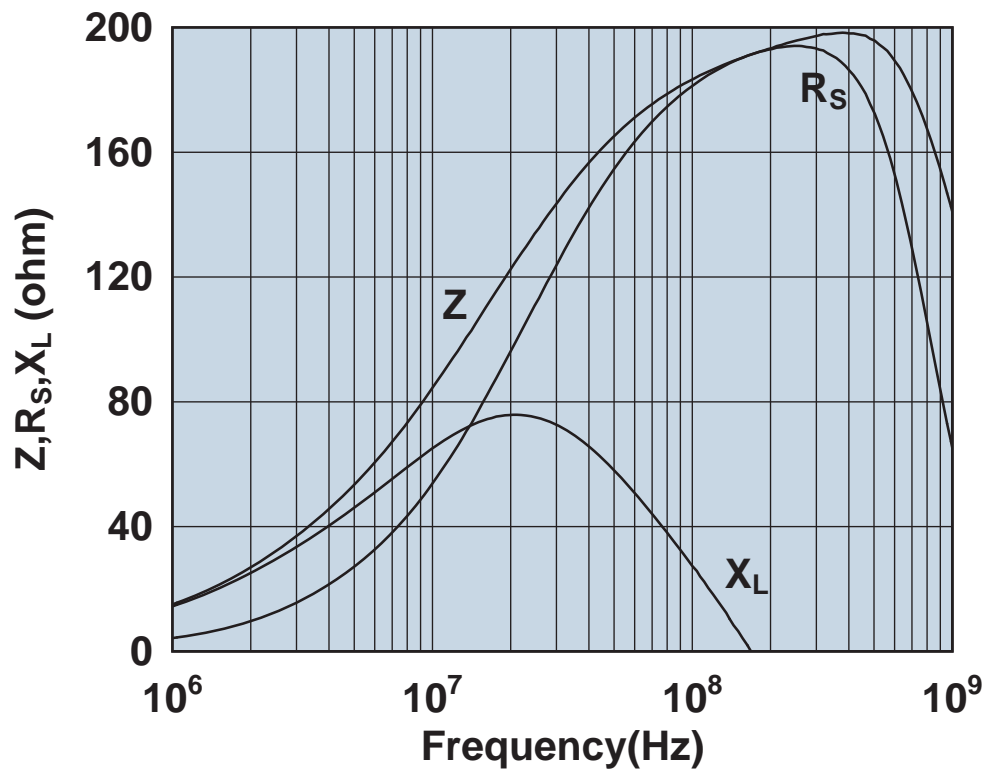

Impedance, reactance, and resistance vs. frequency.

2643250302

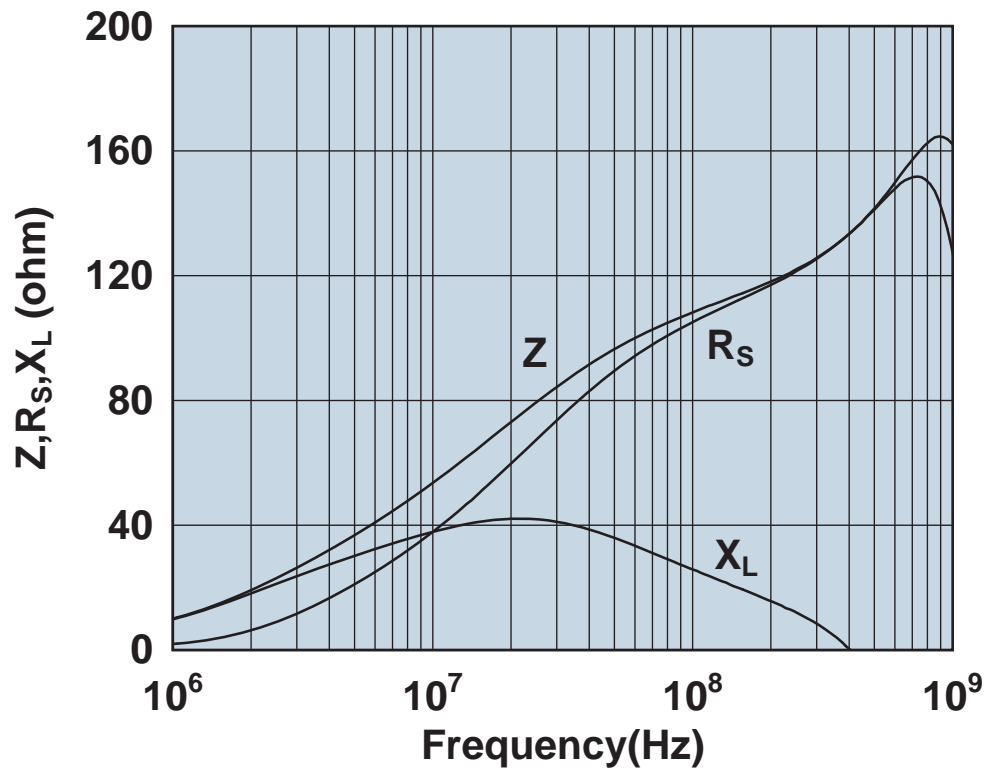

Impedance, reactance, and resistance vs. frequency.

2643250402

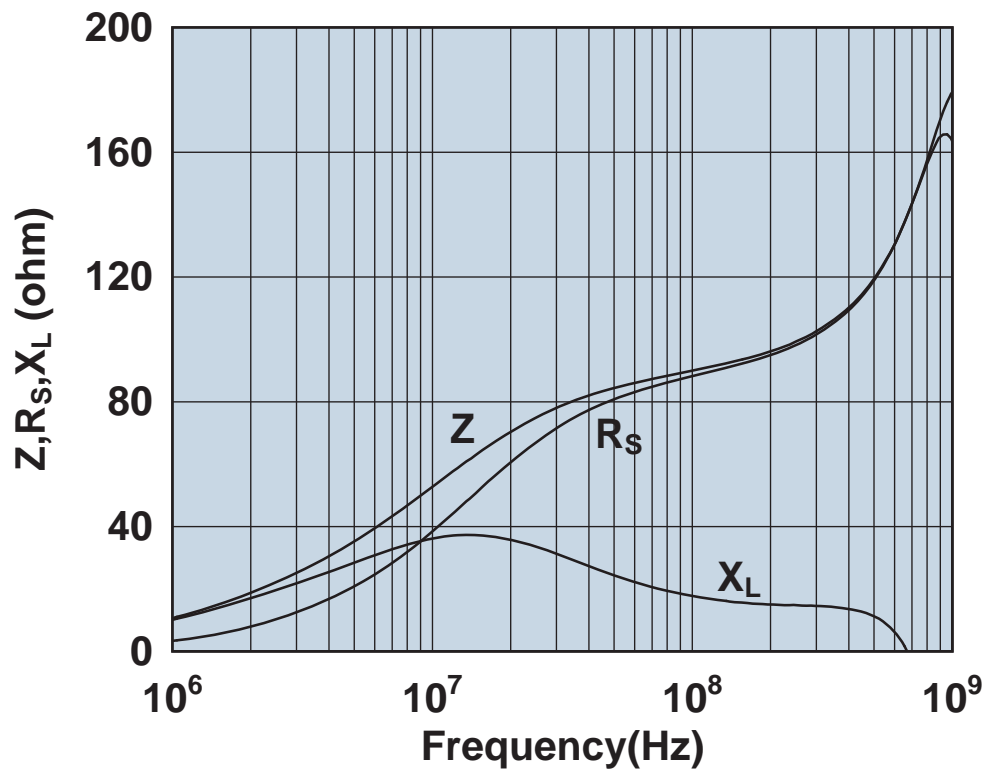

Impedance, reactance, and resistance vs. frequency.

2643251002

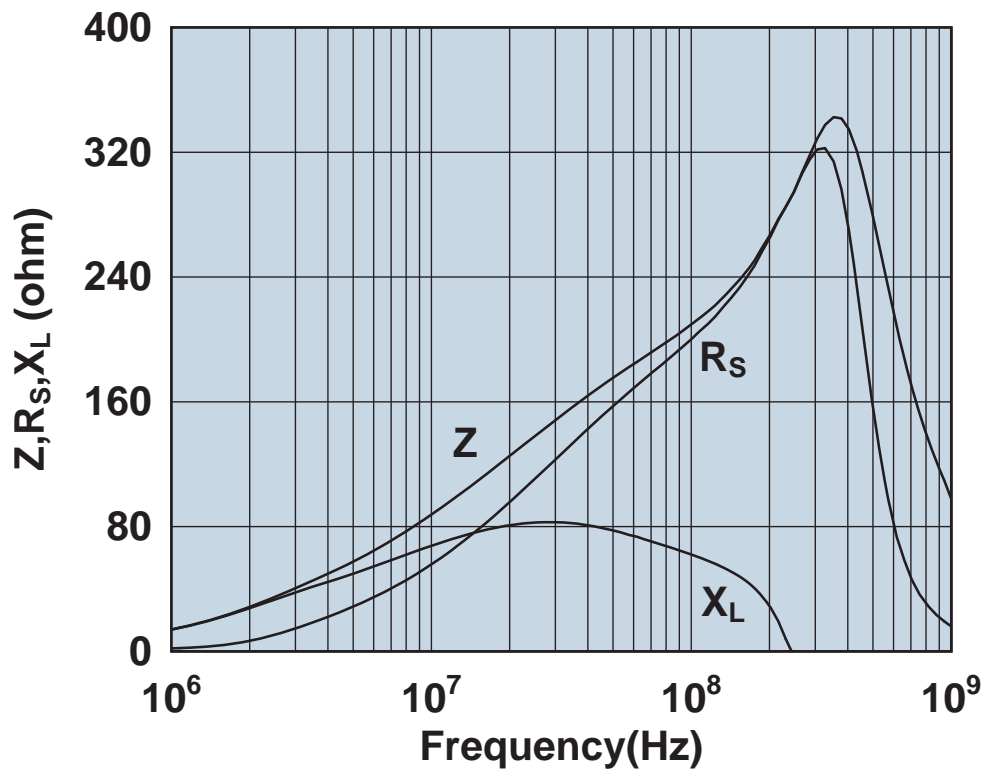

Impedance, reactance, and resistance vs. frequency.

2643300101

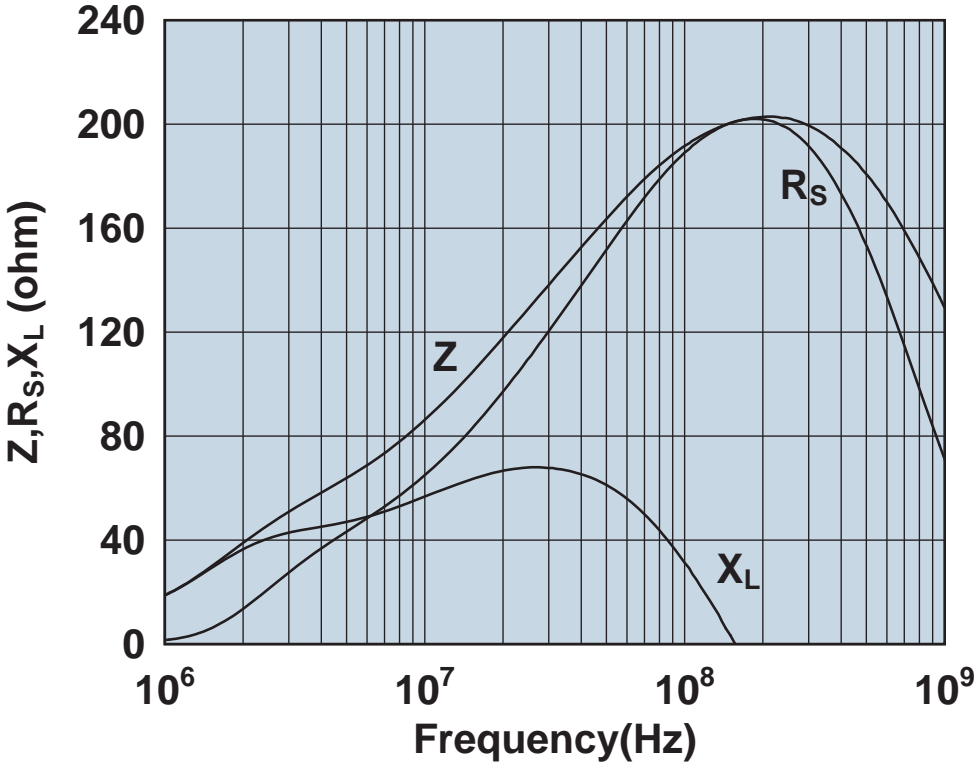

Impedance, reactance, and resistance vs. frequency.

2643375002

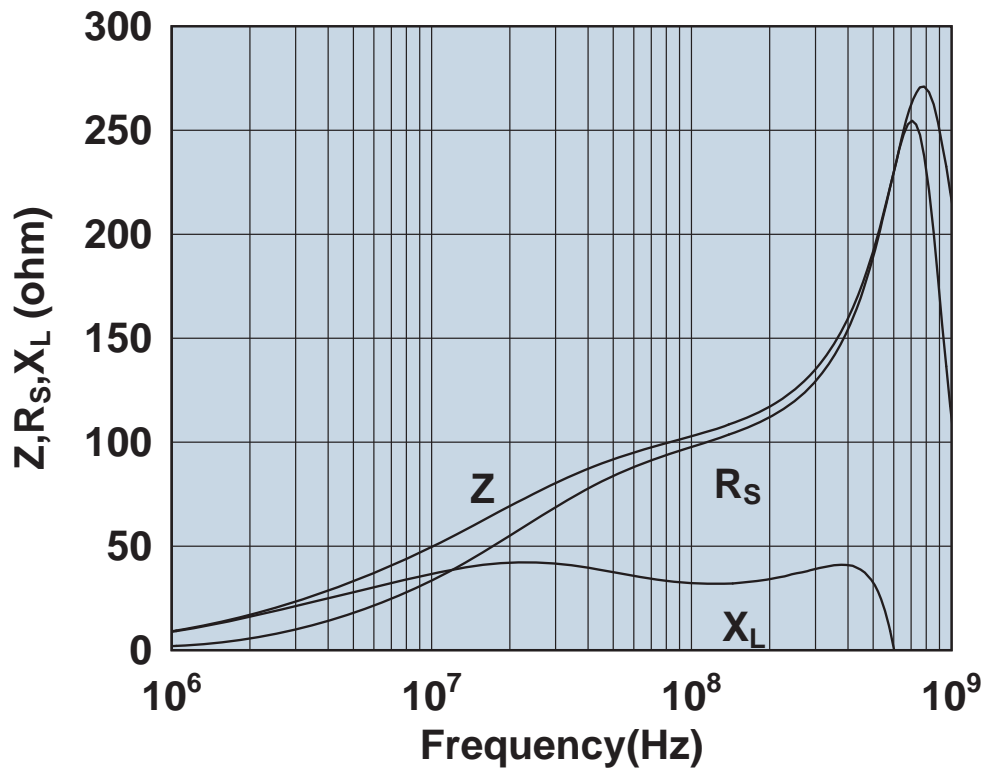

Impedance, reactance, and resistance vs. frequency.

2643375102

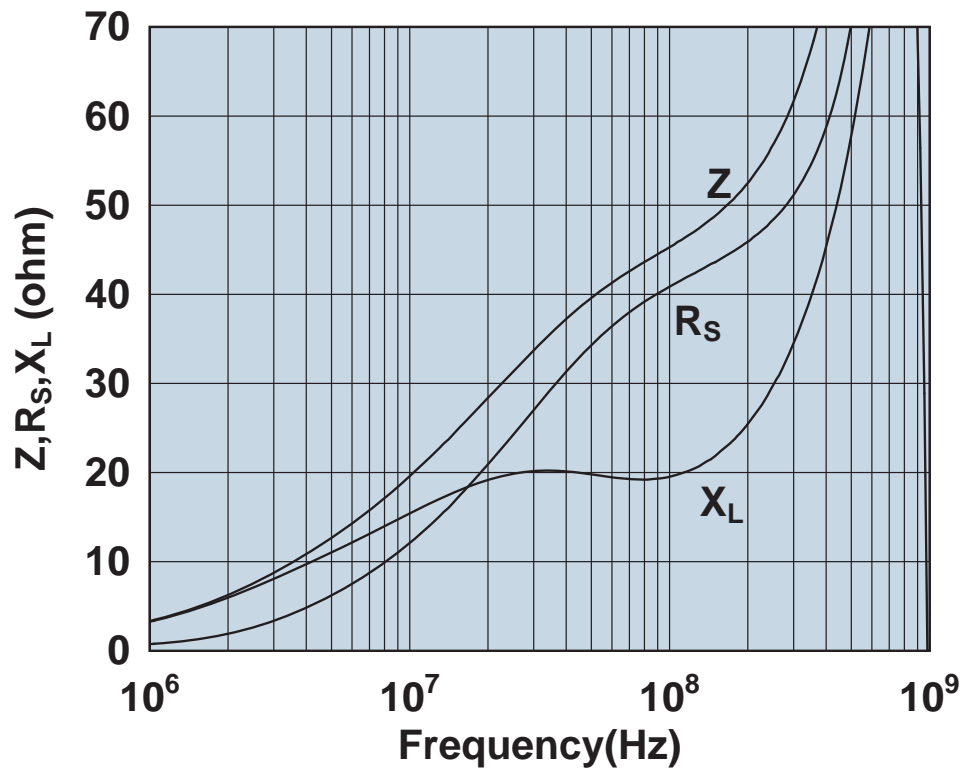

Impedance, reactance, and resistance vs. frequency.

2643480002

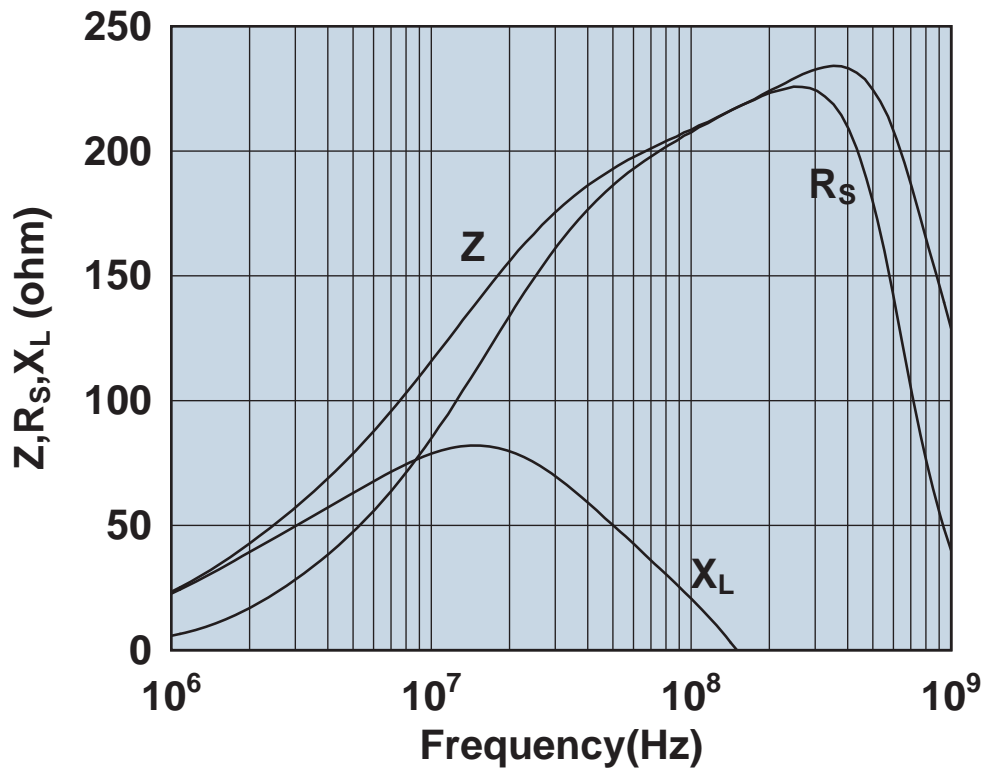

Impedance, reactance, and resistance vs. frequency.

2643480102

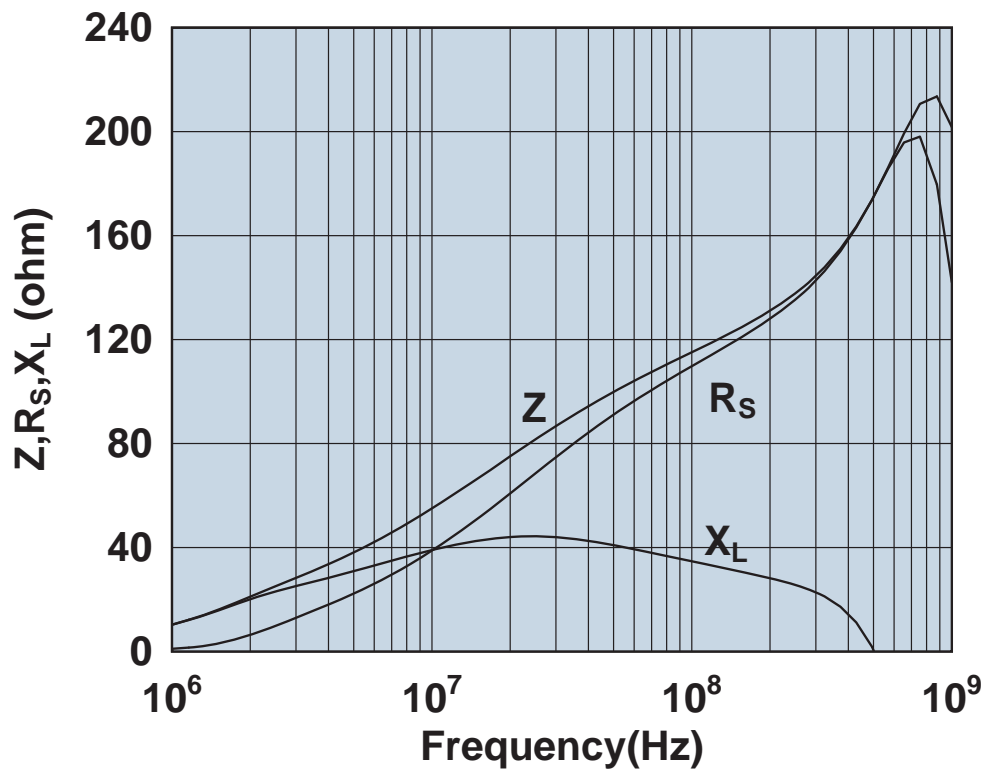

Impedance, reactance, and resistance vs. frequency.

2643540002

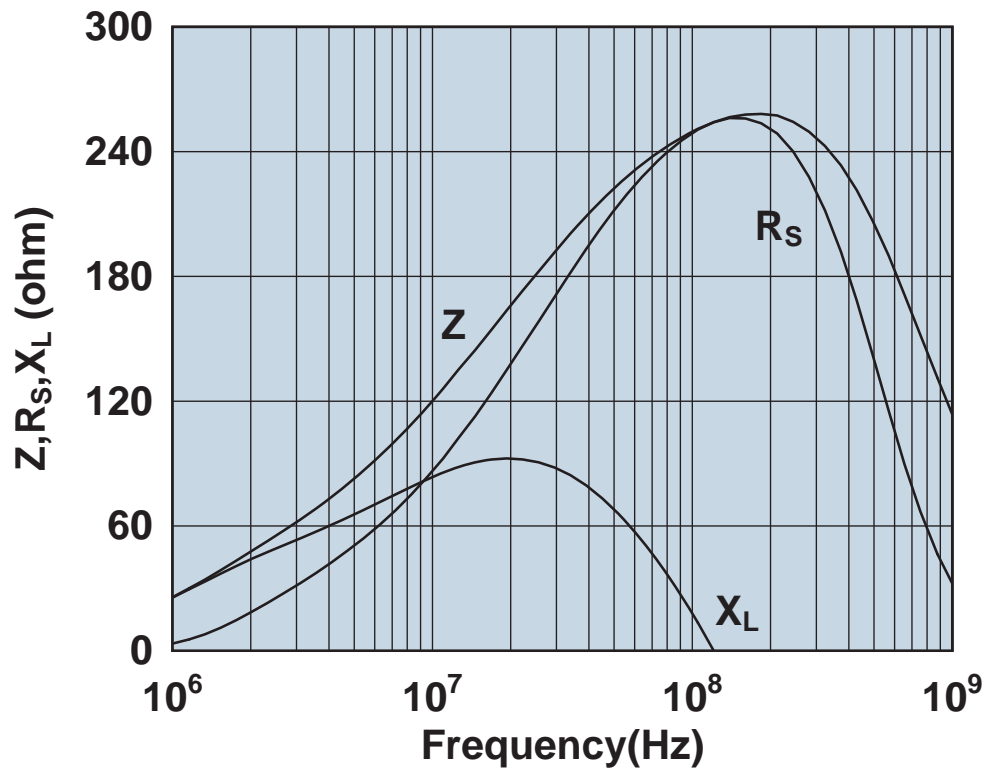

Impedance, reactance, and resistance vs. frequency.

2643540102

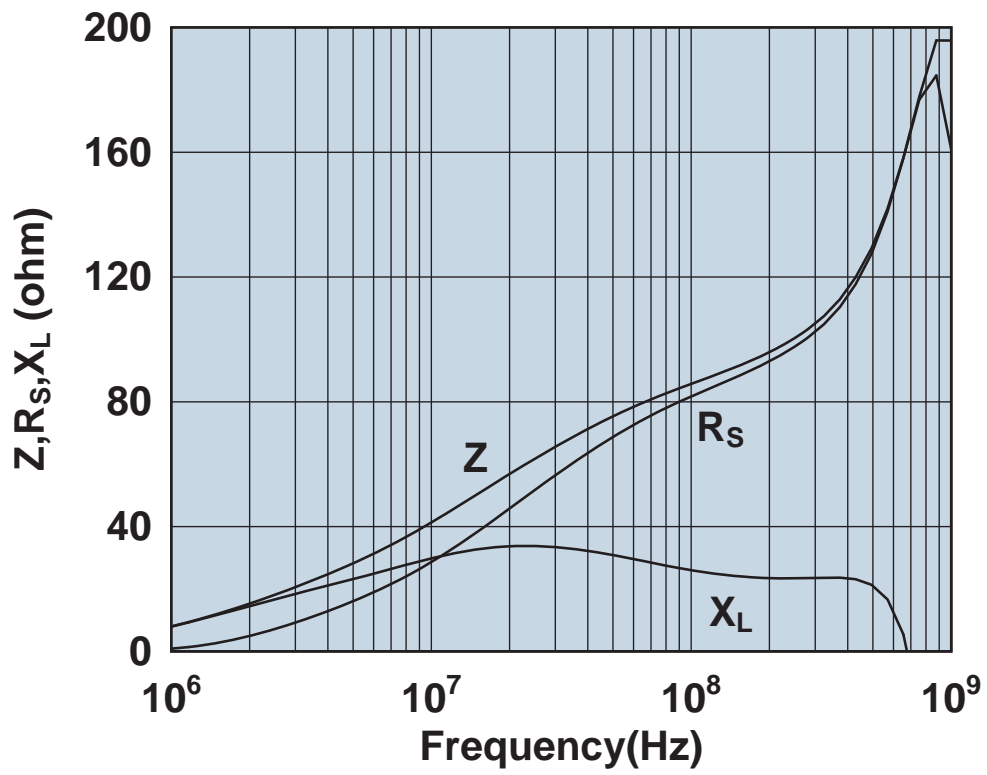

Impedance, reactance, and resistance vs. frequency.

2643540202

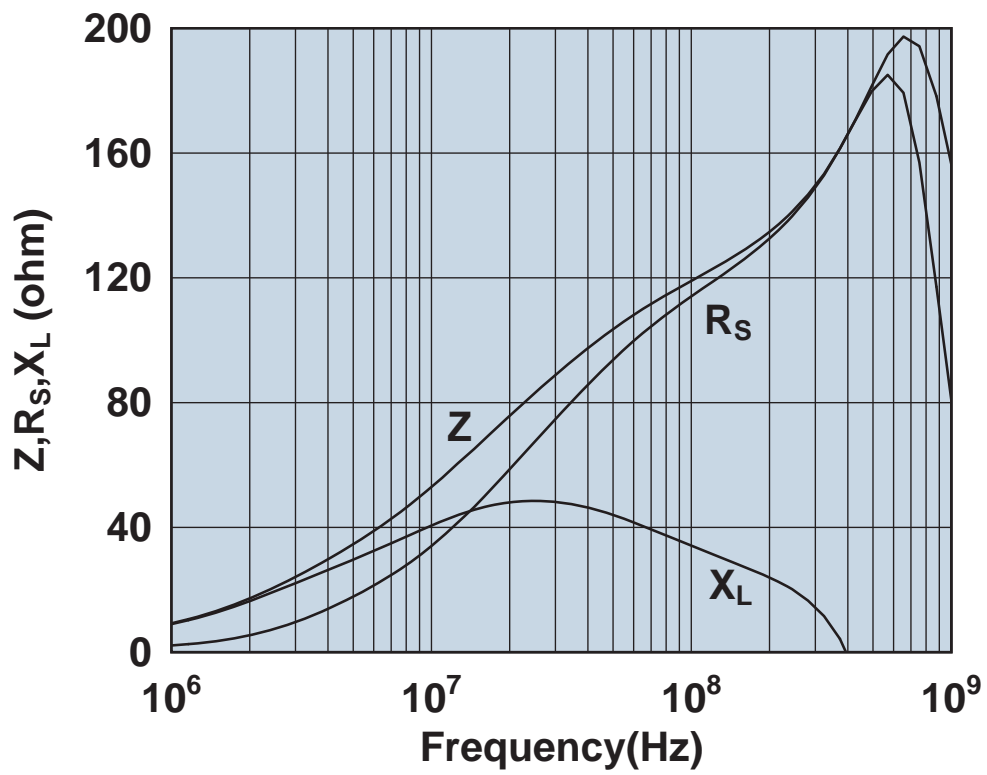

Impedance, reactance, and resistance vs. frequency.

2643540302

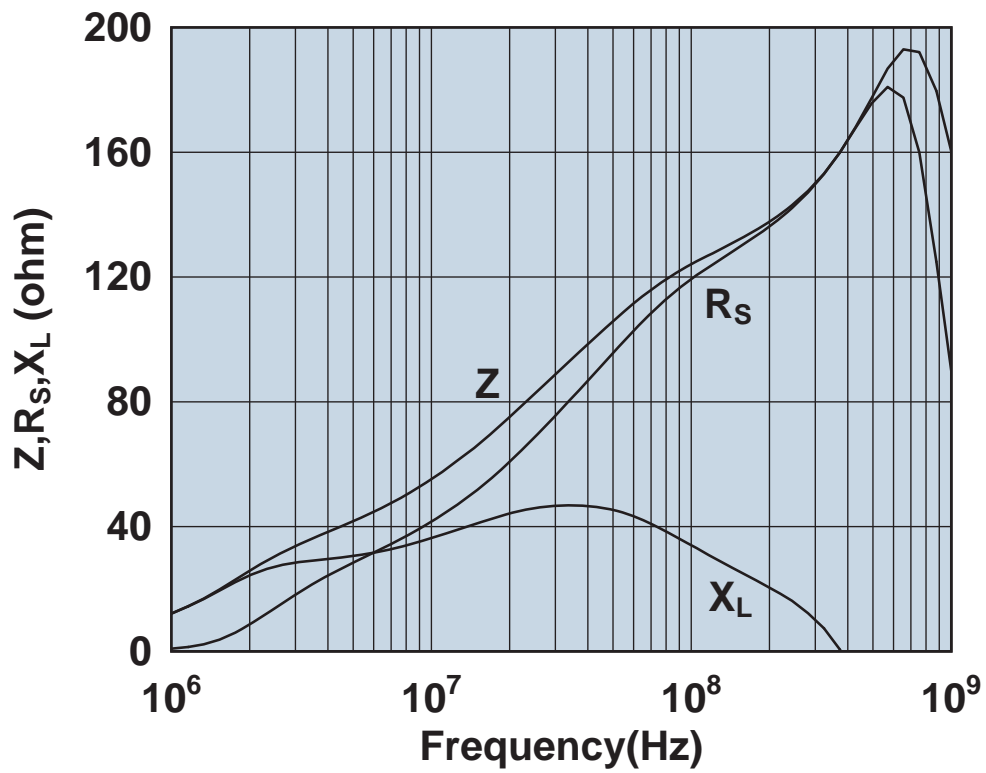

Impedance, reactance, and resistance vs. frequency.

2643540402

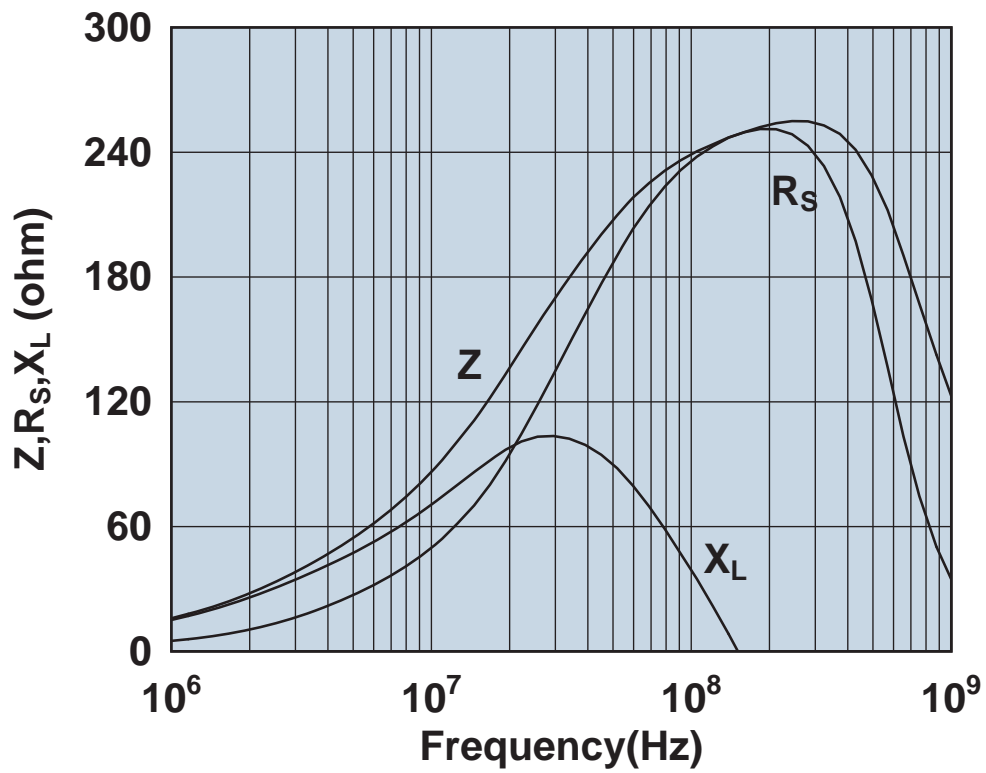

Impedance, reactance, and resistance vs. frequency.

2643540702

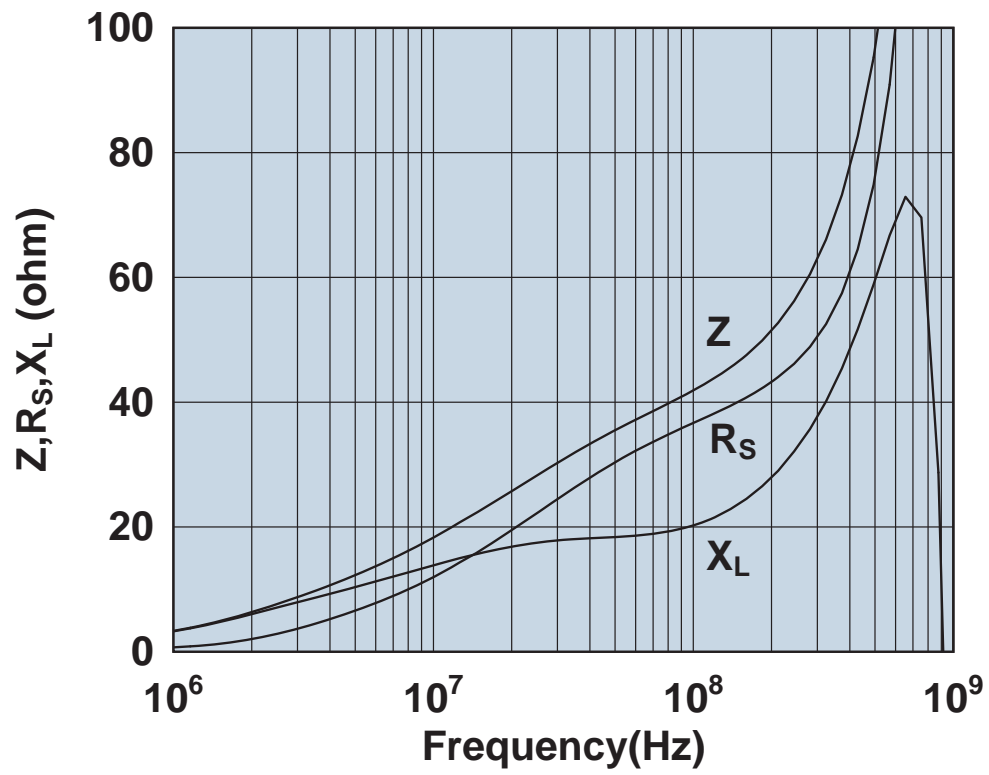

Impedance, reactance, and resistance vs. frequency.

2643625002

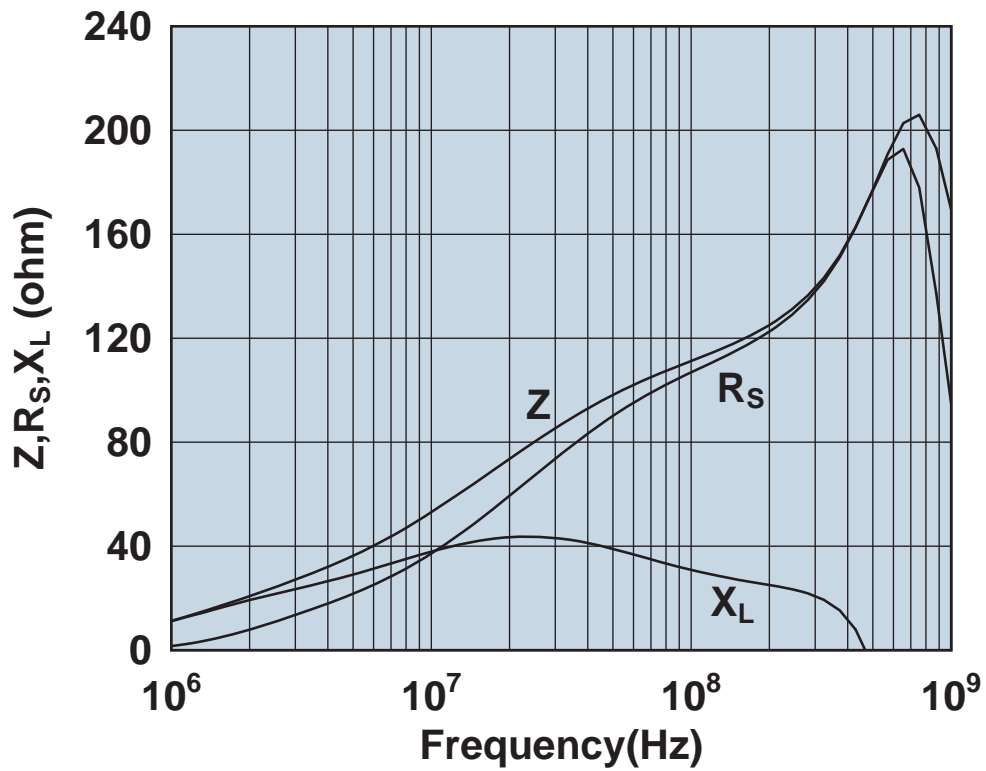

Impedance, reactance, and resistance vs. frequency.

2643625006

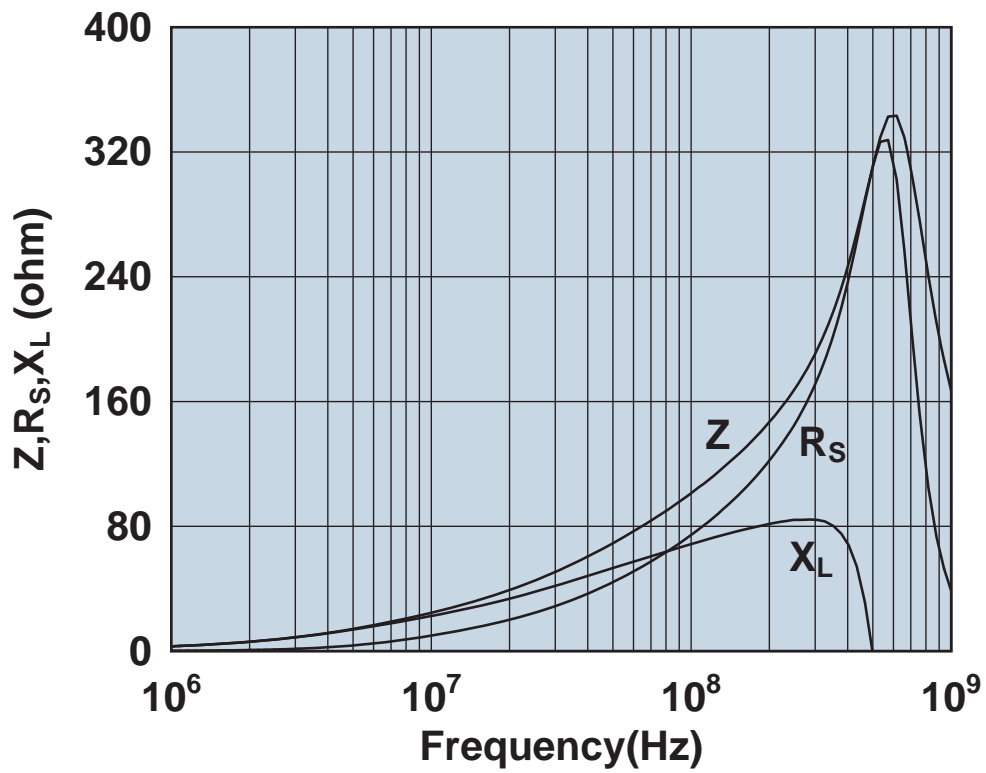

Impedance, reactance, and resistance vs. frequency.

2643625102

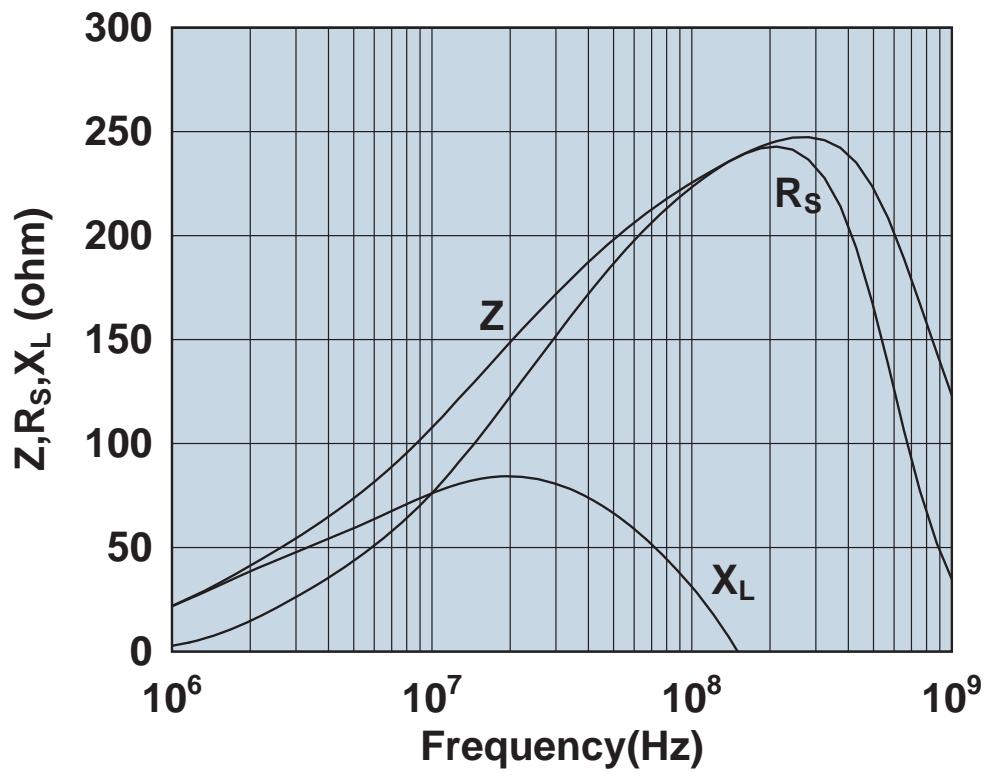

Impedance, reactance, and resistance vs. frequency.

2643625202

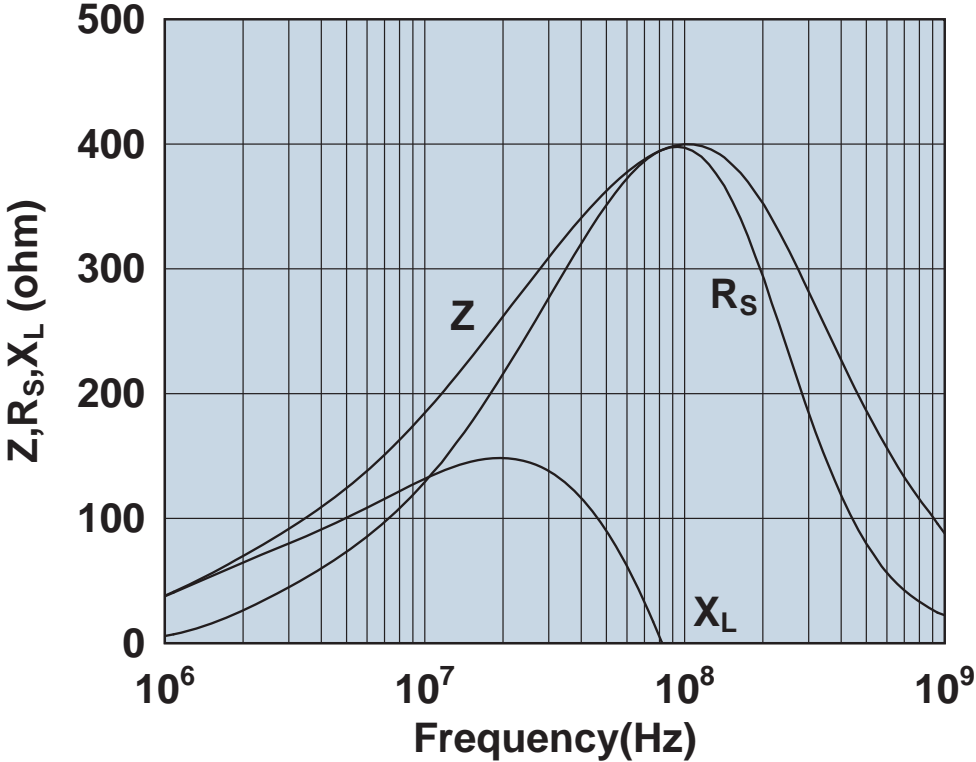

Impedance, reactance, and resistance vs. frequency.

2643625902

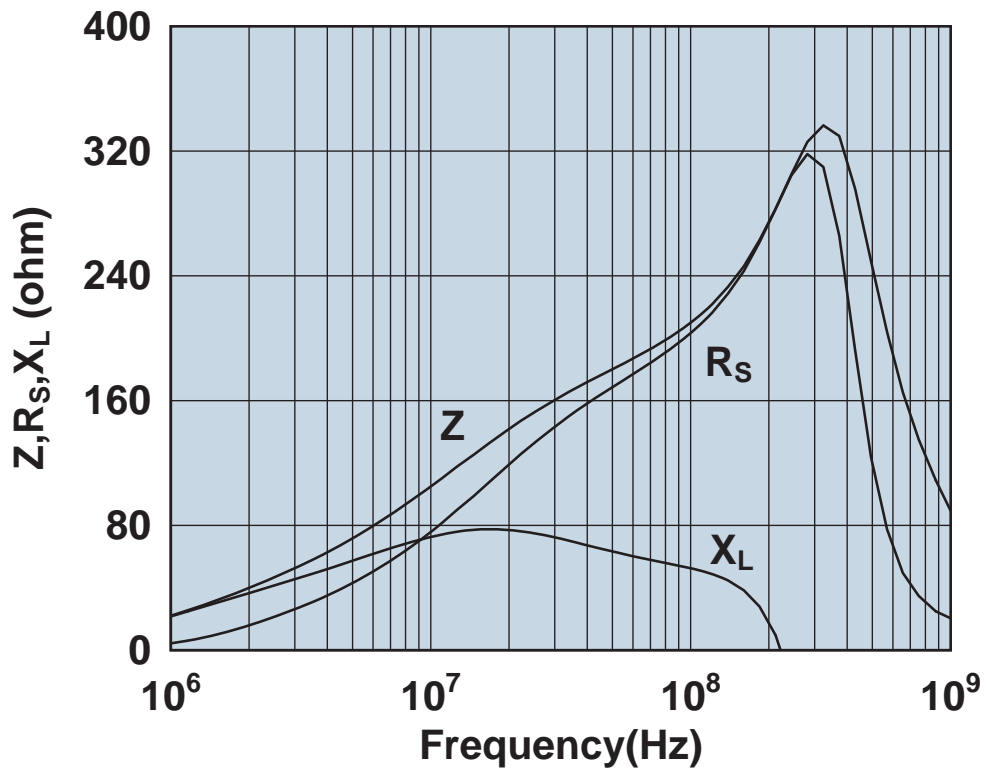

Impedance, reactance, and resistance vs. frequency.

2643626002

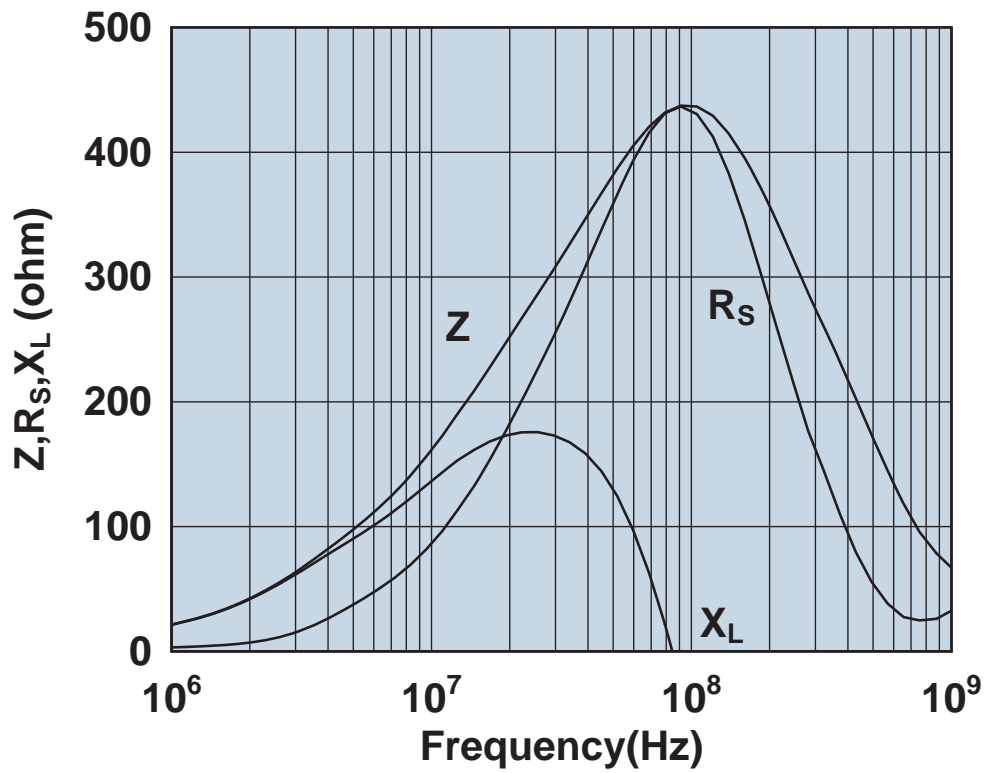

Impedance, reactance, and resistance vs. frequency.

2643626102

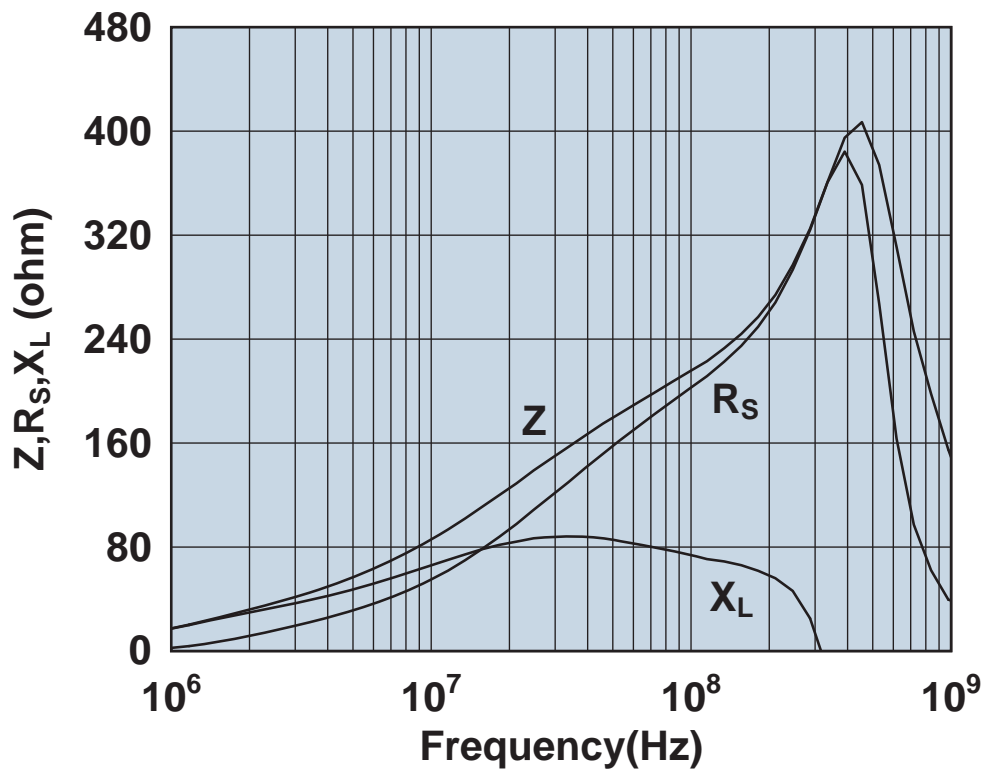

Impedance, reactance, and resistance vs. frequency.

2643626202

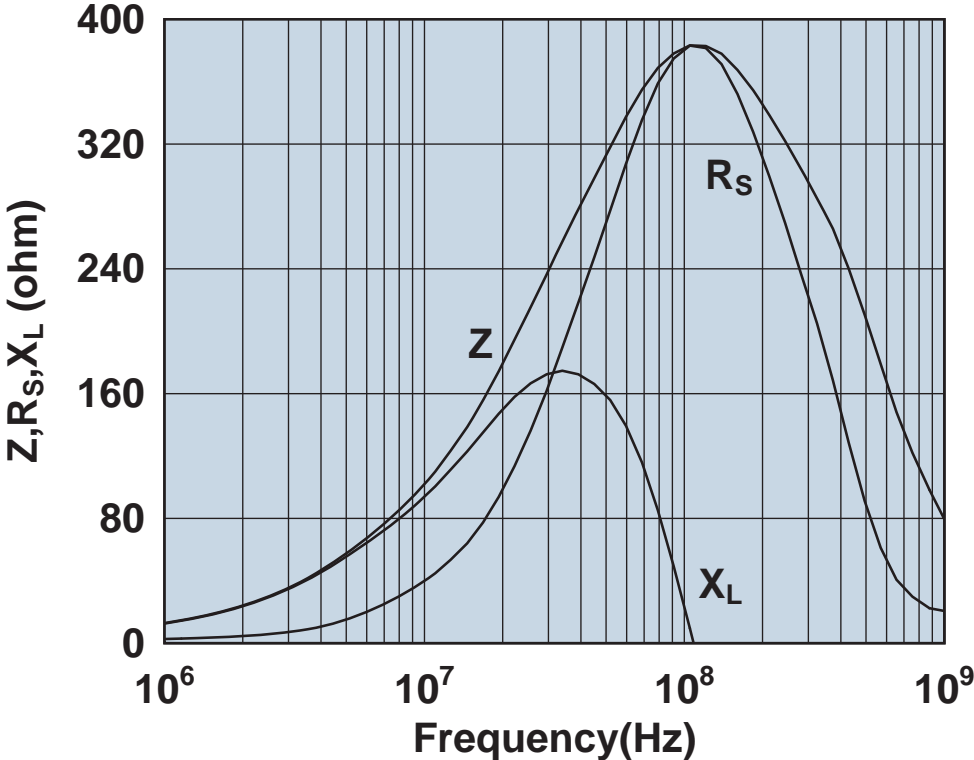

Impedance, reactance, and resistance vs. frequency.

2643626302

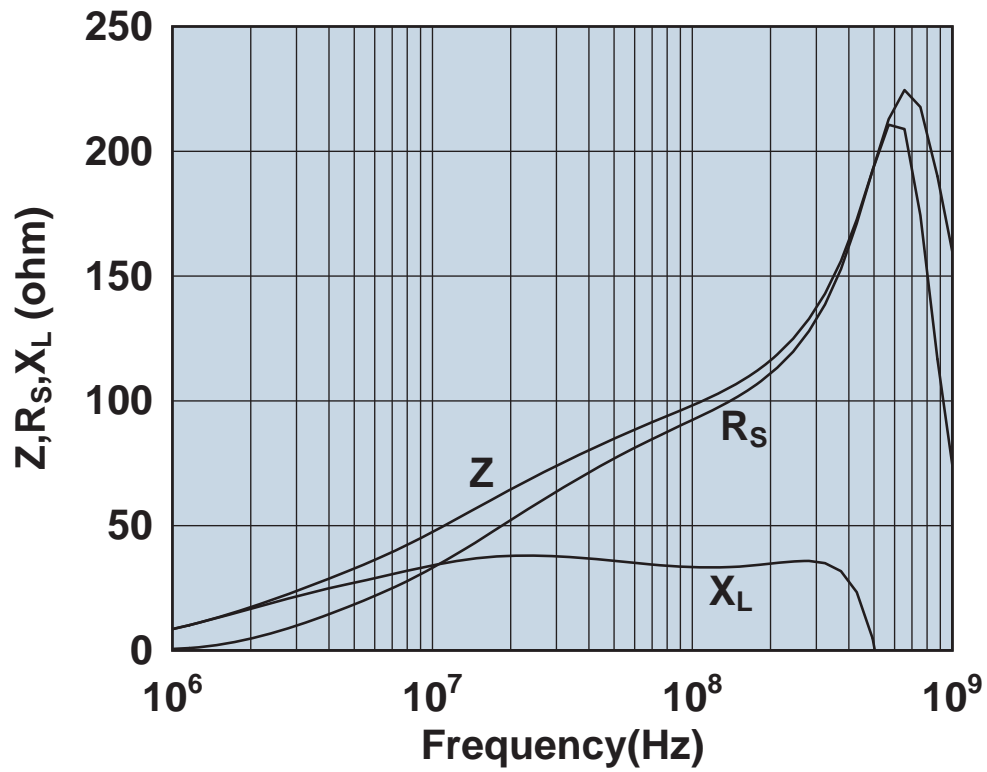

Impedance, reactance, and resistance vs. frequency.

2643626402

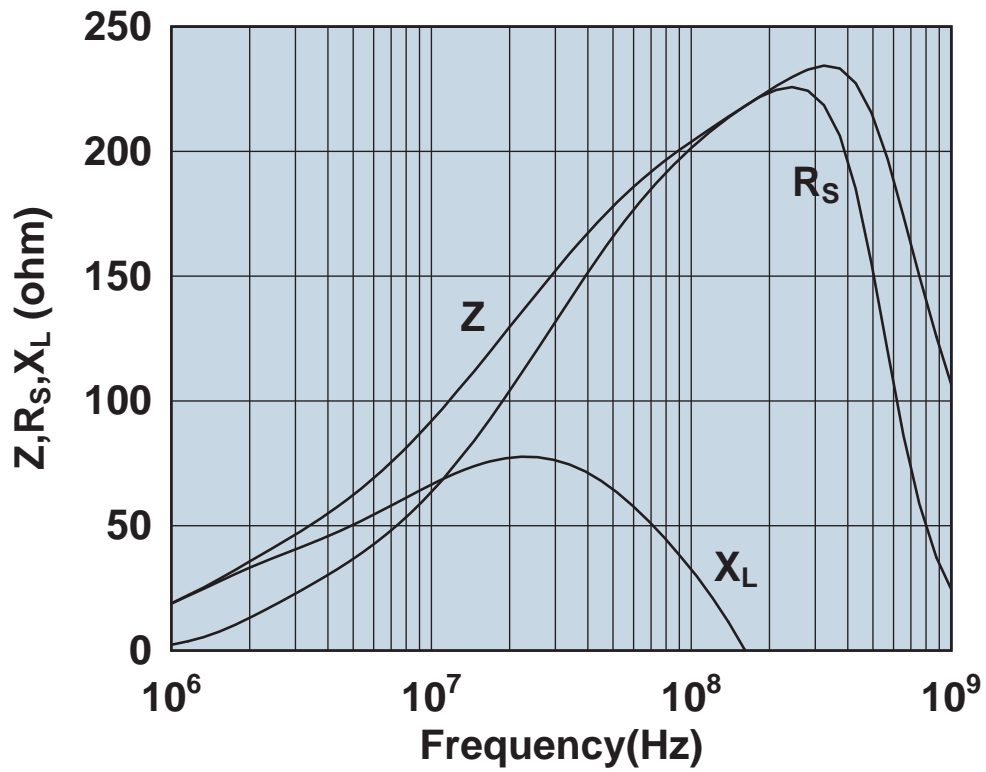

Impedance, reactance, and resistance vs. frequency.

2643626502

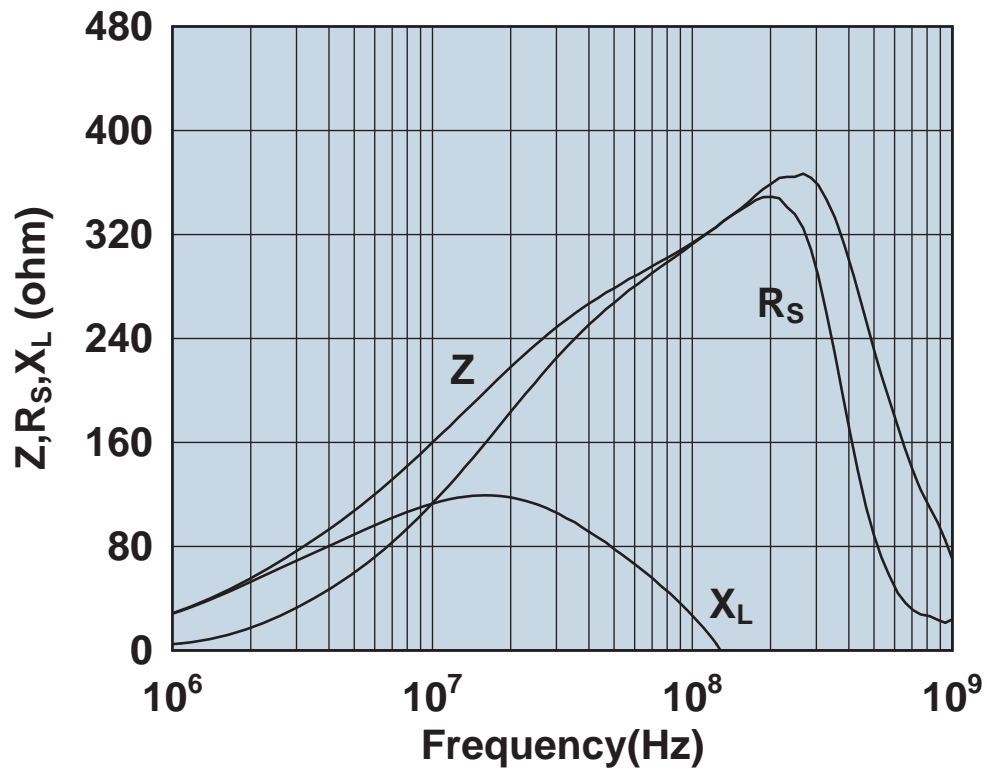

Impedance, reactance, and resistance vs. frequency.

2643665702

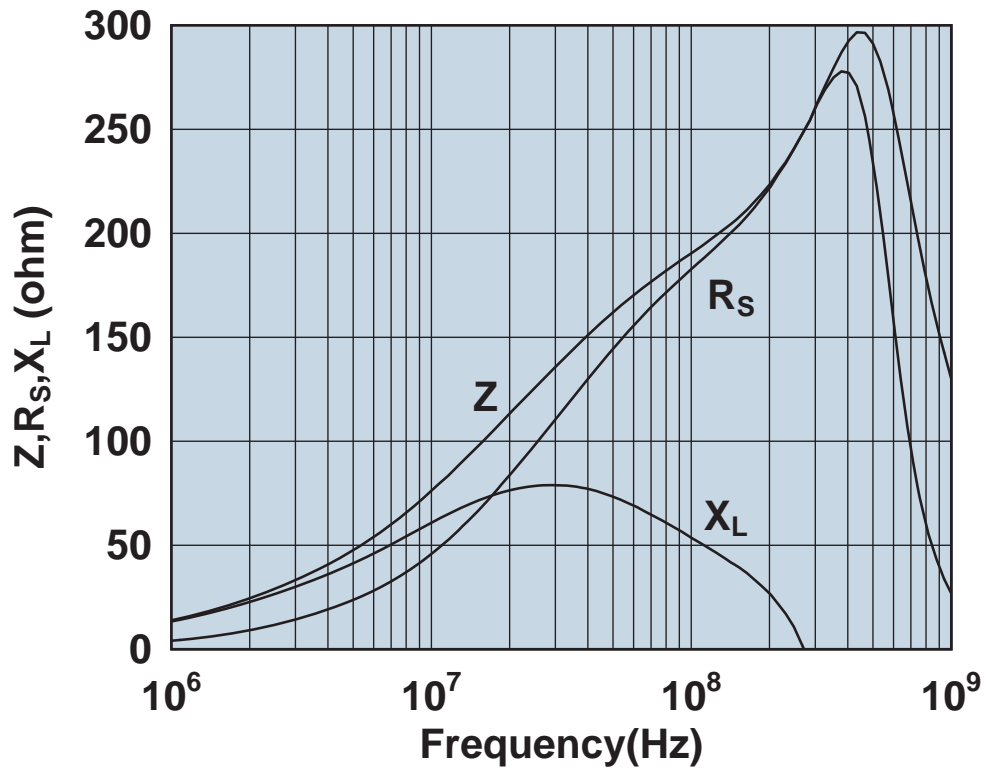

Impedance, reactance, and resistance vs. frequency.

2643665802

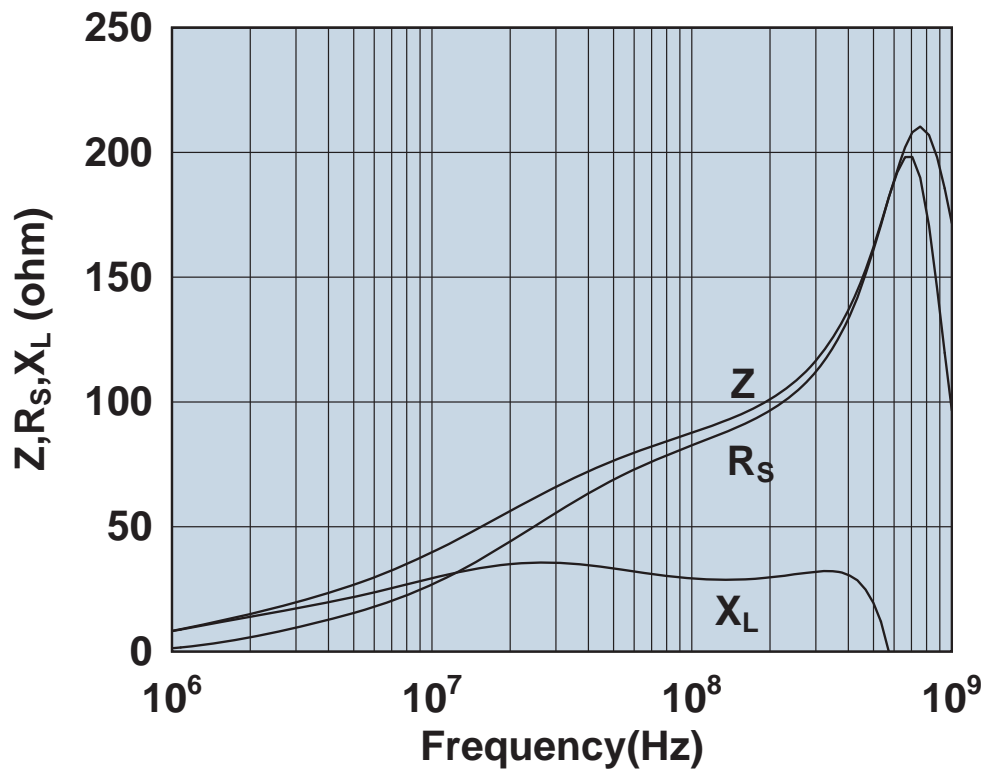

Impedance, reactance, and resistance vs. frequency.

2643665806

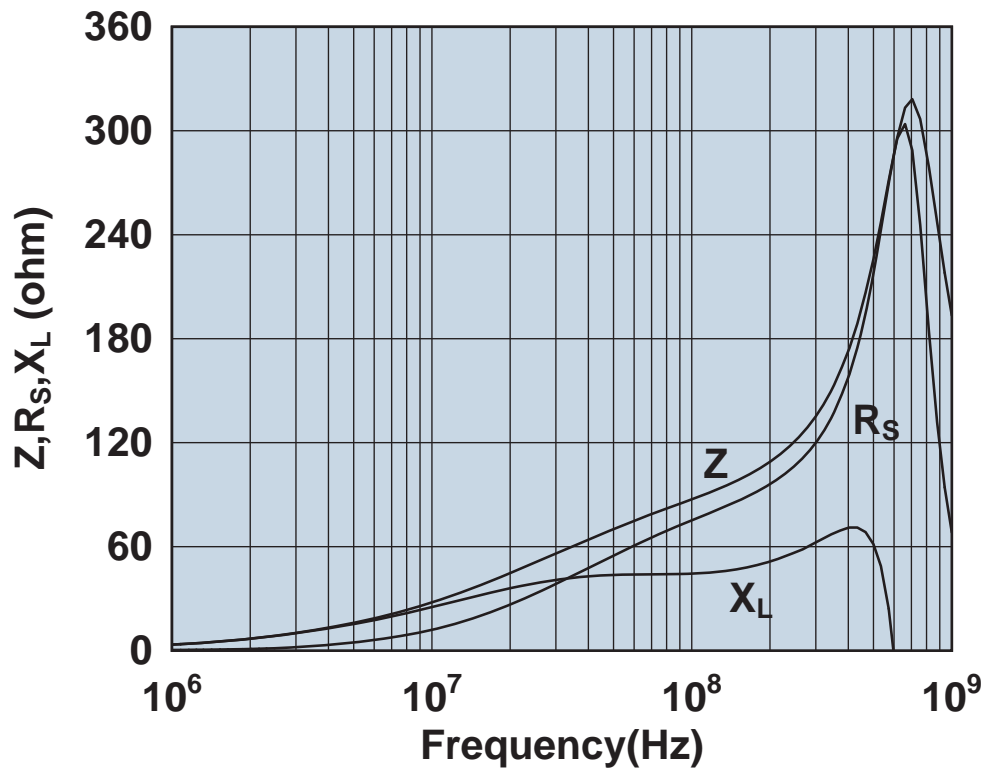

Impedance, reactance, and resistance vs. frequency.

2643665902

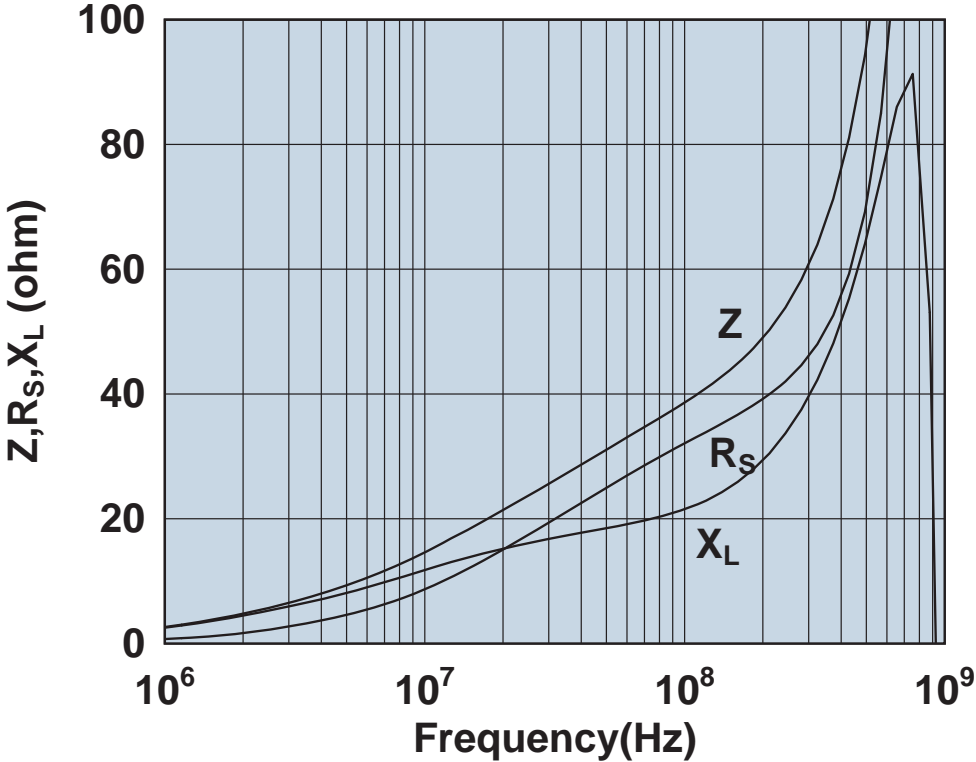

Impedance, reactance, and resistance vs. frequency.

2643706001

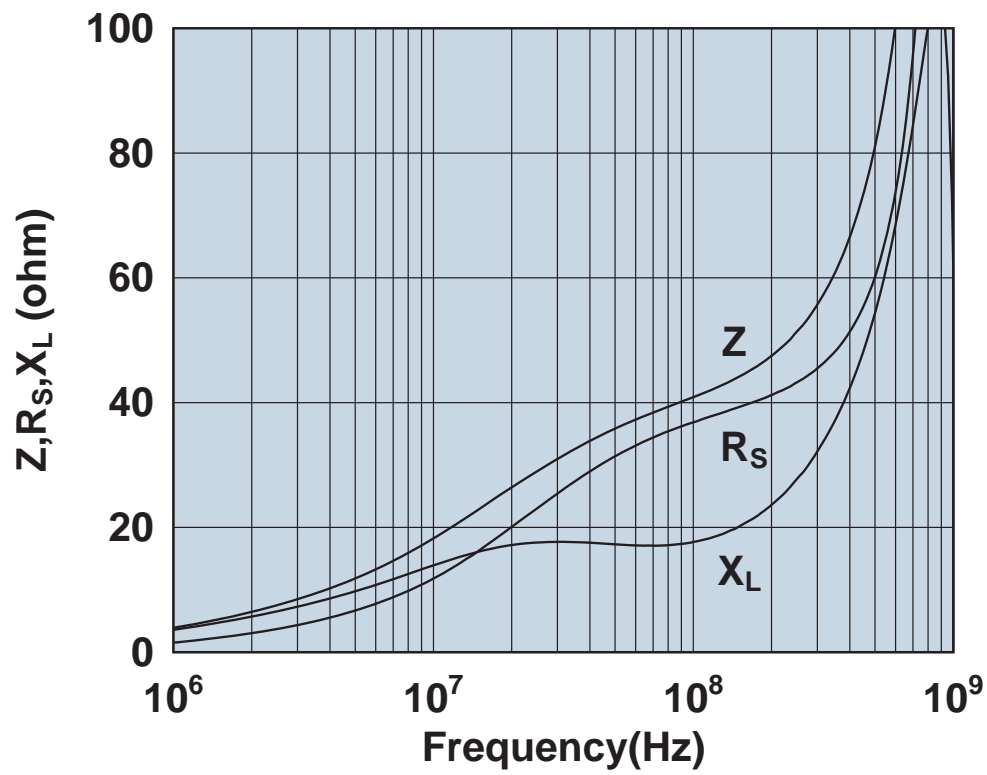

Impedance, reactance, and resistance vs. frequency.

2643800302

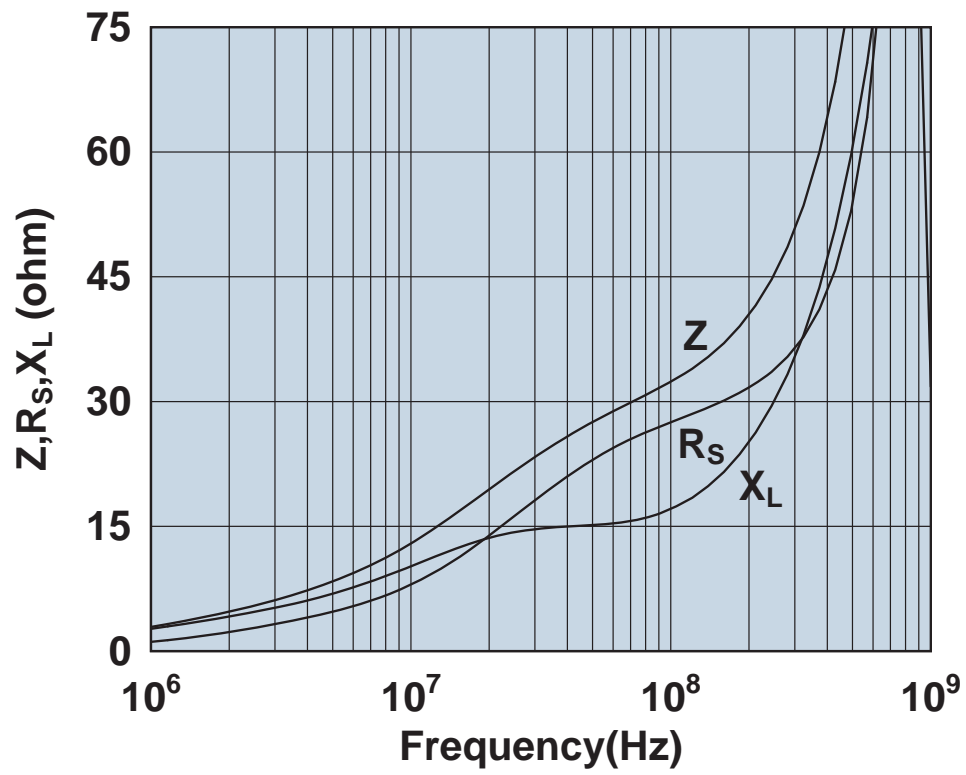

Impedance, reactance, and resistance vs. frequency.

2643800502

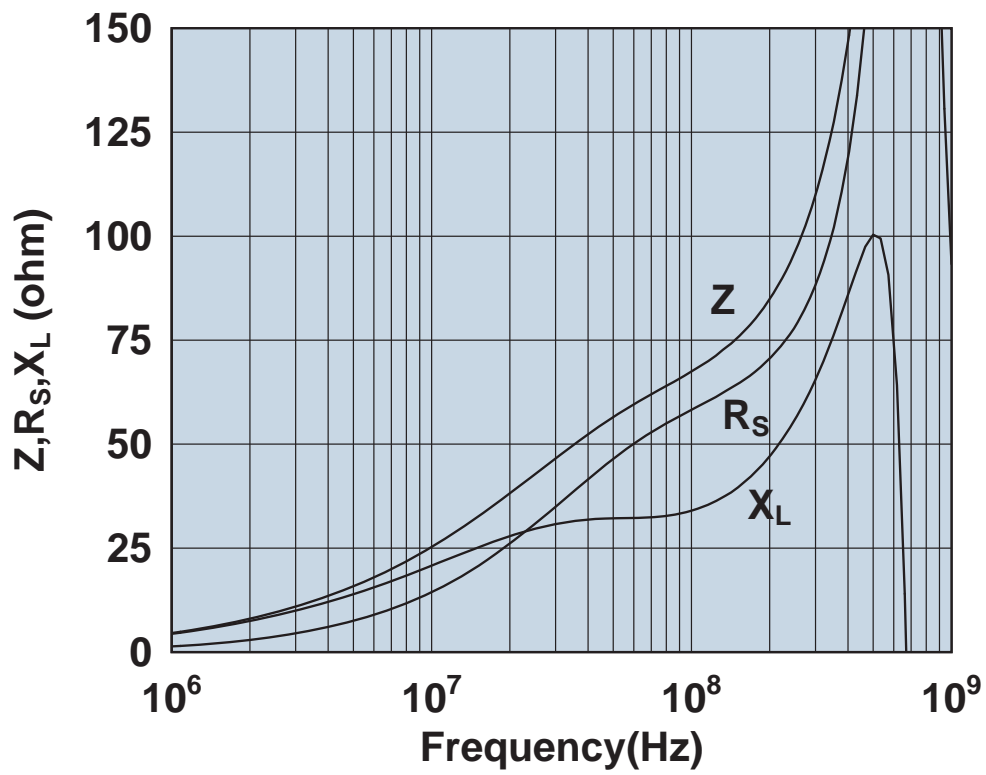

Impedance, reactance, and resistance vs. frequency.

2643800506

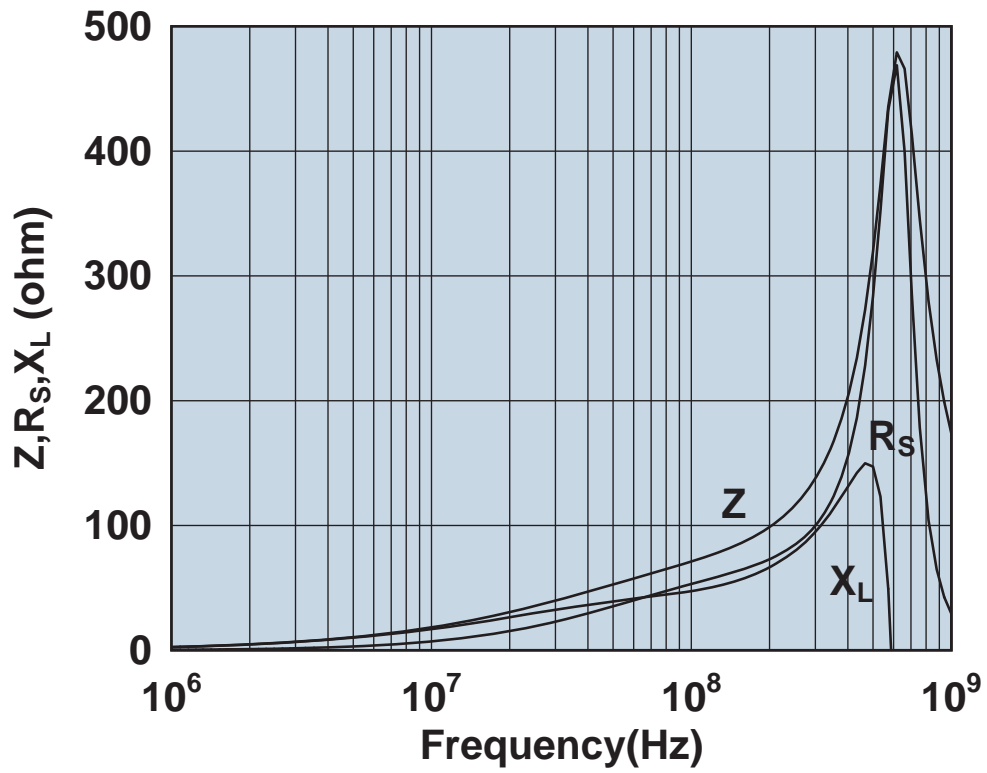

Impedance, reactance, and resistance vs. frequency.

2643800602

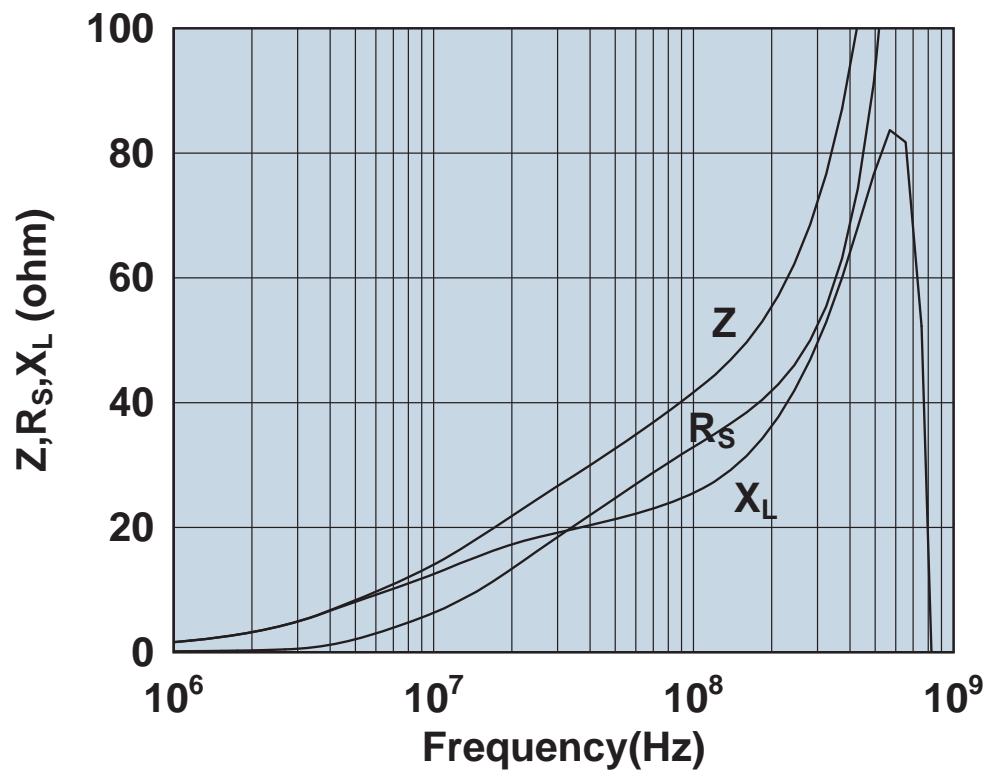

Impedance, reactance, and resistance vs. frequency.

2643801002

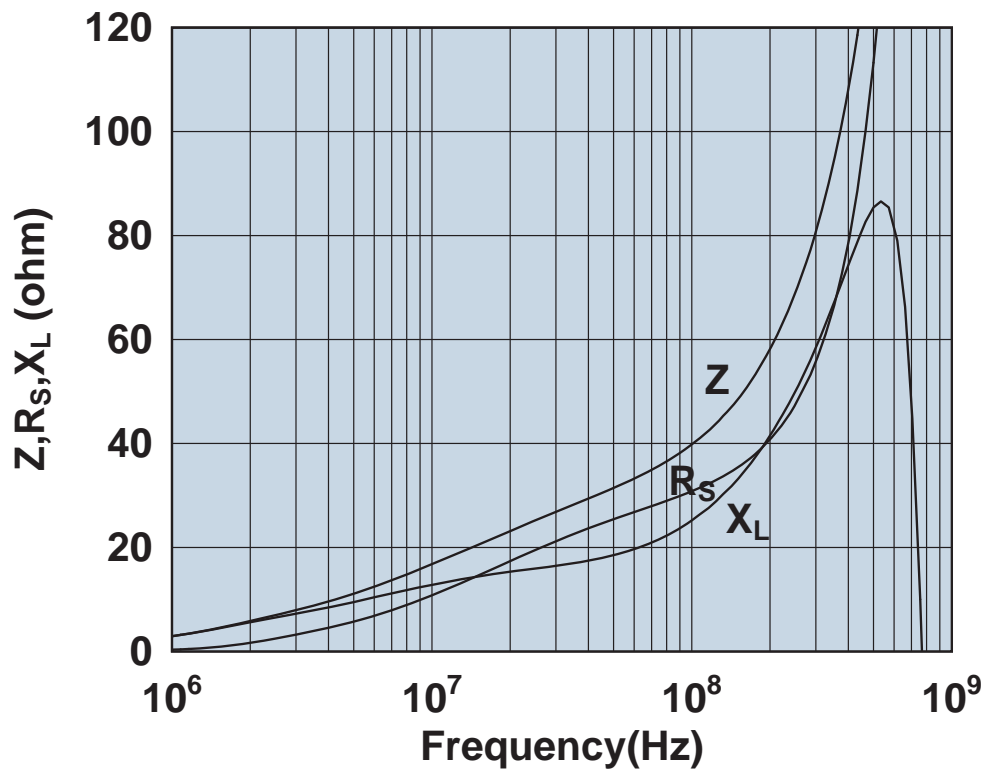

Impedance, reactance, and resistance vs. frequency.

2643801102

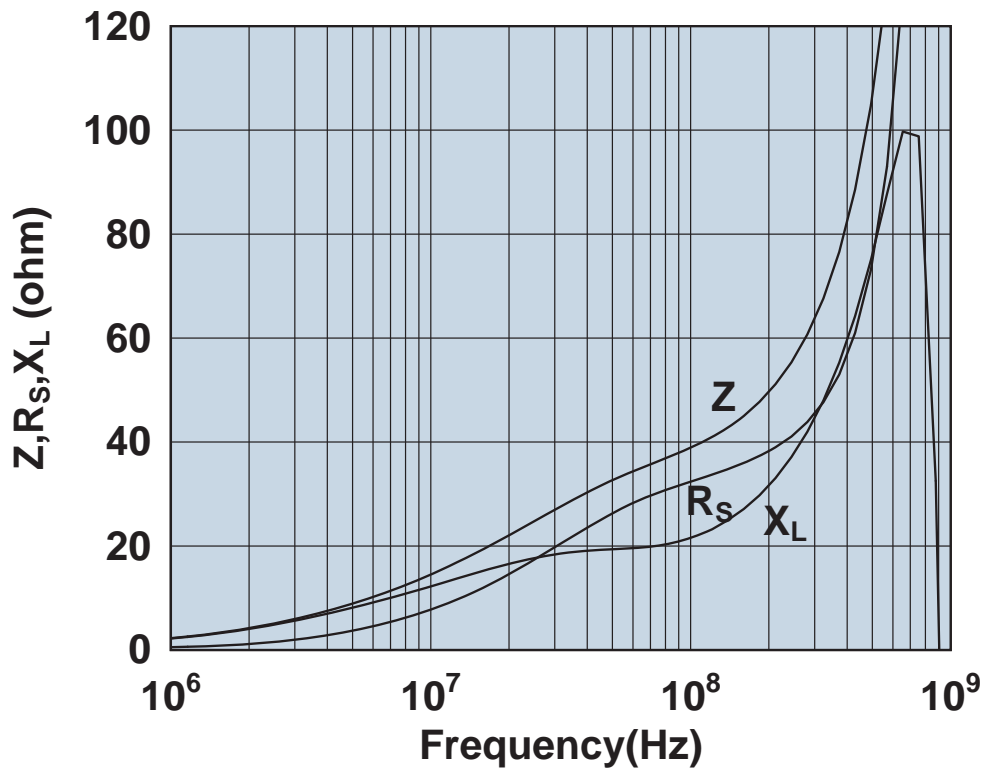

Impedance, reactance, and resistance vs. frequency.

2643801202

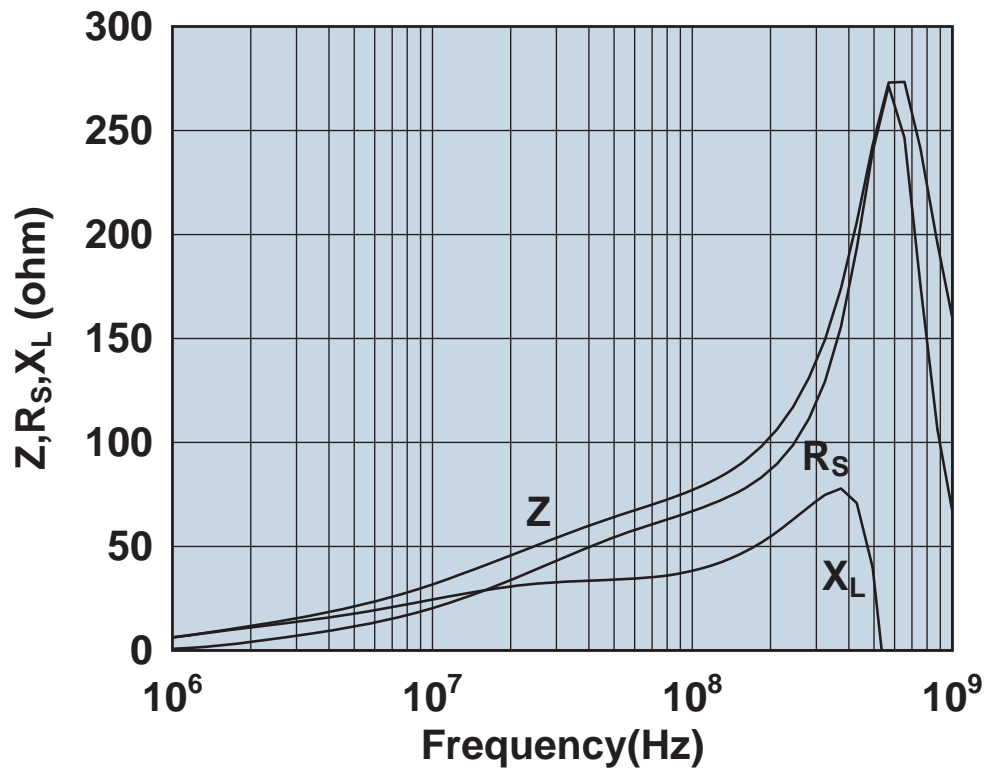

Impedance, reactance, and resistance vs. frequency.

2643801402

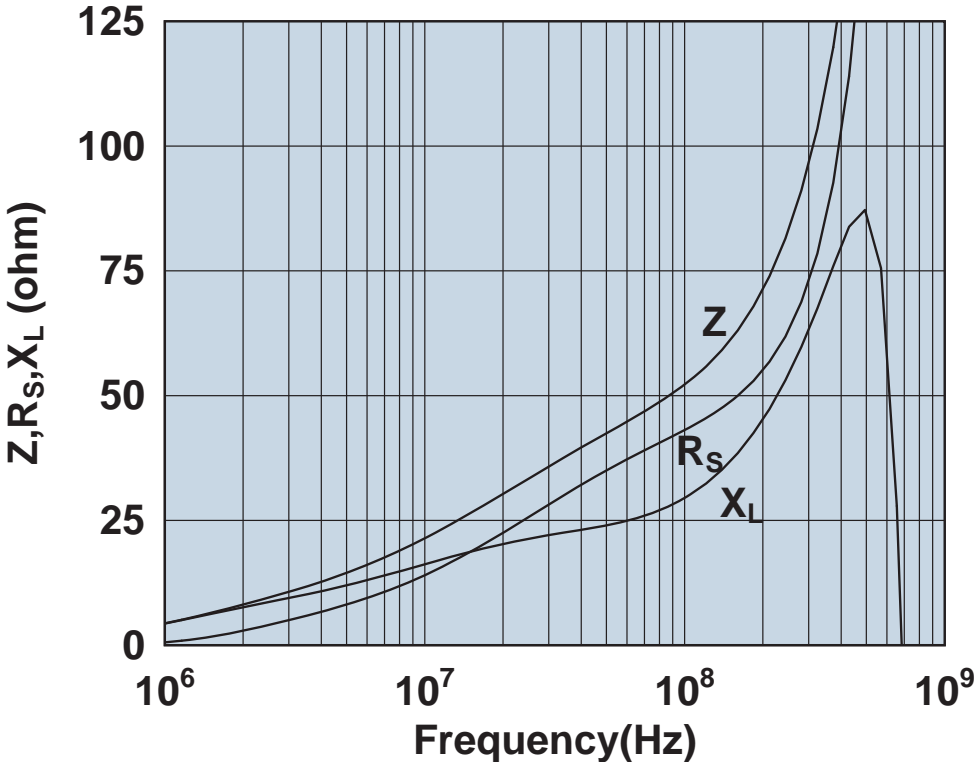

Impedance, reactance, and resistance vs. frequency.

2643801502

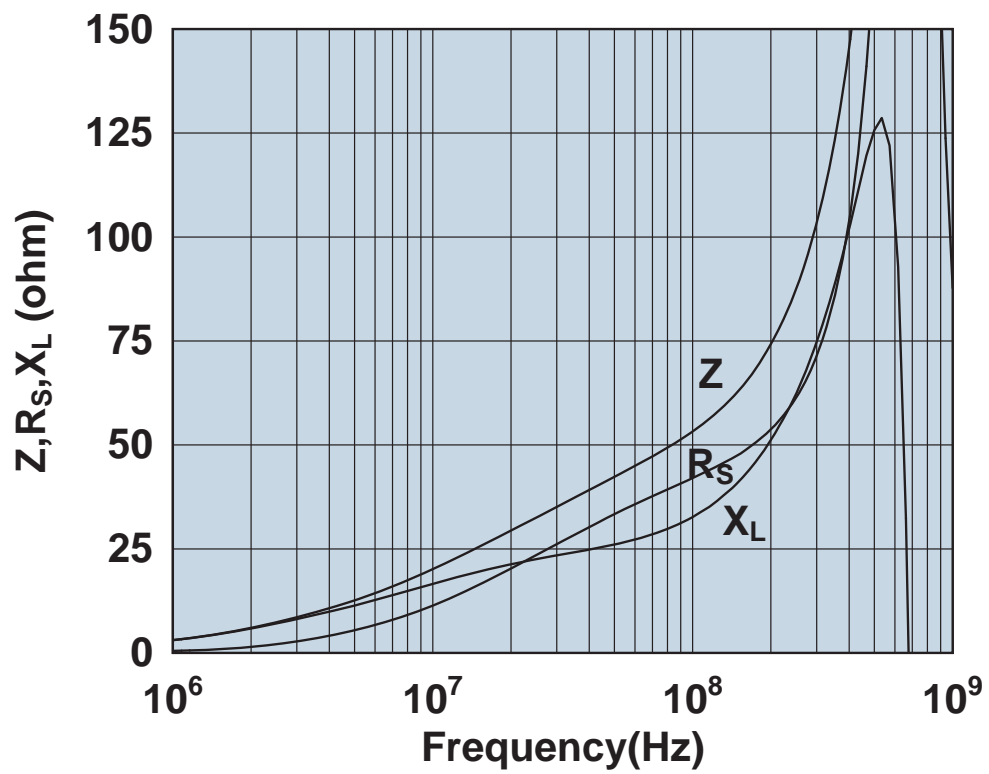

Impedance, reactance, and resistance vs. frequency.

2643801802

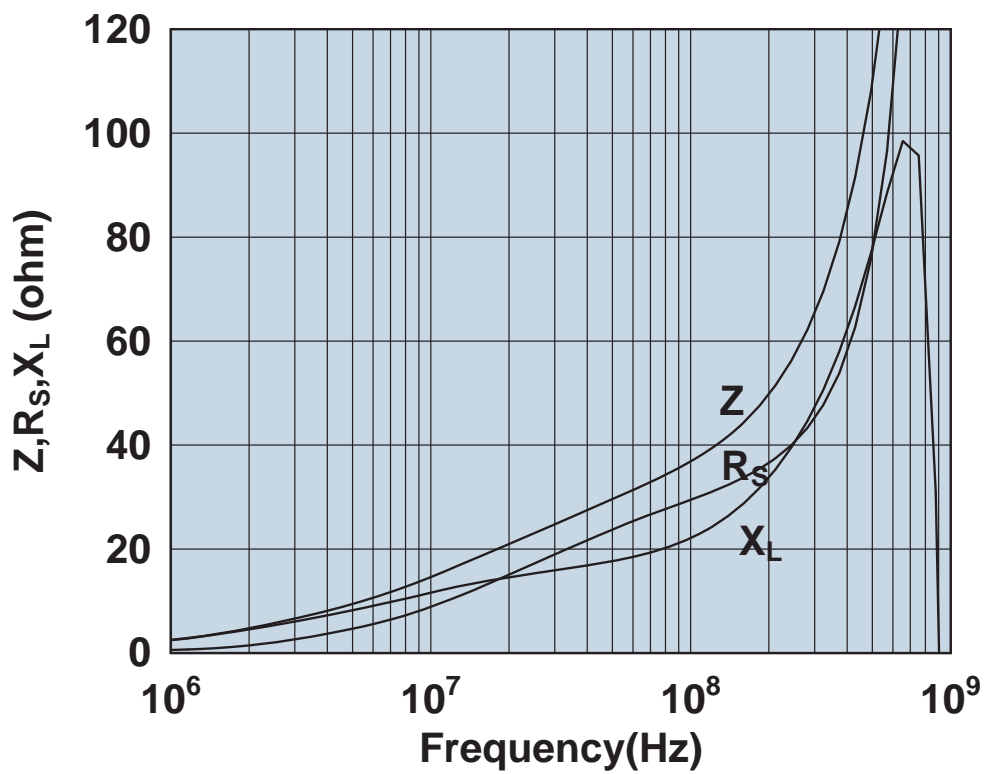

Impedance, reactance, and resistance vs. frequency.

2643801902

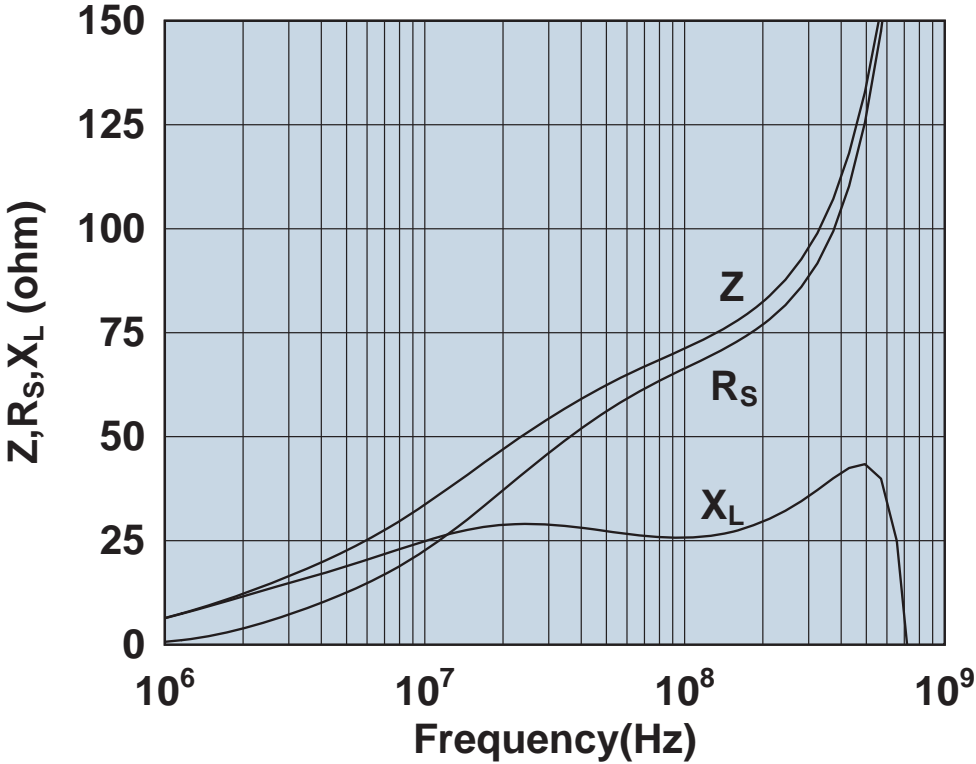

Impedance, reactance, and resistance vs. frequency.

2643802702

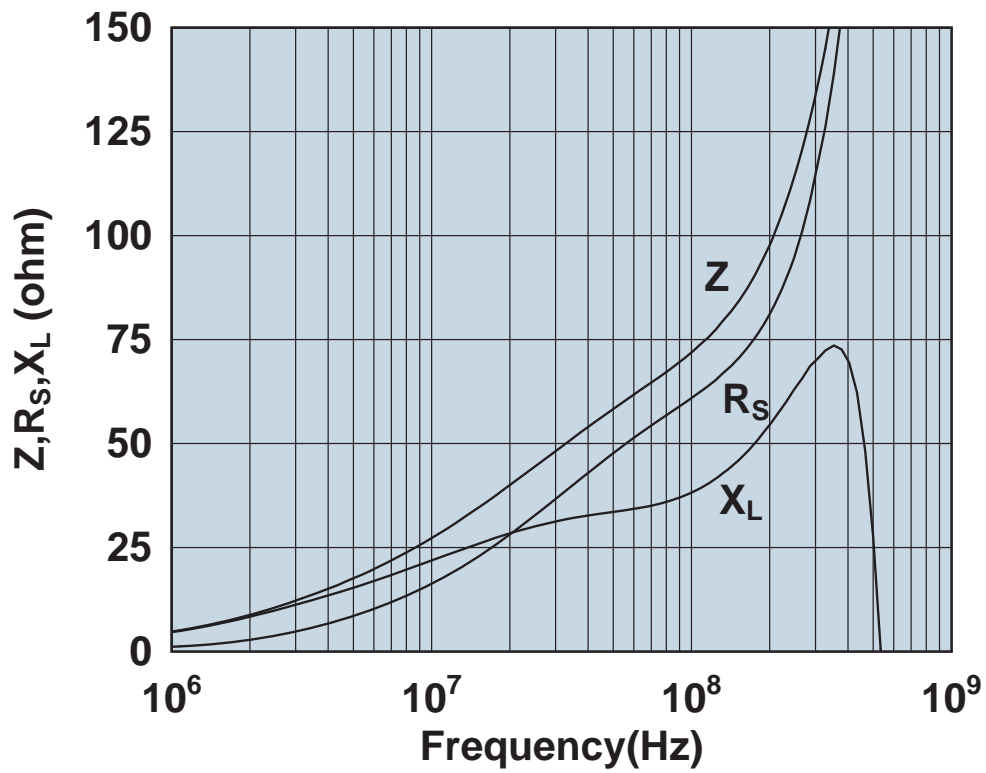

Impedance, reactance, and resistance vs. frequency.

2643803802

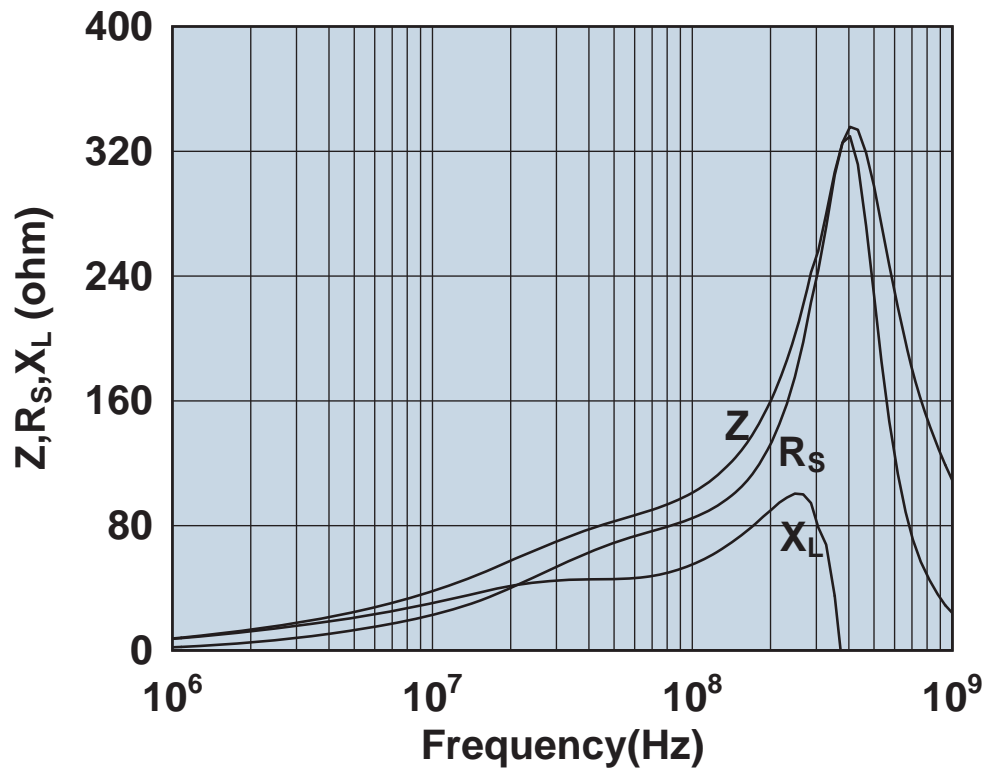

Impedance, reactance, and resistance vs. frequency.

2643804502

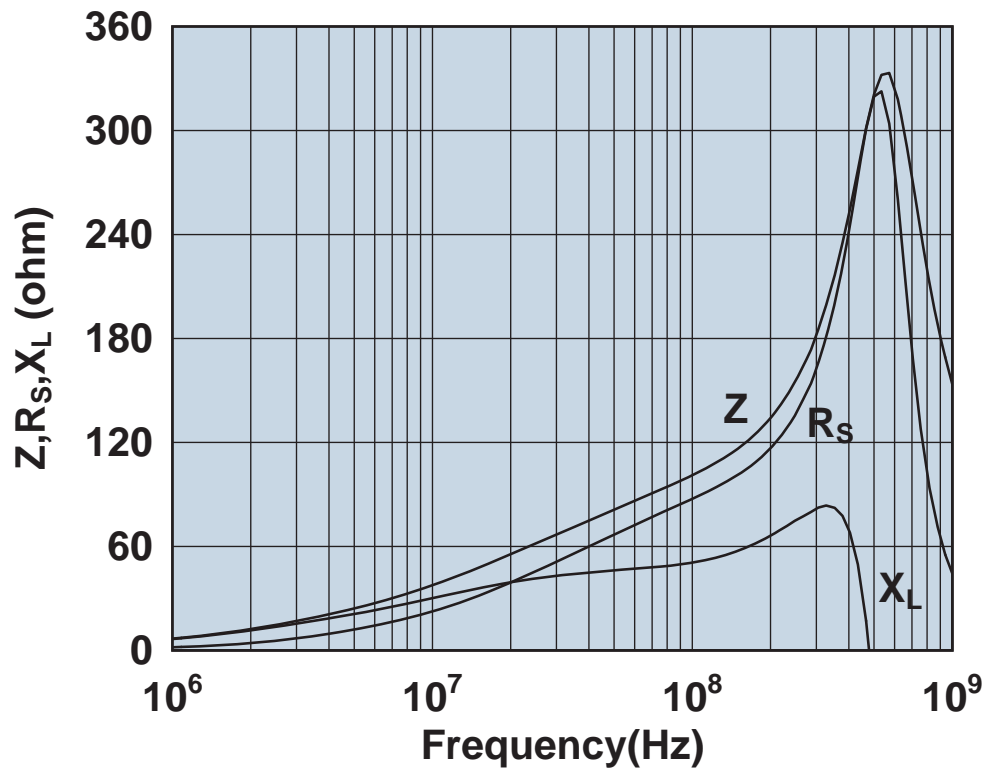

Impedance, reactance, and resistance vs. frequency.

2643806402

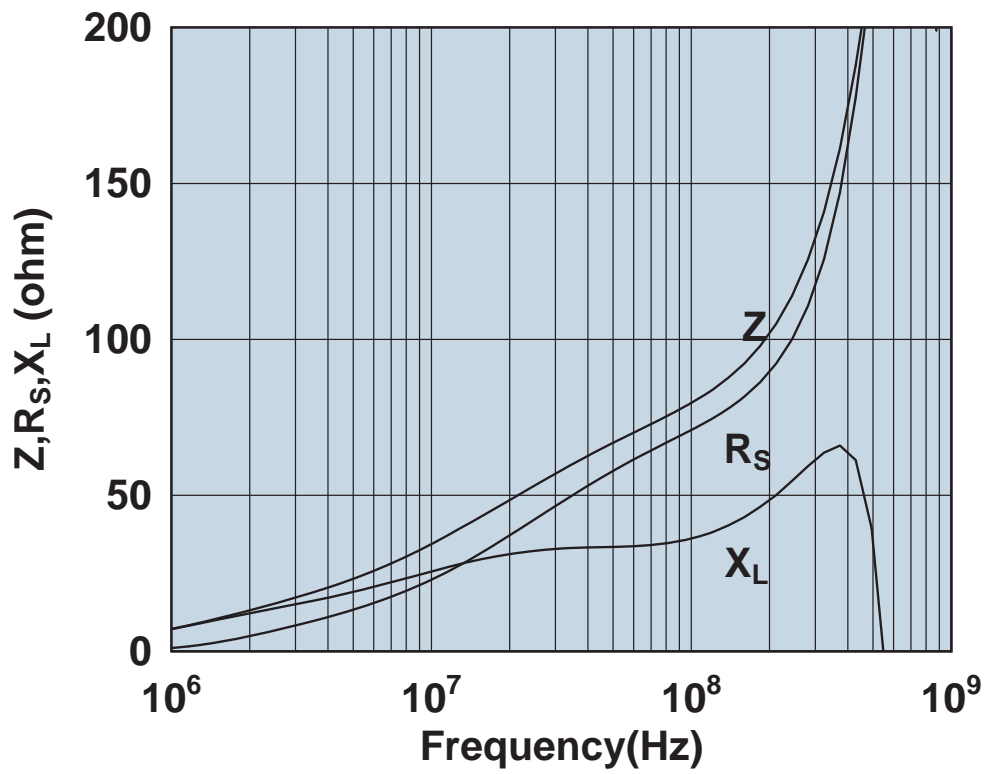

Impedance, reactance, and resistance vs. frequency.

2643806406

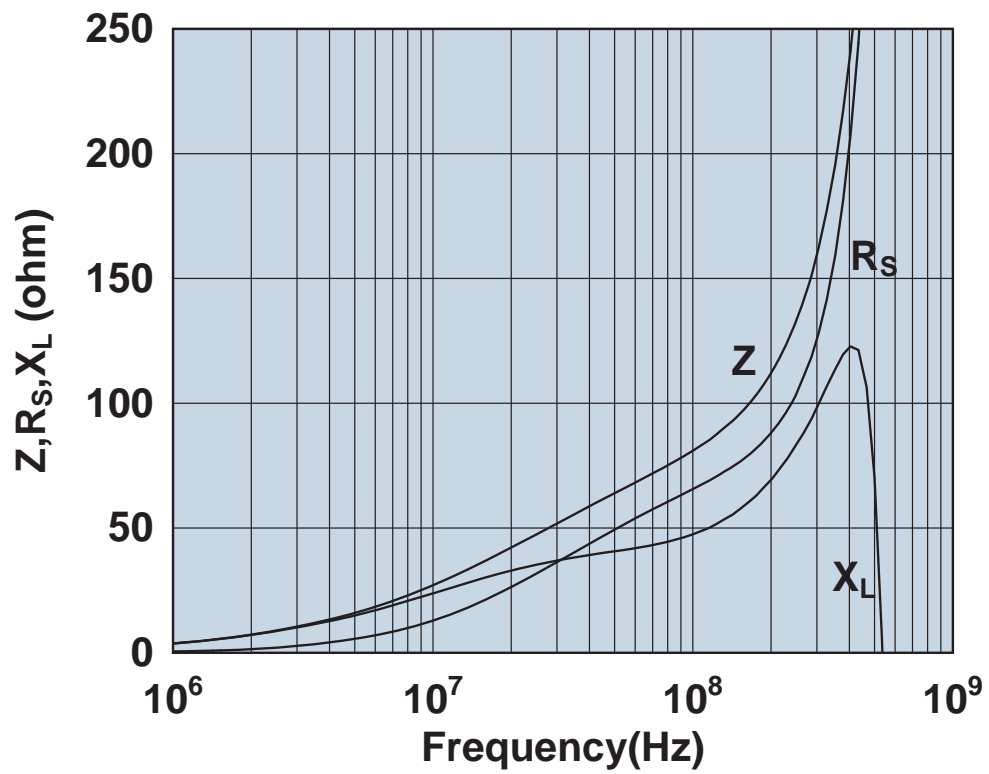

Impedance, reactance, and resistance vs. frequency.

2644164181

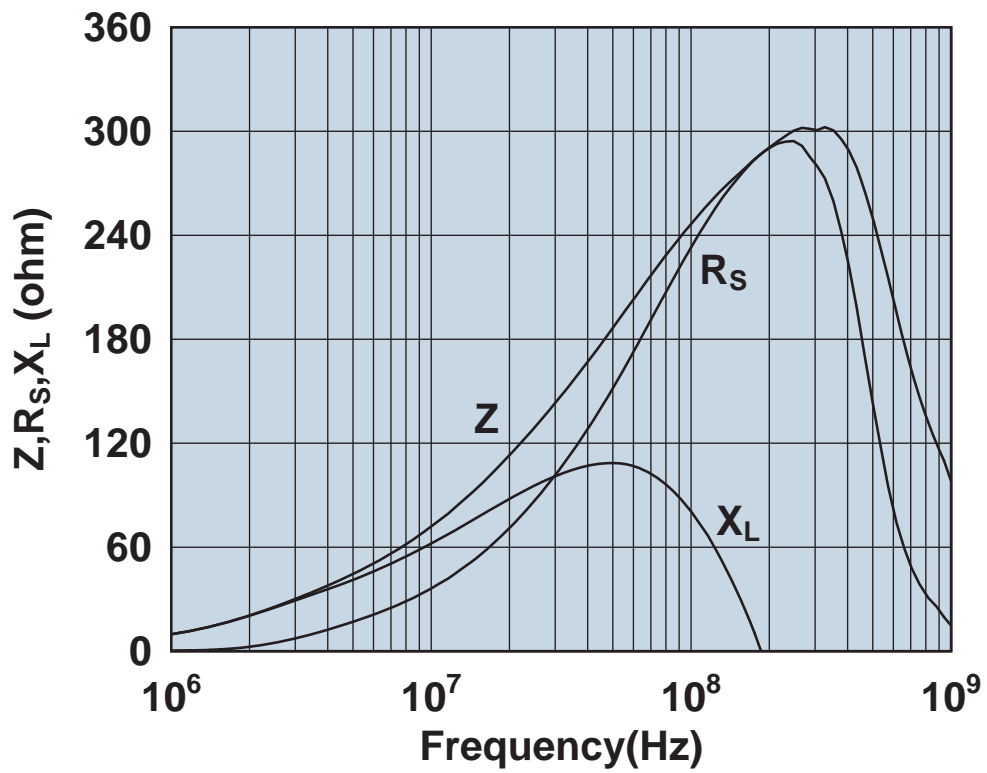

Impedance, reactance, and resistance vs. frequency.

2644164281

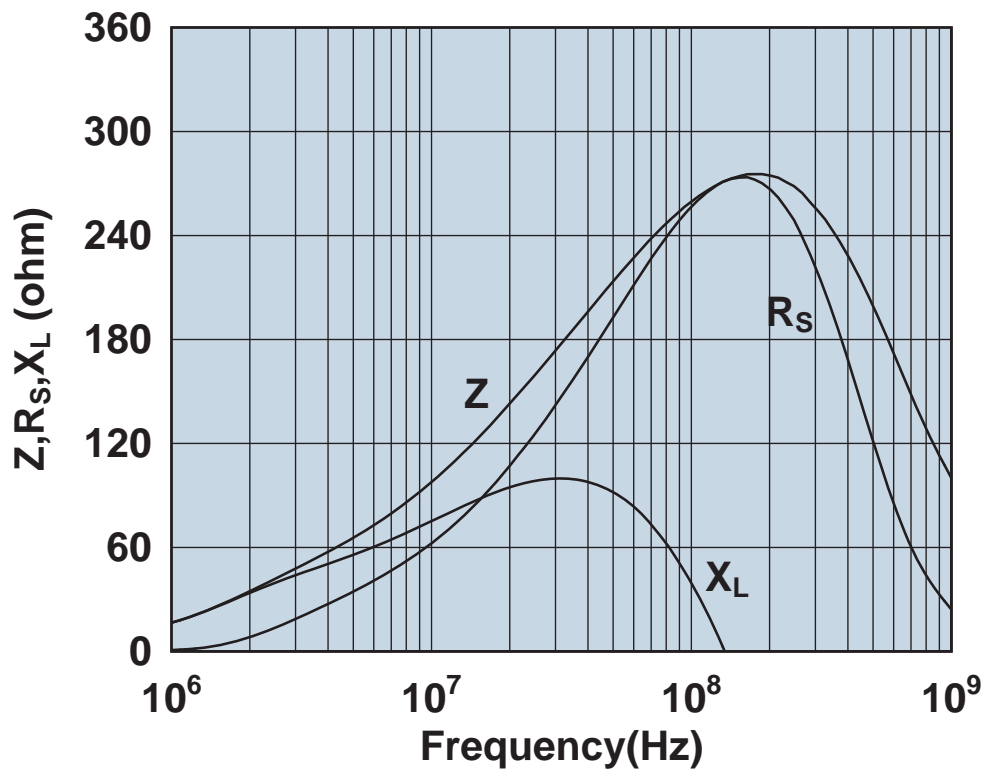

Impedance, reactance, and resistance vs. frequency.

2644164951

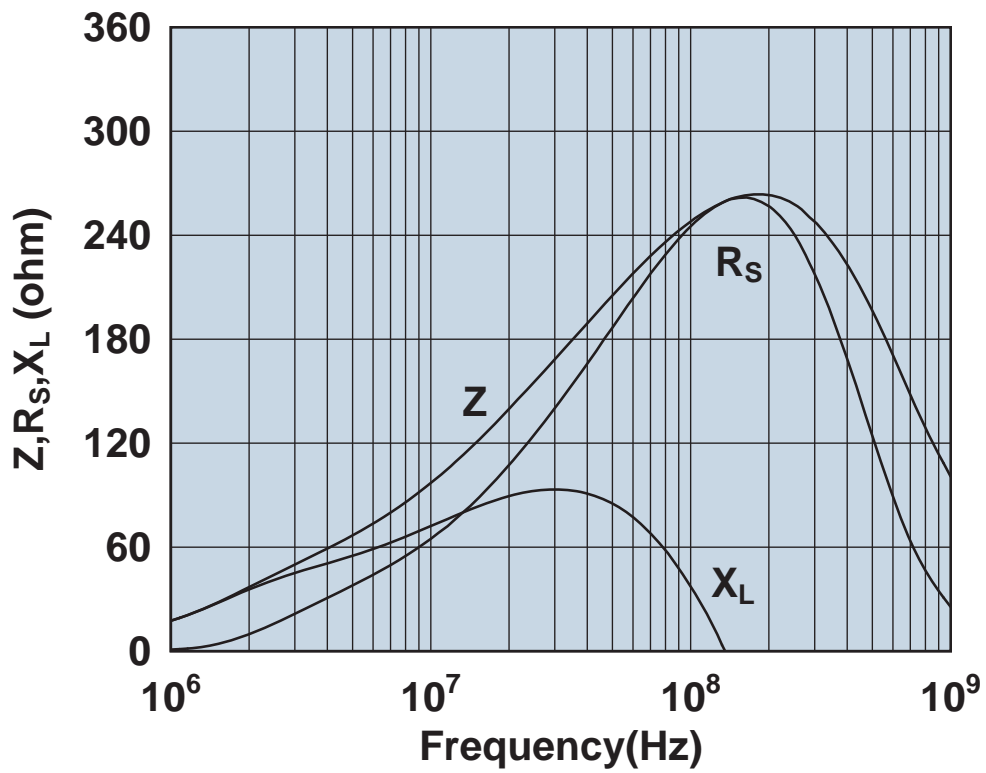

Impedance, reactance, and resistance vs. frequency.

2644167281

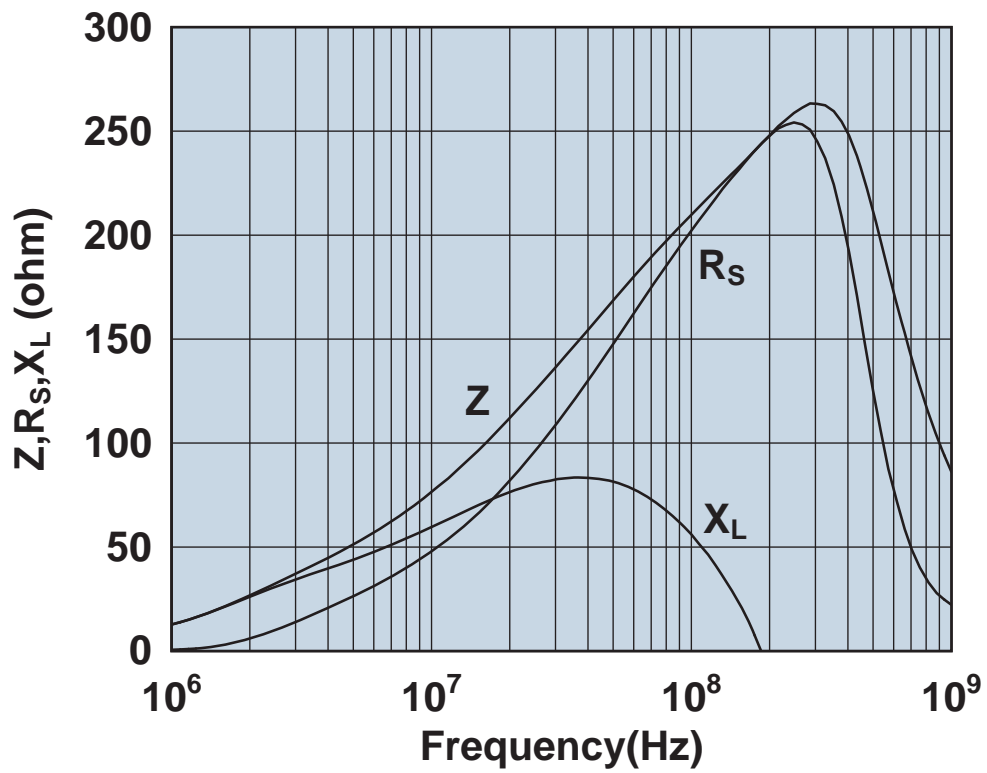

Impedance, reactance, and resistance vs. frequency.

2644173551

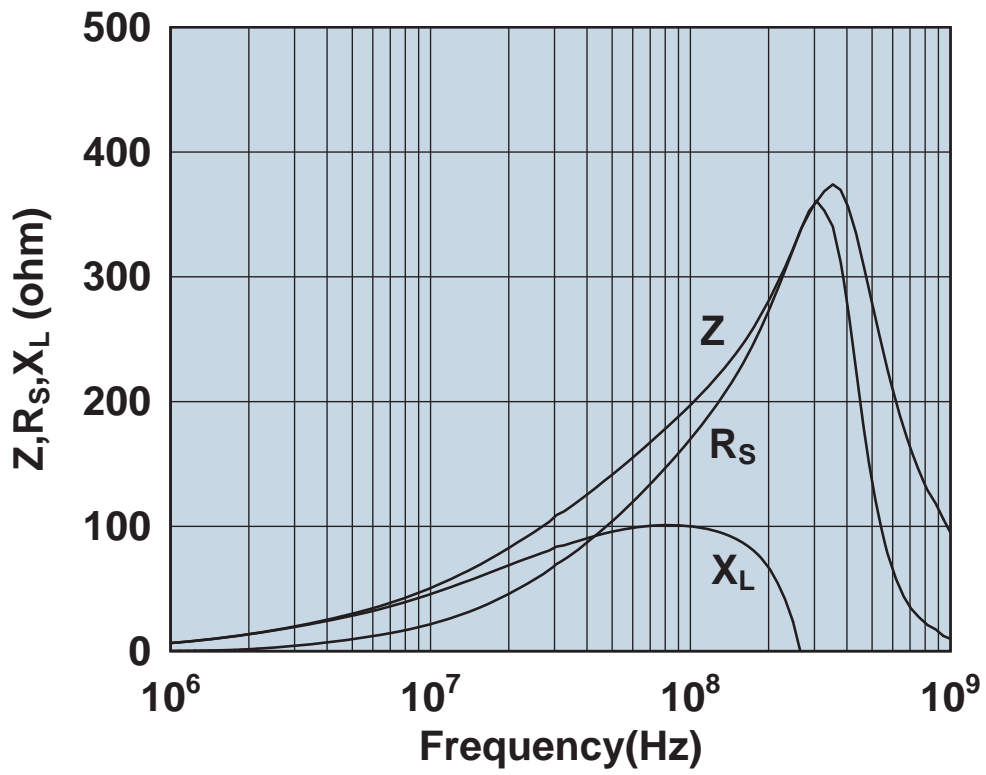

Impedance, reactance, and resistance vs. frequency.

2644173951

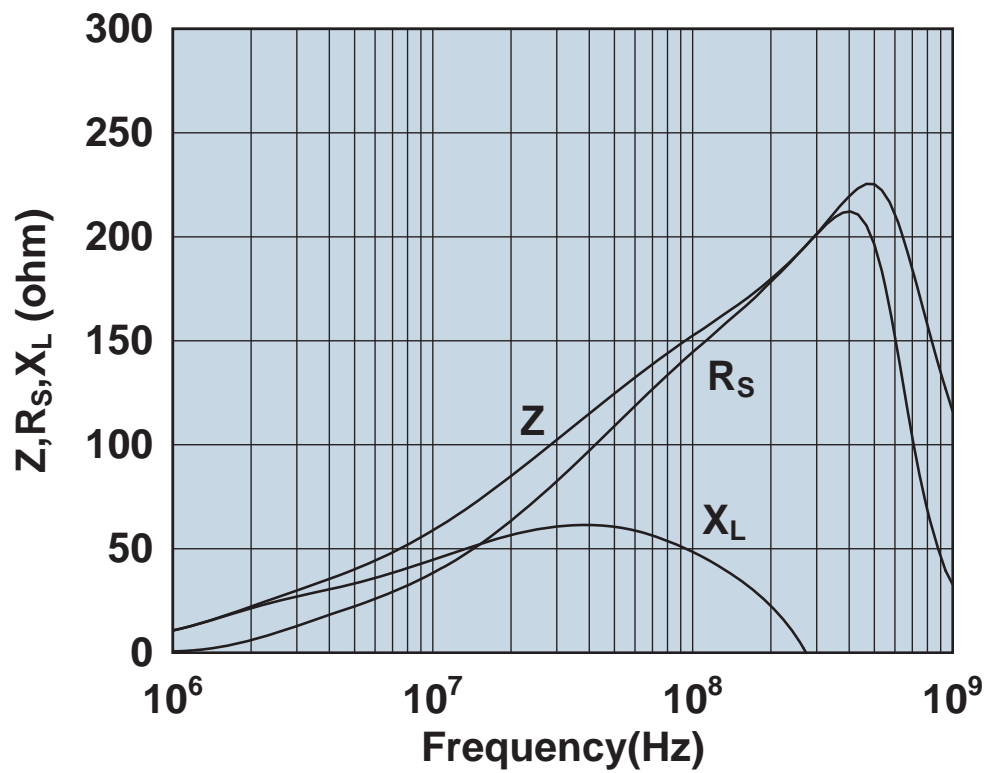

Impedance, reactance, and resistance vs. frequency.

2644176451

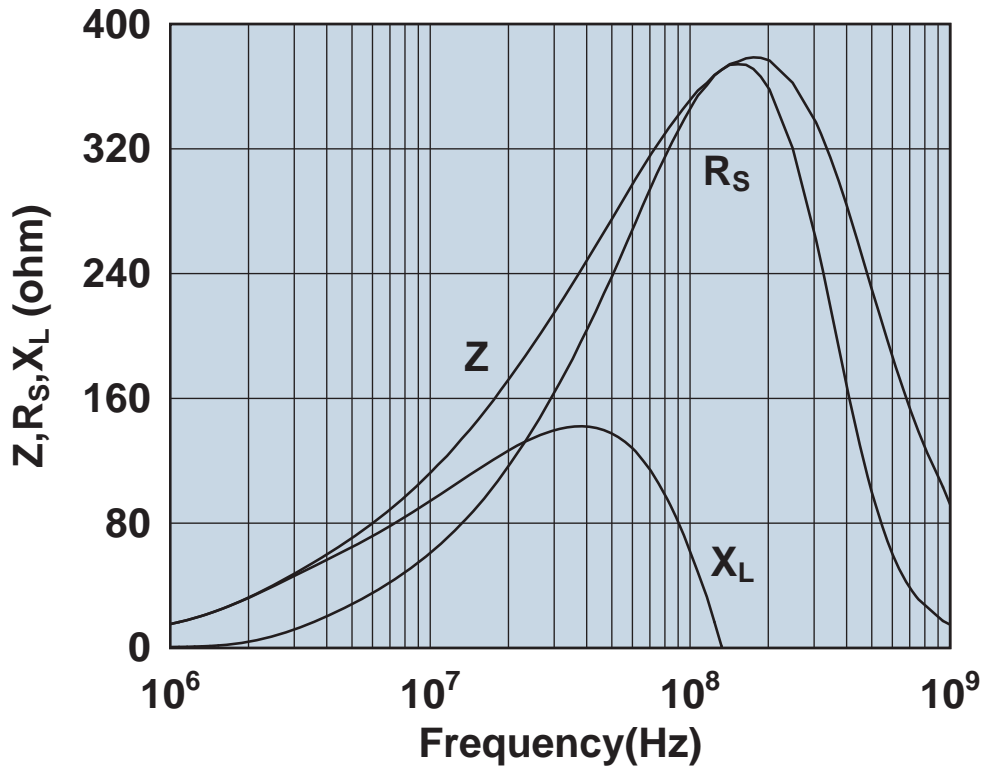

Impedance, reactance, and resistance vs. frequency.

2644177081

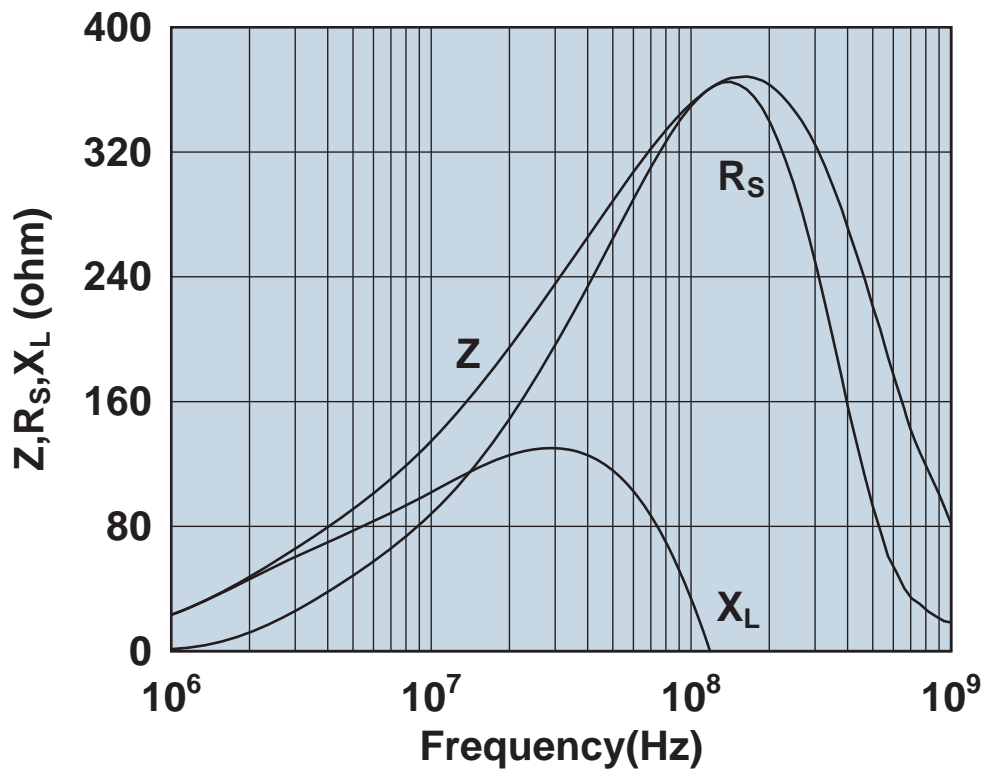

Impedance, reactance, and resistance vs. frequency.

2644236001

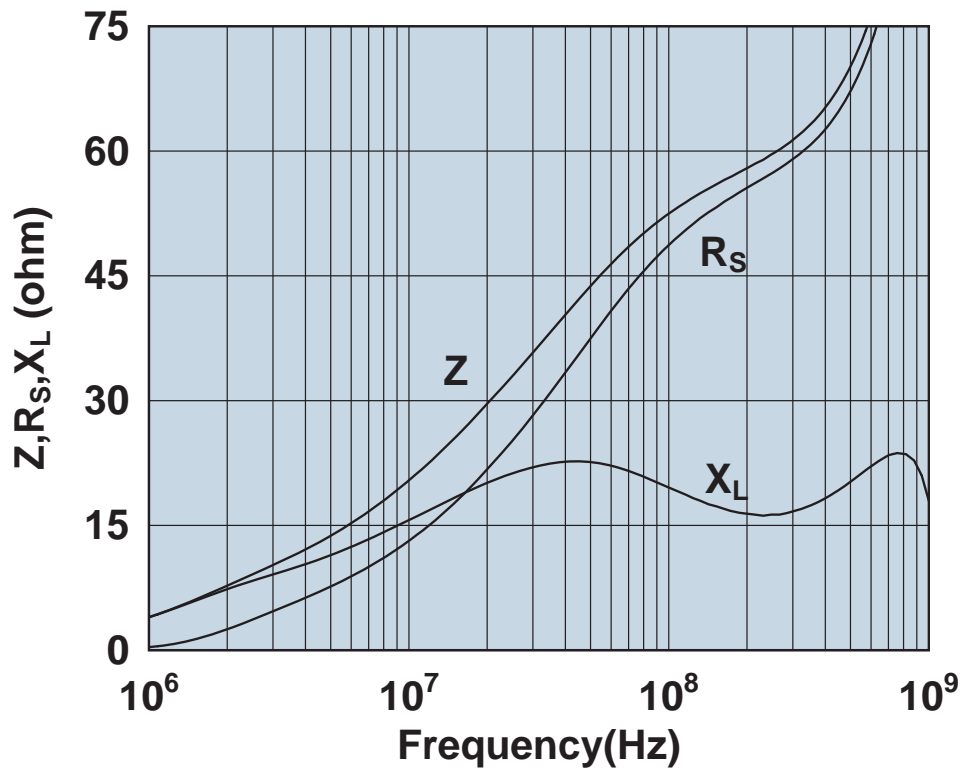

Impedance, reactance, and resistance vs. frequency.

2644236101

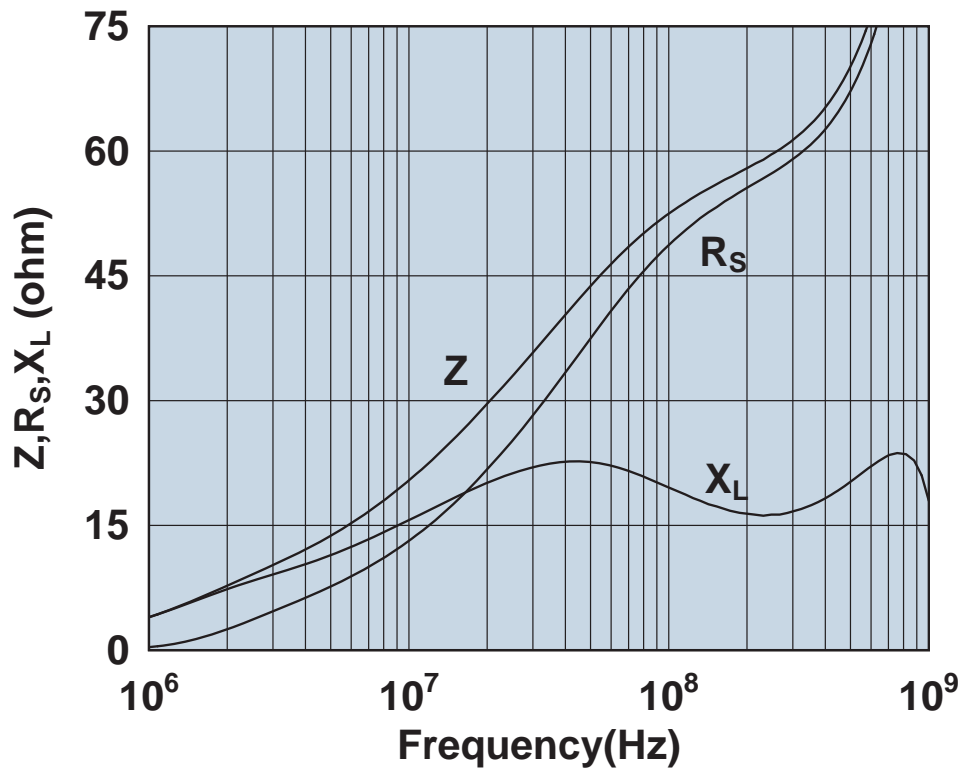

Impedance, reactance, and resistance vs. frequency.

2644236301

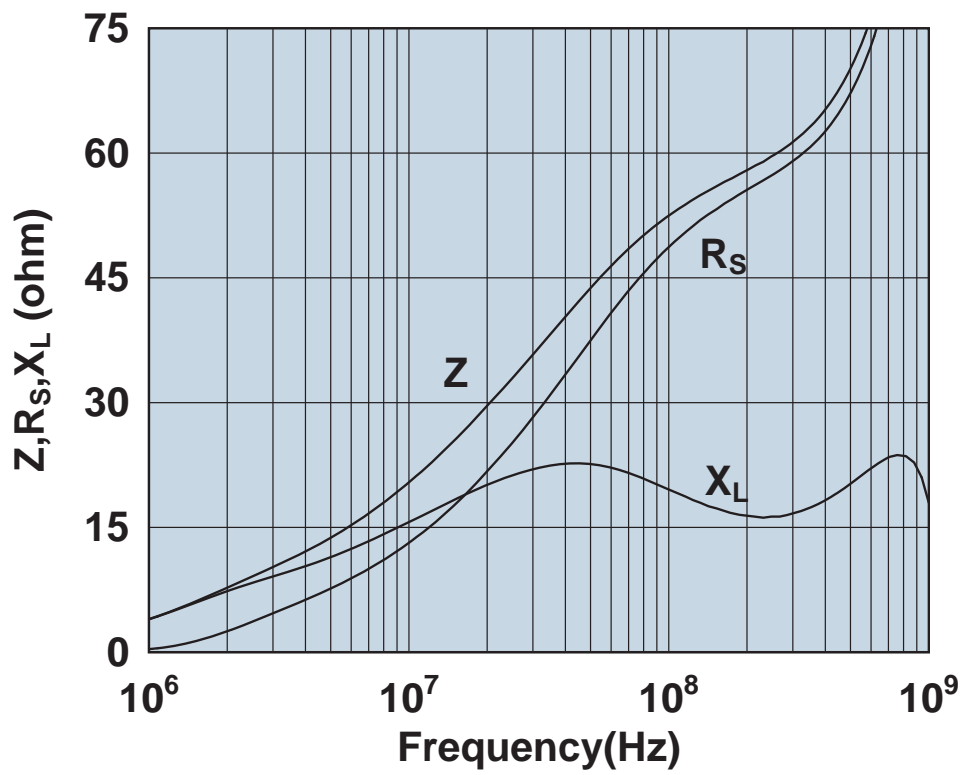

Impedance, reactance, and resistance vs. frequency.

2644236401

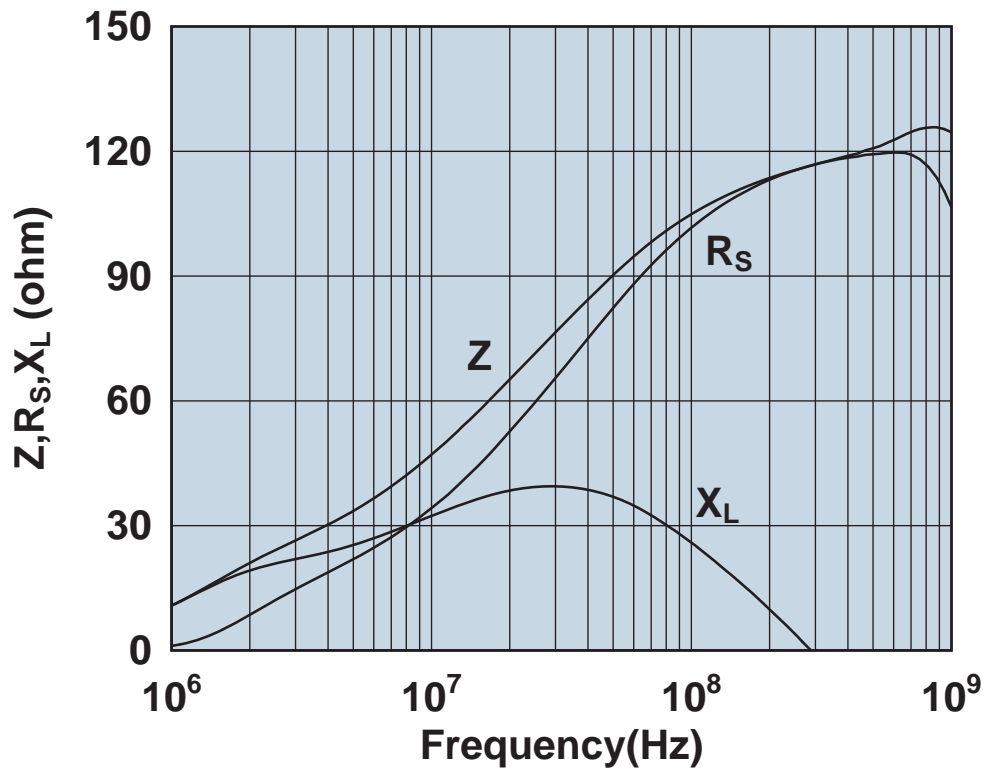

Impedance, reactance, and resistance vs. frequency.

2644236501

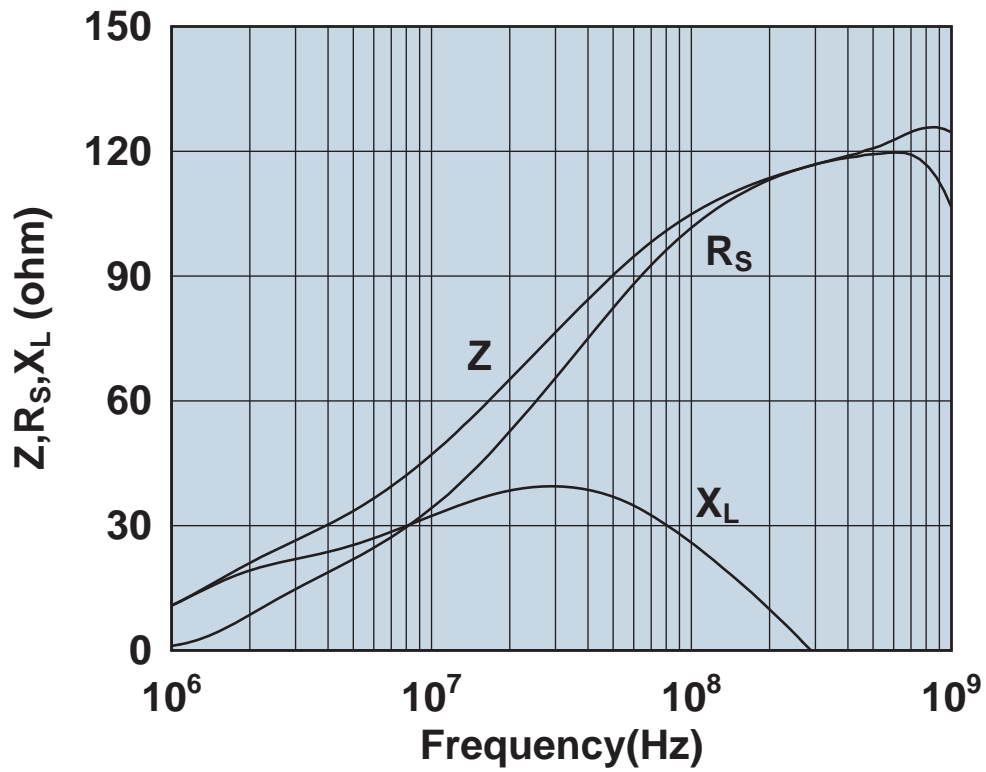

Impedance, reactance, and resistance vs. frequency.

2644236601

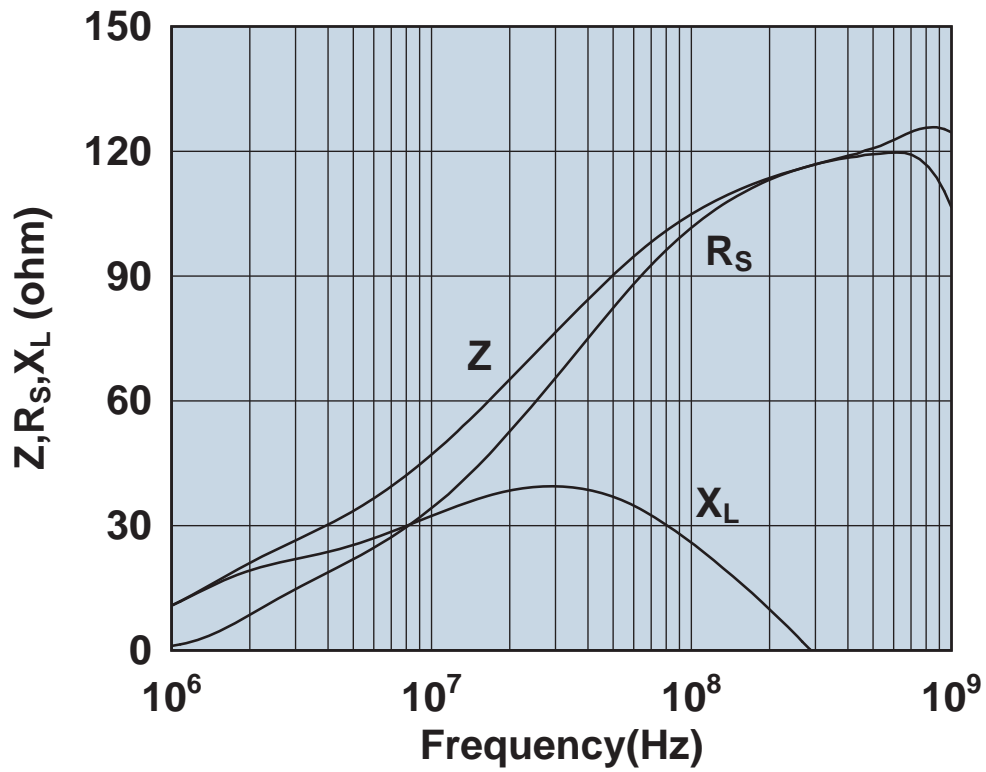

Impedance, reactance, and resistance vs. frequency.

2644245601

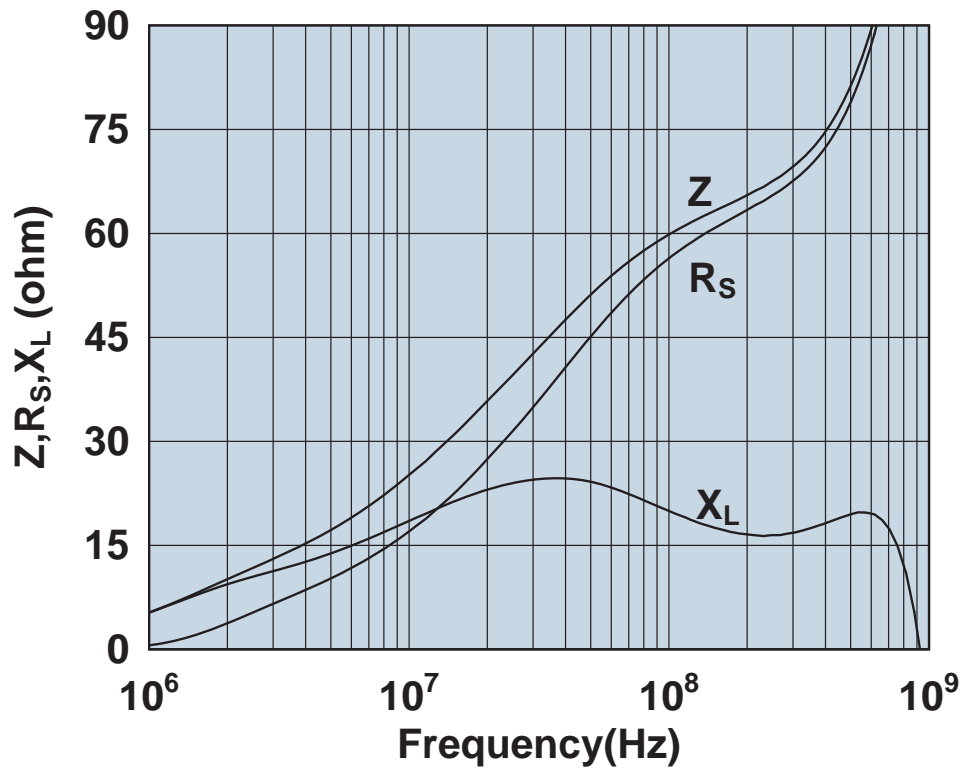

Impedance, reactance, and resistance vs. frequency.

2644245701

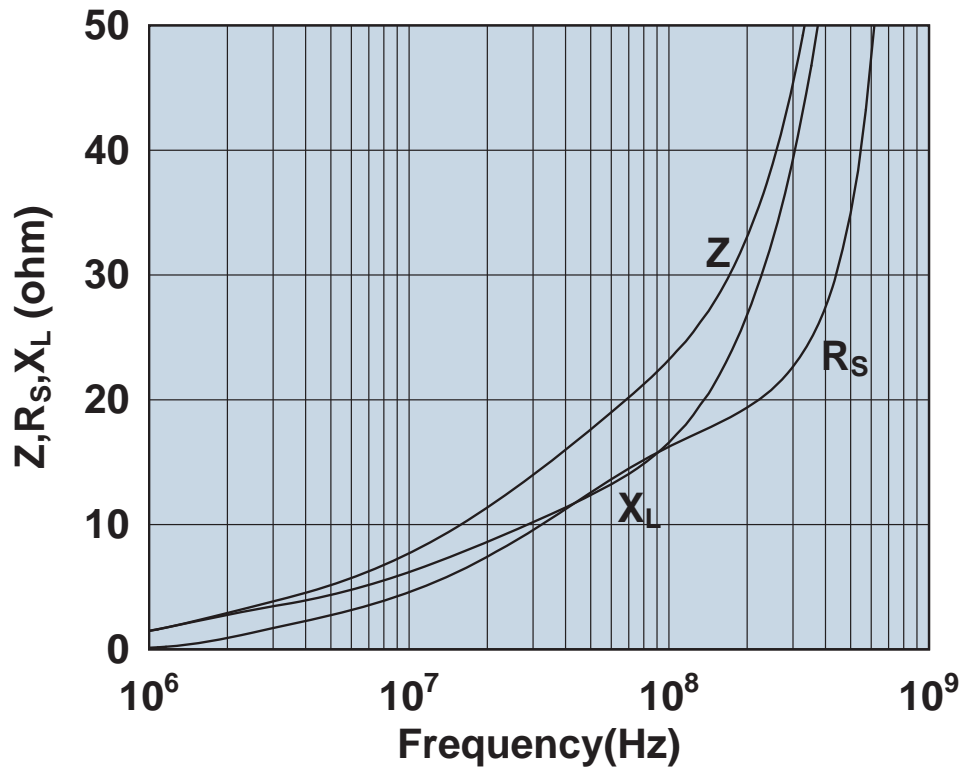

Impedance, reactance, and resistance vs. frequency.

2644245801

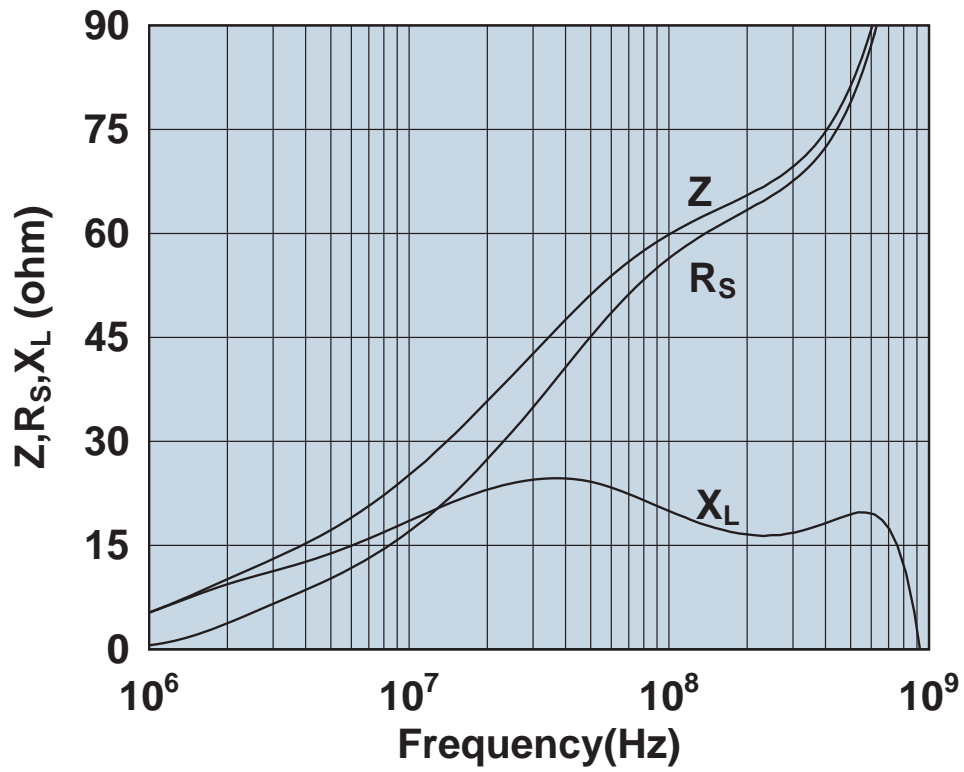

Impedance, reactance, and resistance vs. frequency.

2644245901

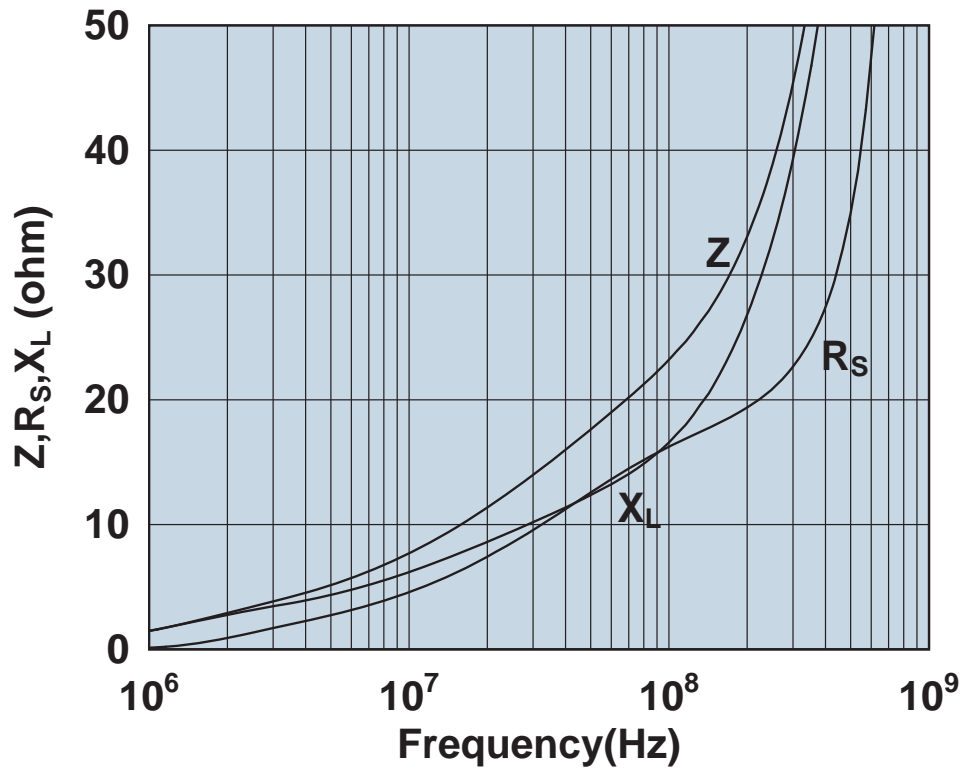

Impedance, reactance, and resistance vs. frequency.

2644246001

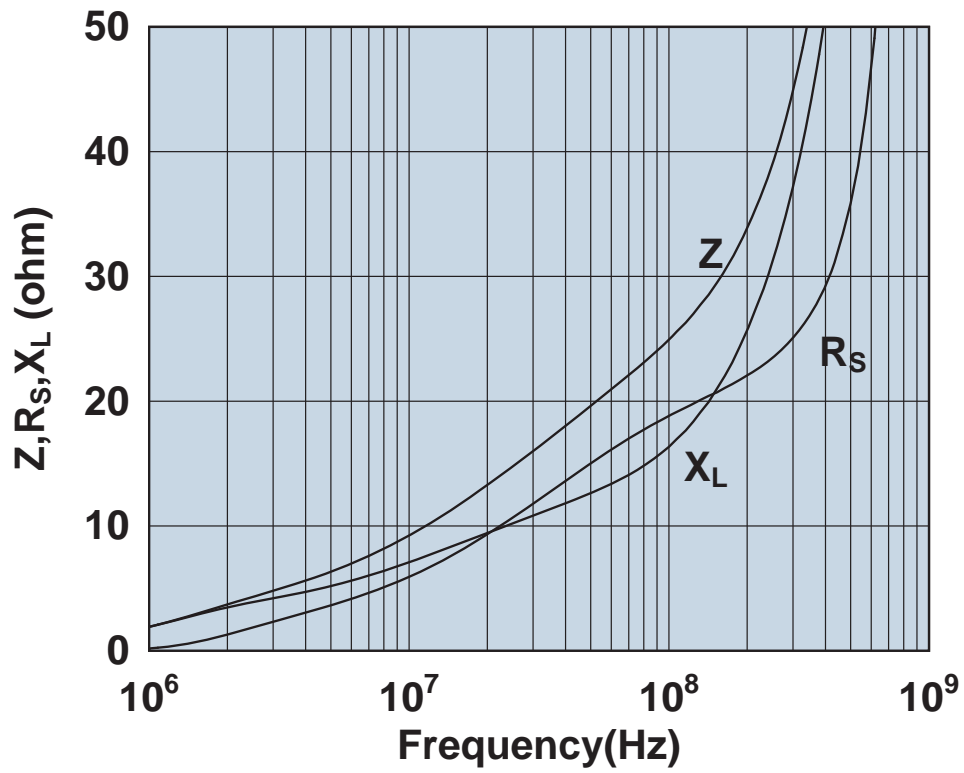

Impedance, reactance, and resistance vs. frequency.

2644246101

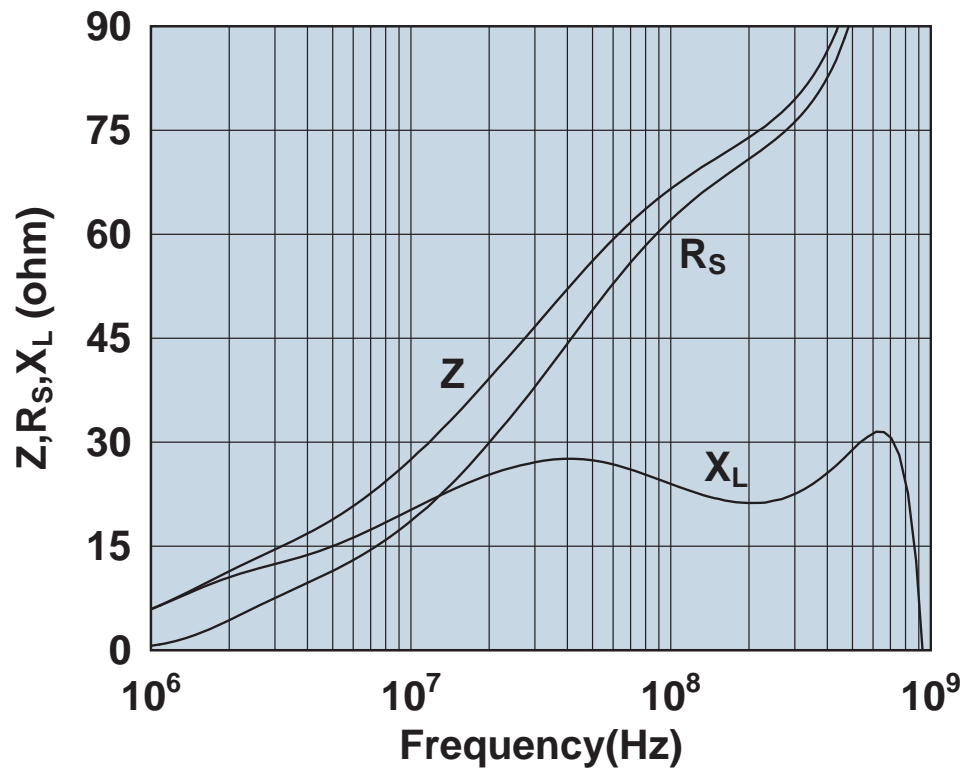

Impedance, reactance, and resistance vs. frequency.

2644246201

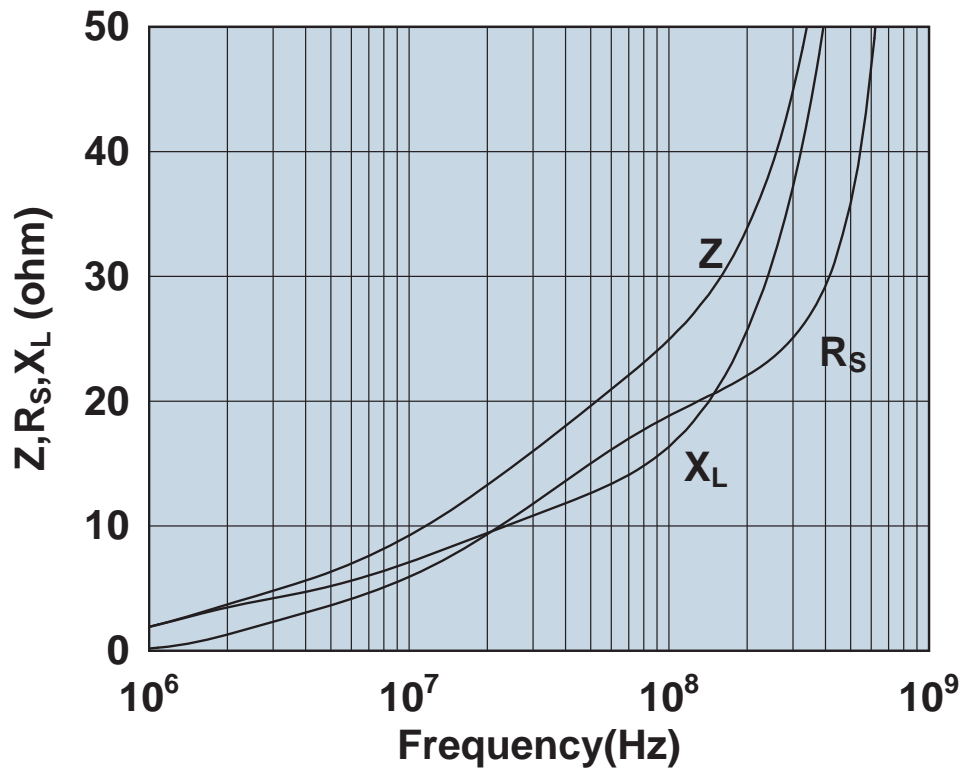

Impedance, reactance, and resistance vs. frequency.

2644246301

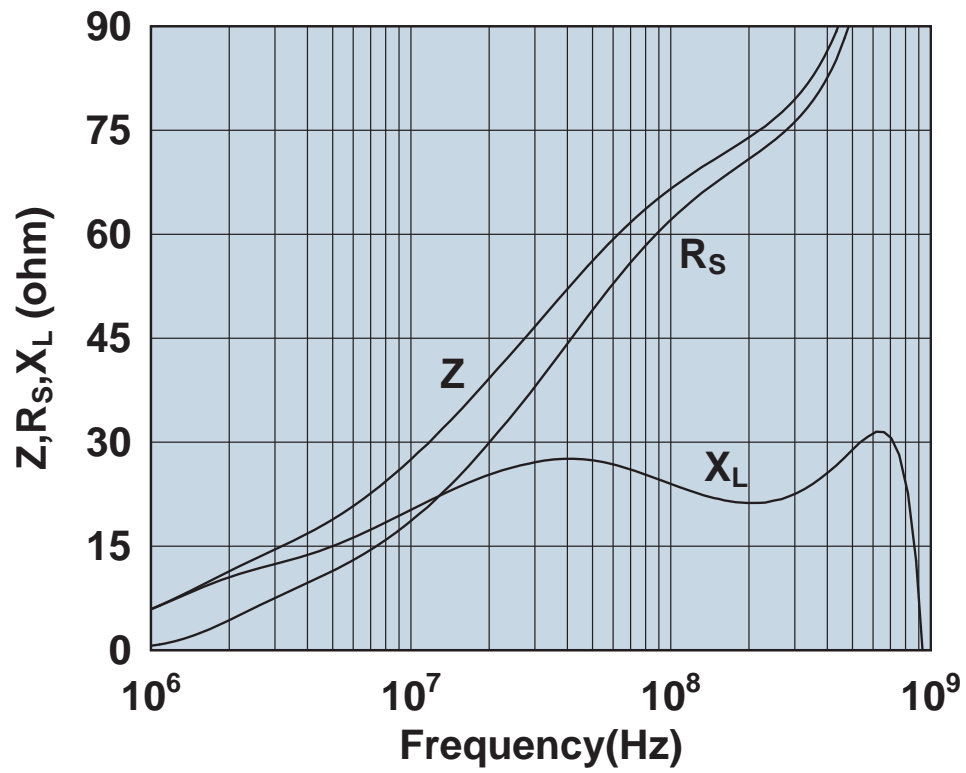

Impedance, reactance, and resistance vs. frequency.

2644246701

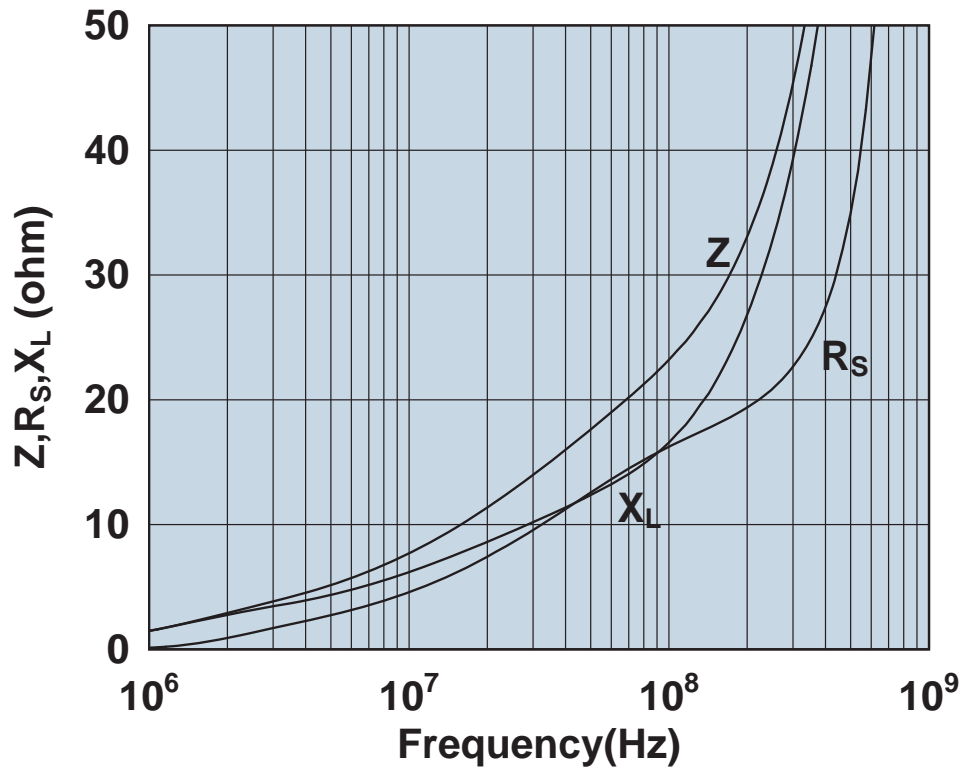

Impedance, reactance, and resistance vs. frequency.

2644246801

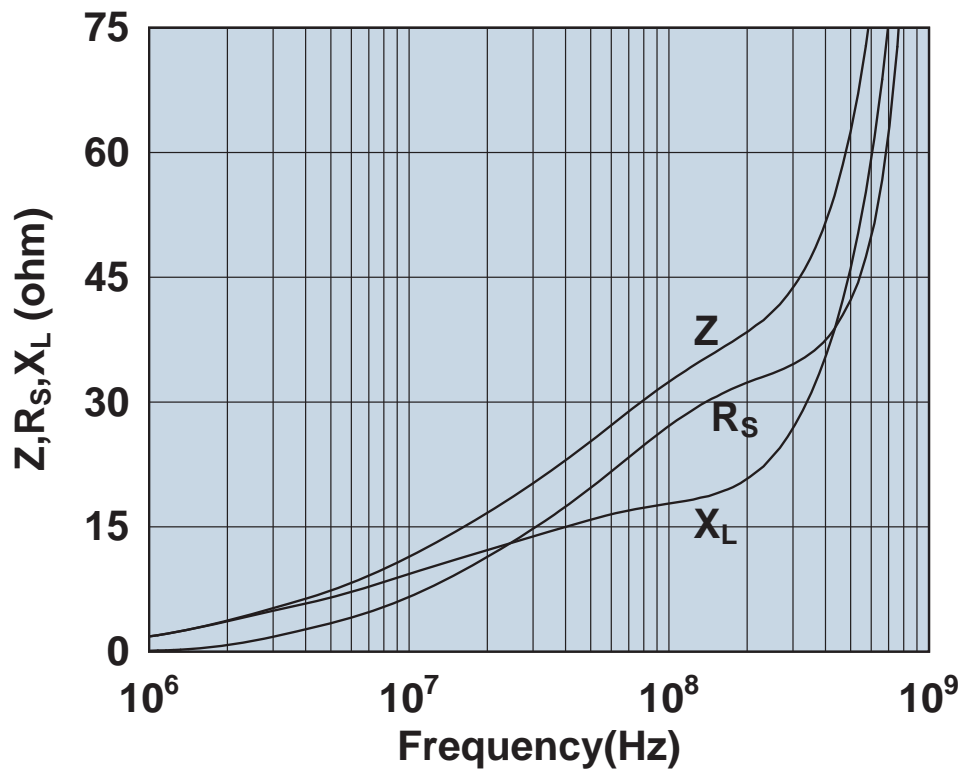

Impedance, reactance, and resistance vs. frequency.

2644246901

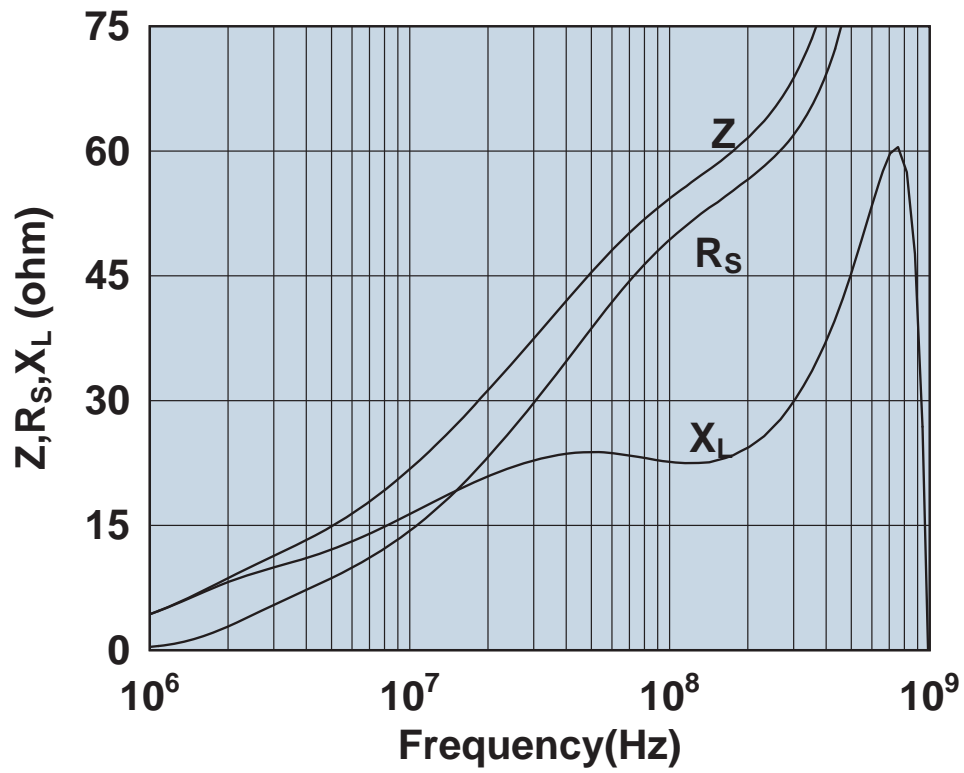

Impedance, reactance, and resistance vs. frequency.

2644247001

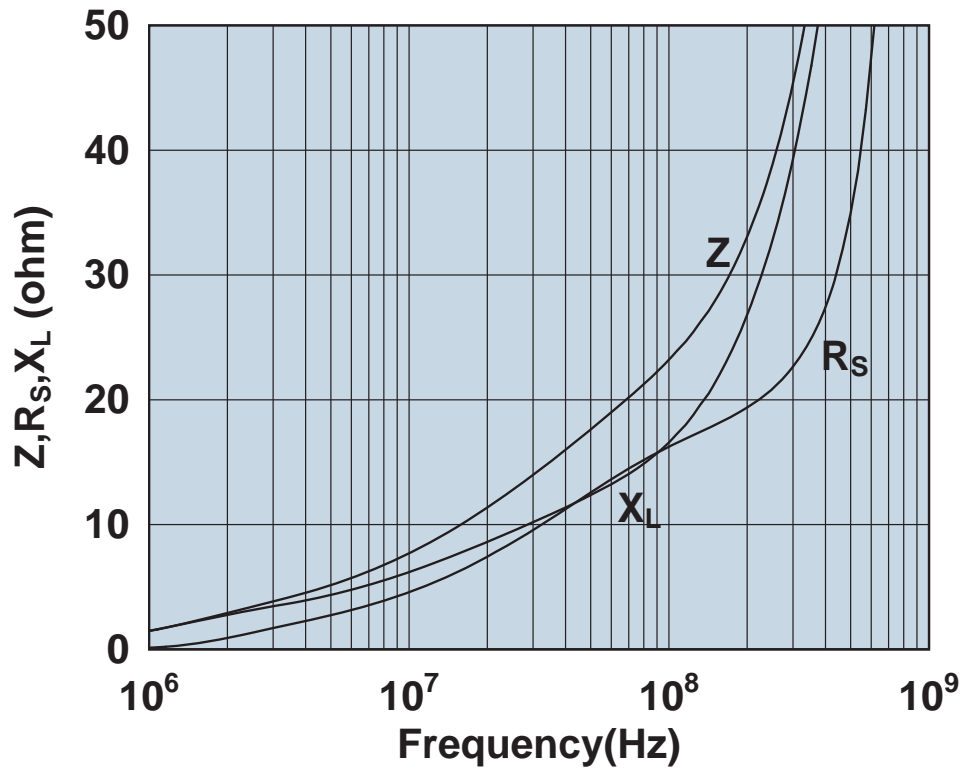

Impedance, reactance, and resistance vs. frequency.

2644247101

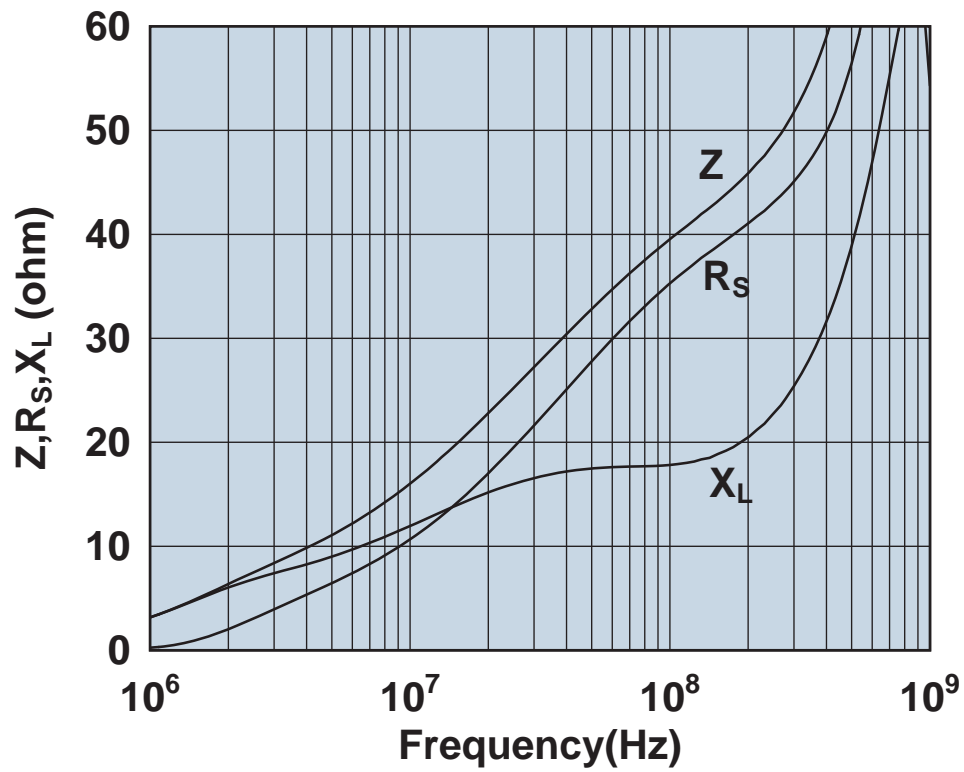

Impedance, reactance, and resistance vs. frequency.

2644247201

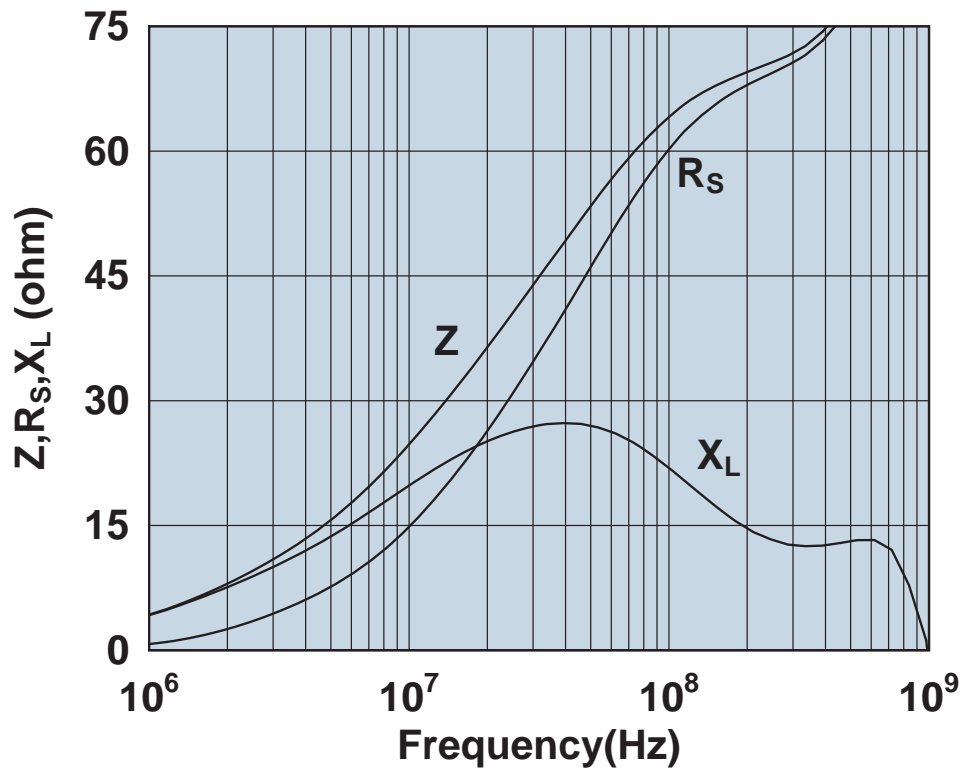

Impedance, reactance, and resistance vs. frequency.

2644247301

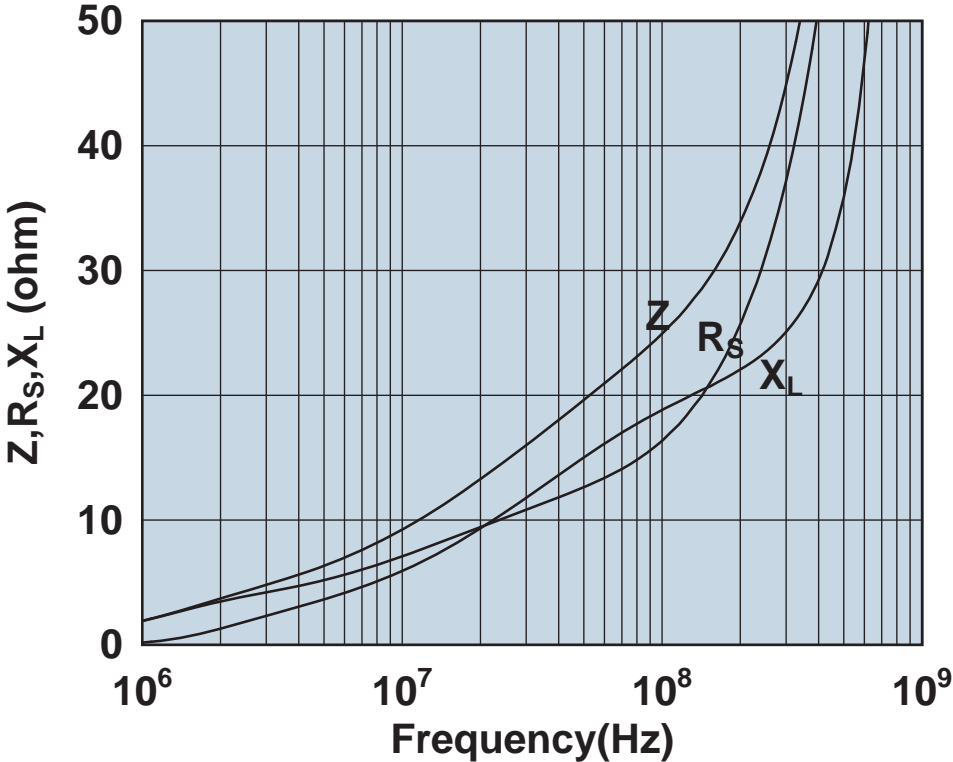

Impedance, reactance, and resistance vs. frequency.

2644247401

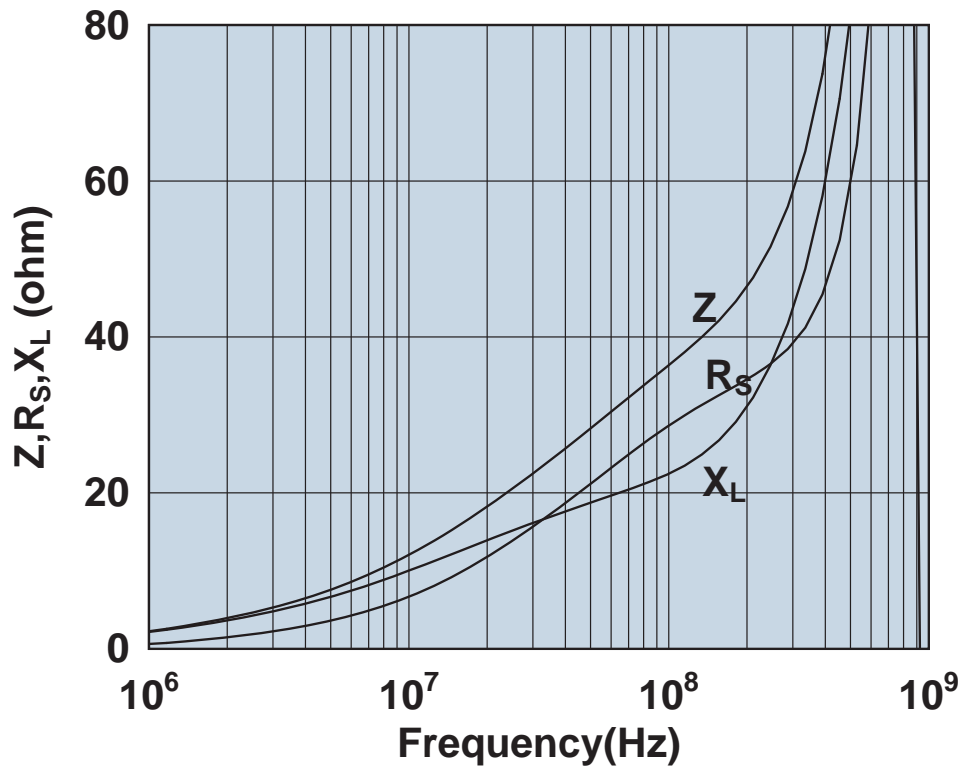

Impedance, reactance, and resistance vs. frequency.

2644247501

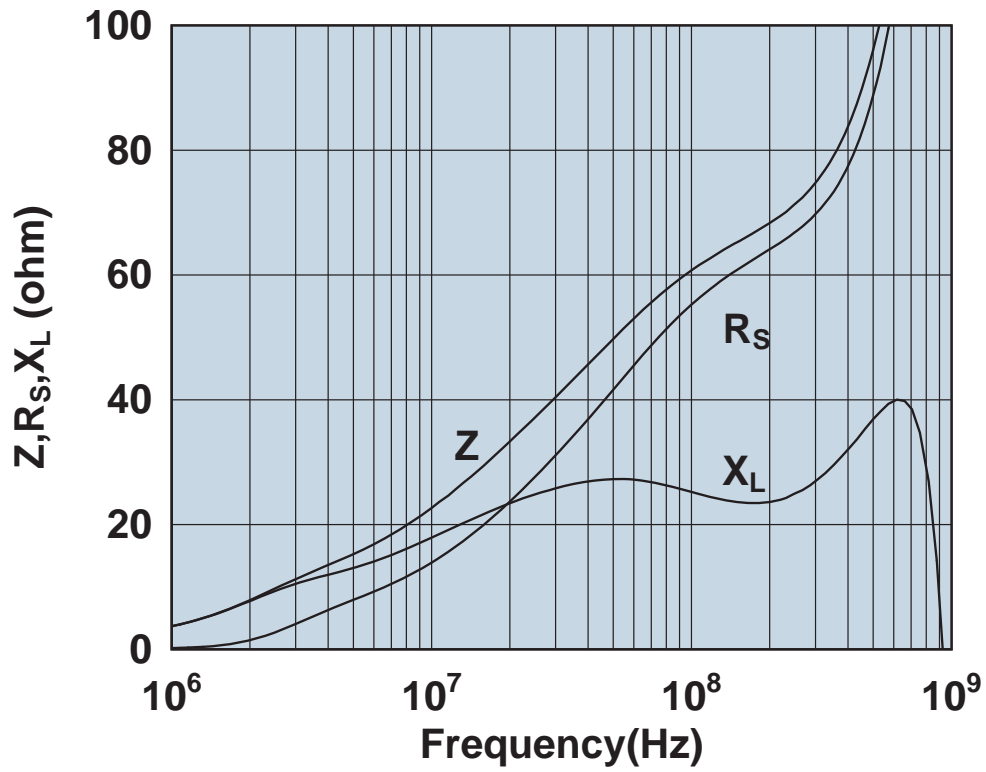

Impedance, reactance, and resistance vs. frequency.

2644251801

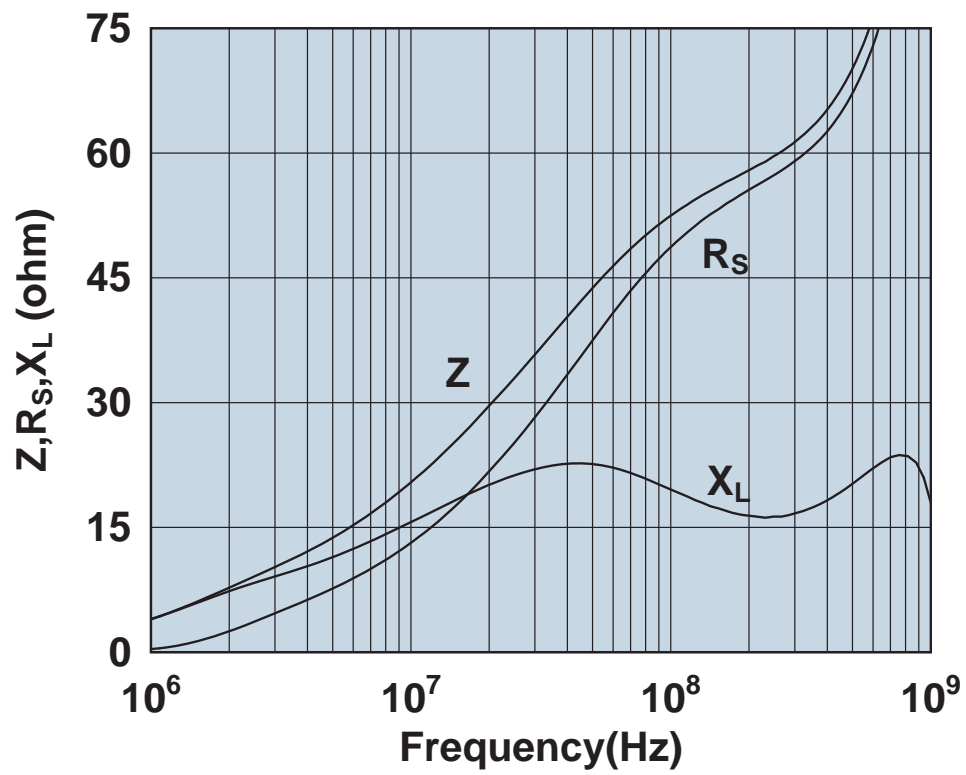

Impedance, reactance, and resistance vs. frequency.

2644251901

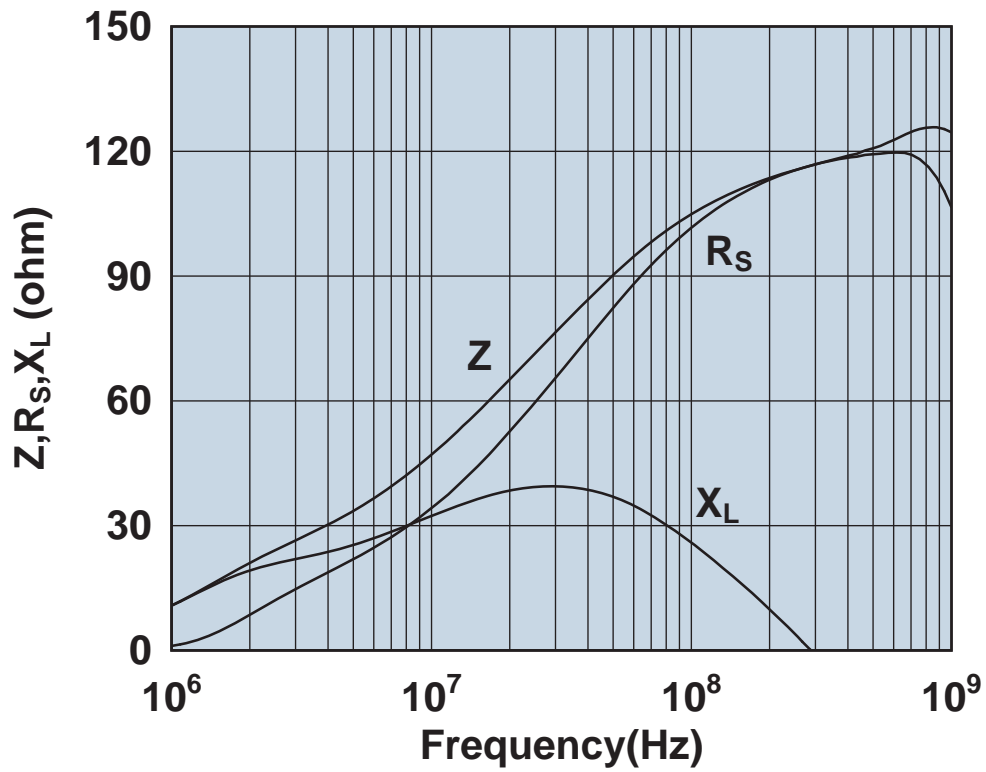

Impedance, reactance, and resistance vs. frequency.

2644373841

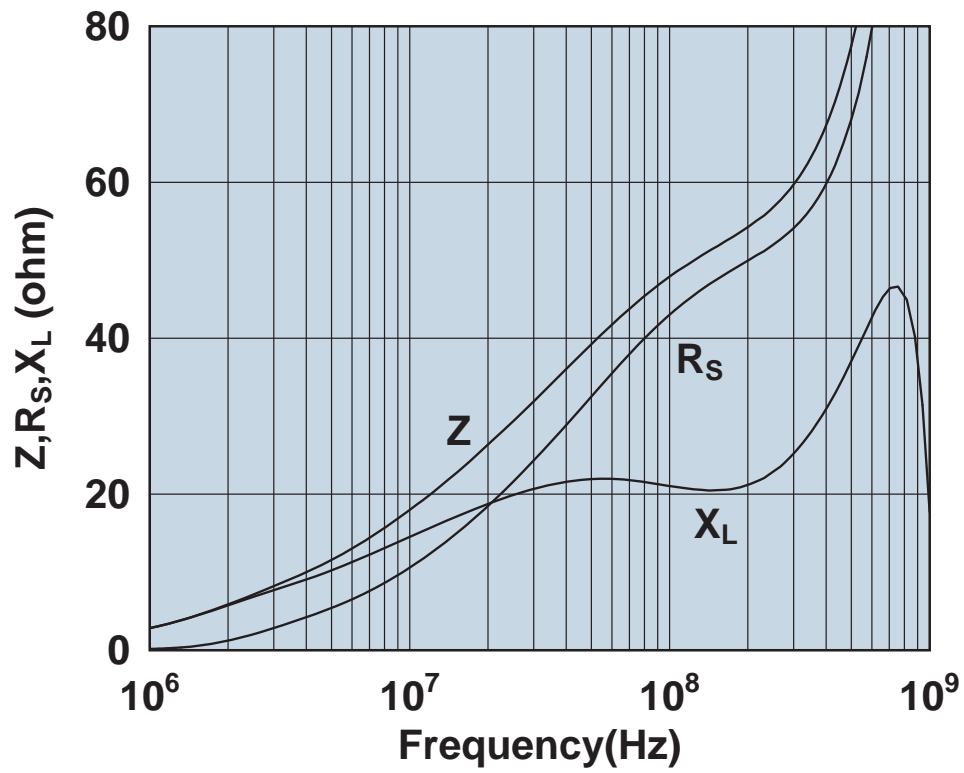

Impedance, reactance, and resistance vs. frequency.

2644373941

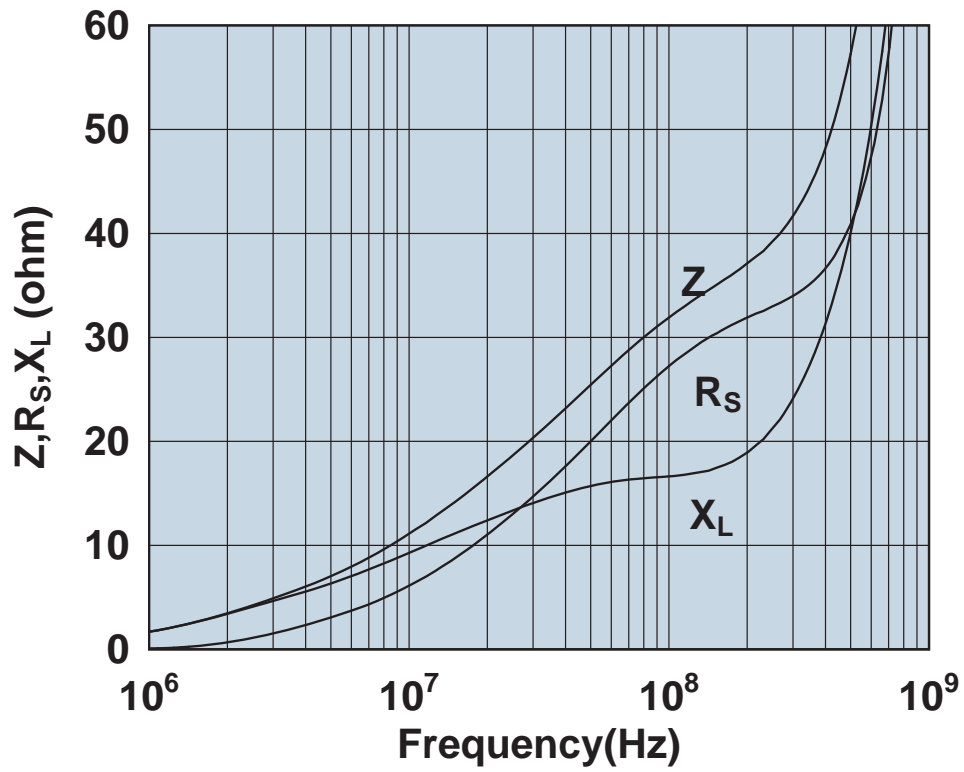

Impedance, reactance, and resistance vs. frequency.

2644666611

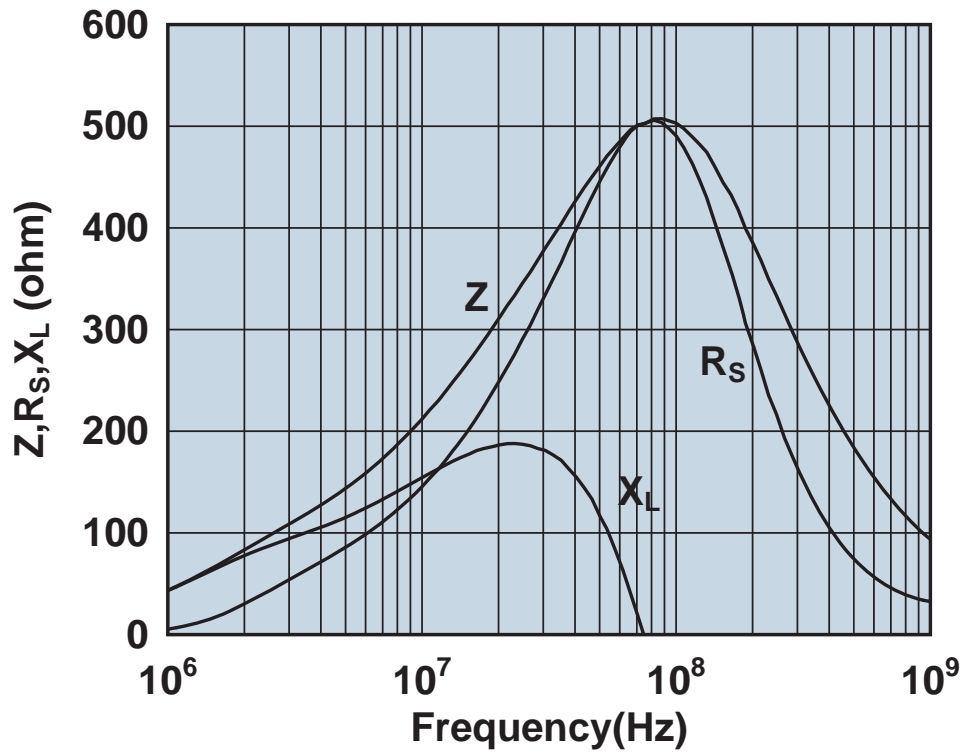

Impedance, reactance, and resistance vs. frequency.

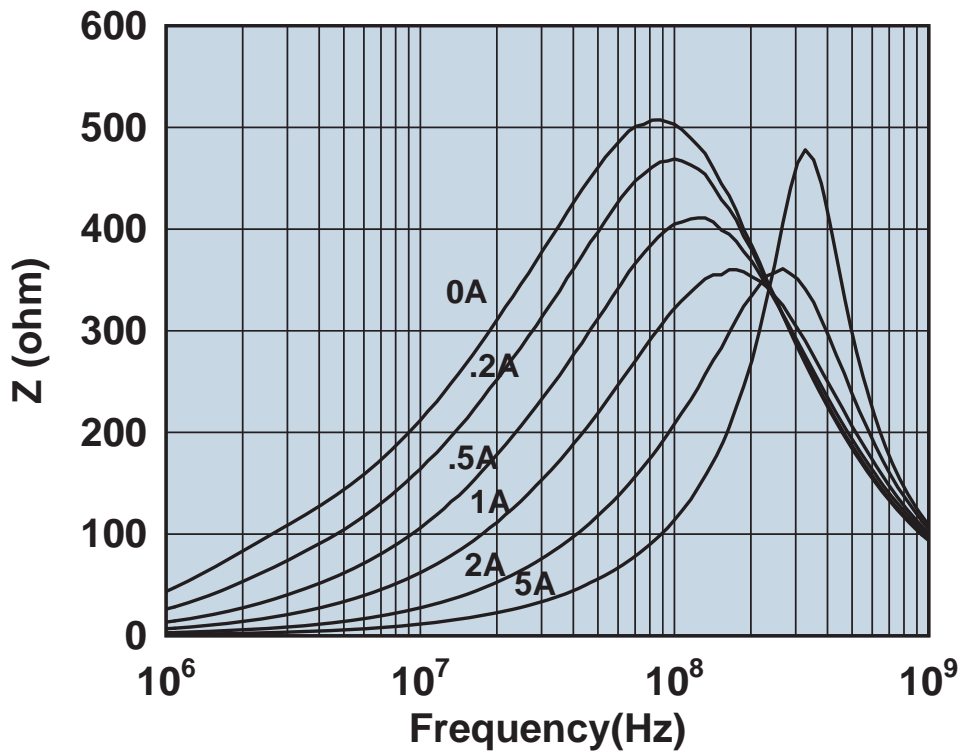

Impedance vs. frequency with dc bias.

2644777711

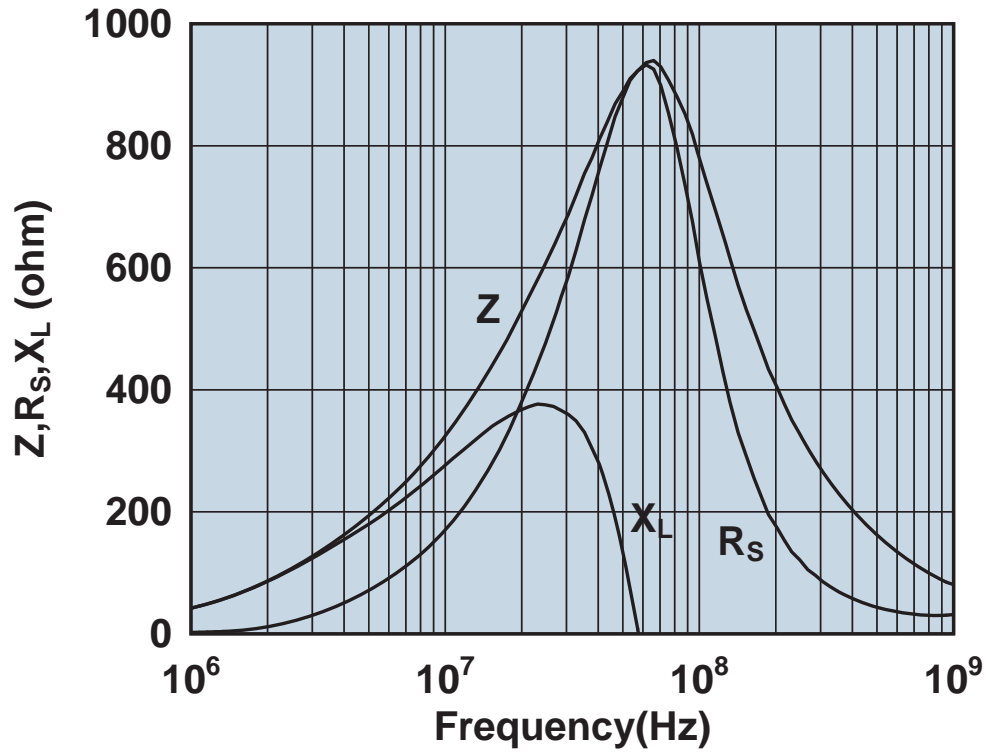

Impedance, reactance, and resistance vs. frequency.

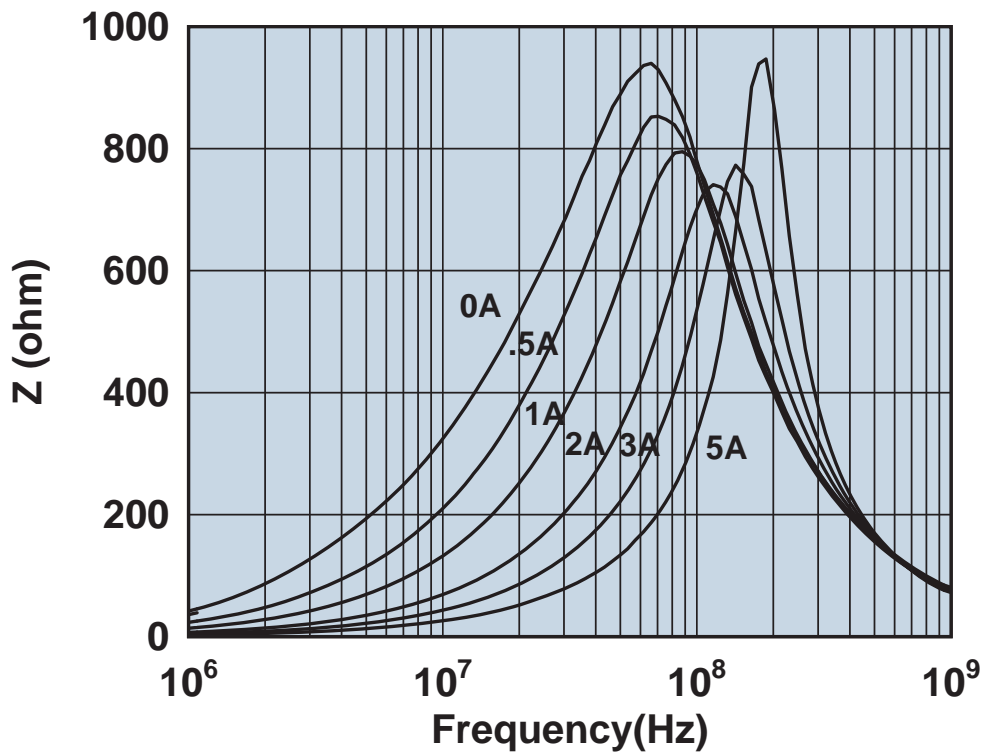

Impedance vs. frequency with dc bias.

2646101902

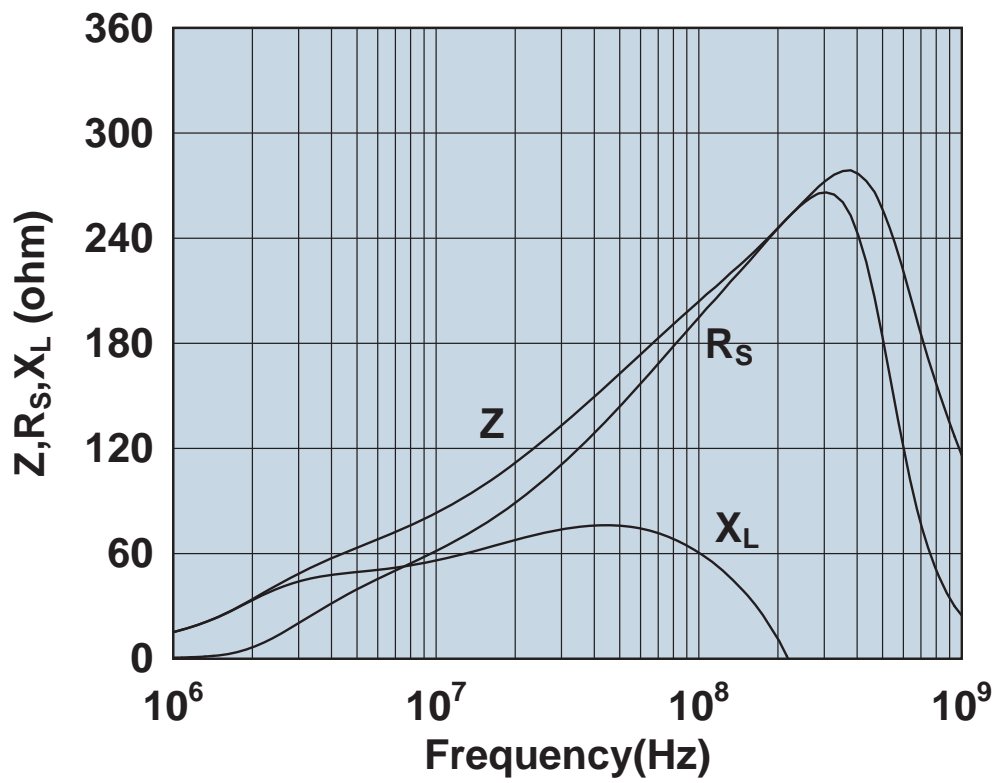

Impedance, reactance, and resistance vs. frequency.

2646102002

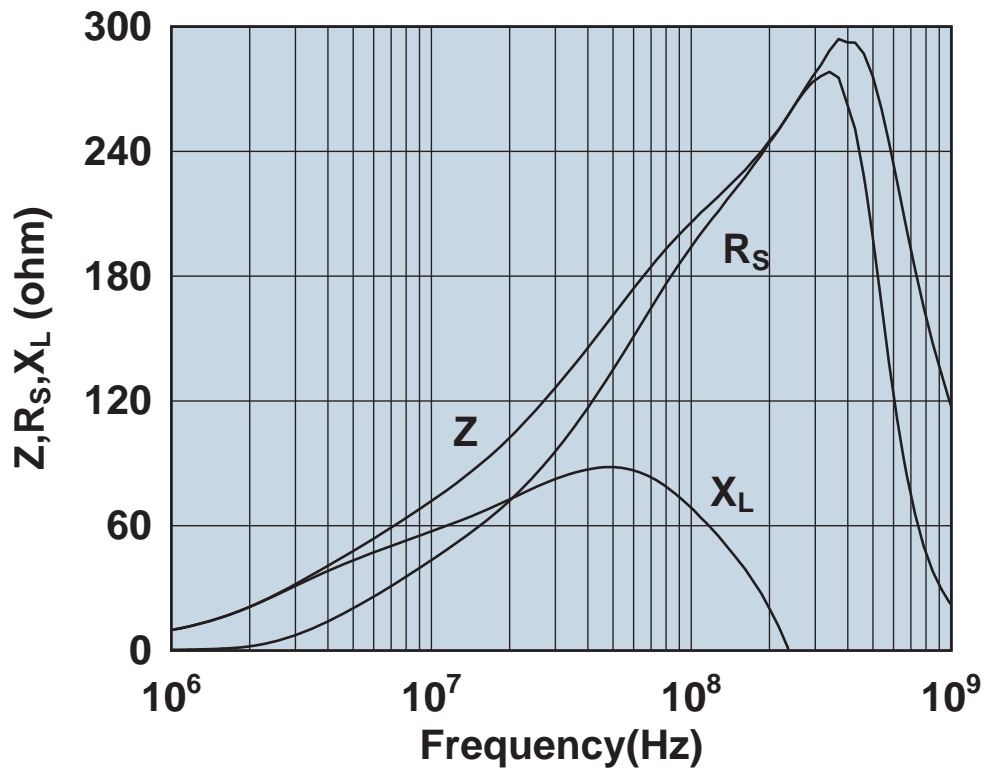

Impedance, reactance, and resistance vs. frequency.

2646102402

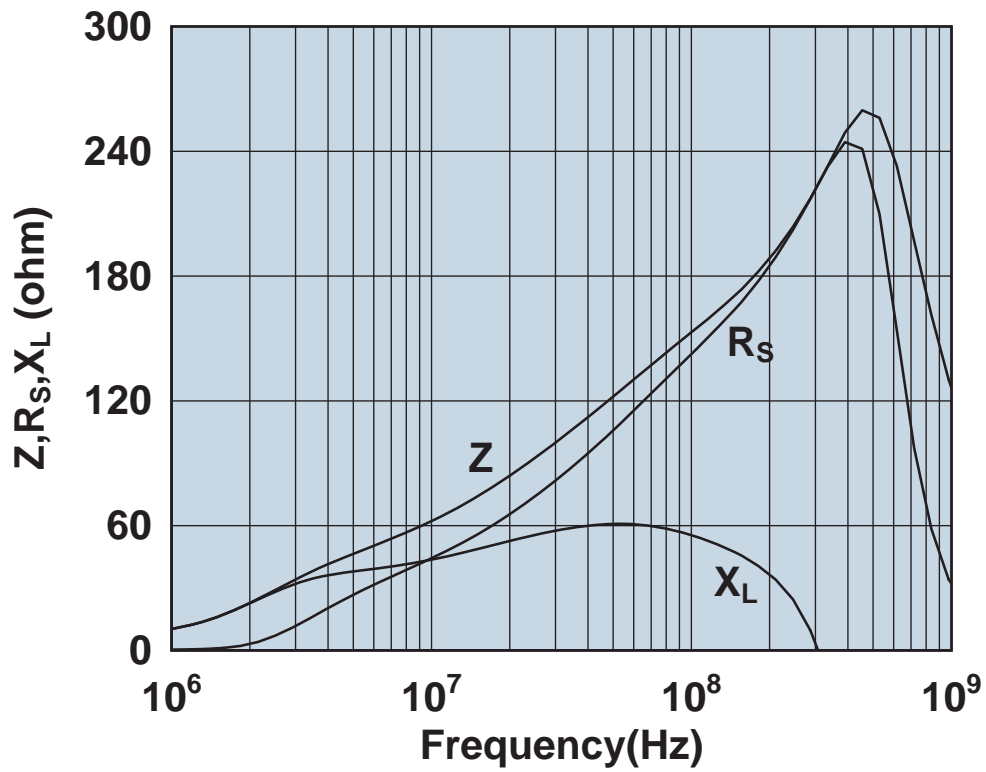

Impedance, reactance, and resistance vs. frequency.

2646103002

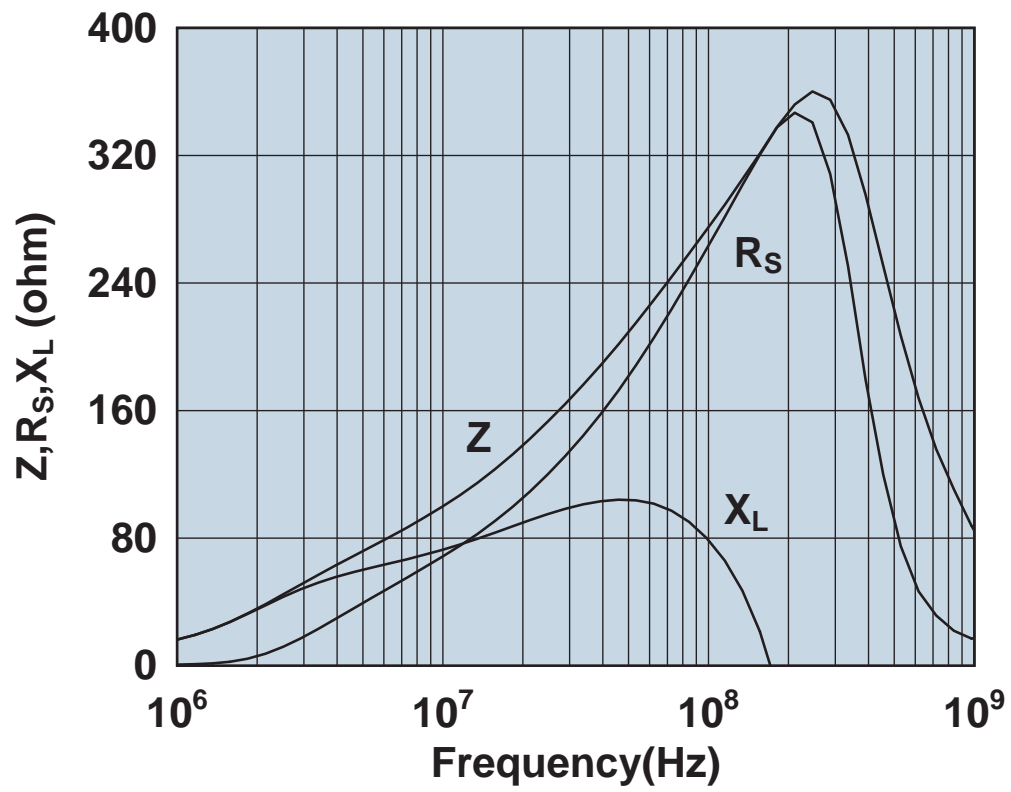

Impedance, reactance, and resistance vs. frequency.

2646164151

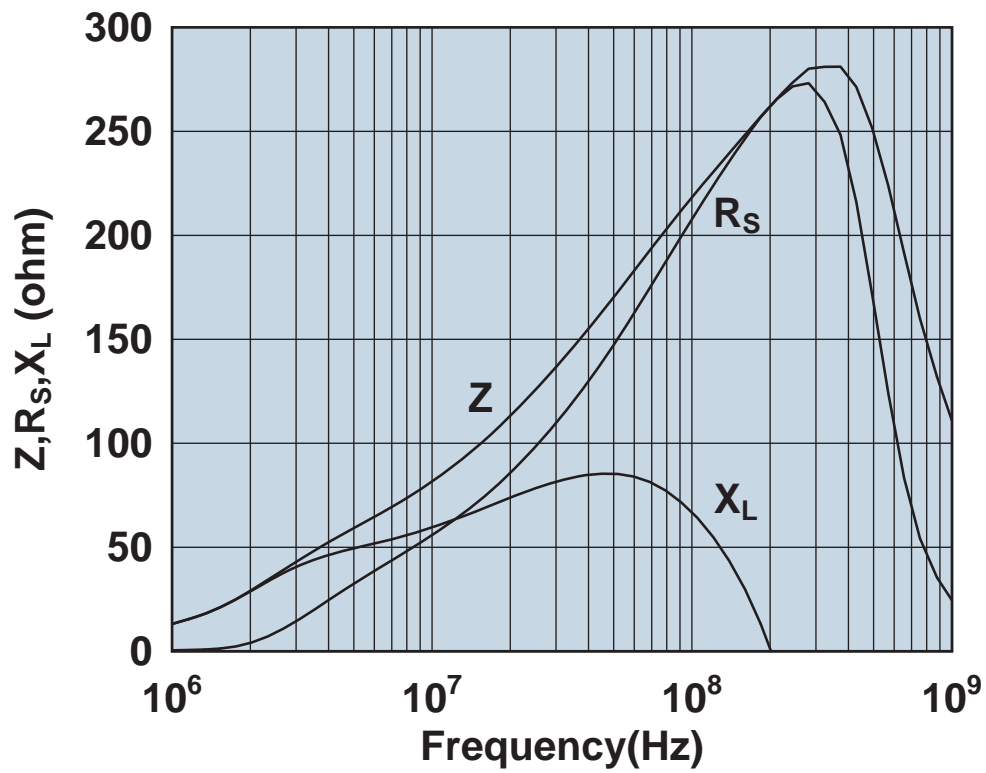

Impedance, reactance, and resistance vs. frequency.

2646164181

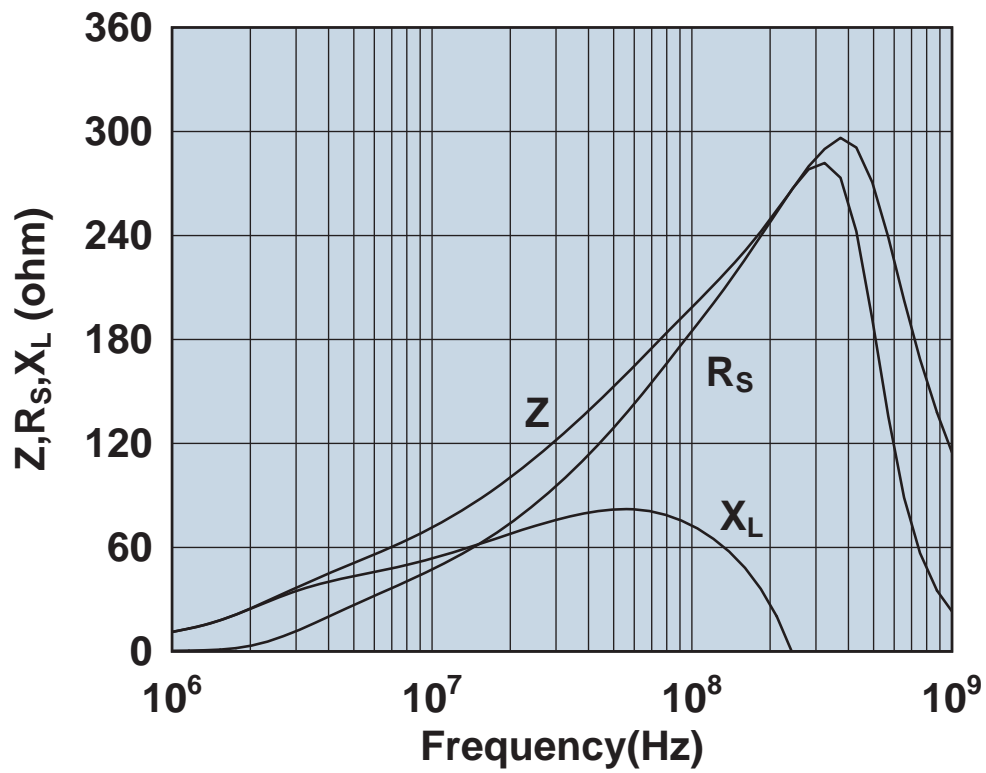

Impedance, reactance, and resistance vs. frequency.

2646164251

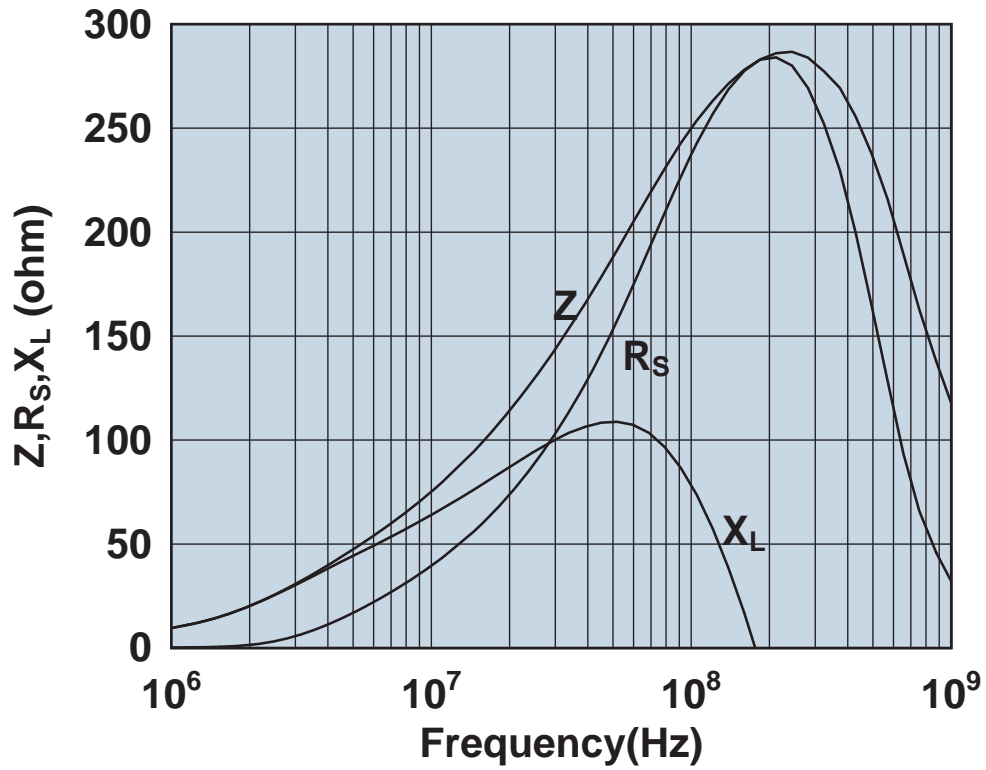

Impedance, reactance, and resistance vs. frequency.

2646164281

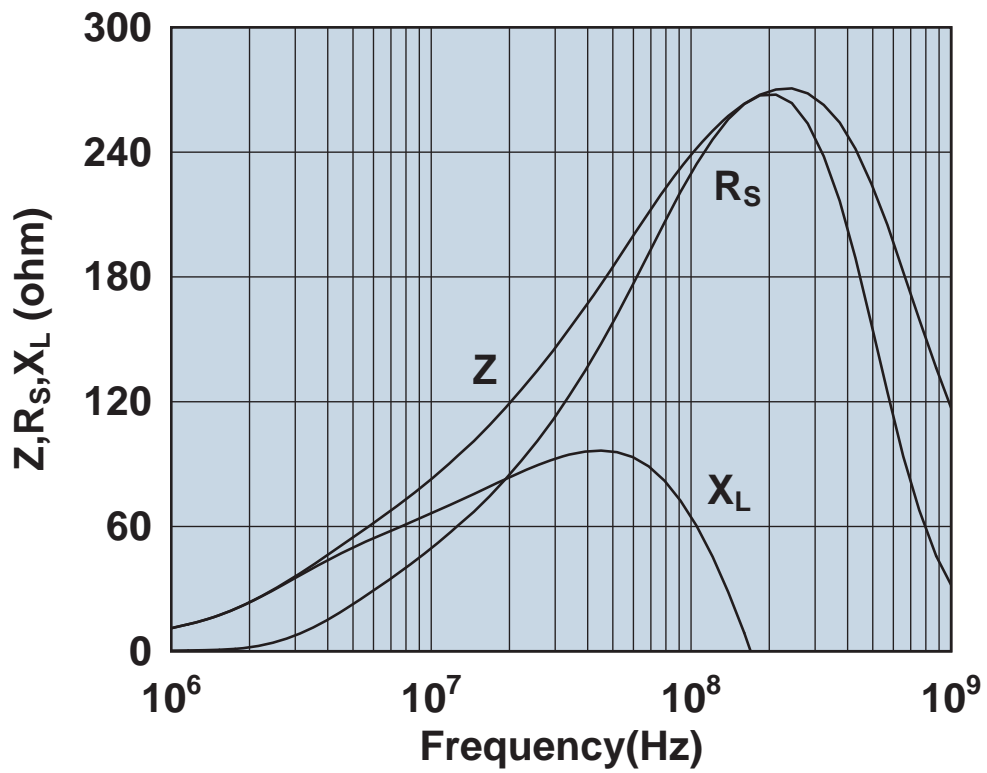

Impedance, reactance, and resistance vs. frequency.

2646164951

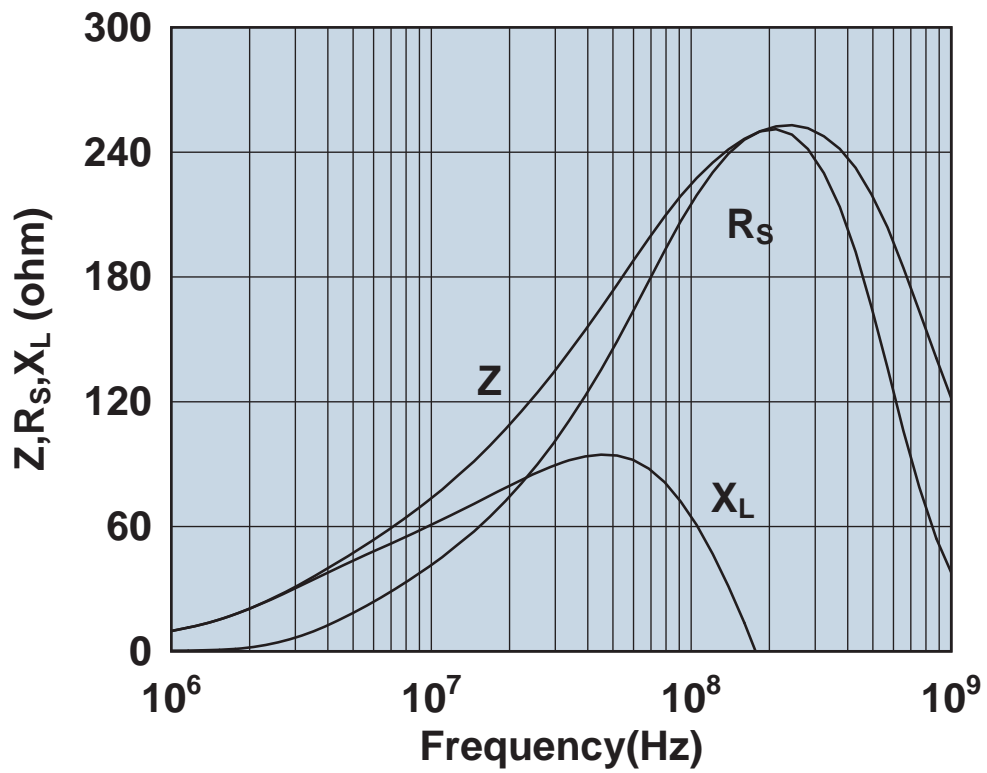

Impedance, reactance, and resistance vs. frequency.

2646167251

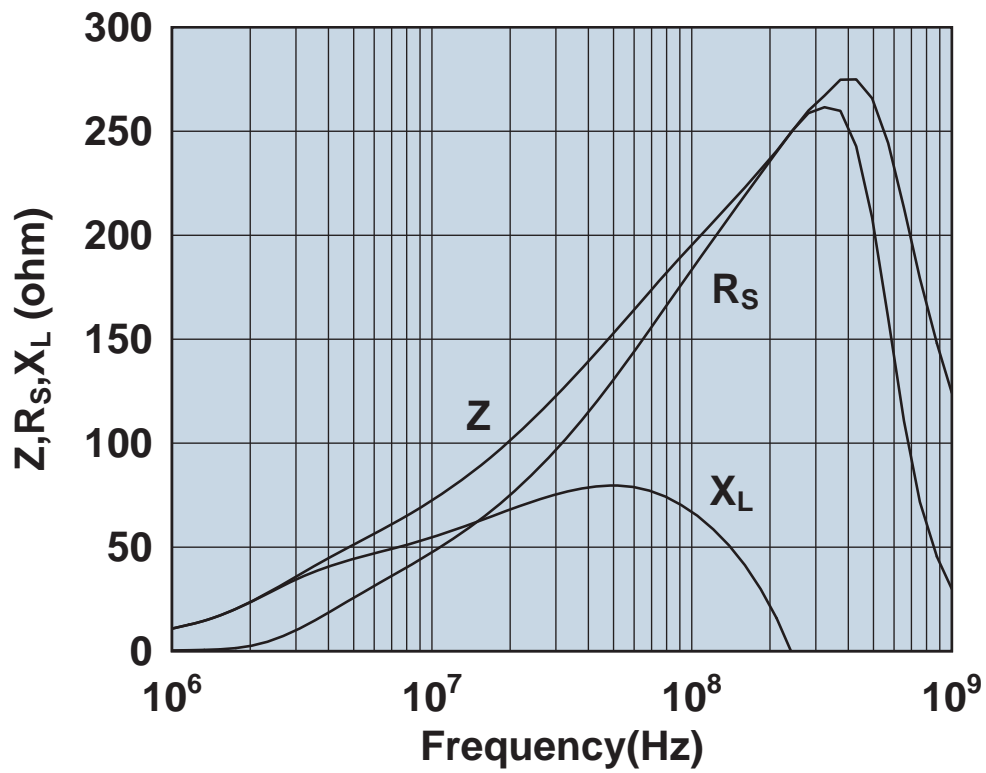

Impedance, reactance, and resistance vs. frequency.

2646167281

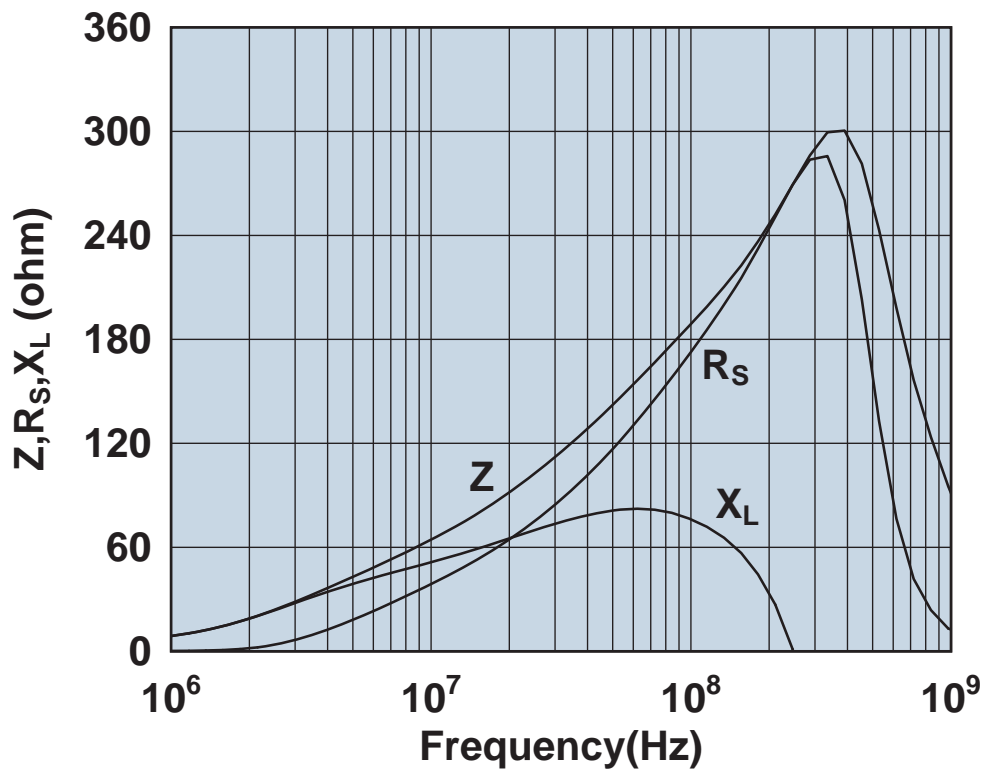

Impedance, reactance, and resistance vs. frequency.

2646173551

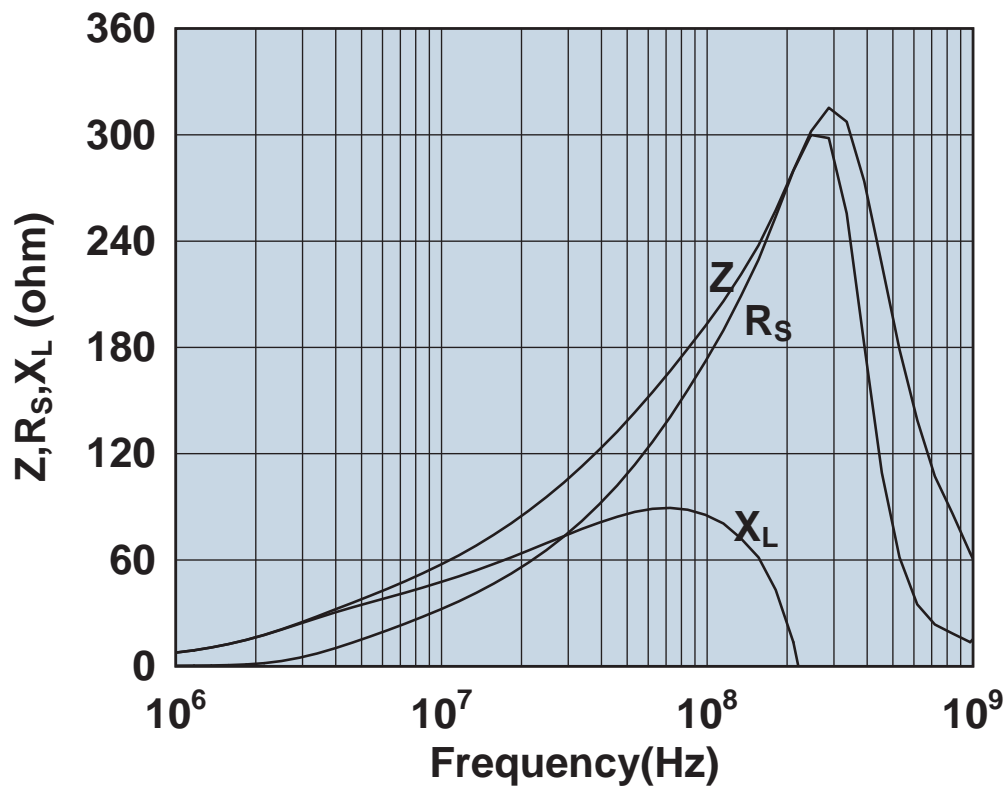

Impedance, reactance, and resistance vs. frequency.

2646173951

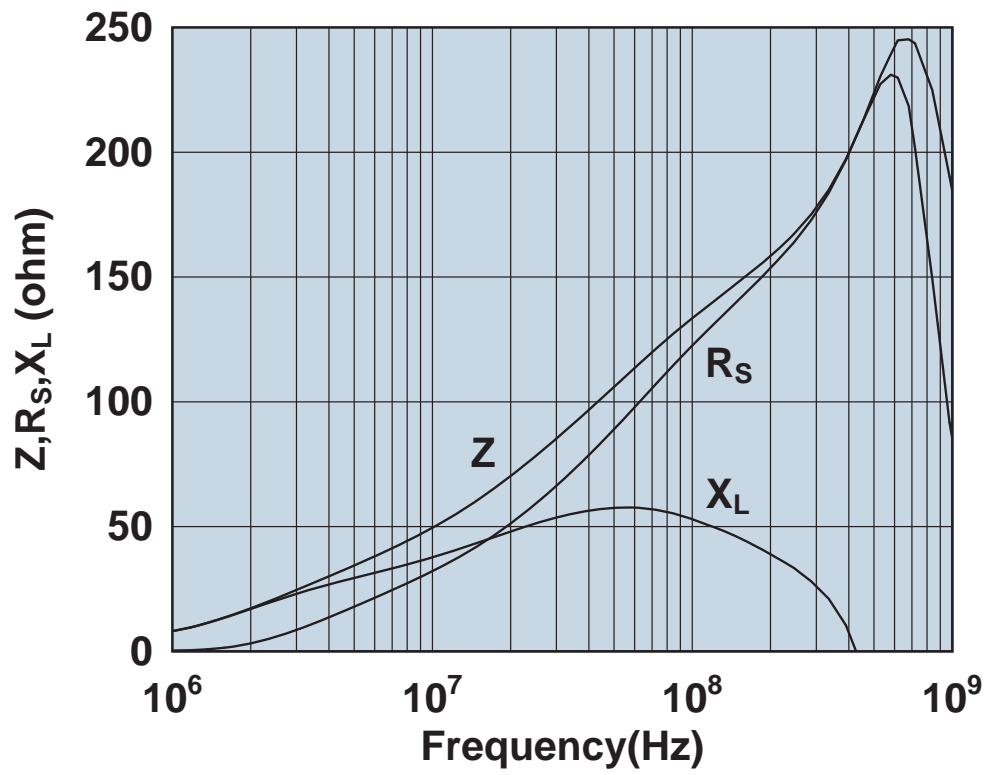

Impedance, reactance, and resistance vs. frequency.

2646176451

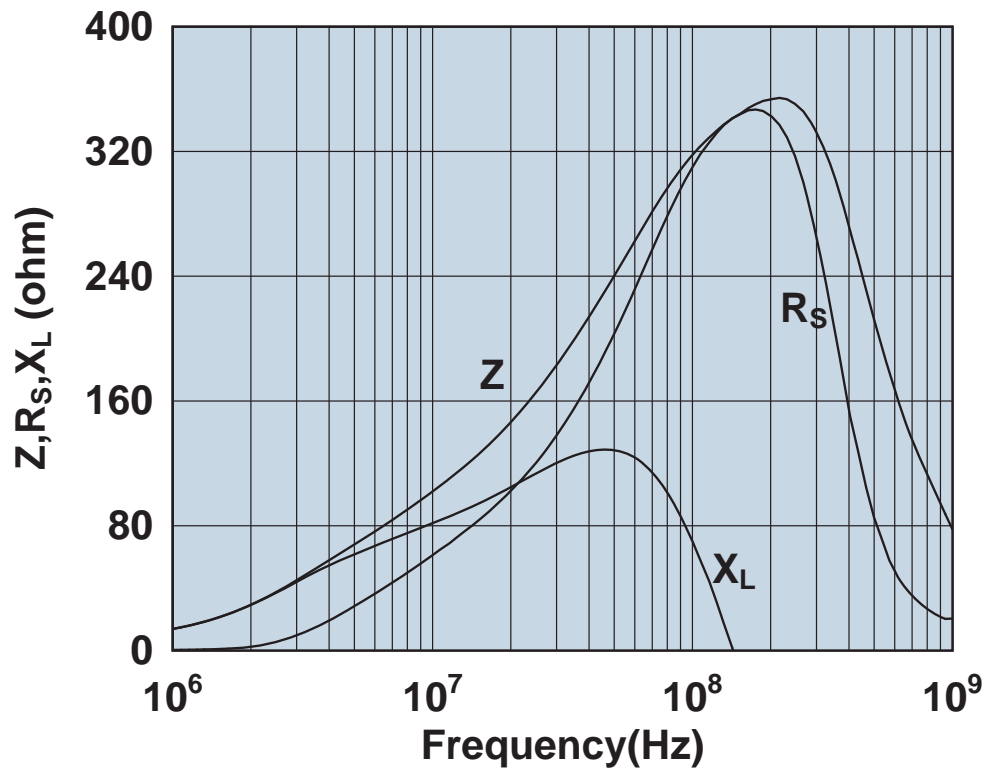

Impedance, reactance, and resistance vs. frequency.

2646177081

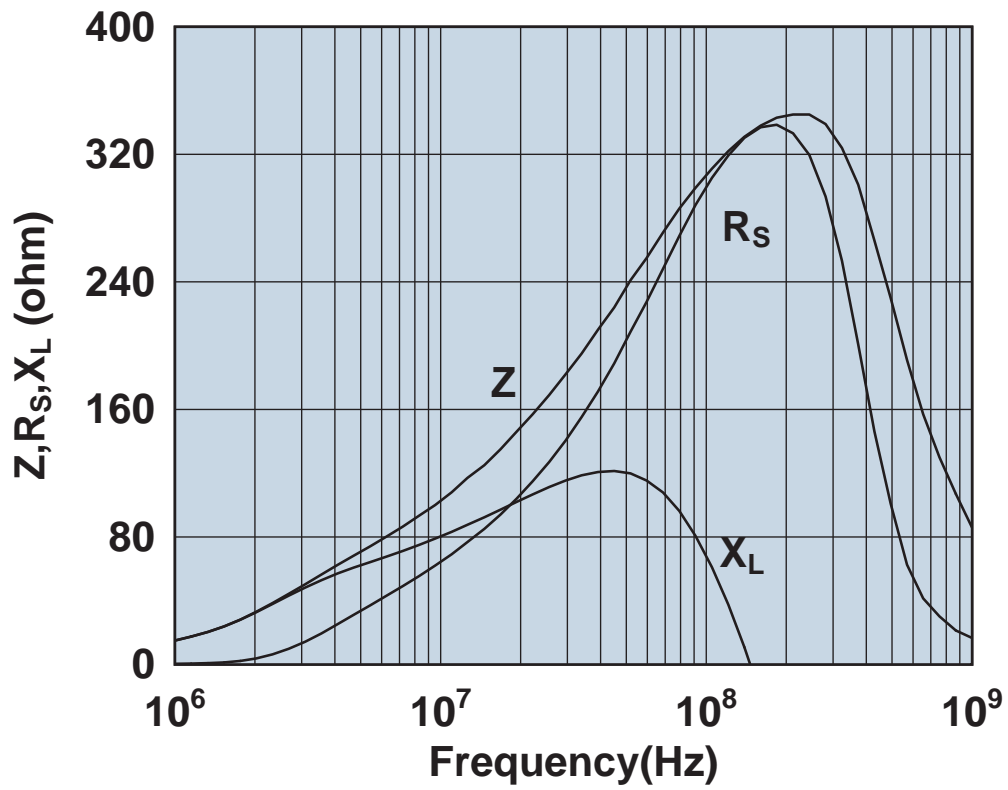

Impedance, reactance, and resistance vs. frequency.

2646480002

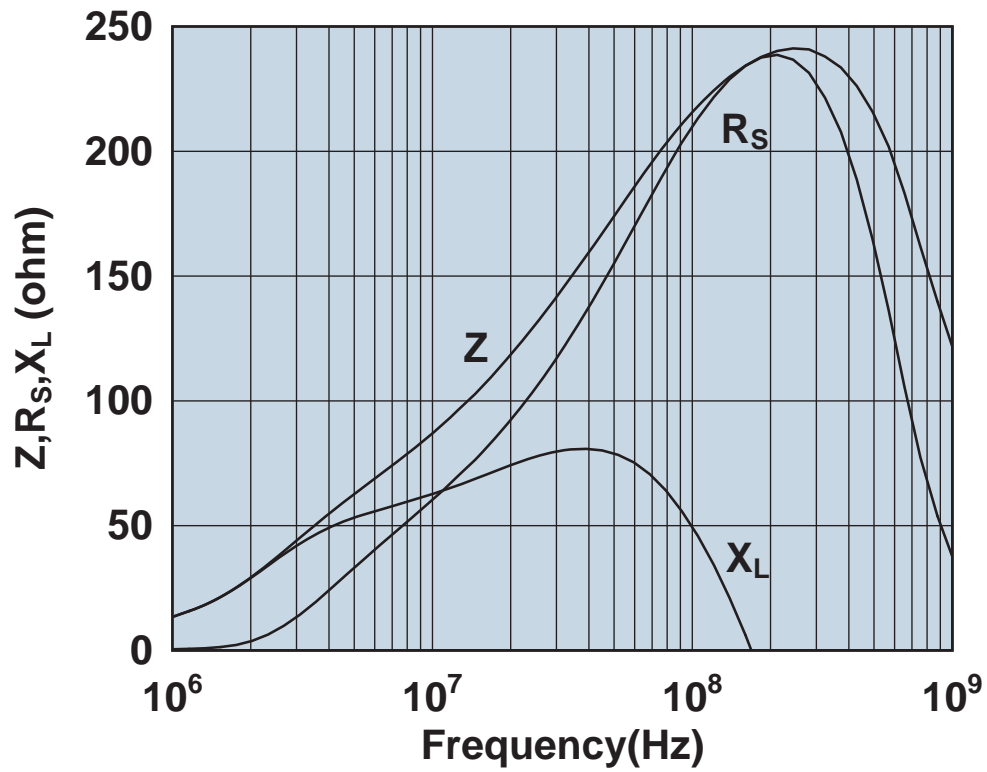

Impedance, reactance, and resistance vs. frequency.

2646480102

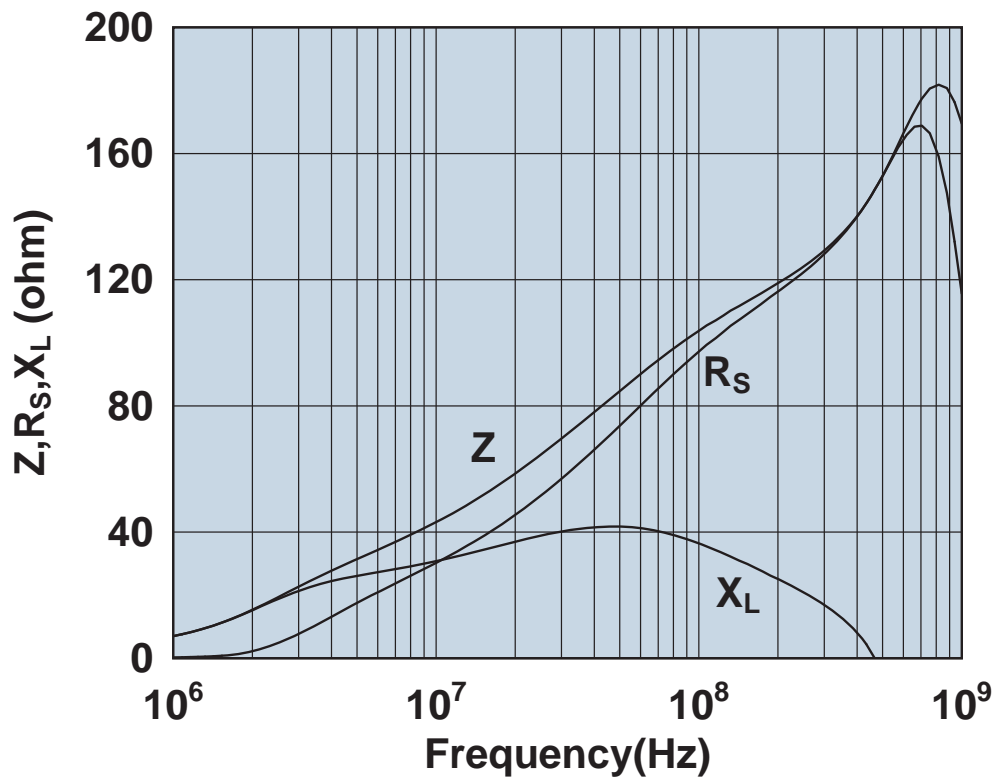

Impedance, reactance, and resistance vs. frequency.

2646540002

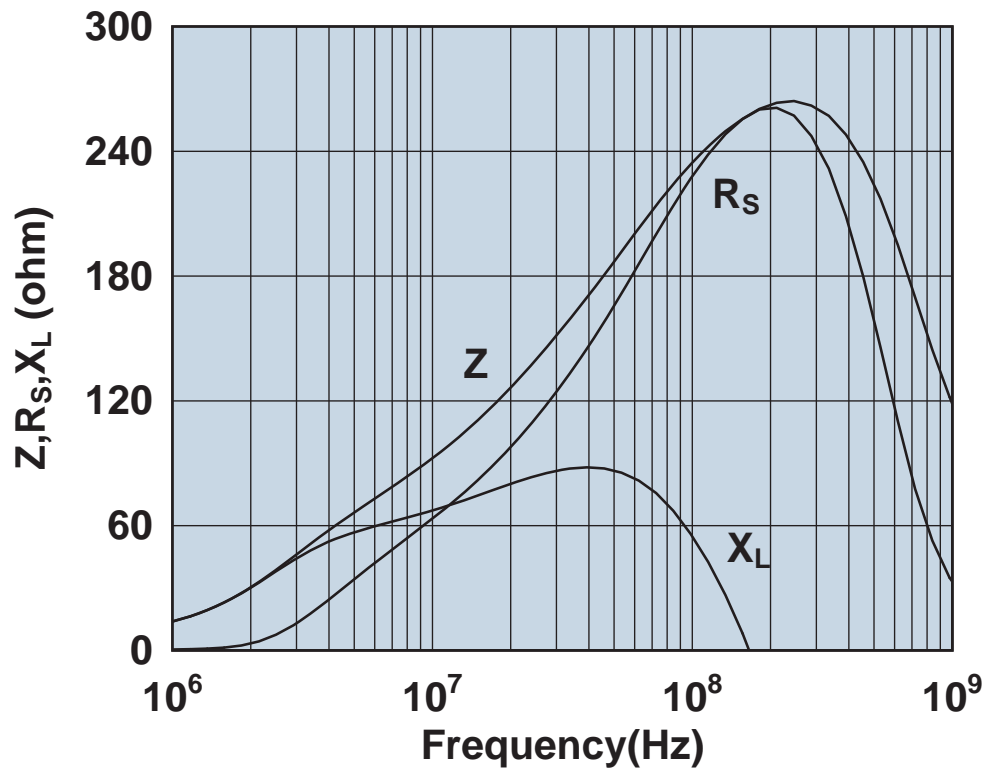

Impedance, reactance, and resistance vs. frequency.

2646540202

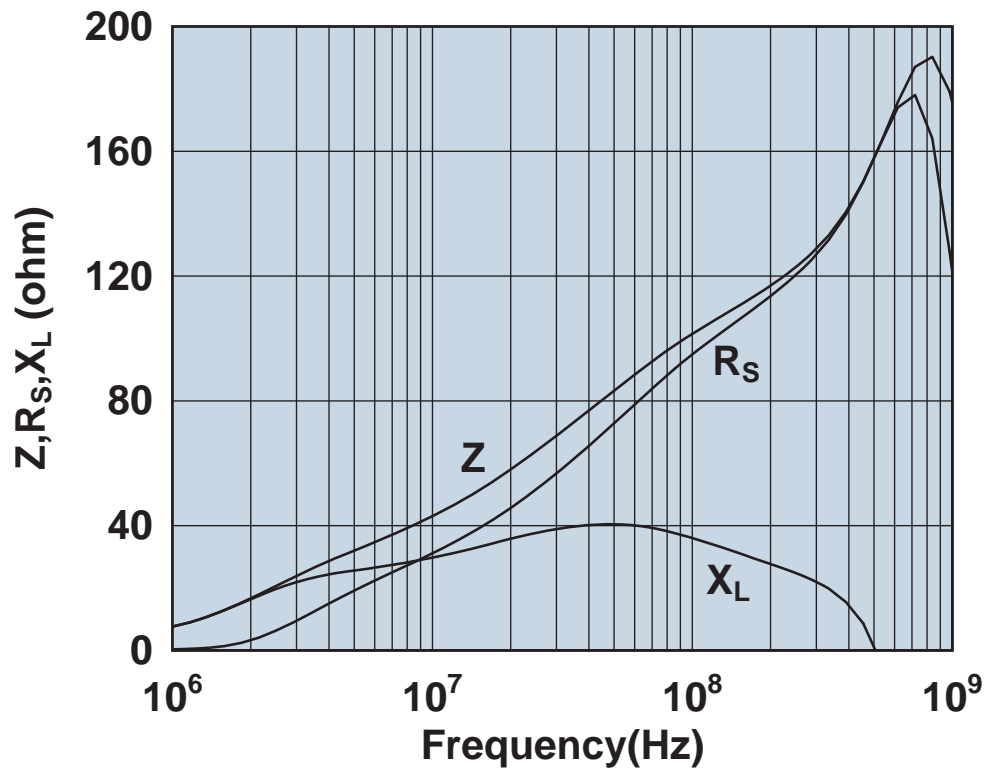

Impedance, reactance, and resistance vs. frequency.

2646625002

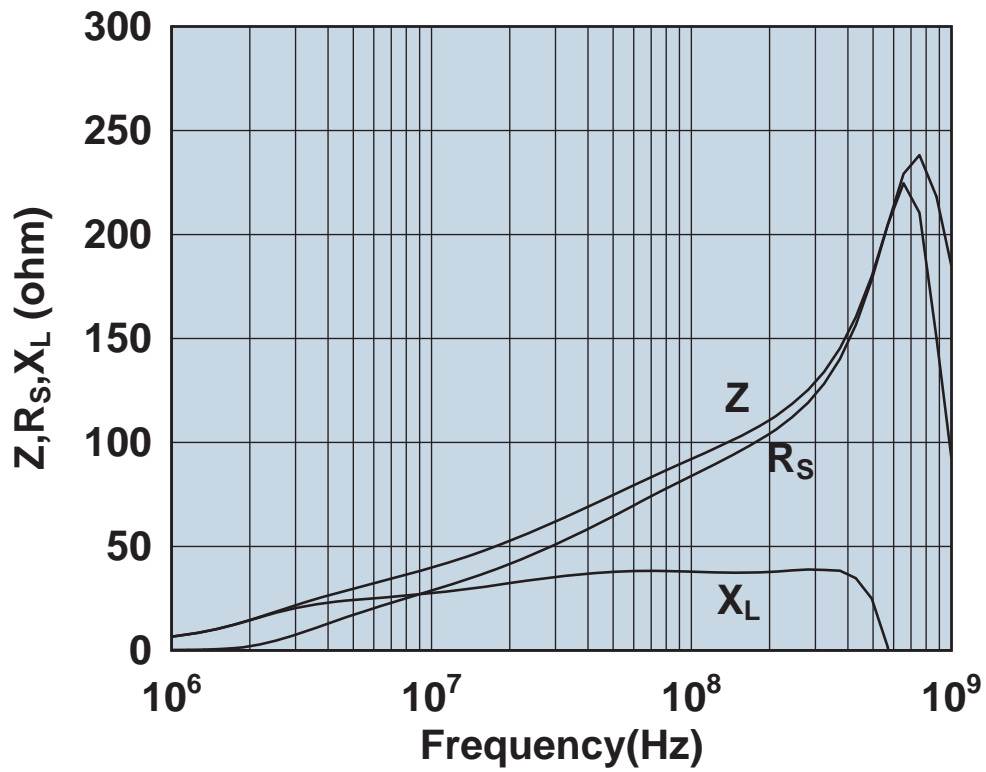

Impedance, reactance, and resistance vs. frequency.

2646625102

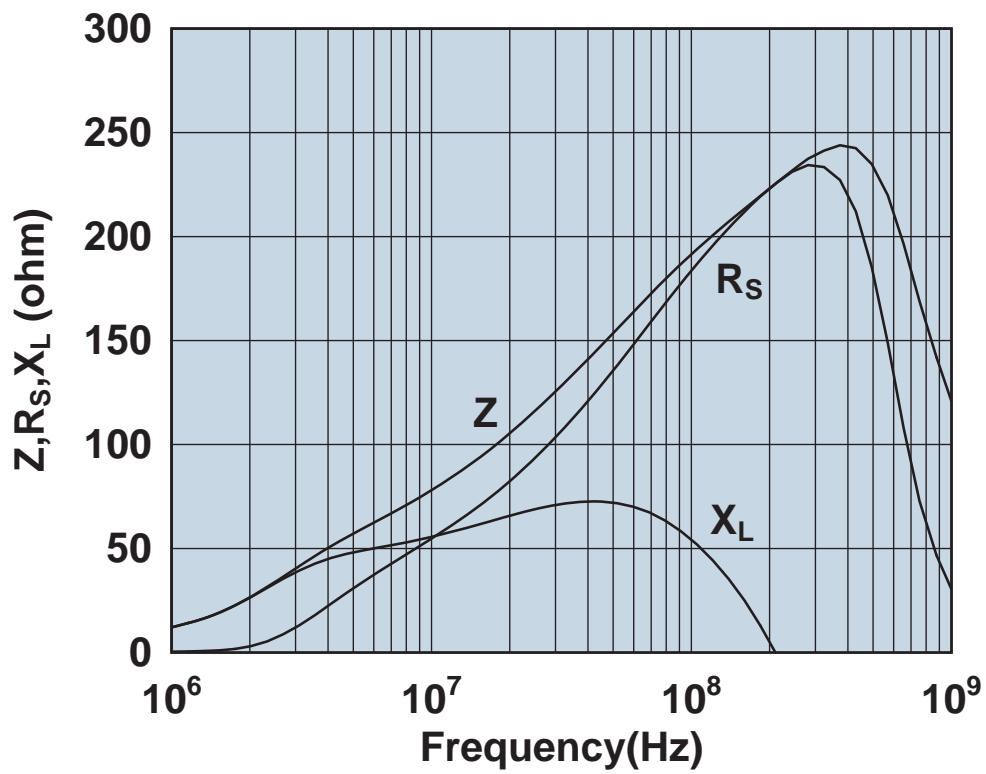

Impedance, reactance, and resistance vs. frequency.

2646625202

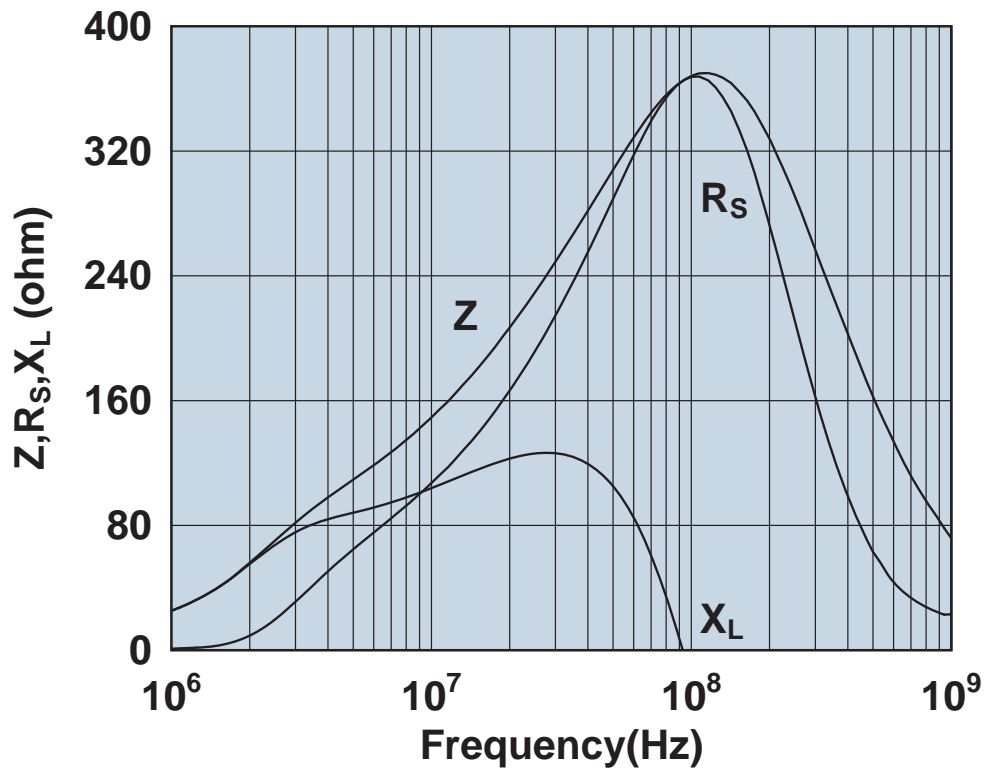

Impedance, reactance, and resistance vs. frequency.

2646626202

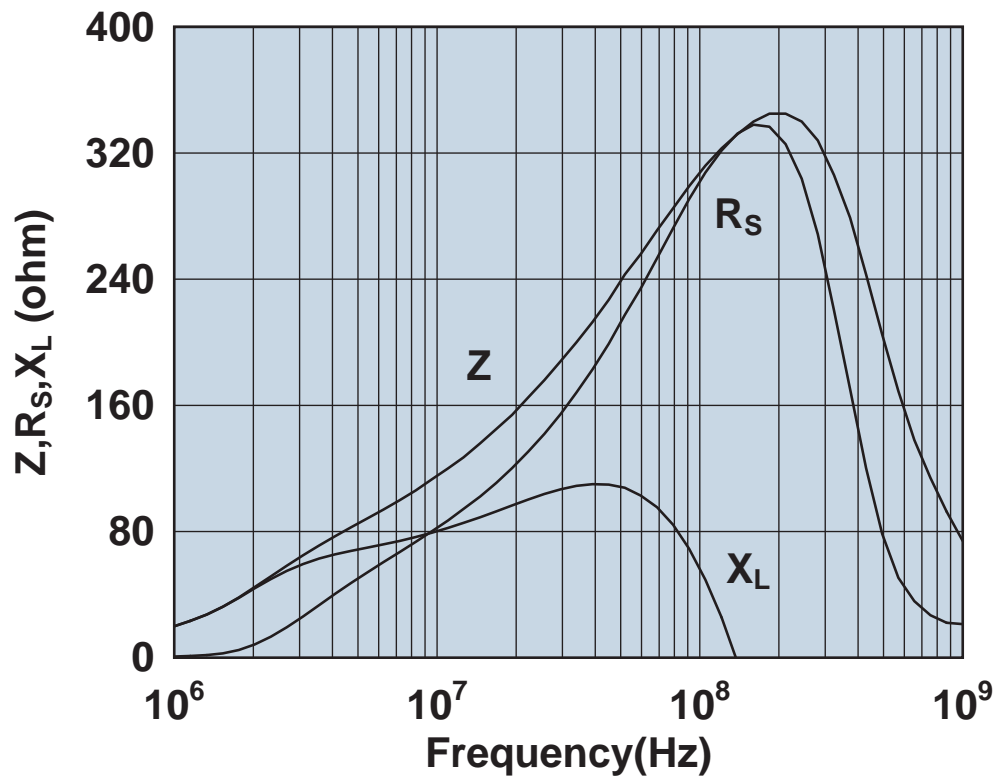

Impedance, reactance, and resistance vs. frequency.

2646665702

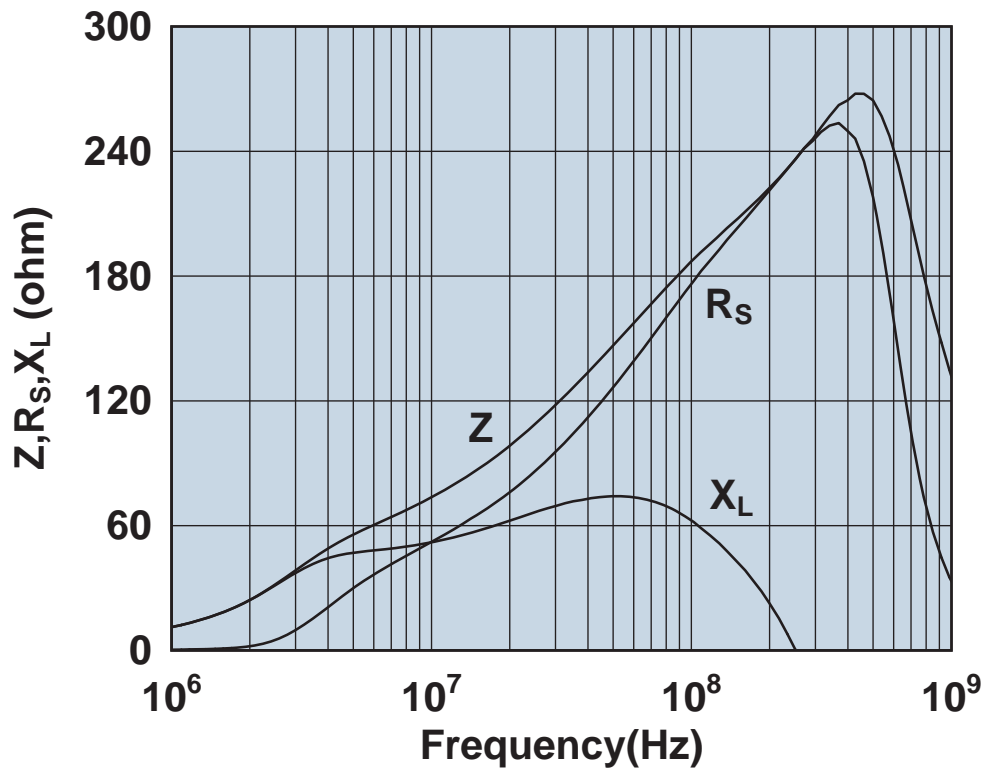

Impedance, reactance, and resistance vs. frequency.

2646665802

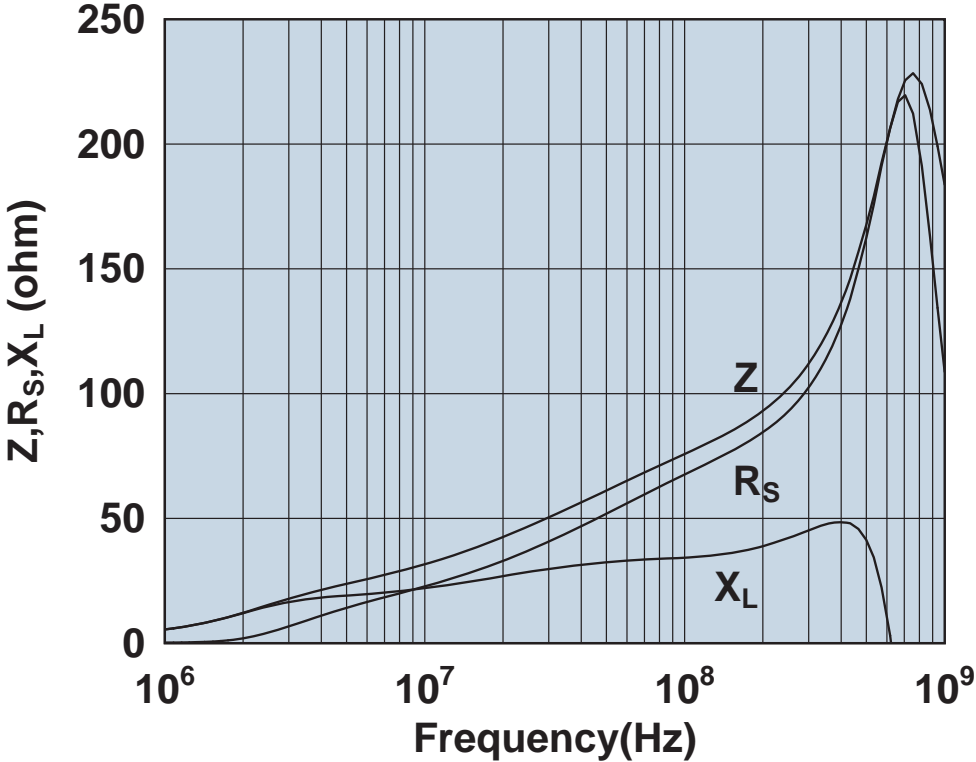

Impedance, reactance, and resistance vs. frequency.

2646803802

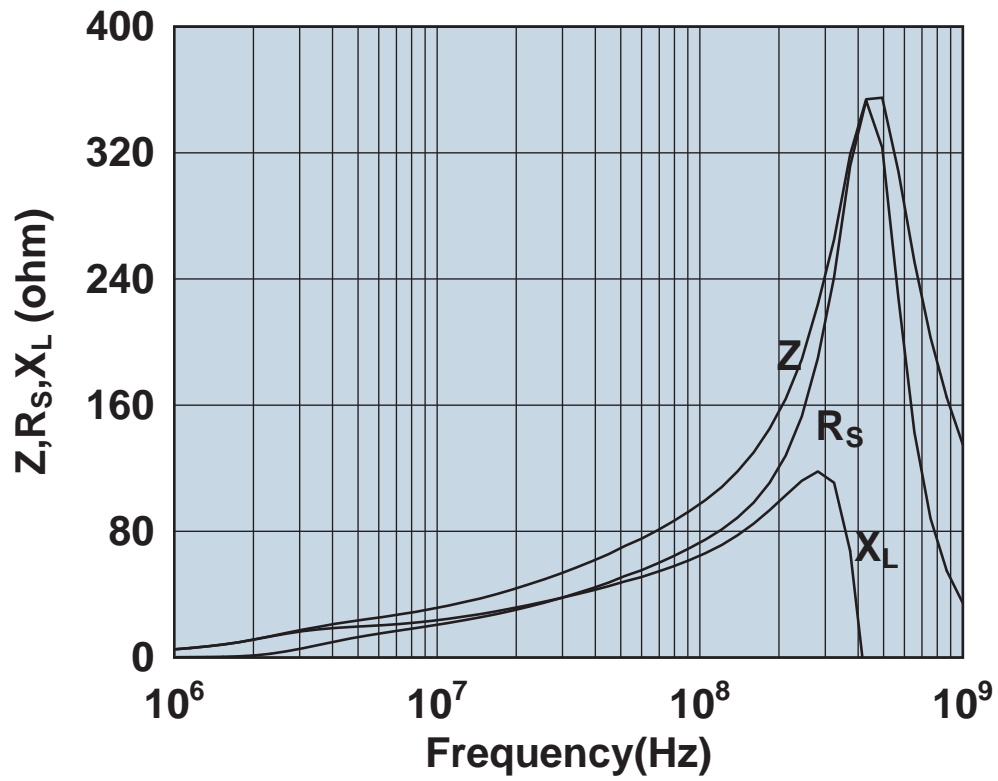

Impedance, reactance, and resistance vs. frequency.

2646804502

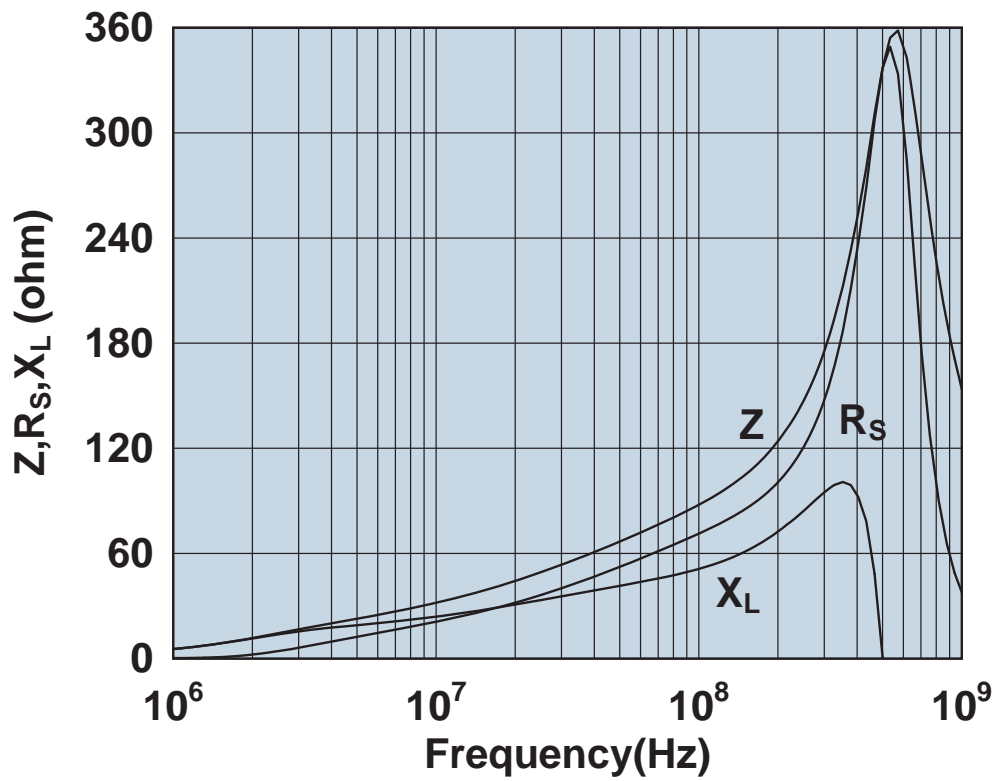

Impedance, reactance, and resistance vs. frequency.

2661000101

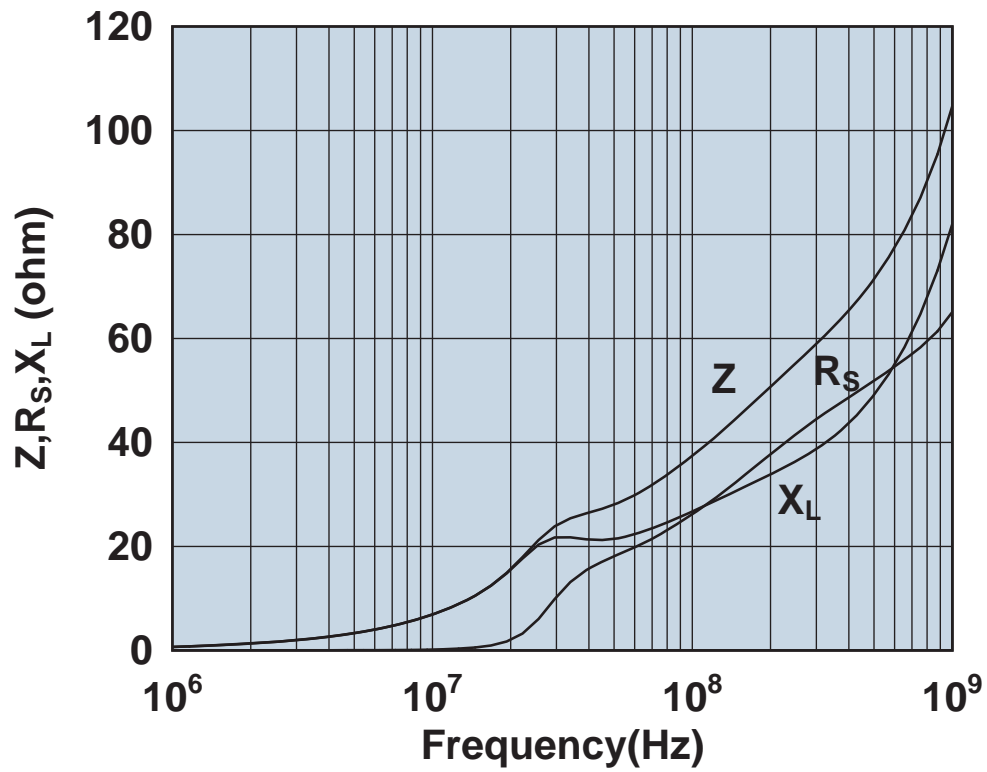

Impedance, reactance, and resistance vs. frequency.

2661000301

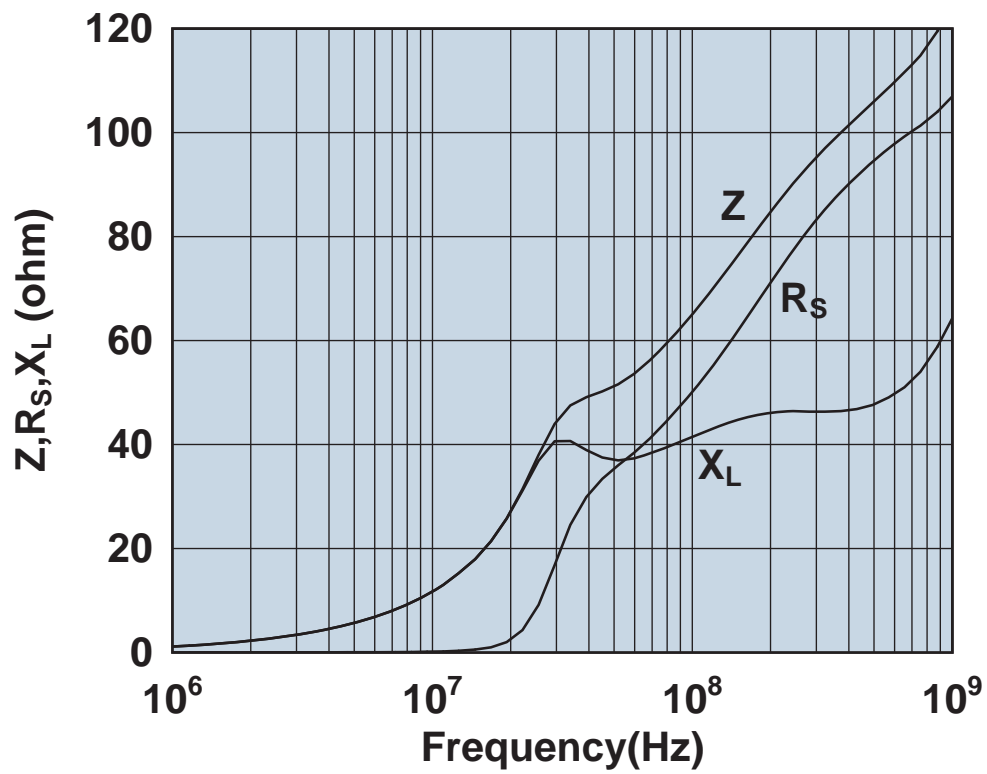

Impedance, reactance, and resistance vs. frequency.

2661000701

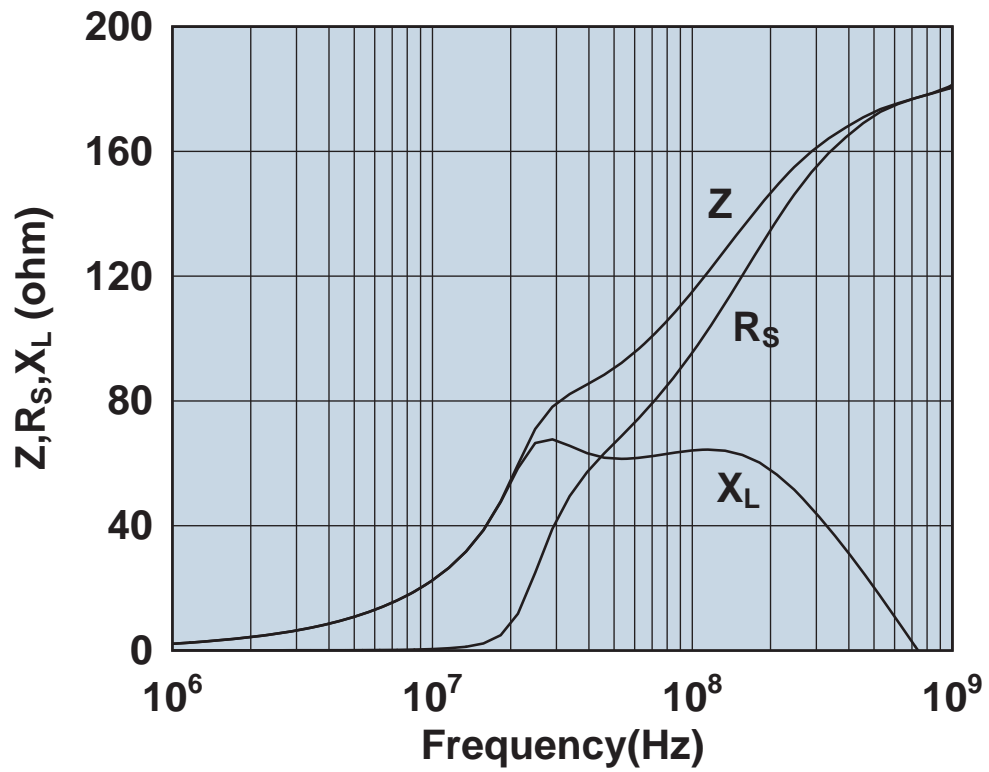

Impedance, reactance, and resistance vs. frequency.

2661000801

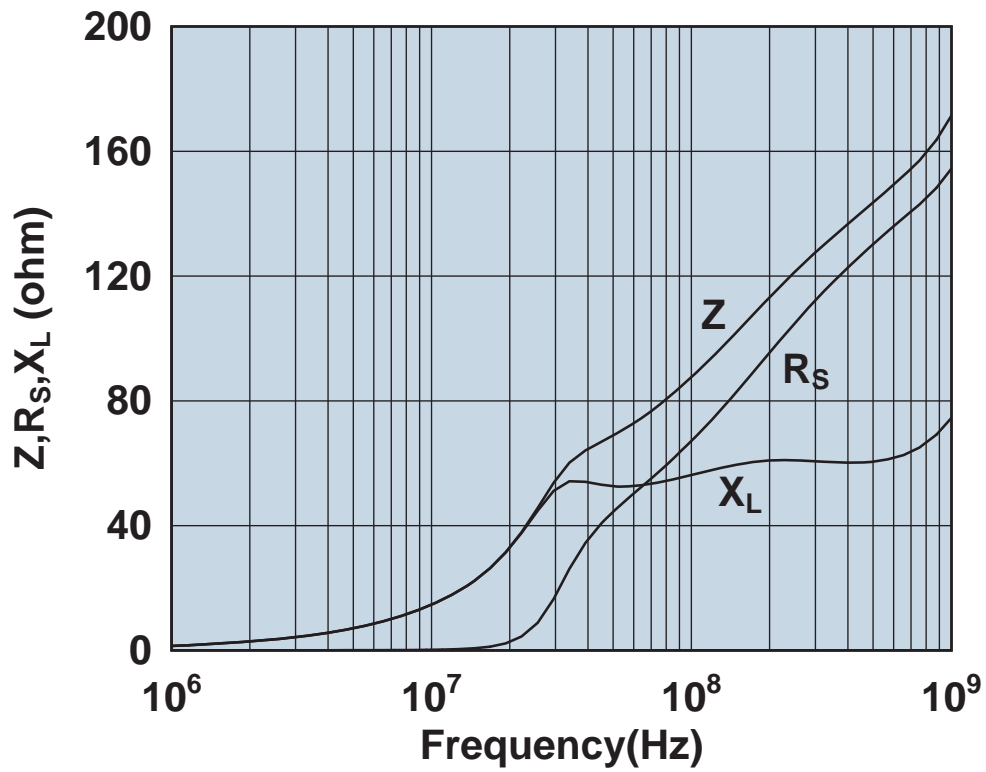

Impedance, reactance, and resistance vs. frequency.

2661002201

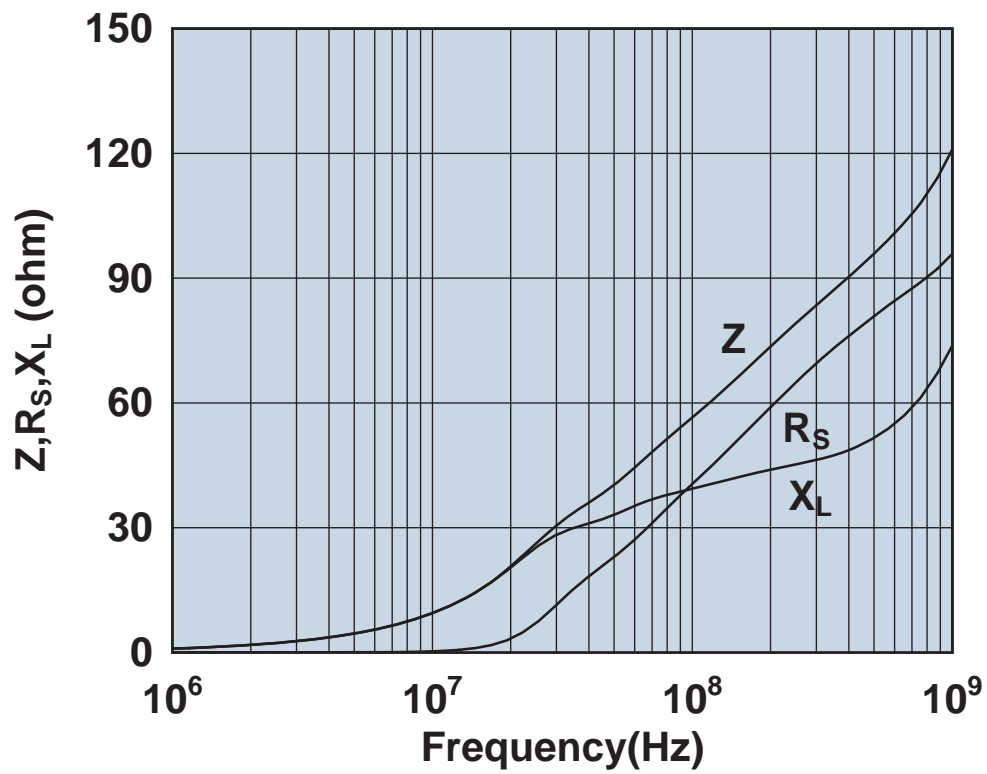

Impedance, reactance, and resistance vs. frequency.

2661002402

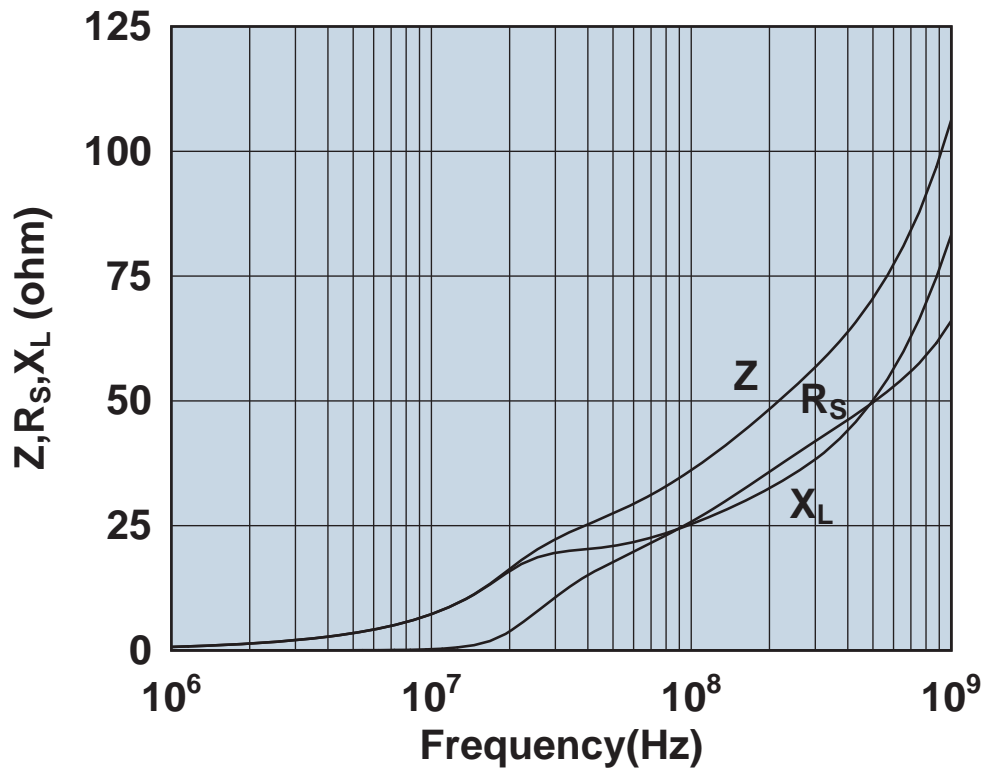

Impedance, reactance, and resistance vs. frequency.

2661005701

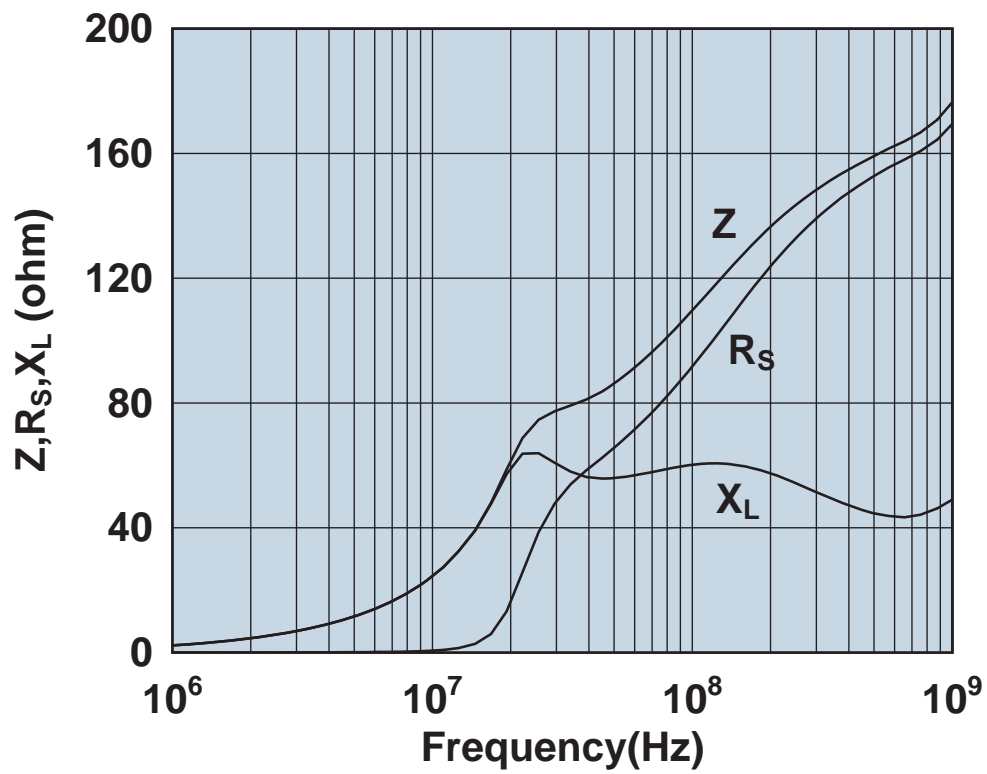

Impedance, reactance, and resistance vs. frequency.

2661021801

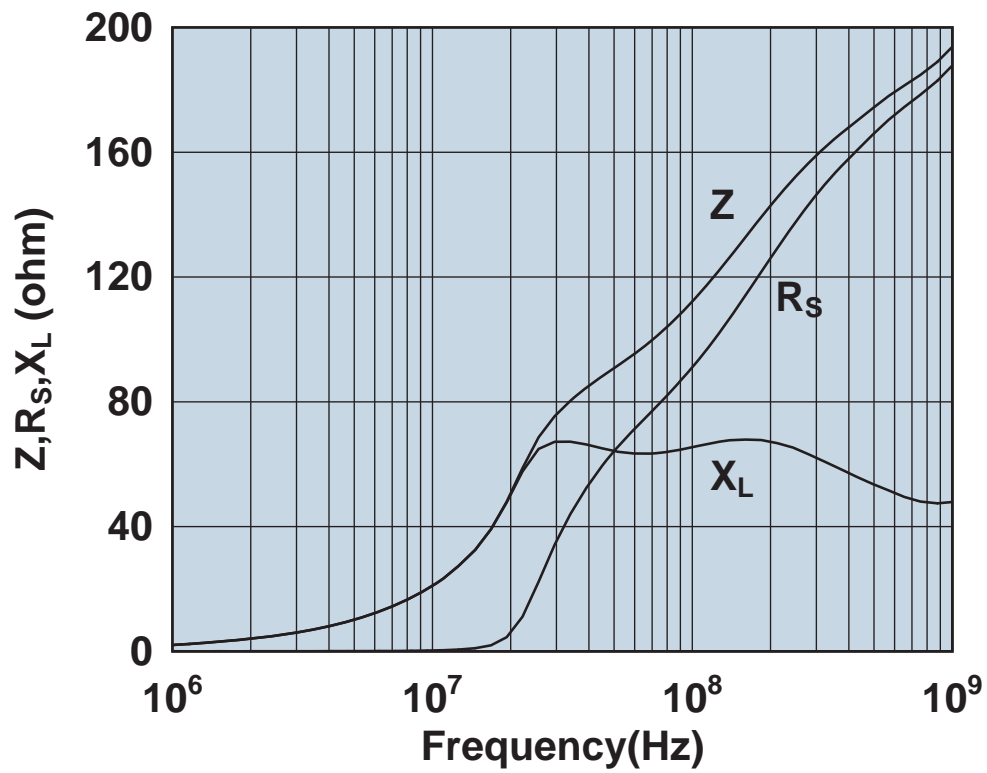

Impedance, reactance, and resistance vs. frequency.

2661022401

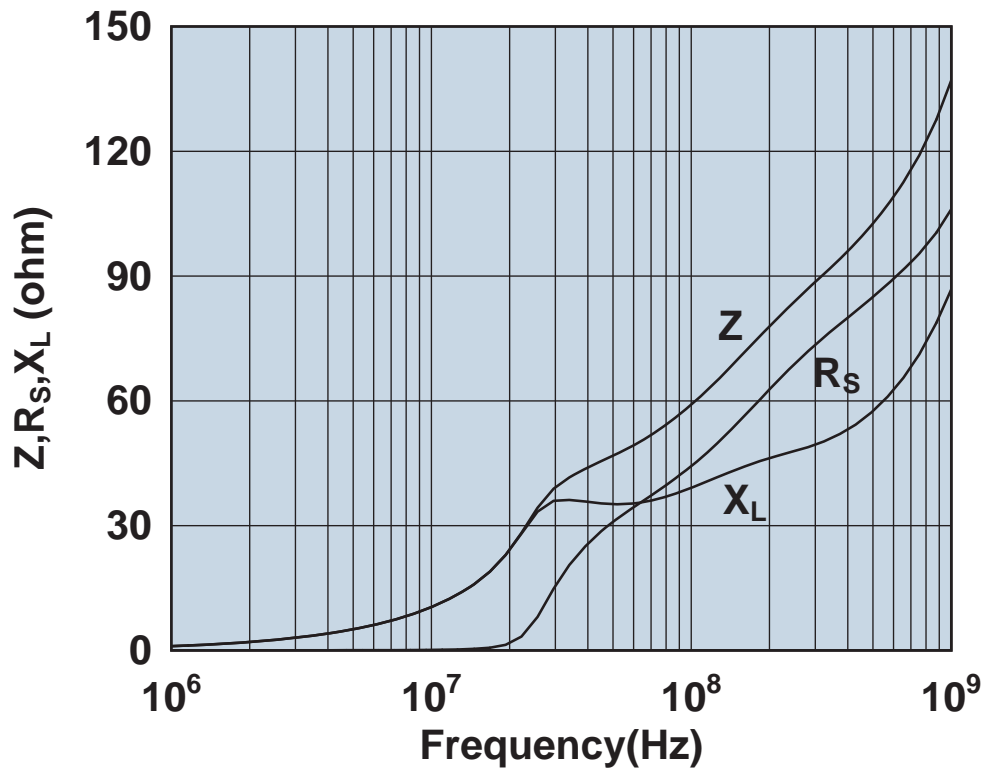

Impedance, reactance, and resistance vs. frequency.

2661023801

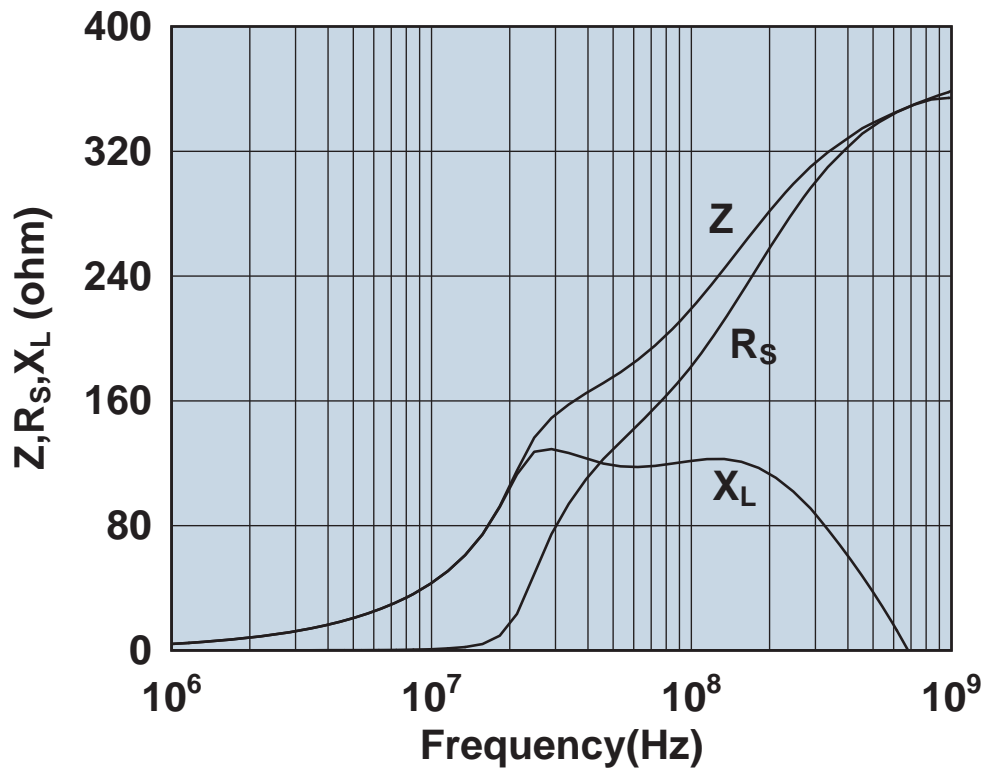

Impedance, reactance, and resistance vs. frequency.

2661030101

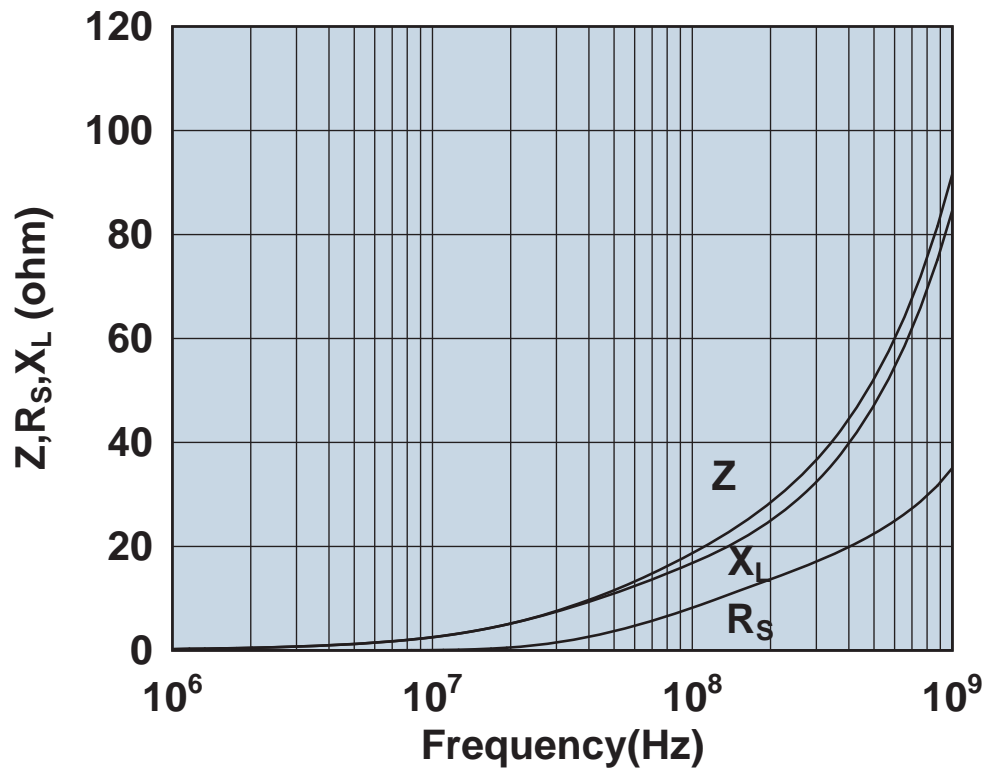

Impedance, reactance, and resistance vs. frequency.

2661102002

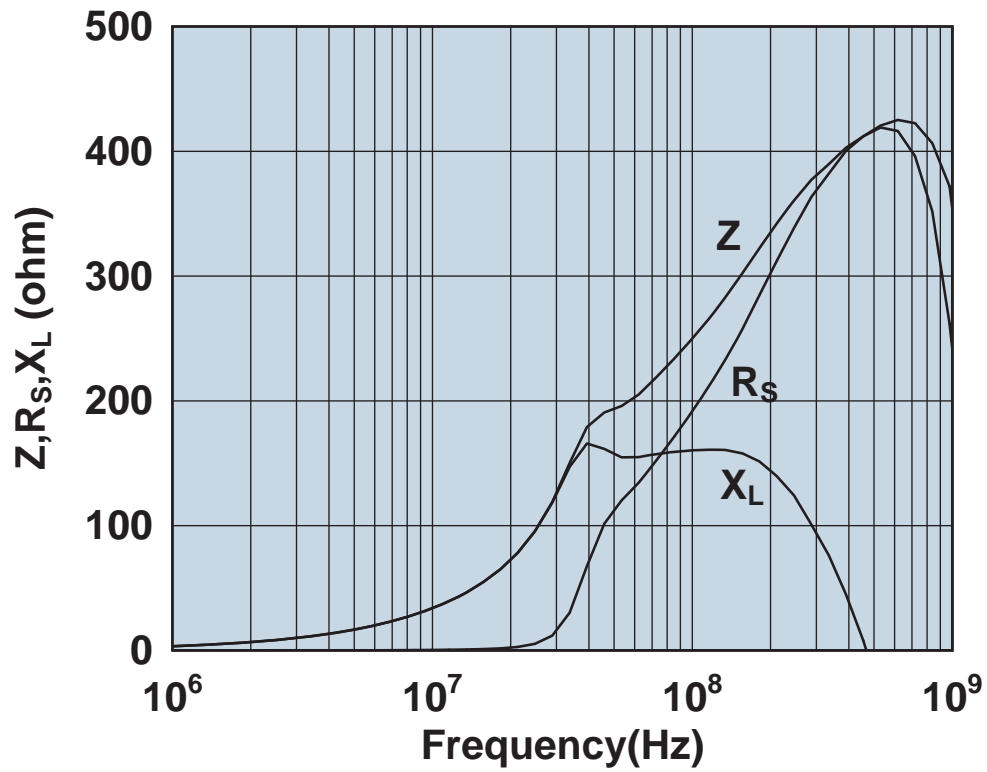

Impedance, reactance, and resistance vs. frequency.

2661102402

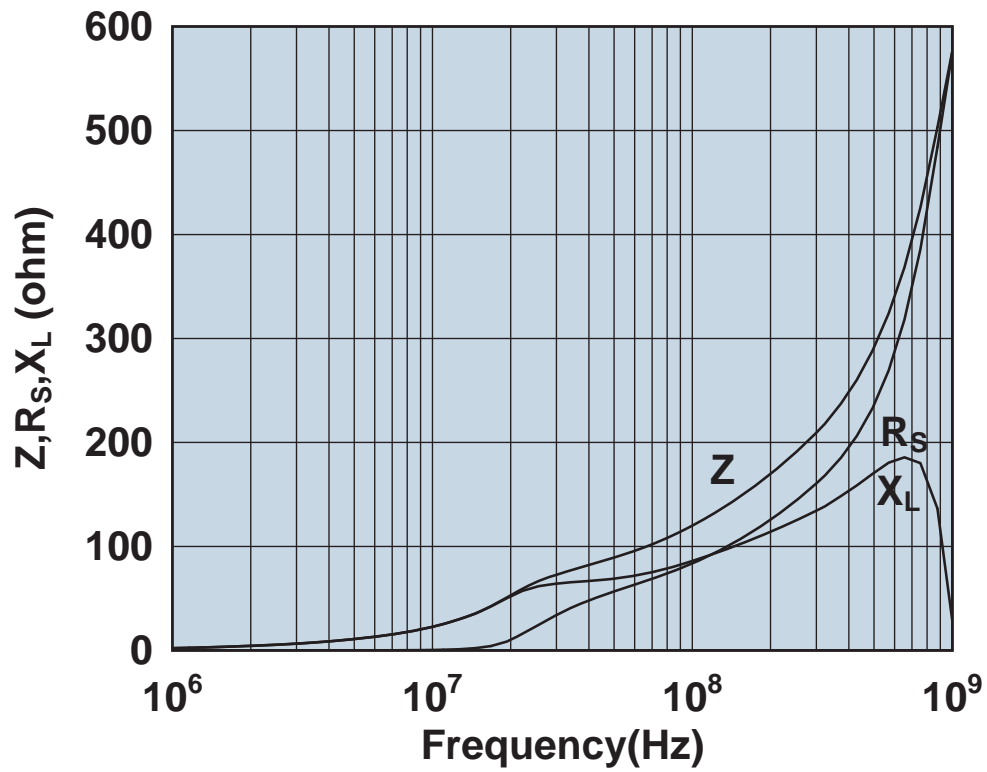

Impedance, reactance, and resistance vs. frequency.

2661164181

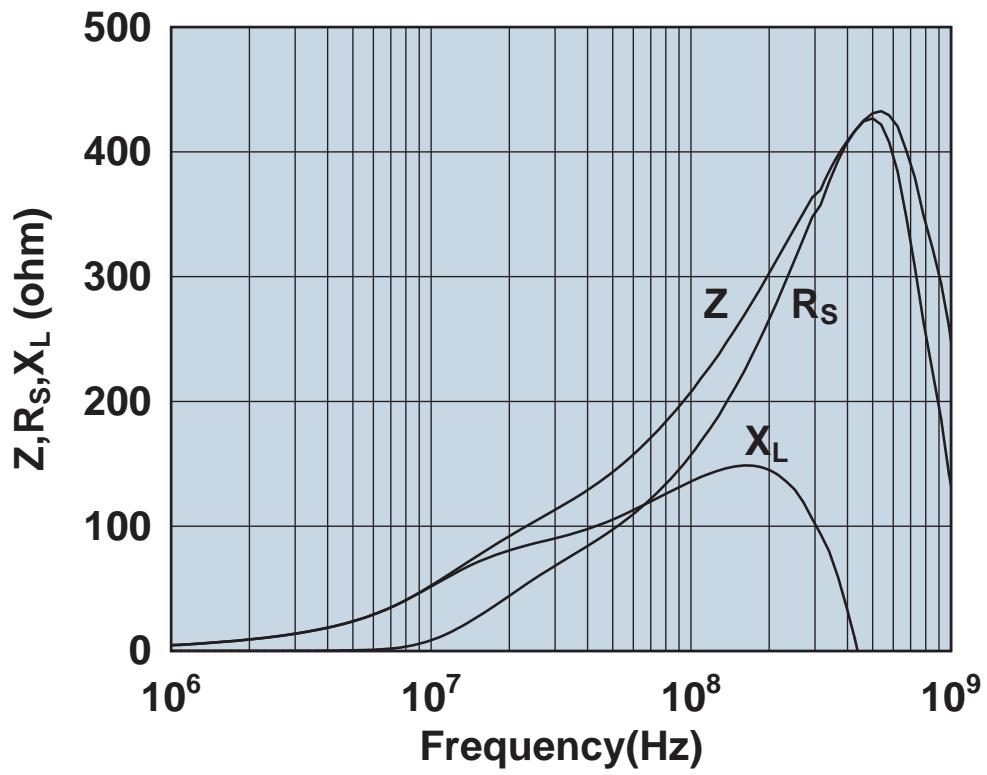

Impedance, reactance, and resistance vs. frequency.

2661164281

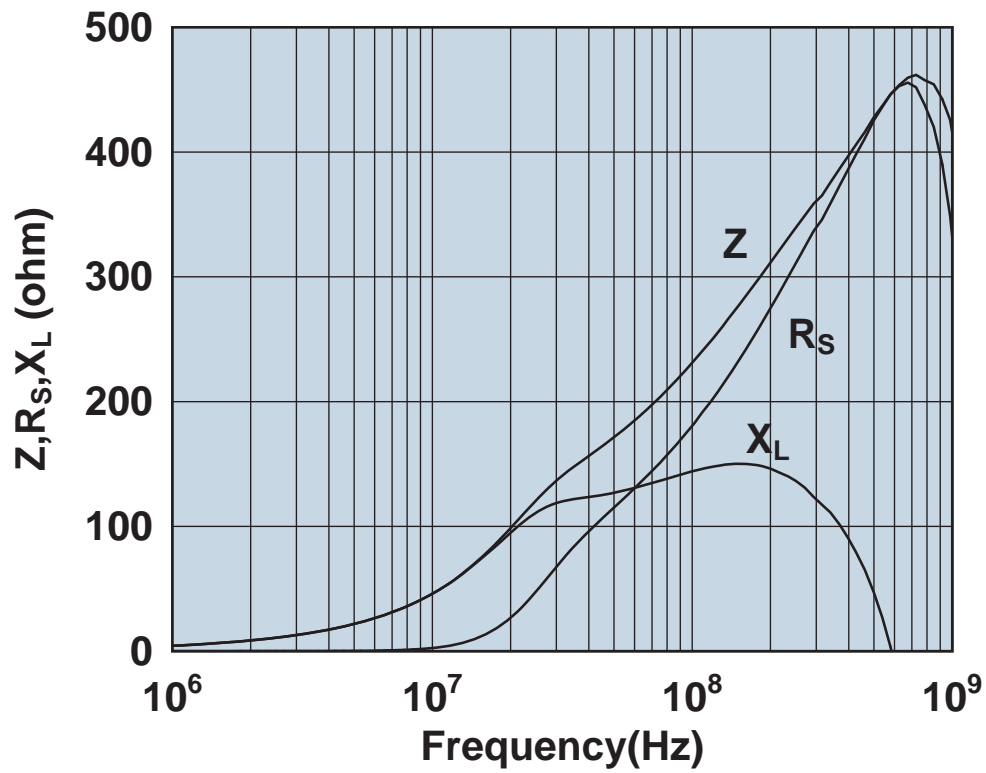

Impedance, reactance, and resistance vs. frequency.

2661164951

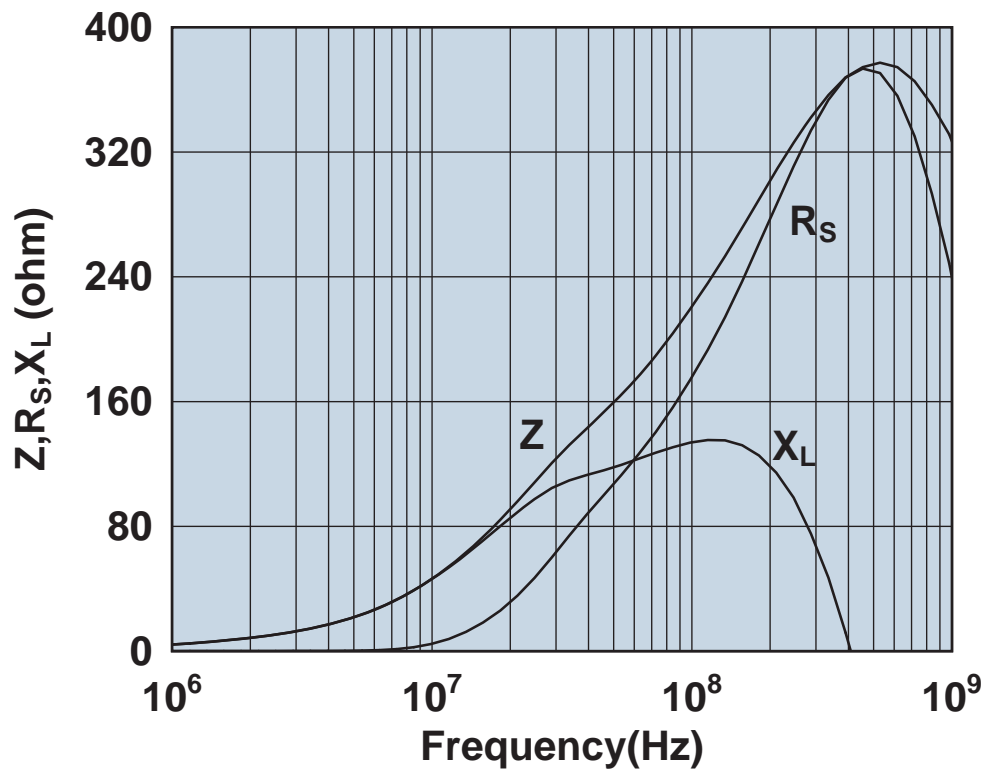

Impedance, reactance, and resistance vs. frequency.

2661167281

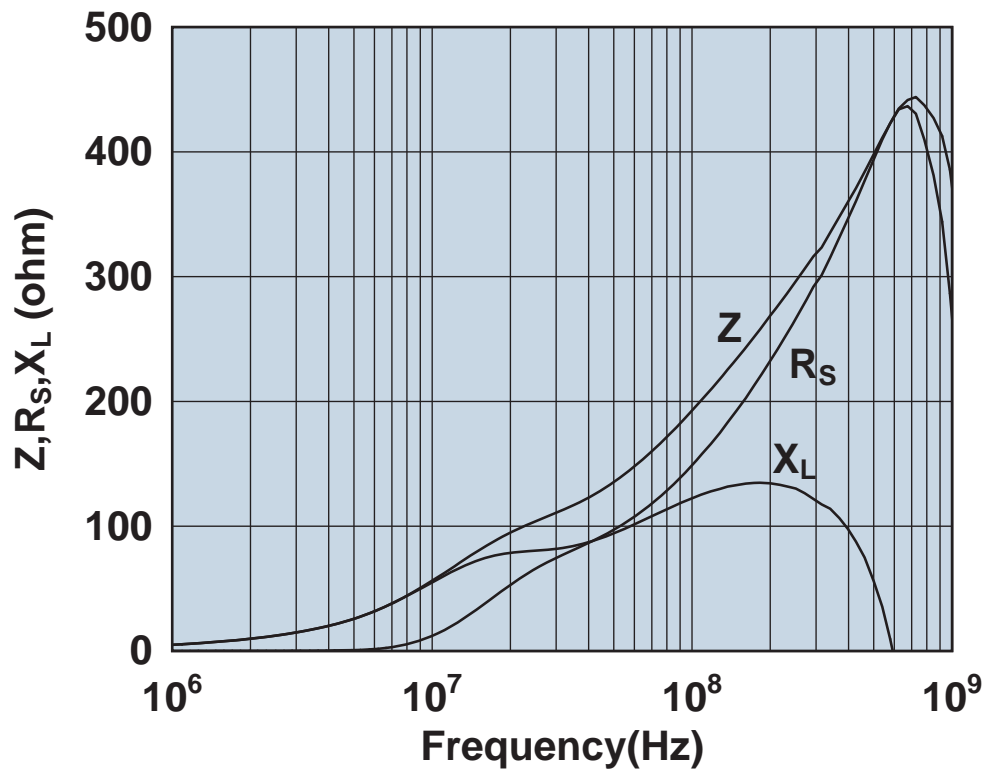

Impedance, reactance, and resistance vs. frequency.

2661176451

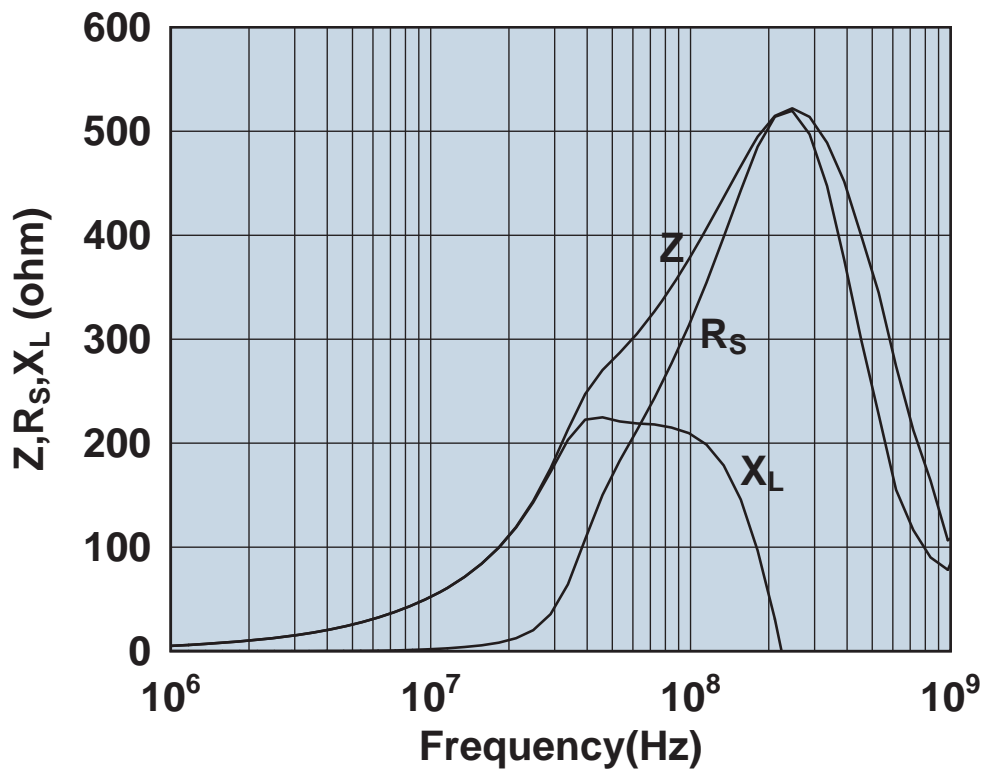

Impedance, reactance, and resistance vs. frequency.

2661178181

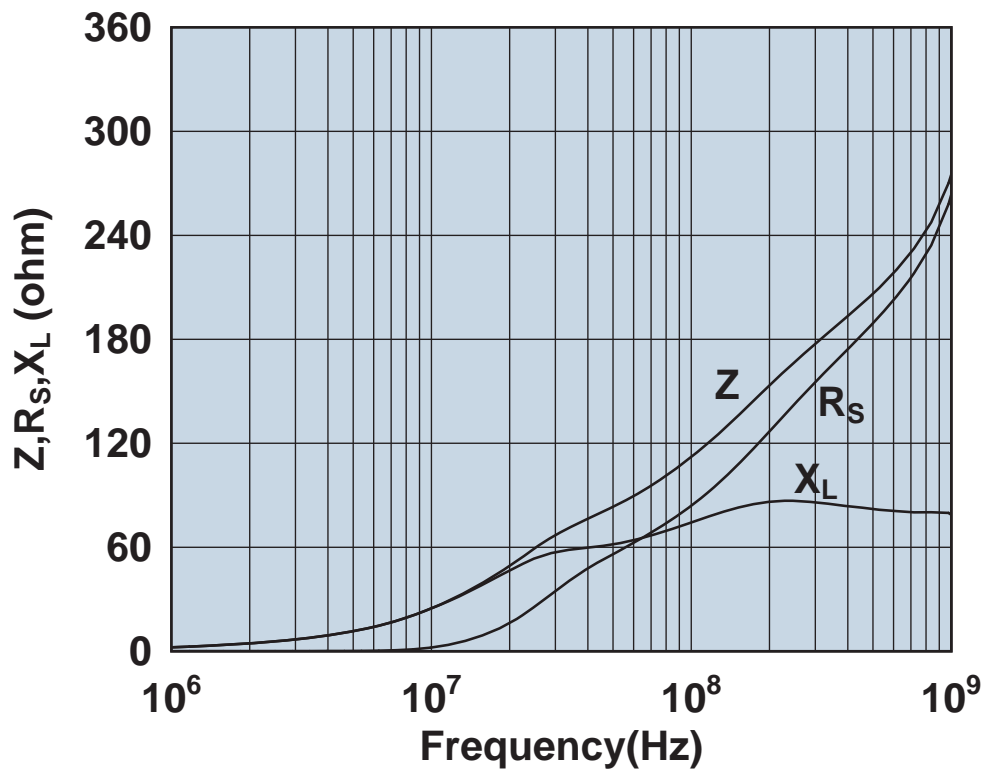

Impedance, reactance, and resistance vs. frequency.

2661178281

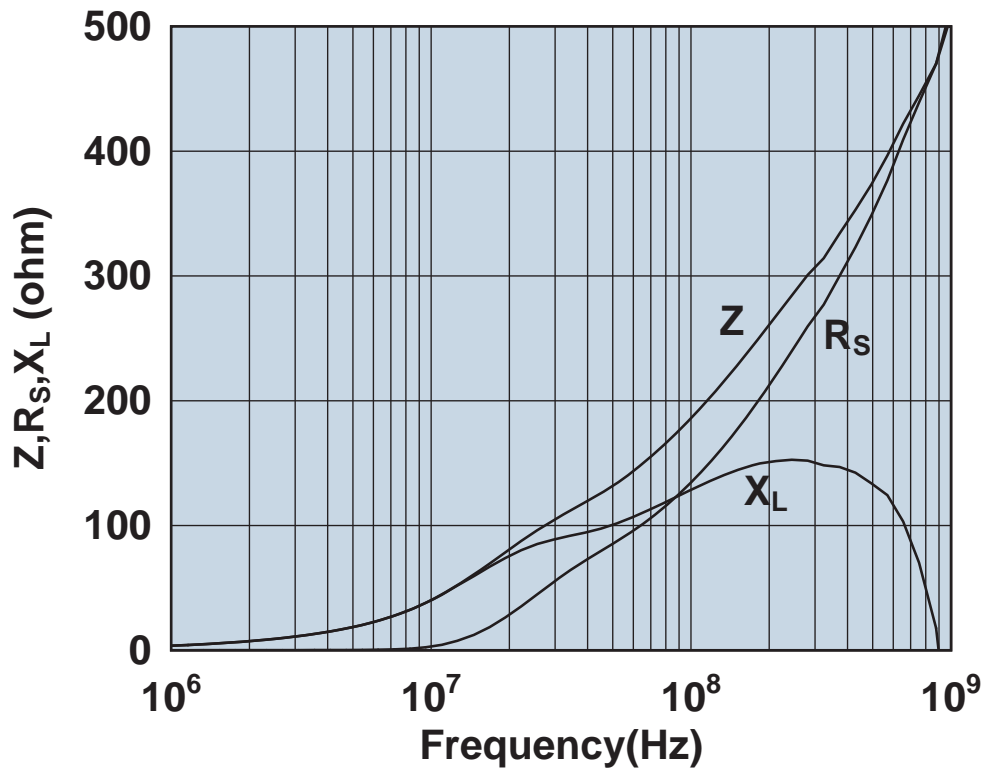

Impedance, reactance, and resistance vs. frequency.

2661250202

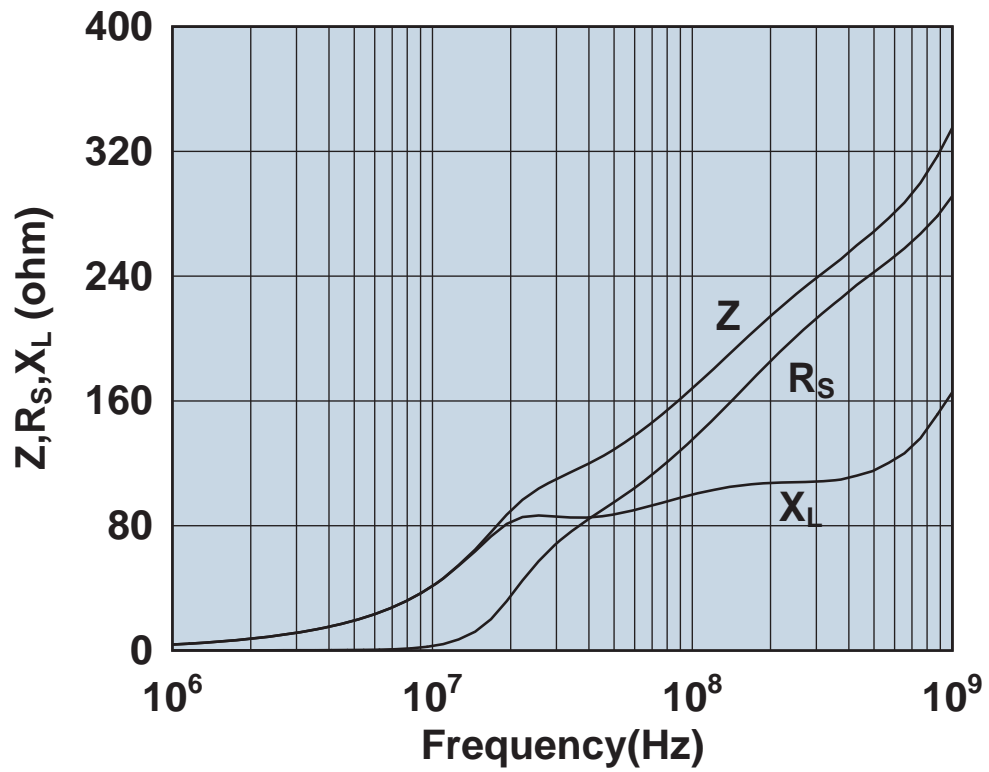

Impedance, reactance, and resistance vs. frequency.

2661250402

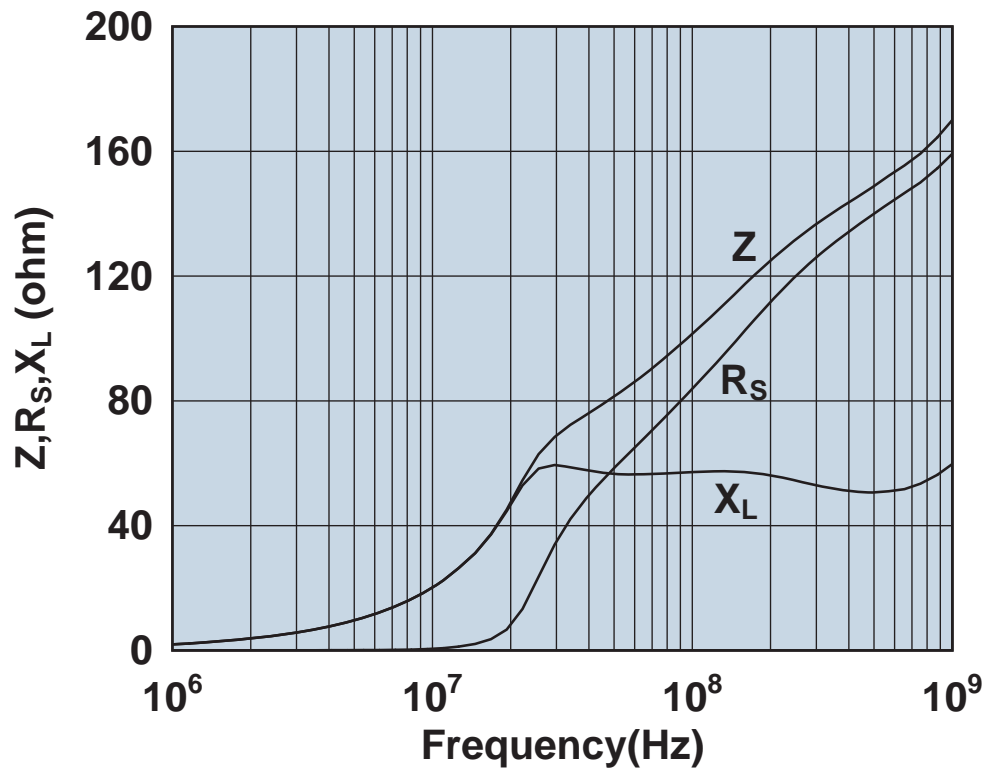

Impedance, reactance, and resistance vs. frequency.

2661375102

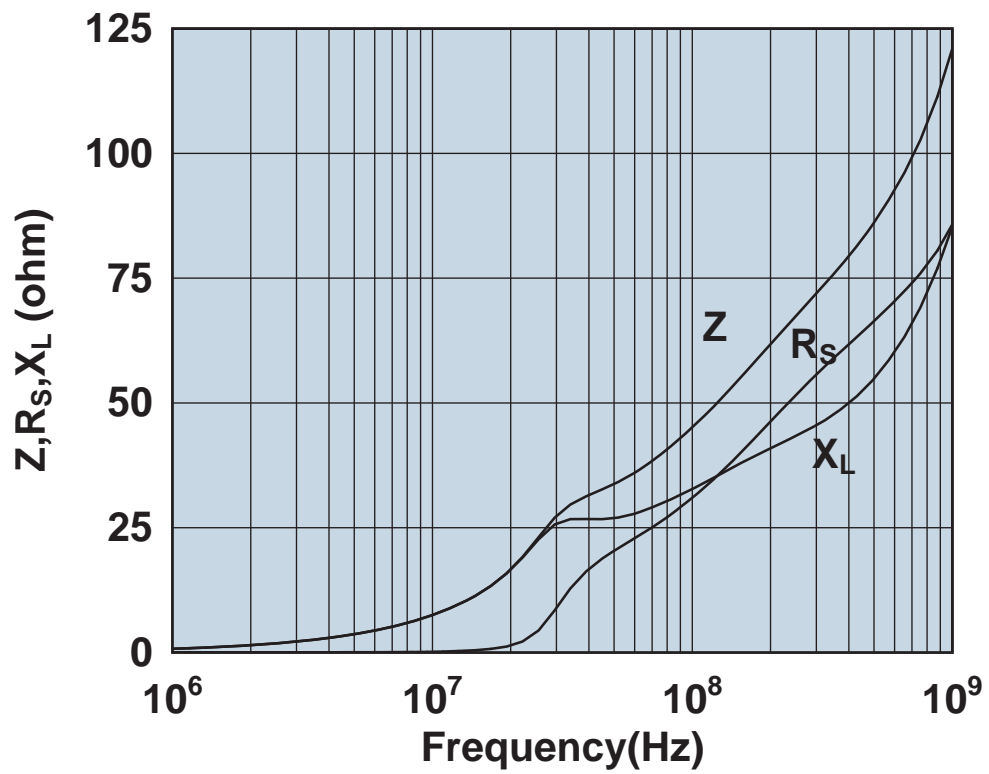

Impedance, reactance, and resistance vs. frequency.

2661540002

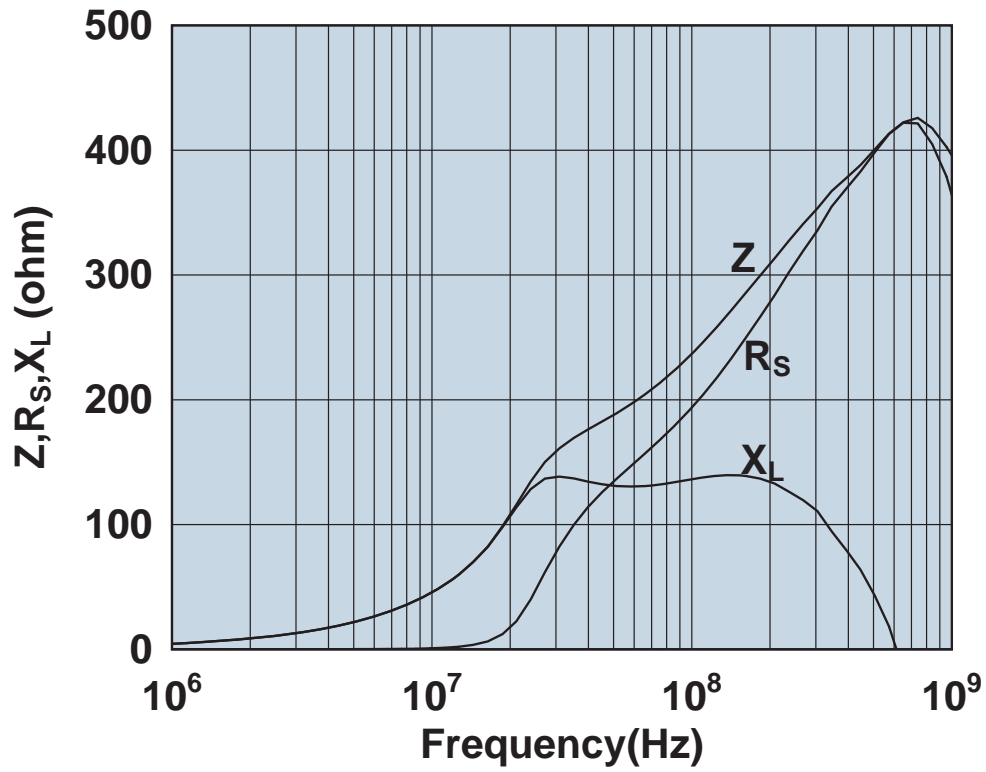

Impedance, reactance, and resistance vs. frequency.

2661540202

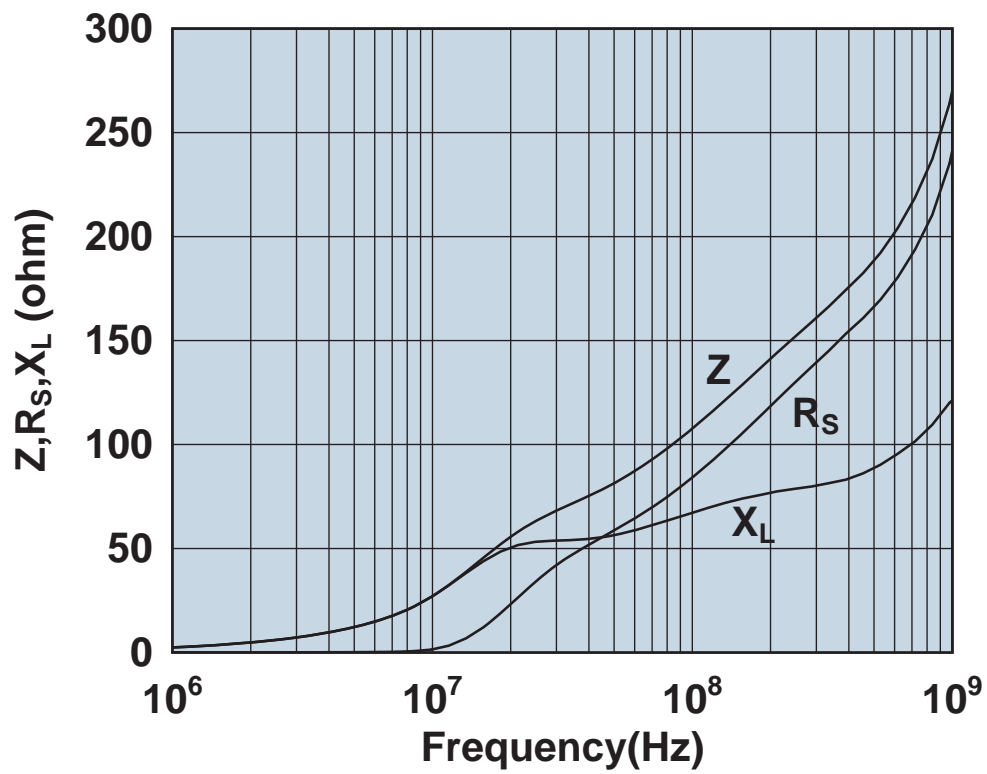

Impedance, reactance, and resistance vs. frequency.

2661626302

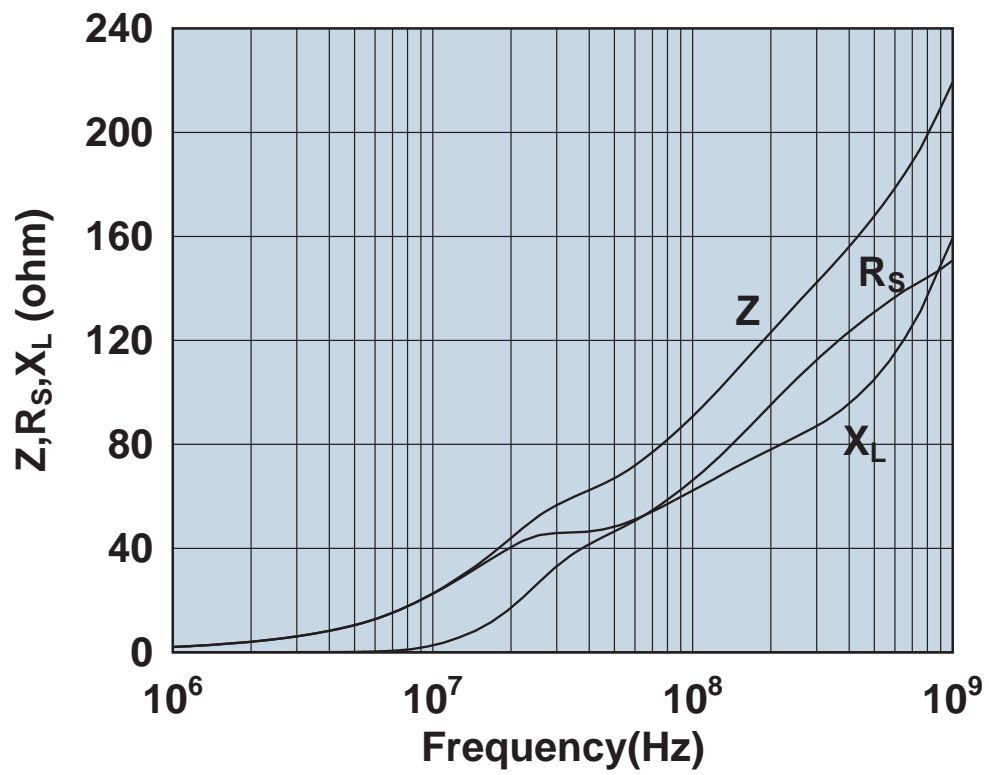

Impedance, reactance, and resistance vs. frequency.

2661626402

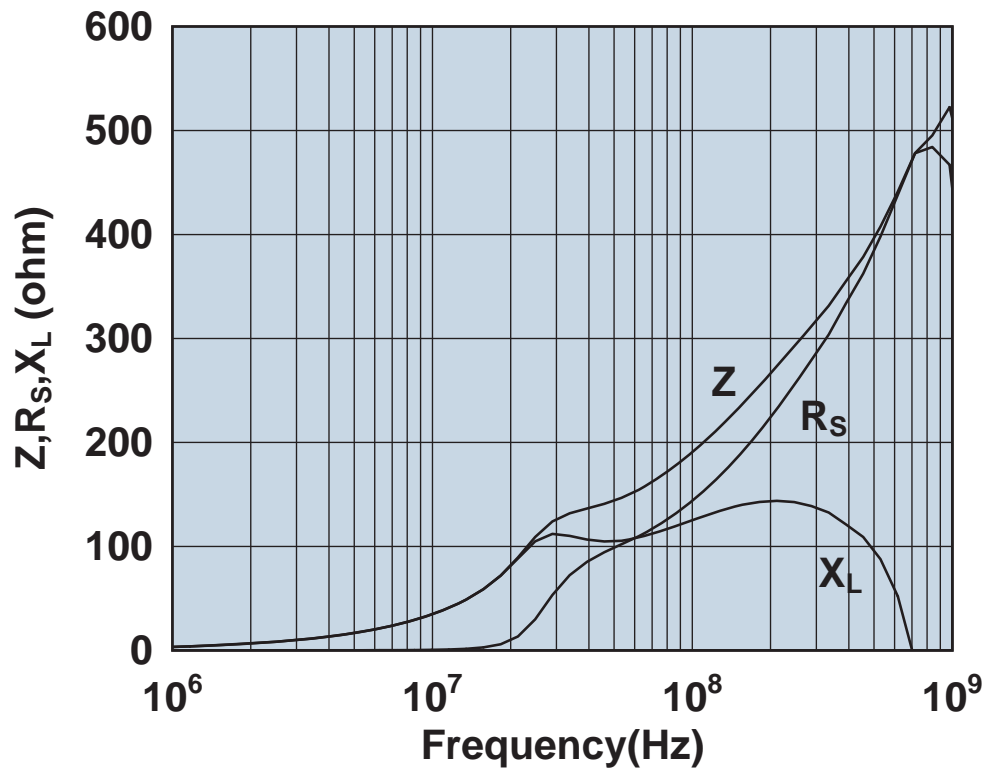

Impedance, reactance, and resistance vs. frequency.

2661665702

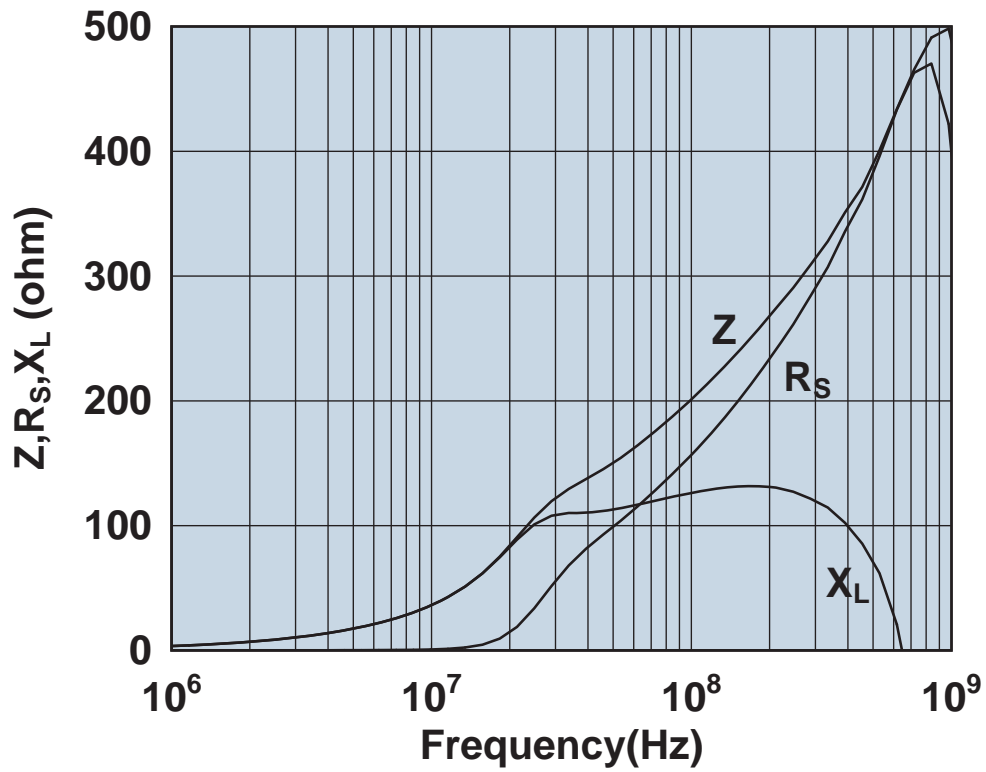

Impedance, reactance, and resistance vs. frequency.

2661665802

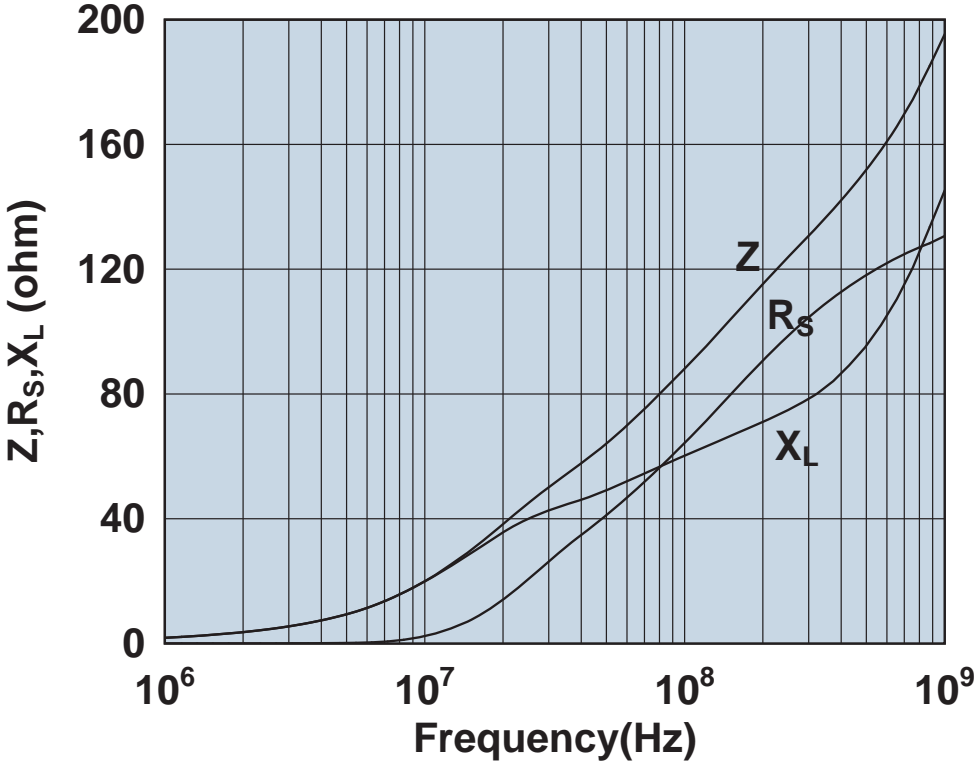

Impedance, reactance, and resistance vs. frequency.

2661666611

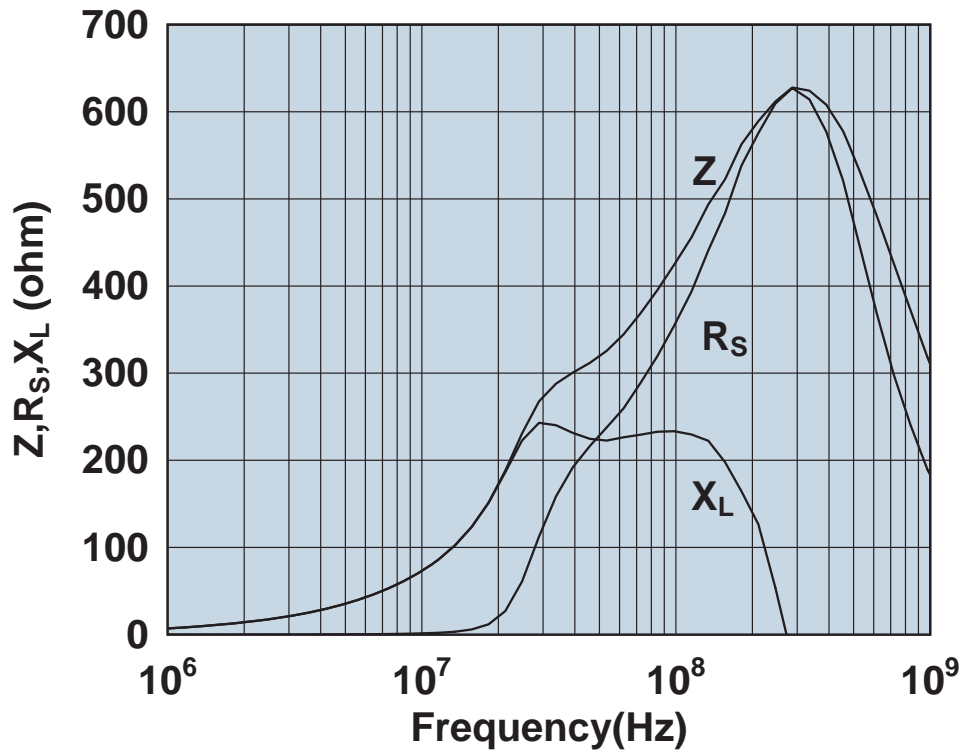

Impedance, reactance, and resistance vs. frequency.

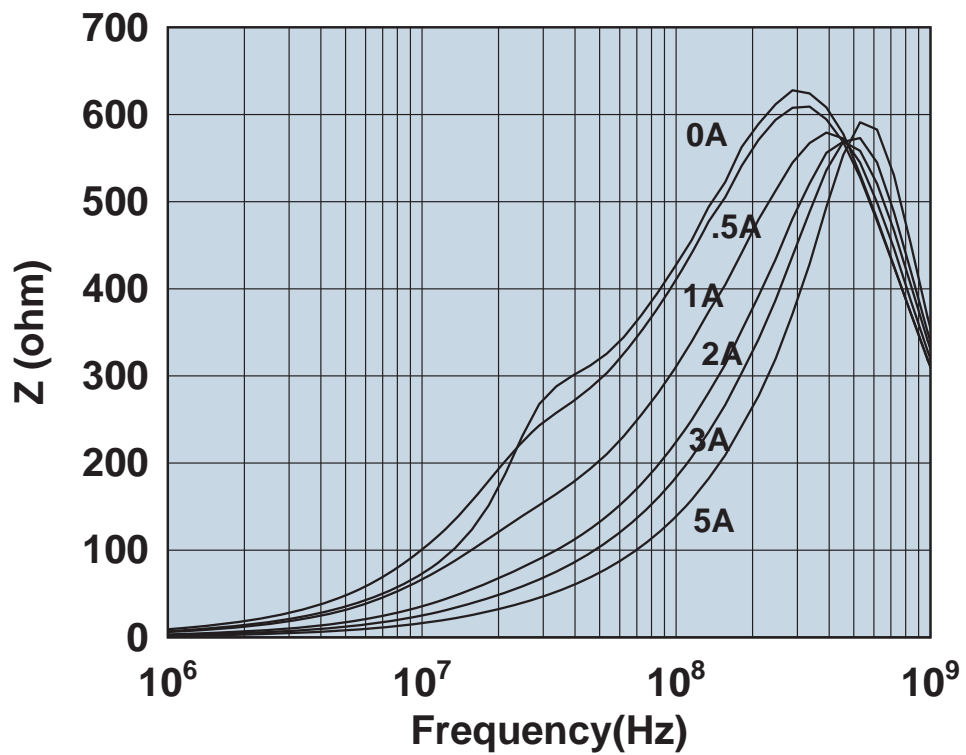

Impedance vs. frequency with dc bias.

2661801902

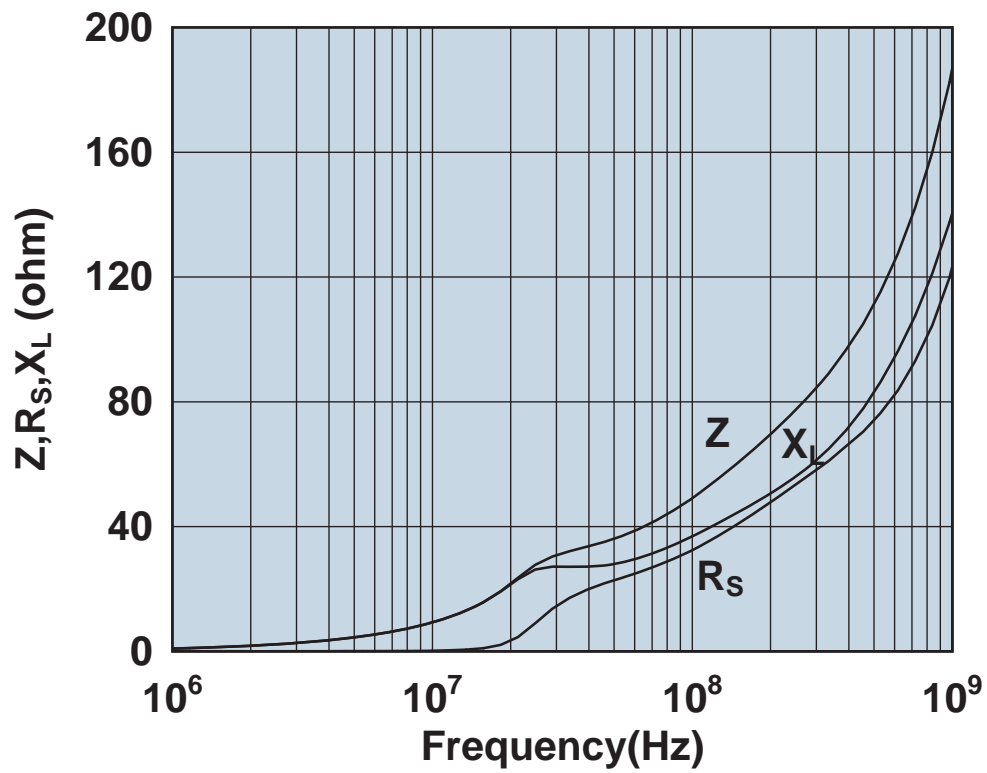

Impedance, reactance, and resistance vs. frequency.

2673000101

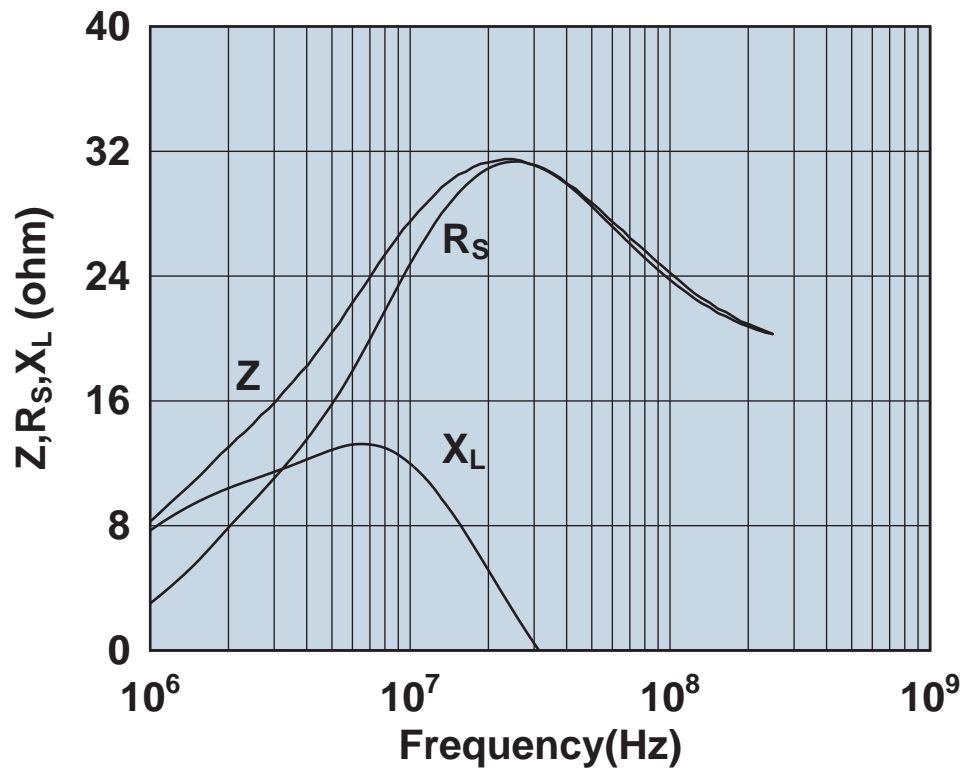

Impedance, reactance, and resistance vs. frequency.

2673000201

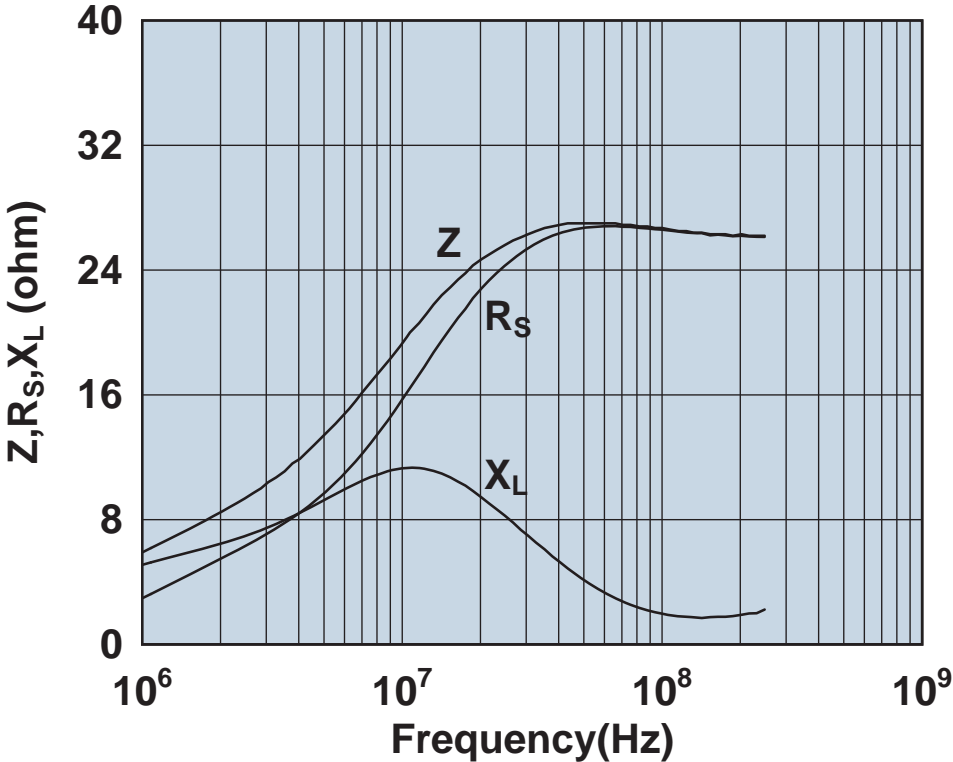

Impedance, reactance, and resistance vs. frequency.

2673000301

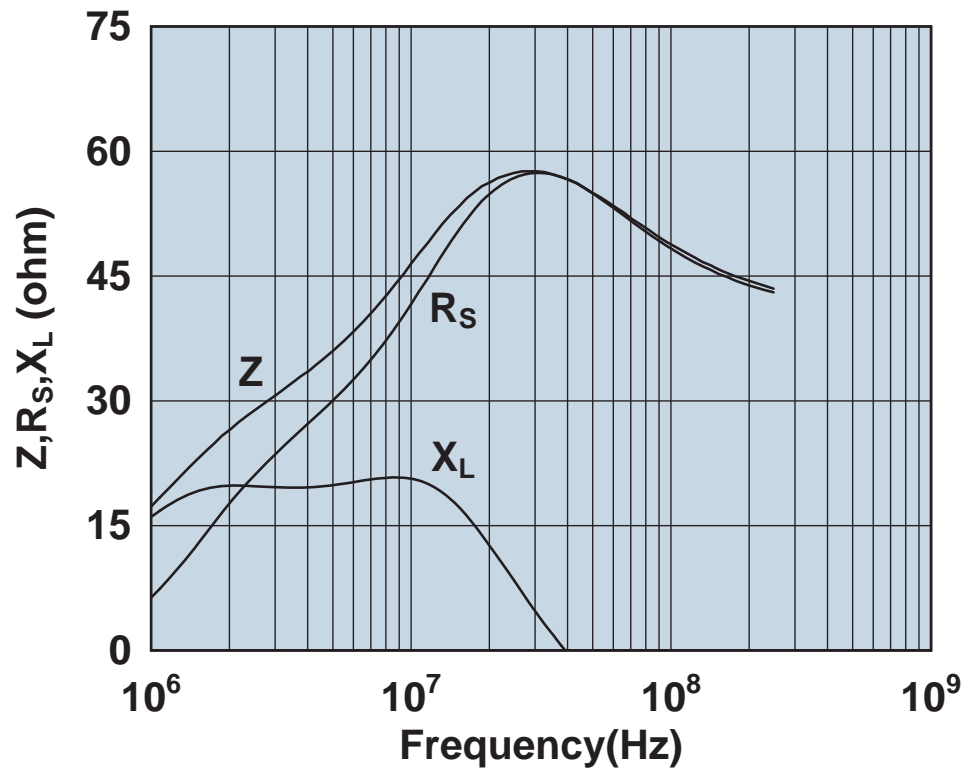

Impedance, reactance, and resistance vs. frequency.

2673000501

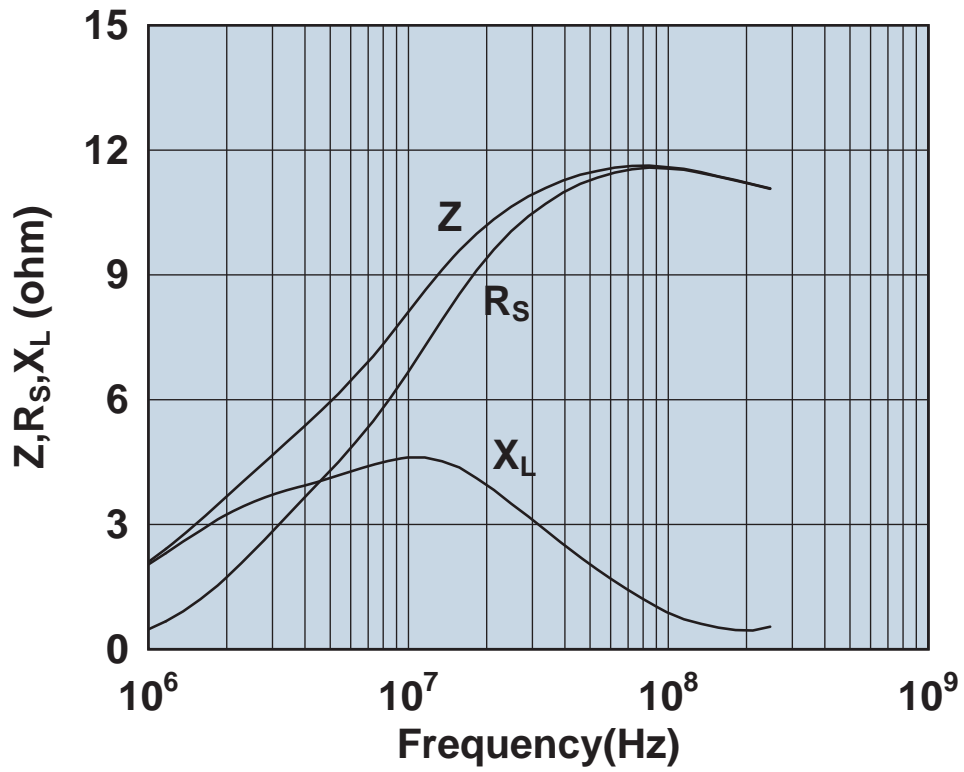

Impedance, reactance, and resistance vs. frequency.

2673000701

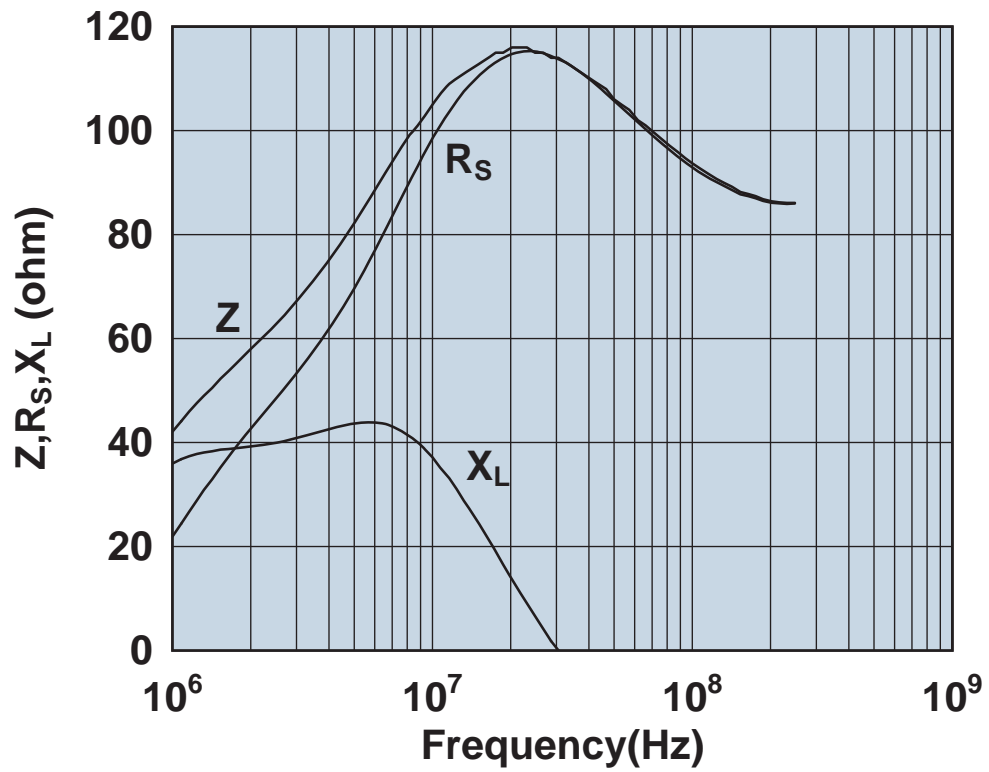

Impedance, reactance, and resistance vs. frequency.

2673000801

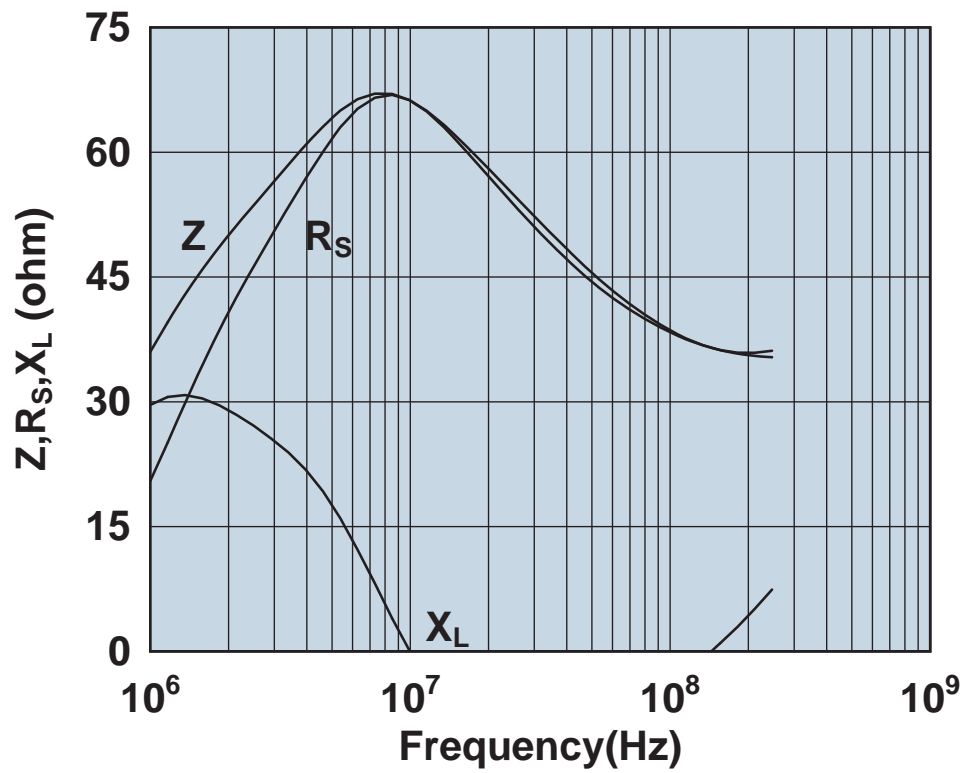

Impedance, reactance, and resistance vs. frequency.

2673001601

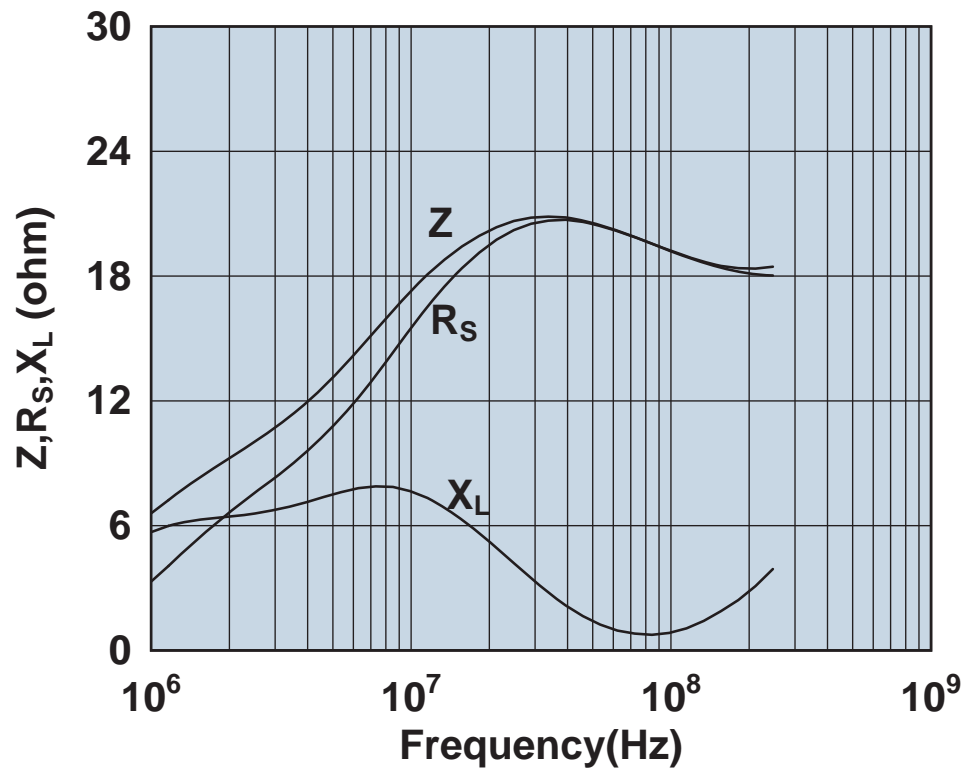

Impedance, reactance, and resistance vs. frequency.

2673002201

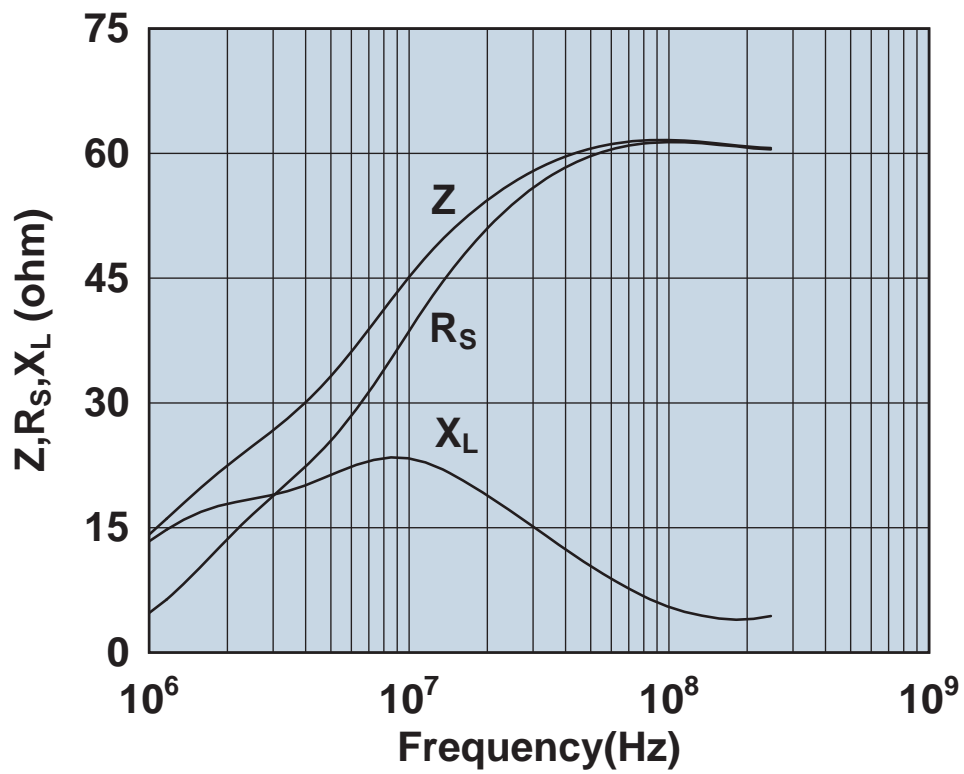

Impedance, reactance, and resistance vs. frequency.

2673002402

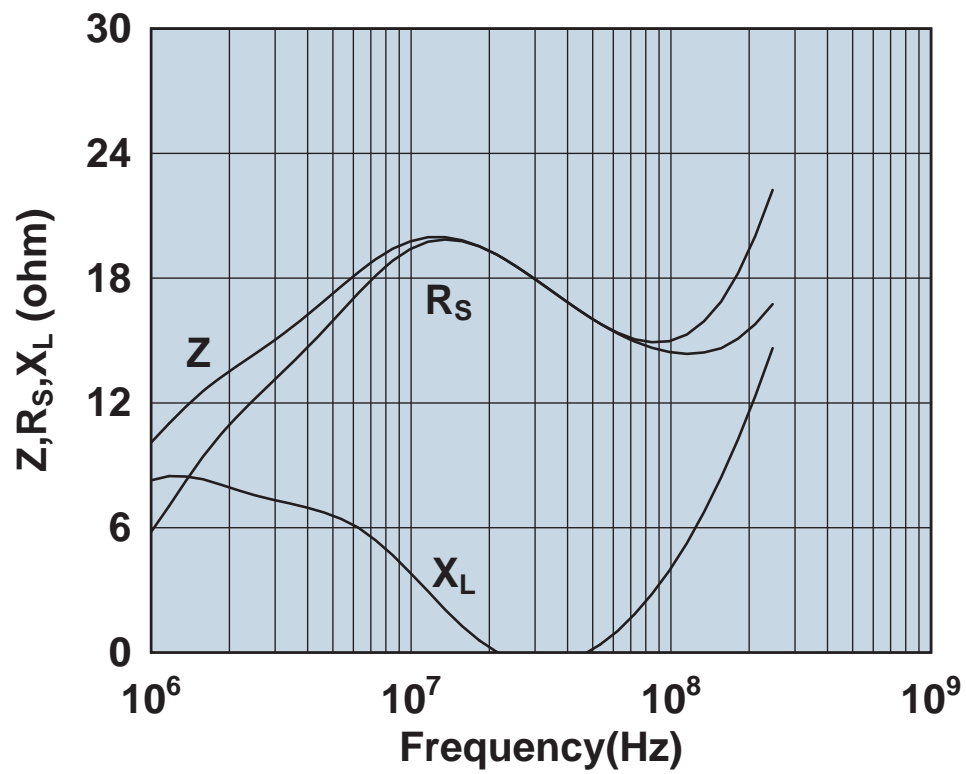

Impedance, reactance, and resistance vs. frequency.

2673003201

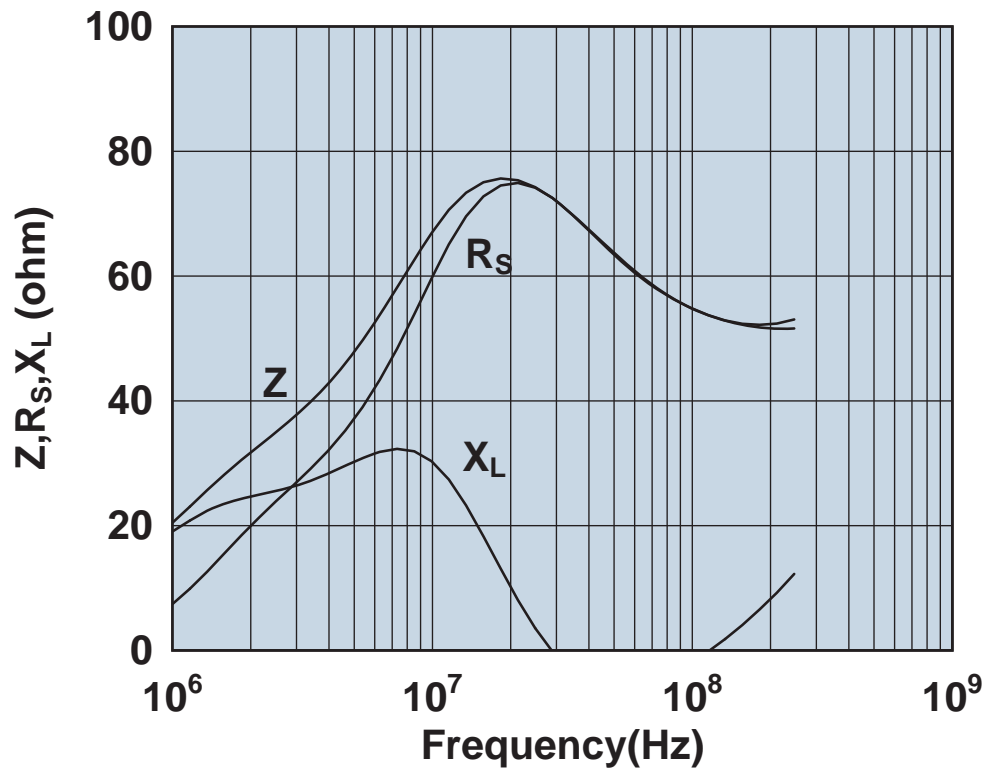

Impedance, reactance, and resistance vs. frequency.

2673004601

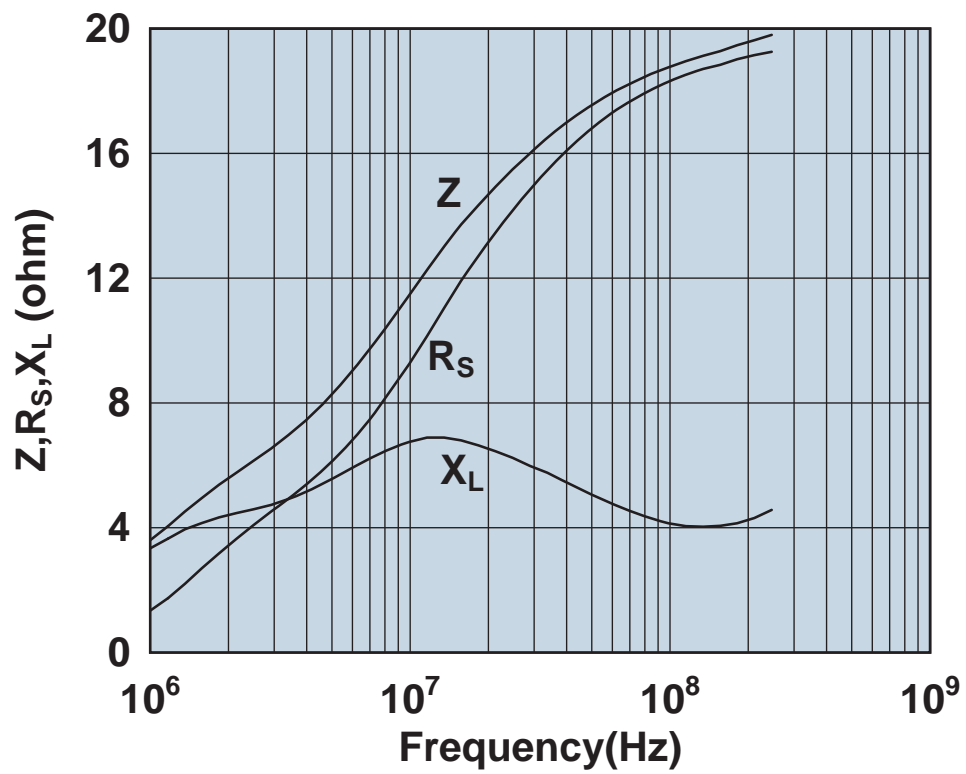

Impedance, reactance, and resistance vs. frequency.

2673004701

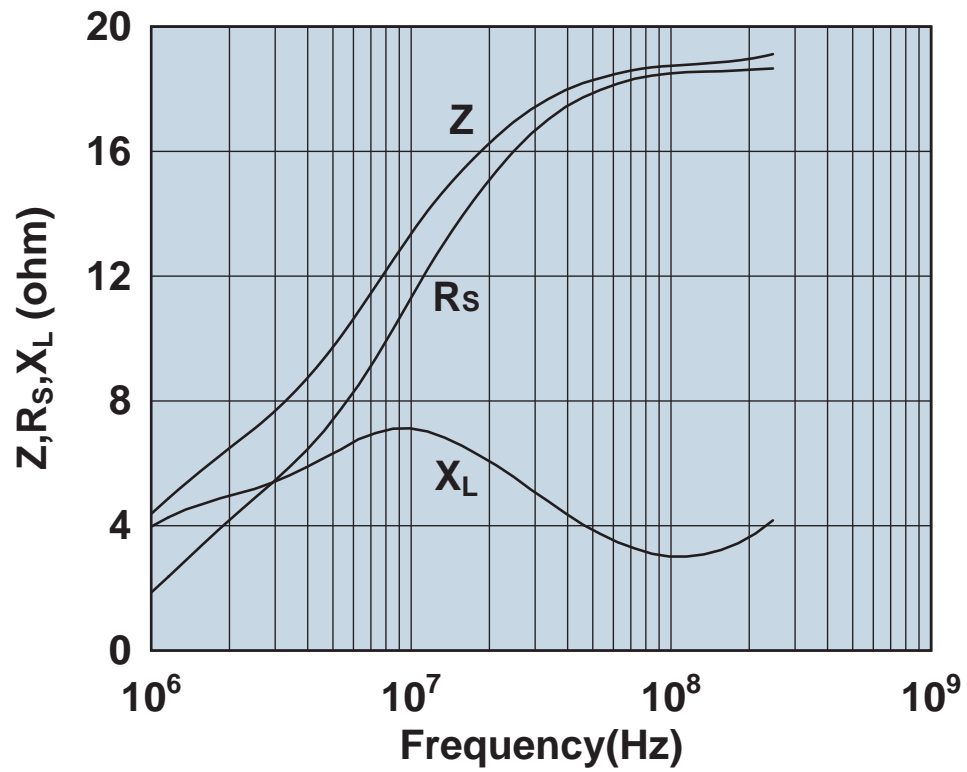

Impedance, reactance, and resistance vs. frequency.

2673004801

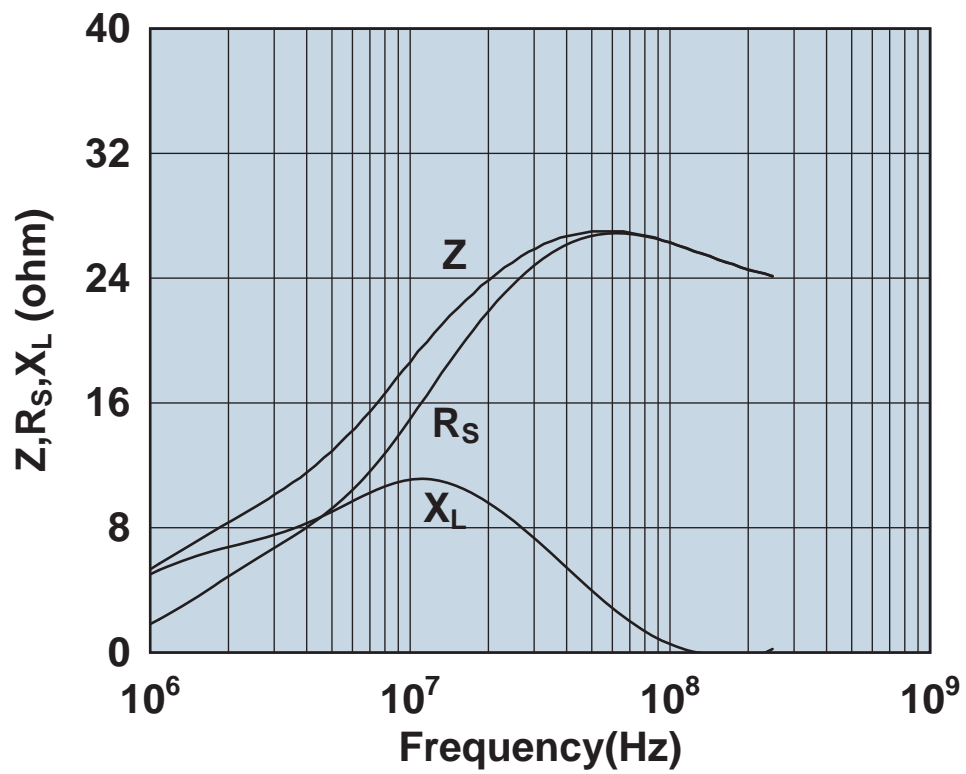

Impedance, reactance, and resistance vs. frequency.

2673004901

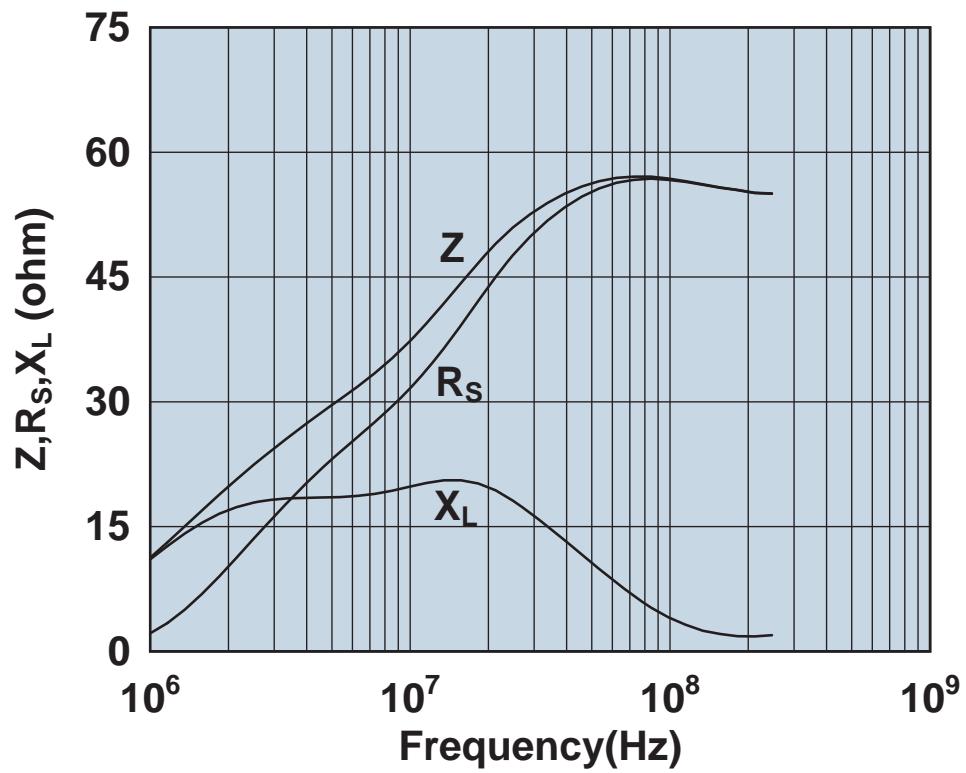

Impedance, reactance, and resistance vs. frequency.

2673010101

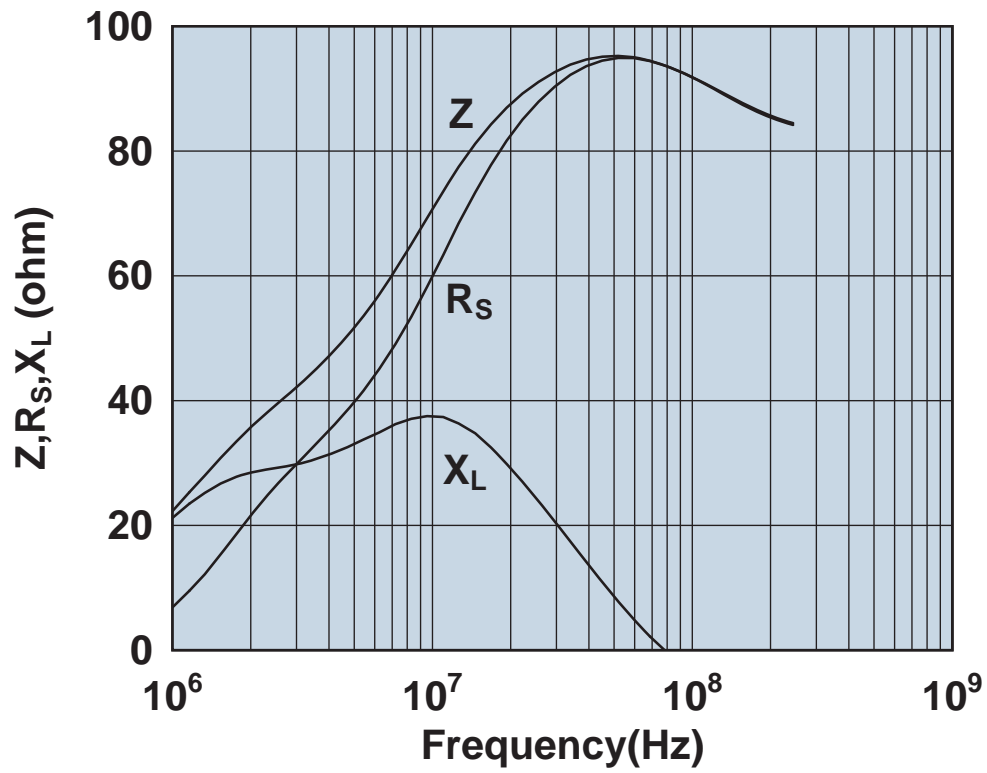

Impedance, reactance, and resistance vs. frequency.

2673012401

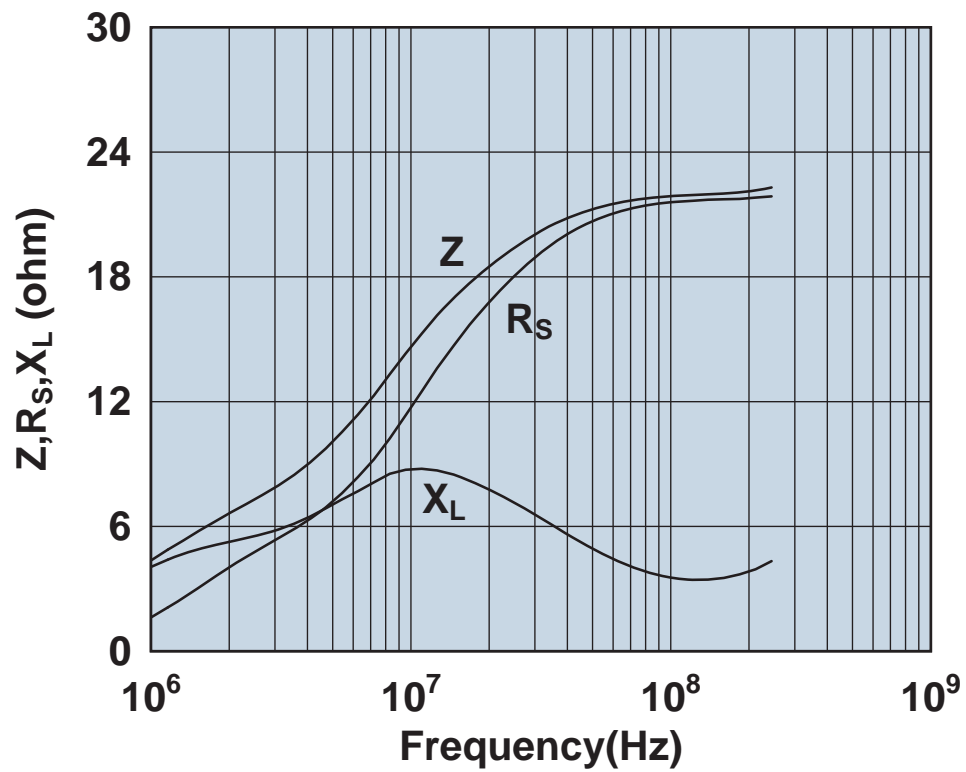

Impedance, reactance, and resistance vs. frequency.

2673015301

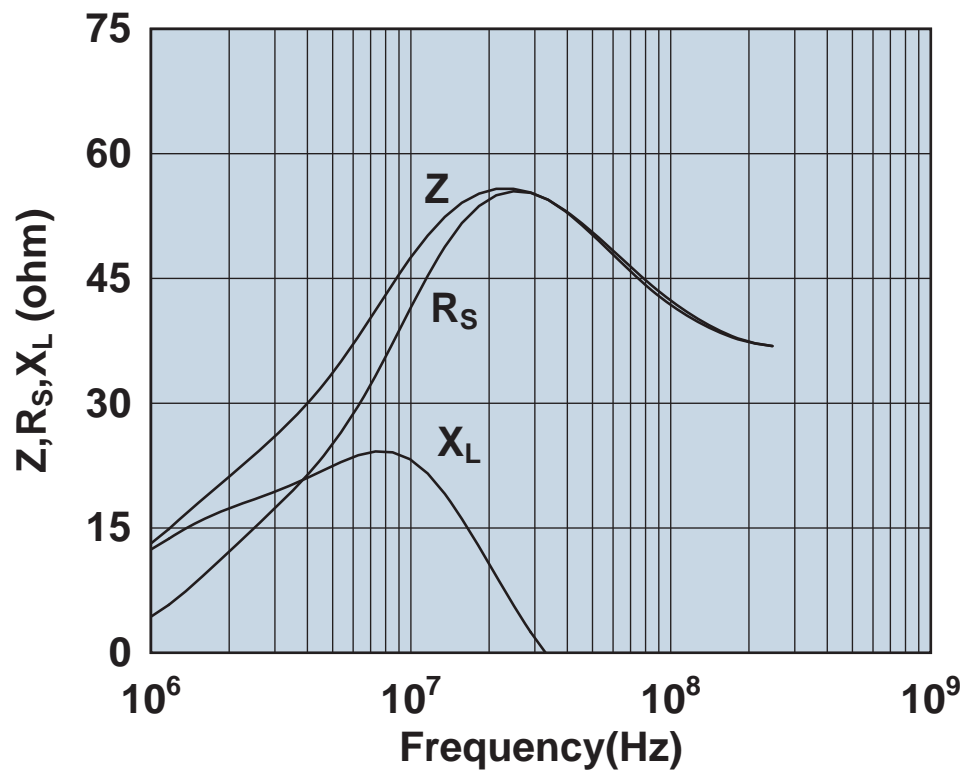

Impedance, reactance, and resistance vs. frequency.

2673018001

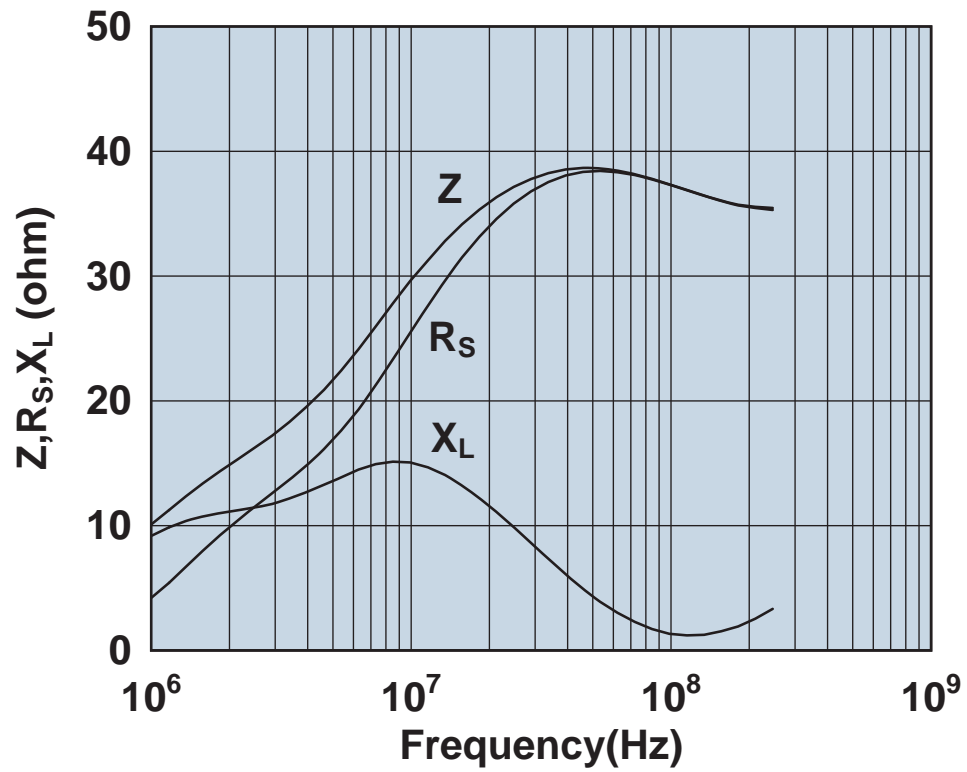

Impedance, reactance, and resistance vs. frequency.

2673021801

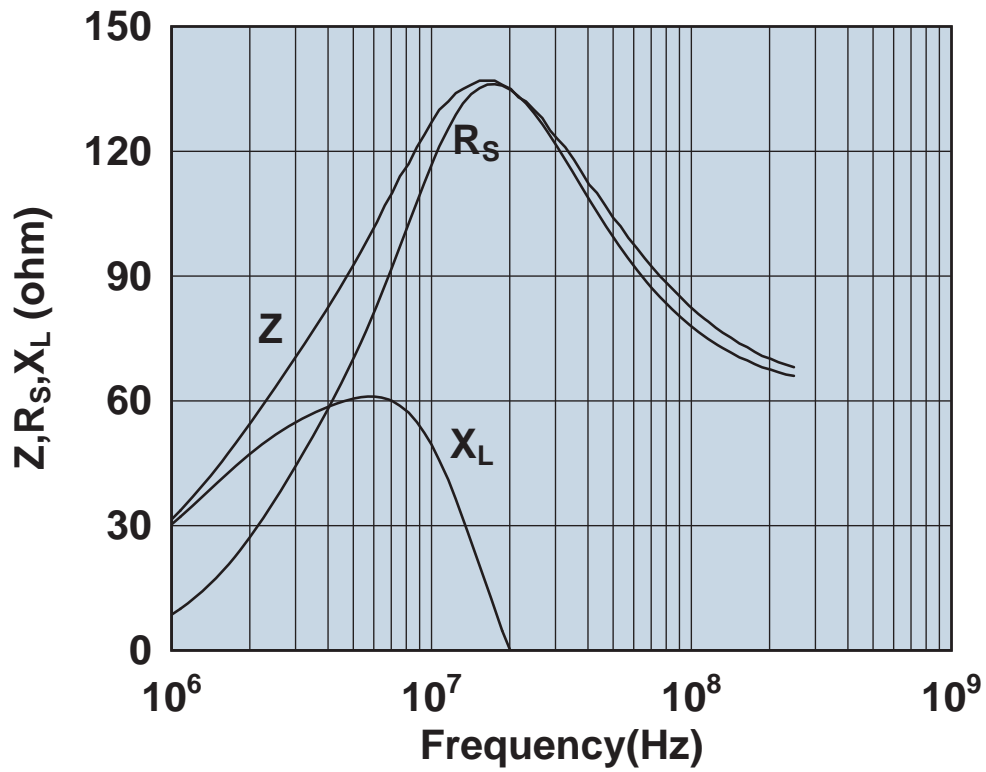

Impedance, reactance, and resistance vs. frequency.

2673022401

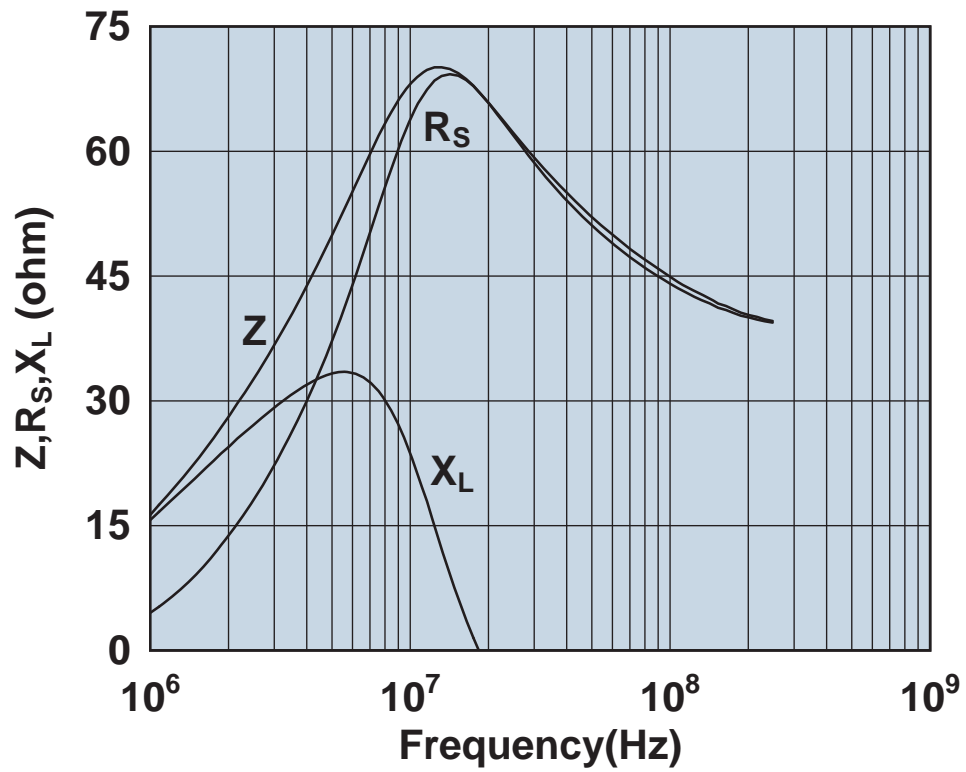

Impedance, reactance, and resistance vs. frequency.

2673025301

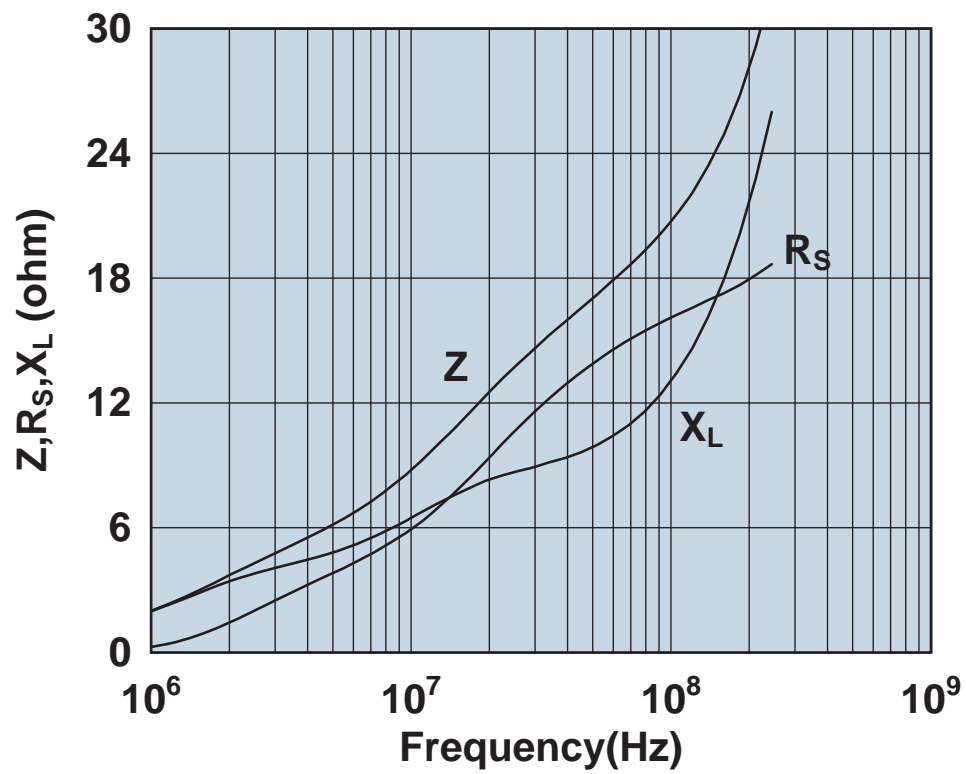

Impedance, reactance, and resistance vs. frequency.

2673028602

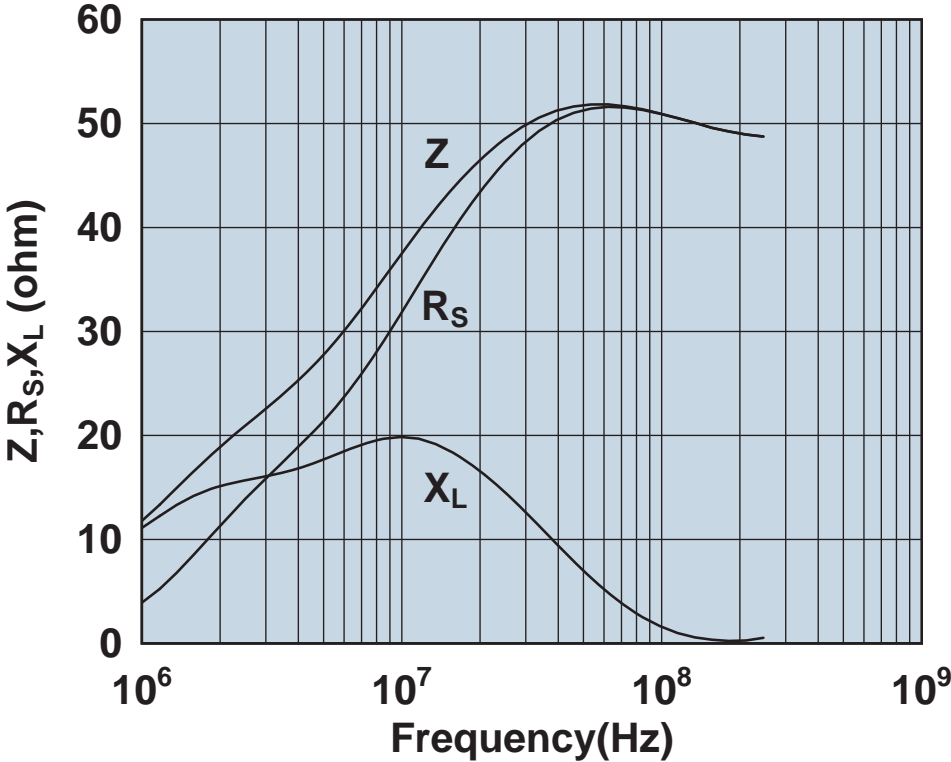

Impedance, reactance, and resistance vs. frequency.

2673030101

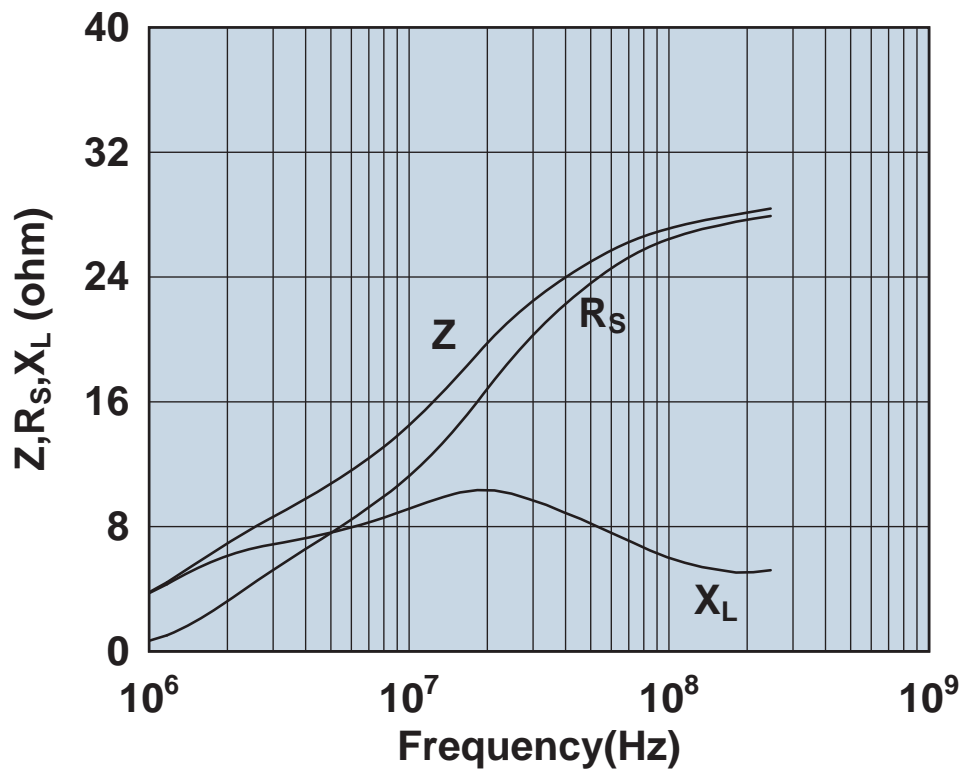

Impedance, reactance, and resistance vs. frequency.

2673200201

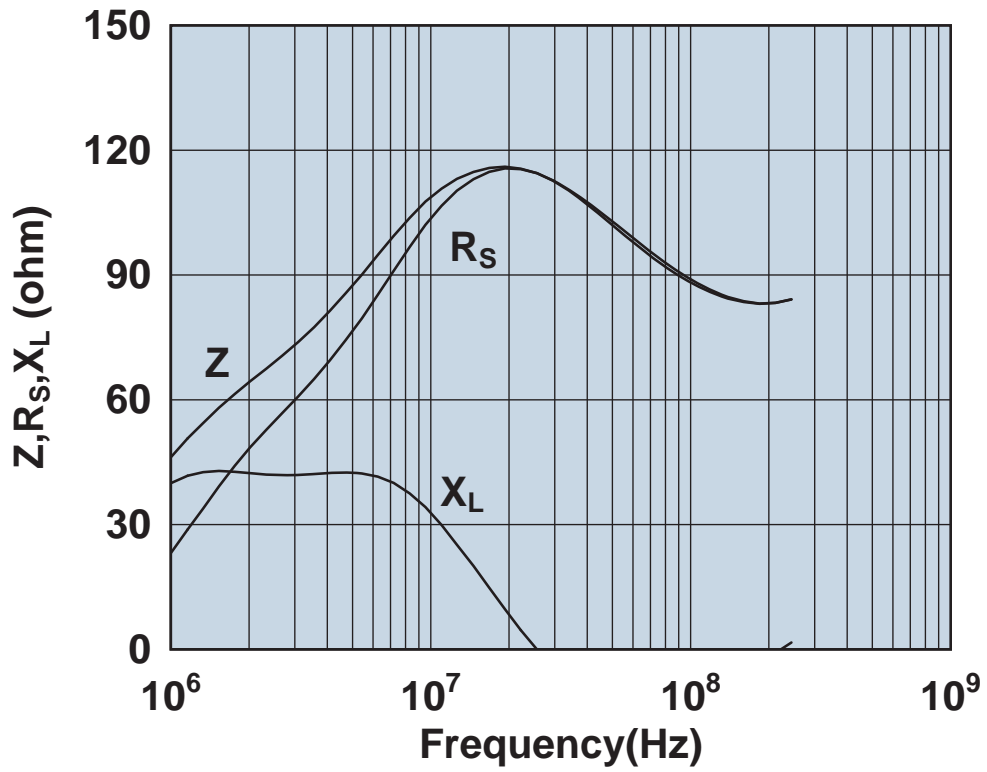

Impedance, reactance, and resistance vs. frequency.

2673901301

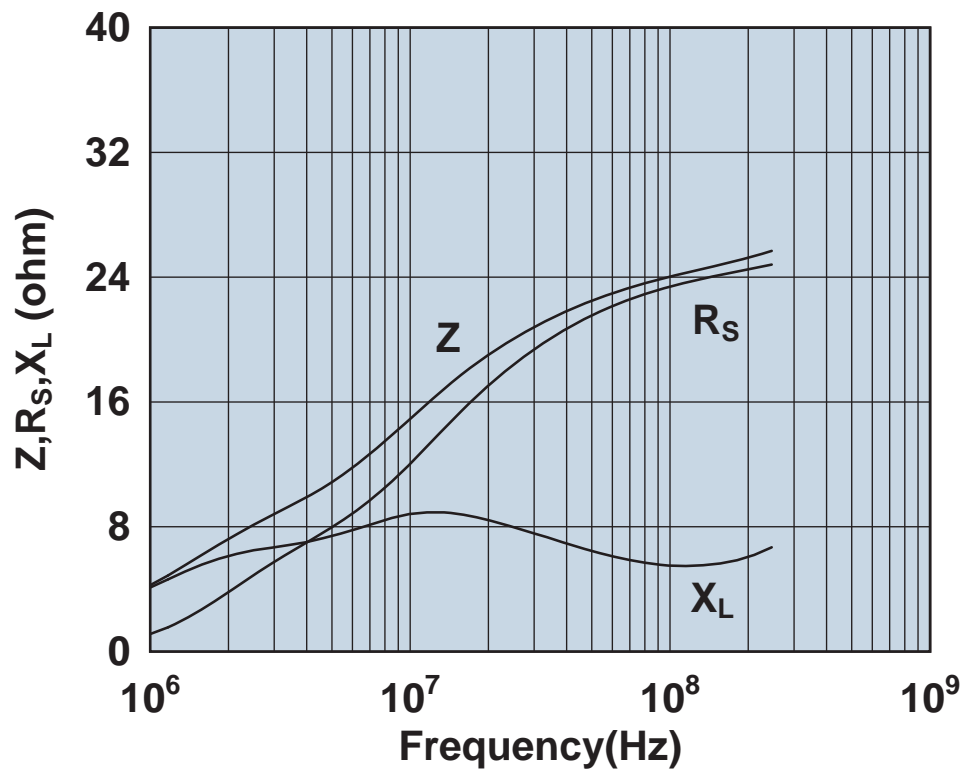

Impedance, reactance, and resistance vs. frequency.

2743001112

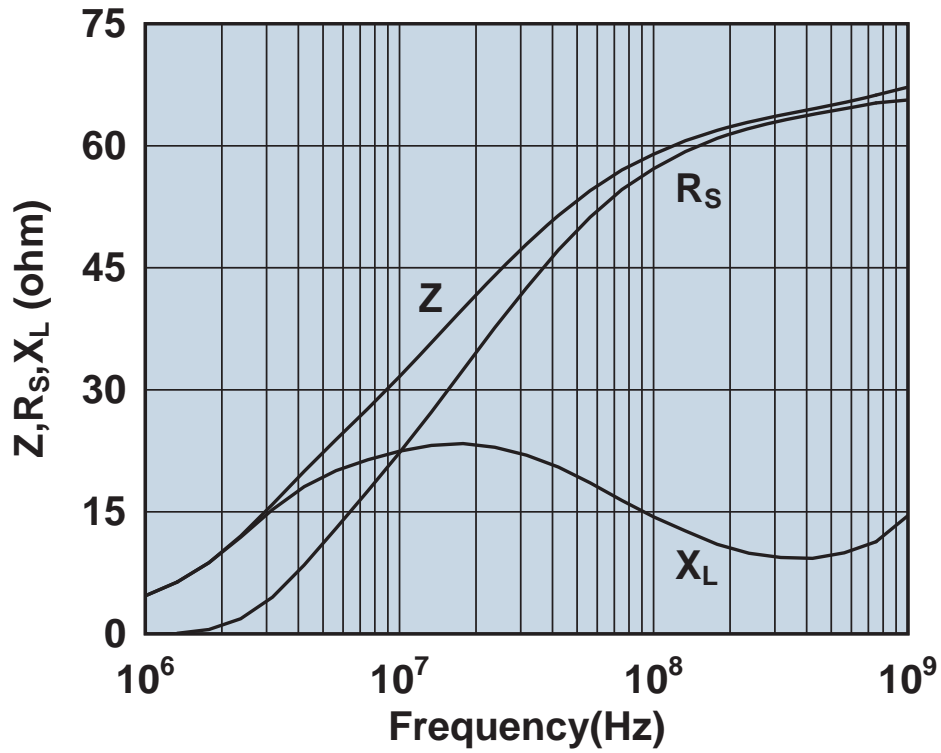

Impedance, reactance, and resistance vs. frequency.

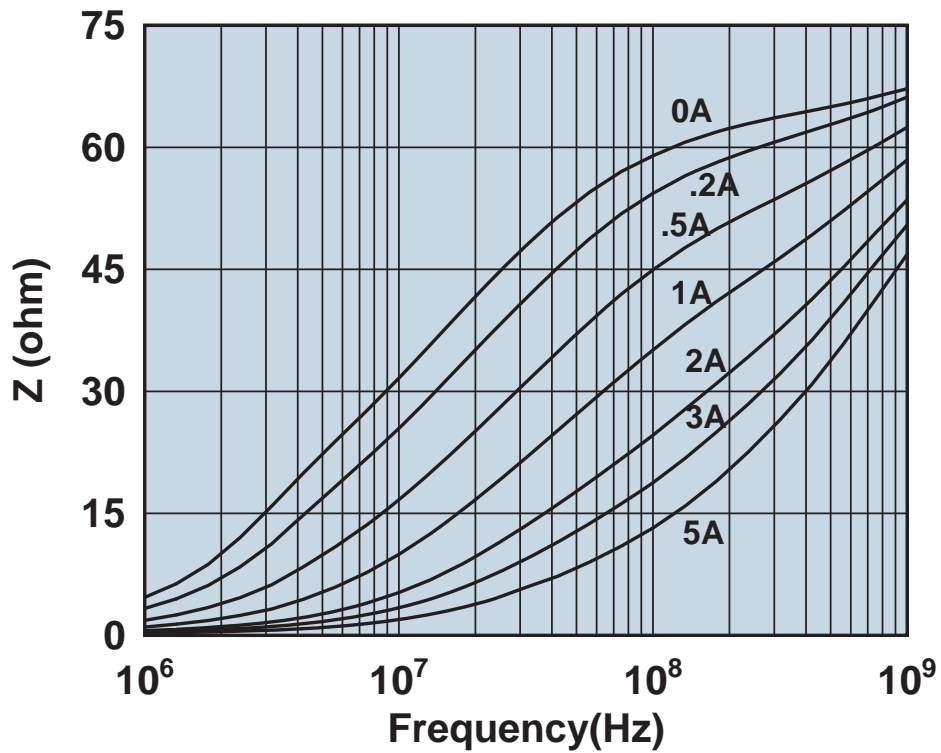

Impedance vs. frequency with dc bias.

2743002112

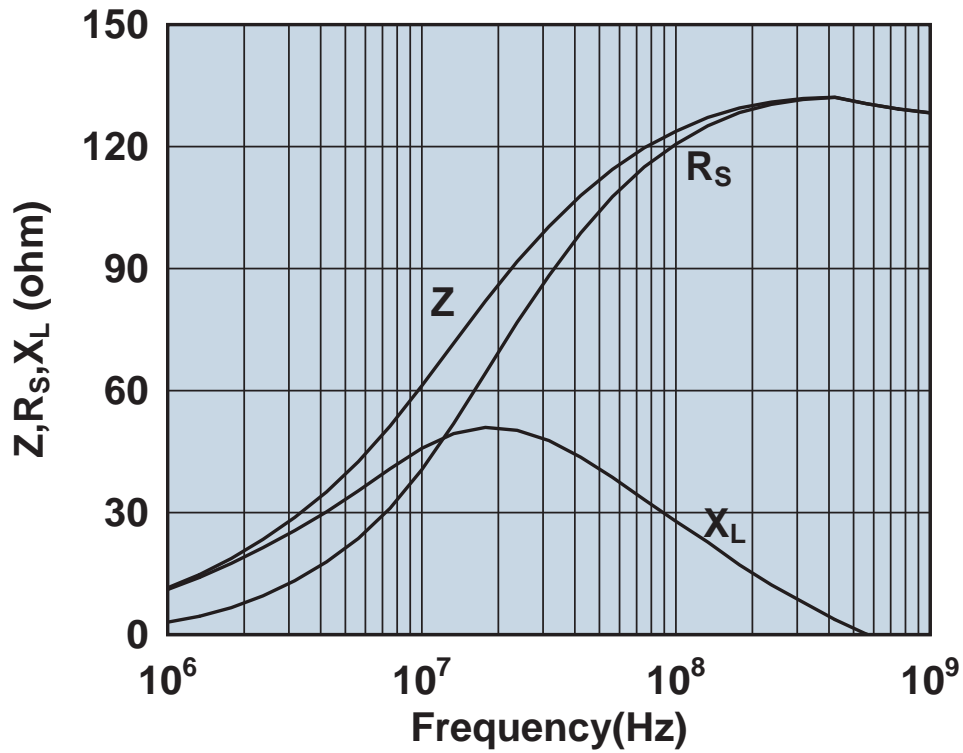

Impedance, reactance, and resistance vs. frequency.

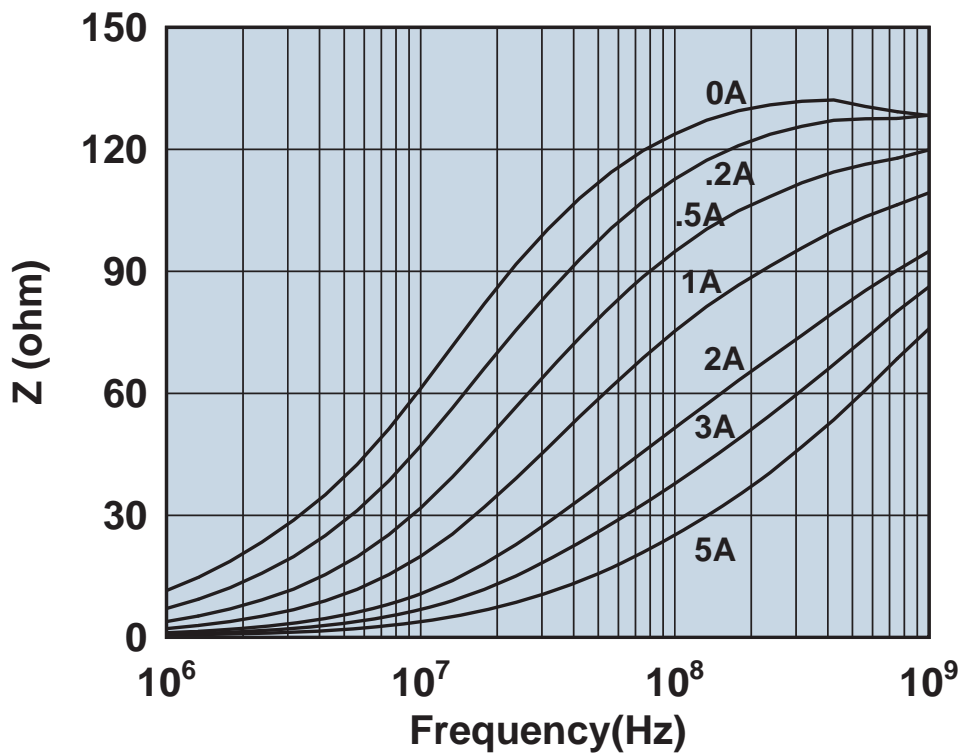

Impedance vs. frequency with dc bias.

2743003112

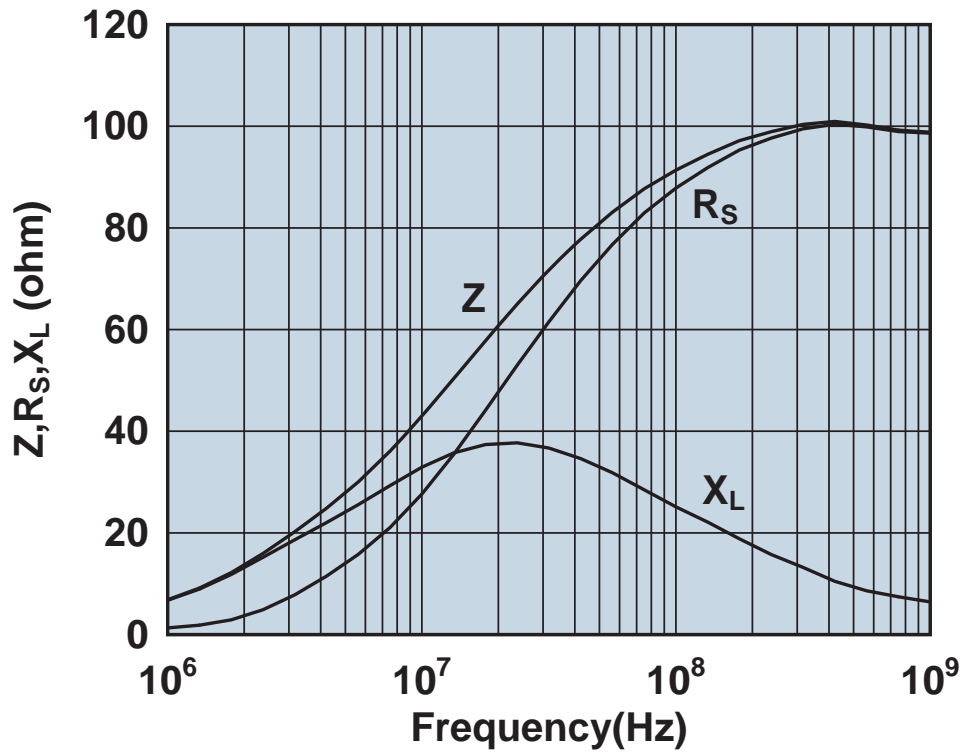

Impedance, reactance, and resistance vs. frequency.

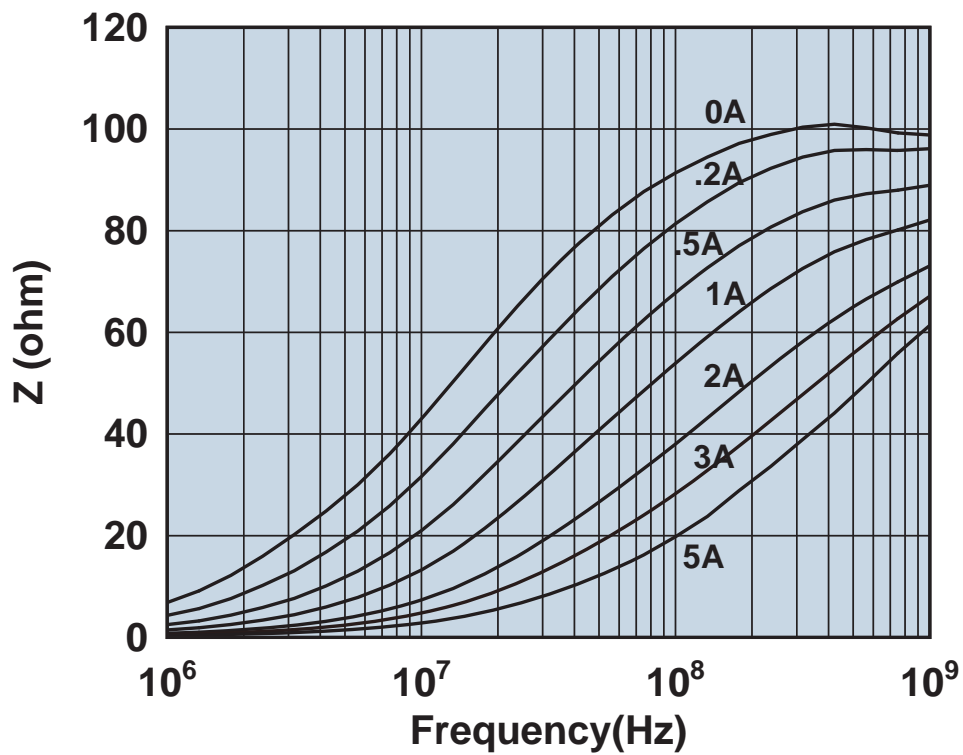

Impedance vs. frequency with dc bias.

2743004112

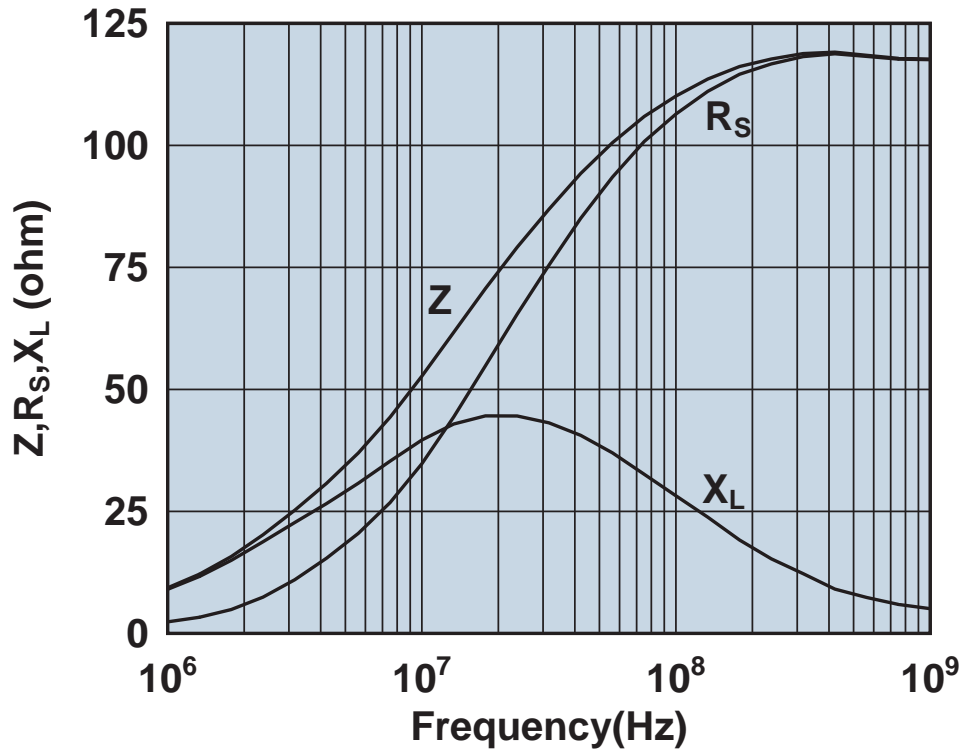

Impedance, reactance, and resistance vs. frequency.

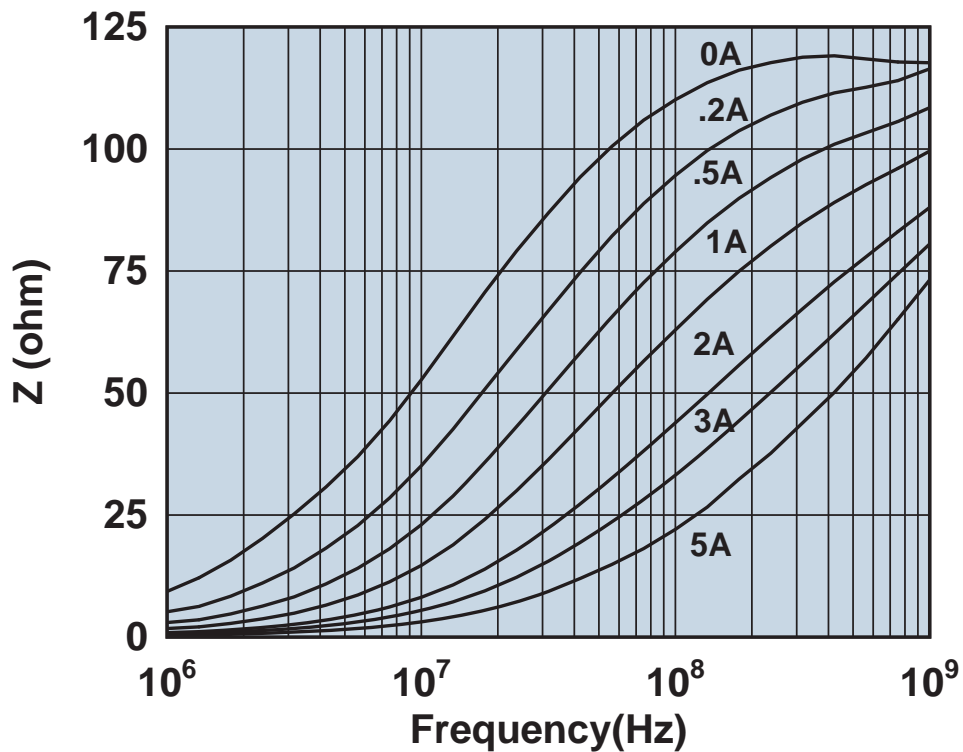

Impedance vs. frequency with dc bias.

2743005112

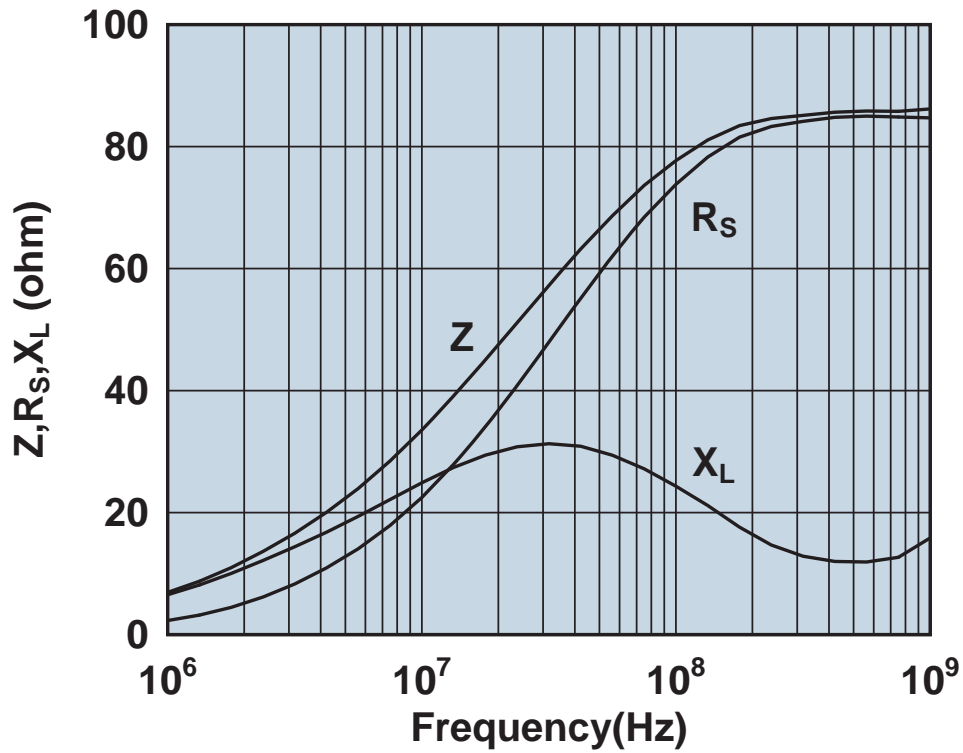

Impedance, reactance, and resistance vs. frequency.

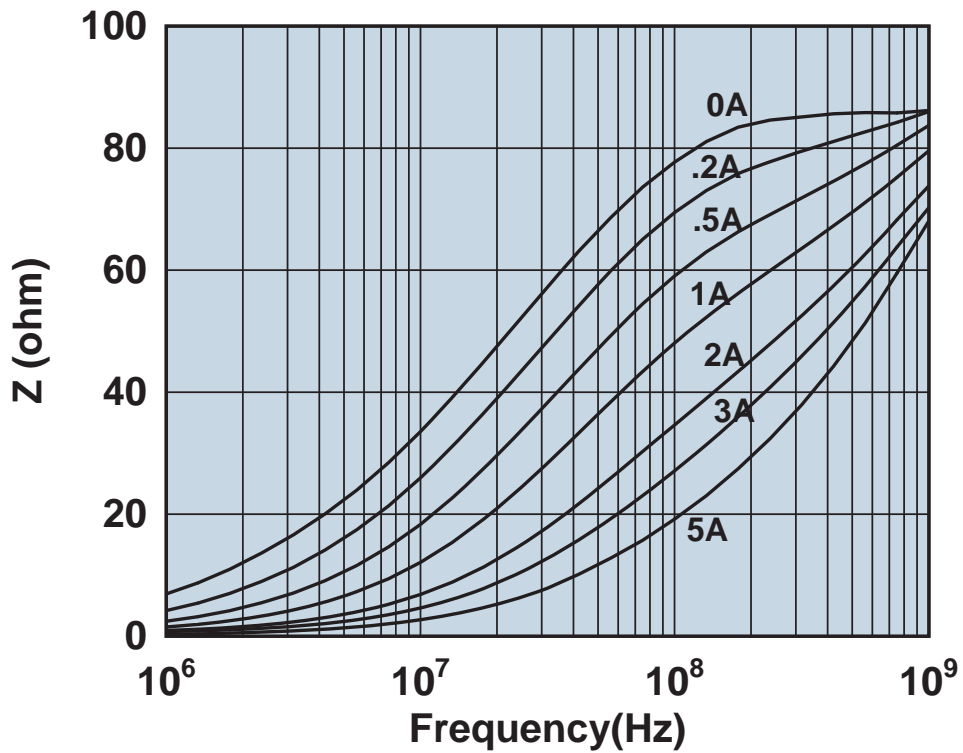

Impedance vs. frequency with dc bias.

2743007112

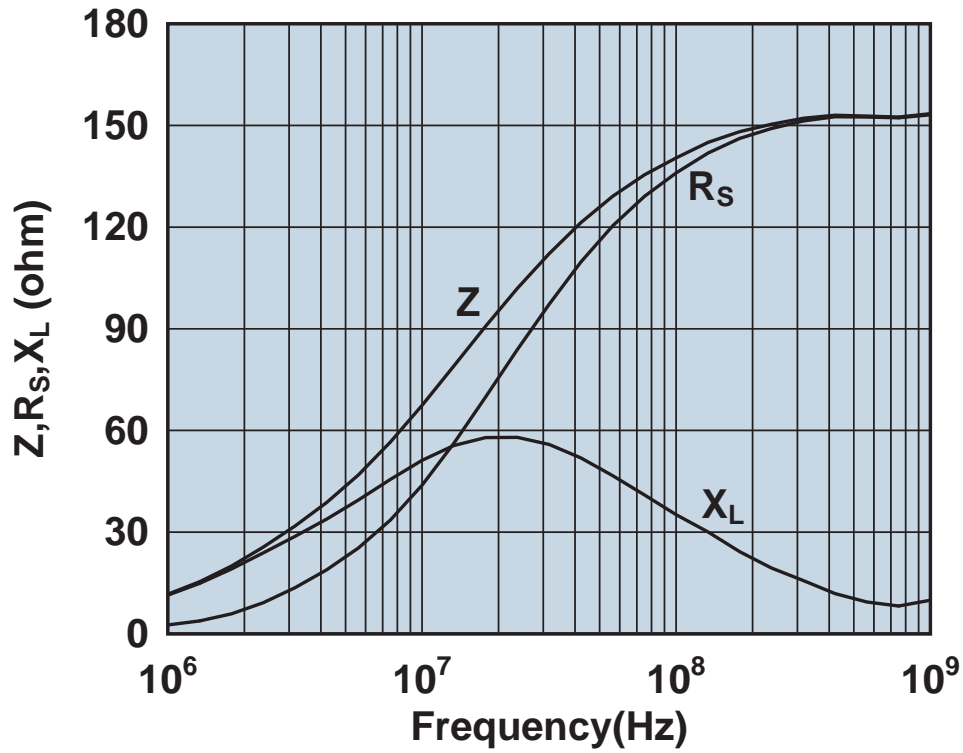

Impedance, reactance, and resistance vs. frequency.

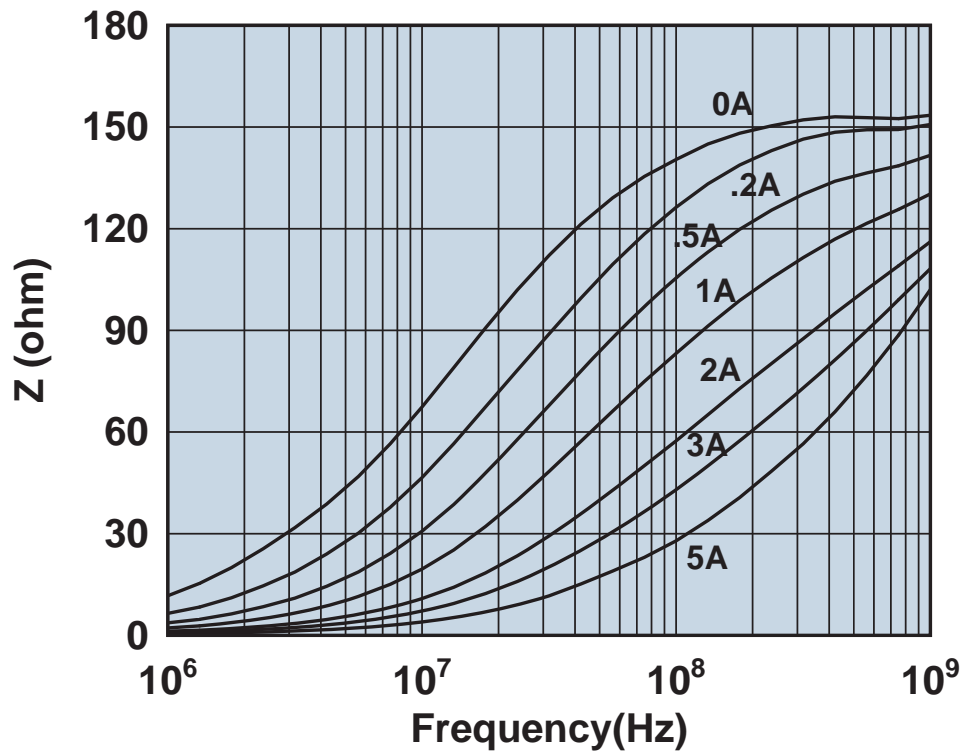

Impedance vs. frequency with dc bias.

2743008112

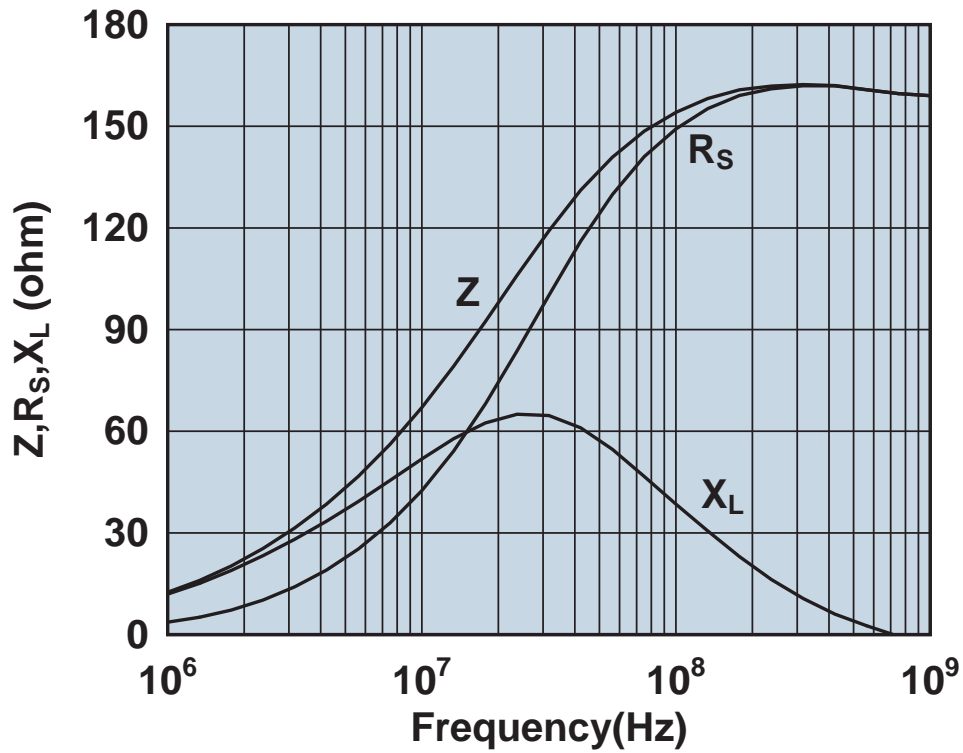

Impedance, reactance, and resistance vs. frequency.

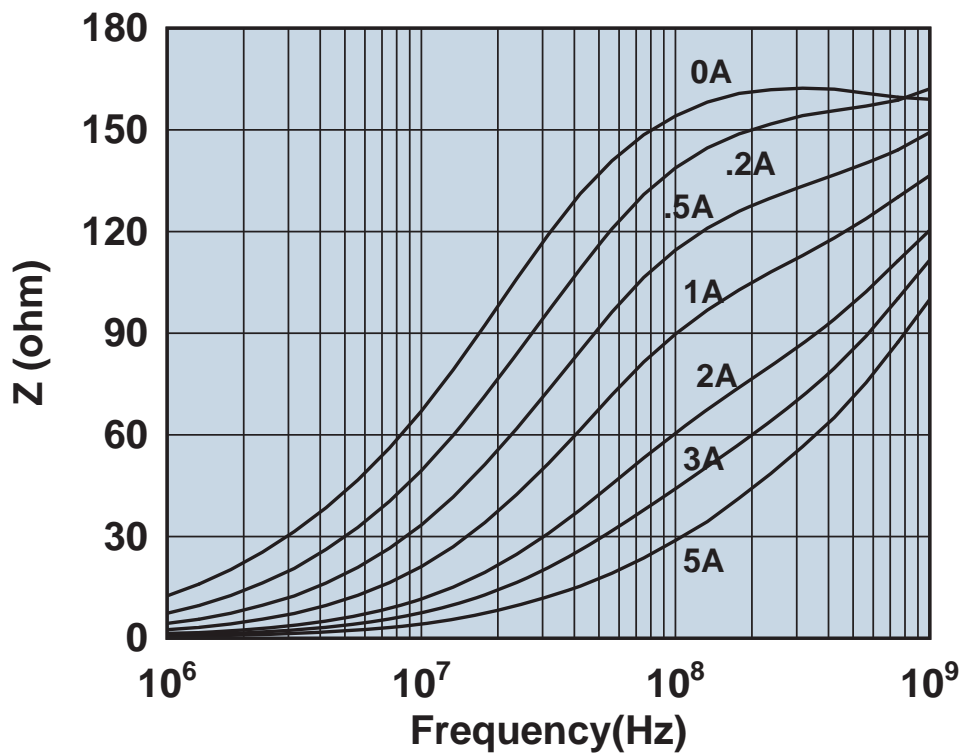

Impedance vs. frequency with dc bias.

2743009112

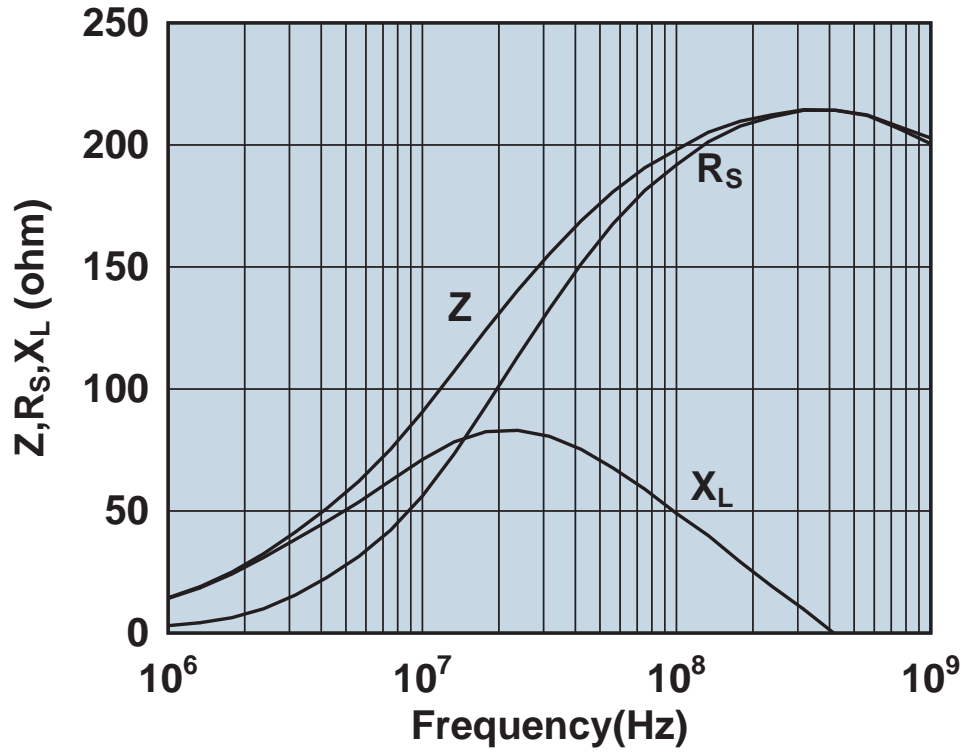

Impedance, reactance, and resistance vs. frequency.

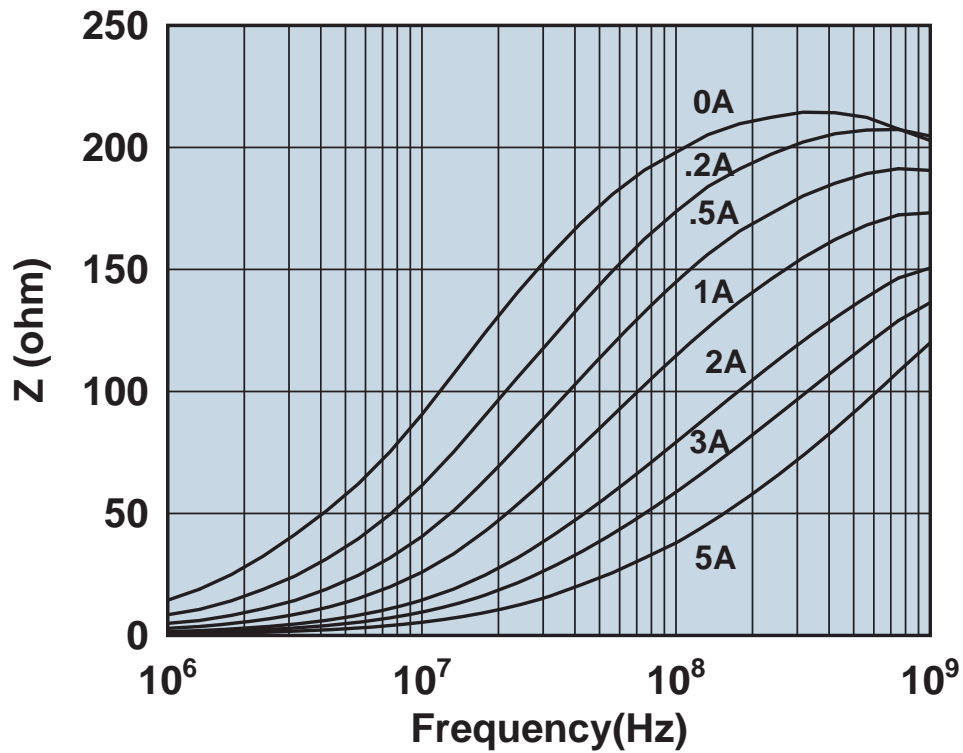

Impedance vs. frequency with dc bias.

2743012201

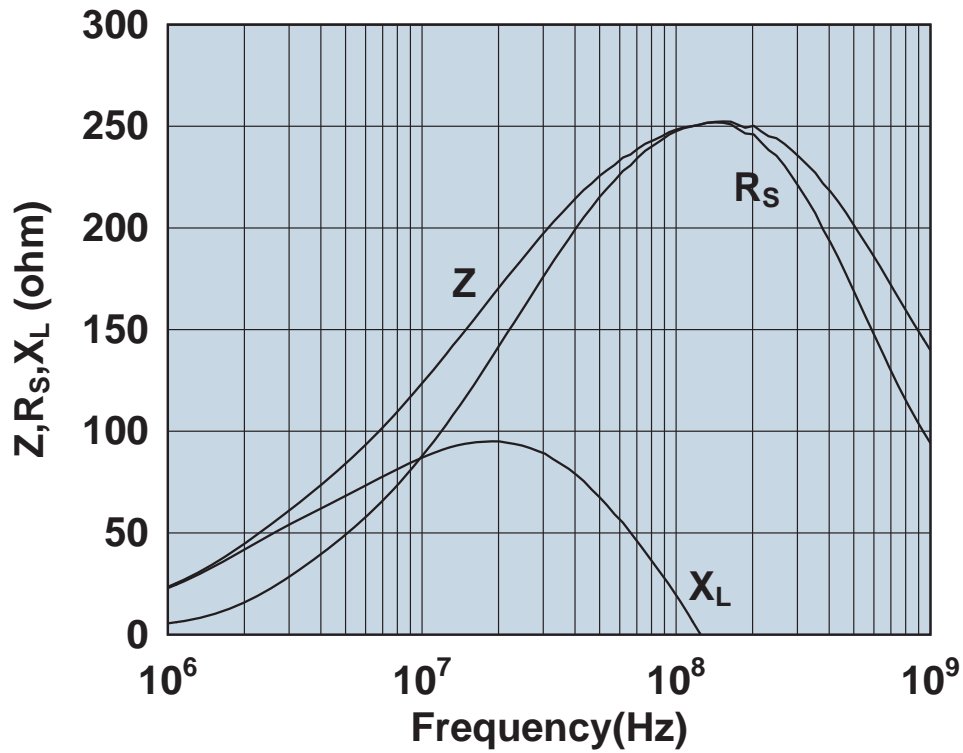

Impedance, reactance, and resistance vs. frequency.

2743012201

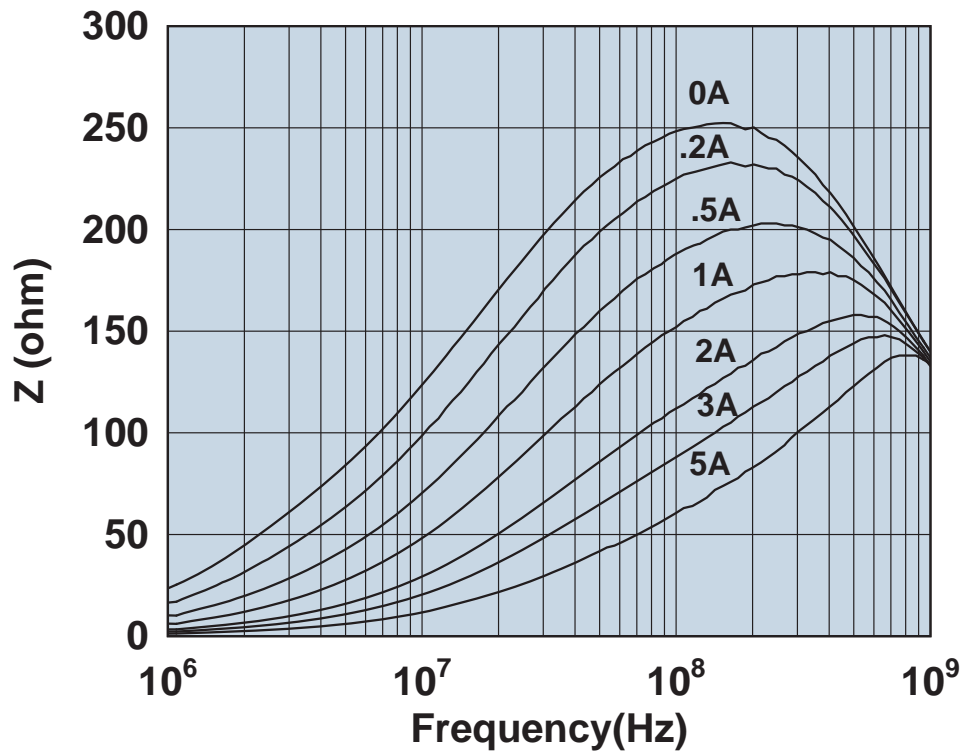

Impedance vs. frequency with dc bias.

2743013211

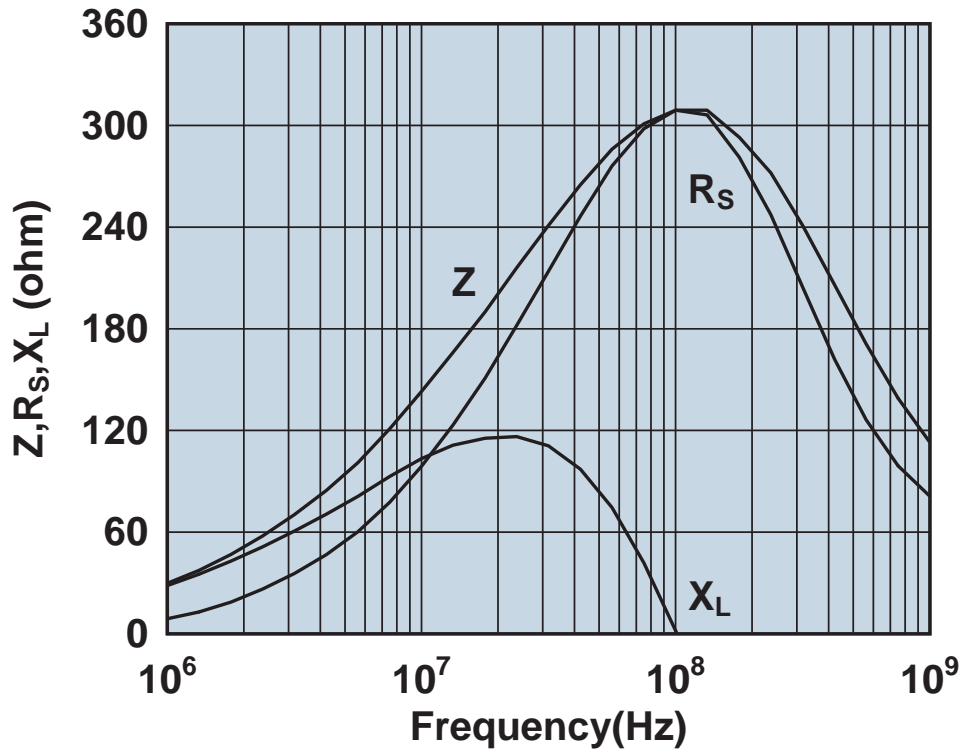

Impedance, reactance, and resistance vs. frequency.

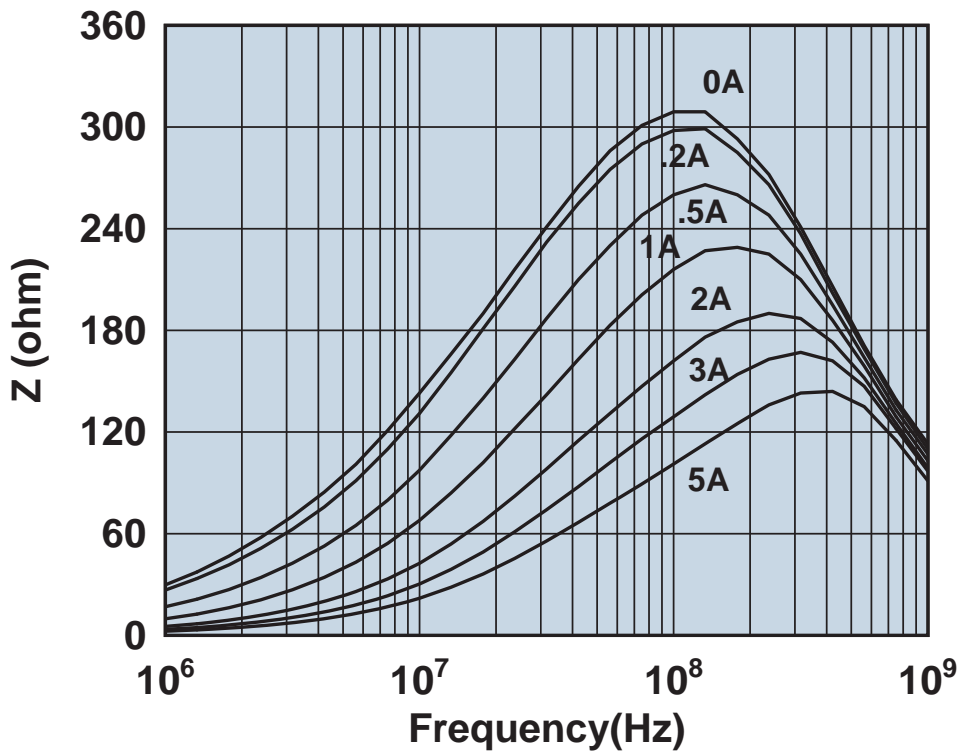

Impedance vs. frequency with dc bias.

2743014221

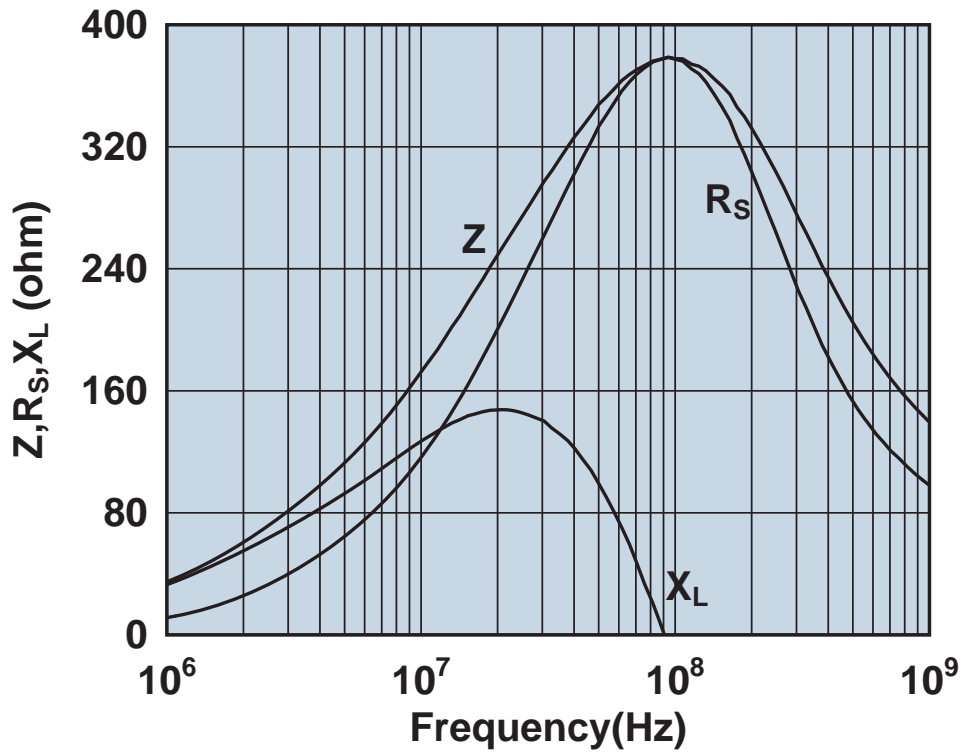

Impedance, reactance, and resistance vs. frequency.

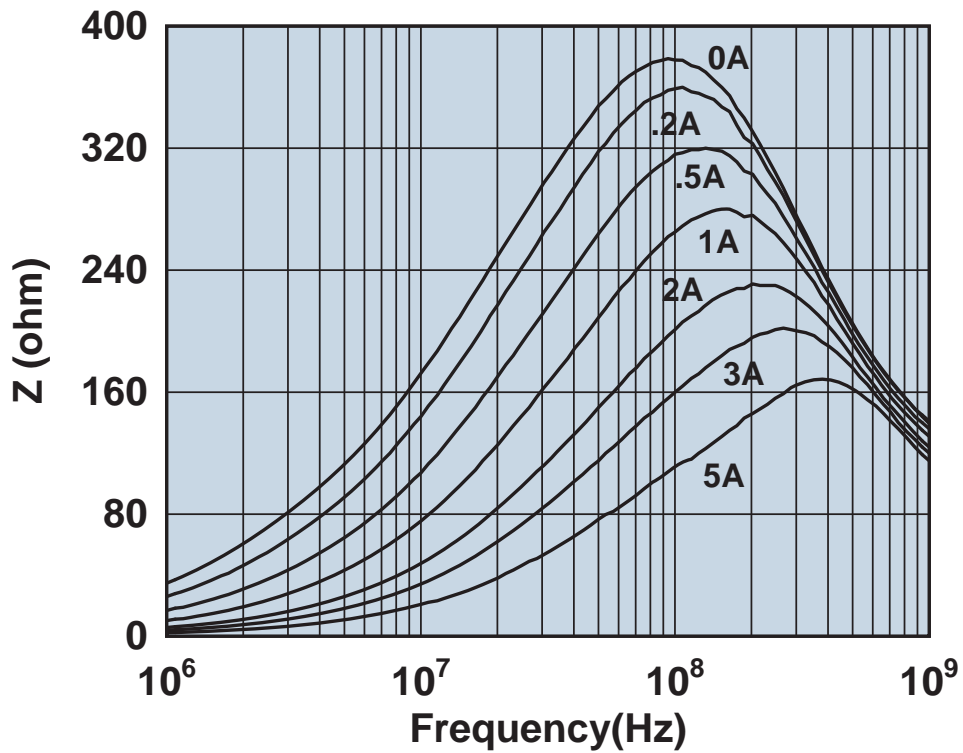

Impedance vs. frequency with dc bias.

2743015112

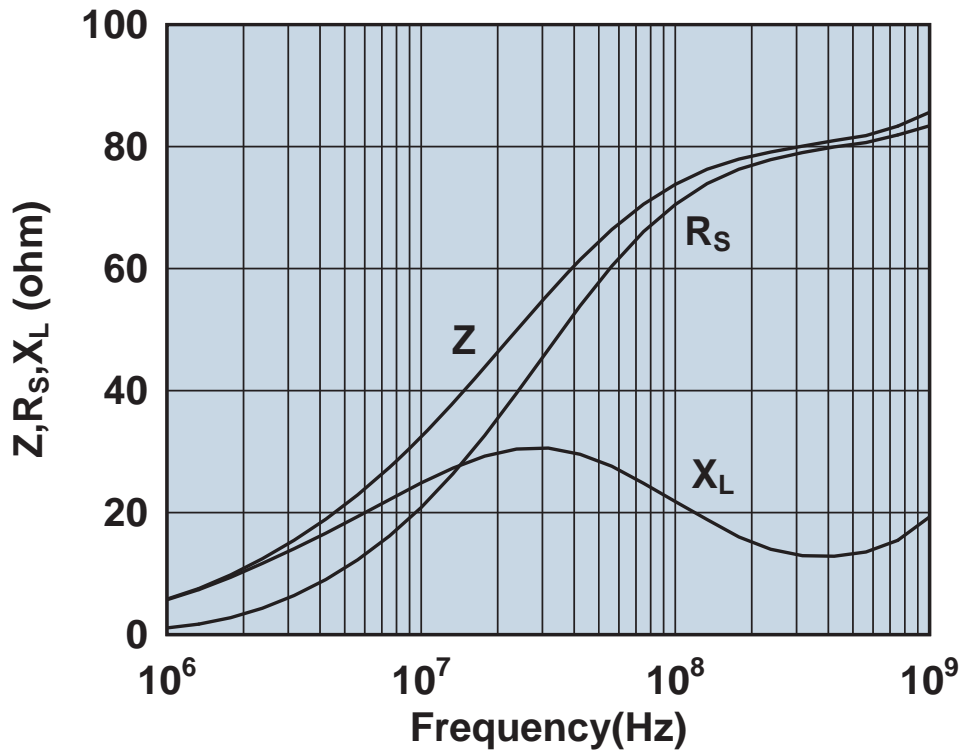

Impedance, reactance, and resistance vs. frequency.

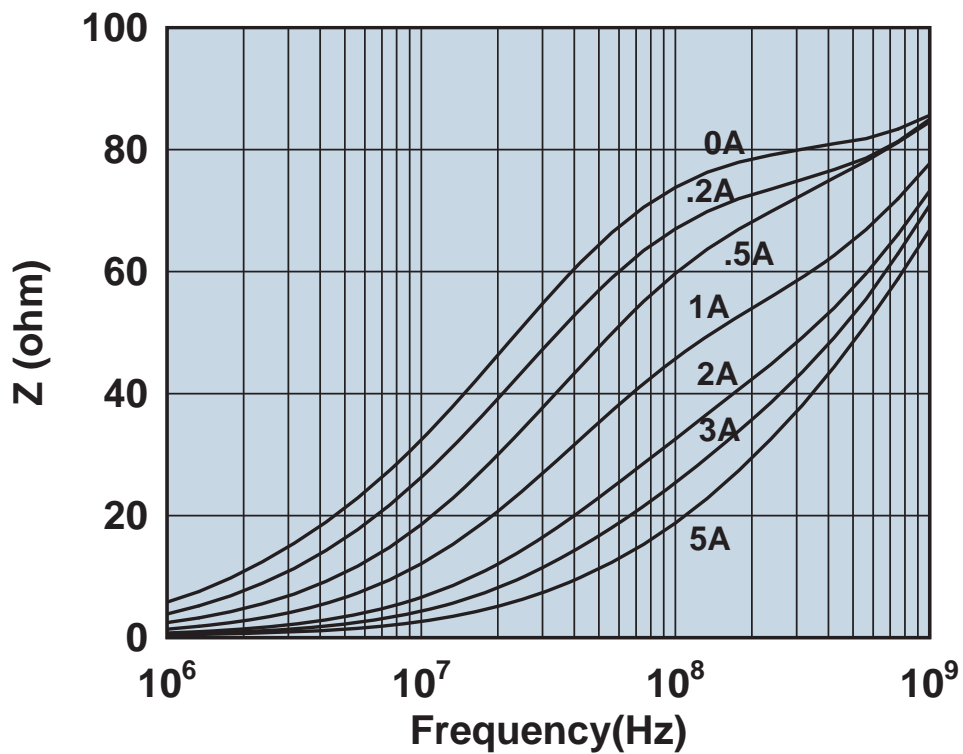

Impedance vs. frequency with dc bias.

2743019447

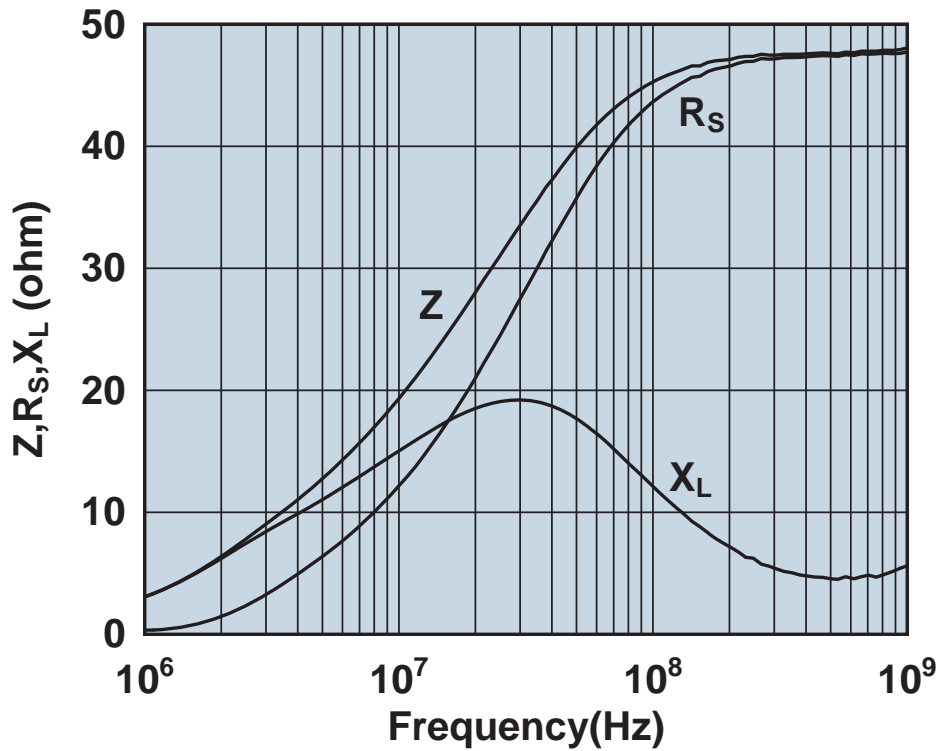

Impedance, reactance, and resistance vs. frequency.

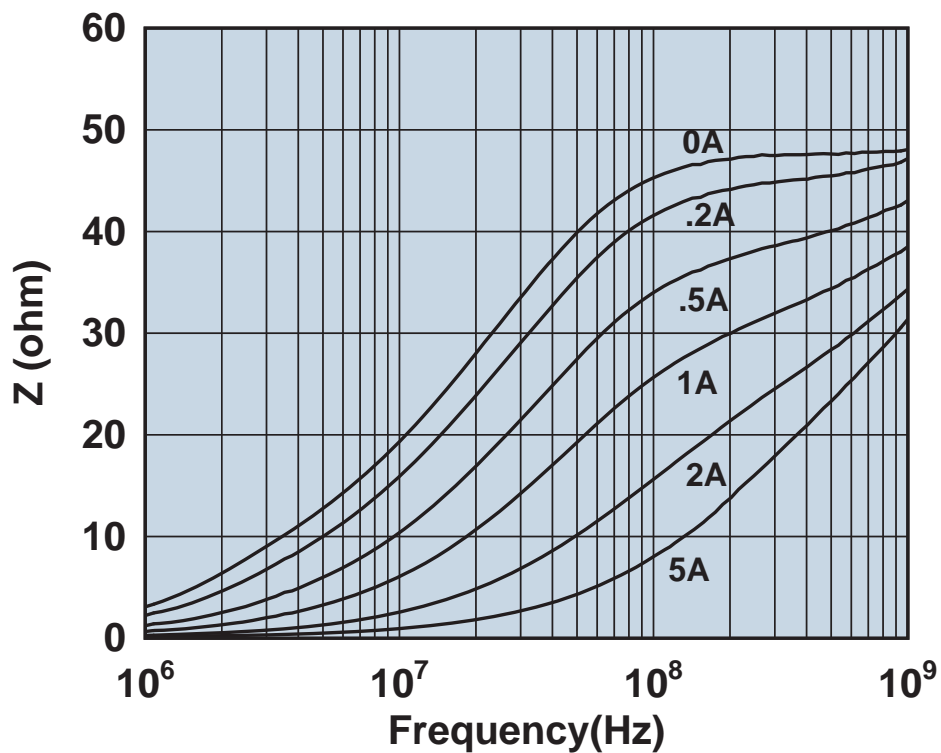

Impedance vs. frequency with dc bias.

2743021447

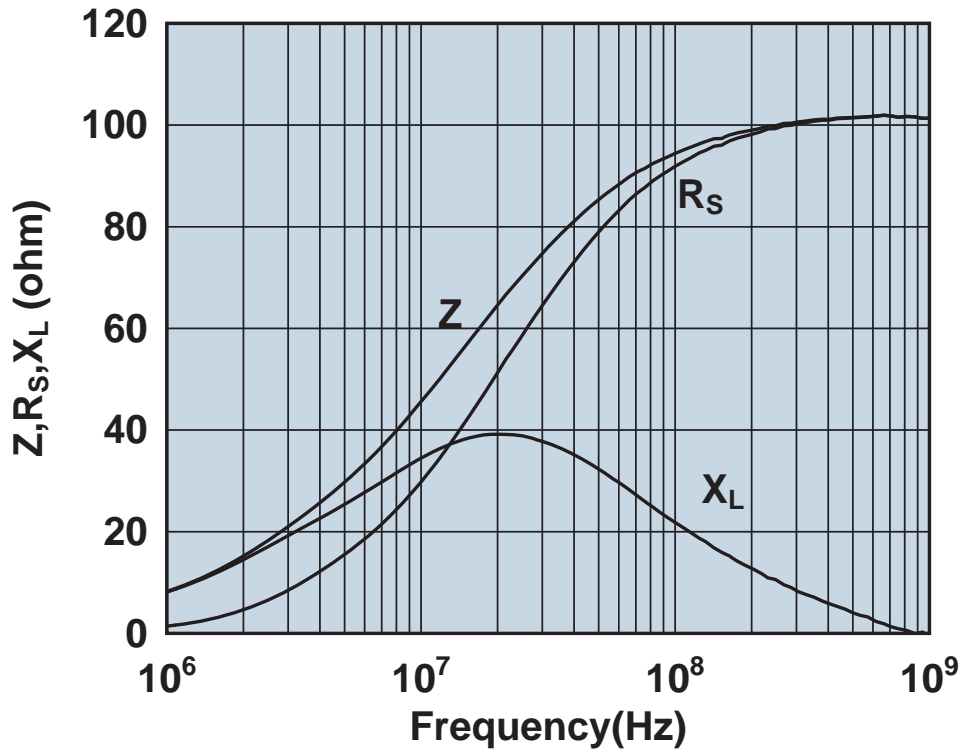

Impedance, reactance, and resistance vs. frequency.

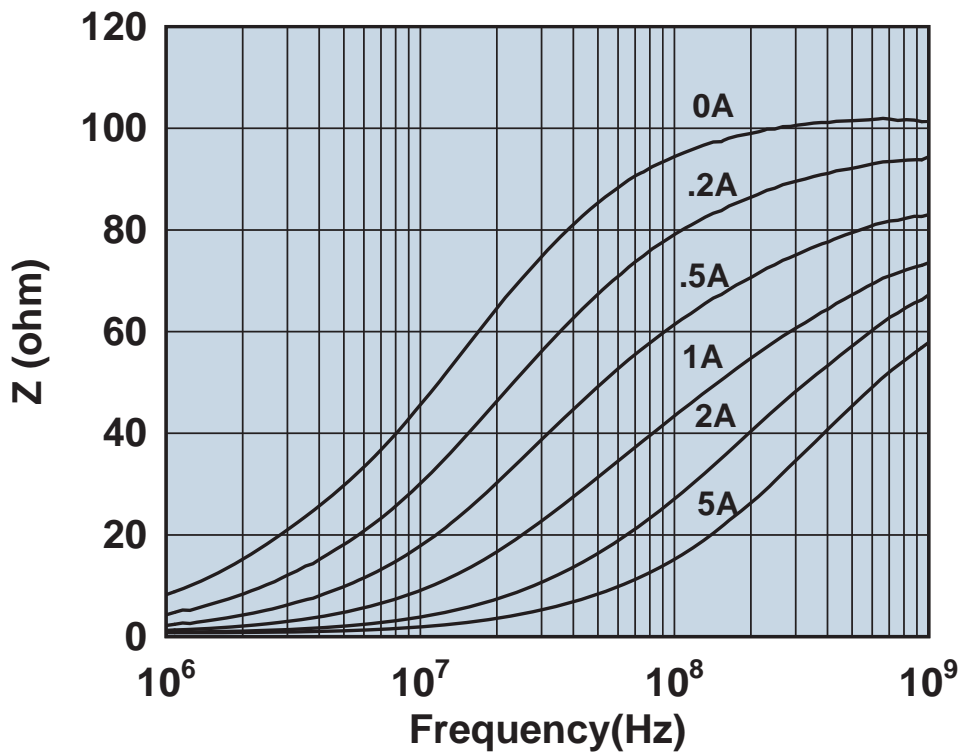

Impedance vs. frequency with dc bias.

2743037447

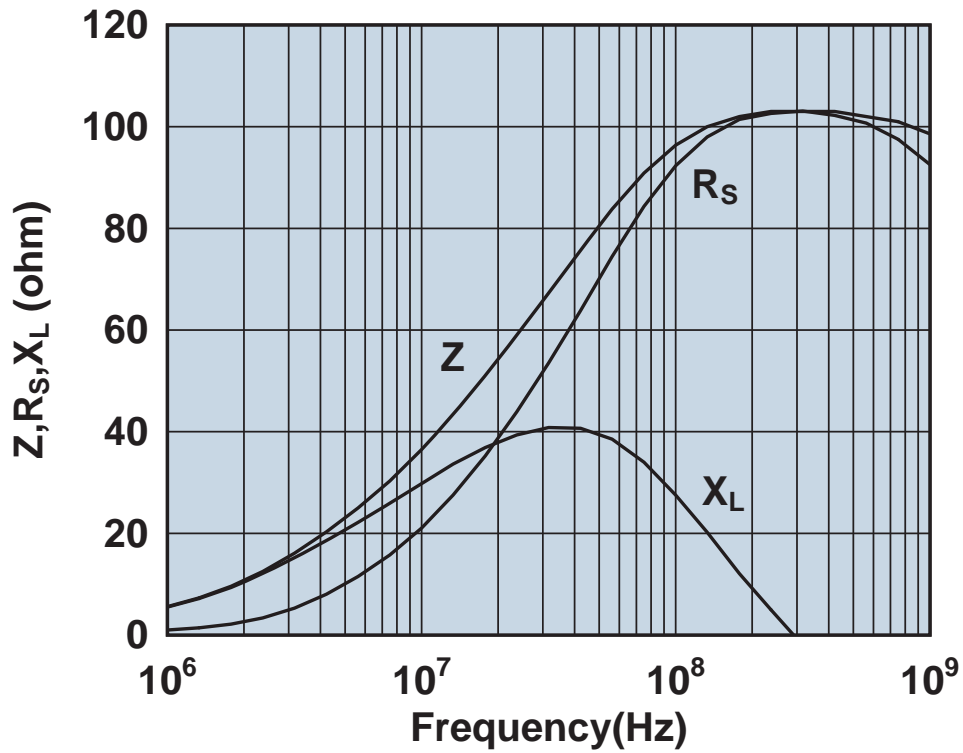

Impedance, reactance, and resistance vs. frequency.

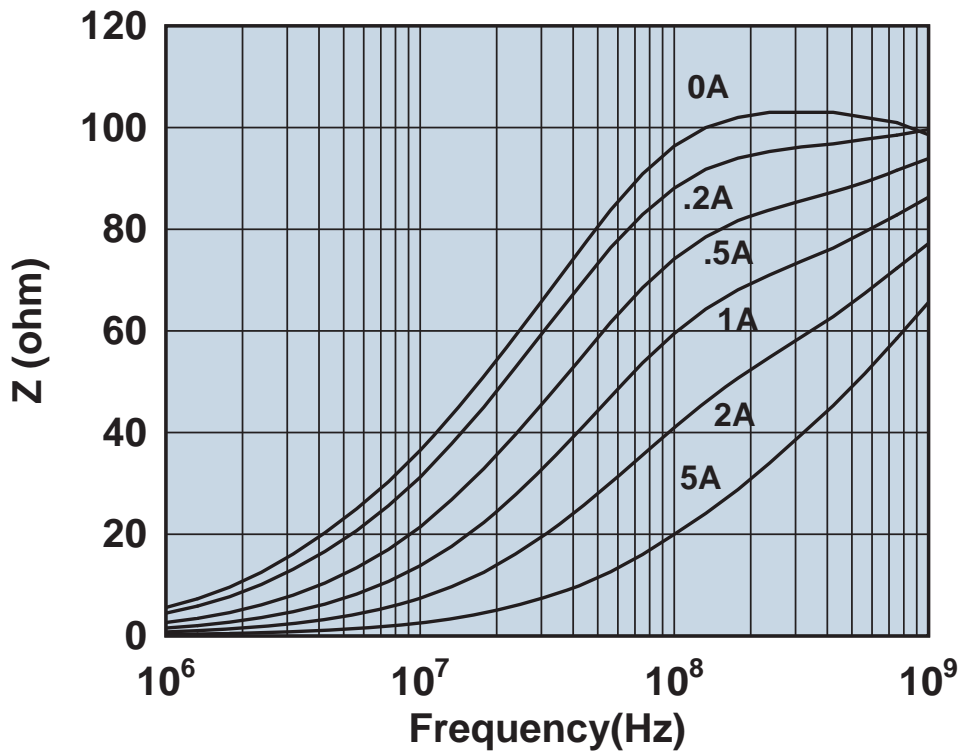

Impedance vs. frequency with dc bias.

2744040447

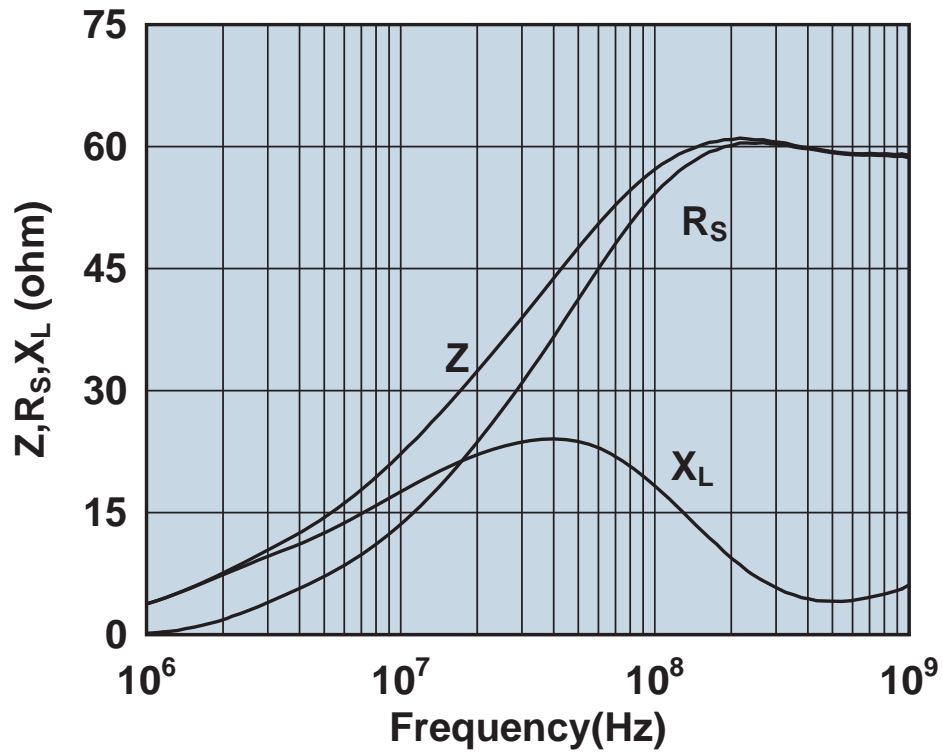

Impedance, reactance, and resistance vs. frequency.

2744040447

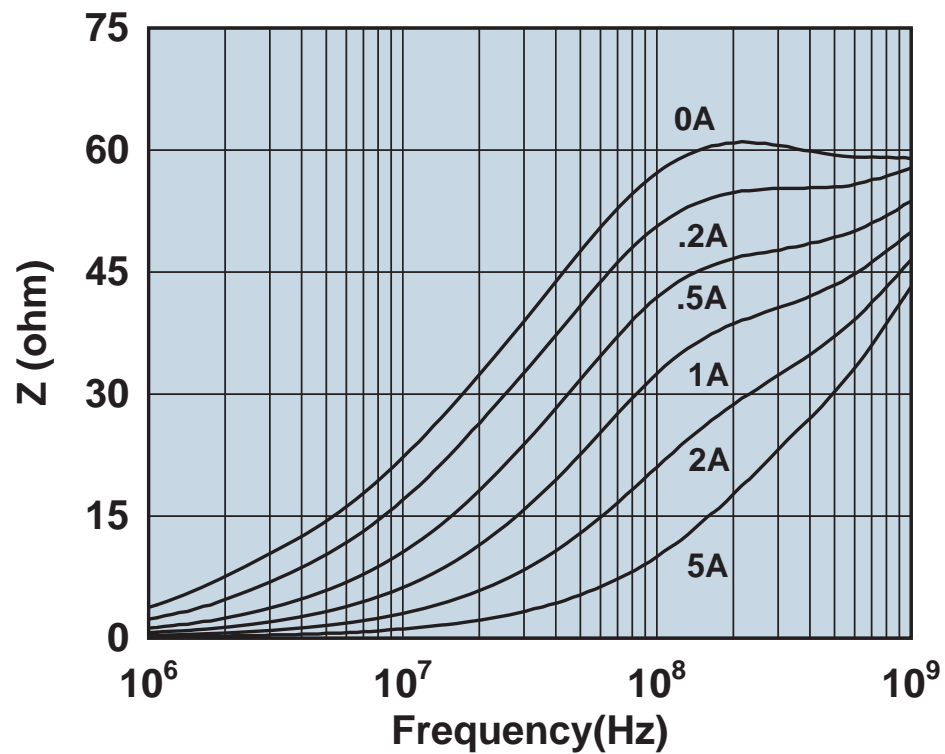

Impedance vs. frequency with dc bias.

2744041447

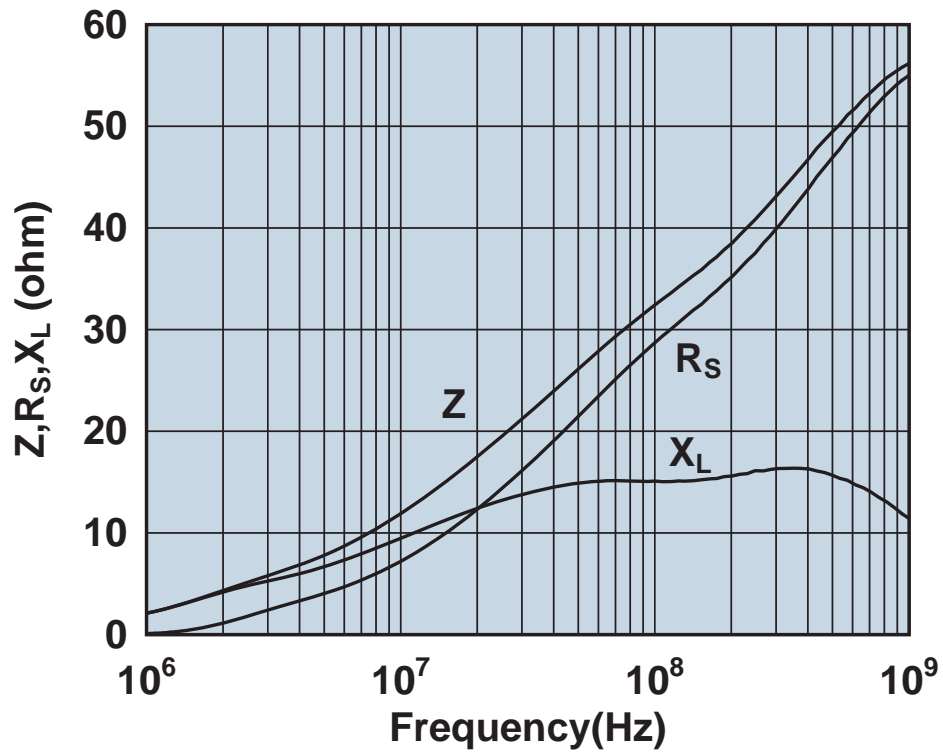

Impedance, reactance, and resistance vs. frequency.

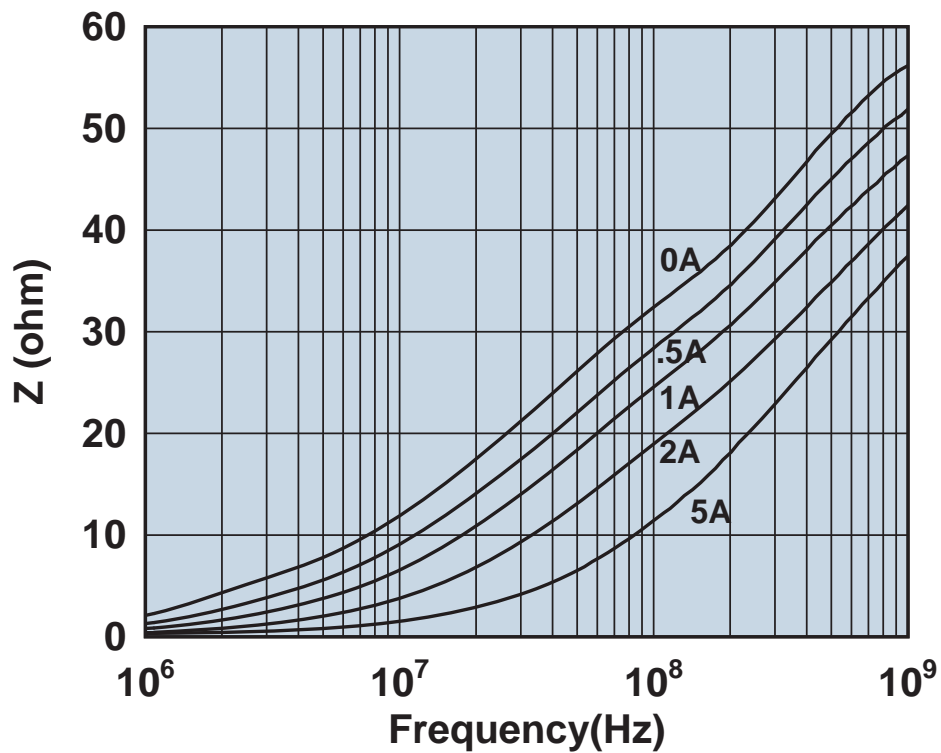

Impedance vs. frequency with dc bias.

274404447

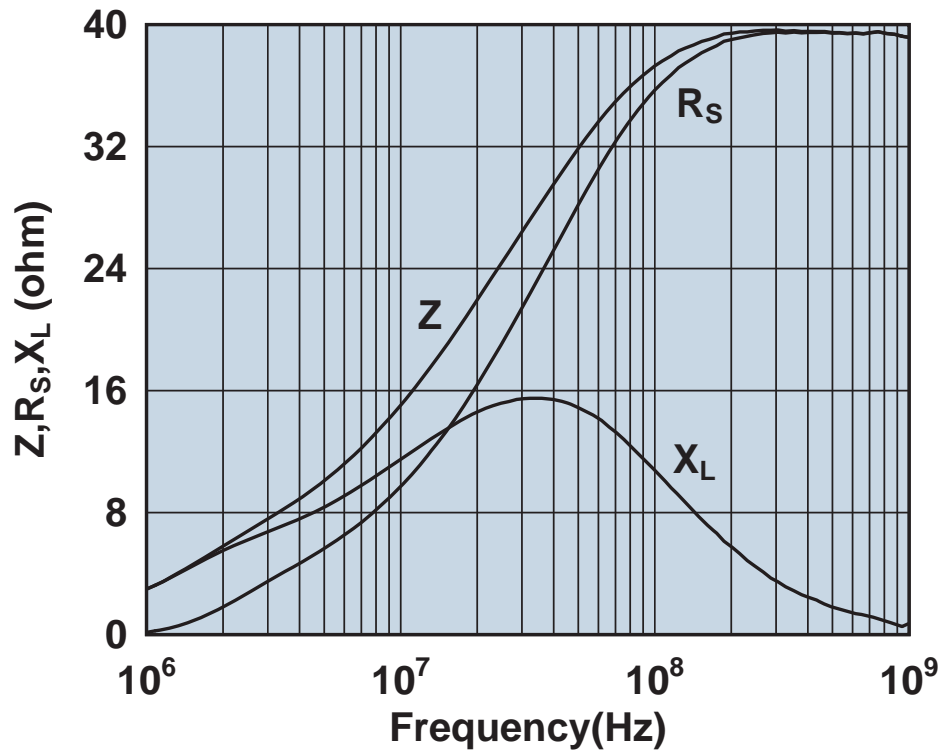

Impedance, reactance, and resistance vs. frequency.

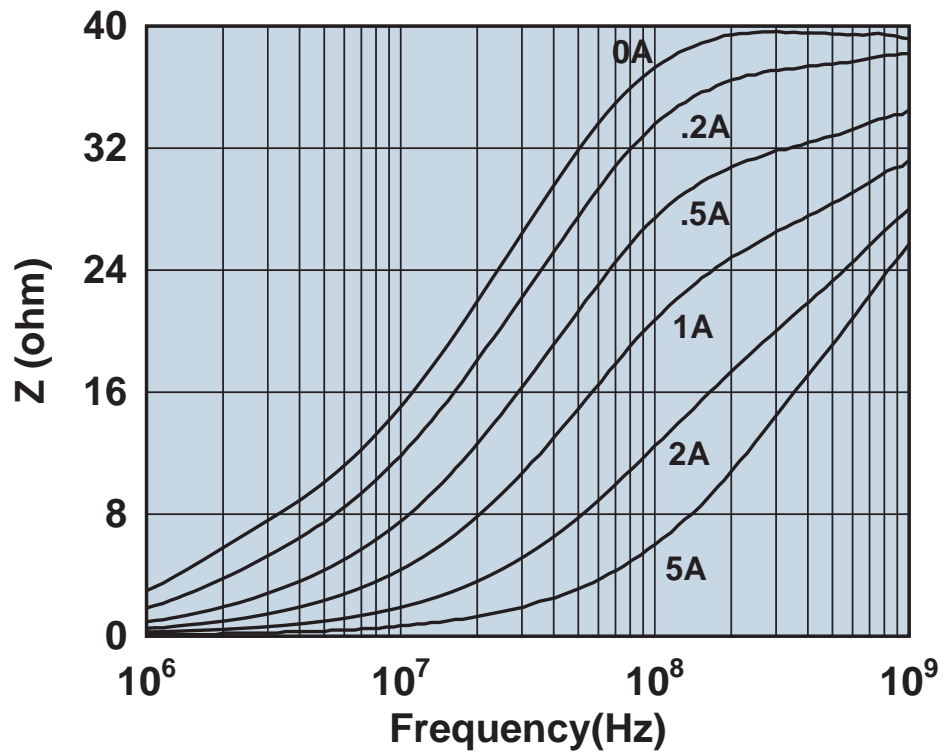

Impedance vs. frequency with dc bias.

2744045447

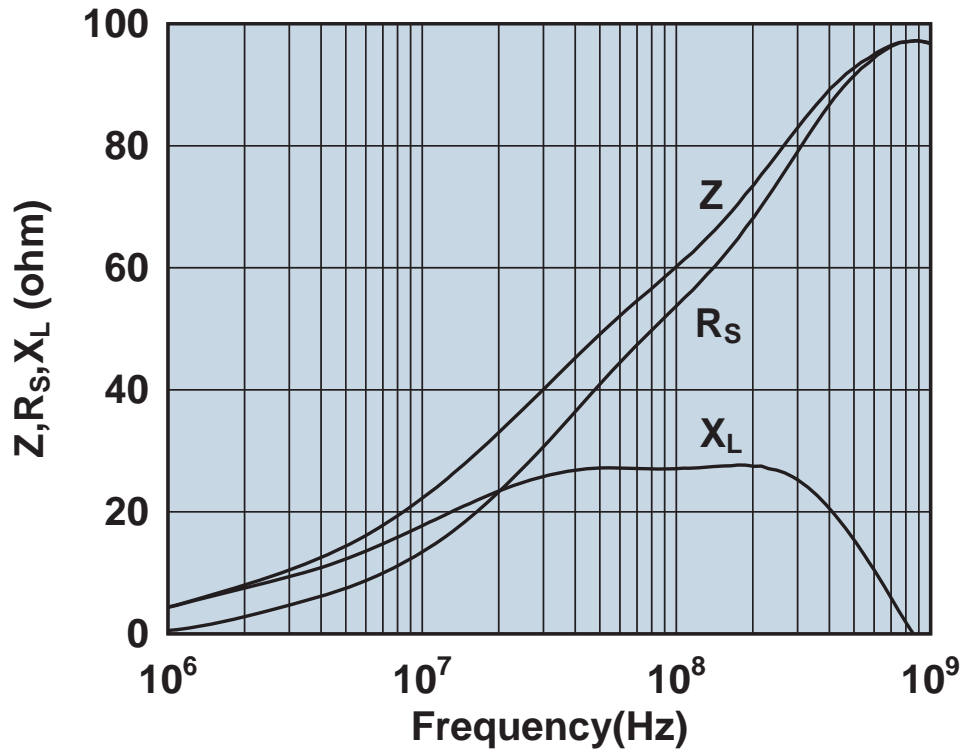

Impedance, reactance, and resistance vs. frequency.

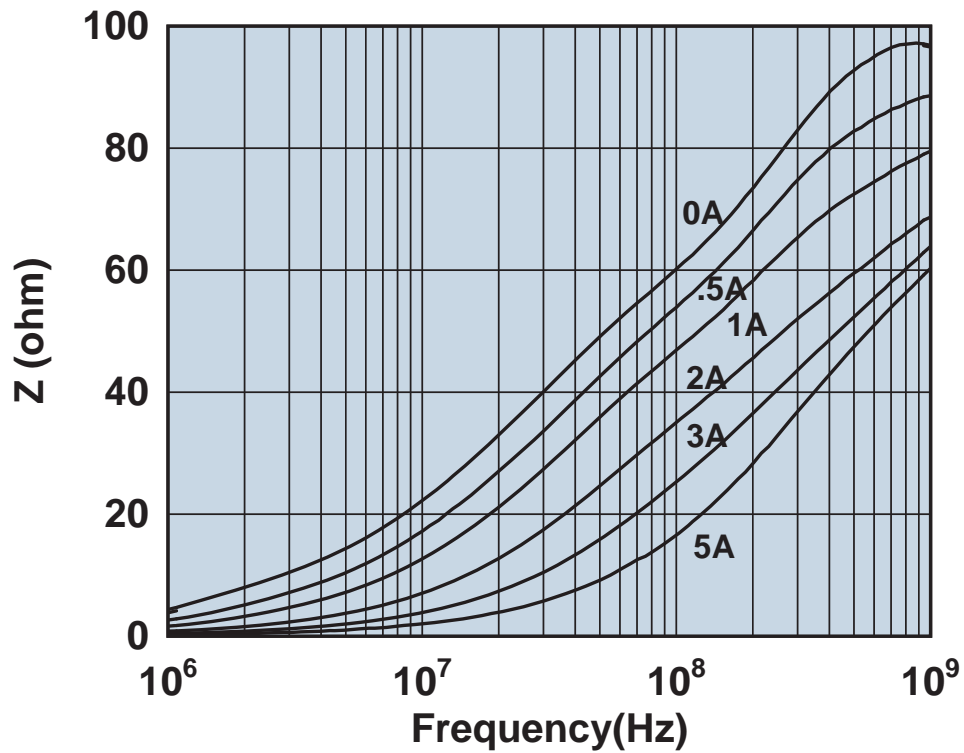

Impedance vs. frequency with dc bias.

2744051447

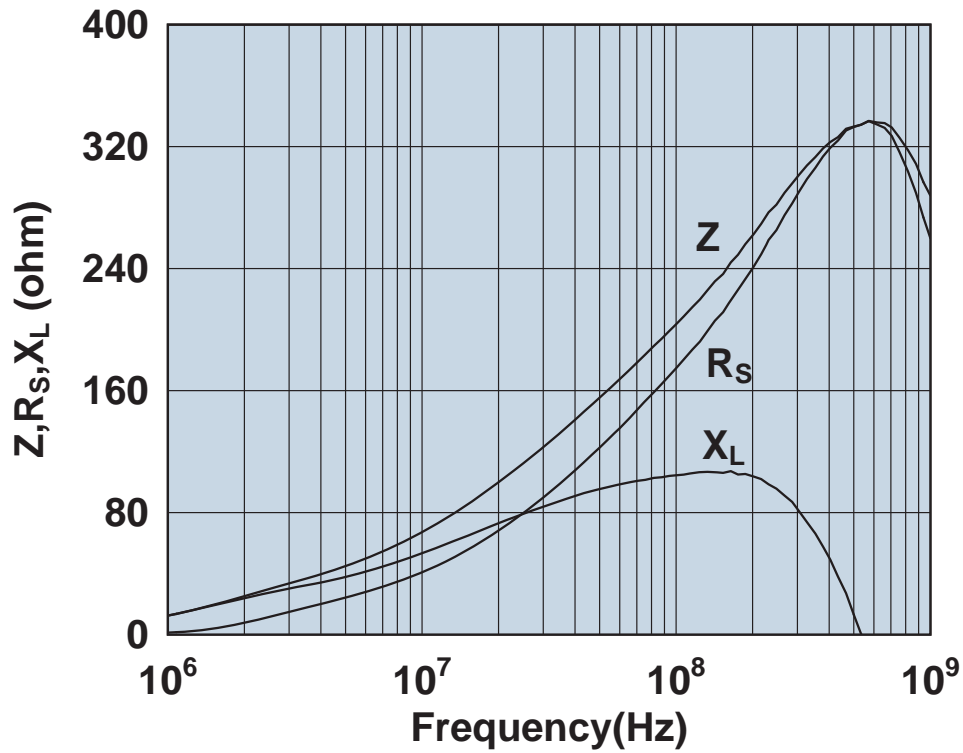

Impedance, reactance, and resistance vs. frequency.

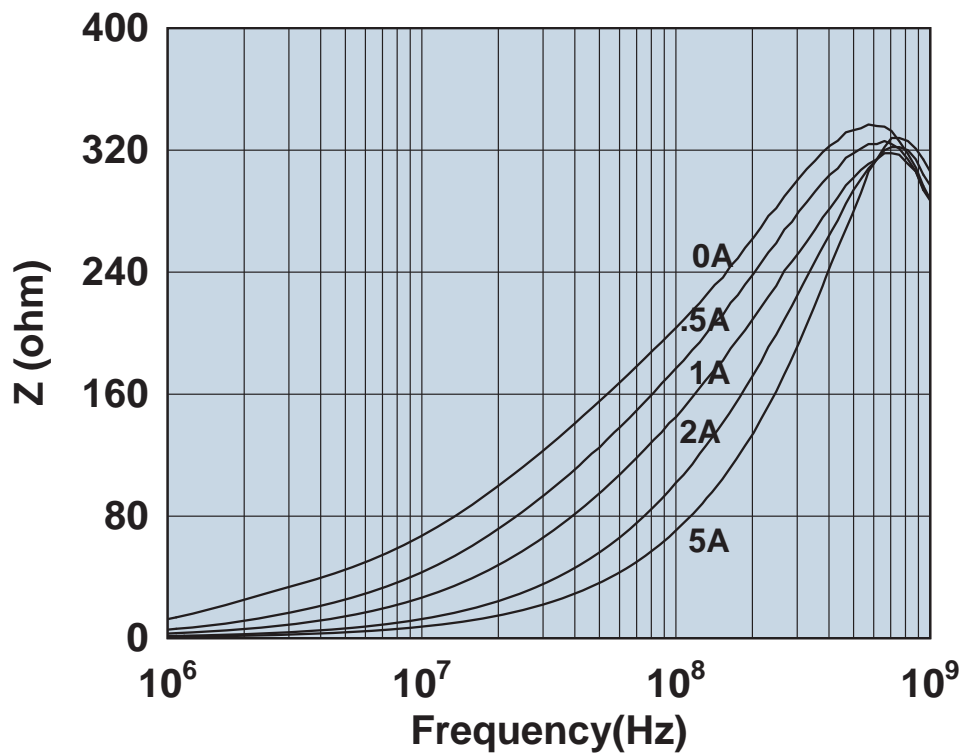

Impedance vs. frequency with dc bias.

2744065447

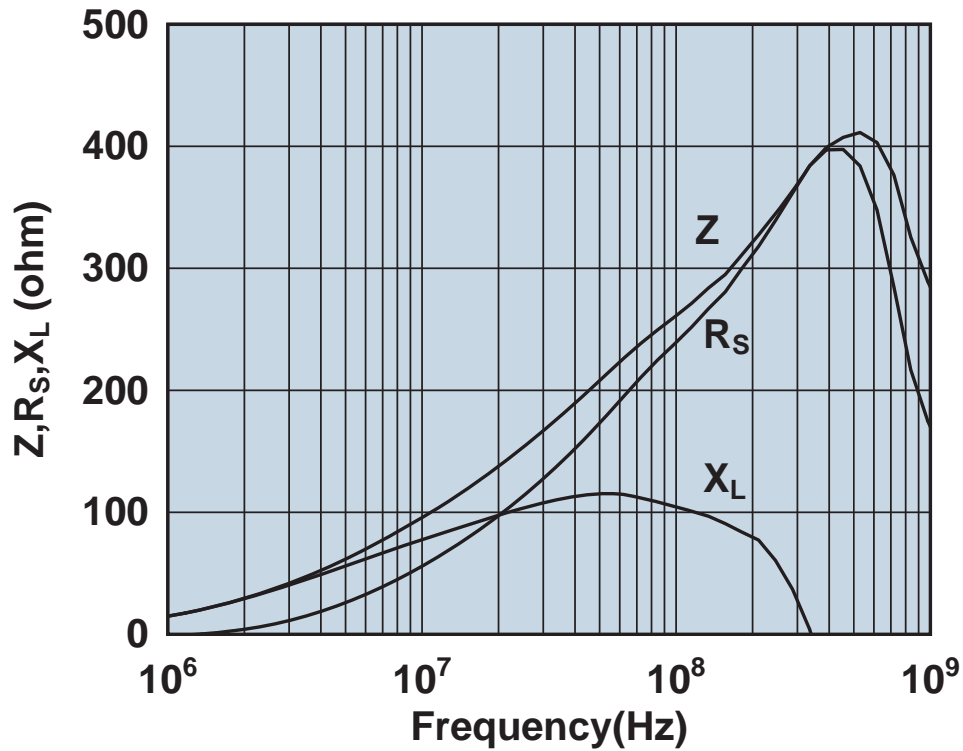

Impedance, reactance, and resistance vs. frequency.

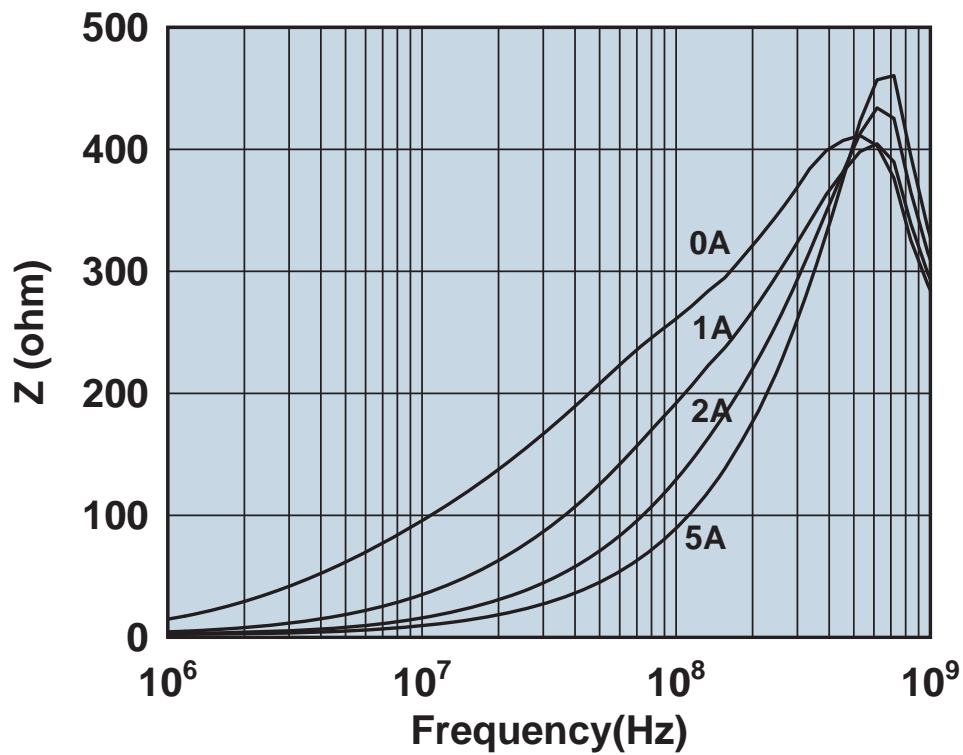

Impedance vs. frequency with dc bias.

274455567

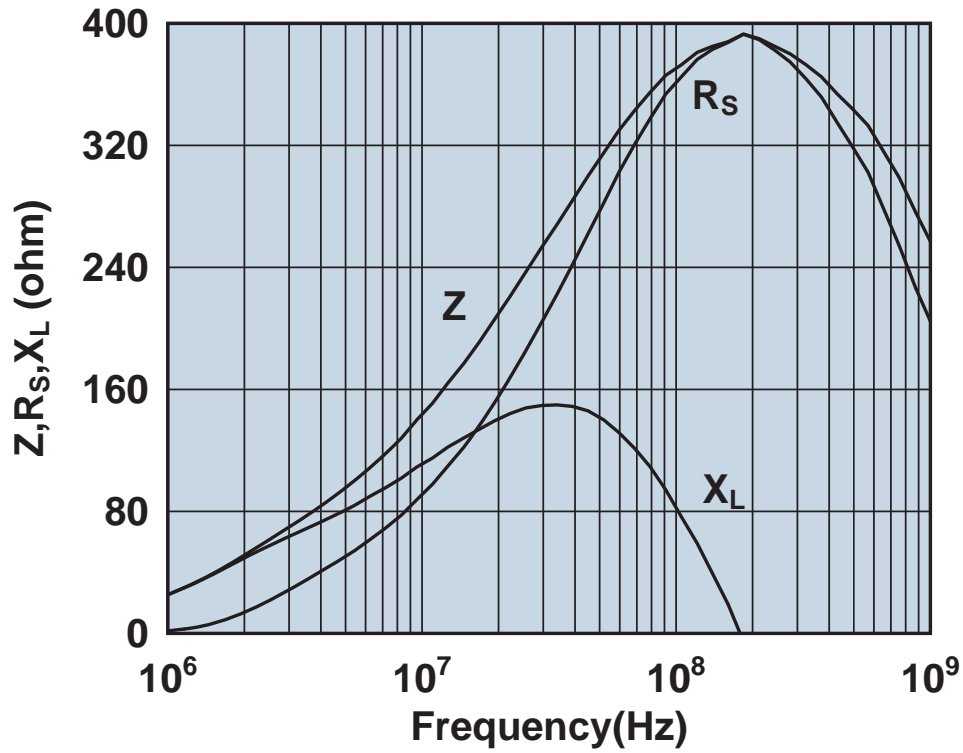

Impedance, reactance, and resistance vs. frequency.

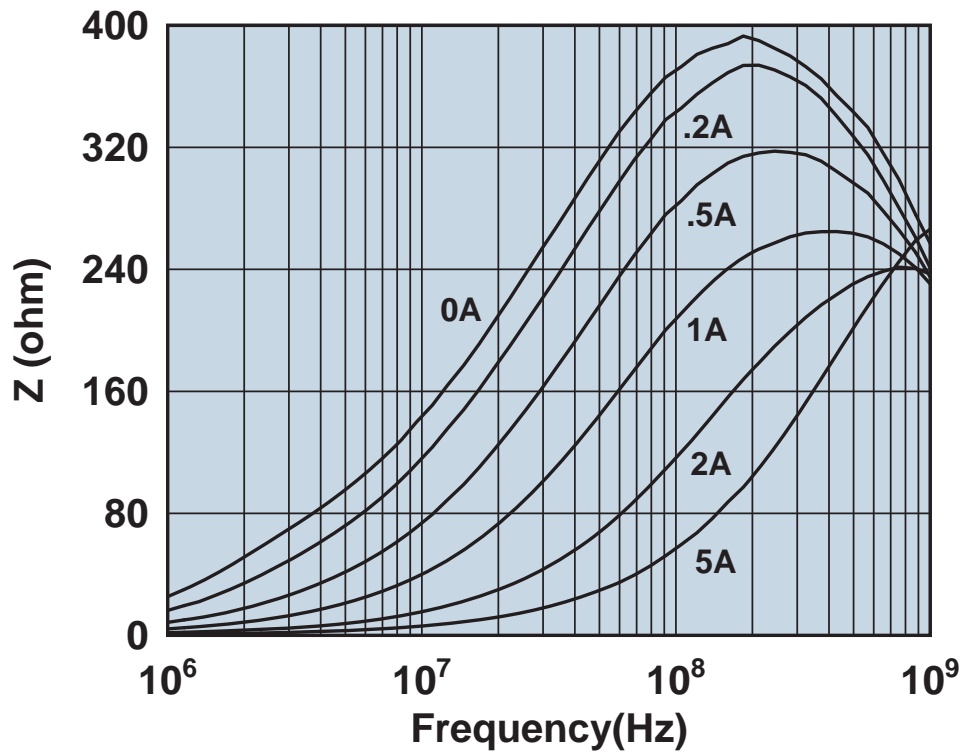

Impedance vs. frequency with dc bias.

274455577

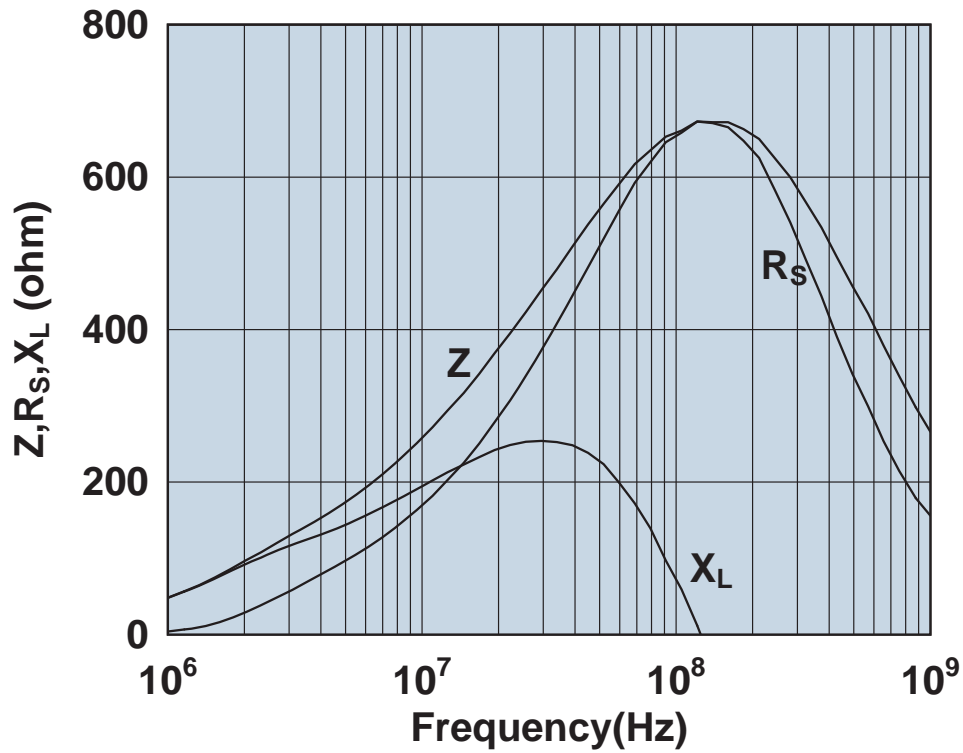

Impedance, reactance, and resistance vs. frequency.

274455577

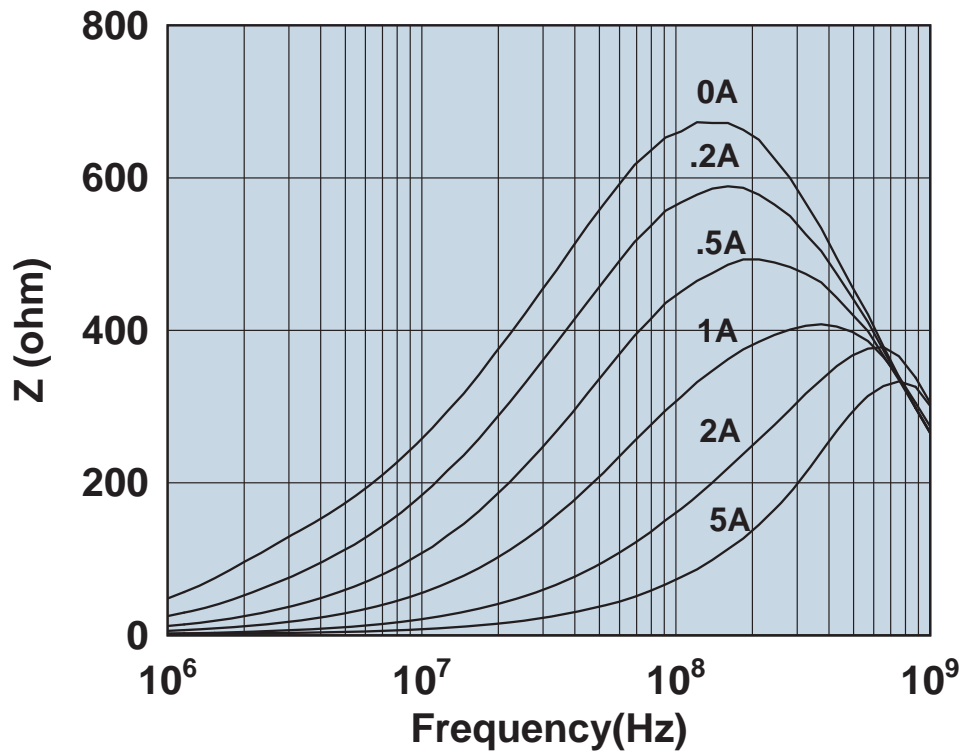

Impedance vs. frequency with dc bias.

2744770347

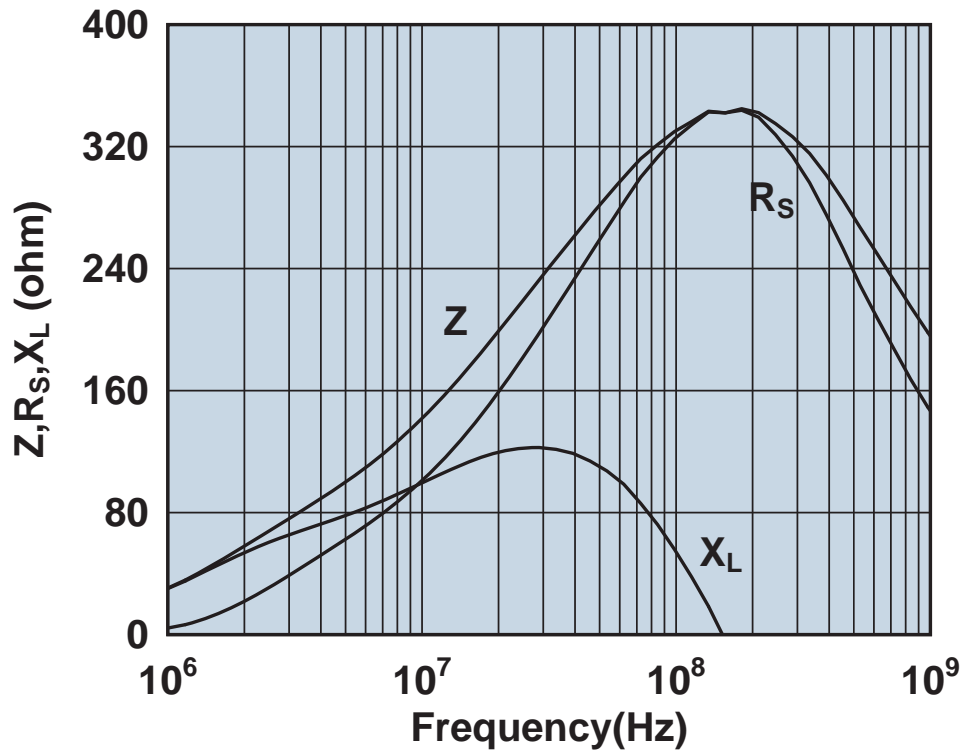

Impedance, reactance, and resistance vs. frequency.

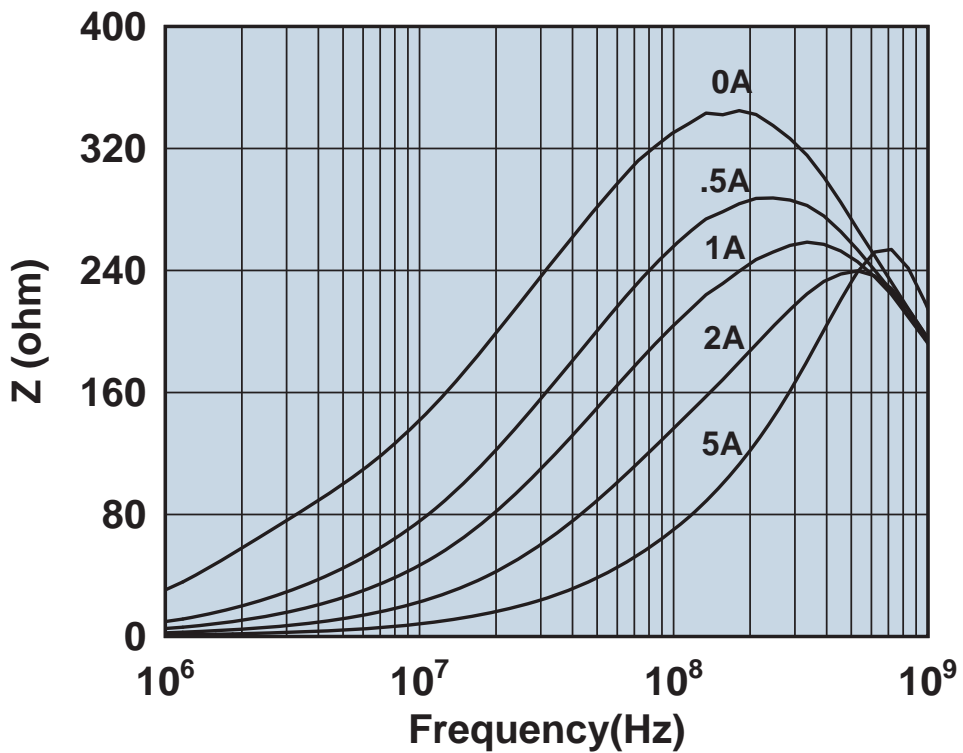

Impedance vs. frequency with dc bias.

2744776147

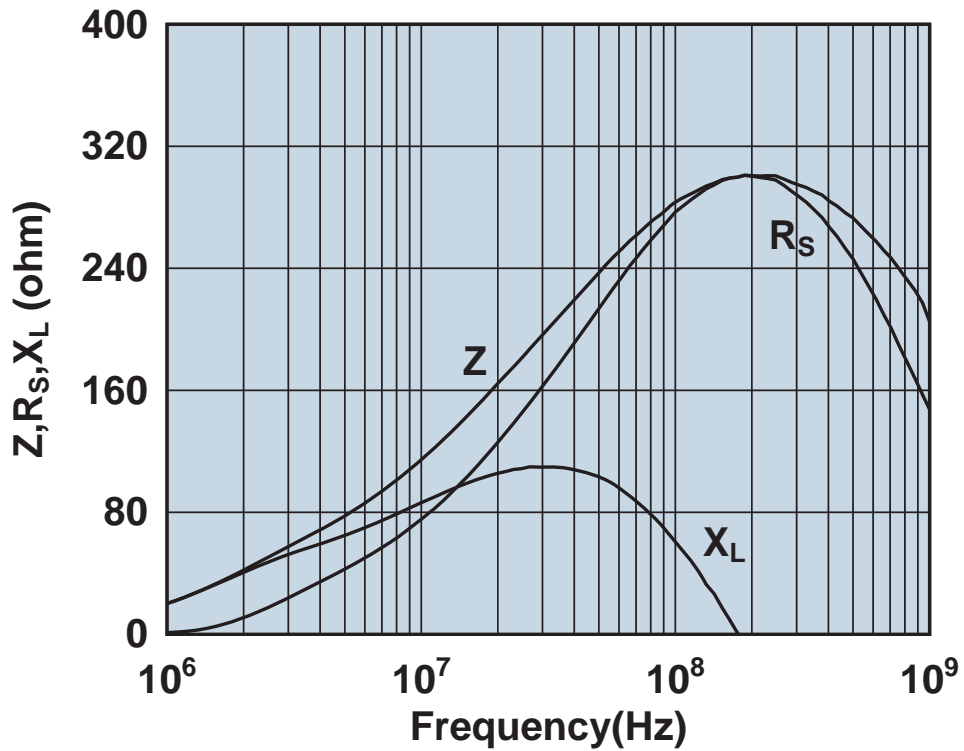

Impedance, reactance, and resistance vs. frequency.

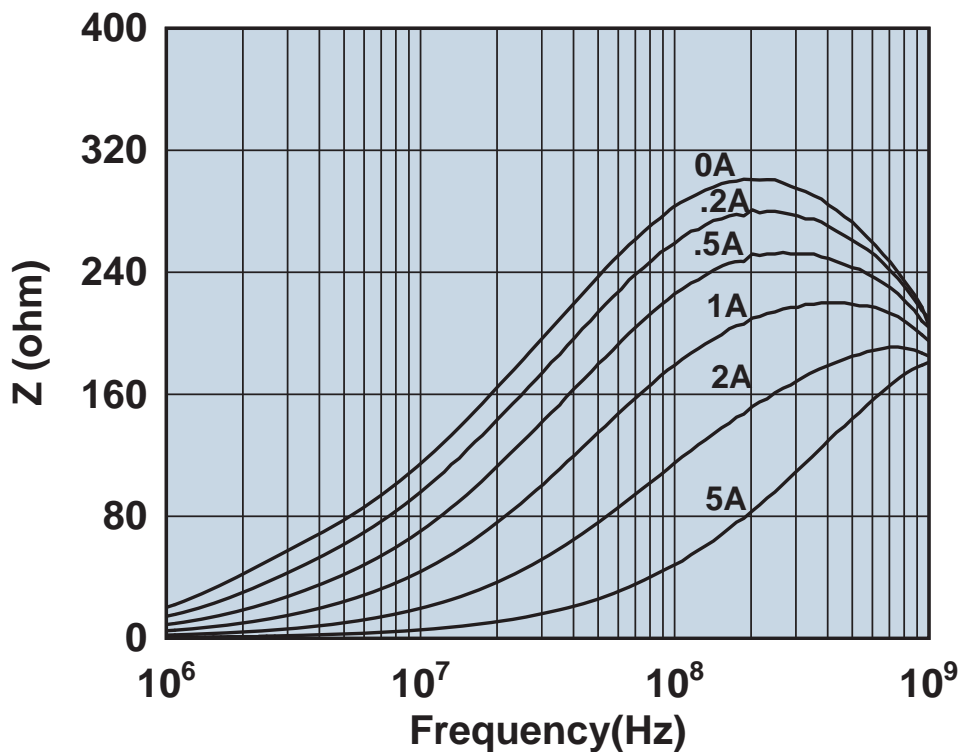

Impedance vs. frequency with dc bias.

2744778147

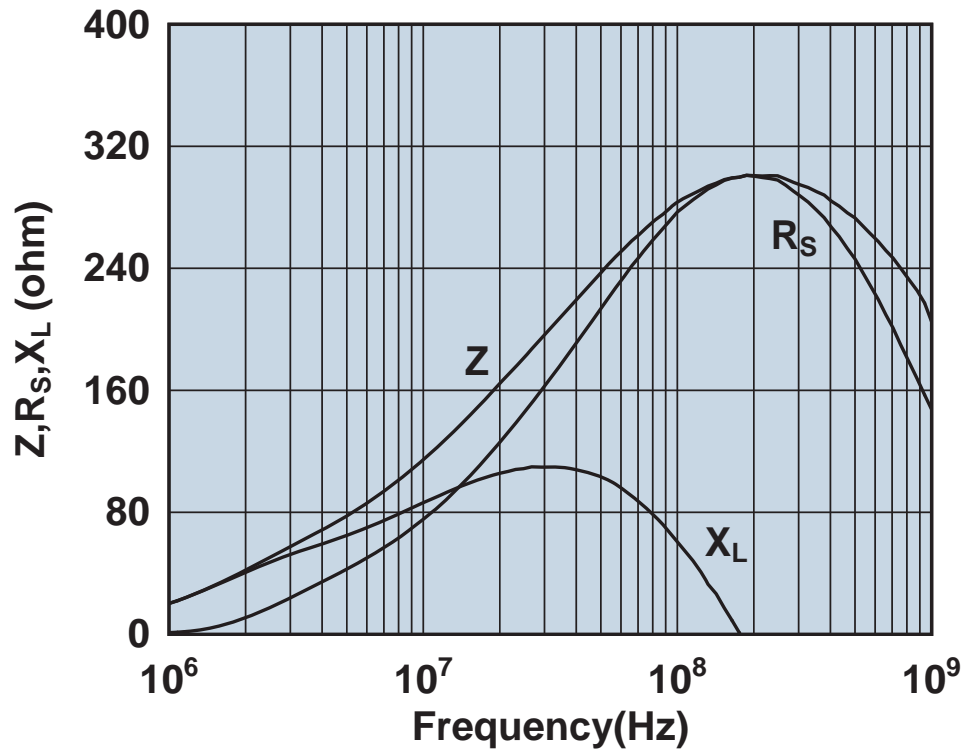

Impedance, reactance, and resistance vs. frequency.

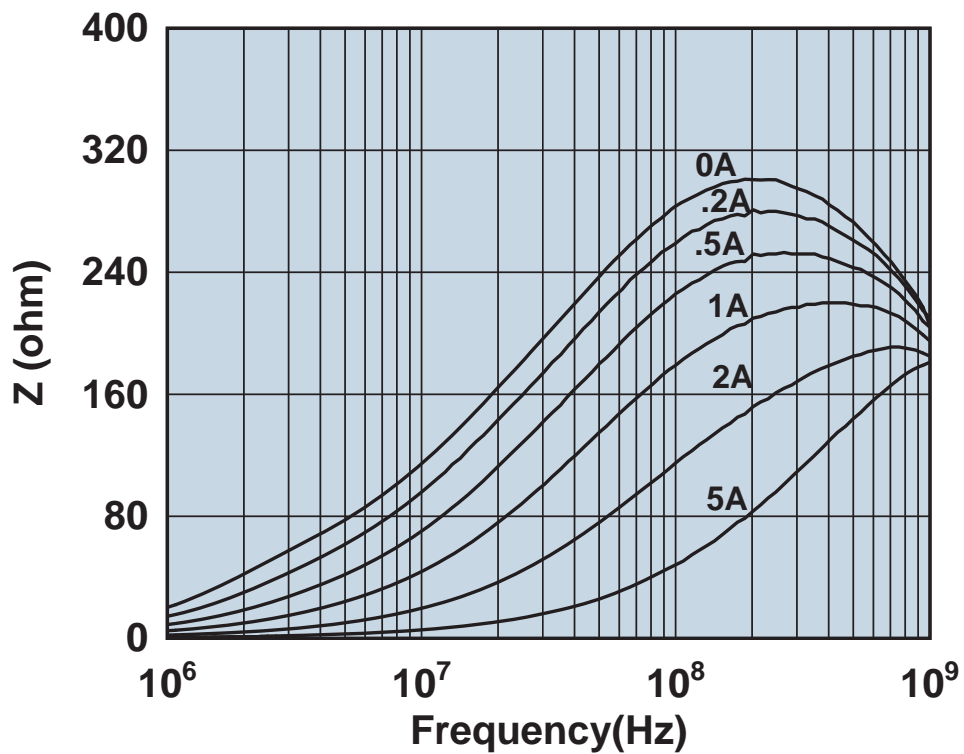

Impedance vs. frequency with dc bias.

2744778347

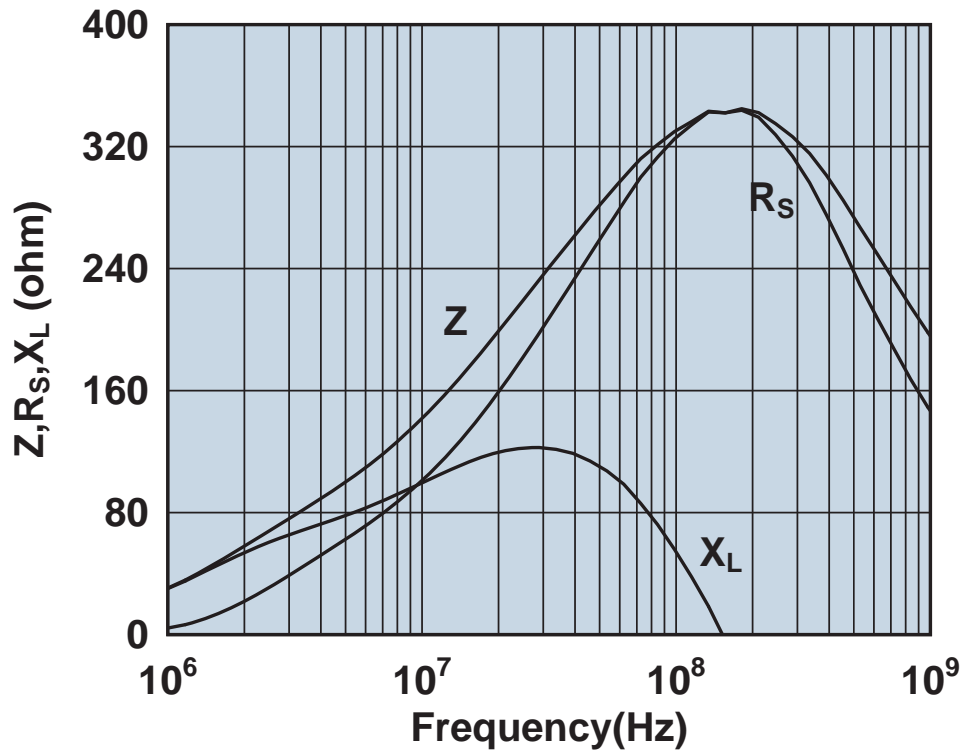

Impedance, reactance, and resistance vs. frequency.

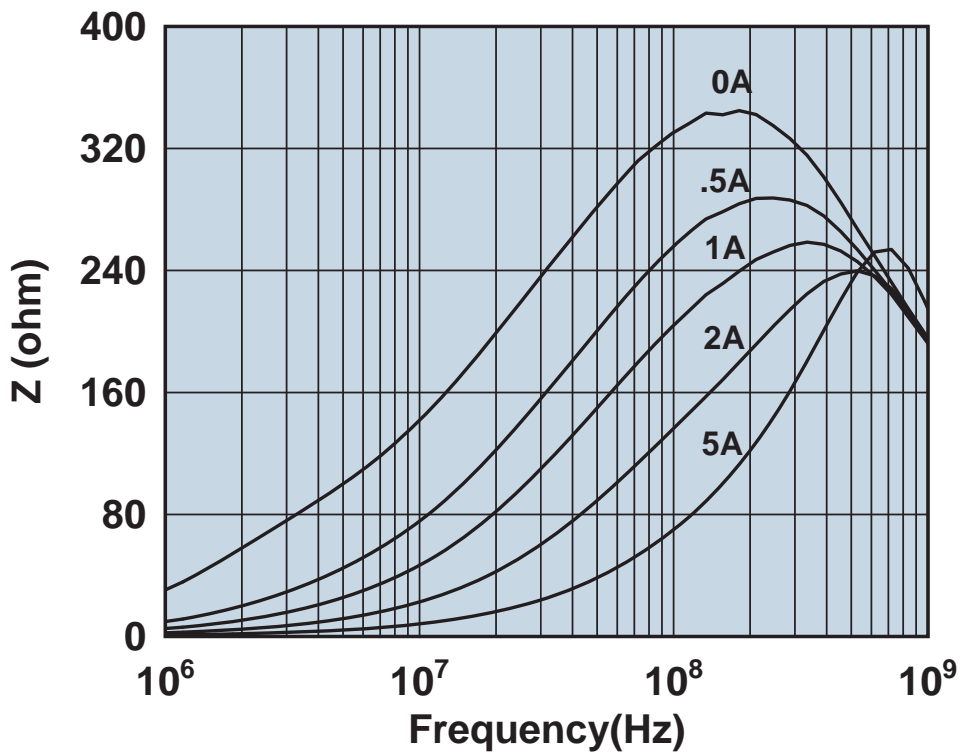

Impedance vs. frequency with dc bias.

2744780347

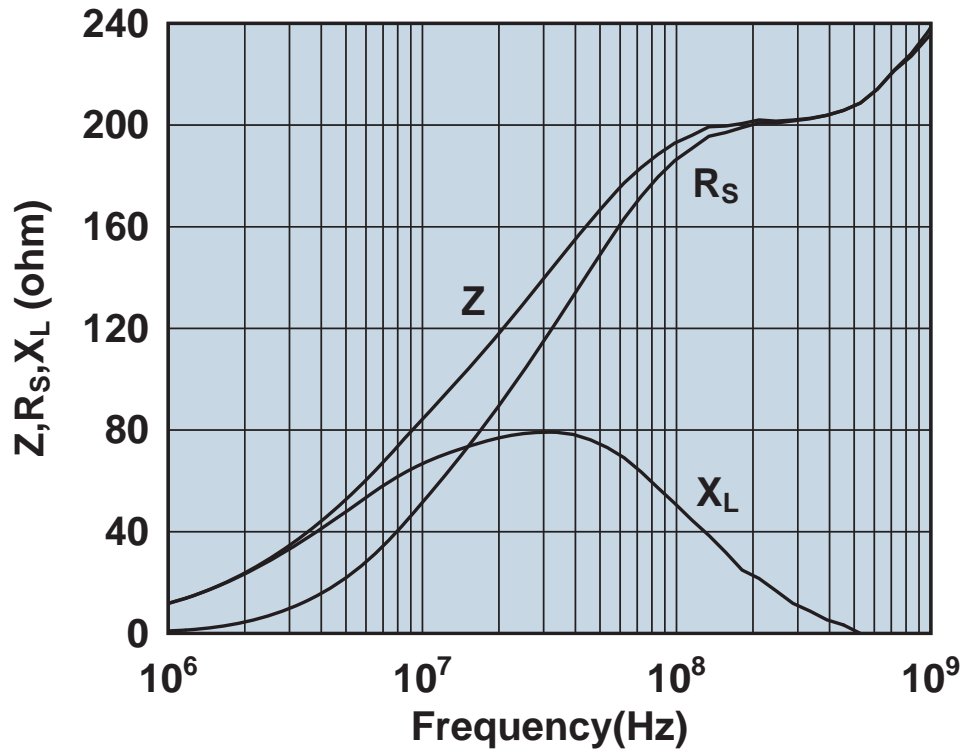

Impedance, reactance, and resistance vs. frequency.

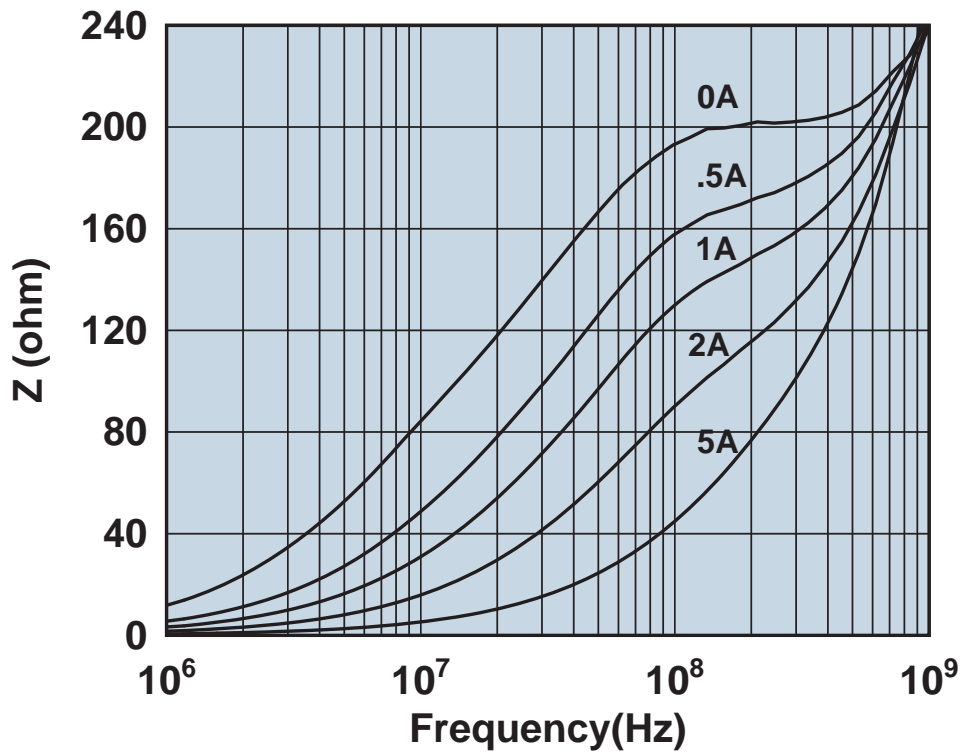

Impedance vs. frequency with dc bias.

2744786147

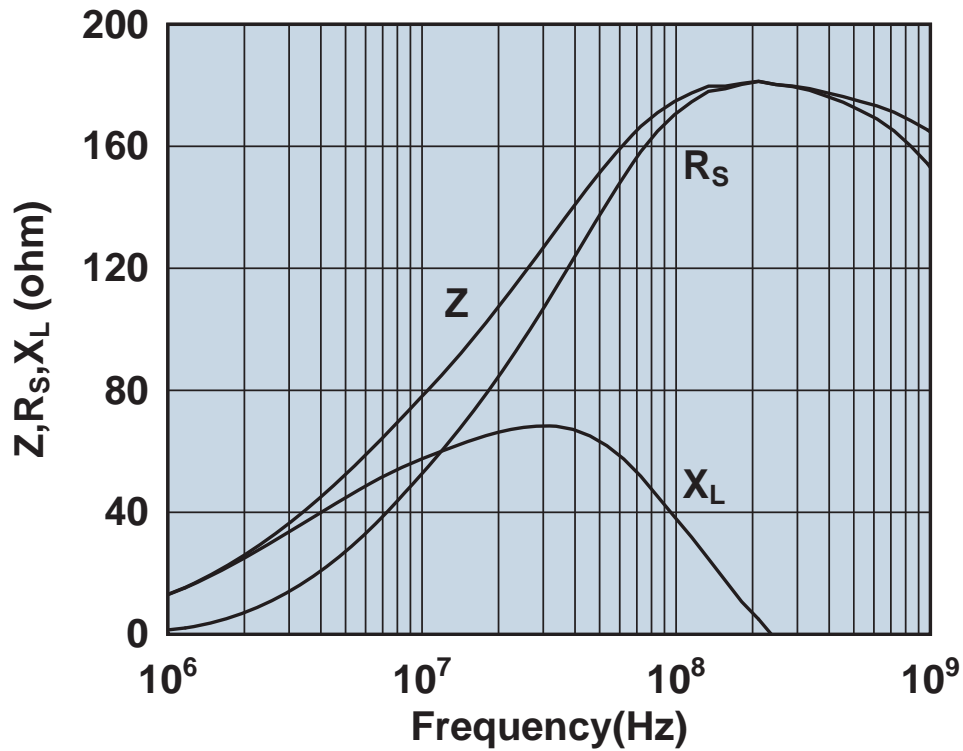

Impedance, reactance, and resistance vs. frequency.

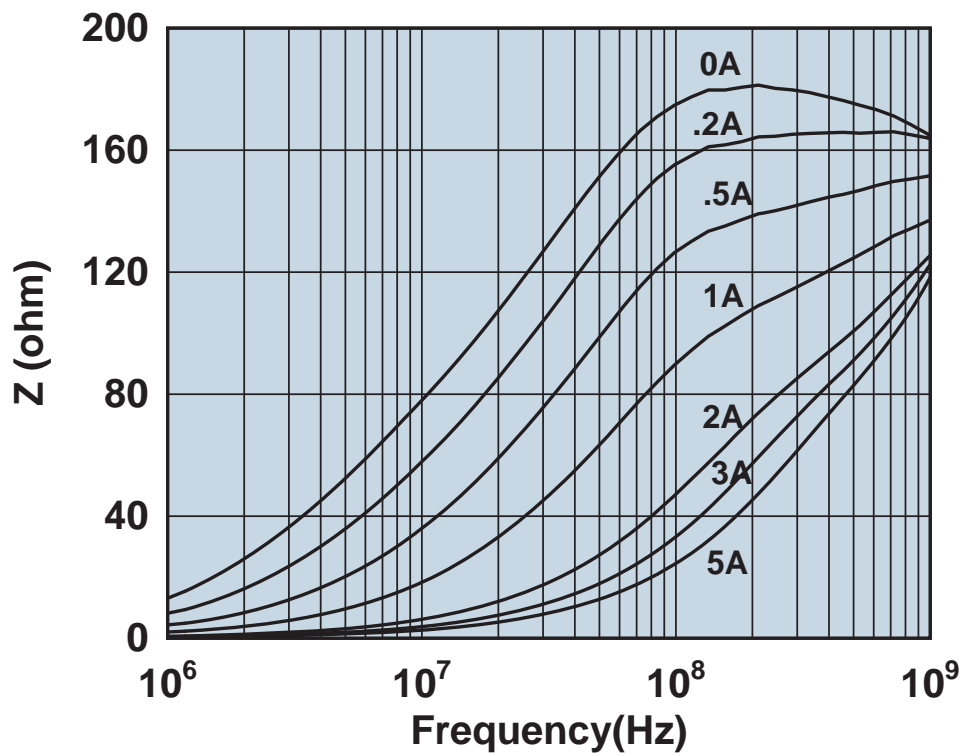

Impedance vs. frequency with dc bias.

2744788147

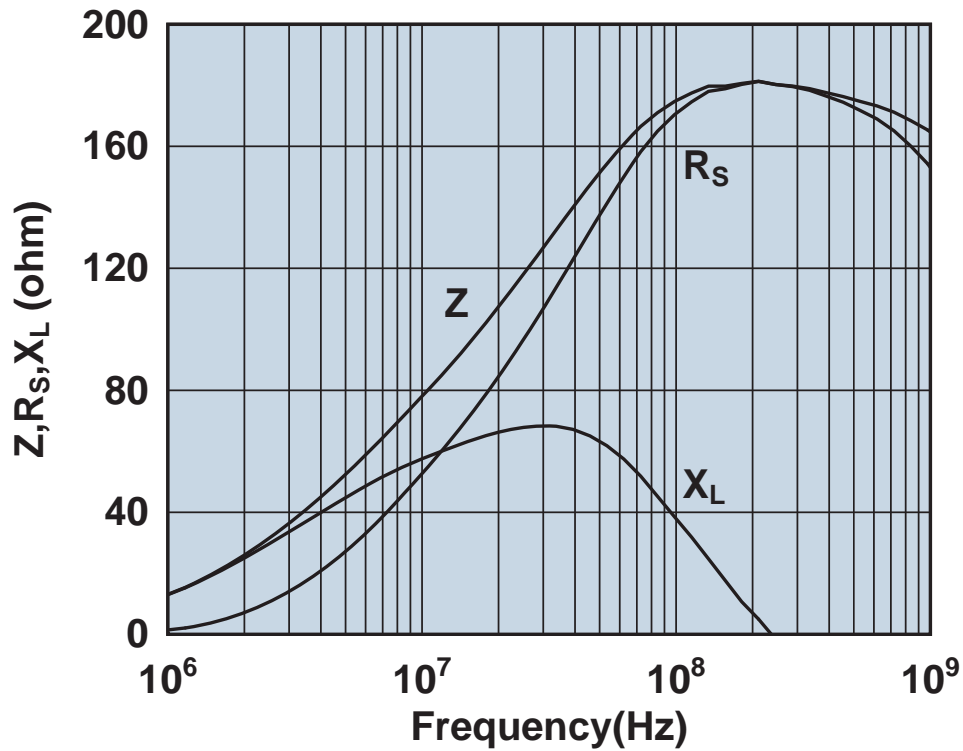

Impedance, reactance, and resistance vs. frequency.

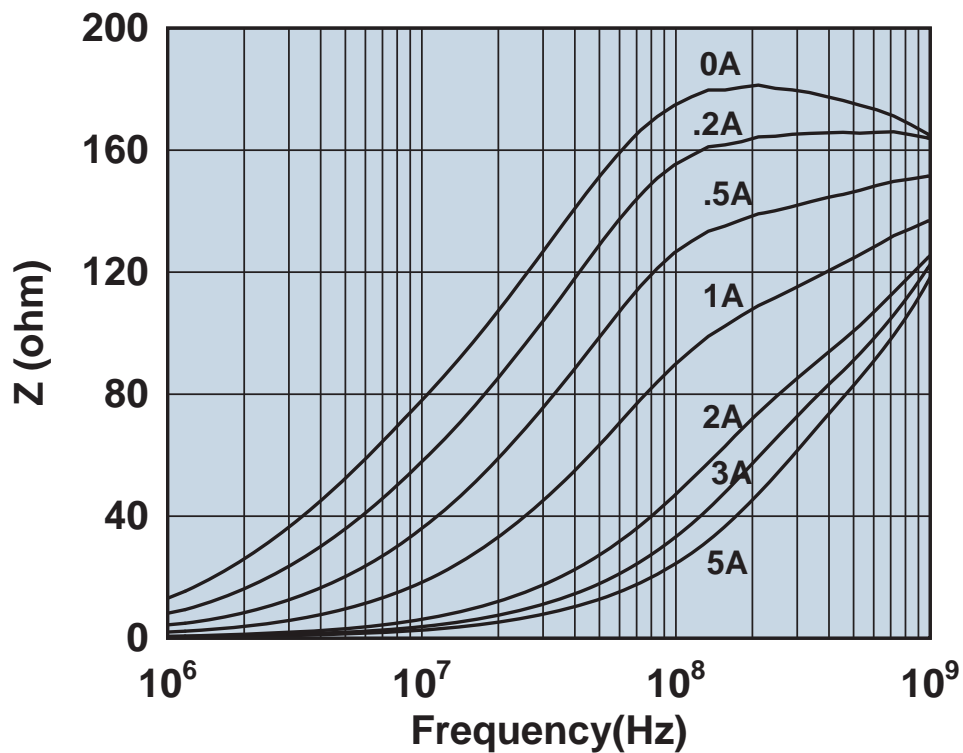

Impedance vs. frequency with dc bias.

2744788347

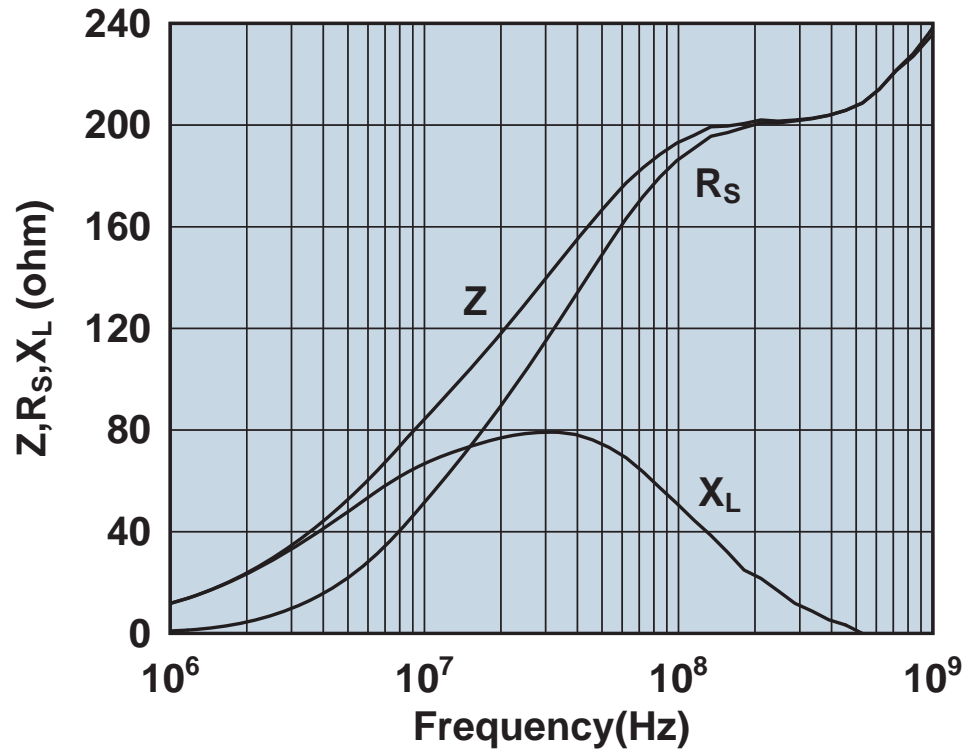

Impedance, reactance, and resistance vs. frequency.

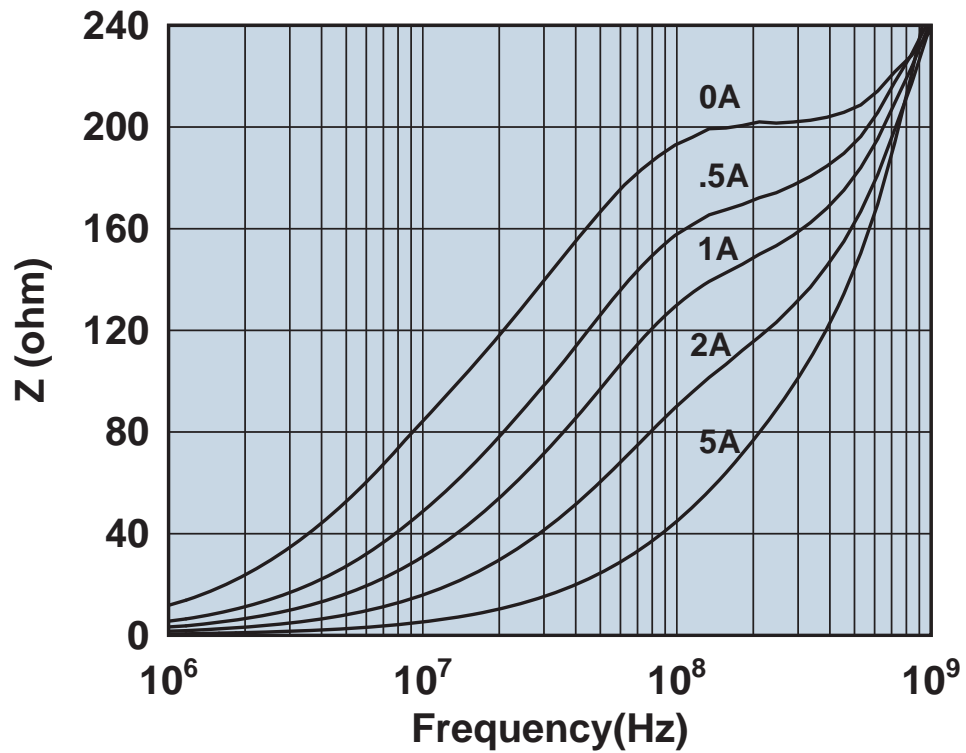

Impedance vs. frequency with dc bias.

2752041447

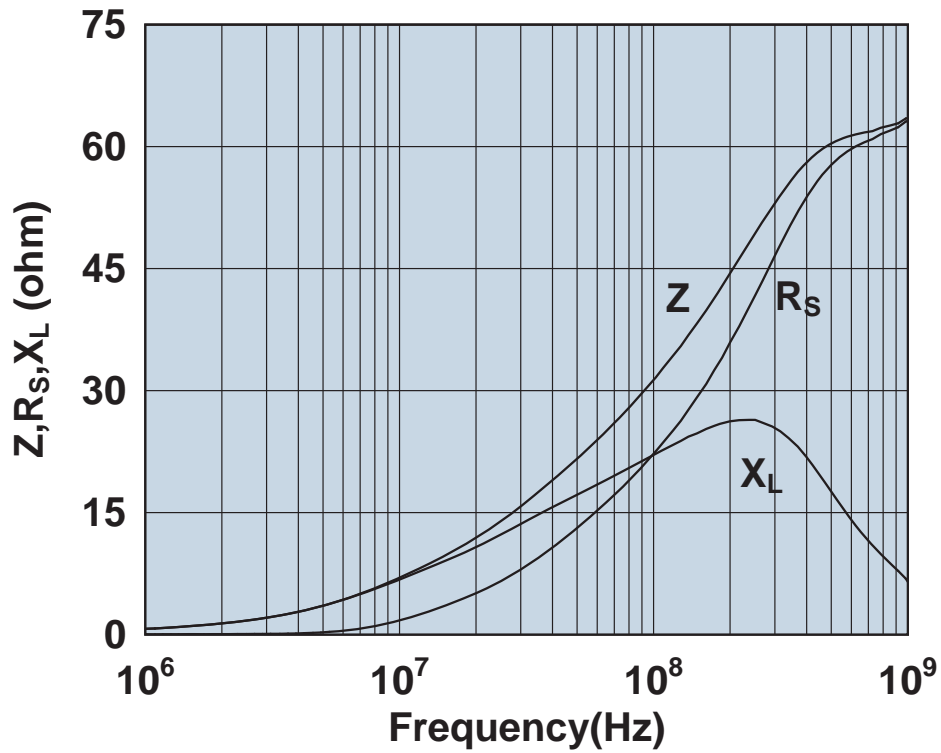

Impedance, reactance, and resistance vs. frequency.

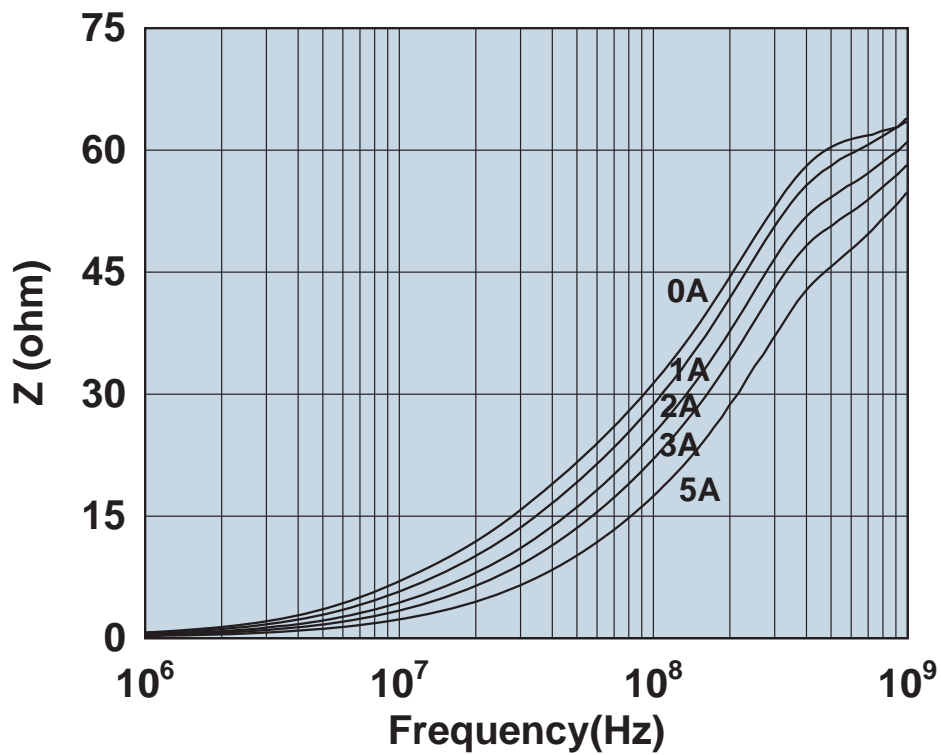

Impedance vs. frequency with dc bias.

2752045447

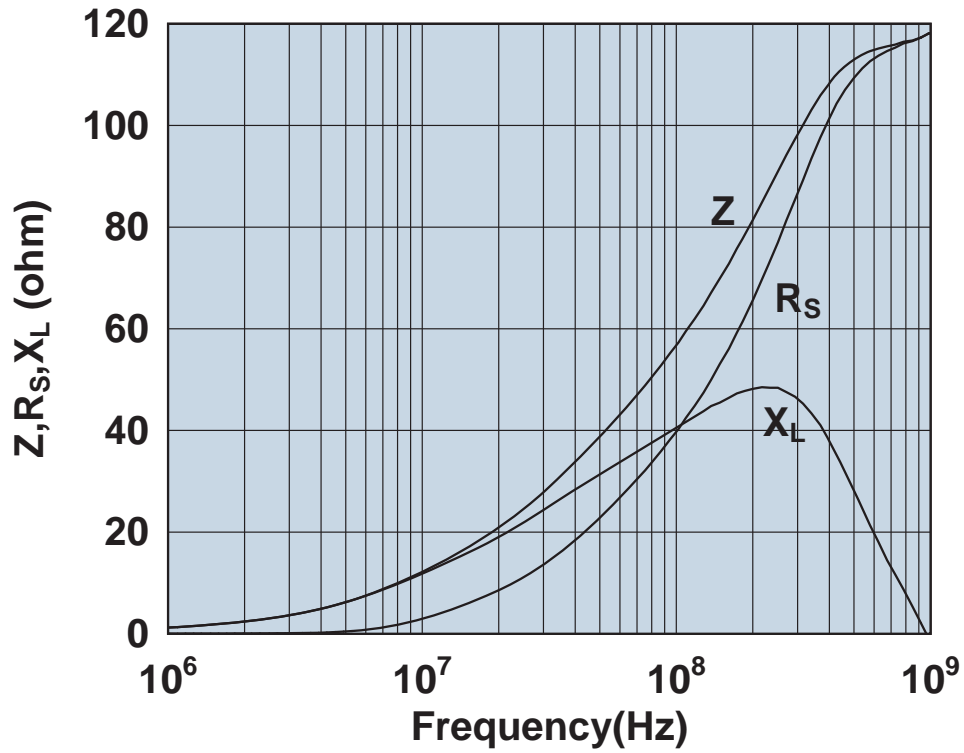

Impedance, reactance, and resistance vs. frequency.

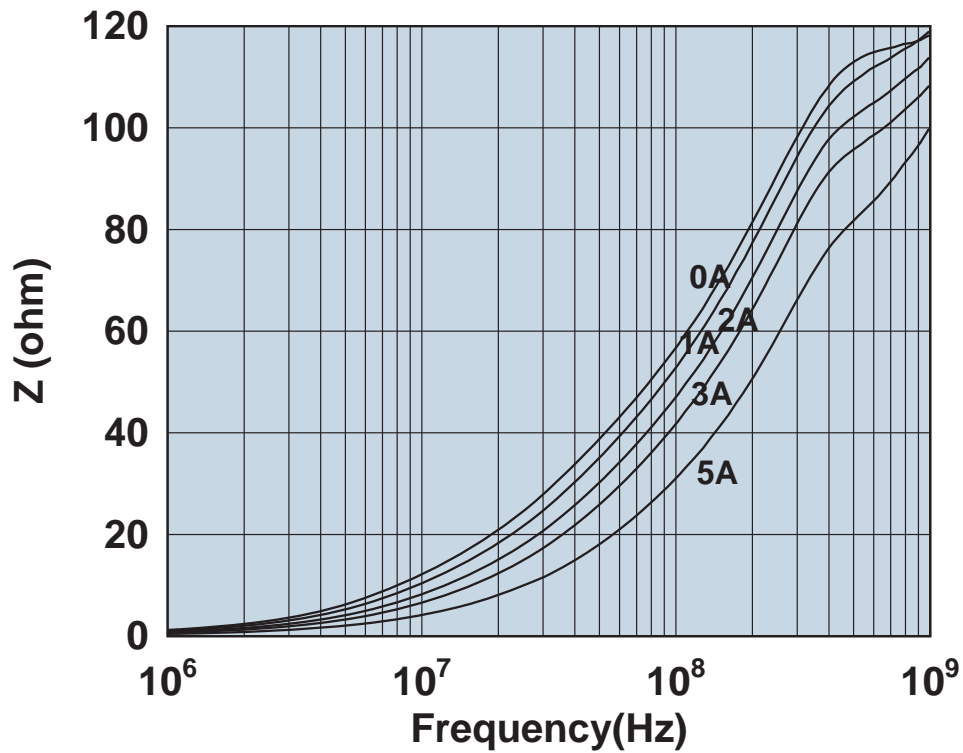

Impedance vs. frequency with dc bias.

2752051447

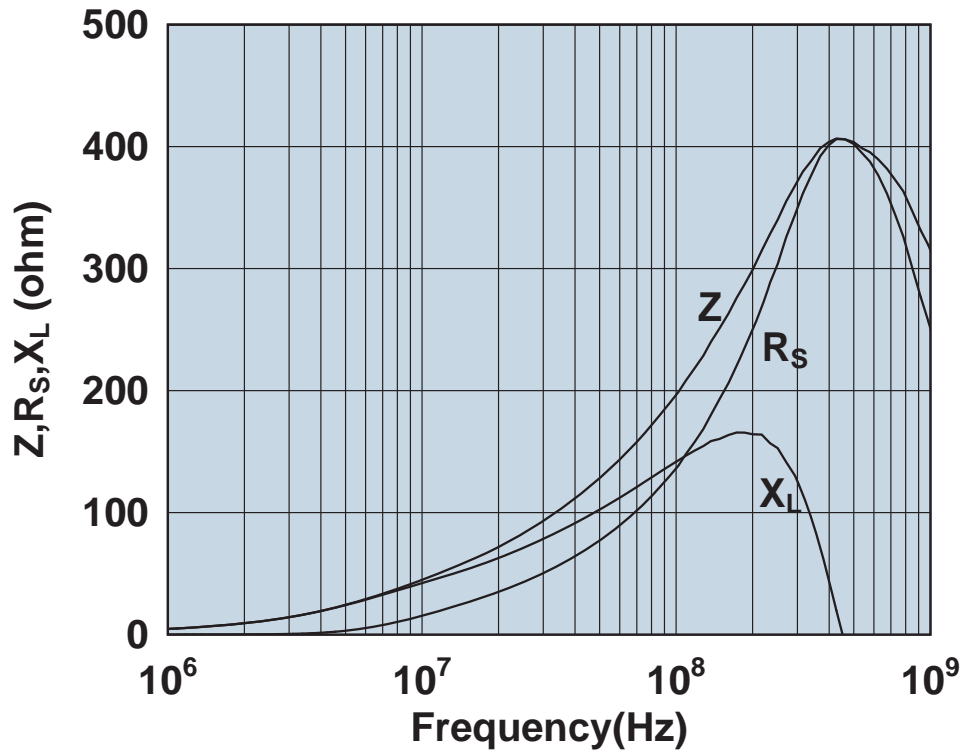

Impedance, reactance, and resistance vs. frequency.

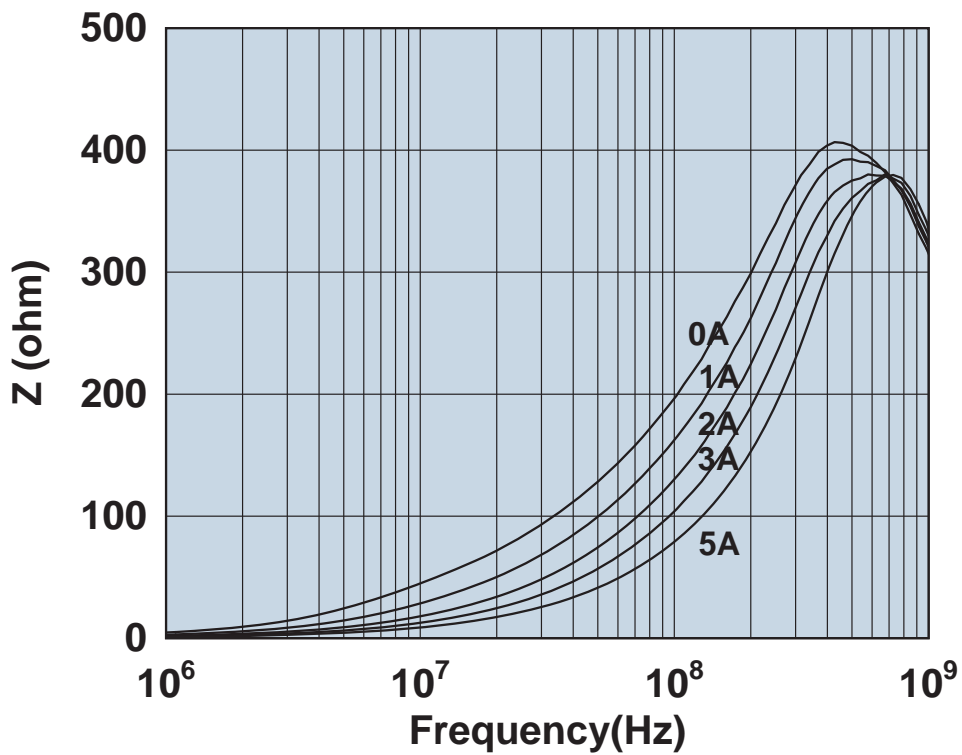

Impedance vs. frequency with dc bias.

2752065447

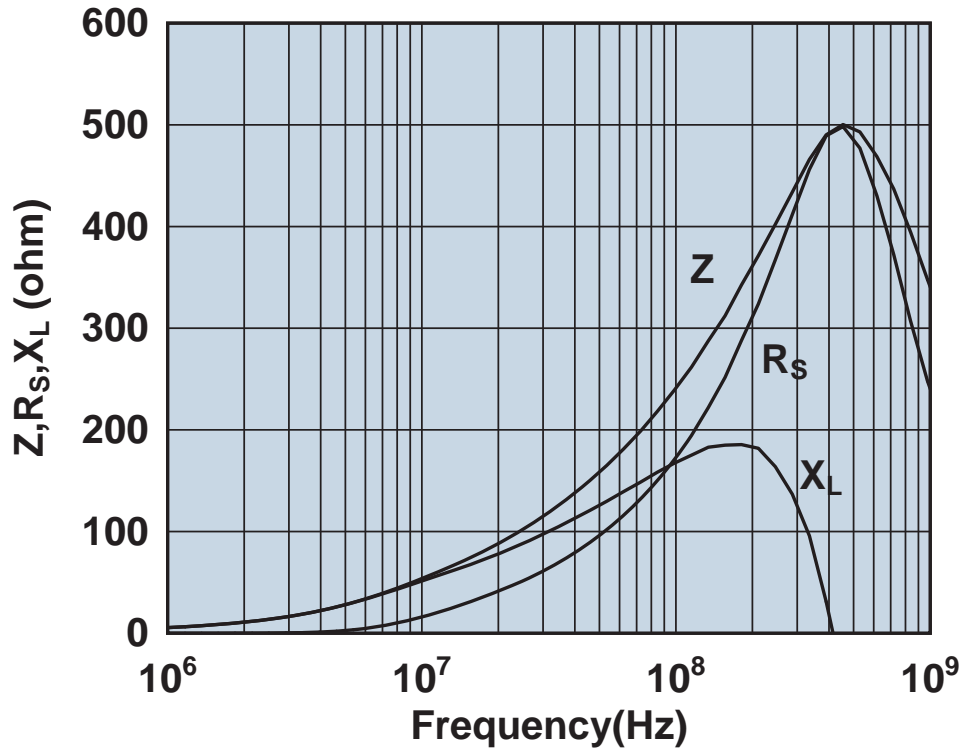

Impedance, reactance, and resistance vs. frequency.

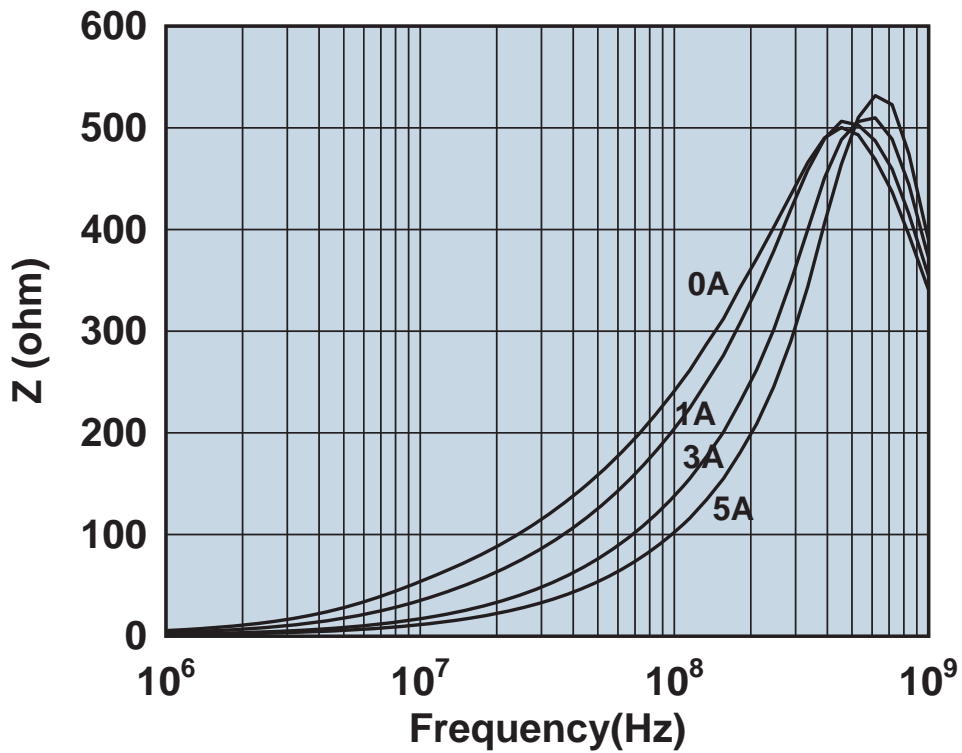

Impedance vs. frequency with dc bias.

2752555567

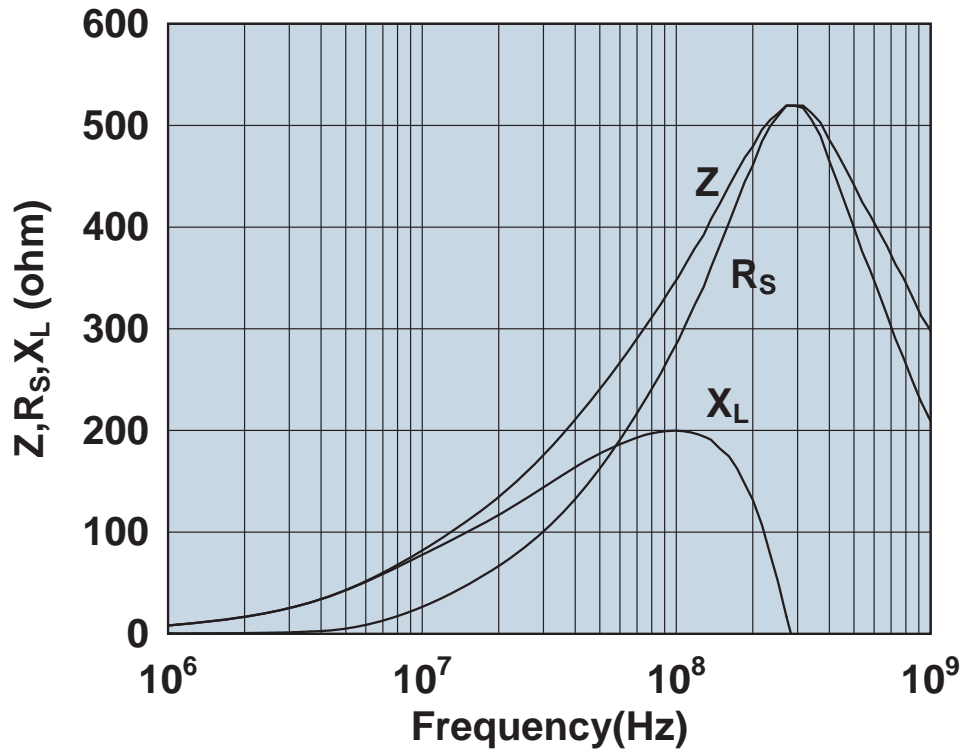

Impedance, reactance, and resistance vs. frequency.

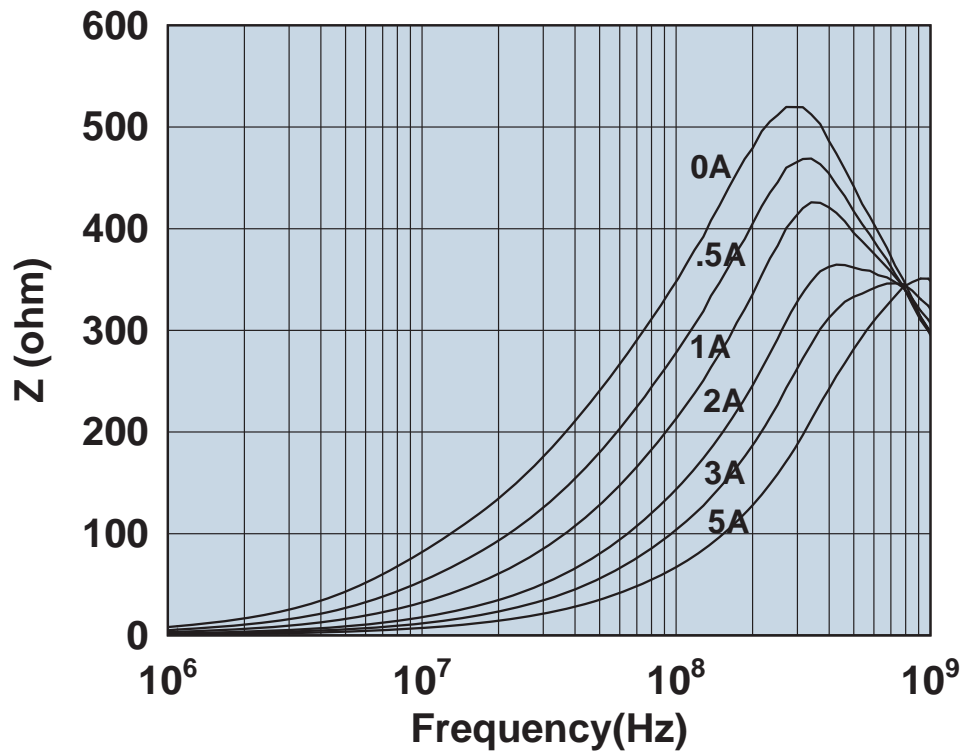

Impedance vs. frequency with dc bias.

275255577

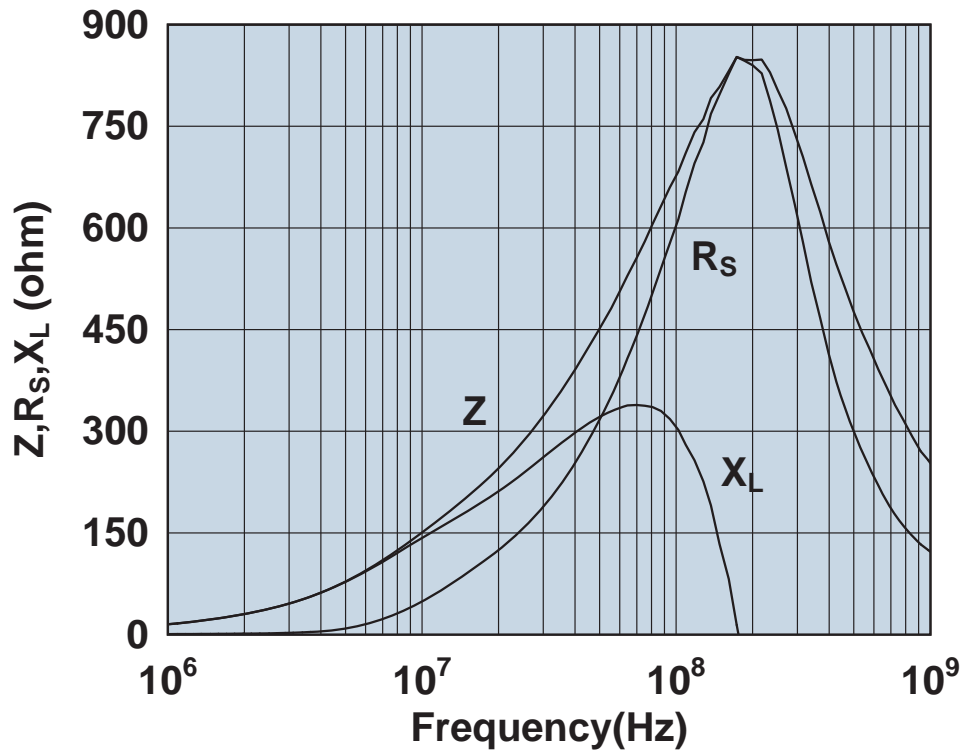

Impedance, reactance, and resistance vs. frequency.

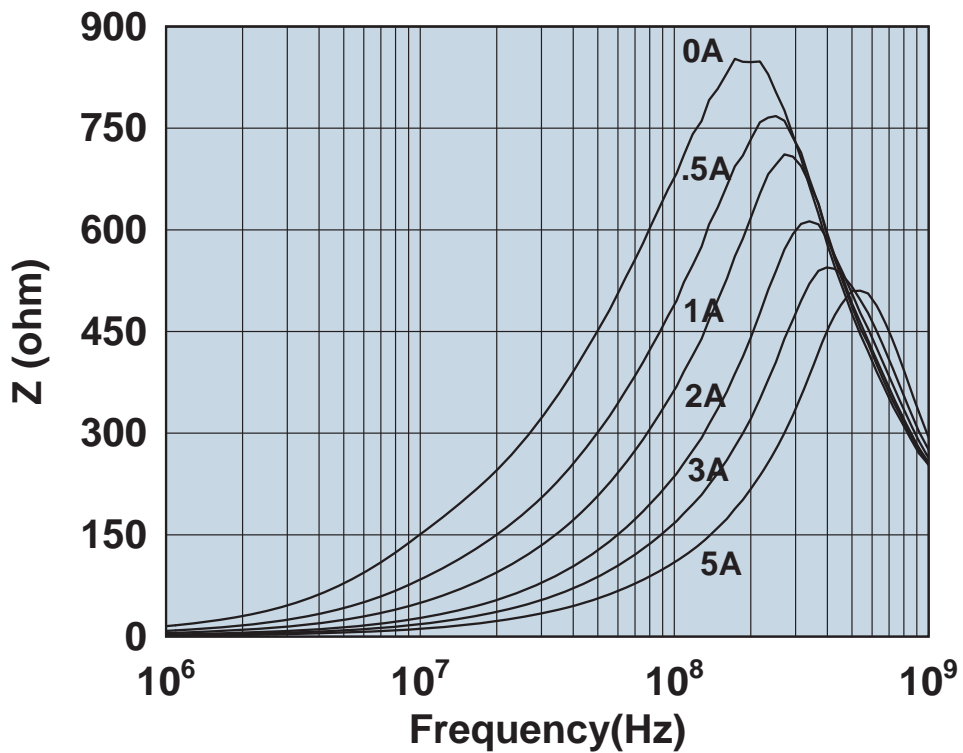

Impedance vs. frequency with dc bias.

2752770347

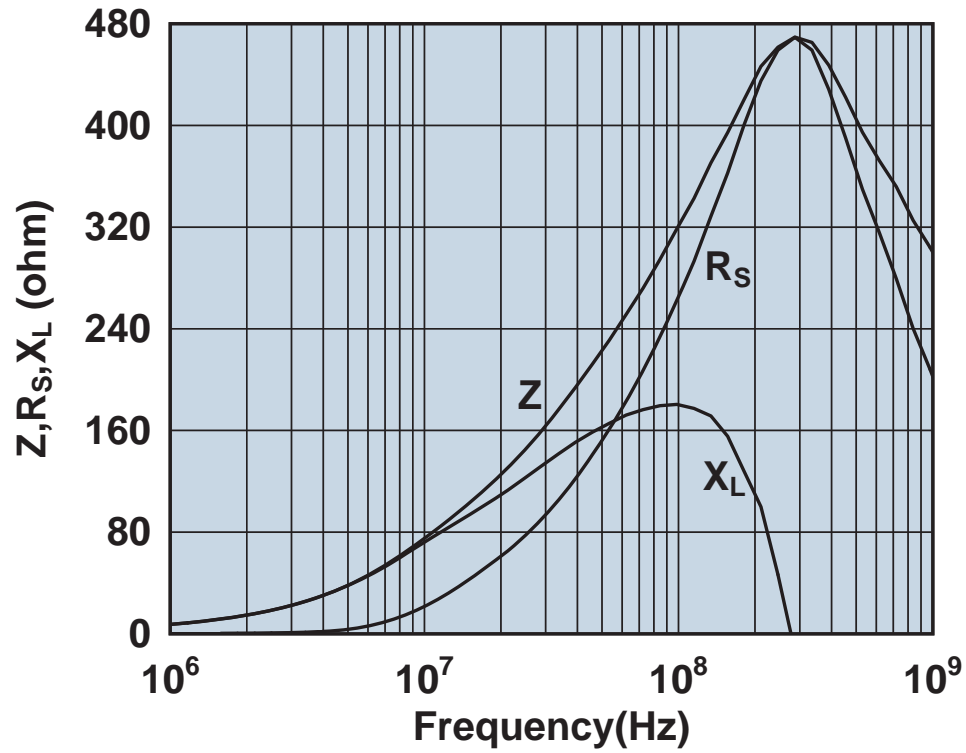

Impedance, reactance, and resistance vs. frequency.

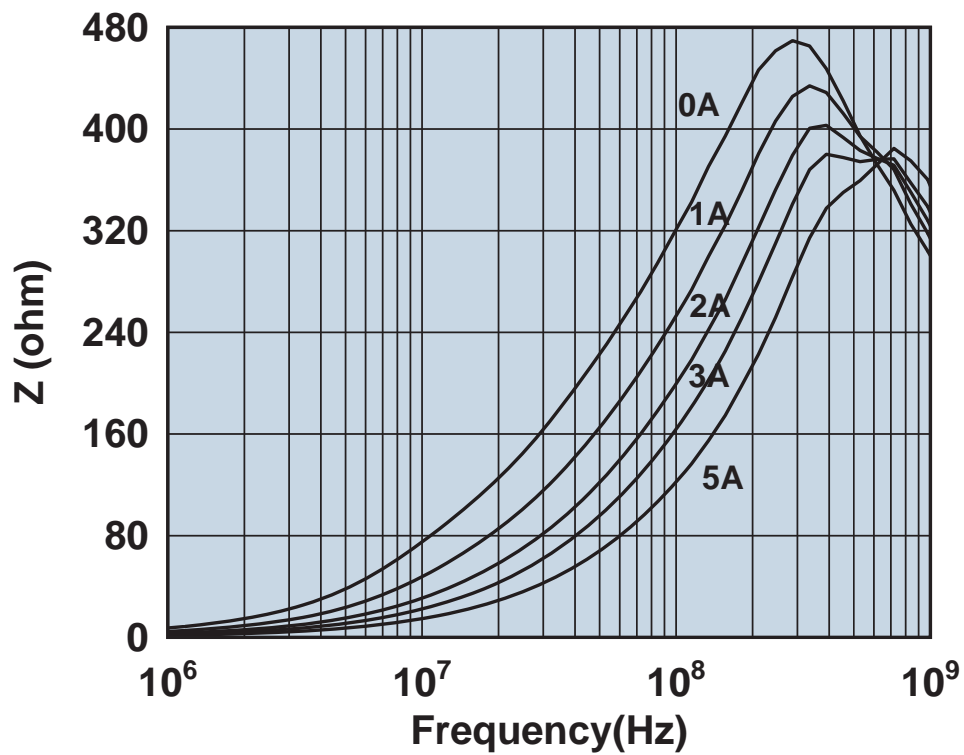

Impedance vs. frequency with dc bias.

2752776147

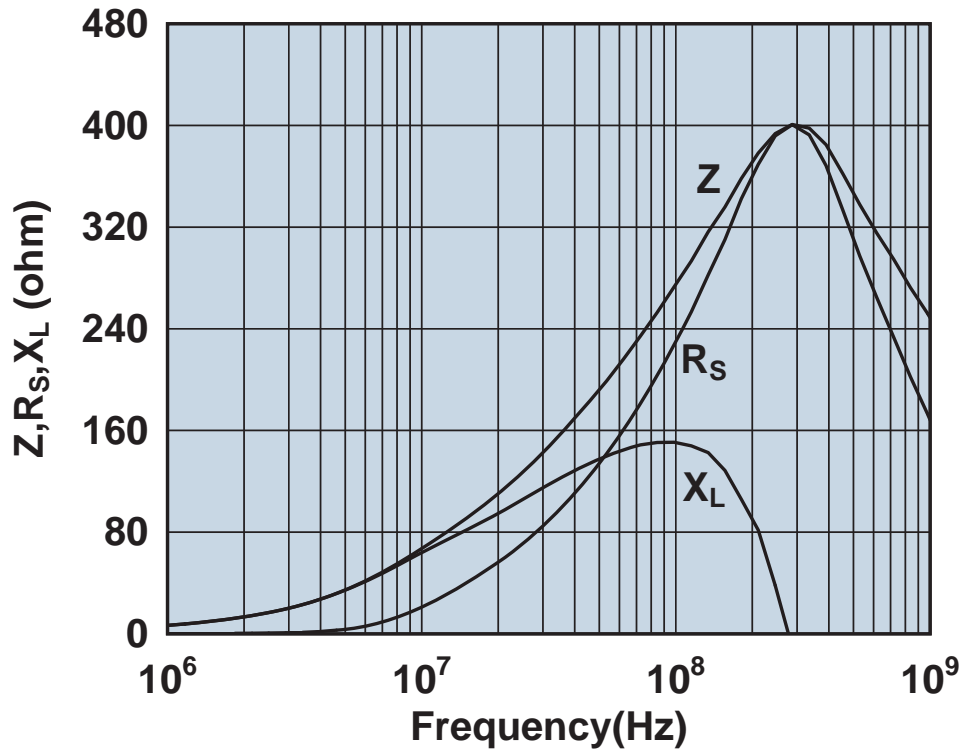

Impedance, reactance, and resistance vs. frequency.

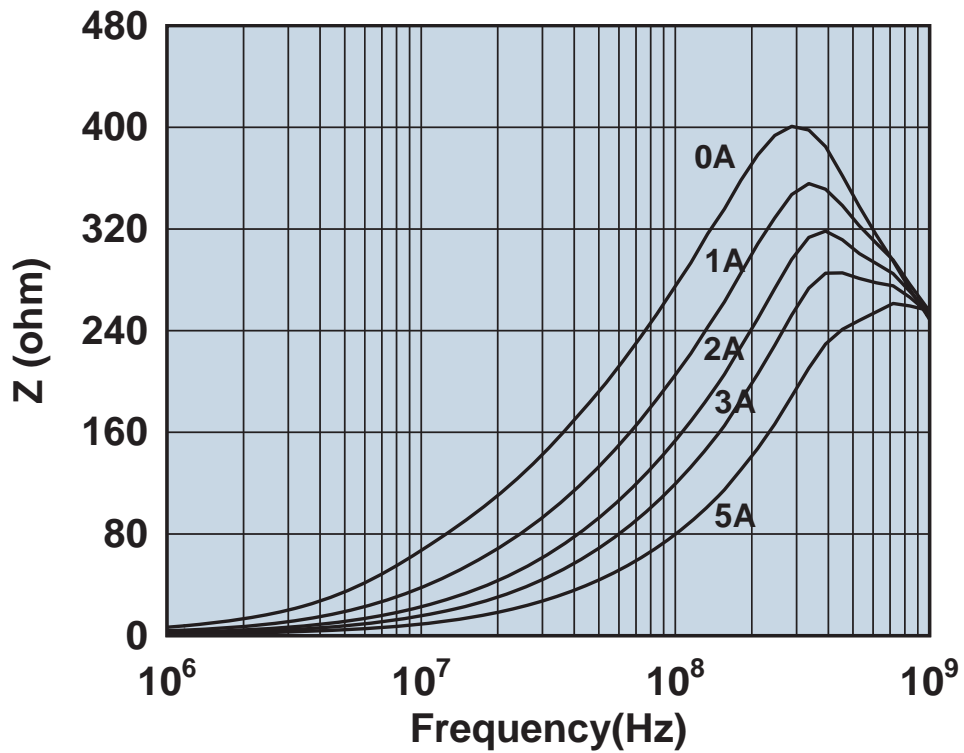

Impedance vs. frequency with dc bias.

2752778147

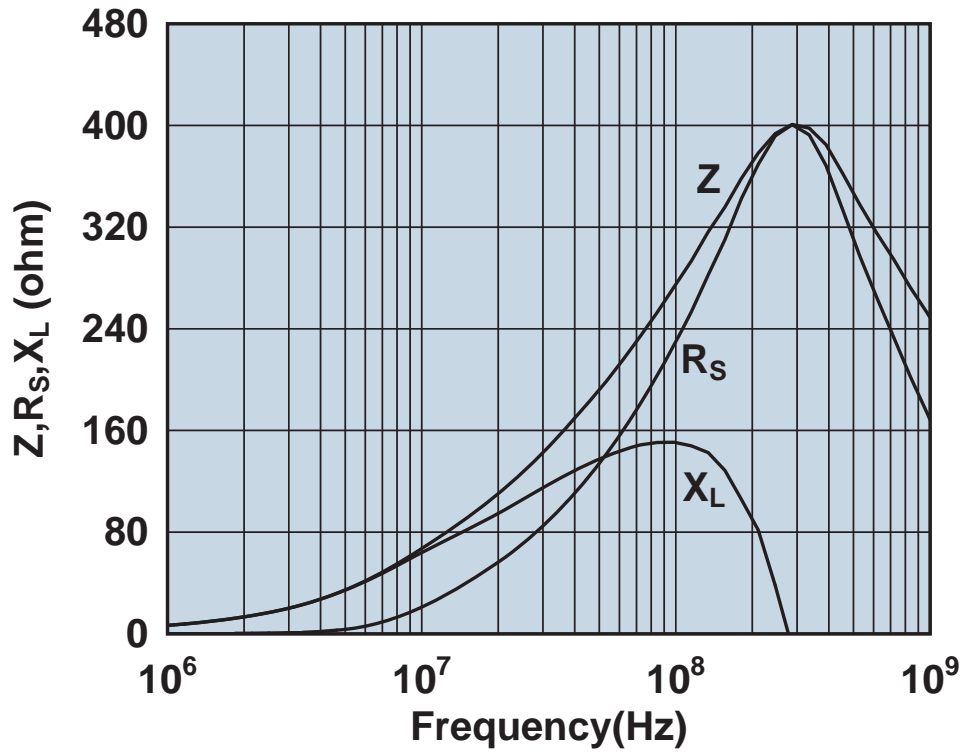

Impedance, reactance, and resistance vs. frequency.

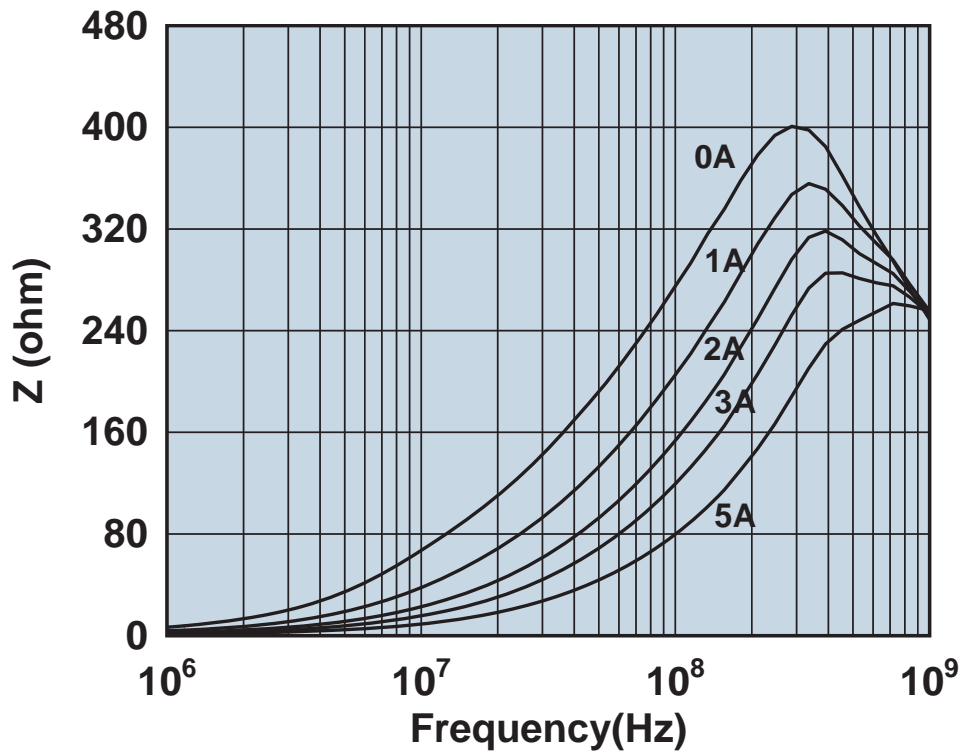

Impedance vs. frequency with dc bias.

2752778347

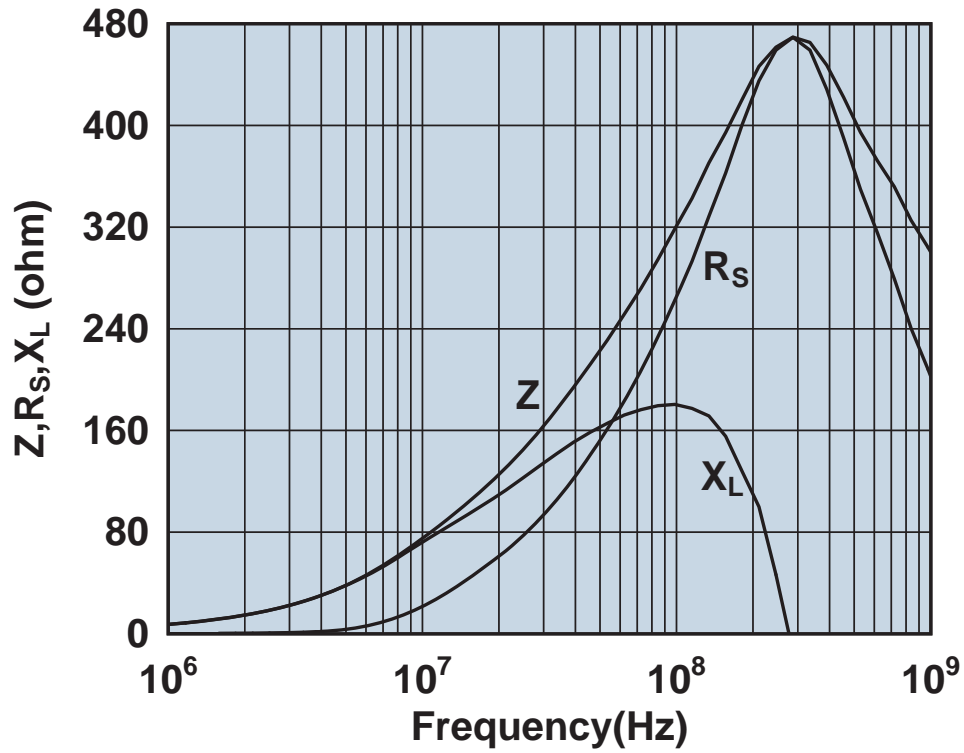

Impedance, reactance, and resistance vs. frequency.

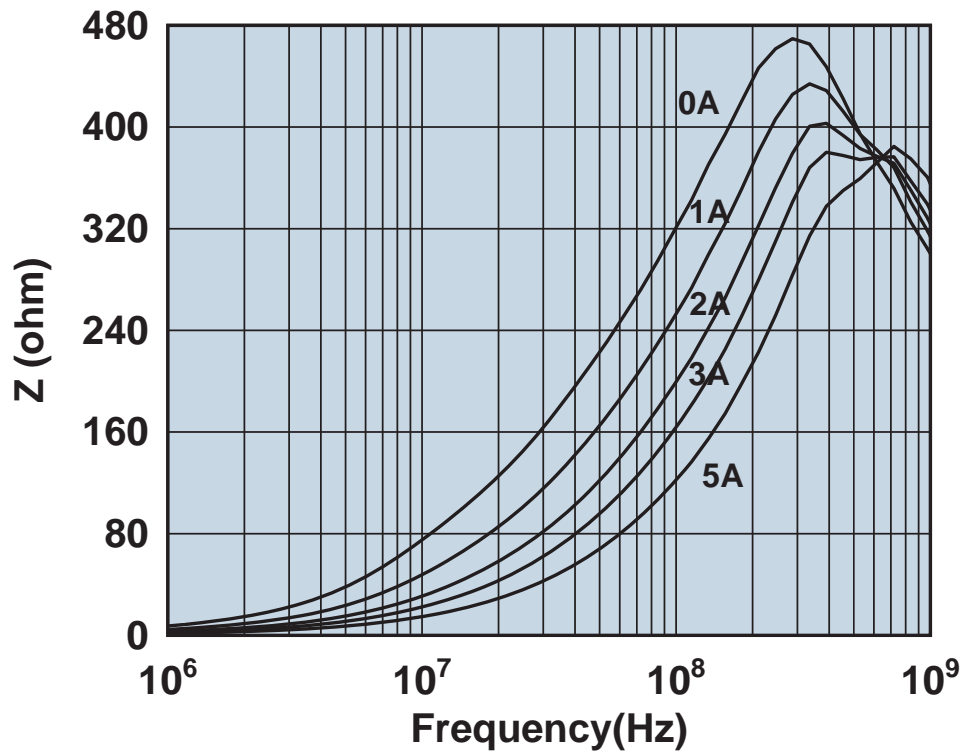

Impedance vs. frequency with dc bias.

2752780347

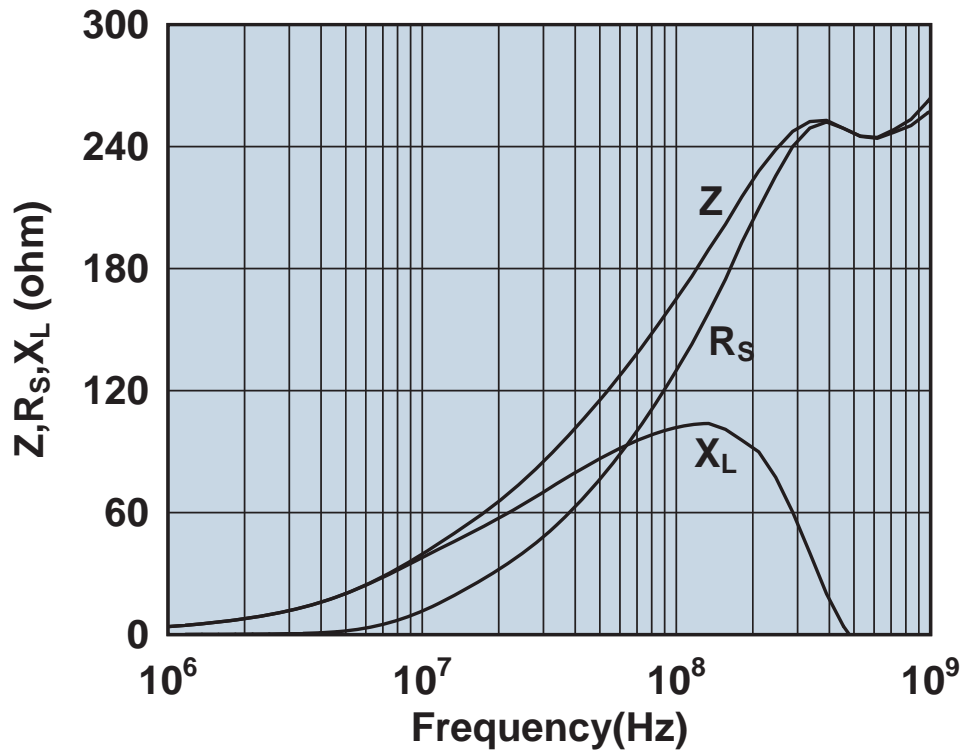

Impedance, reactance, and resistance vs. frequency.

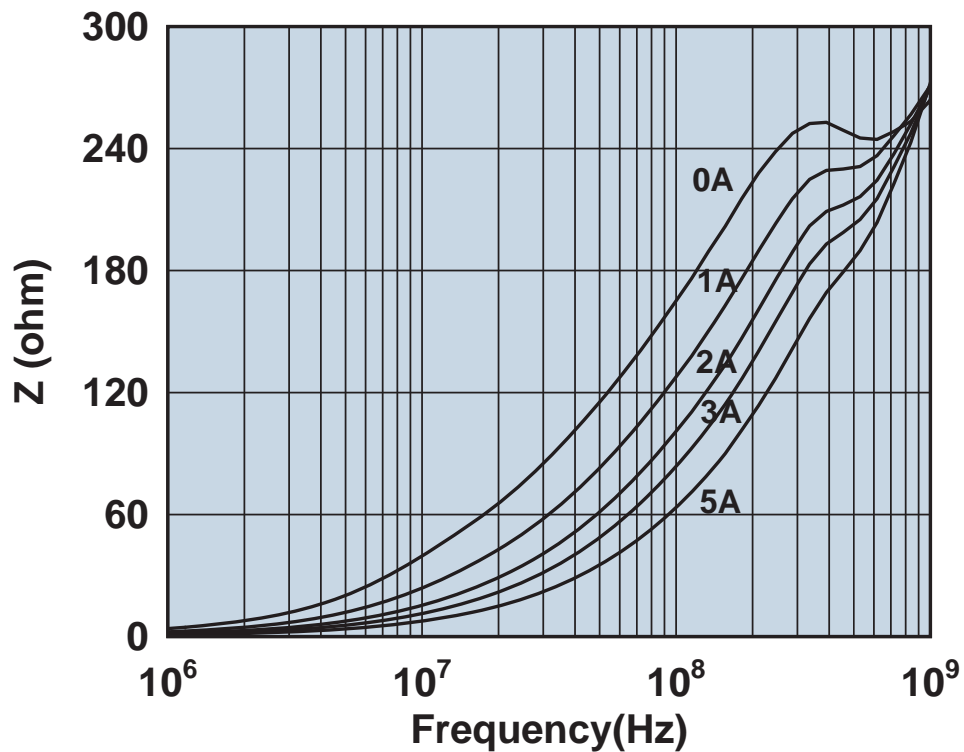

Impedance vs. frequency with dc bias.

2752786147

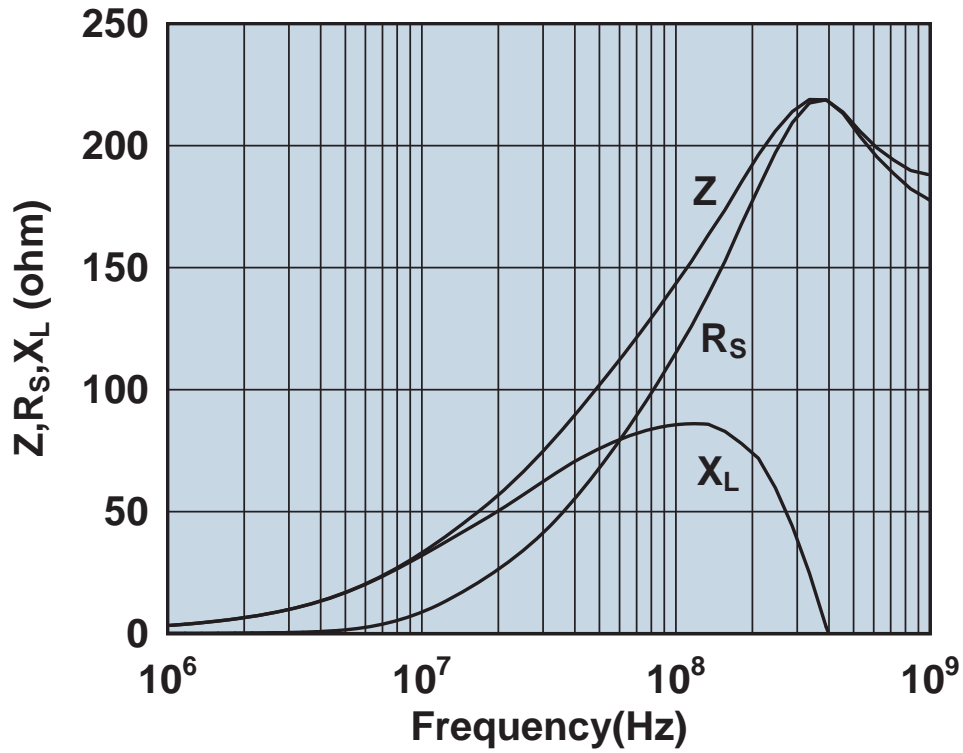

Impedance, reactance, and resistance vs. frequency.

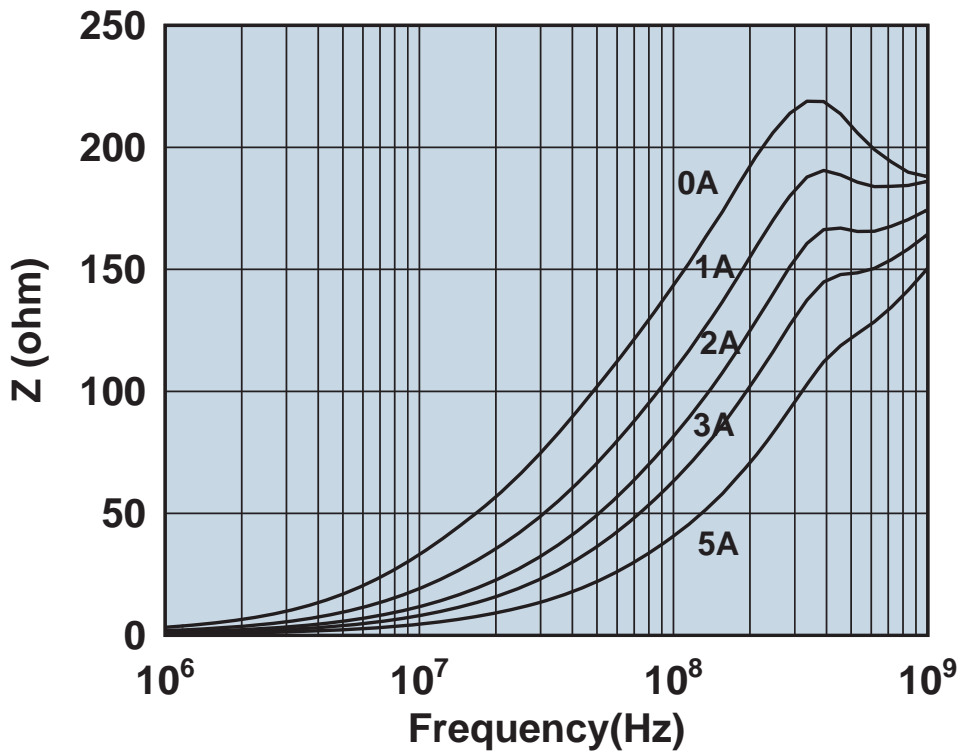

Impedance vs. frequency with dc bias.

2752788147

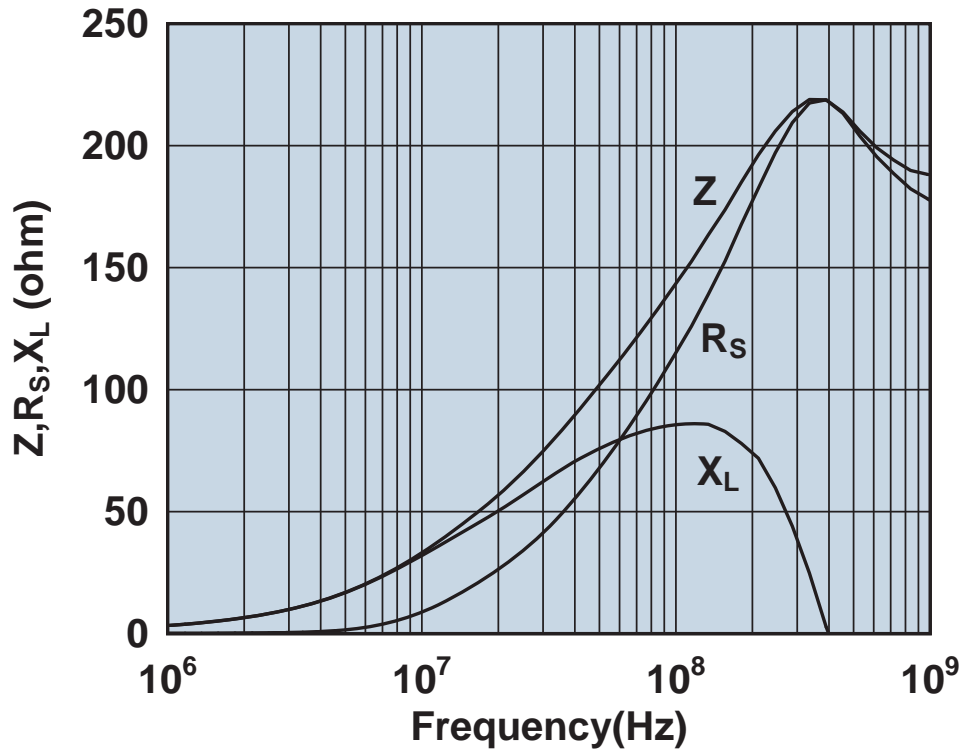

Impedance, reactance, and resistance vs. frequency.

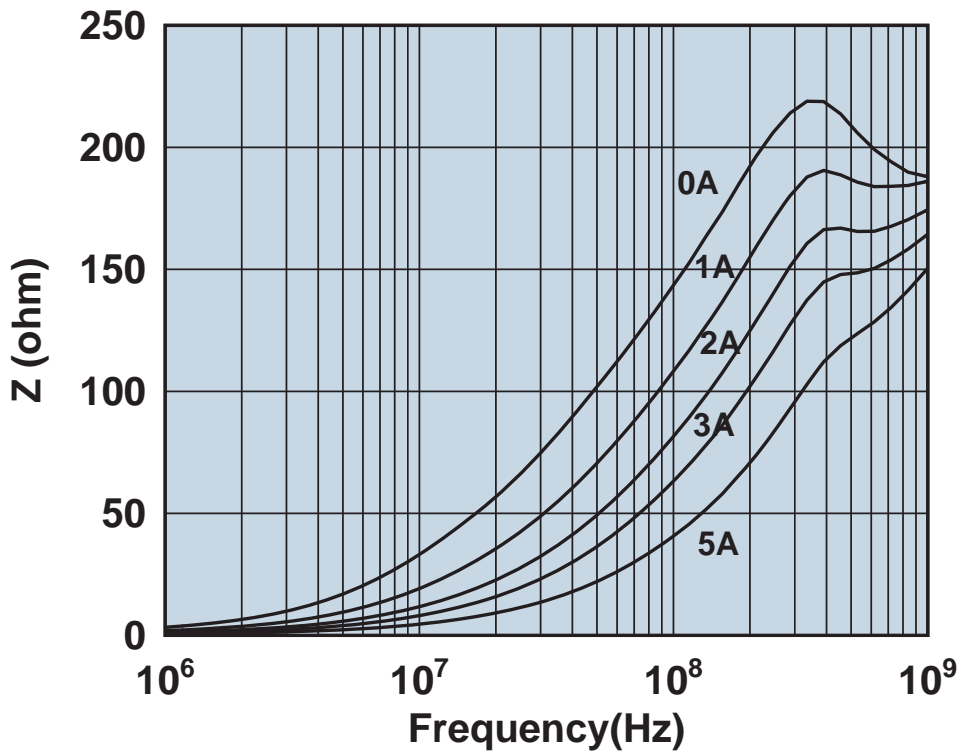

Impedance vs. frequency with dc bias.

2752788347

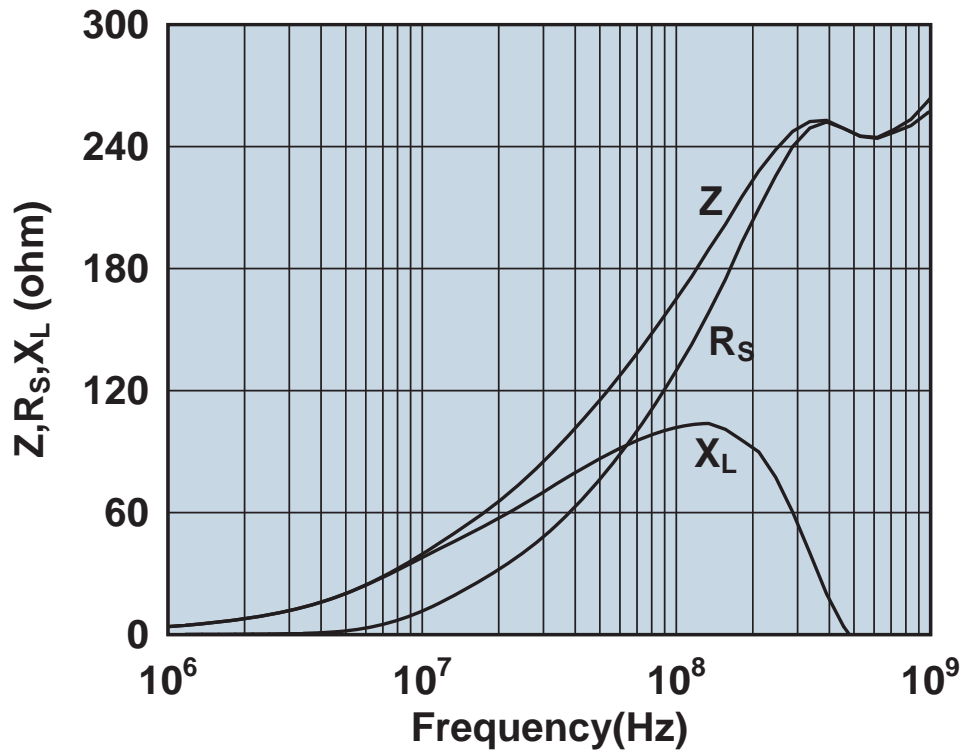

Impedance, reactance, and resistance vs. frequency.

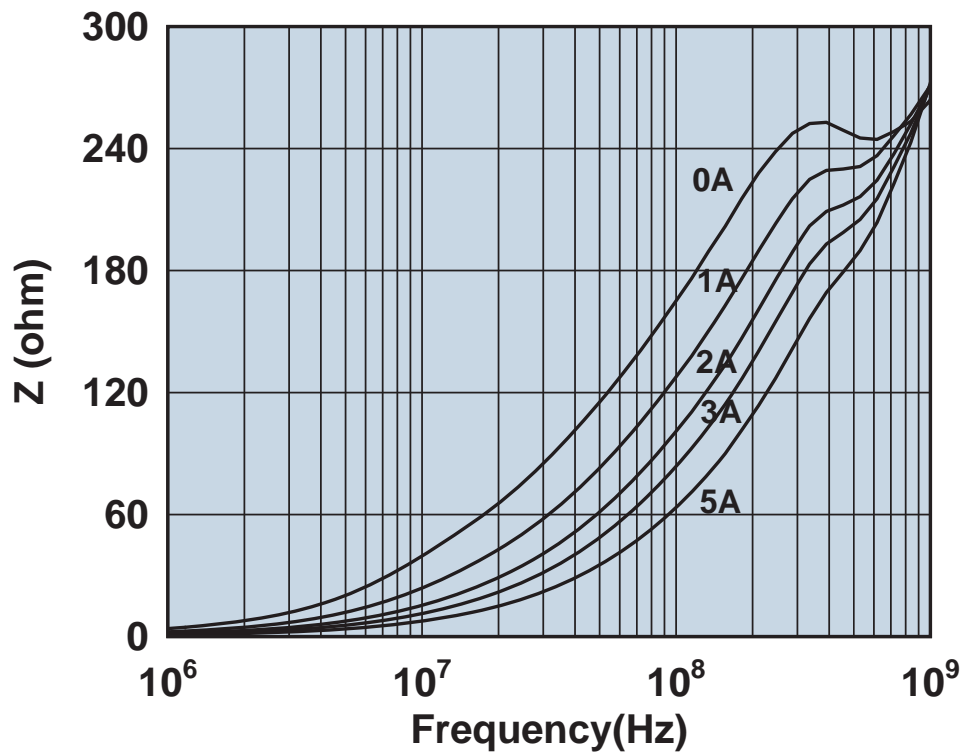

Impedance vs. frequency with dc bias.

2761001112

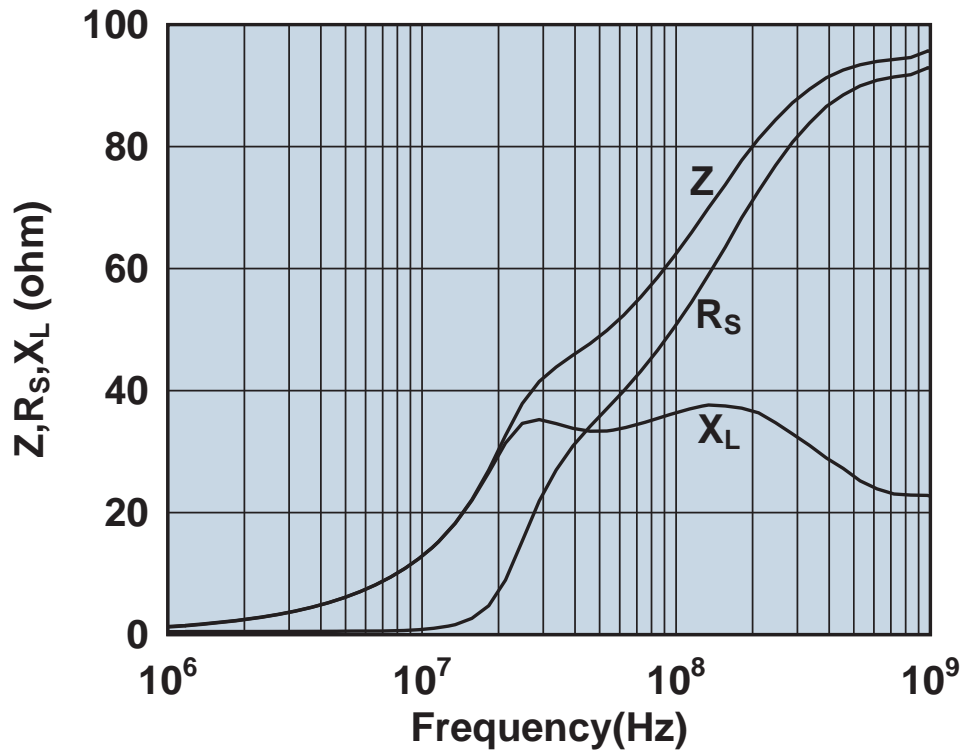

Impedance, reactance, and resistance vs. frequency.

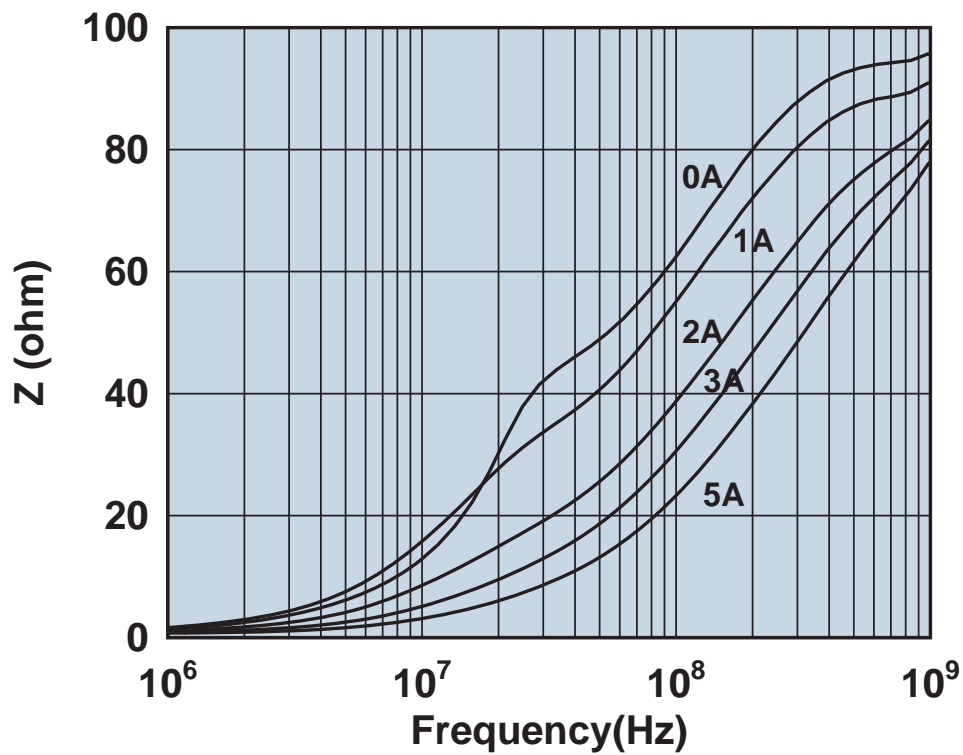

Impedance vs. frequency with dc bias.

2761002112

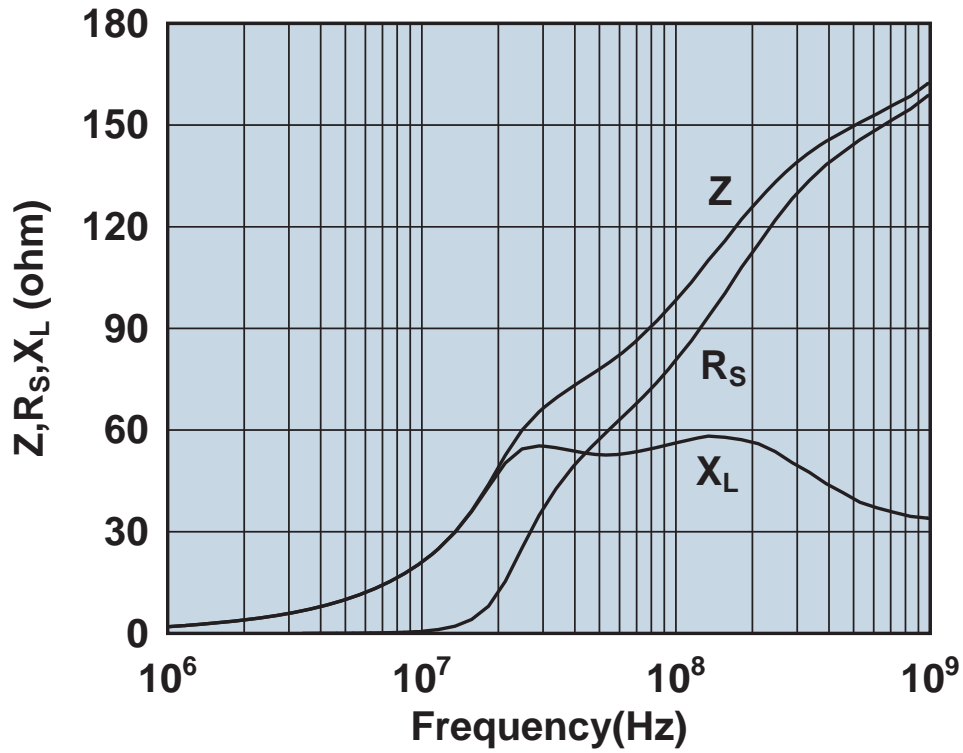

Impedance, reactance, and resistance vs. frequency.

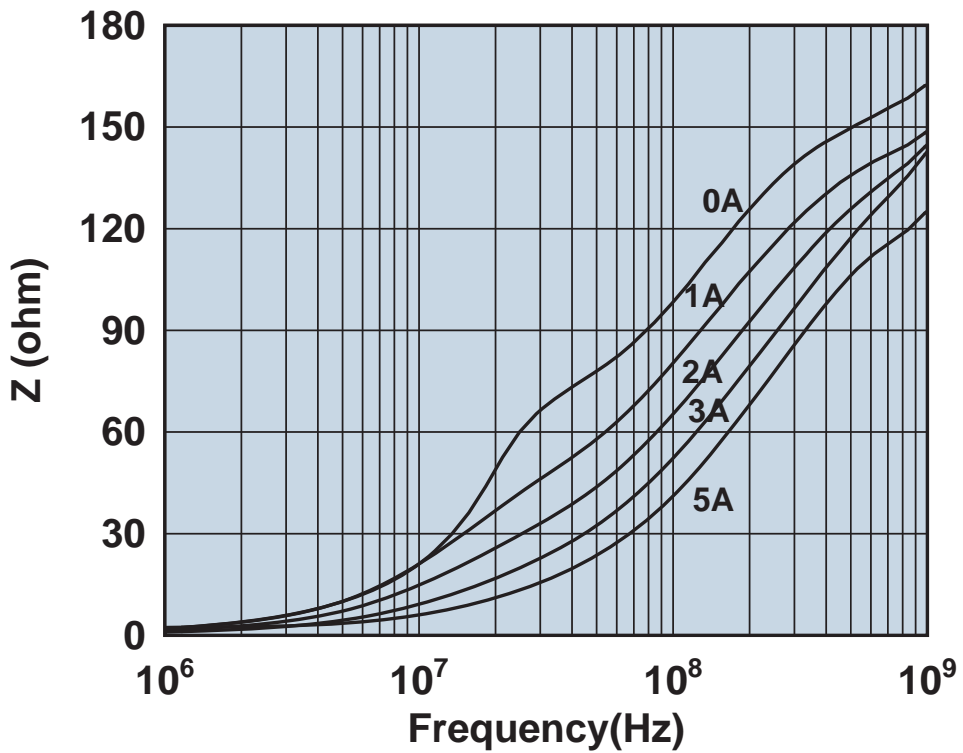

Impedance vs. frequency with dc bias.

2761003112

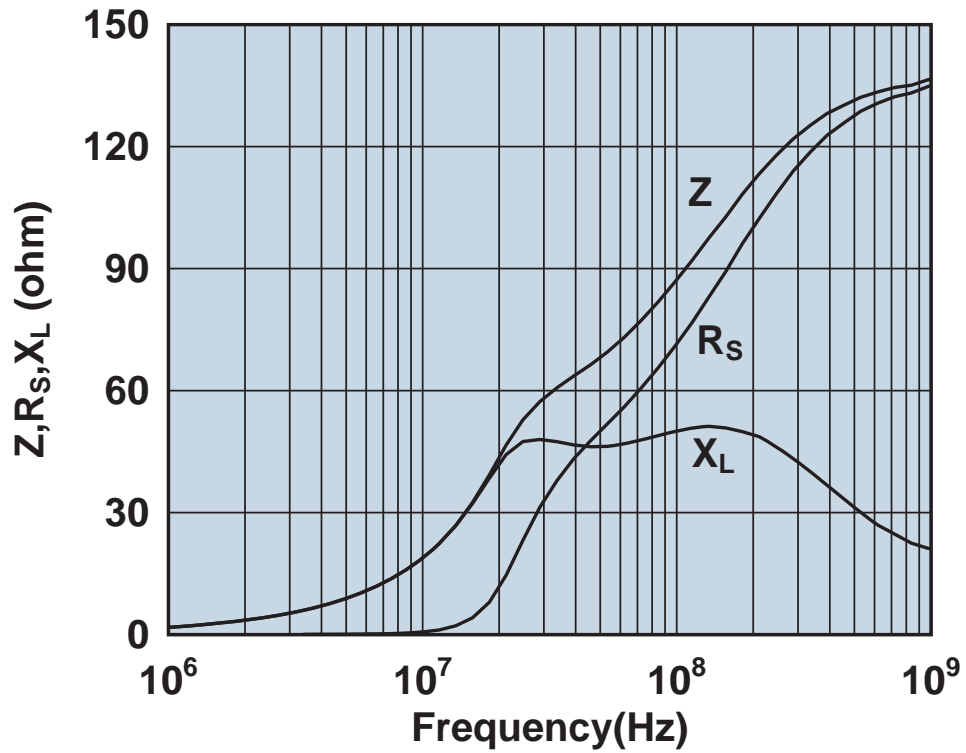

Impedance, reactance, and resistance vs. frequency.

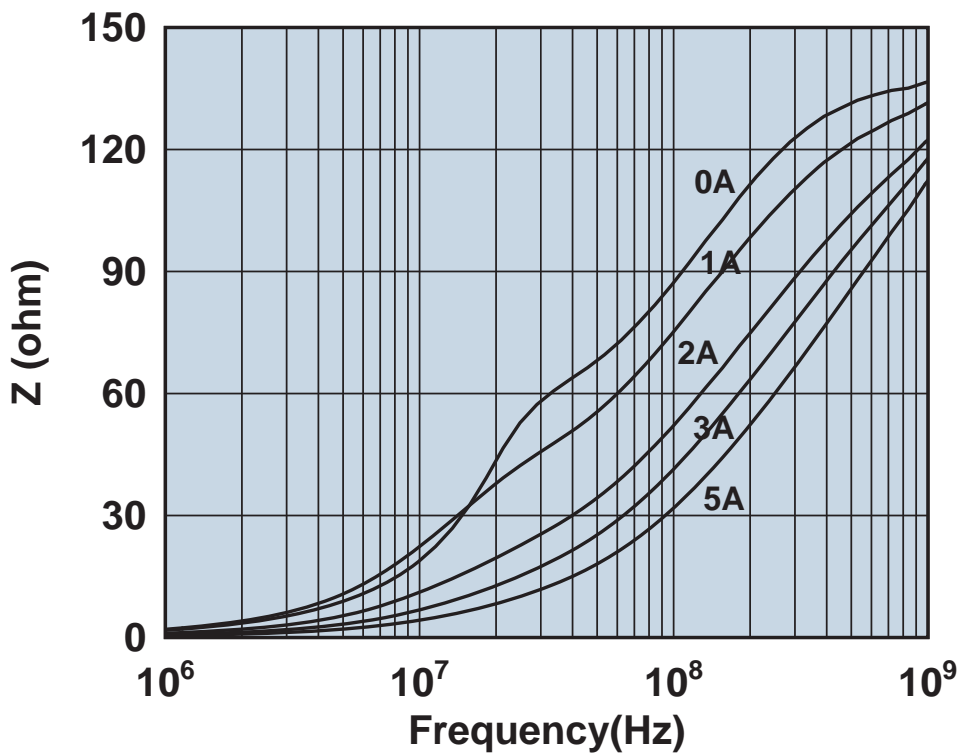

Impedance vs. frequency with dc bias.

2761004112

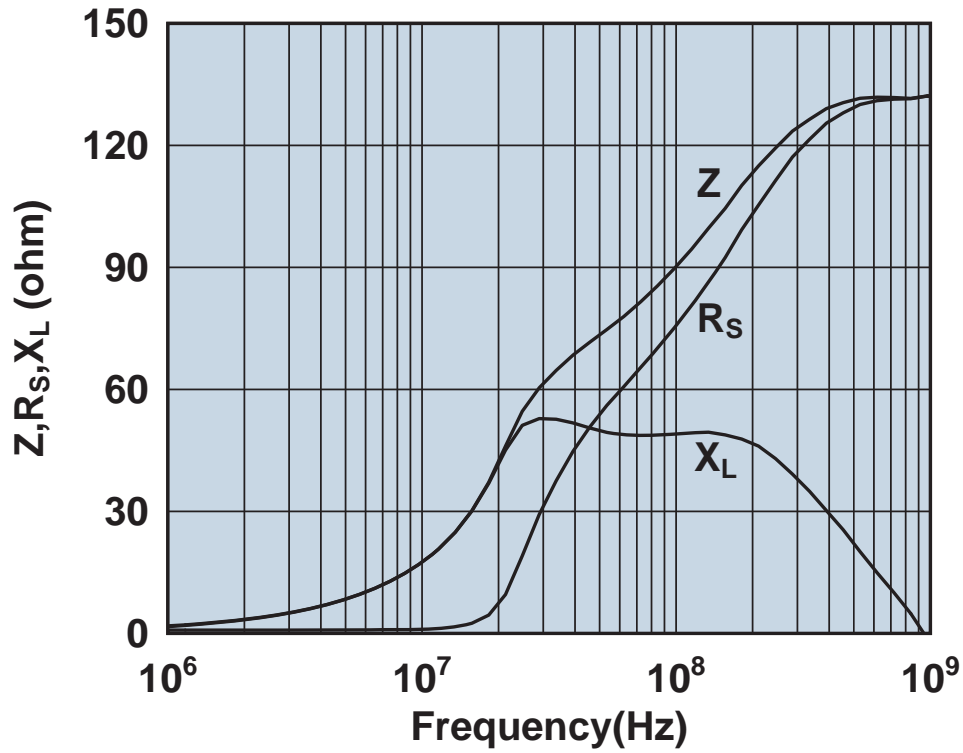

Impedance, reactance, and resistance vs. frequency.

2761004112

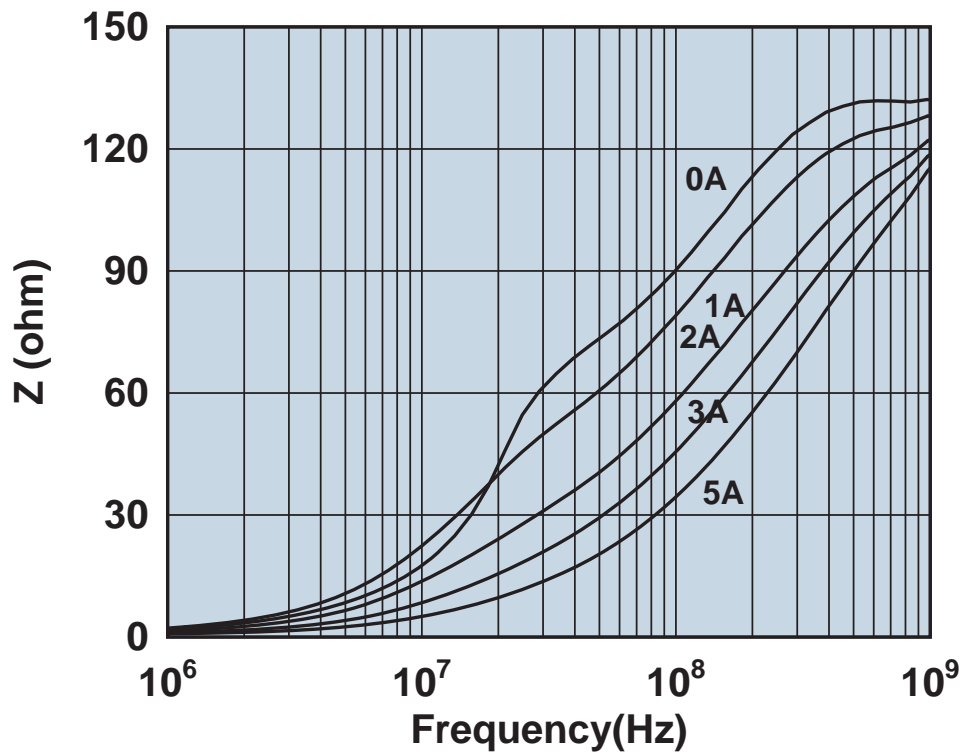

Impedance vs. frequency with dc bias.

2761005112

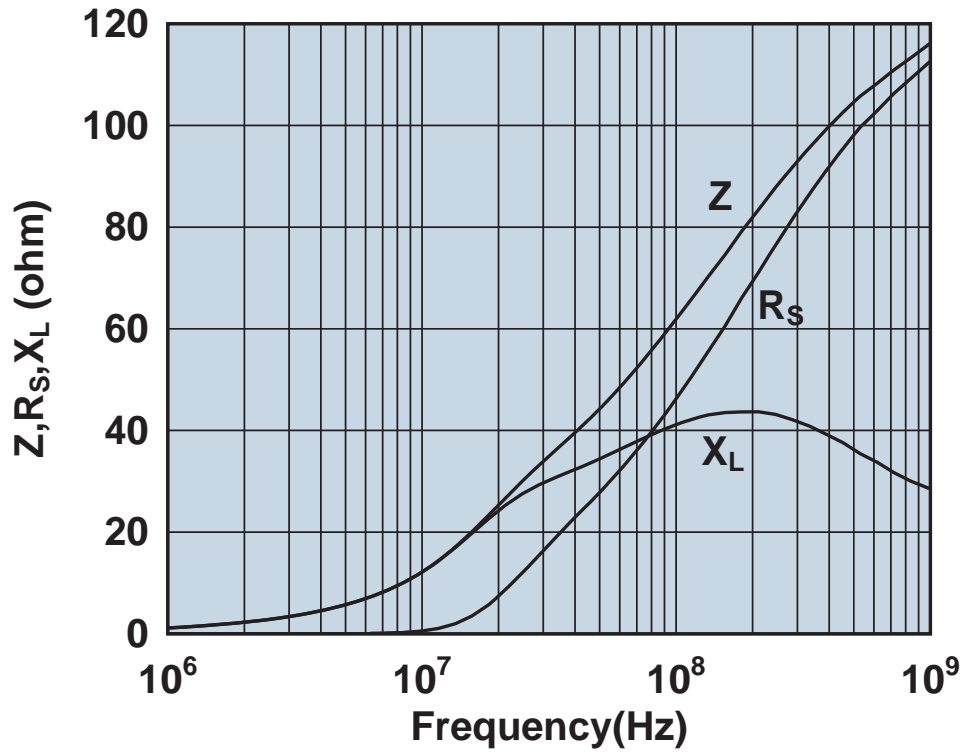

Impedance, reactance, and resistance vs. frequency.

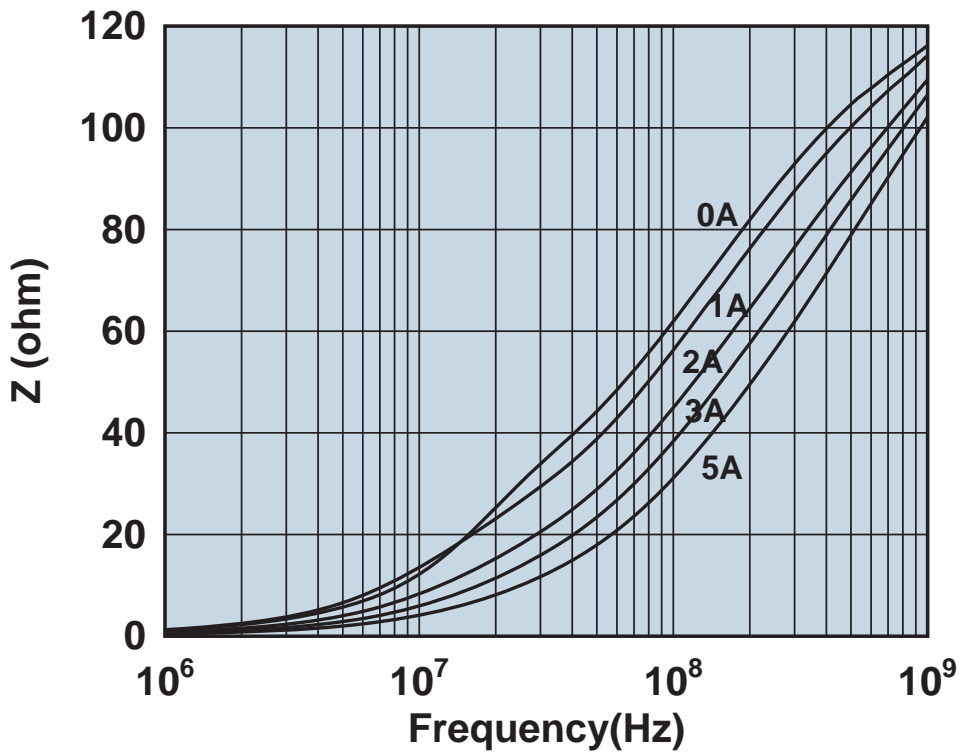

Impedance vs. frequency with dc bias.

2761007112

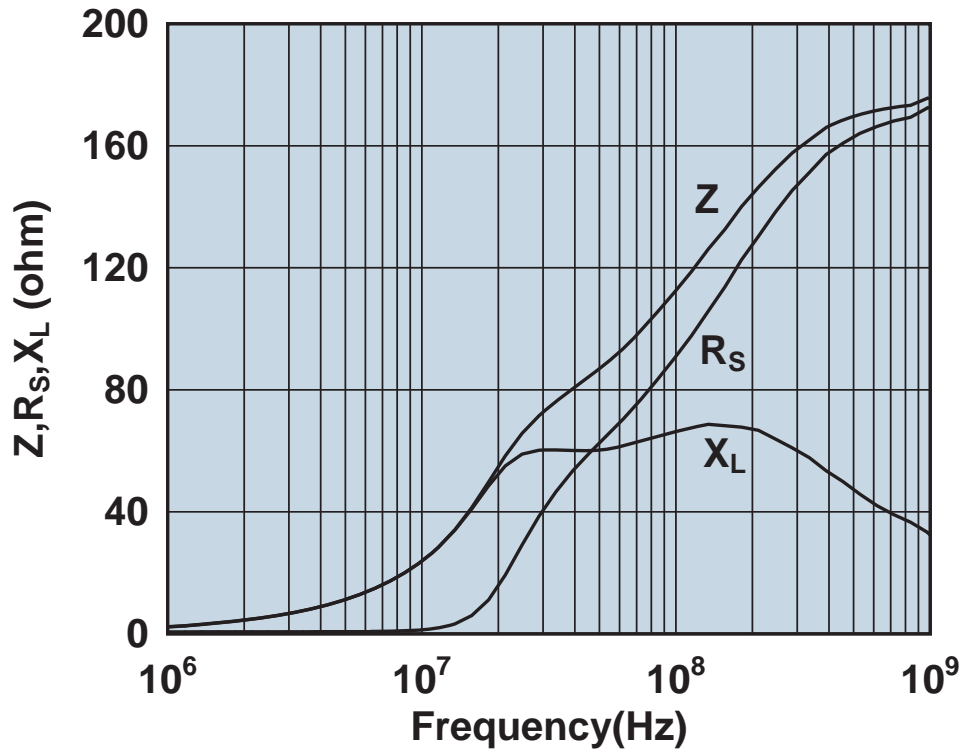

Impedance, reactance, and resistance vs. frequency.

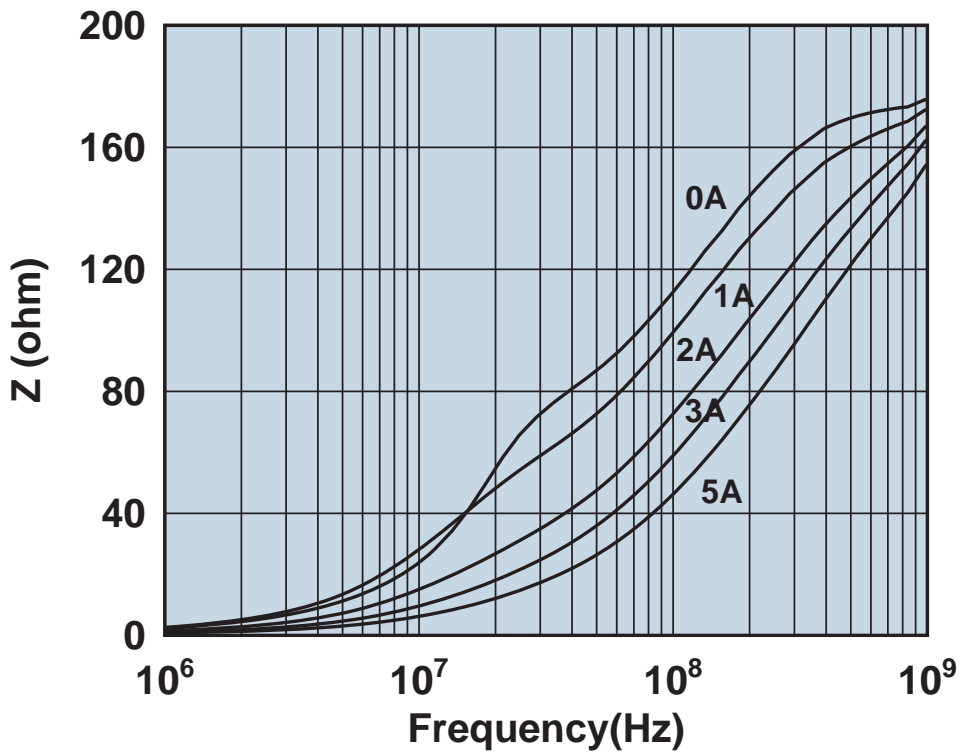

Impedance vs. frequency with dc bias.

2761008112

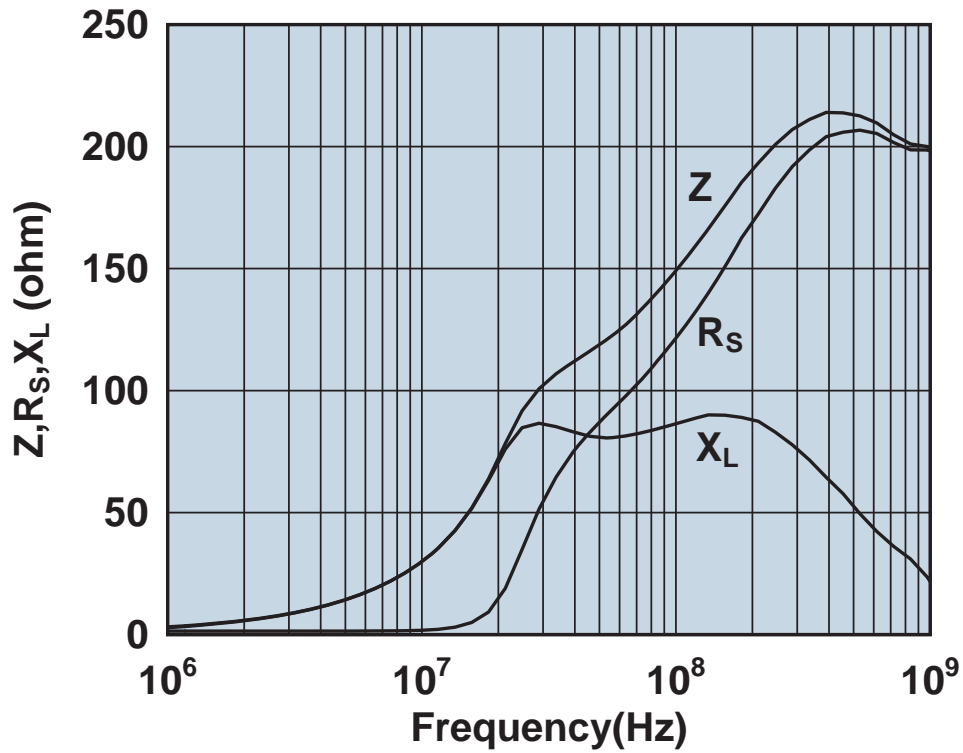

Impedance, reactance, and resistance vs. frequency.

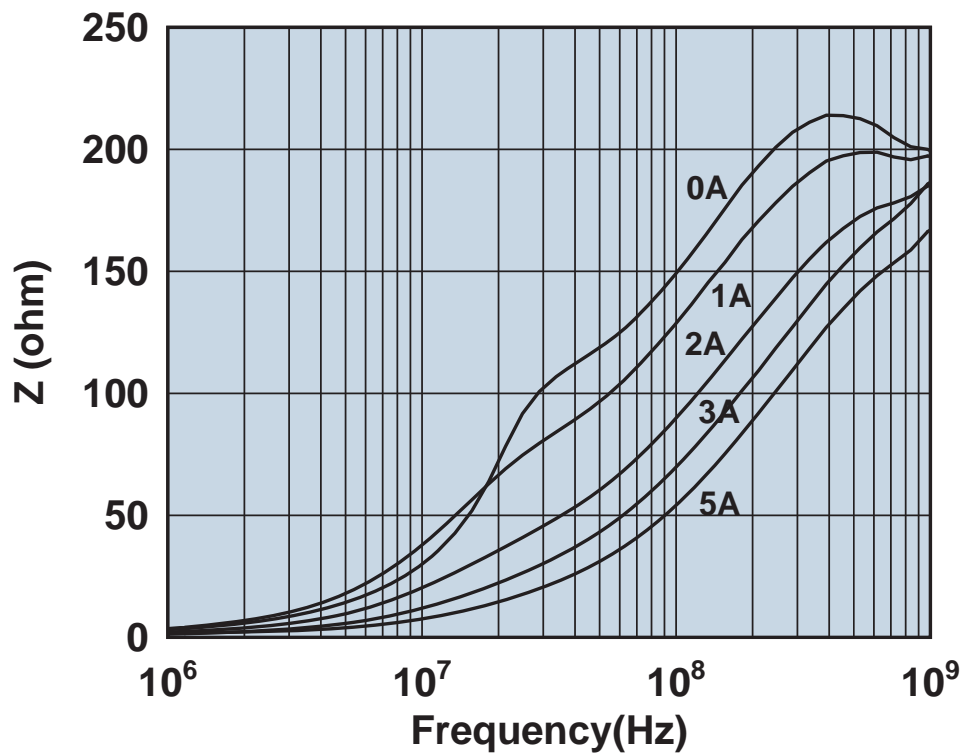

Impedance vs. frequency with dc bias.

2761009112

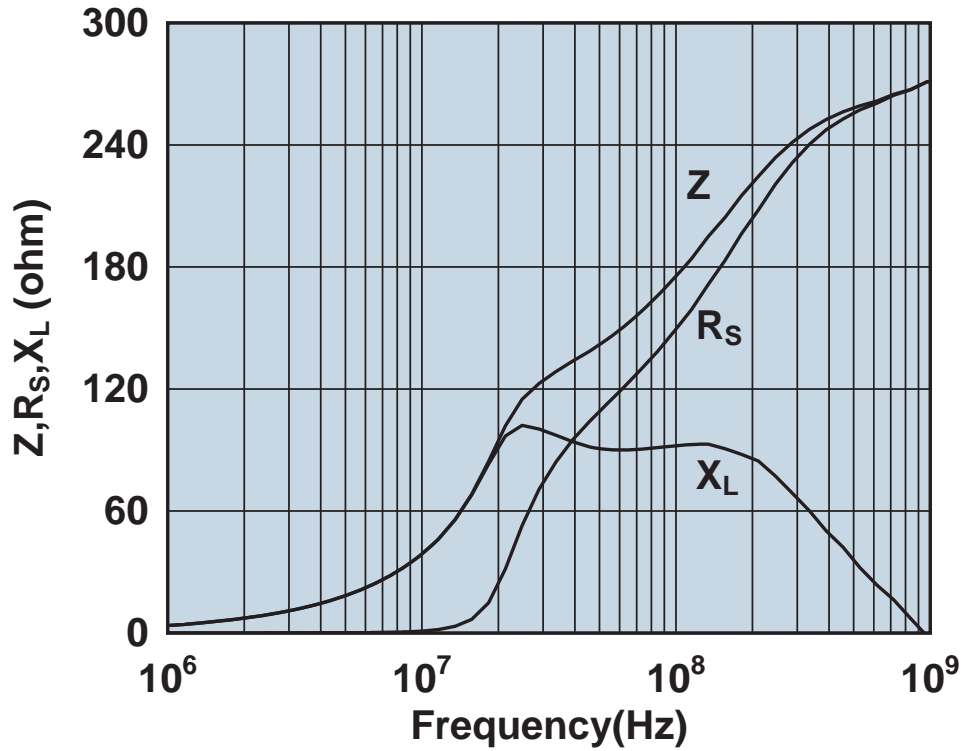

Impedance, reactance, and resistance vs. frequency.

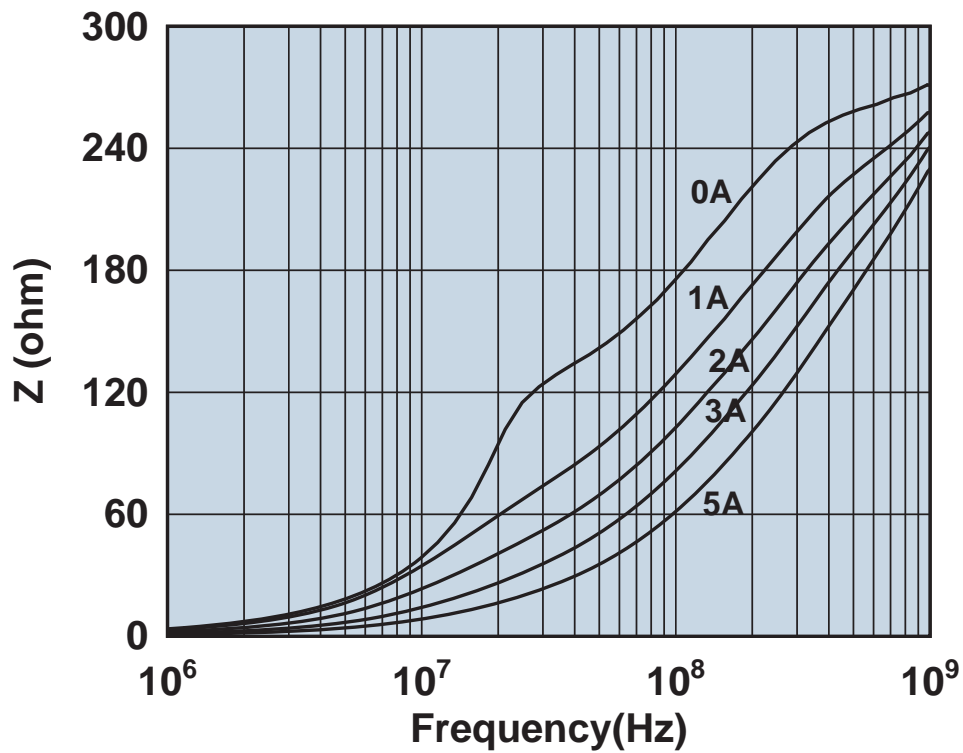

Impedance vs. frequency with dc bias.

2761015112

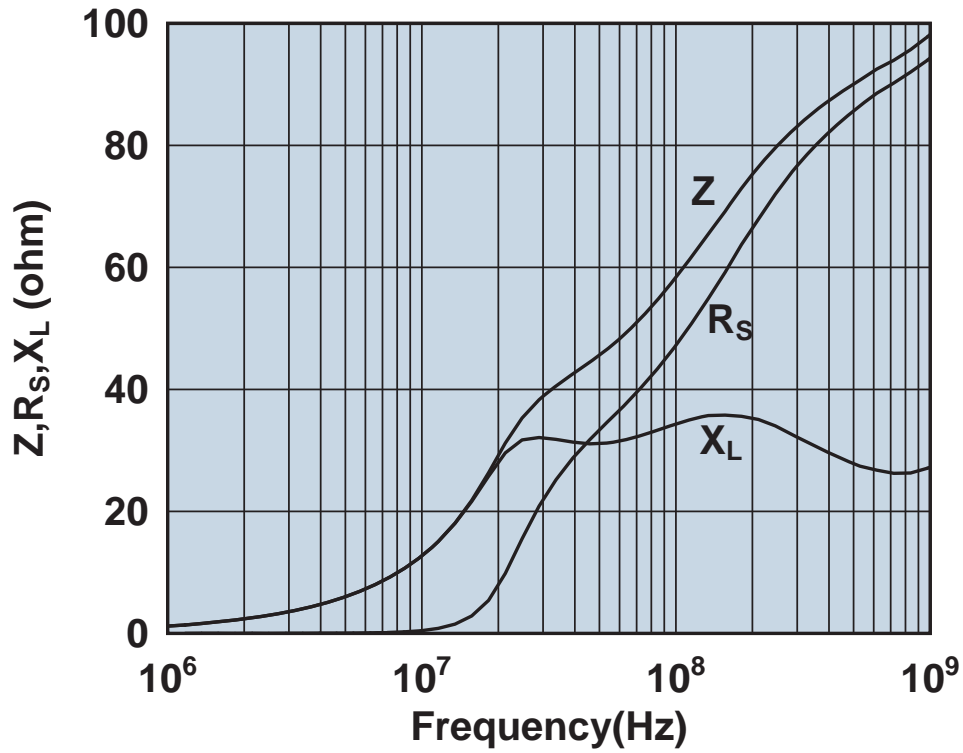

Impedance, reactance, and resistance vs. frequency.

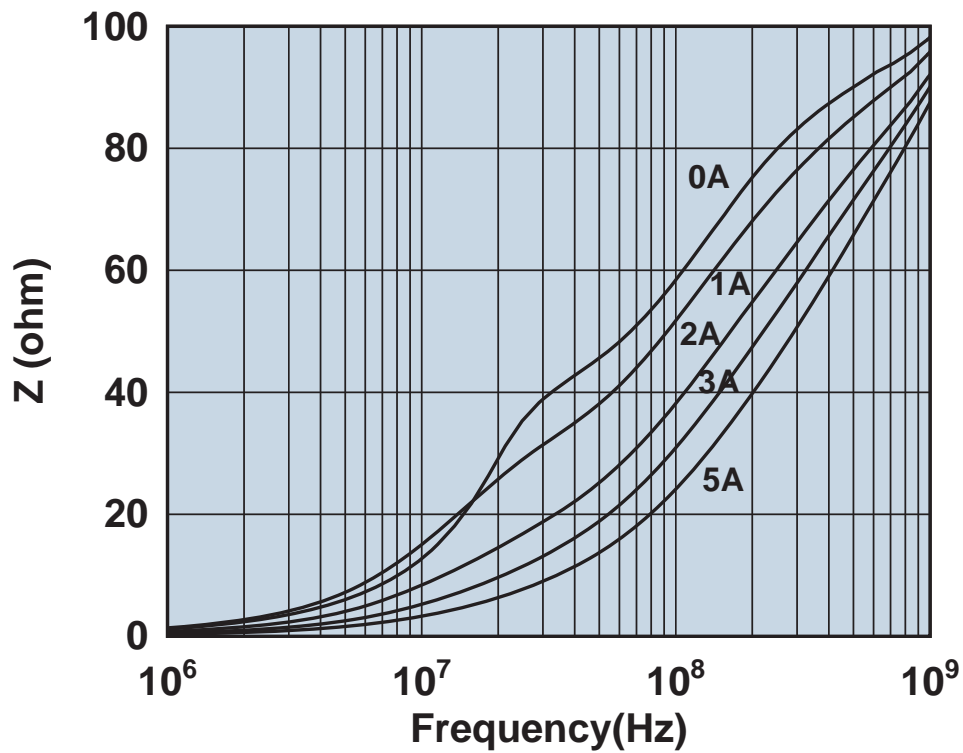

Impedance vs. frequency with dc bias.

2761019447

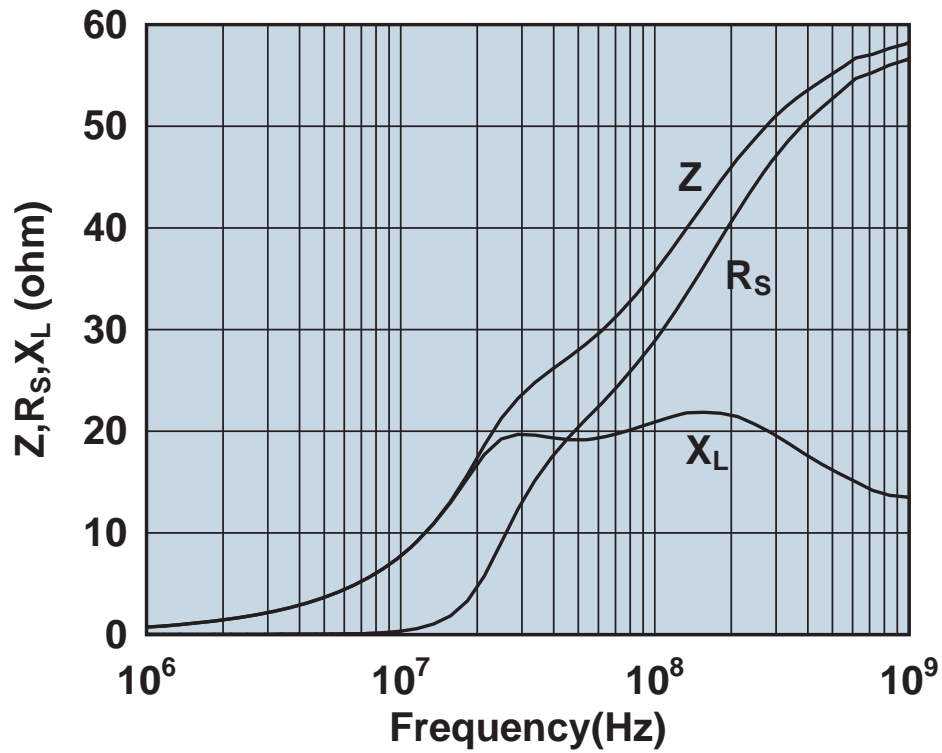

Impedance, reactance, and resistance vs. frequency.

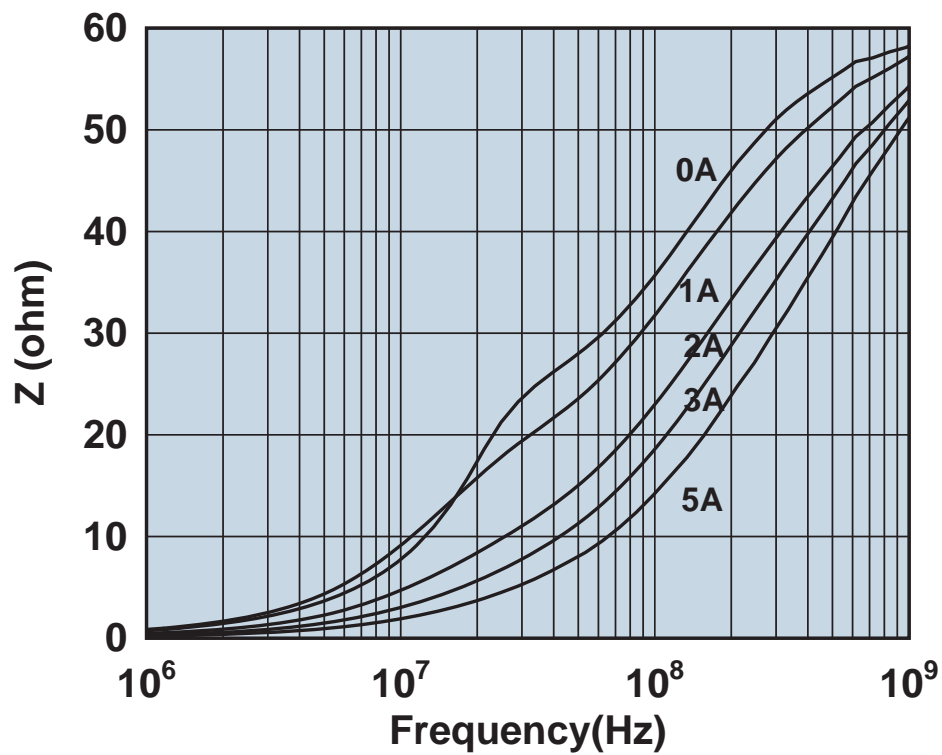

Impedance vs. frequency with dc bias.

2761021447

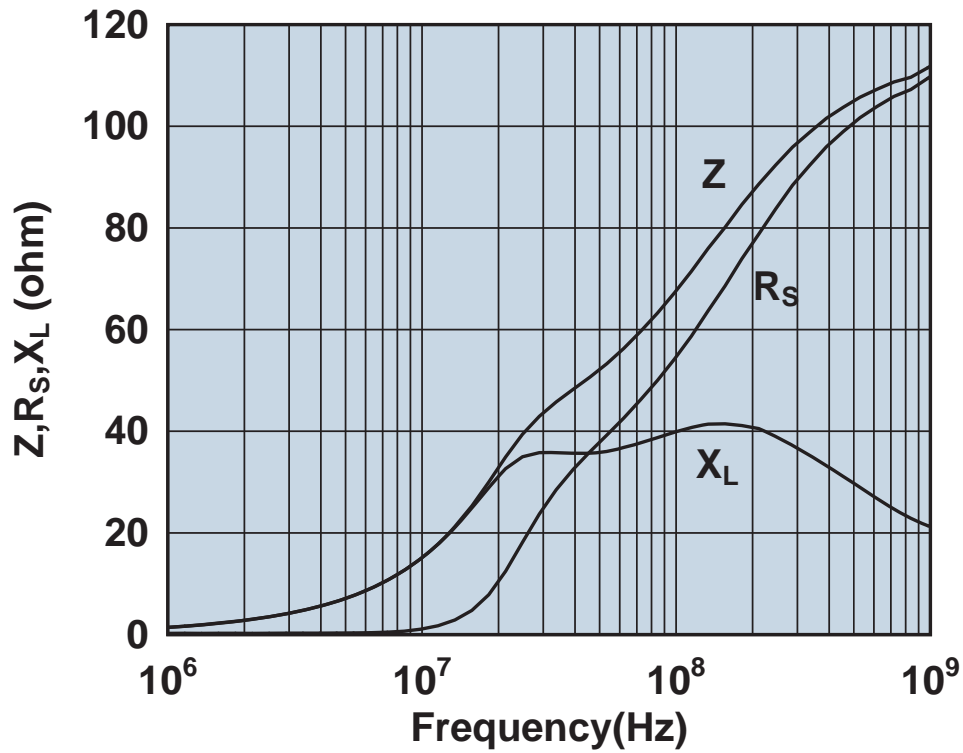

Impedance, reactance, and resistance vs. frequency.

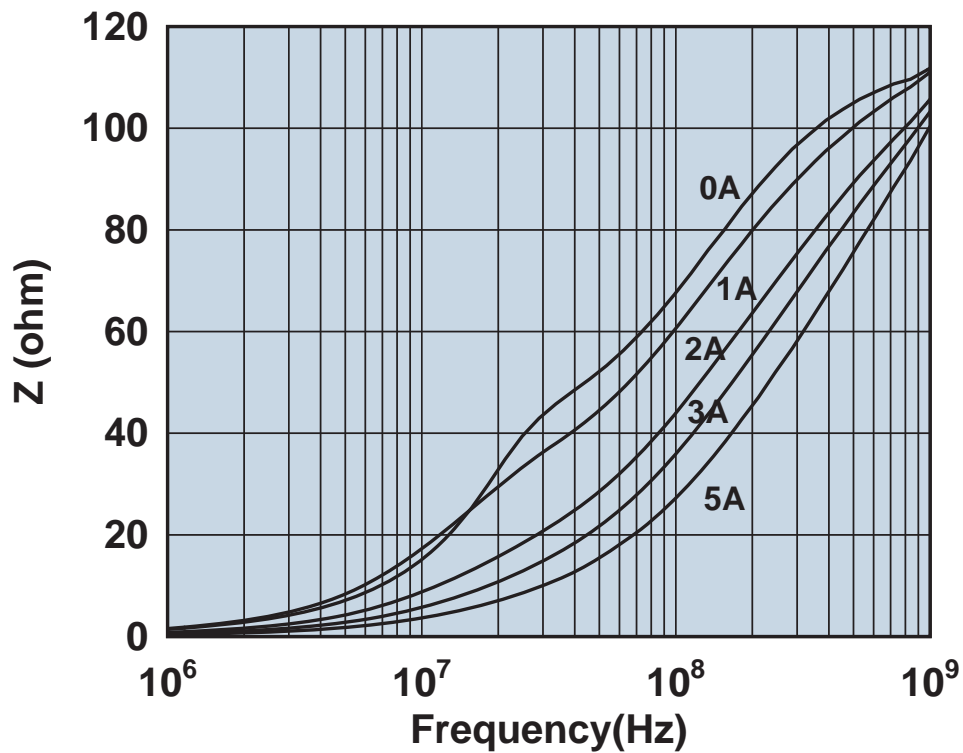

Impedance vs. frequency with dc bias.

2773001112

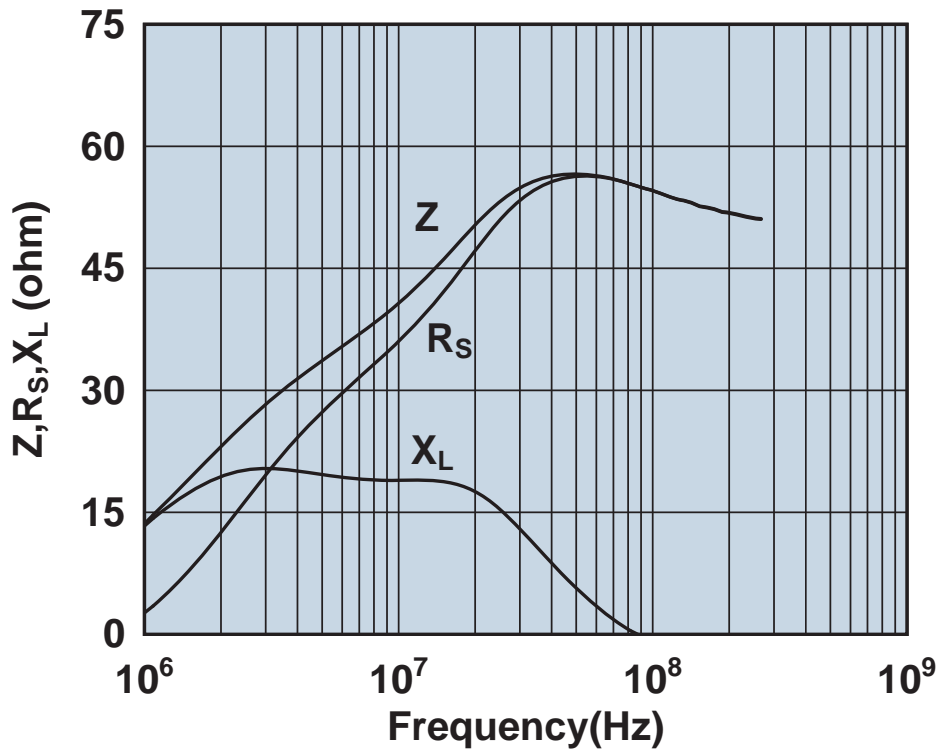

Impedance, reactance, and resistance vs. frequency.

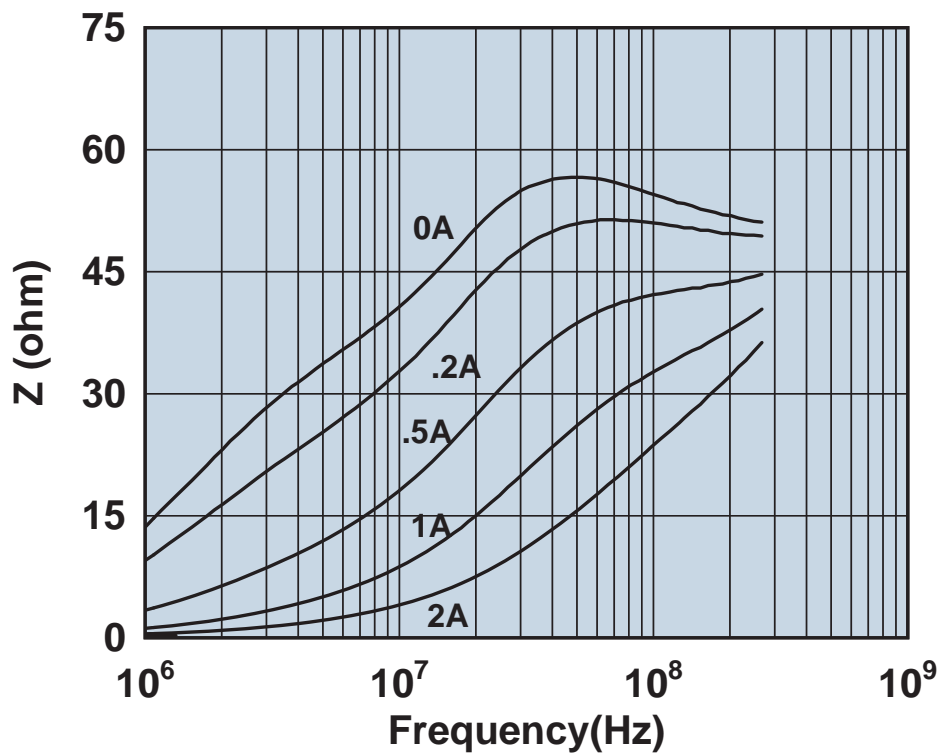

Impedance vs. frequency with dc bias.

2773002112

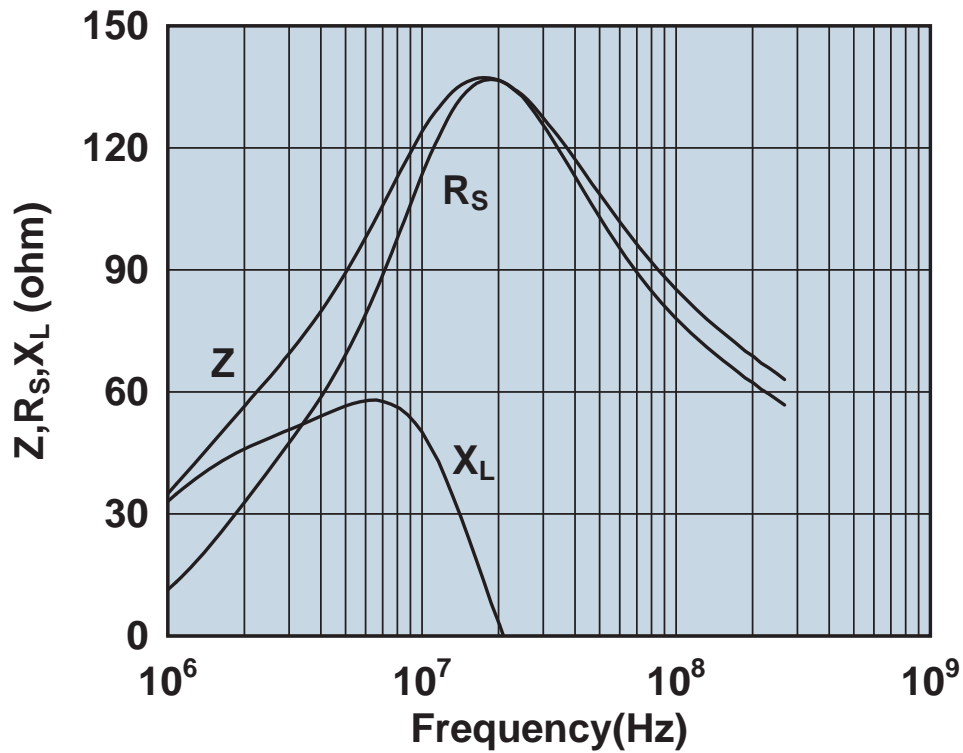

Impedance, reactance, and resistance vs. frequency.

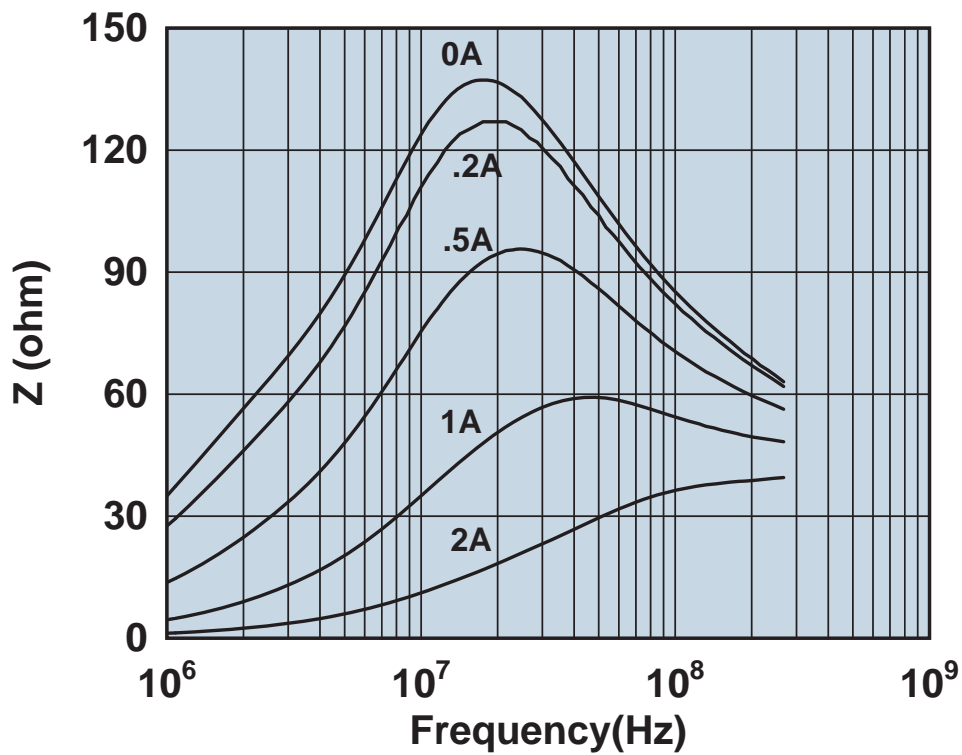

Impedance vs. frequency with dc bias.

2773003112

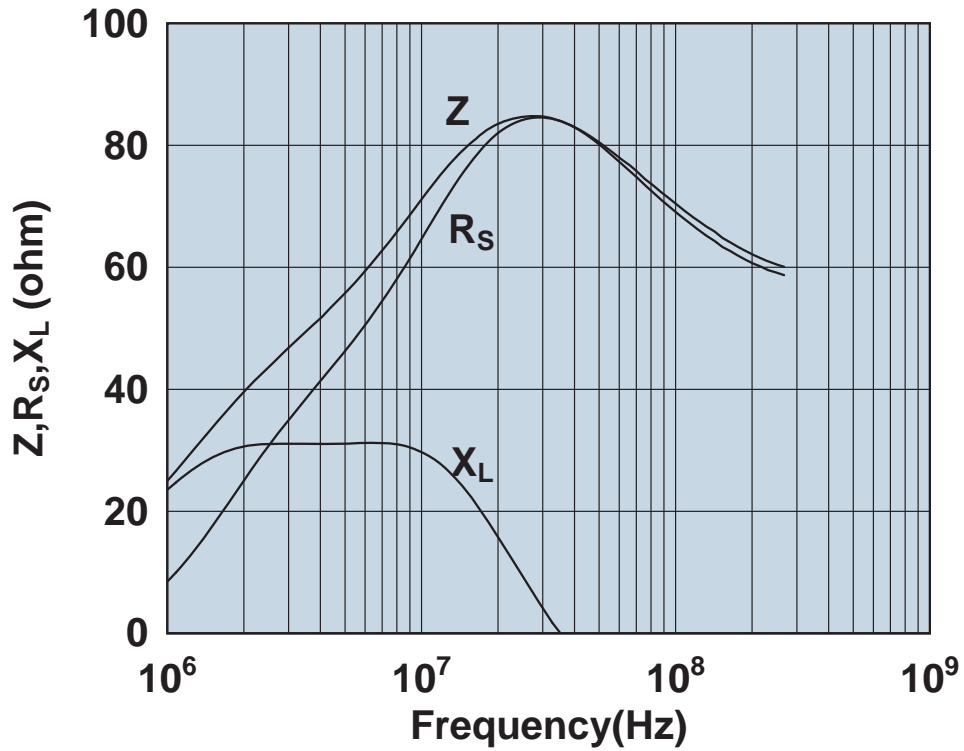

Impedance, reactance, and resistance vs. frequency.

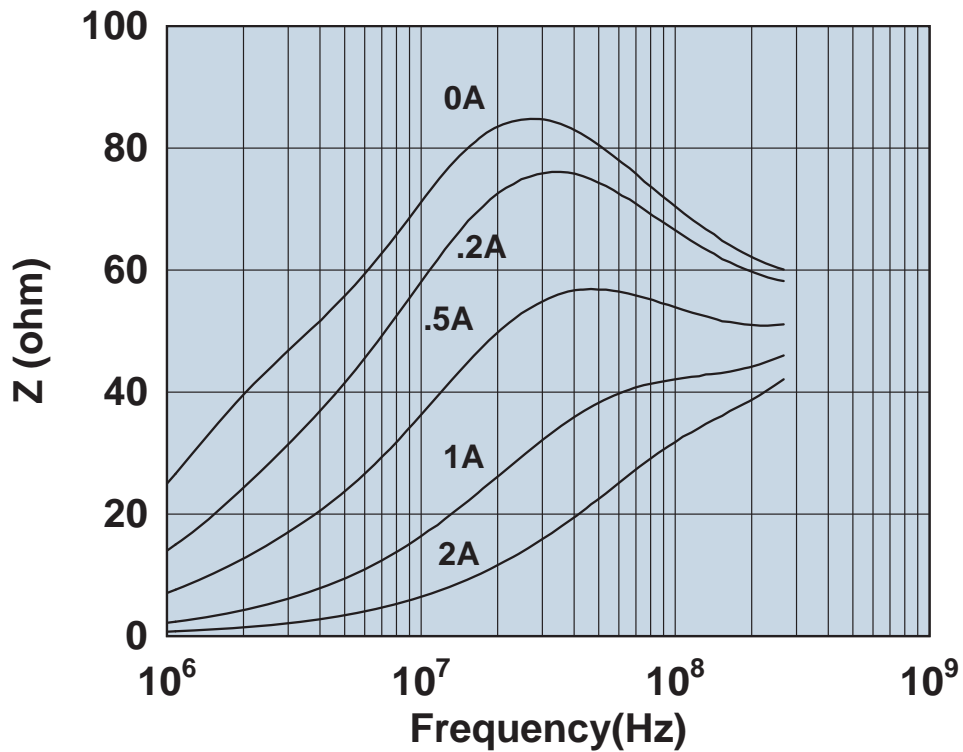

Impedance vs. frequency with dc bias.

2773004112

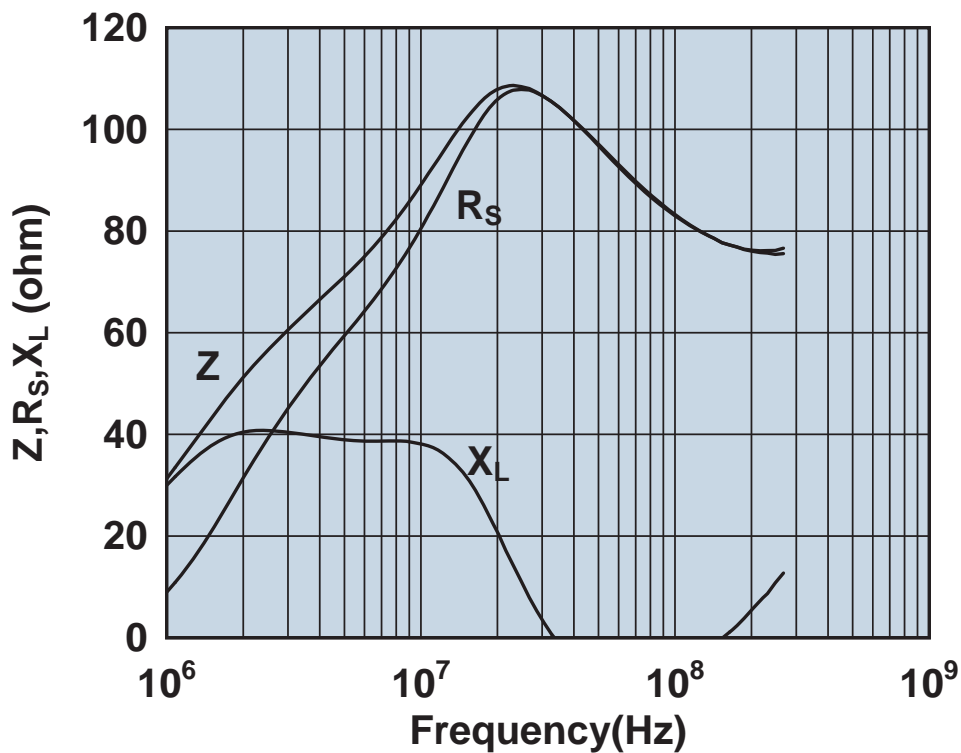

Impedance, reactance, and resistance vs. frequency.

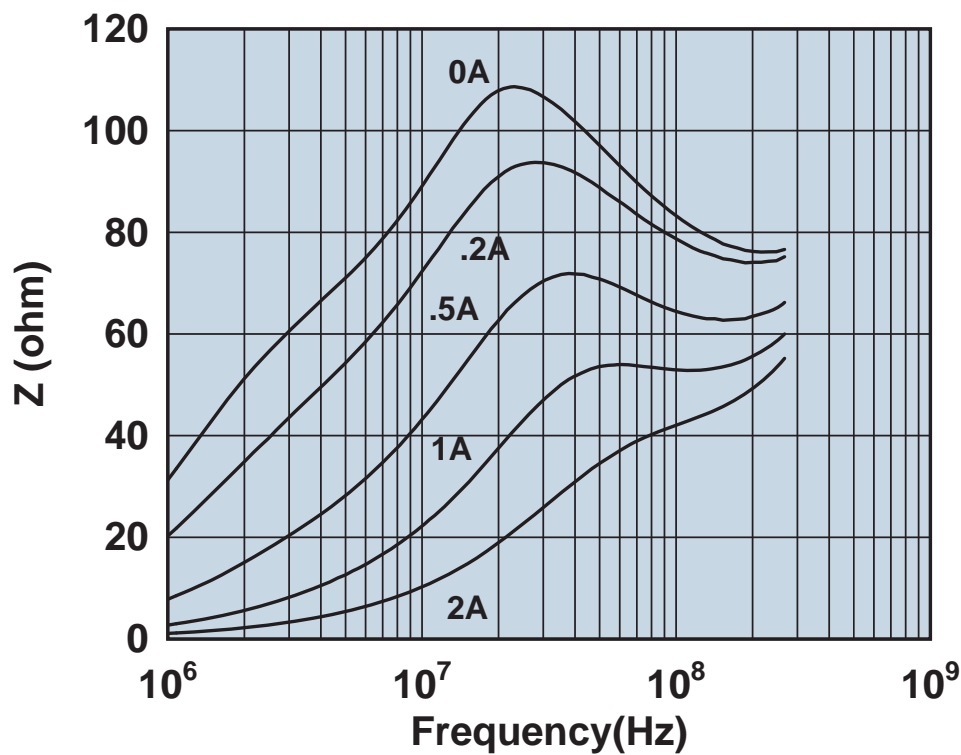

Impedance vs. frequency with dc bias.

2773005112

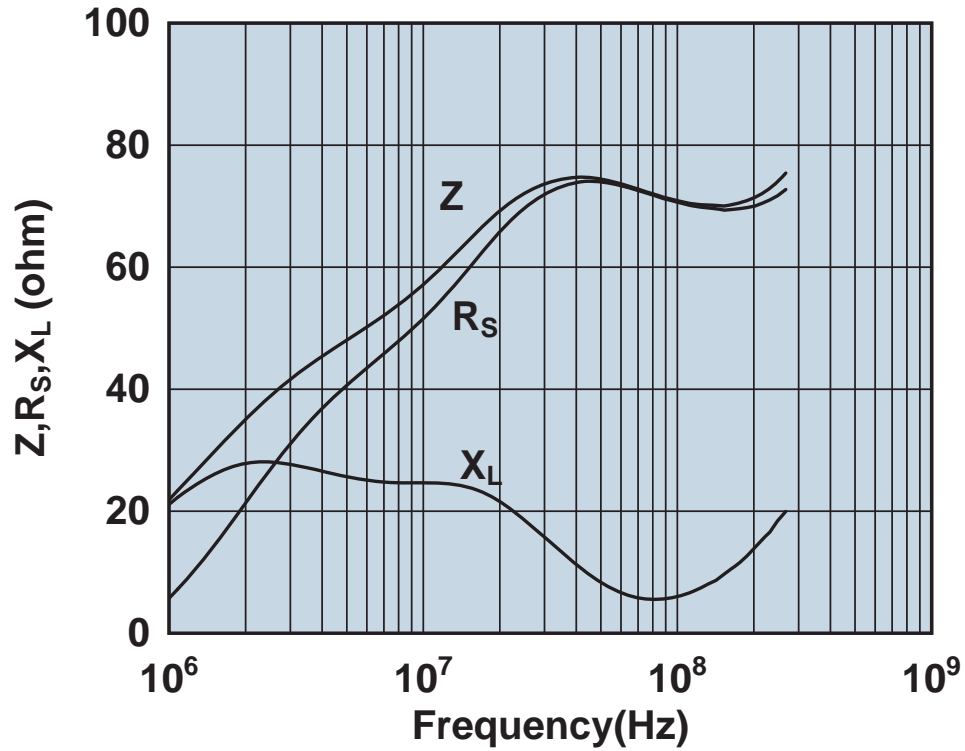

Impedance, reactance, and resistance vs. frequency.

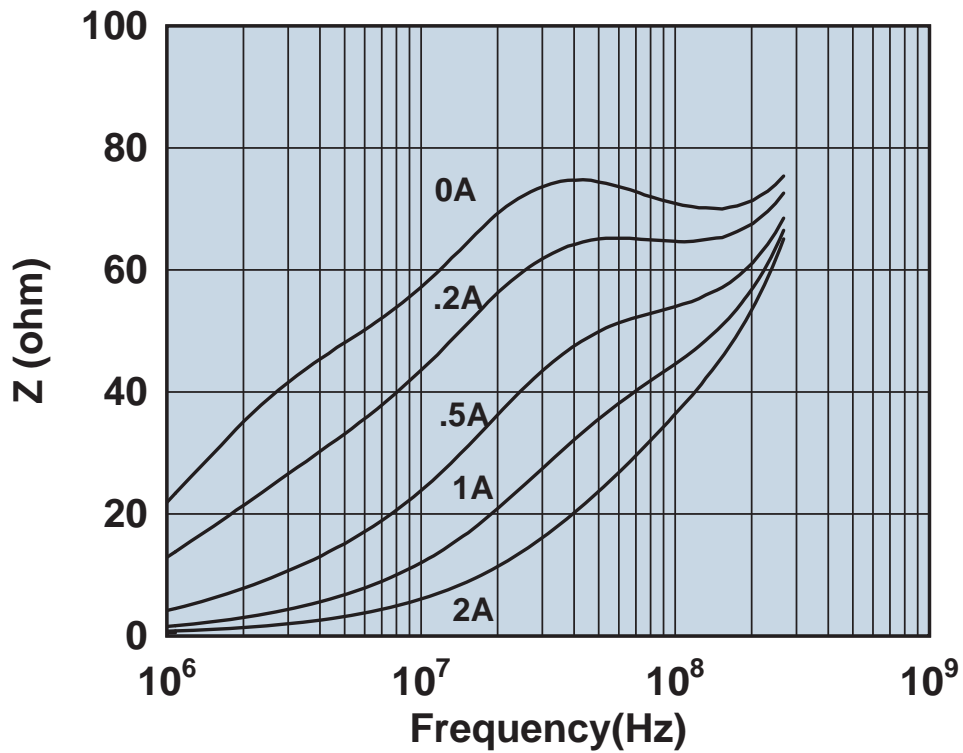

Impedance vs. frequency with dc bias.

2773007112

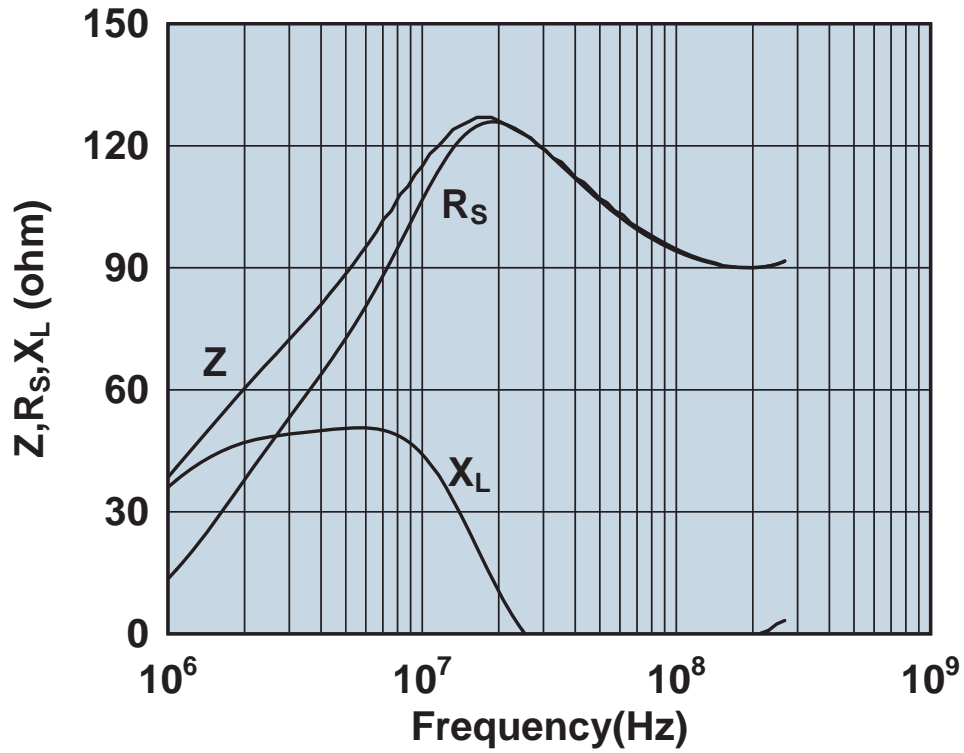

Impedance, reactance, and resistance vs. frequency.

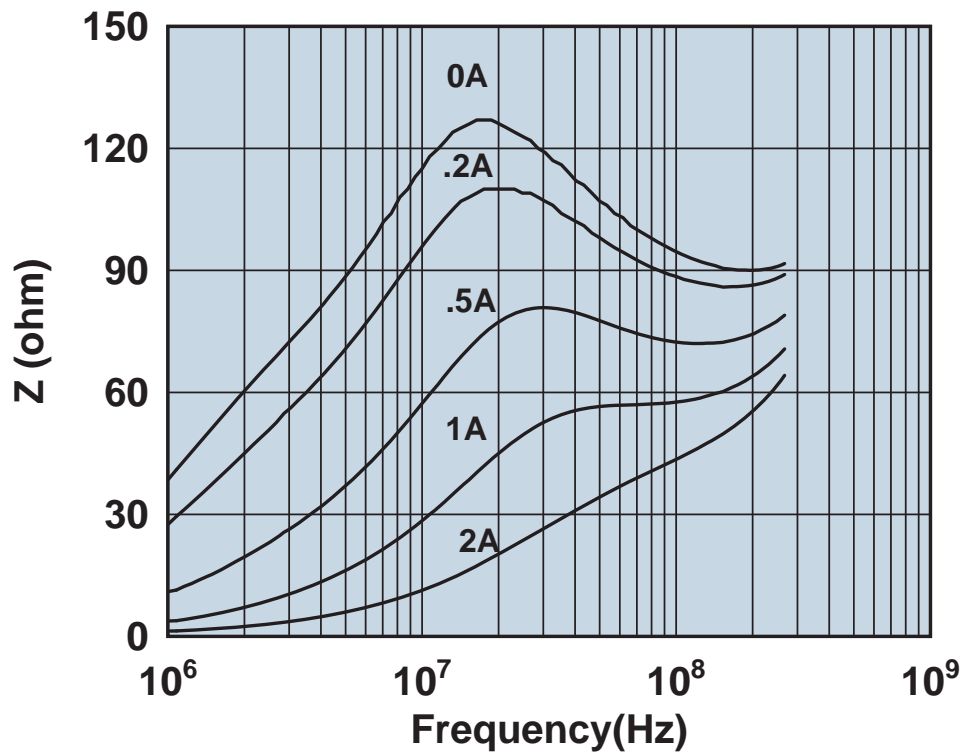

Impedance vs. frequency with dc bias.

2773008112

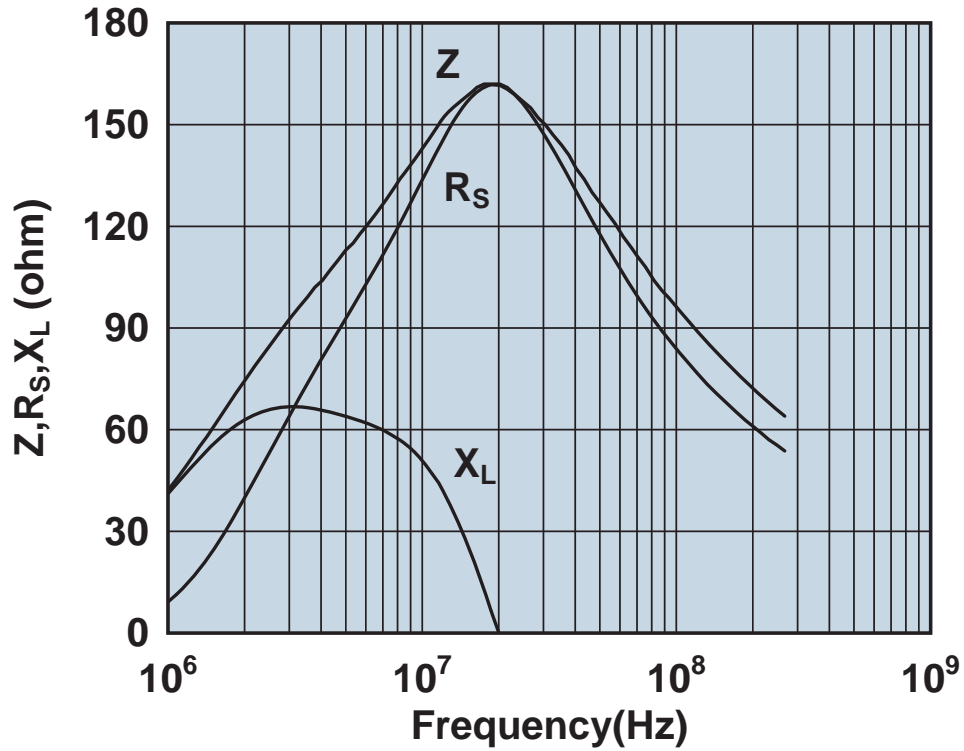

Impedance, reactance, and resistance vs. frequency.

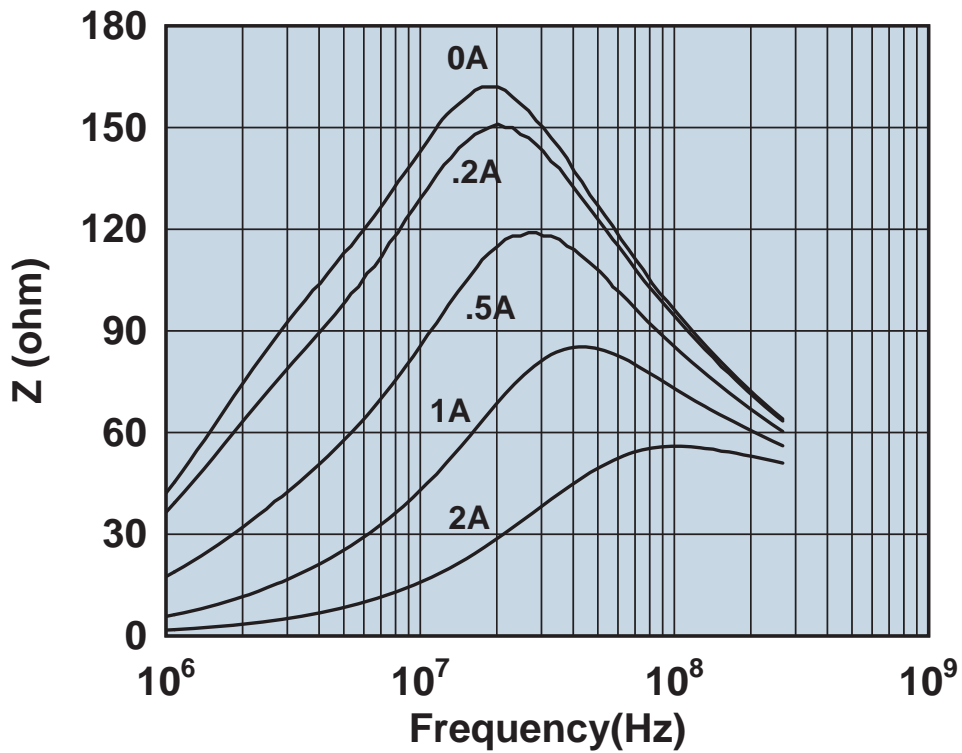

Impedance vs. frequency with dc bias.

2773009112

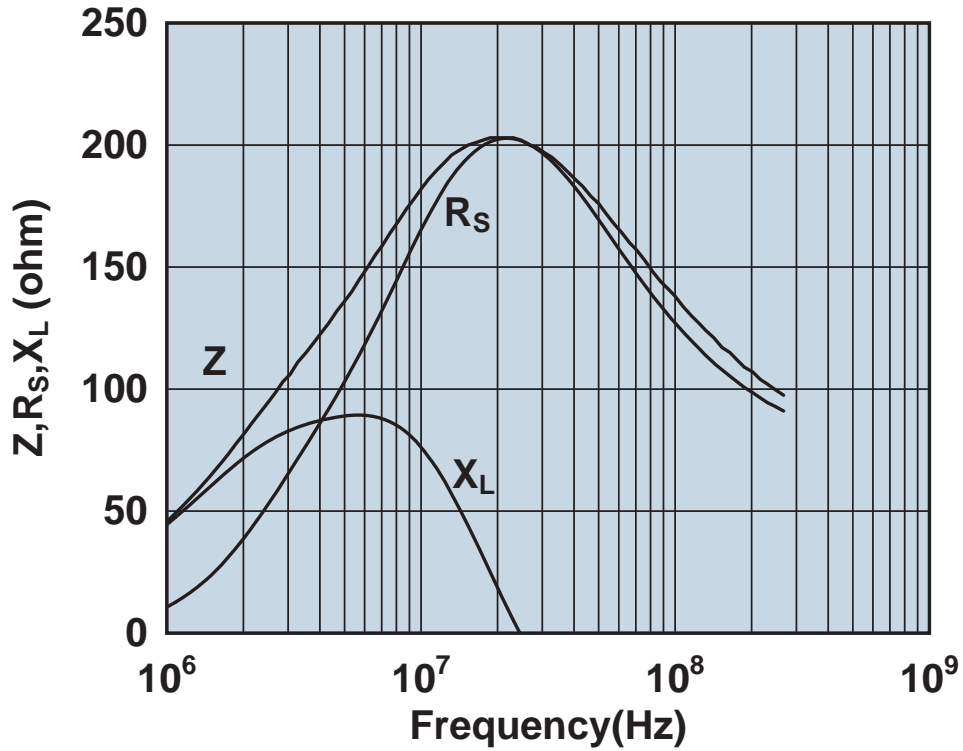

Impedance, reactance, and resistance vs. frequency.

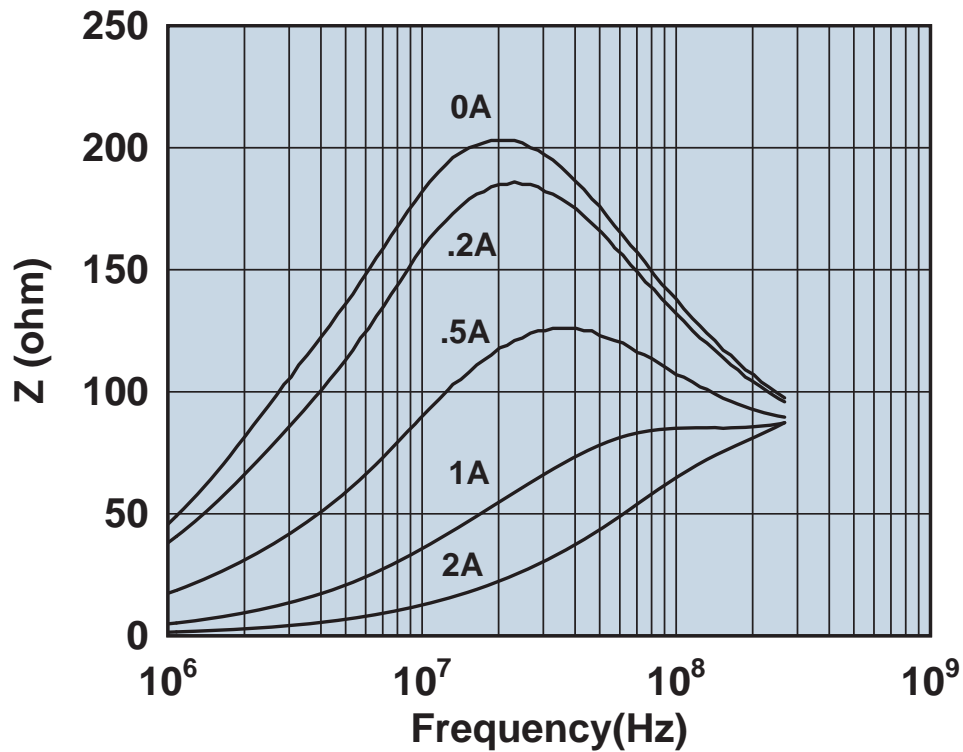

Impedance vs. frequency with dc bias.

2773015112

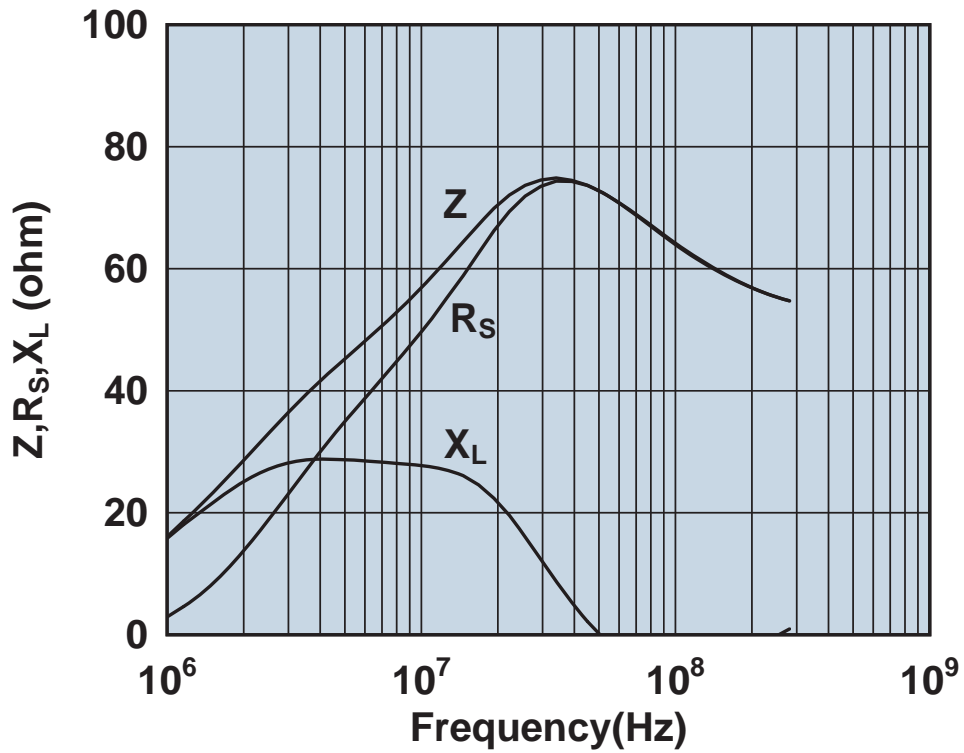

Impedance, reactance, and resistance vs. frequency.

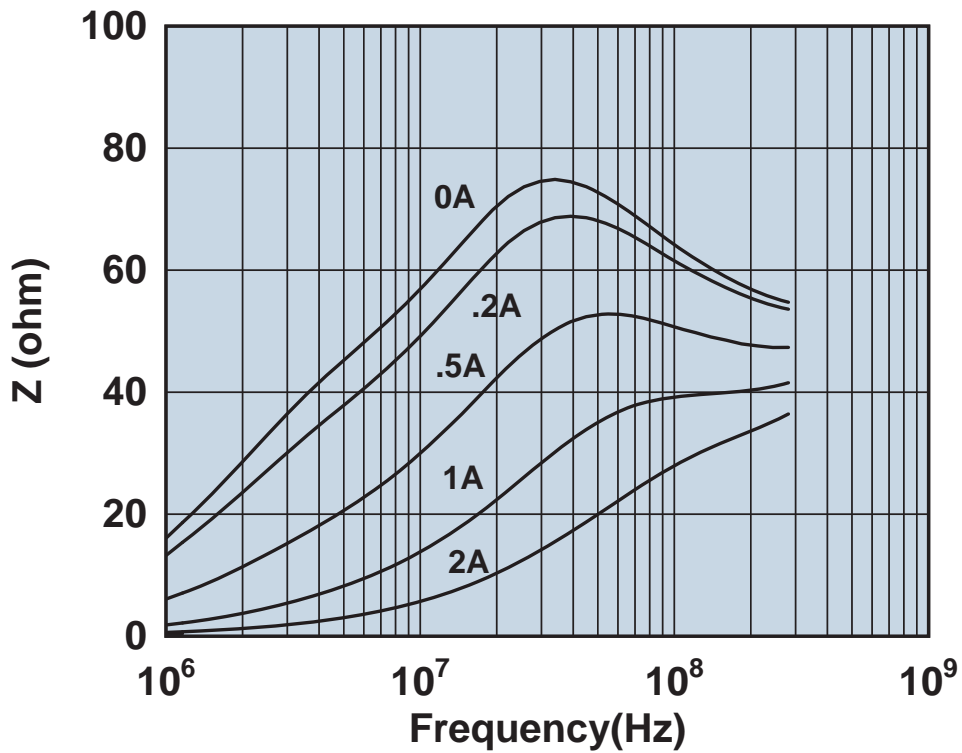

Impedance vs. frequency with dc bias.

2773019447

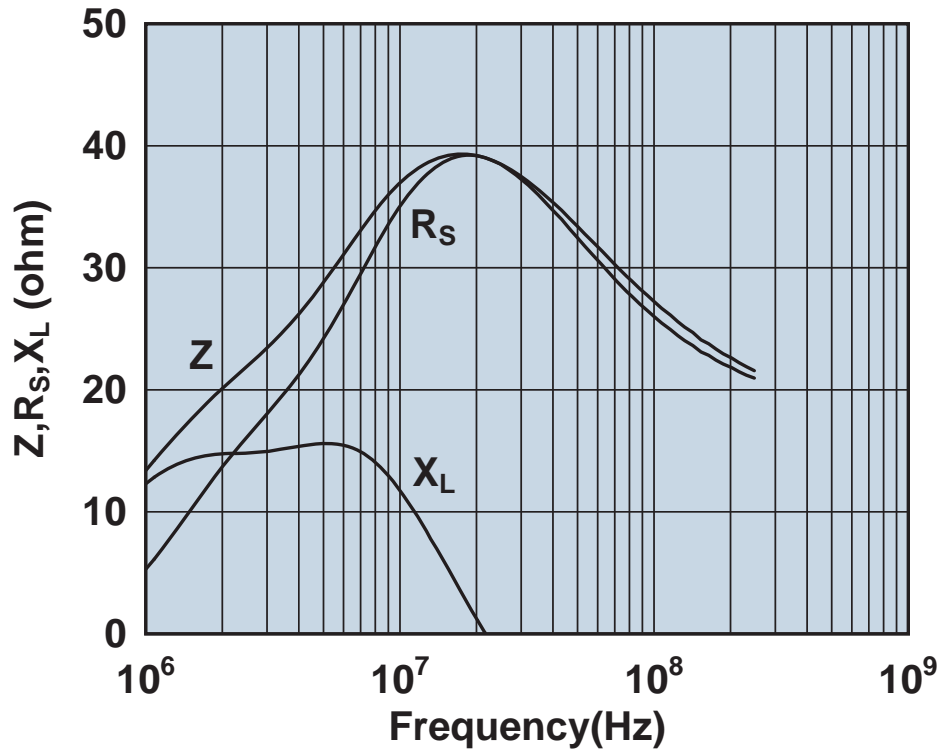

Impedance, reactance, and resistance vs. frequency.

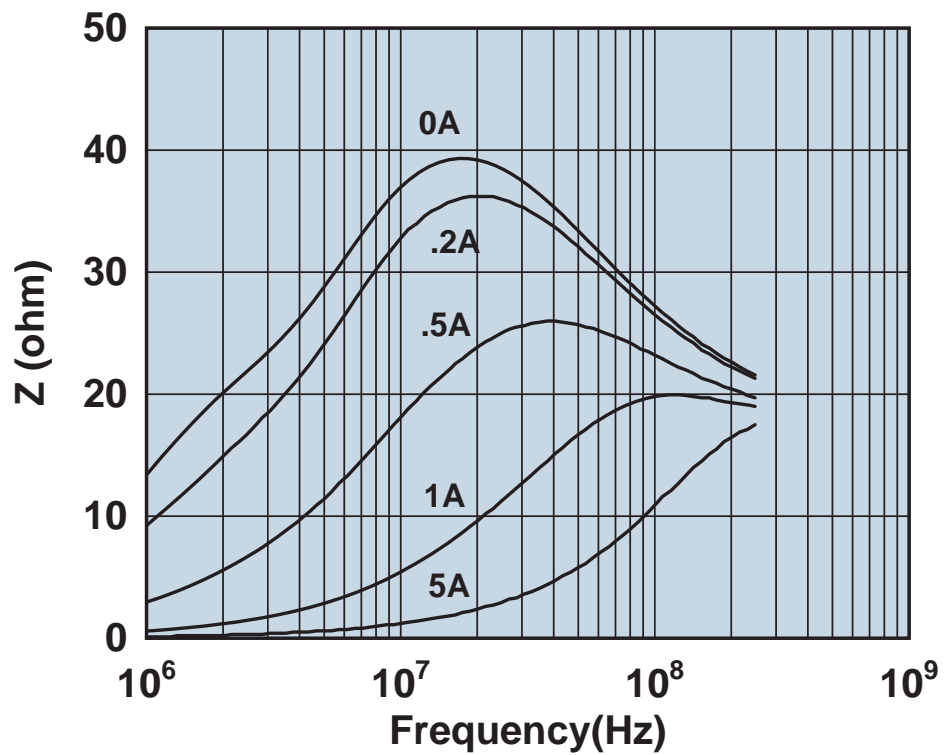

Impedance vs. frequency with dc bias.

2773021447

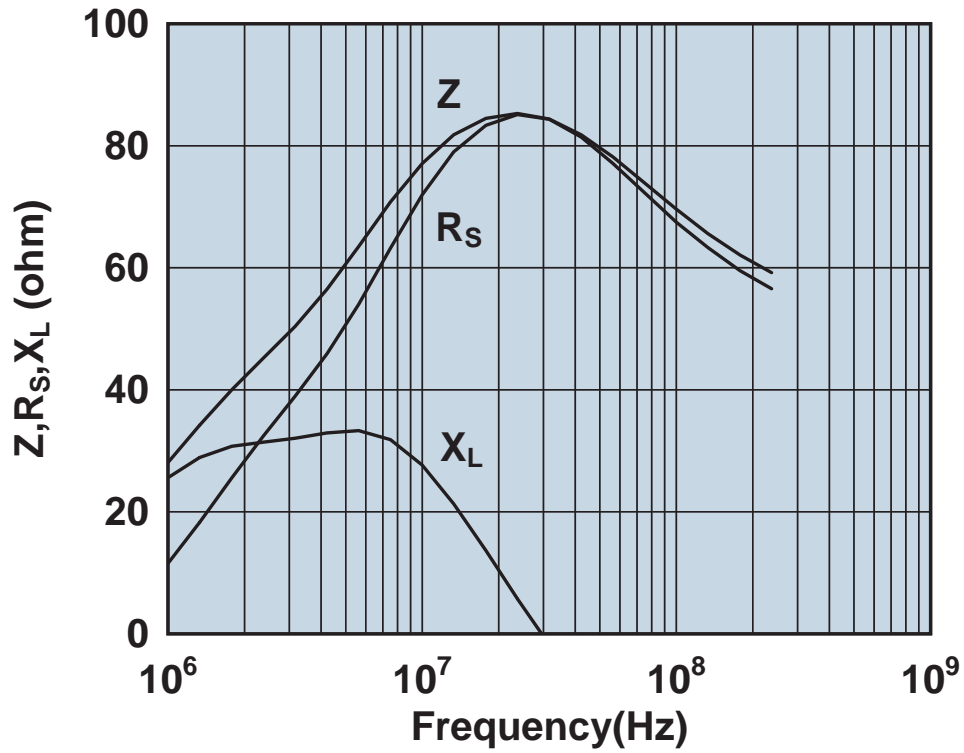

Impedance, reactance, and resistance vs. frequency.

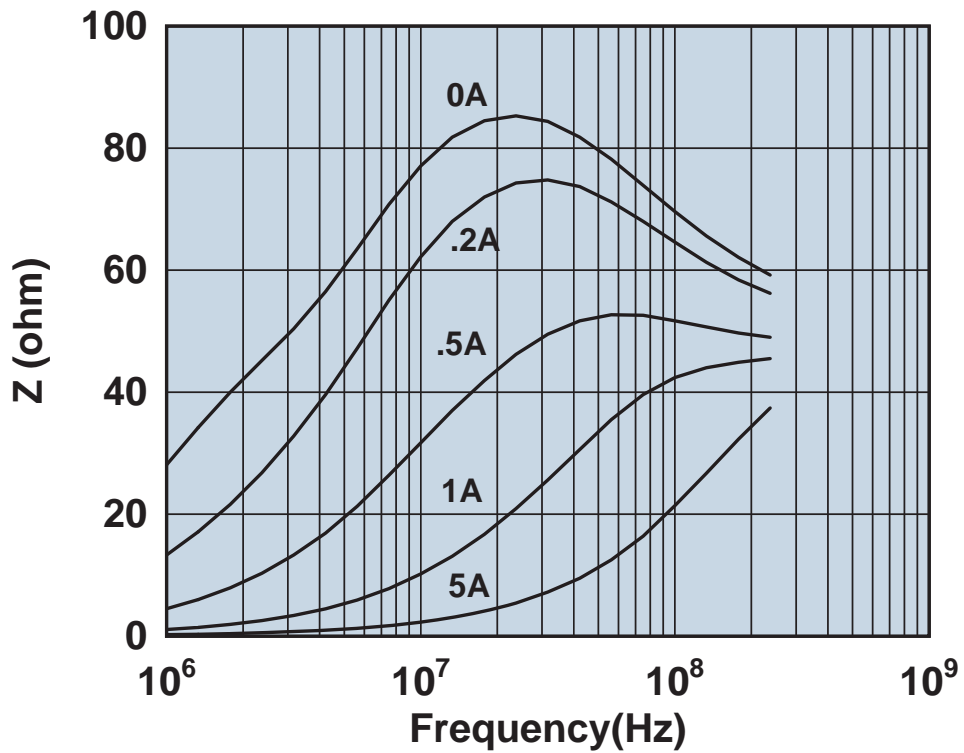

Impedance vs. frequency with dc bias.

2773037447

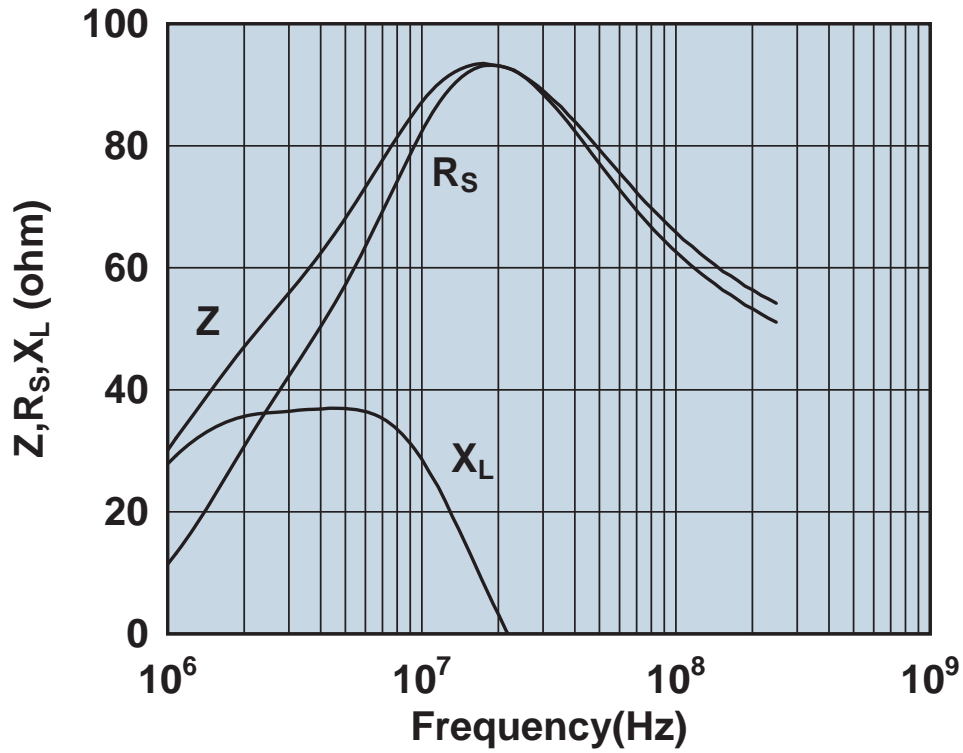

Impedance, reactance, and resistance vs. frequency.

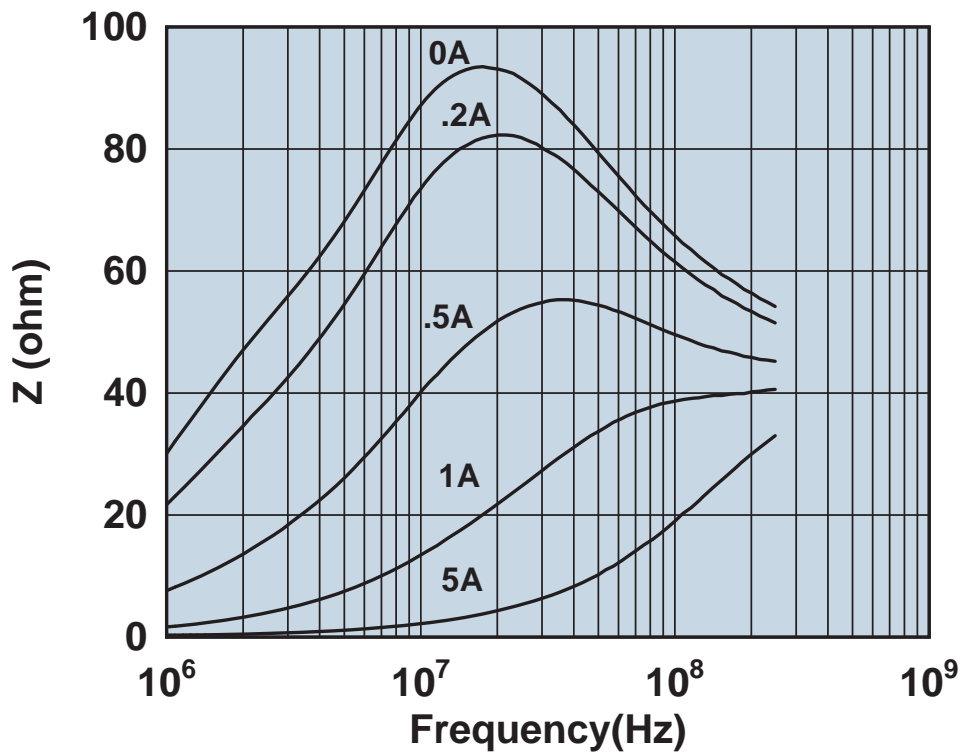

Impedance vs. frequency with dc bias.

277304447

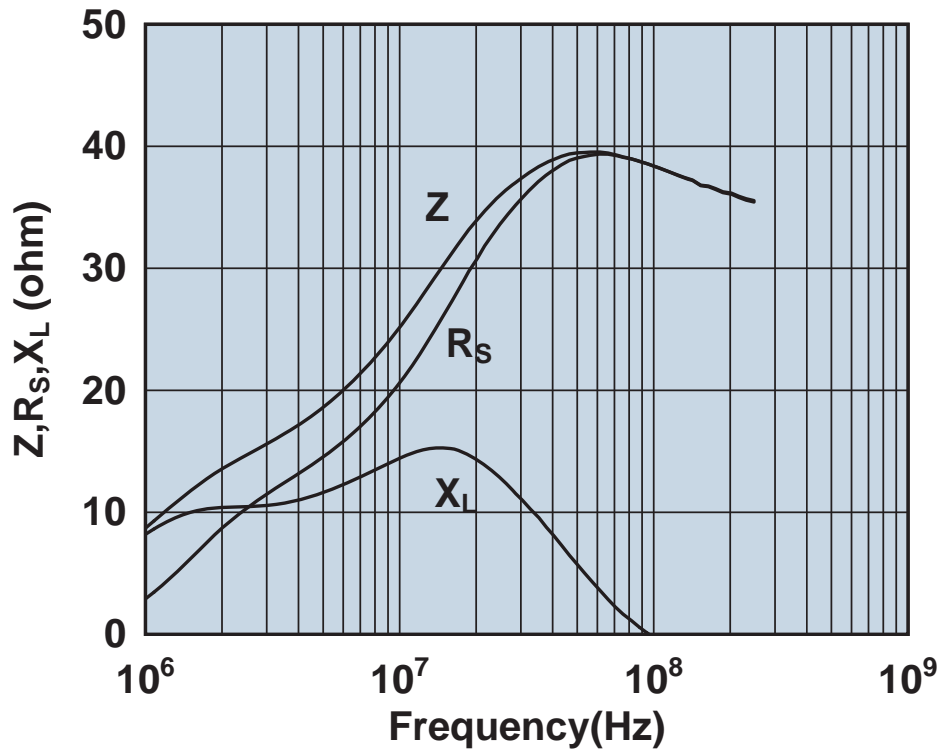

Impedance, reactance, and resistance vs. frequency.

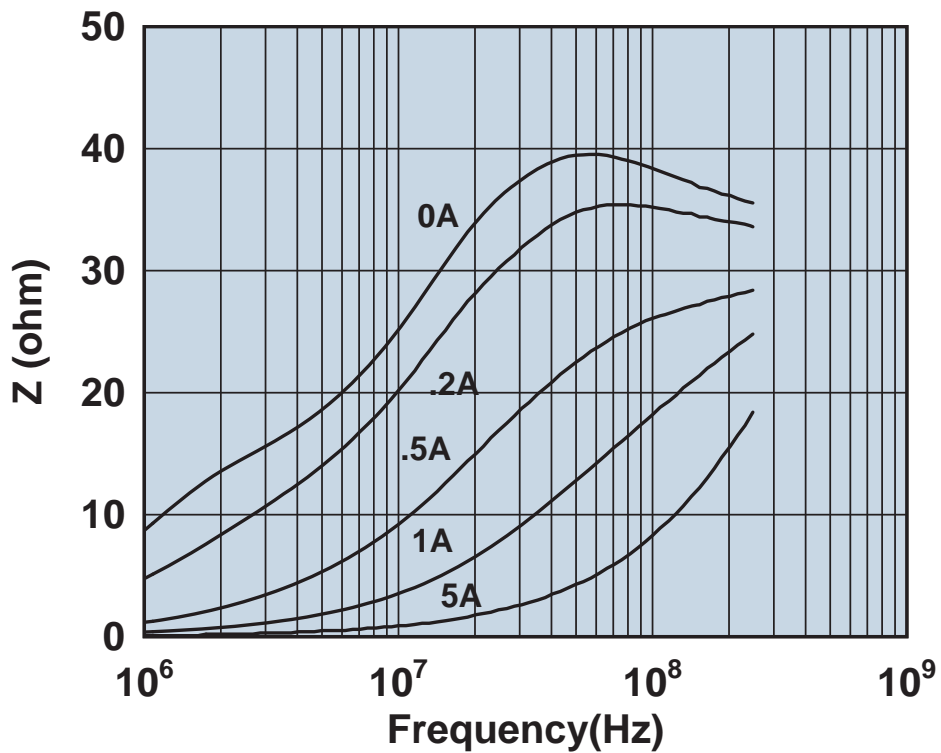

Impedance vs. frequency with dc bias.

2843000102

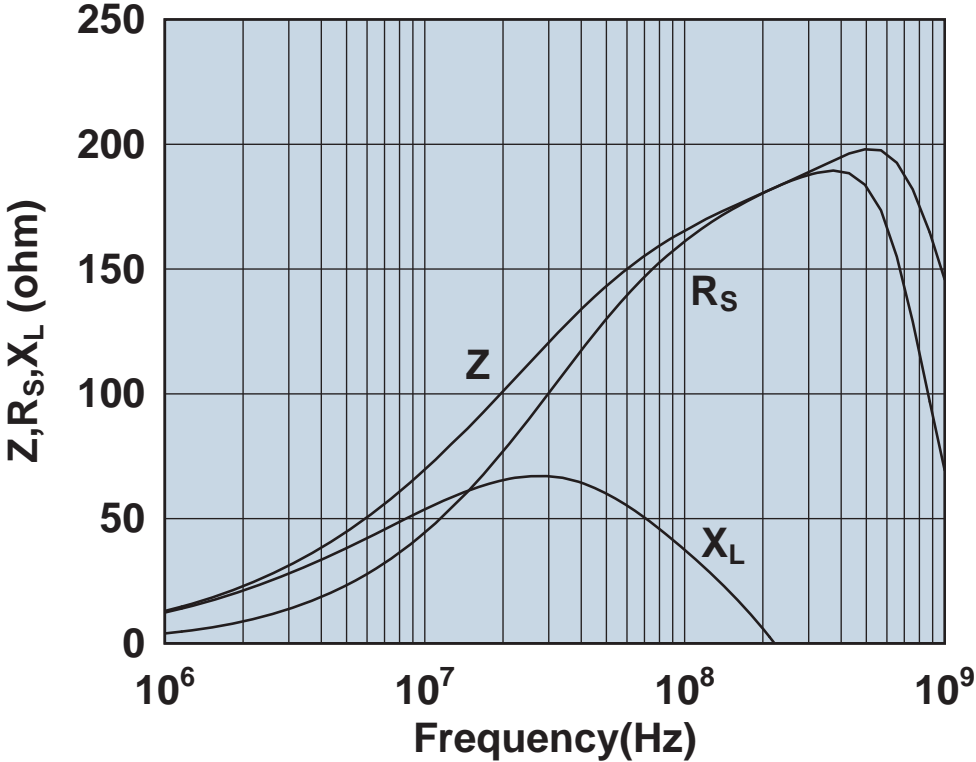

Impedance, reactance, and resistance vs. frequency.

2843000202

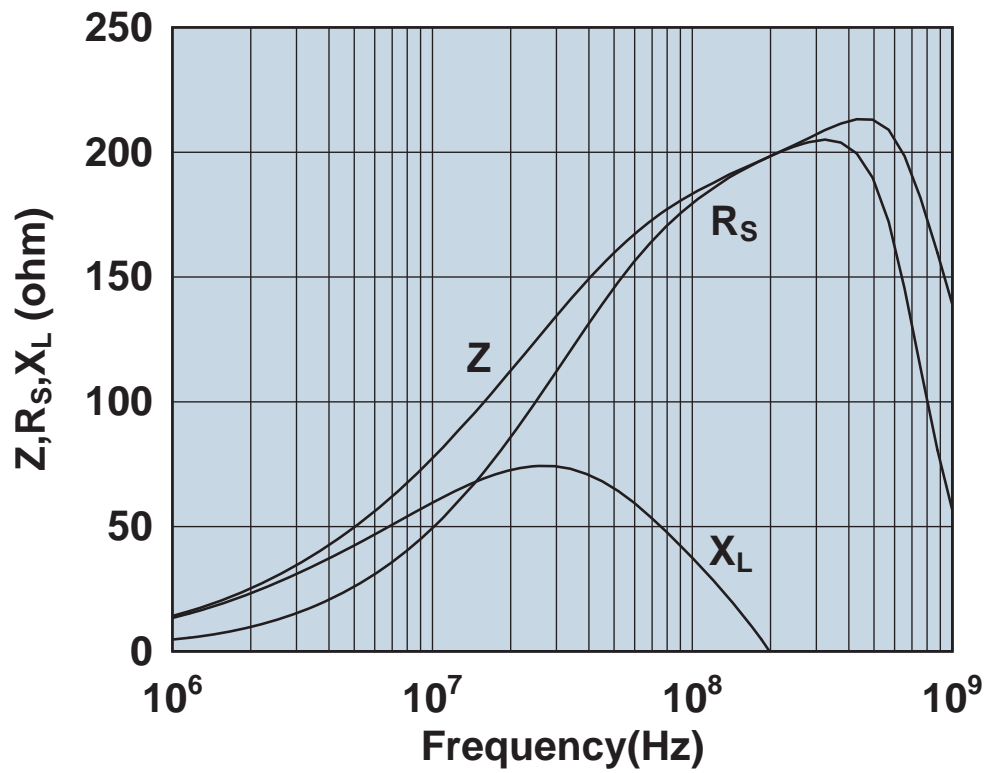

Impedance, reactance, and resistance vs. frequency.

2843000302

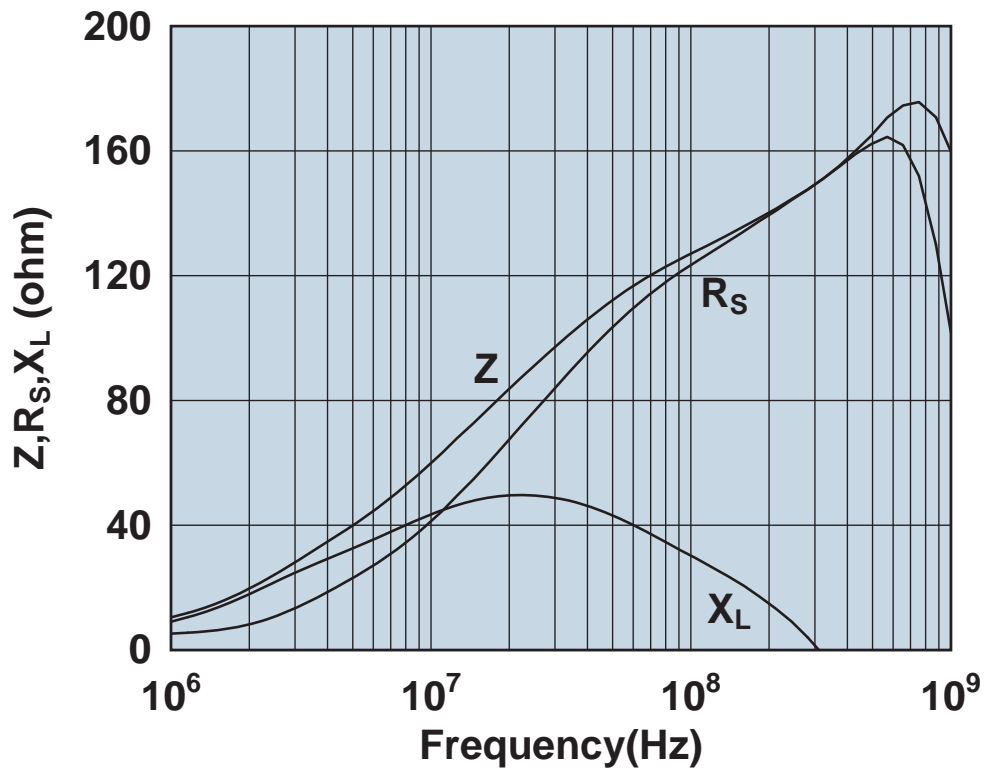

Impedance, reactance, and resistance vs. frequency.

2843001502

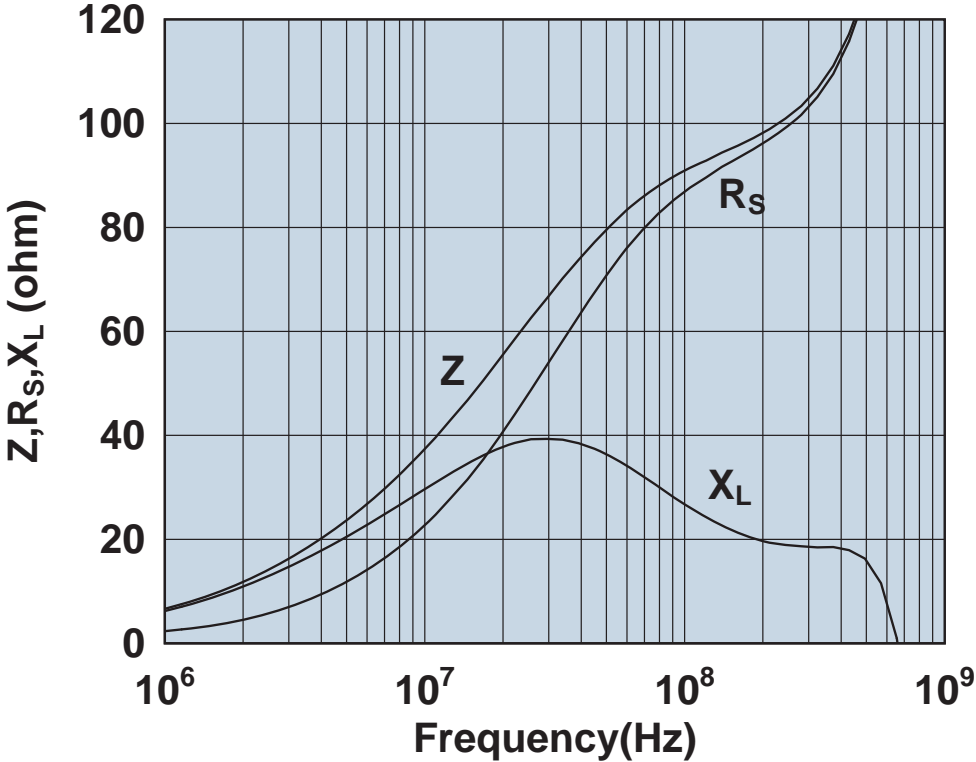

Impedance, reactance, and resistance vs. frequency.

2843001702

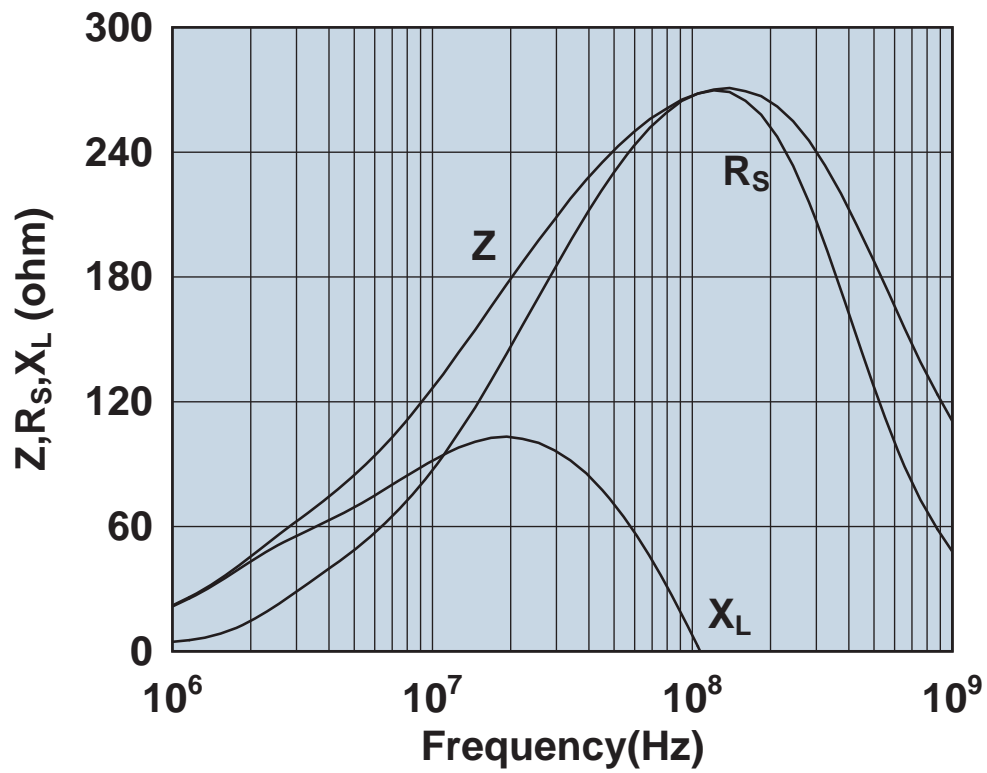

Impedance, reactance, and resistance vs. frequency.

2843001802

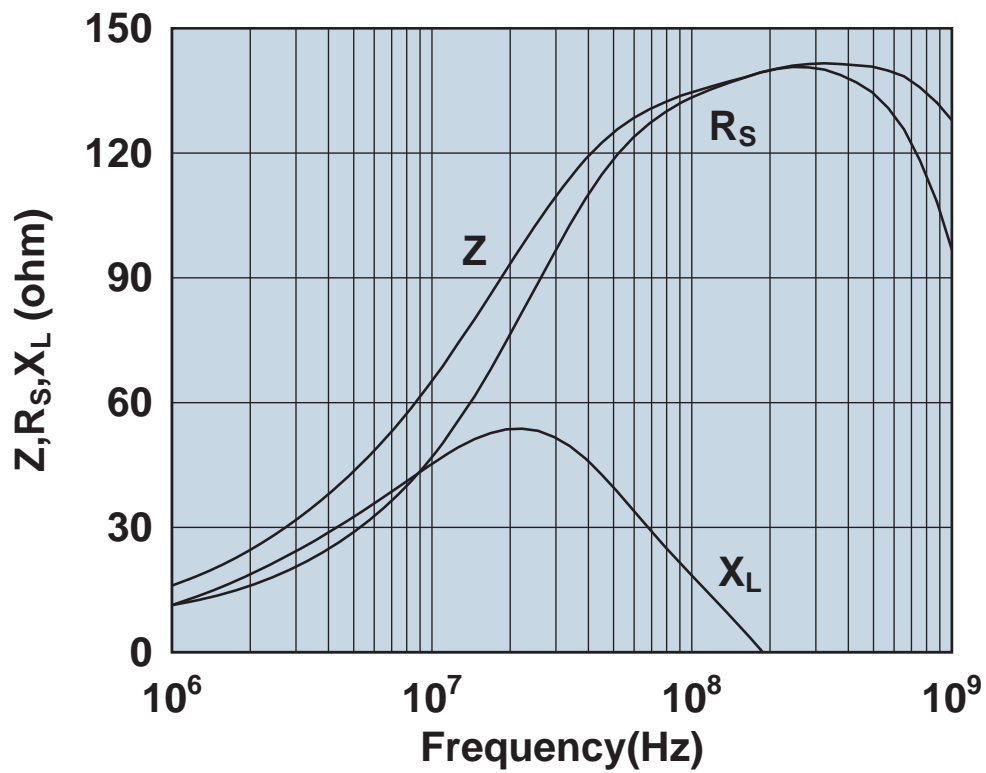

Impedance, reactance, and resistance vs. frequency.

2843002302

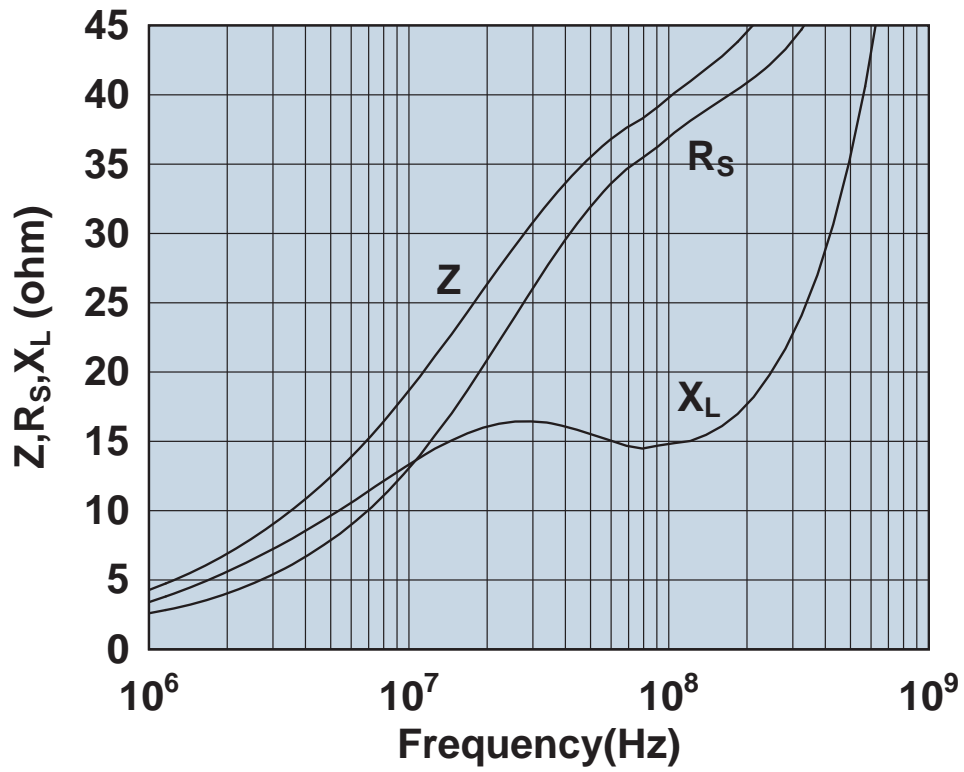

Impedance, reactance, and resistance vs. frequency.

2843002402

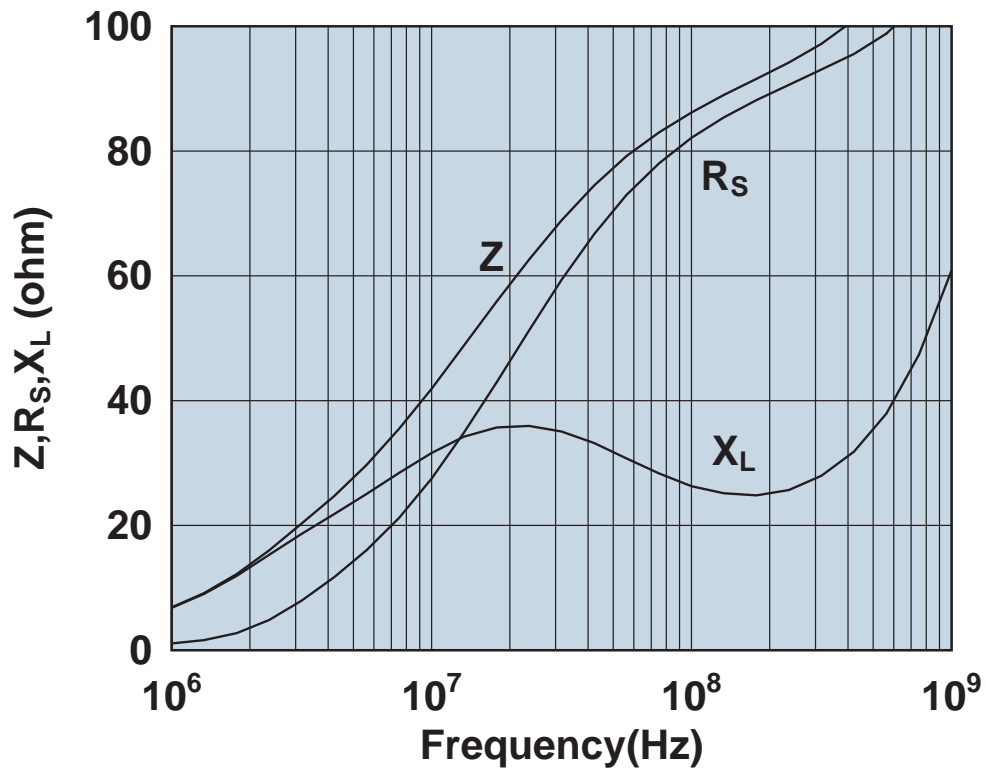

Impedance, reactance, and resistance vs. frequency.

2843002702

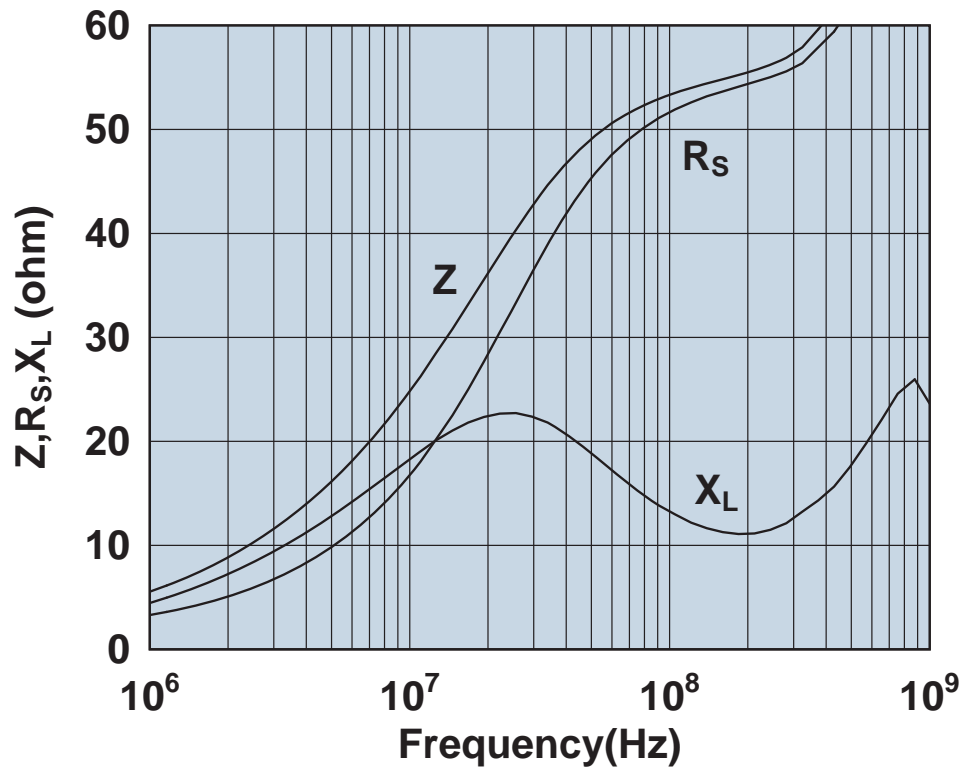

Impedance, reactance, and resistance vs. frequency.

2843006802

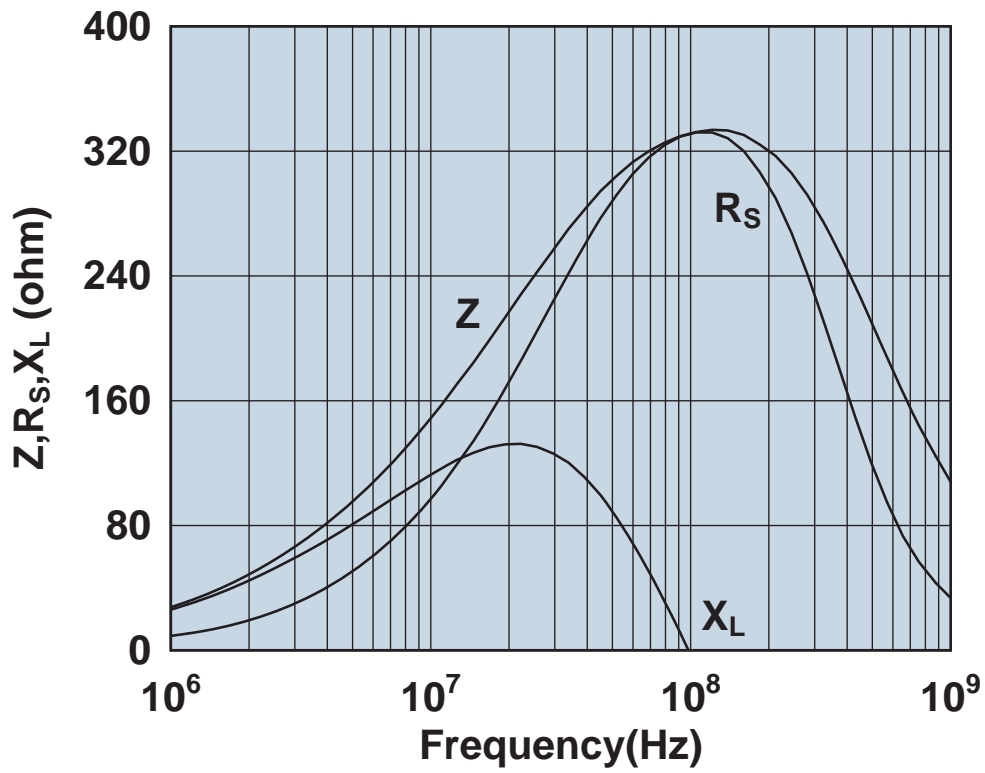

Impedance, reactance, and resistance vs. frequency.

2843009902

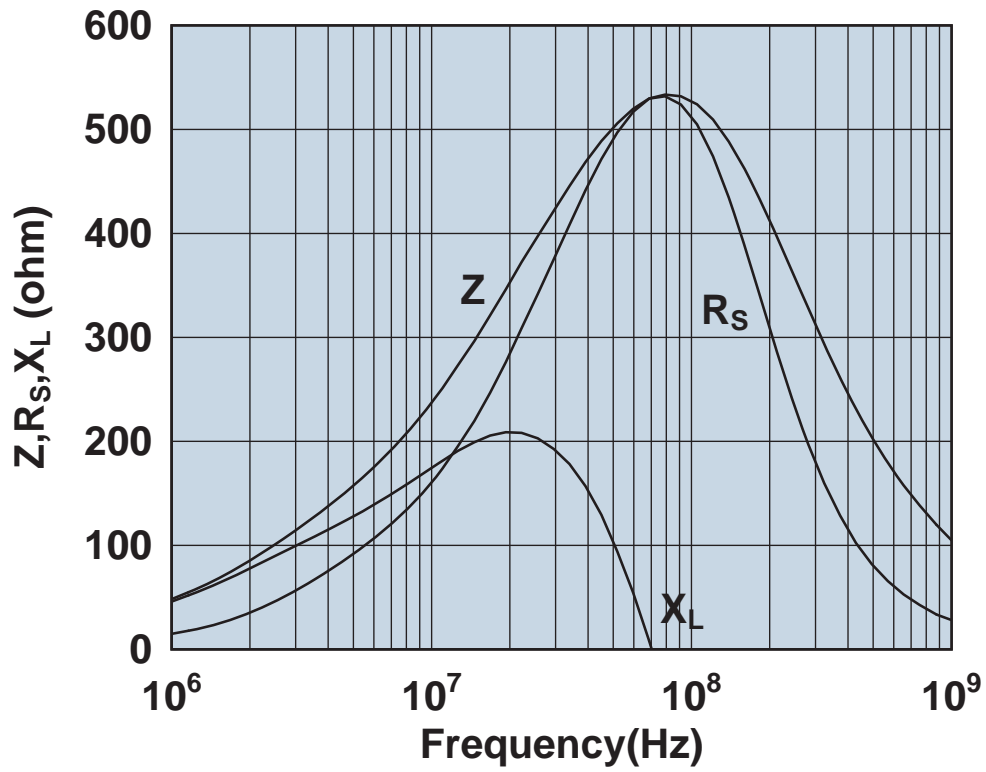

Impedance, reactance, and resistance vs. frequency.

2843010302

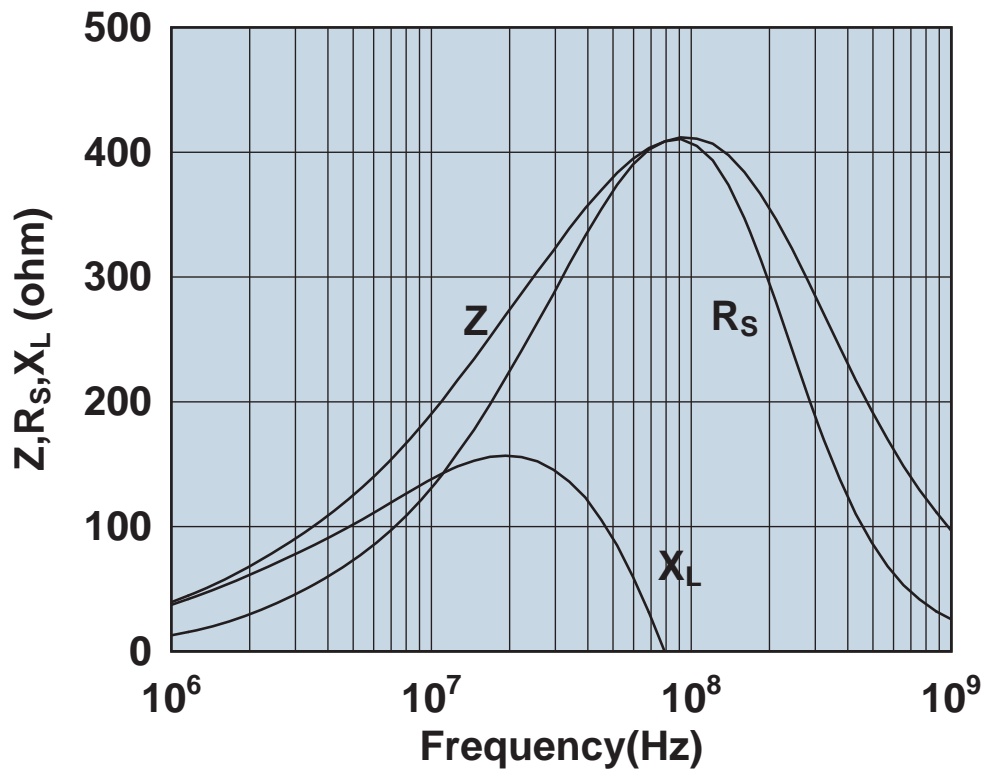

Impedance, reactance, and resistance vs. frequency.

2843010402

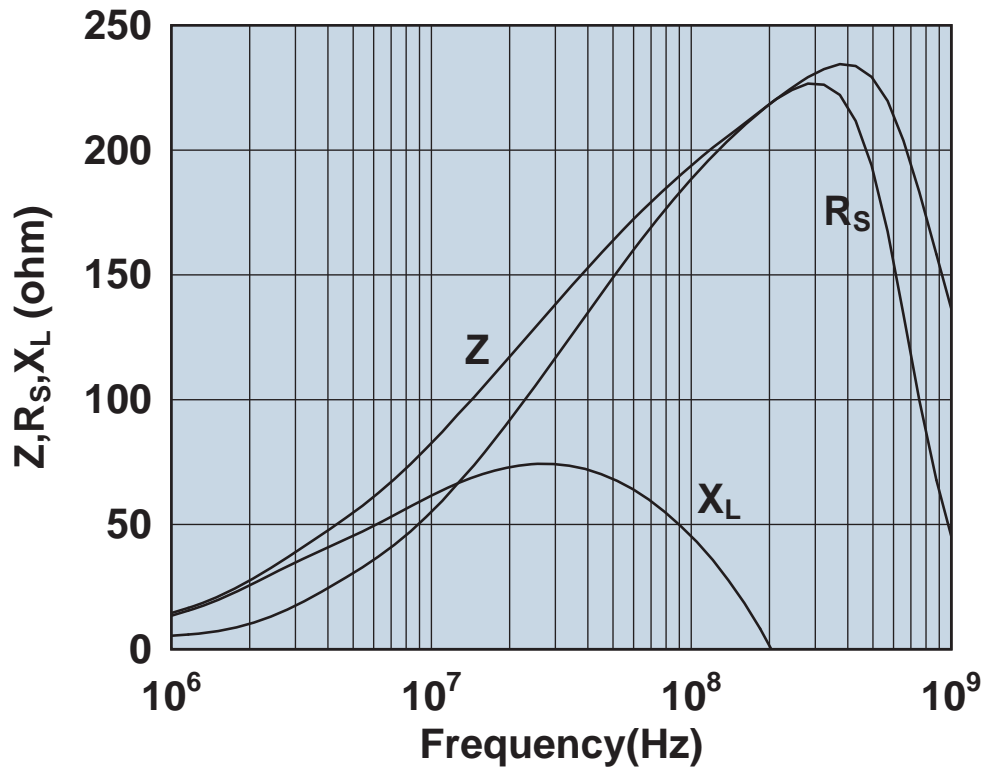

Impedance, reactance, and resistance vs. frequency.

2861000102

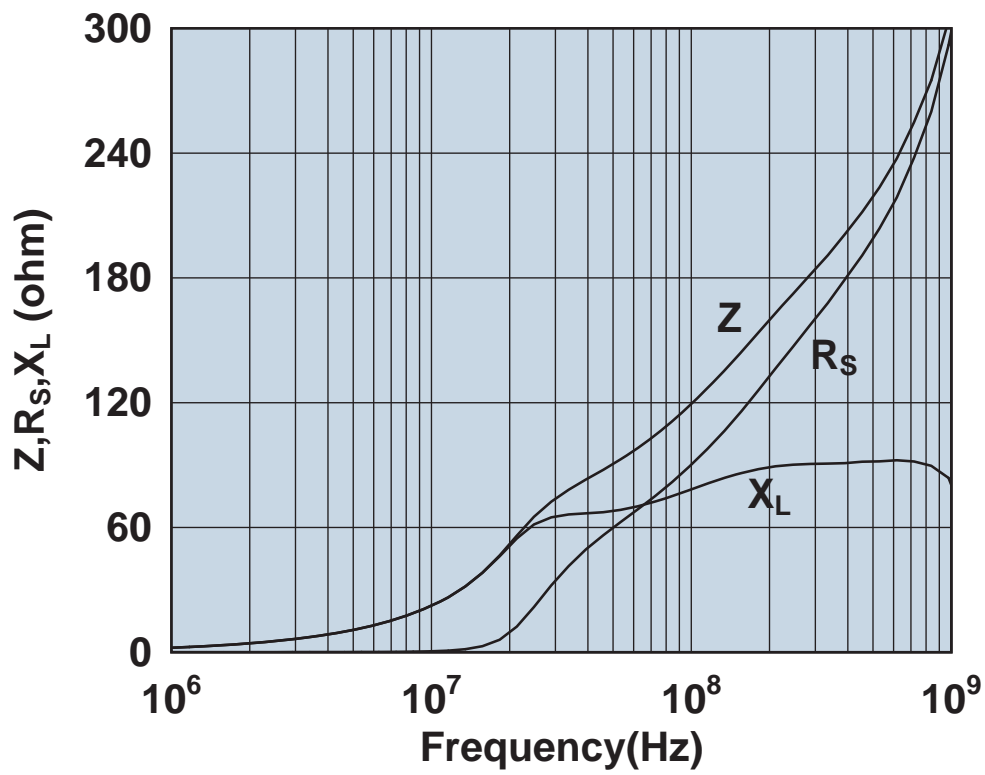

Impedance, reactance, and resistance vs. frequency.

2861000202

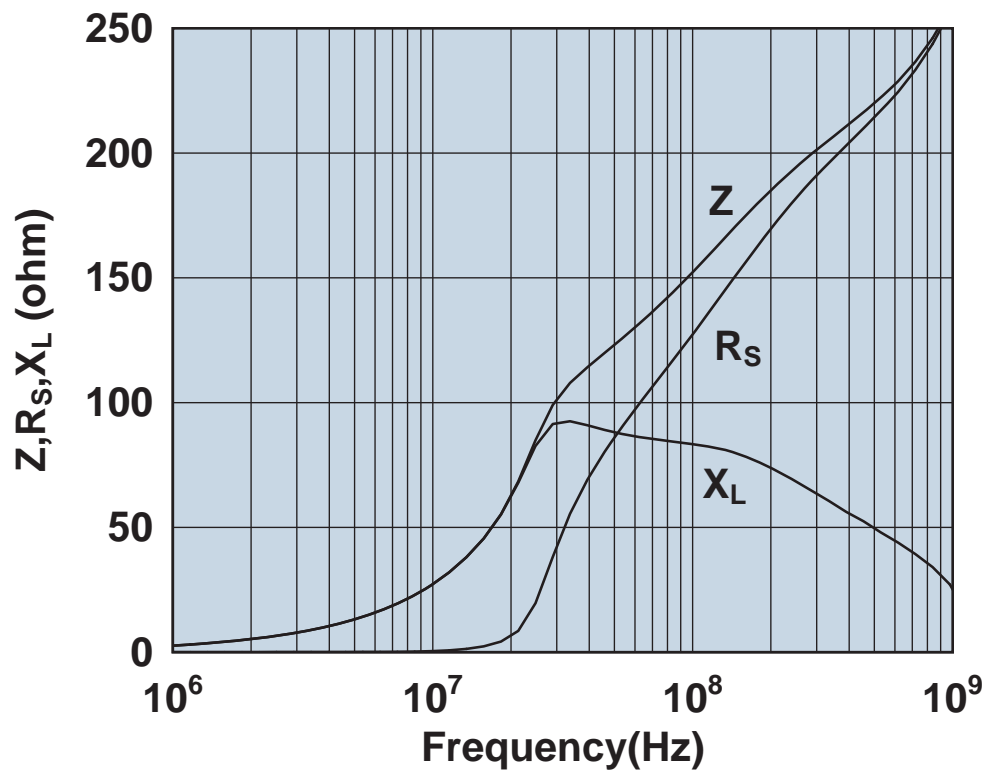

Impedance, reactance, and resistance vs. frequency.

2861000302

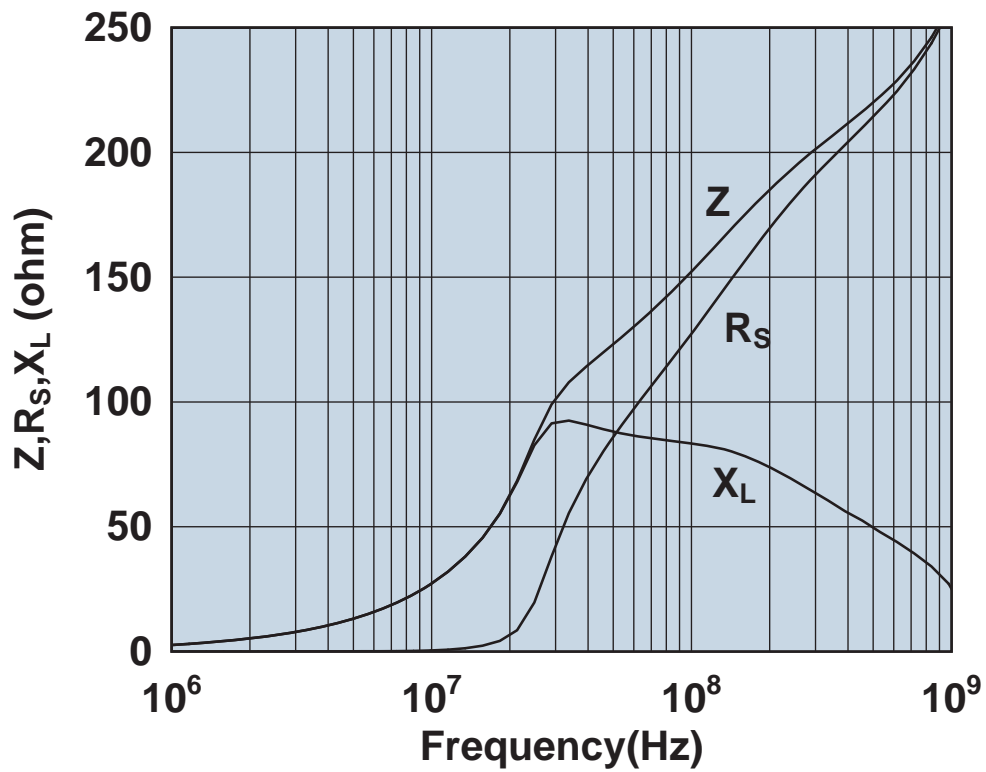

Impedance, reactance, and resistance vs. frequency.

2861001502

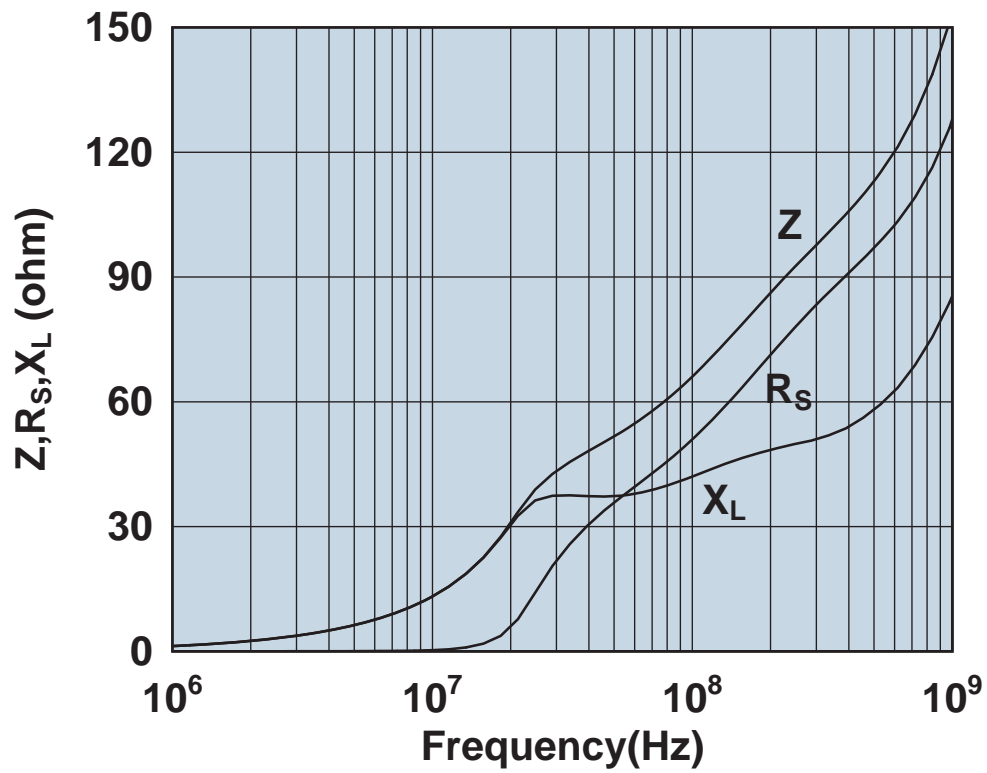

Impedance, reactance, and resistance vs. frequency.

2861001702

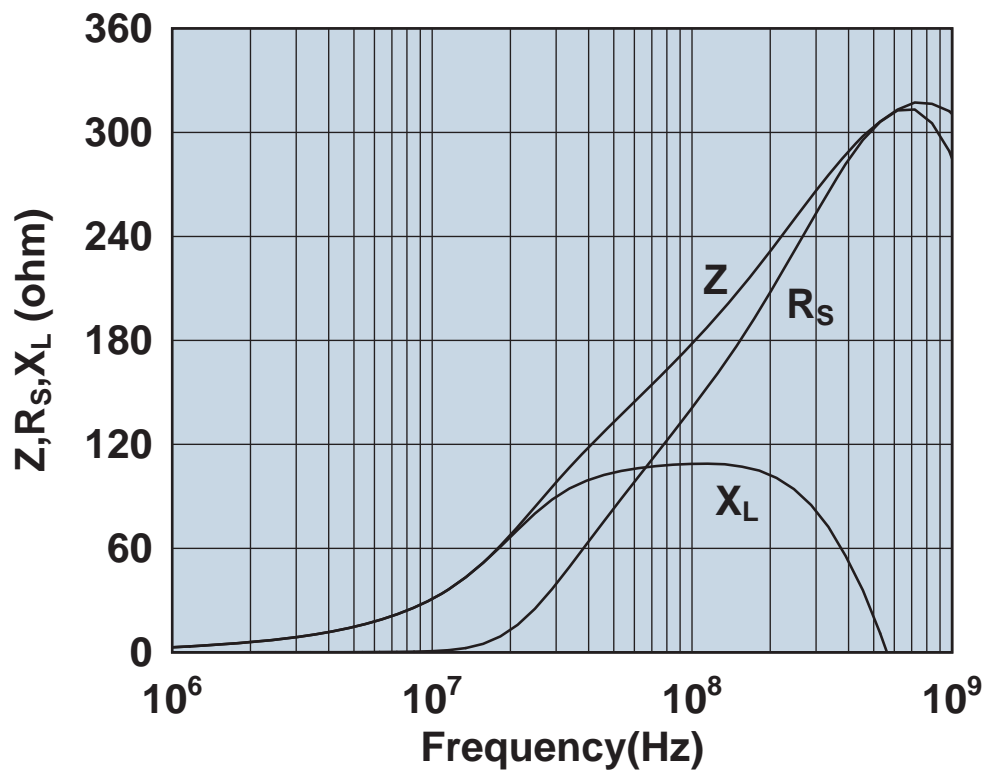

Impedance, reactance, and resistance vs. frequency.

2861001802

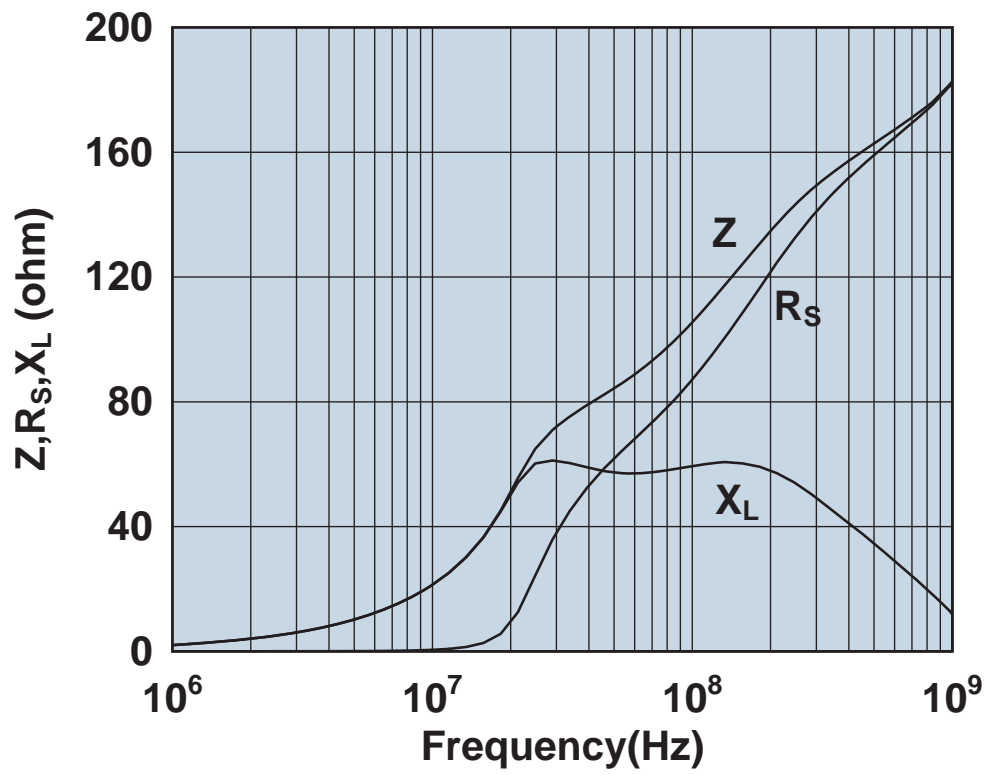

Impedance, reactance, and resistance vs. frequency.

2861002302

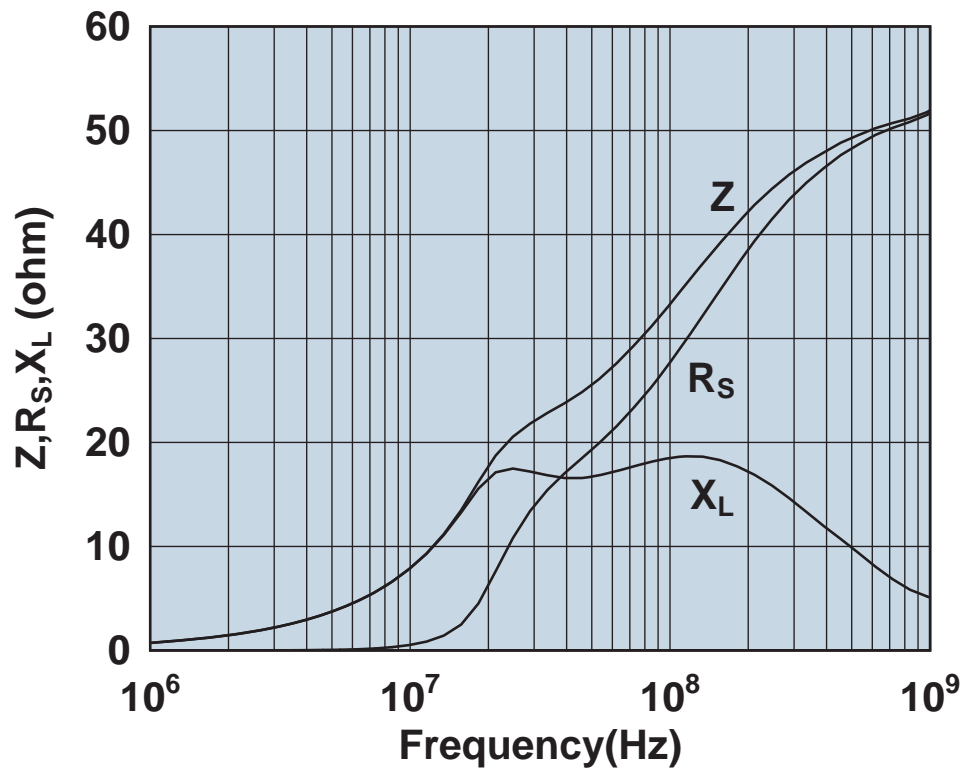

Impedance, reactance, and resistance vs. frequency.

2861002402

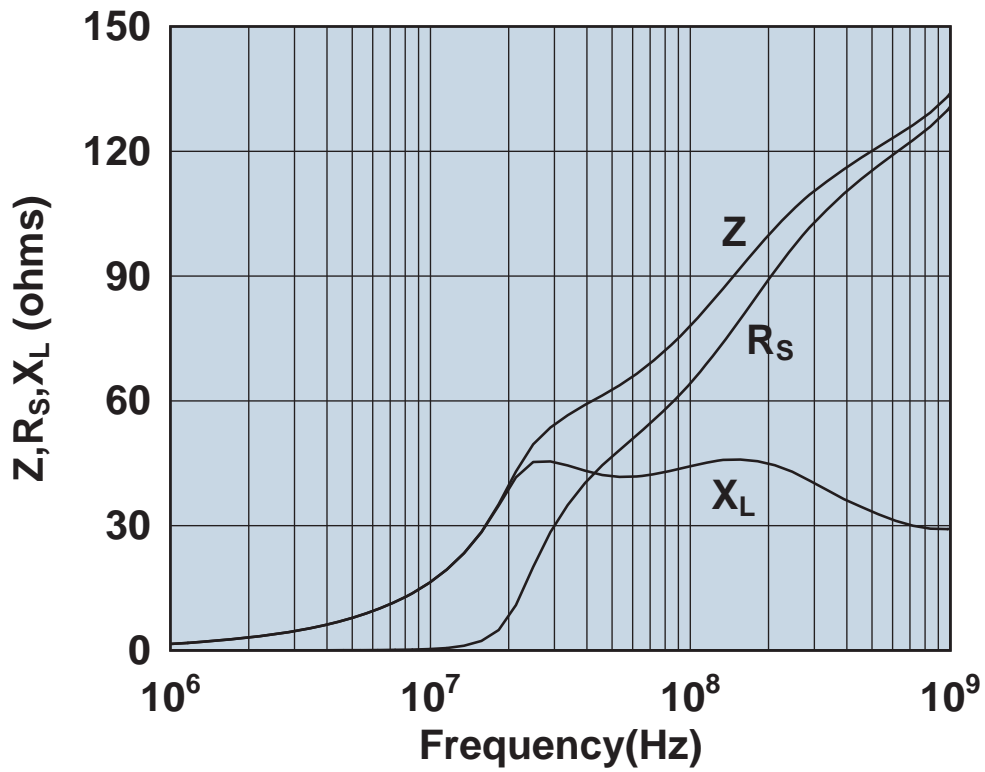

Impedance, reactance, and resistance vs. frequency.

2861002702

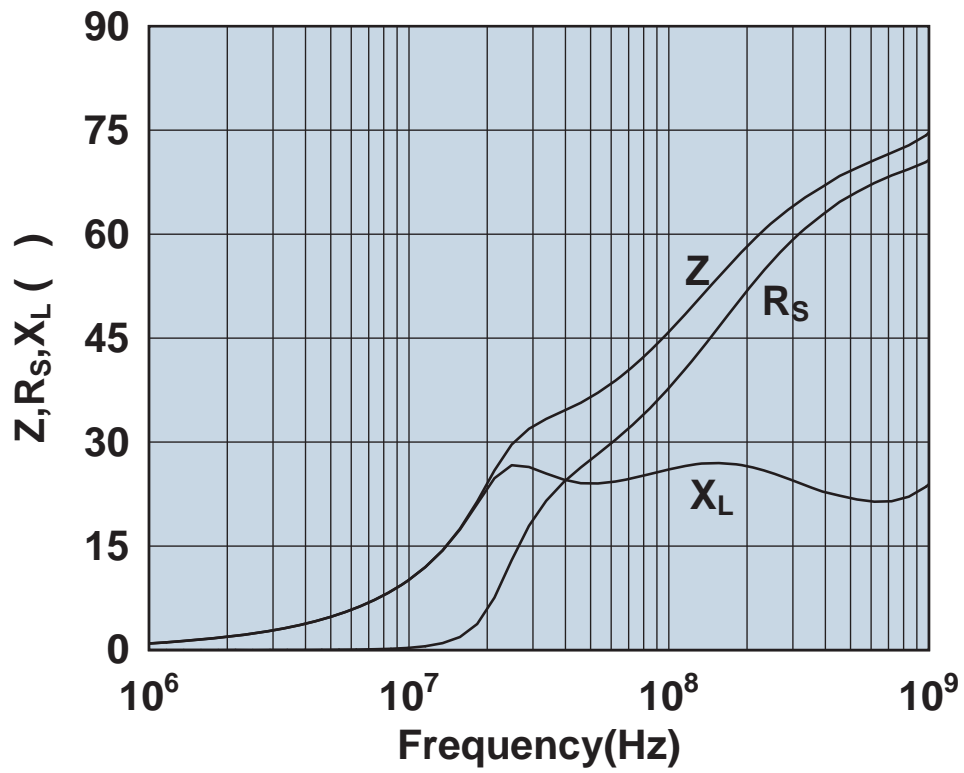

Impedance, reactance, and resistance vs. frequency.

2861006802

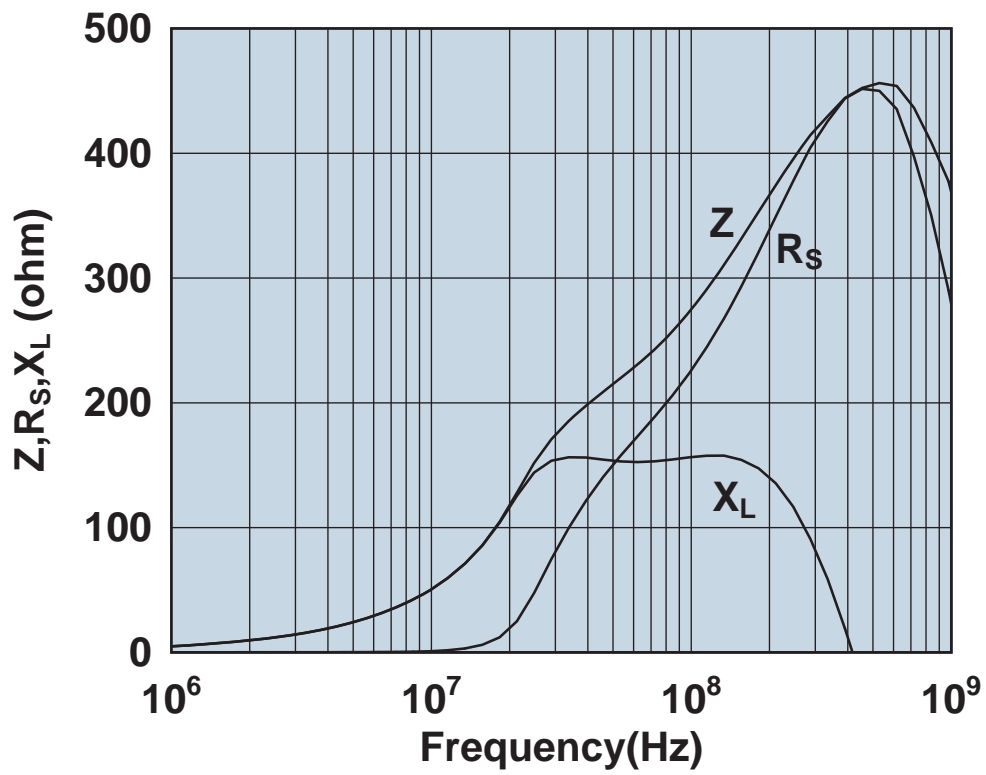

Impedance, reactance, and resistance vs. frequency.

2861010002

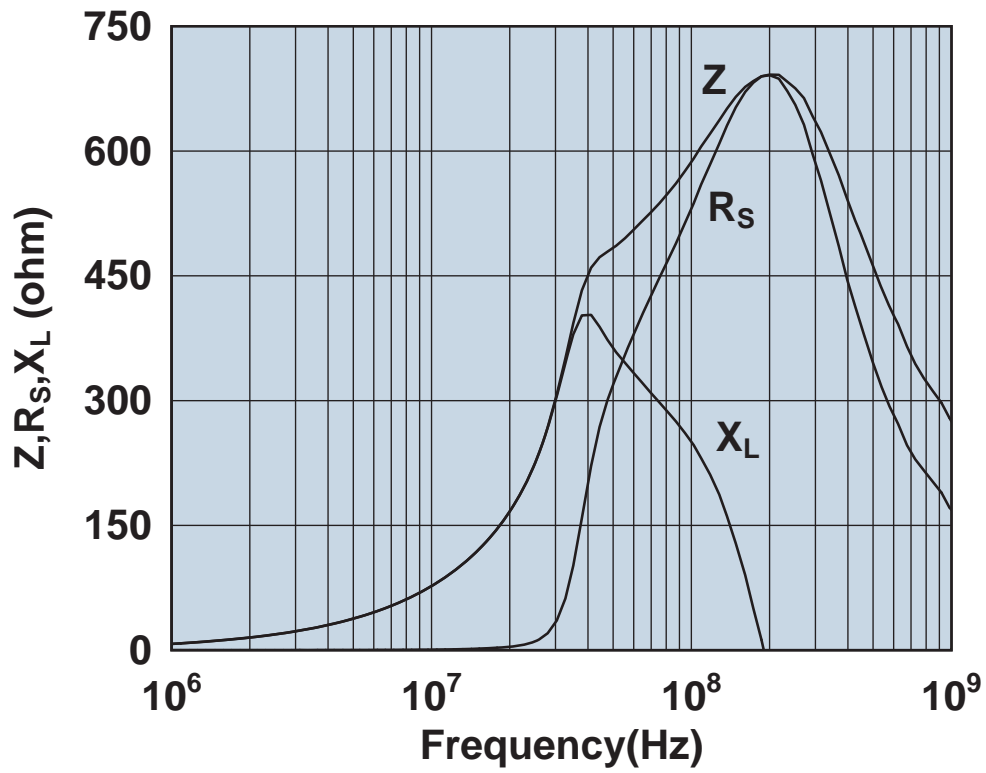

Impedance, reactance, and resistance vs. frequency.

2867000102

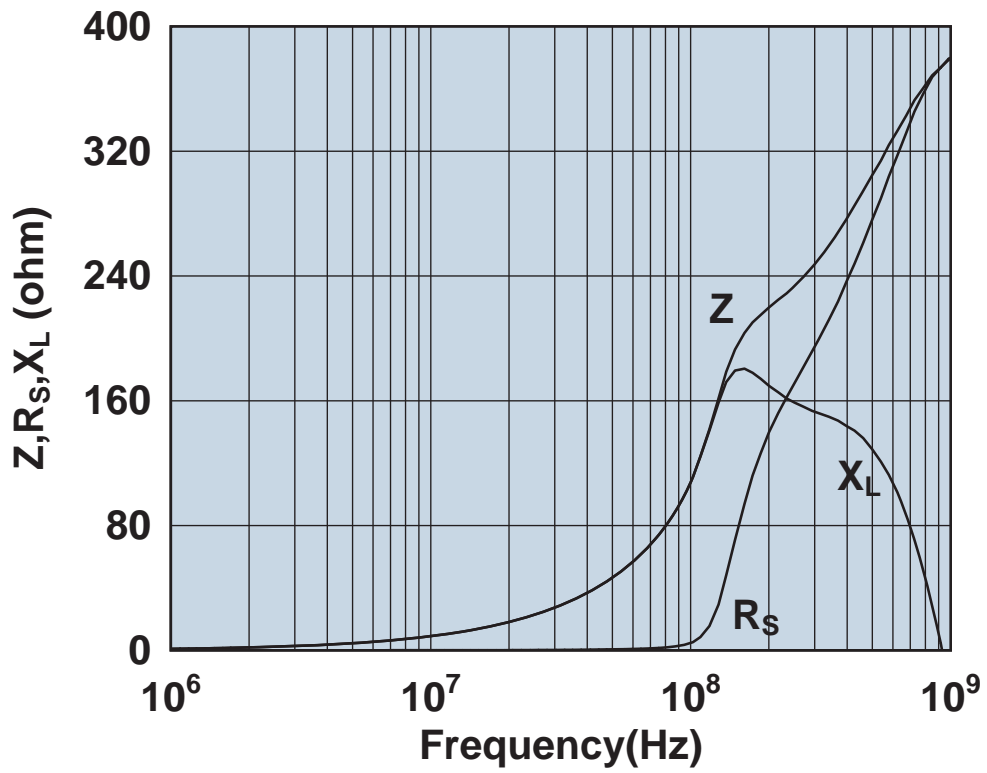

Impedance, reactance, and resistance vs. frequency.

2867000202

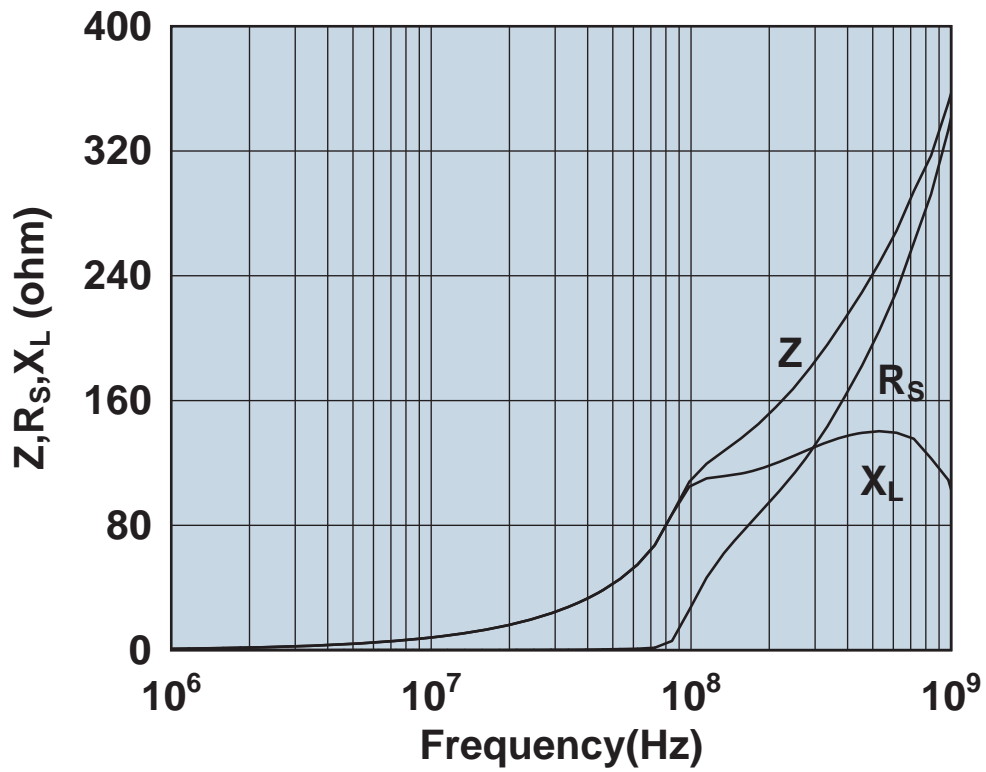

Impedance, reactance, and resistance vs. frequency.

2867000302

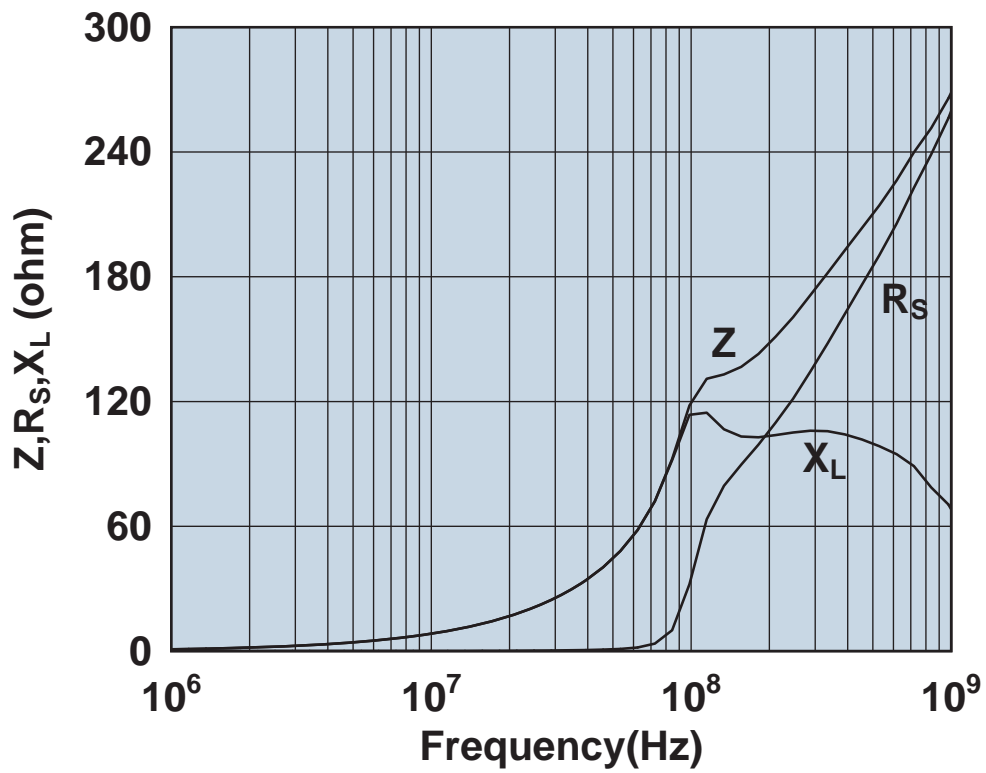

Impedance, reactance, and resistance vs. frequency.

2867001502

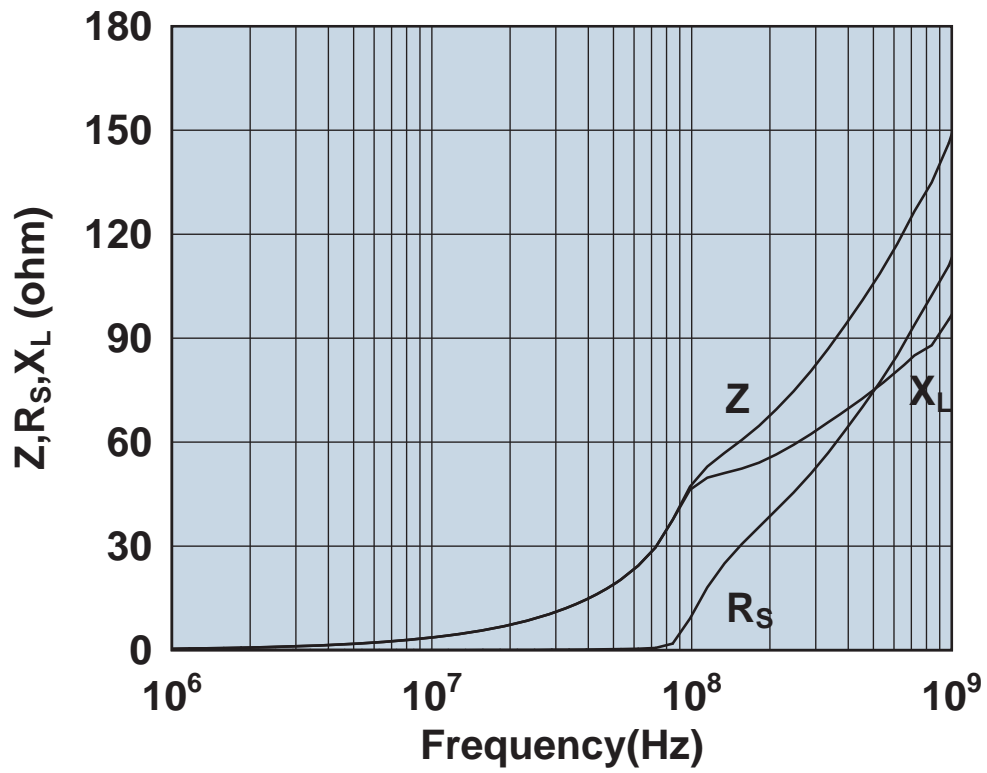

Impedance, reactance, and resistance vs. frequency.

2867001702

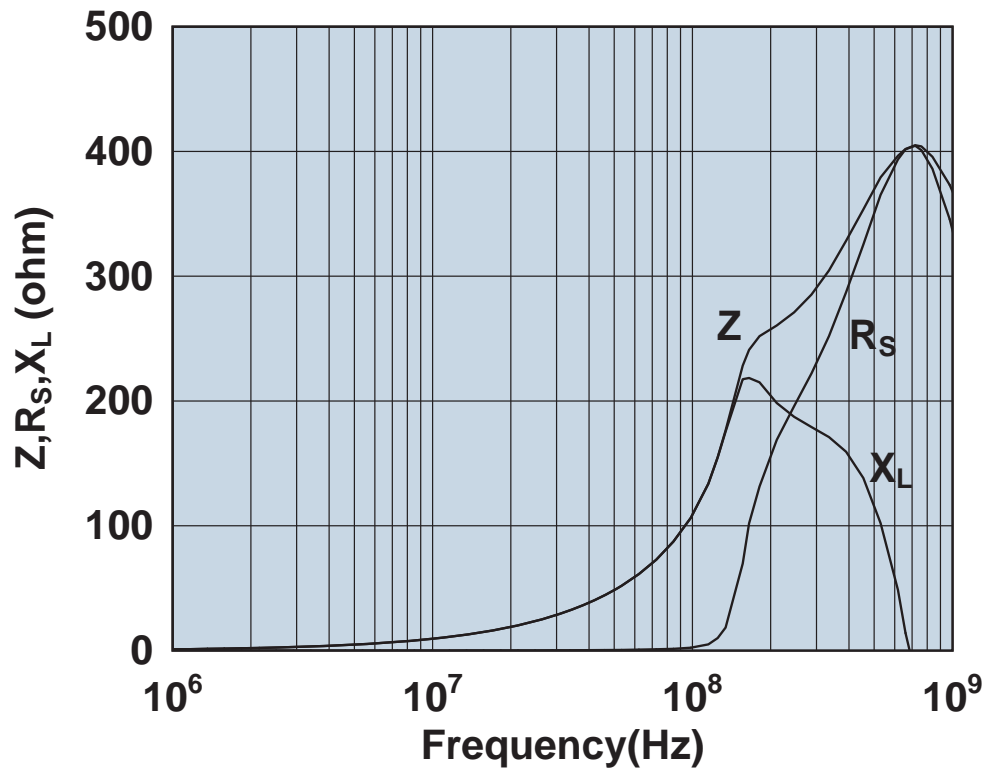

Impedance, reactance, and resistance vs. frequency.

2867001802

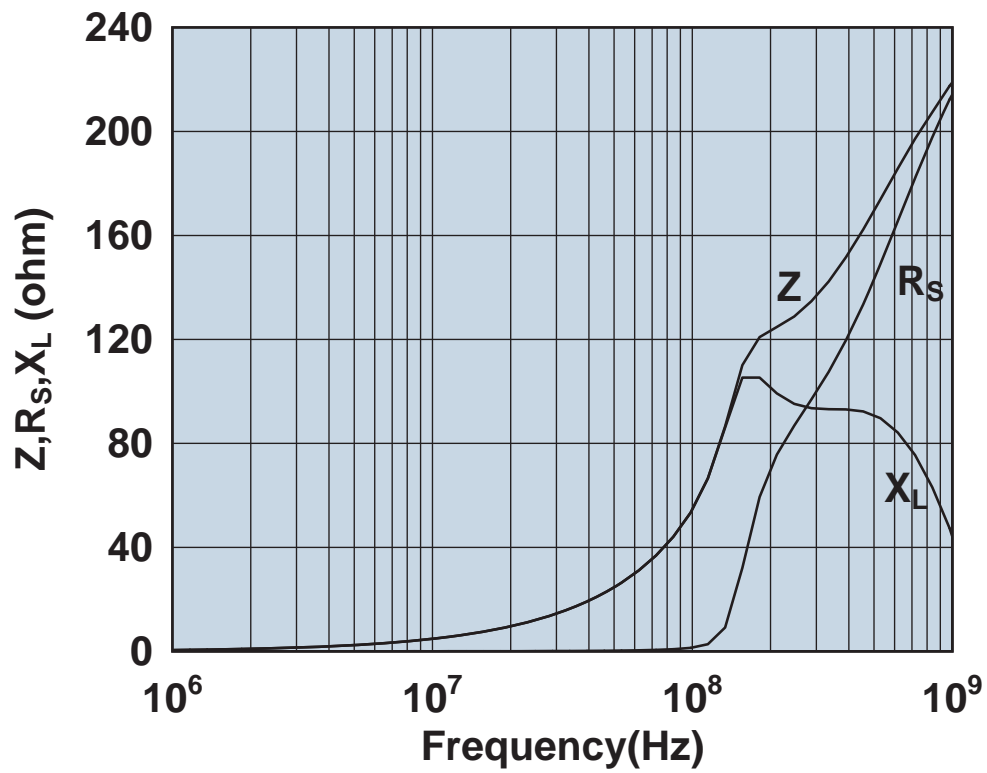

Impedance, reactance, and resistance vs. frequency.

2867002302

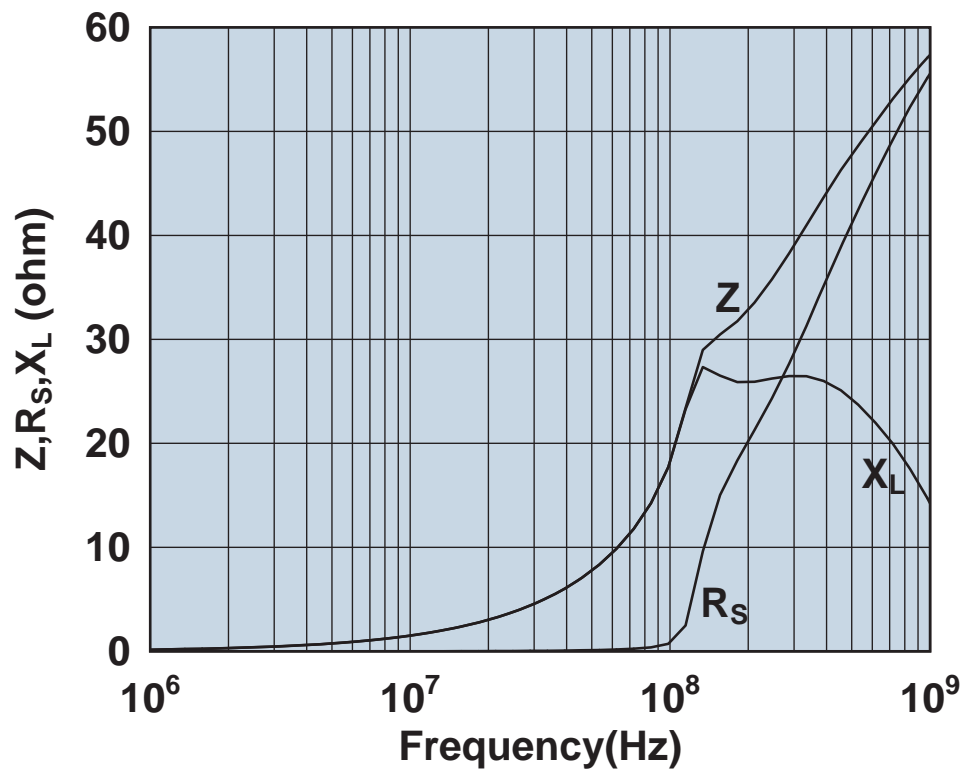

Impedance, reactance, and resistance vs. frequency.

2867002402

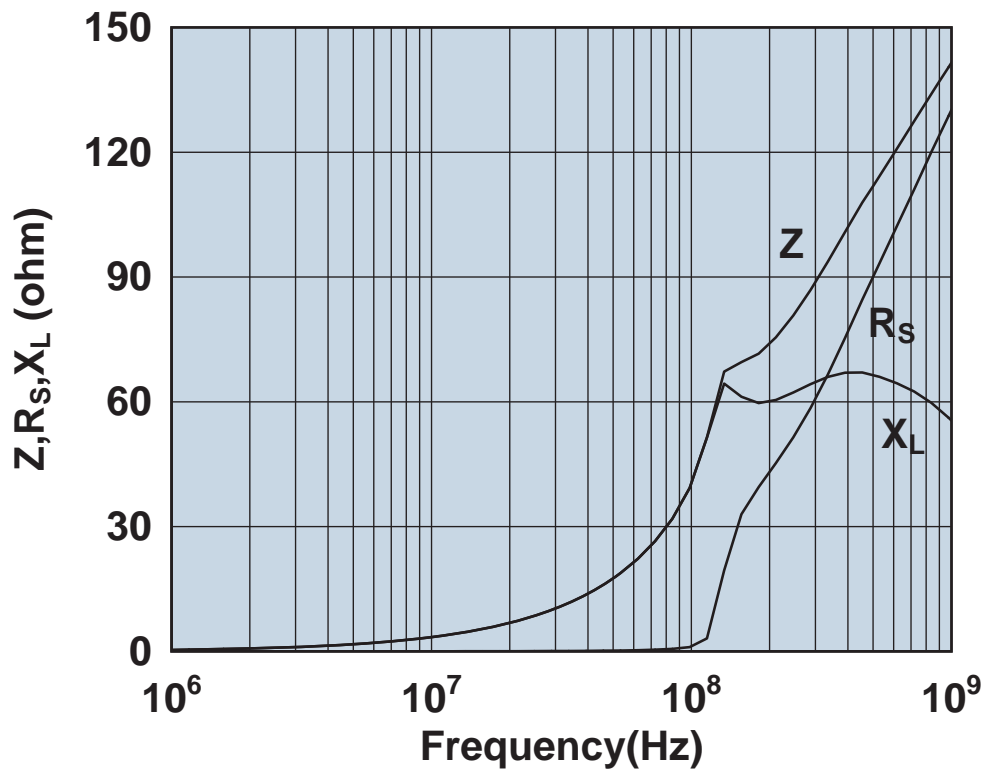

Impedance, reactance, and resistance vs. frequency.

2867002702

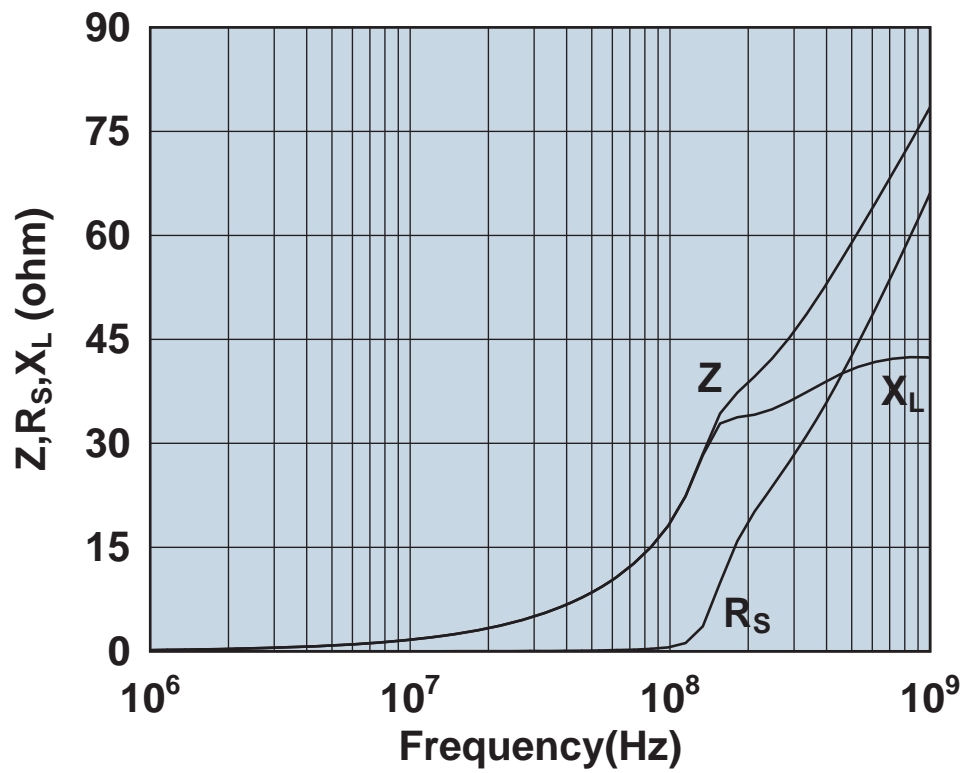

Impedance, reactance, and resistance vs. frequency.

2867006802

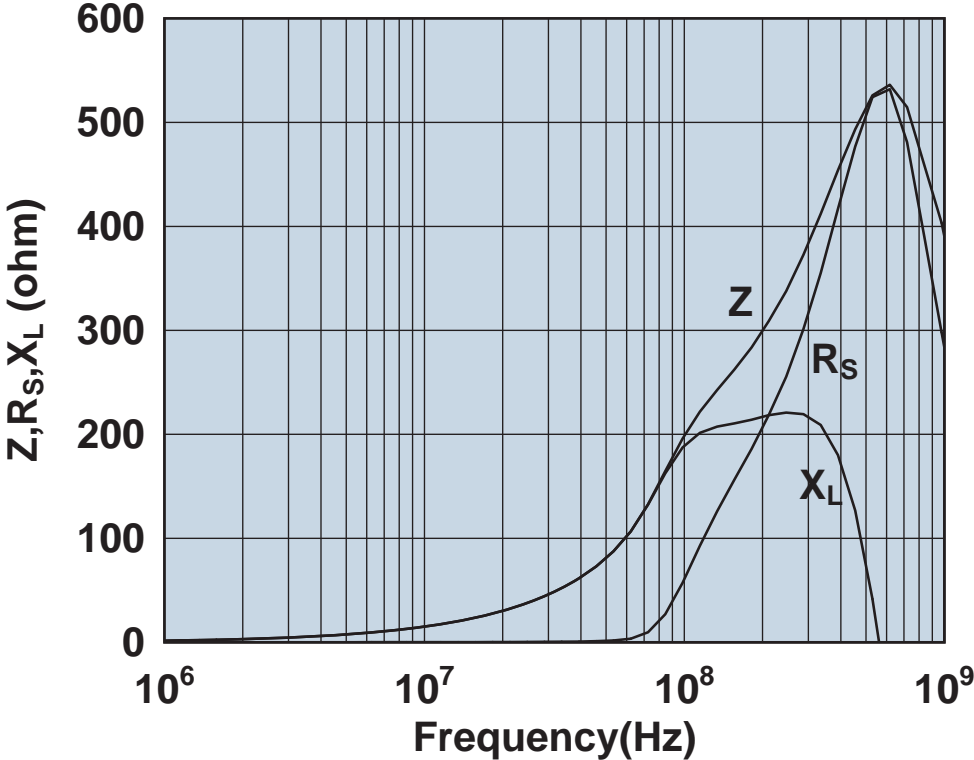

Impedance, reactance, and resistance vs. frequency.

2873000102

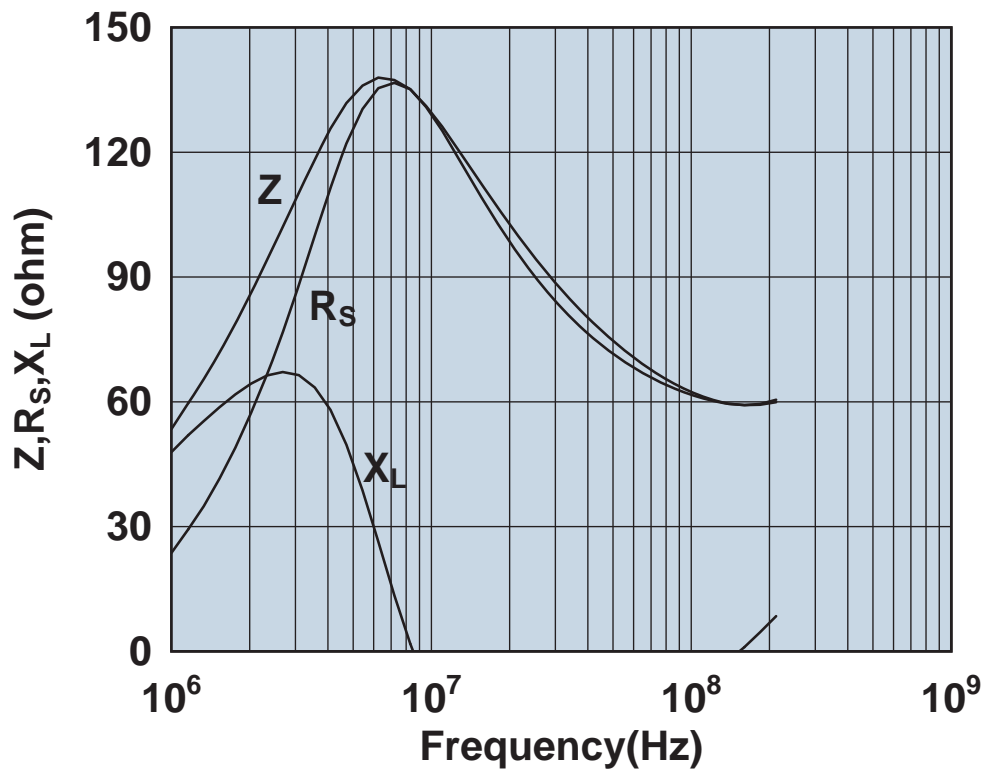

Impedance, reactance, and resistance vs. frequency.

2873000202

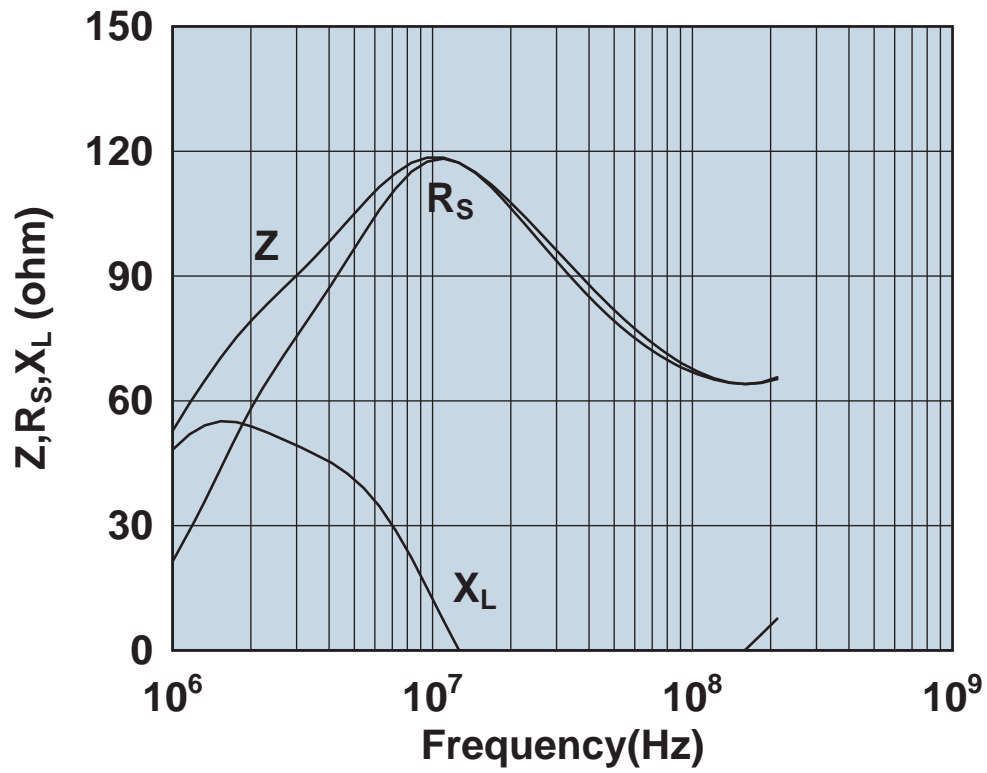

Impedance, reactance, and resistance vs. frequency.

2873000302

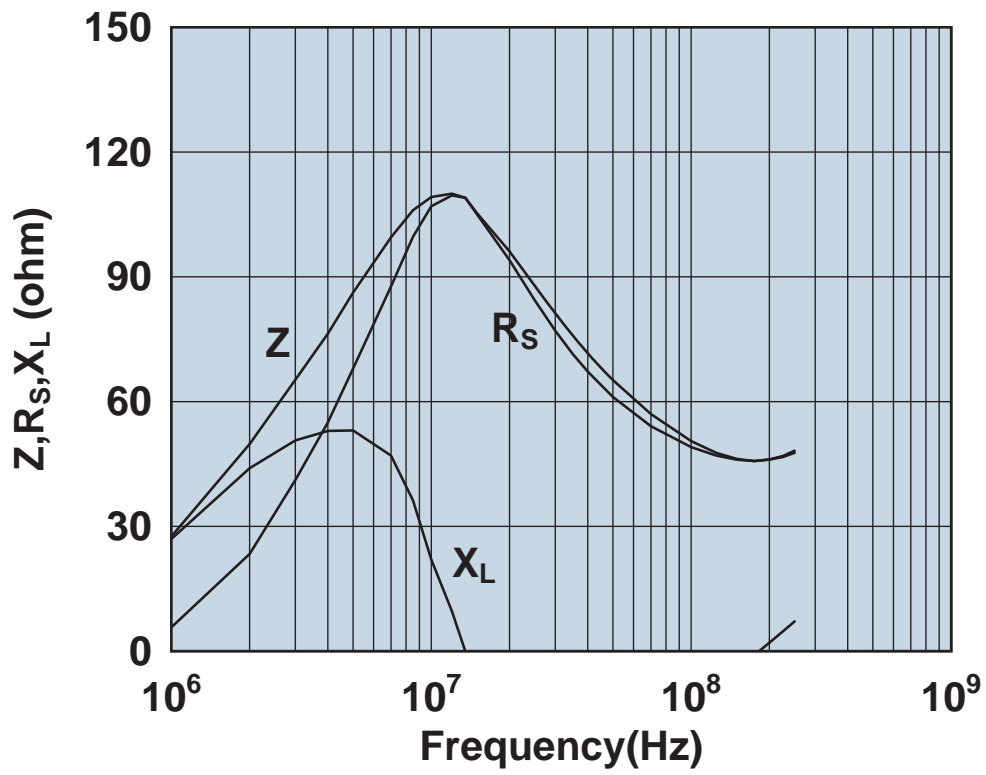

Impedance, reactance, and resistance vs. frequency.

2873001502

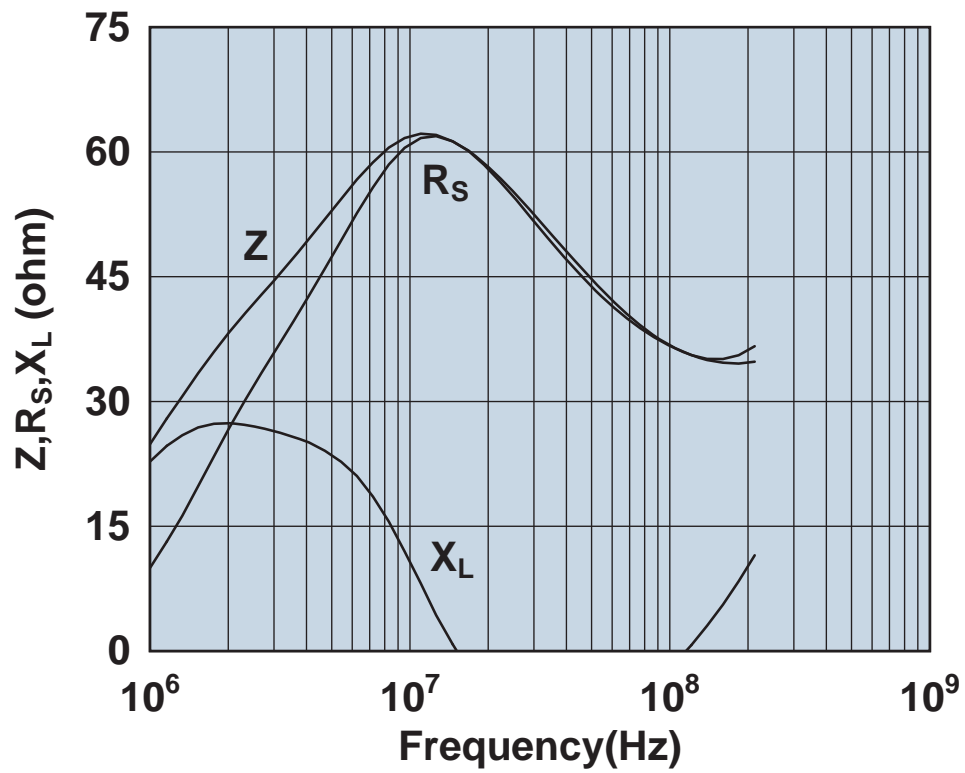

Impedance, reactance, and resistance vs. frequency.

2873001702

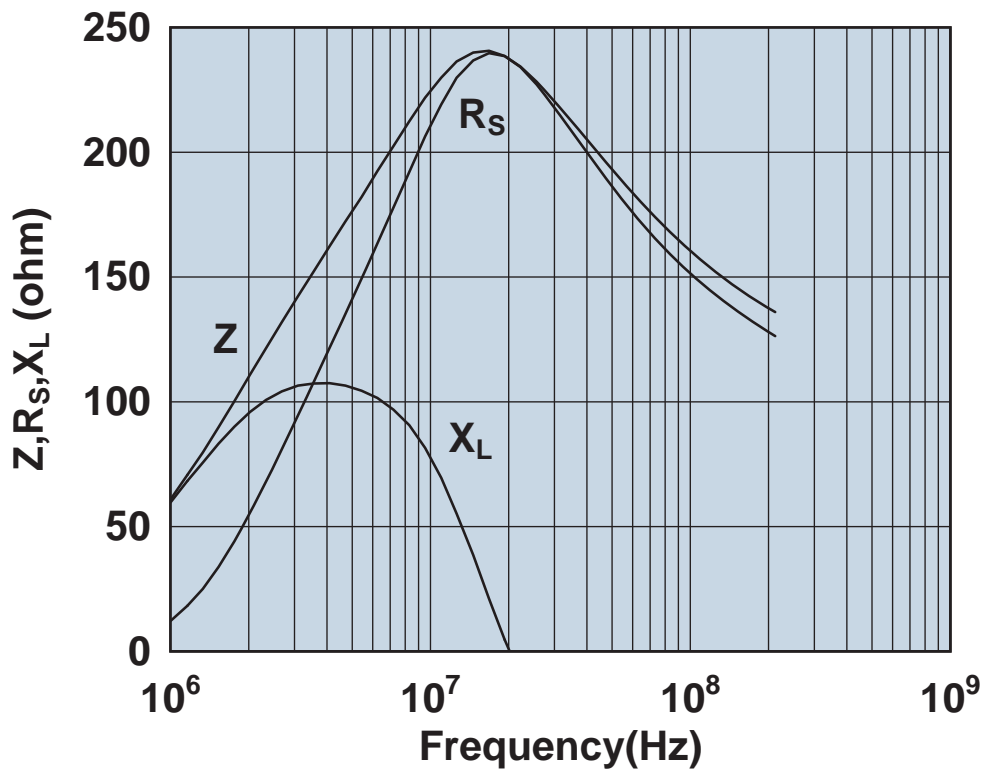

Impedance, reactance, and resistance vs. frequency.

2873001802

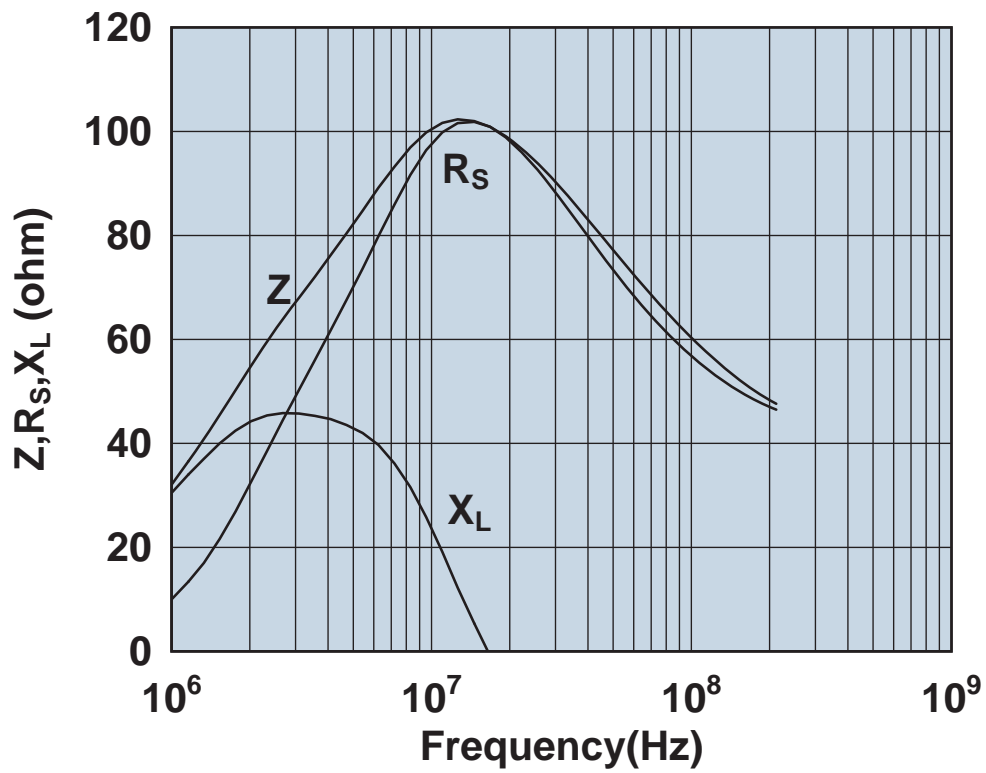

Impedance, reactance, and resistance vs. frequency.

2873002302

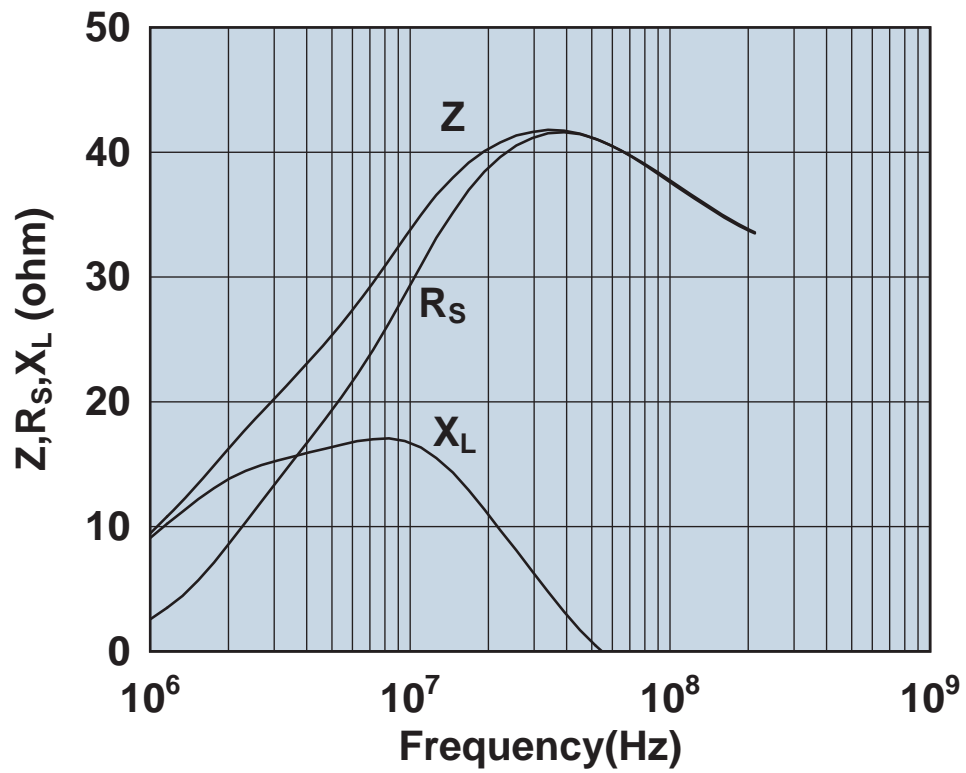

Impedance, reactance, and resistance vs. frequency.

2873002402

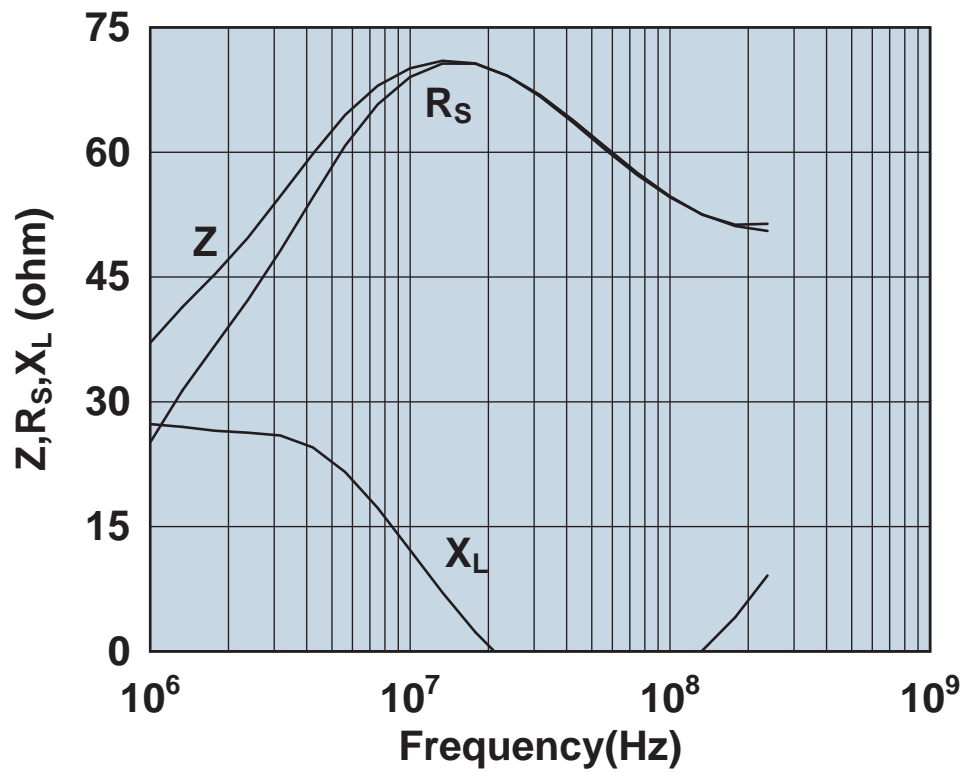

Impedance, reactance, and resistance vs. frequency.

2873002702

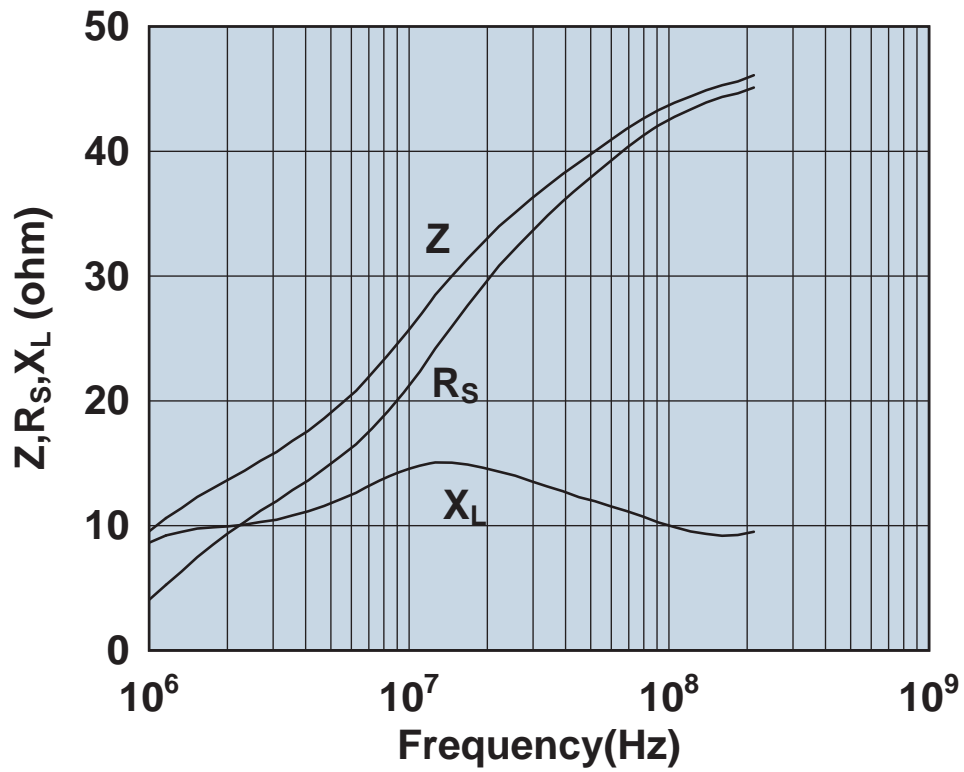

Impedance, reactance, and resistance vs. frequency.

2873006802

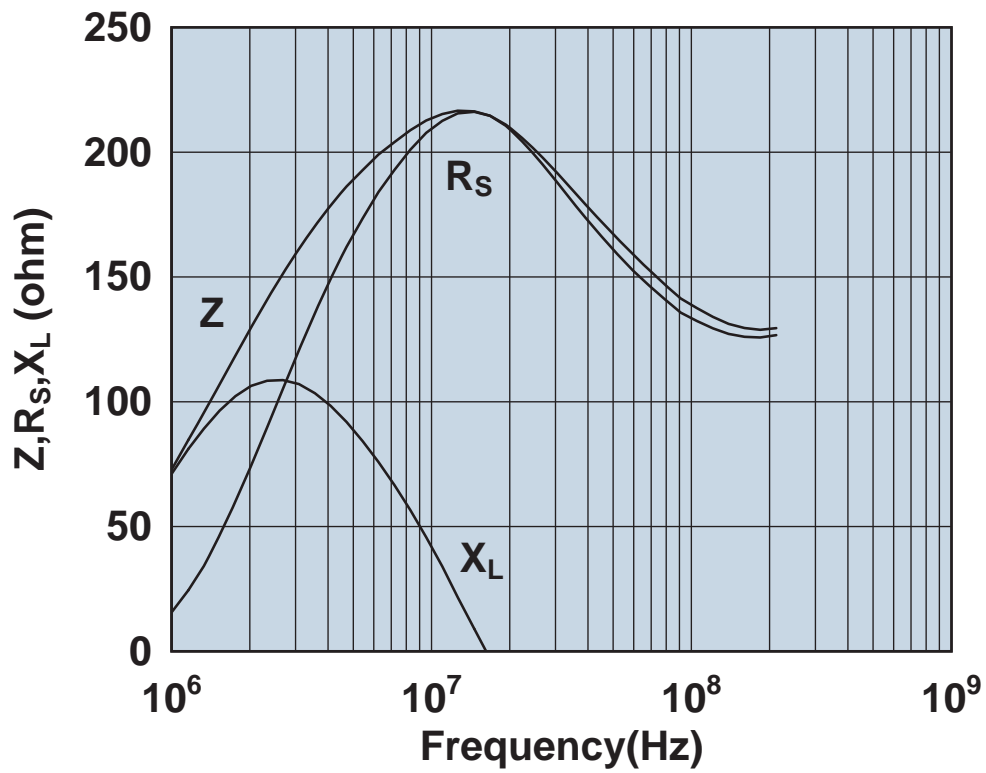

Impedance, reactance, and resistance vs. frequency.

2944666631

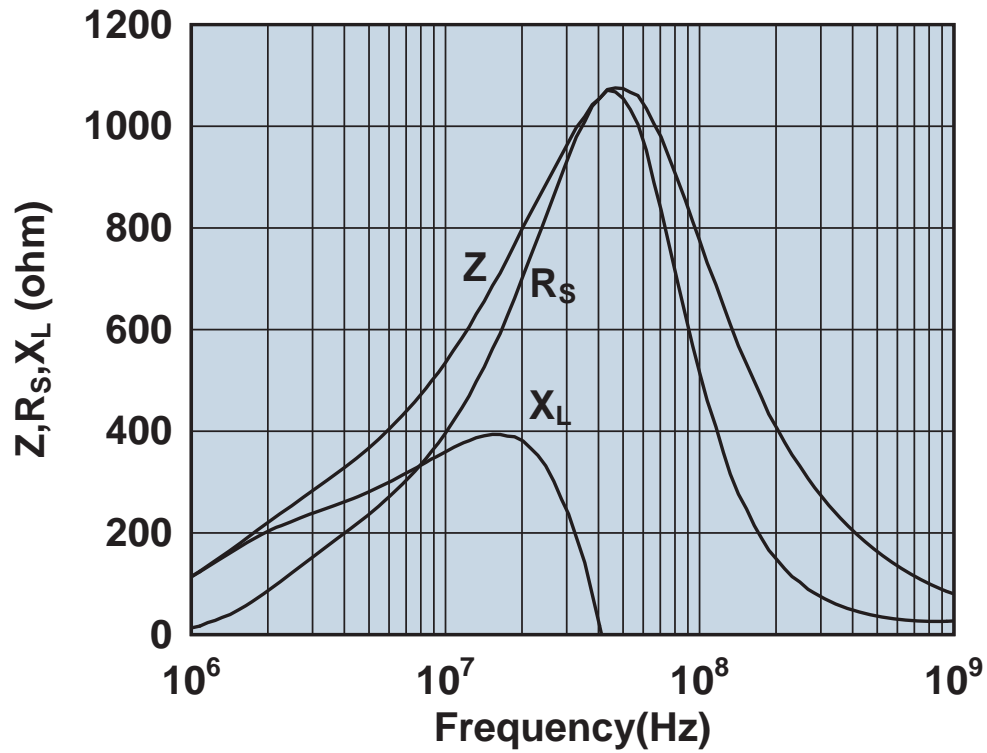

Impedance, reactance, and resistance vs. frequency.

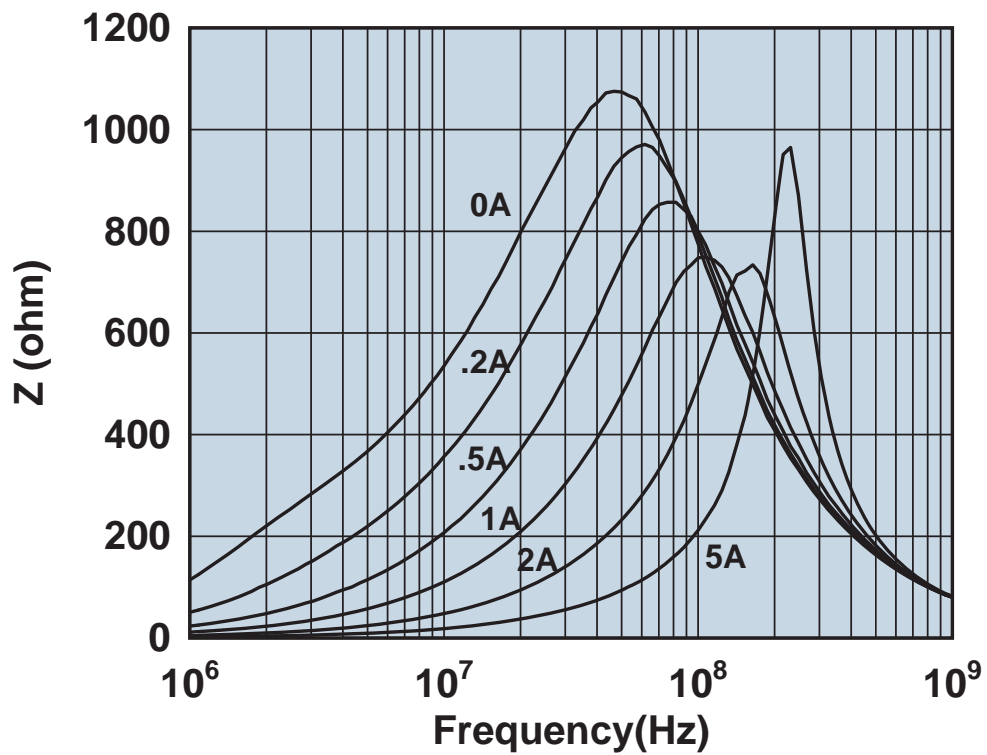

Impedance vs. frequency with dc bias.

2944666651

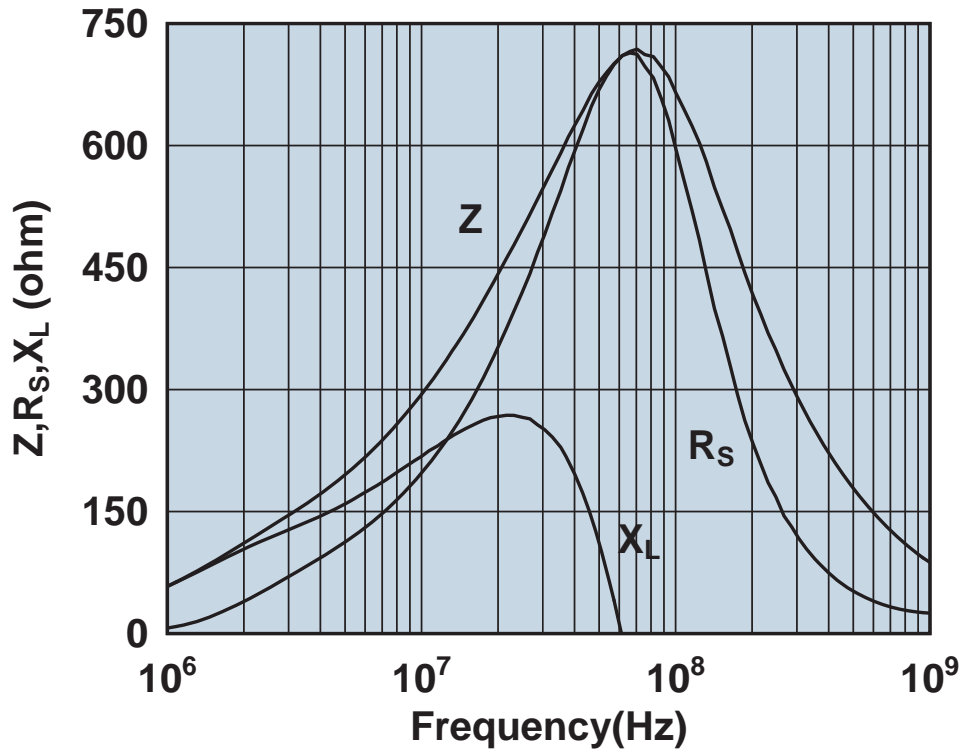

Impedance, reactance, and resistance vs. frequency.

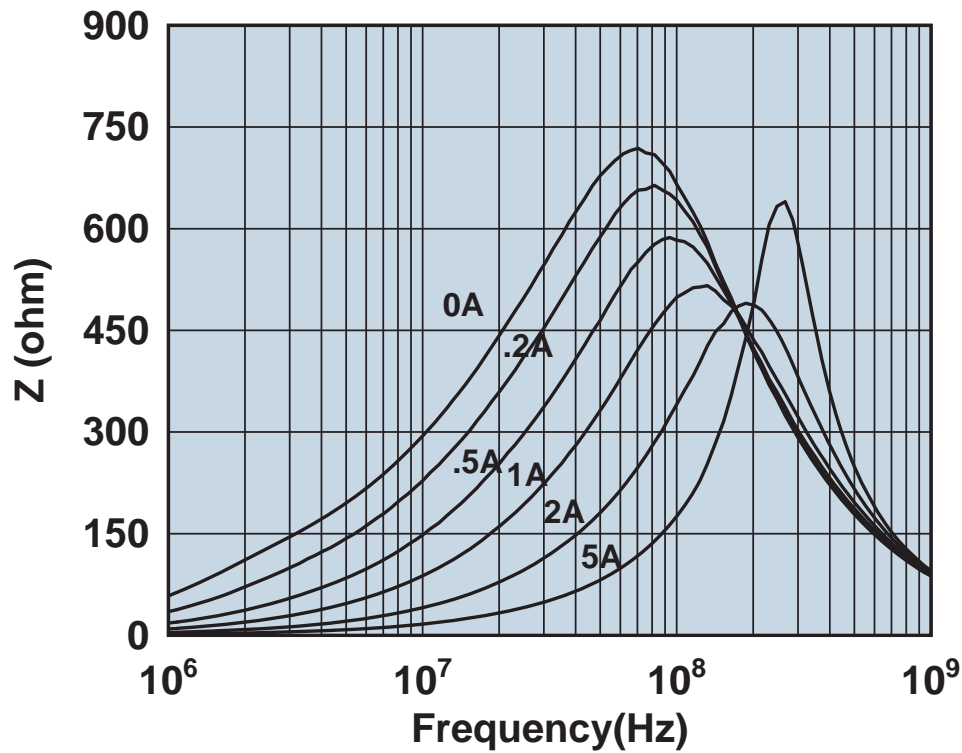

Impedance vs. frequency with dc bias.

2944666661

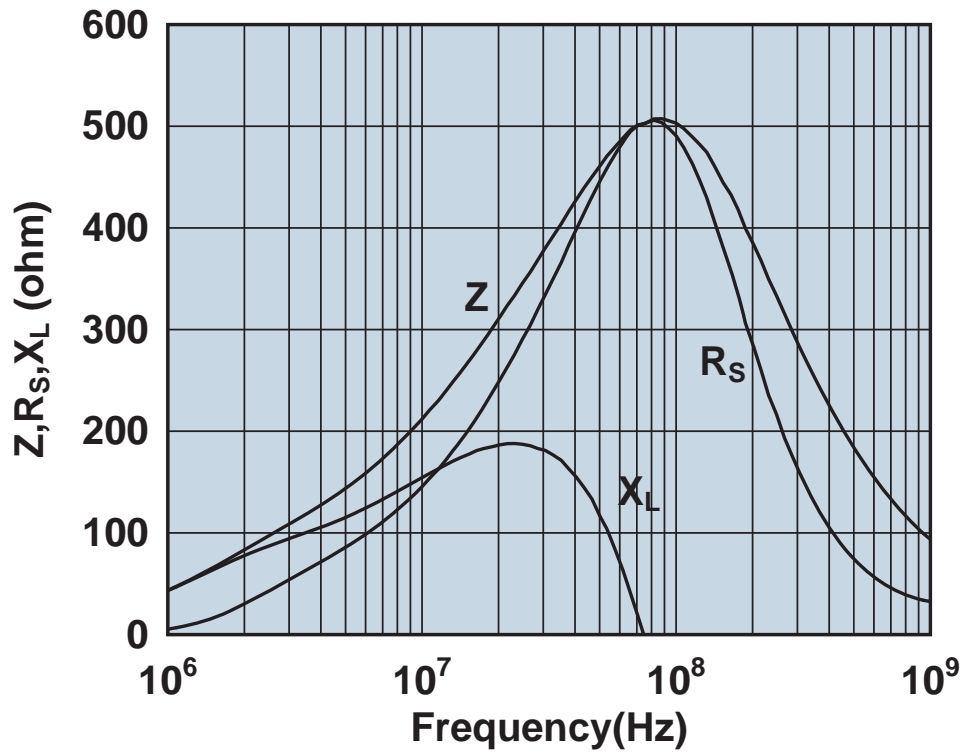

Impedance, reactance, and resistance vs. frequency.

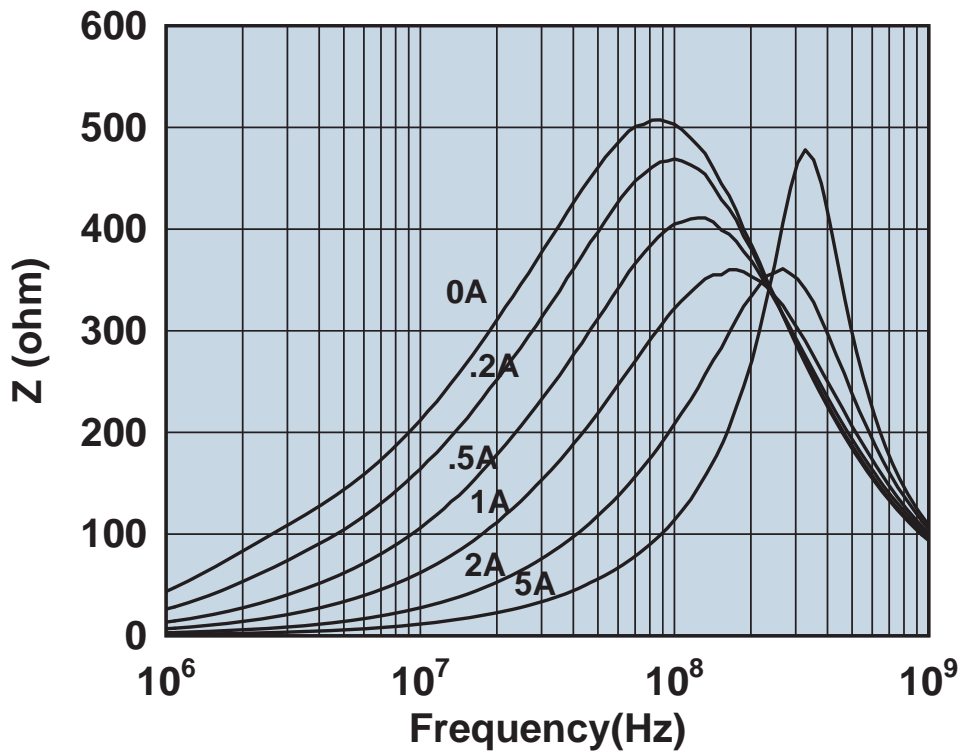

Impedance vs. frequency with dc bias.

2944666671

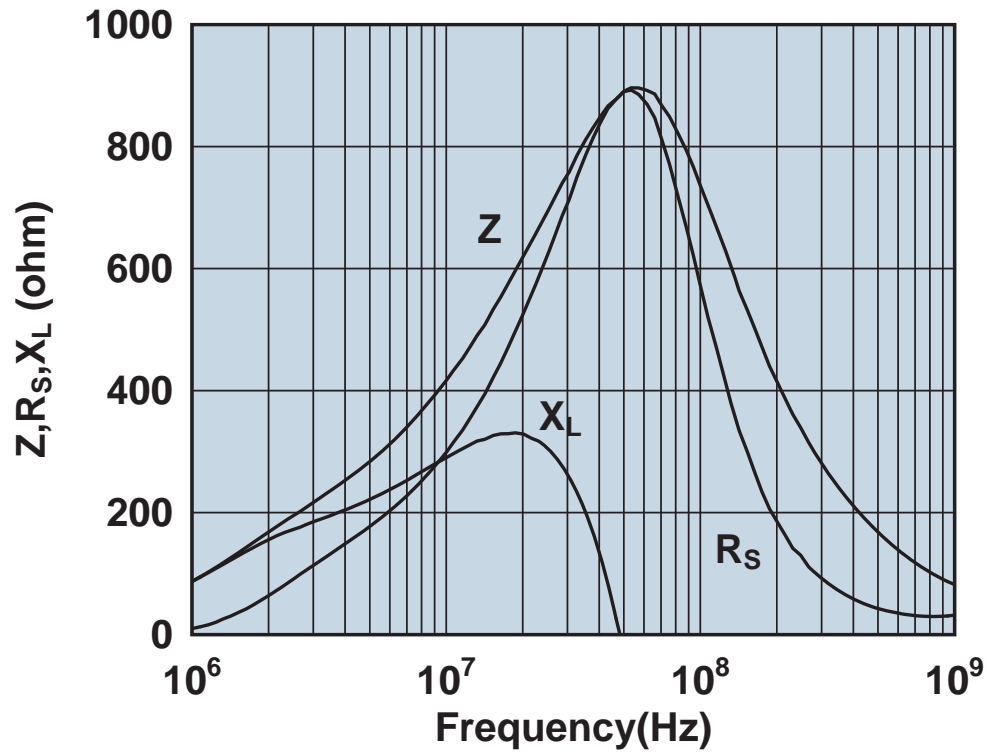

Impedance, reactance, and resistance vs. frequency.

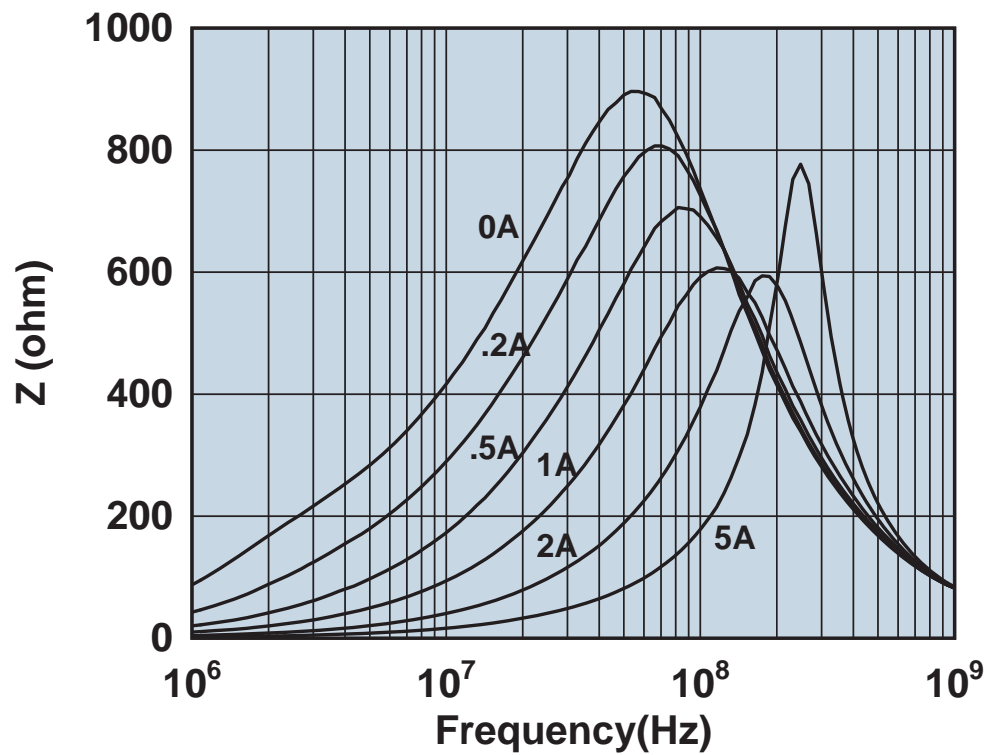

Impedance vs. frequency with dc bias.

294466681

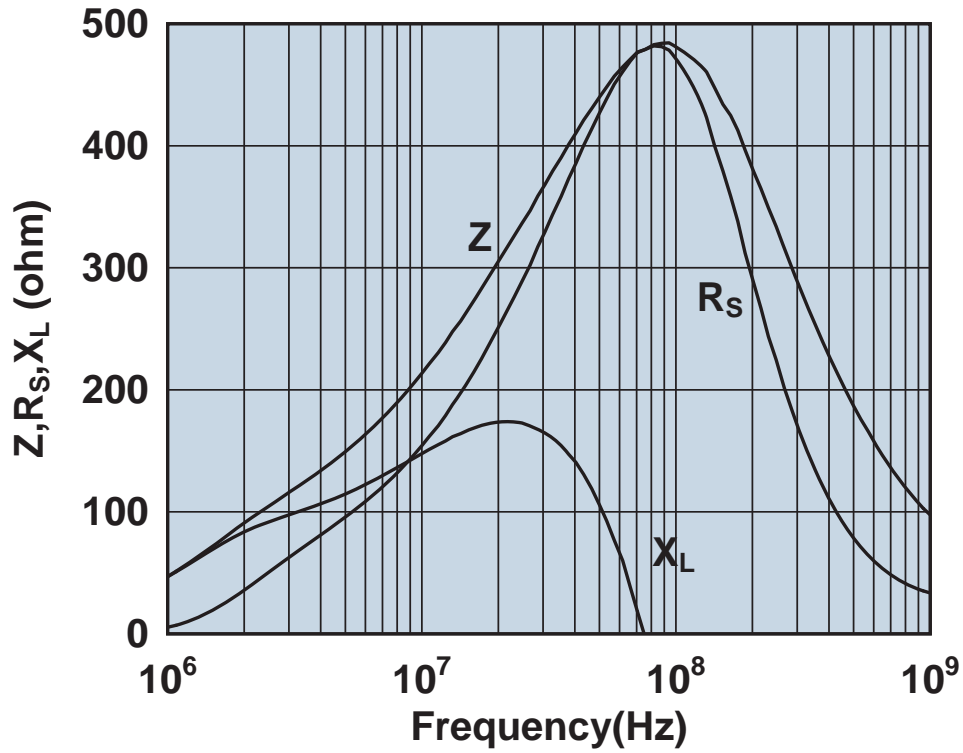

Impedance, reactance, and resistance vs. frequency.

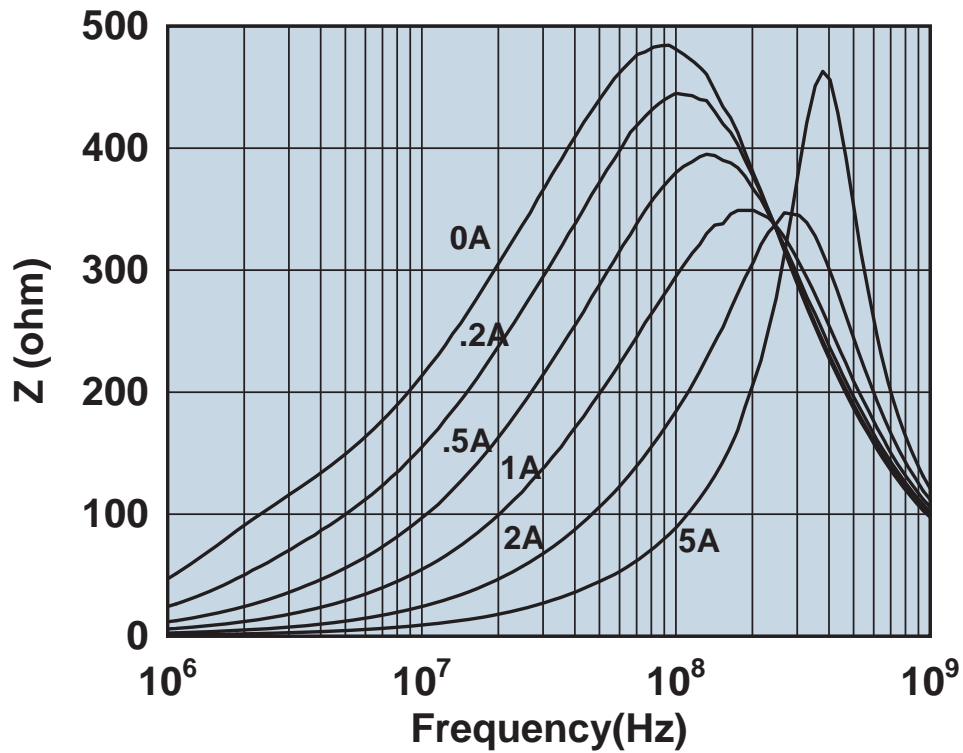

Impedance vs. frequency with dc bias.

2944770301

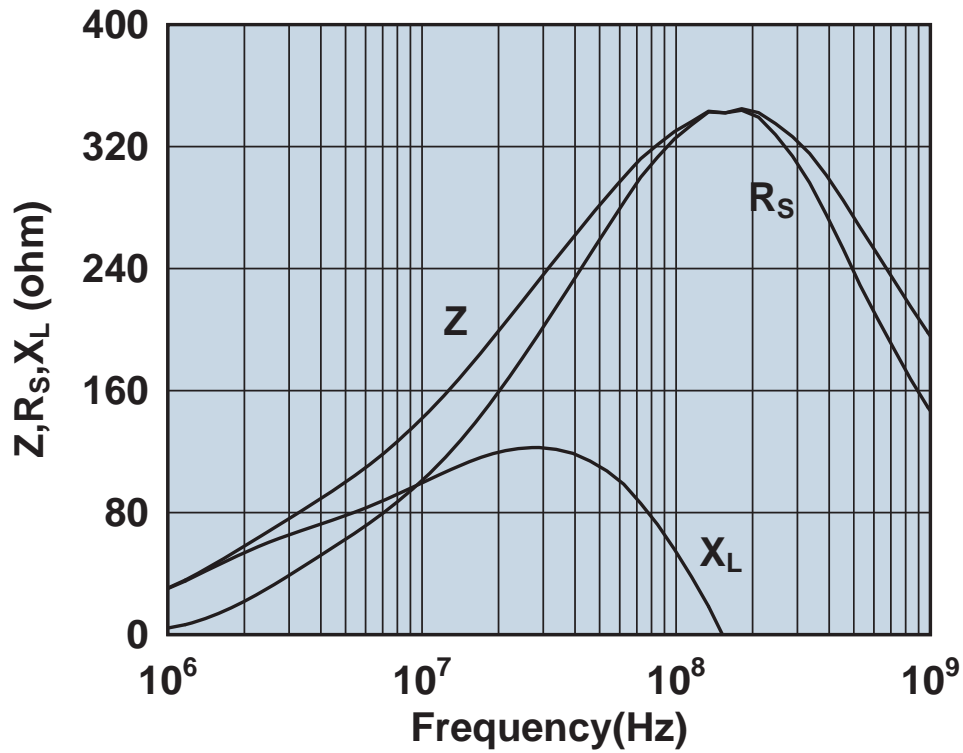

Impedance, reactance, and resistance vs. frequency.

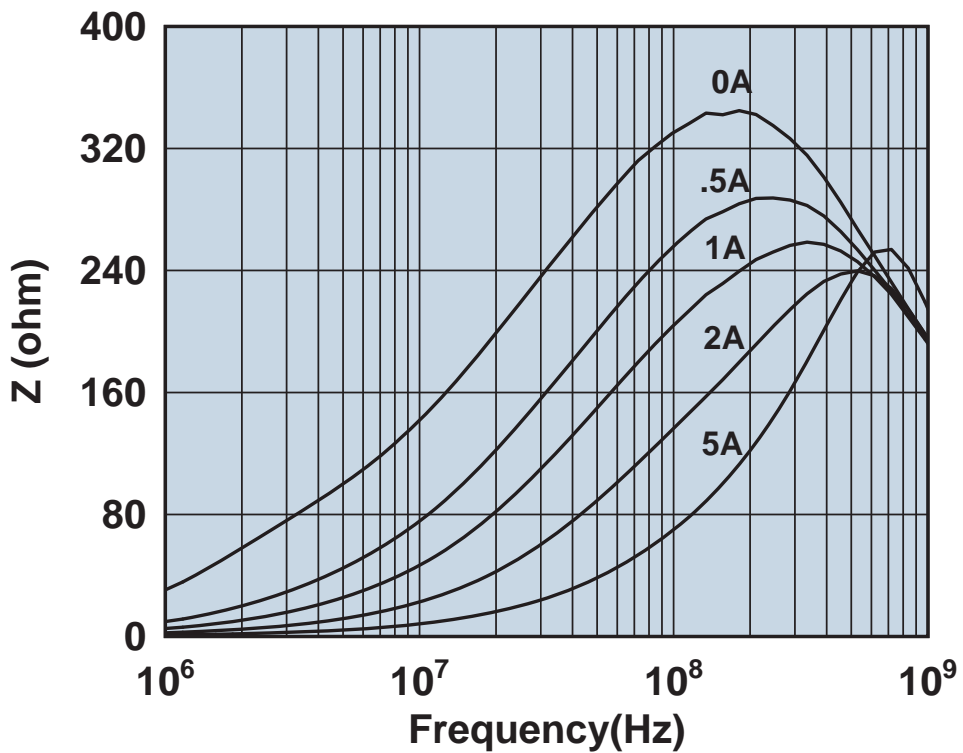

Impedance vs. frequency with dc bias.

2944776101

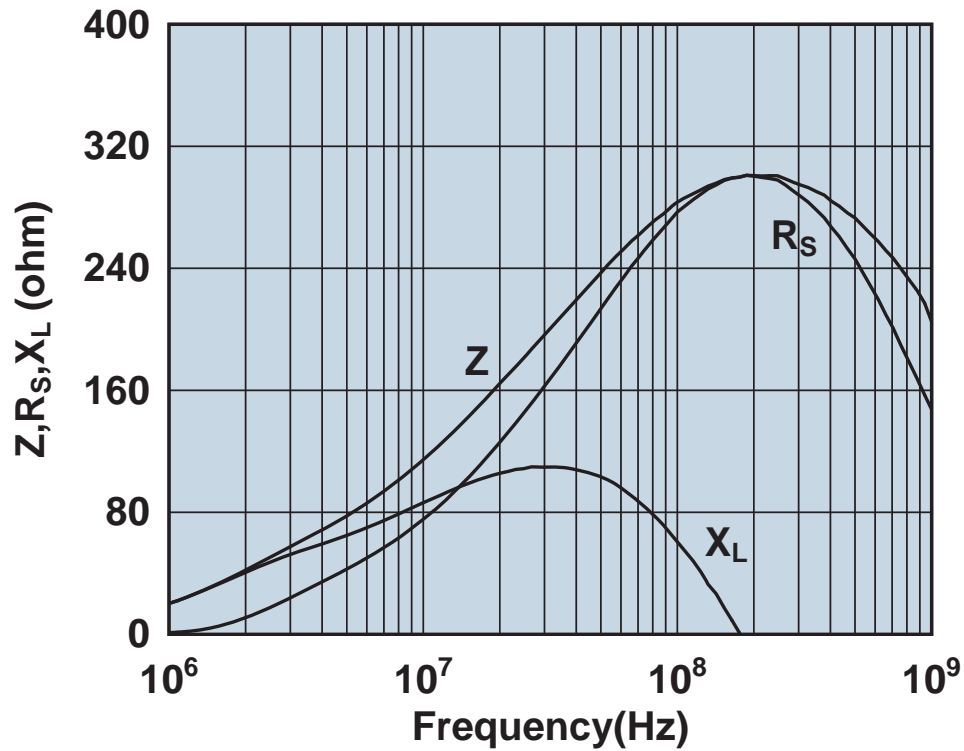

Impedance, reactance, and resistance vs. frequency.

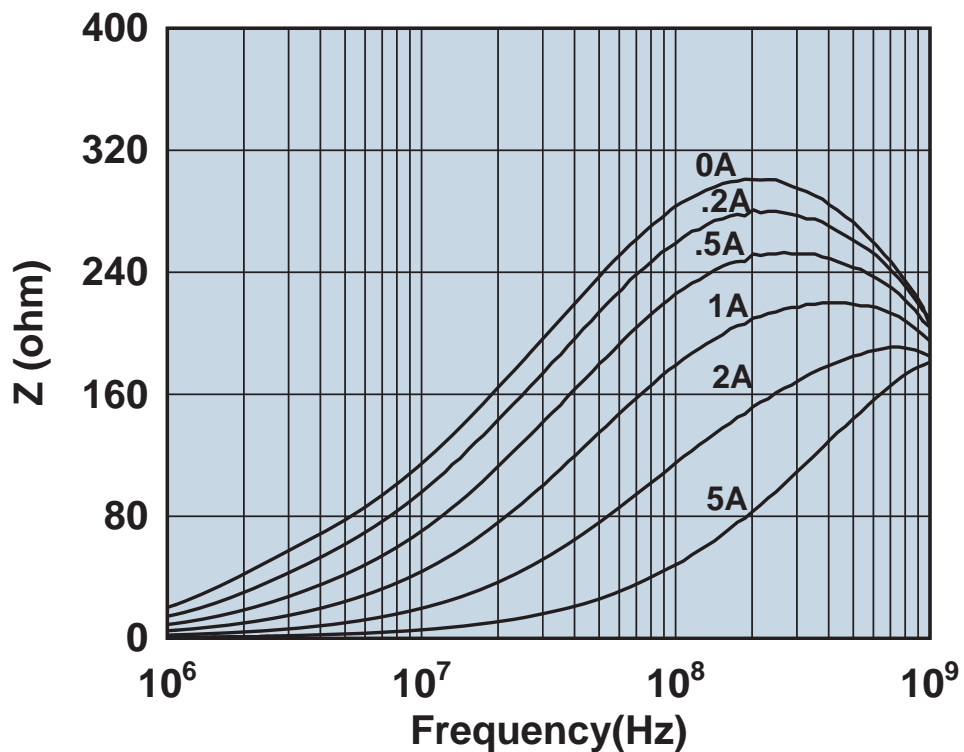

Impedance vs. frequency with dc bias.

2944777721

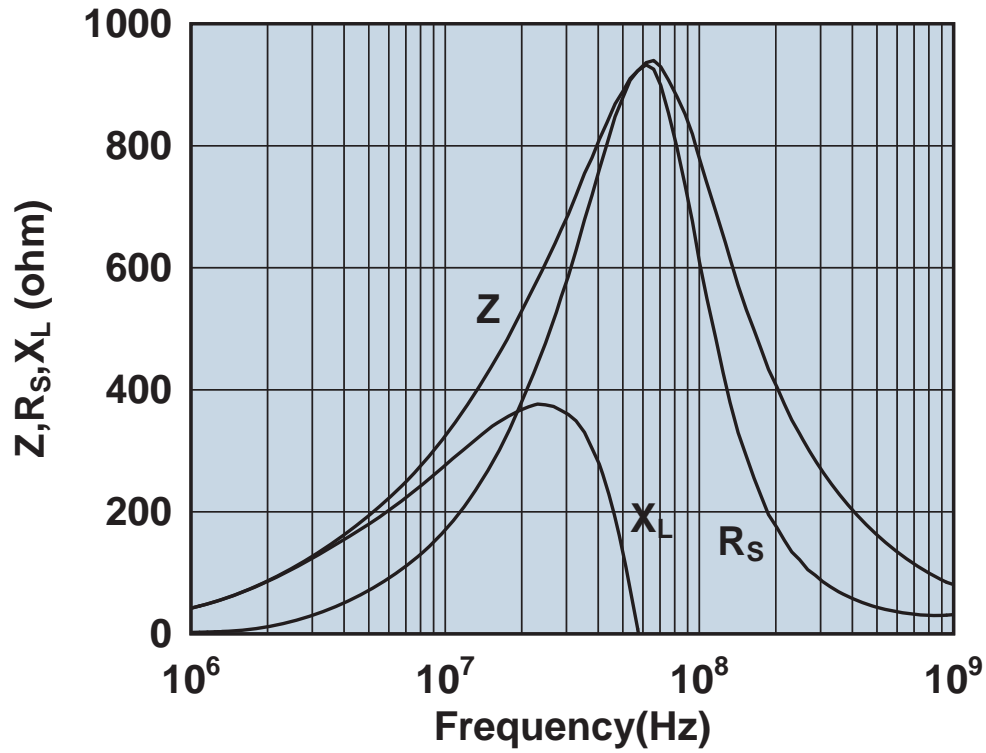

Impedance, reactance, and resistance vs. frequency.

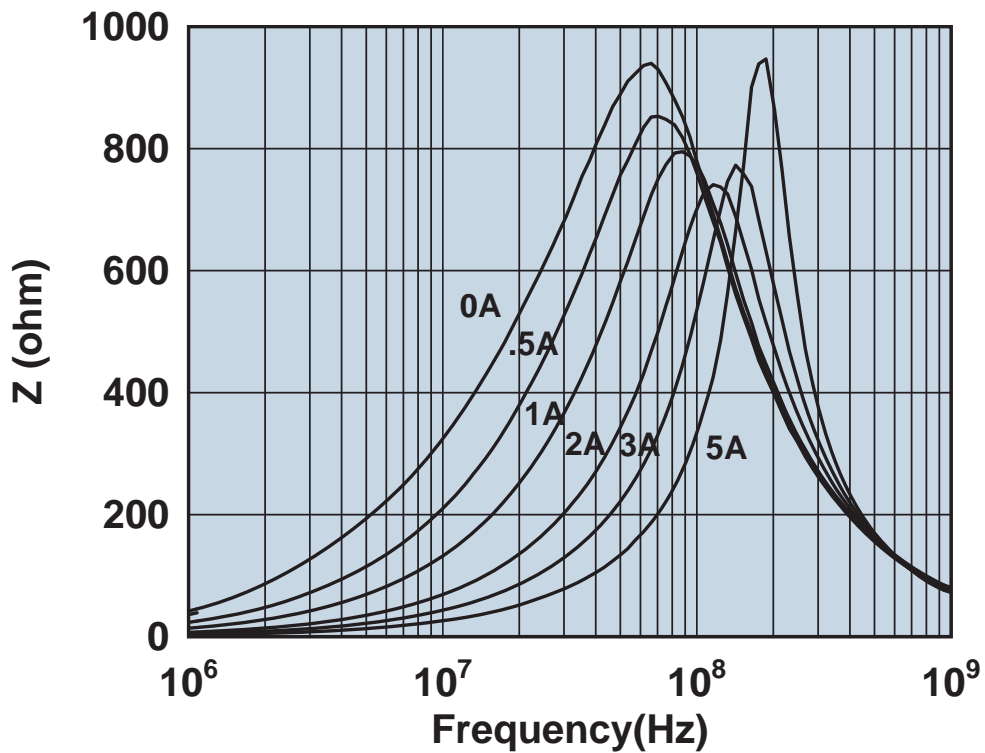

Impedance vs. frequency with dc bias.

2944777741

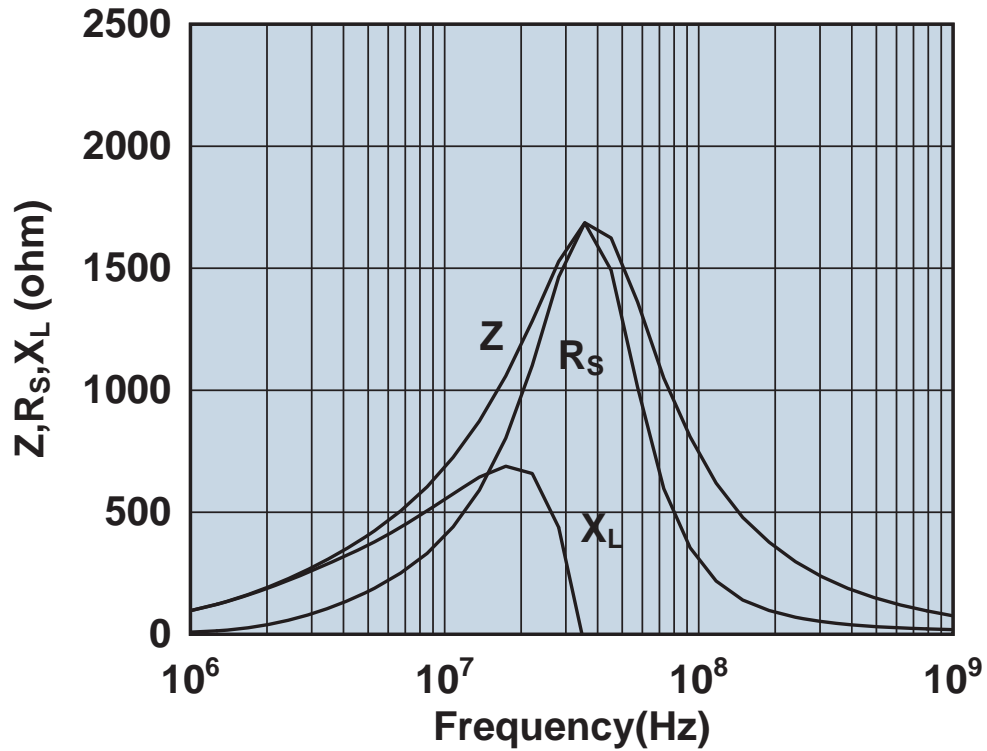

Impedance, reactance, and resistance vs. frequency.

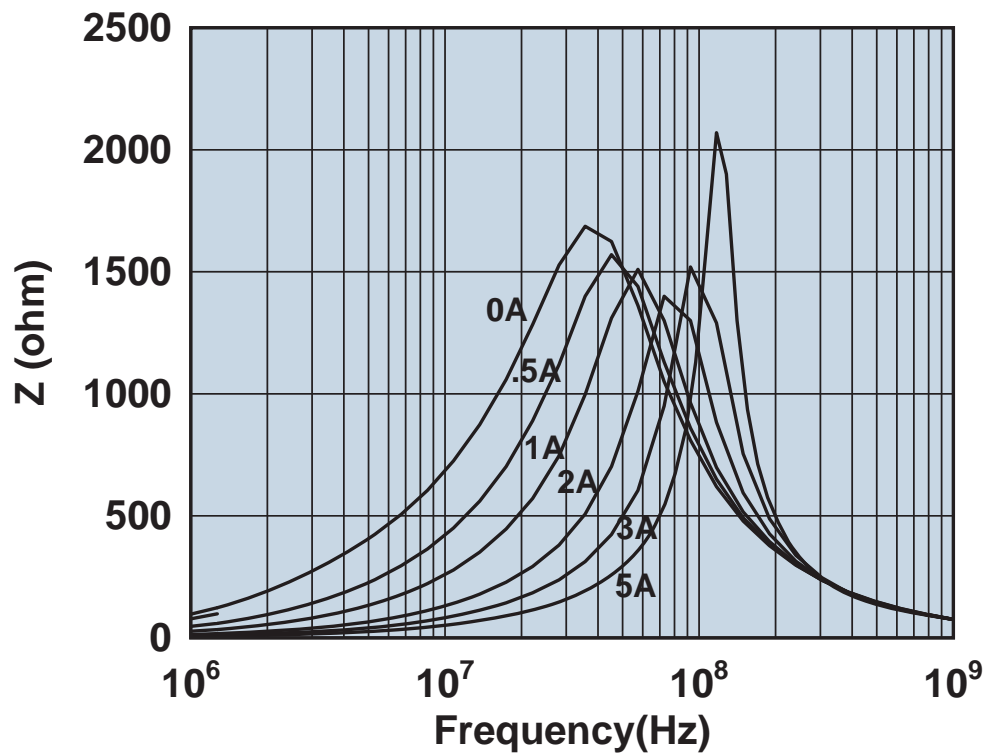

Impedance vs. frequency with dc bias.

2944778101

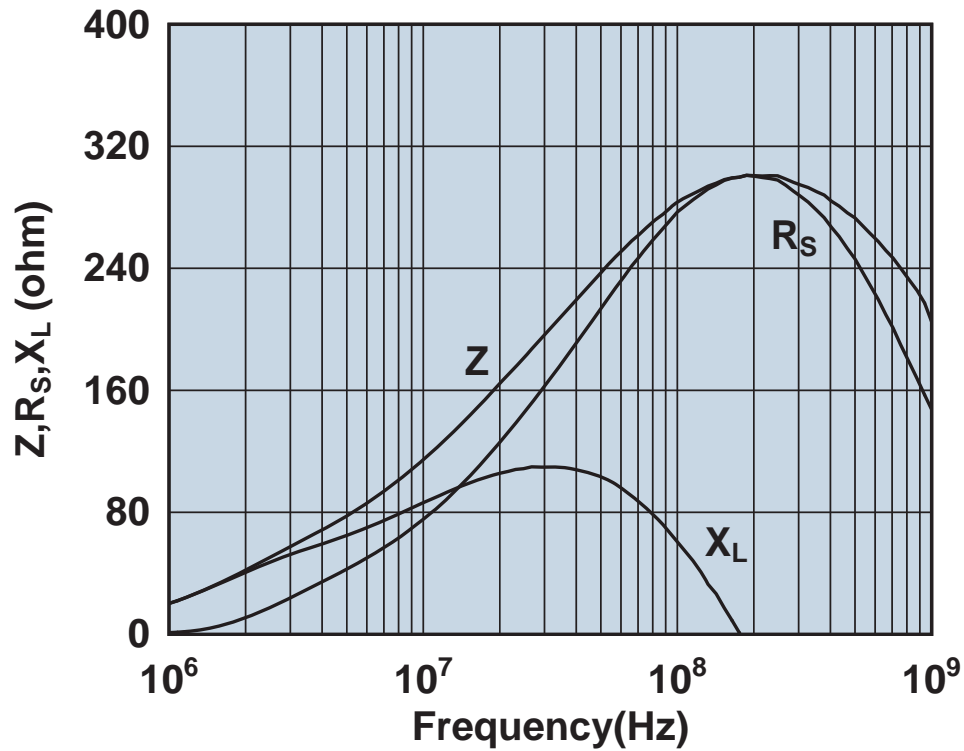

Impedance, reactance, and resistance vs. frequency.

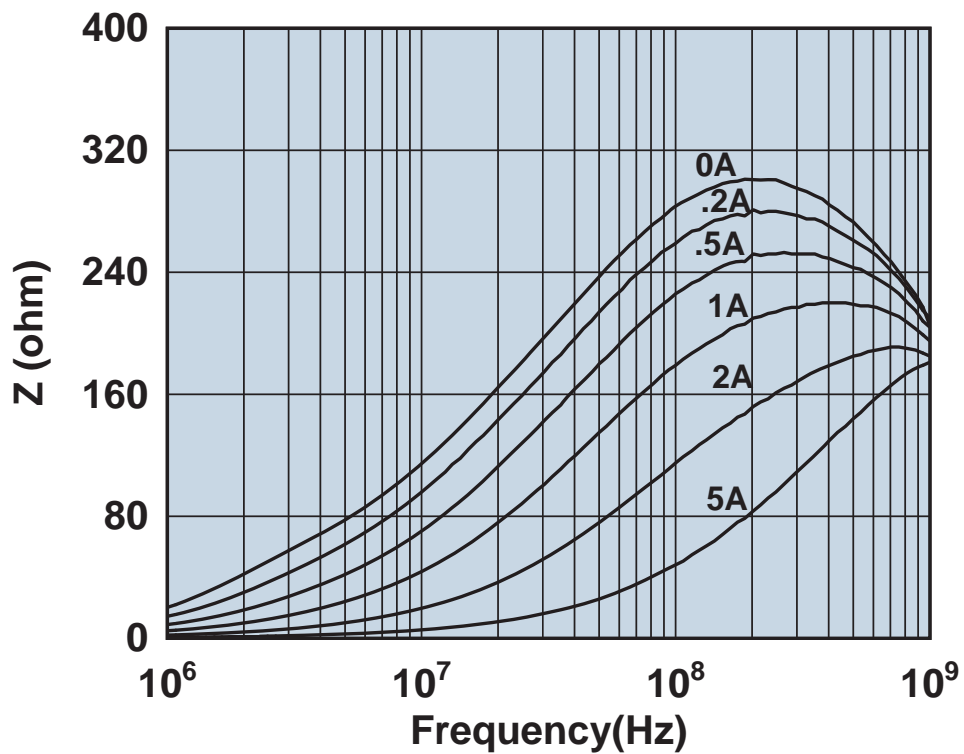

Impedance vs. frequency with dc bias.

2944778301

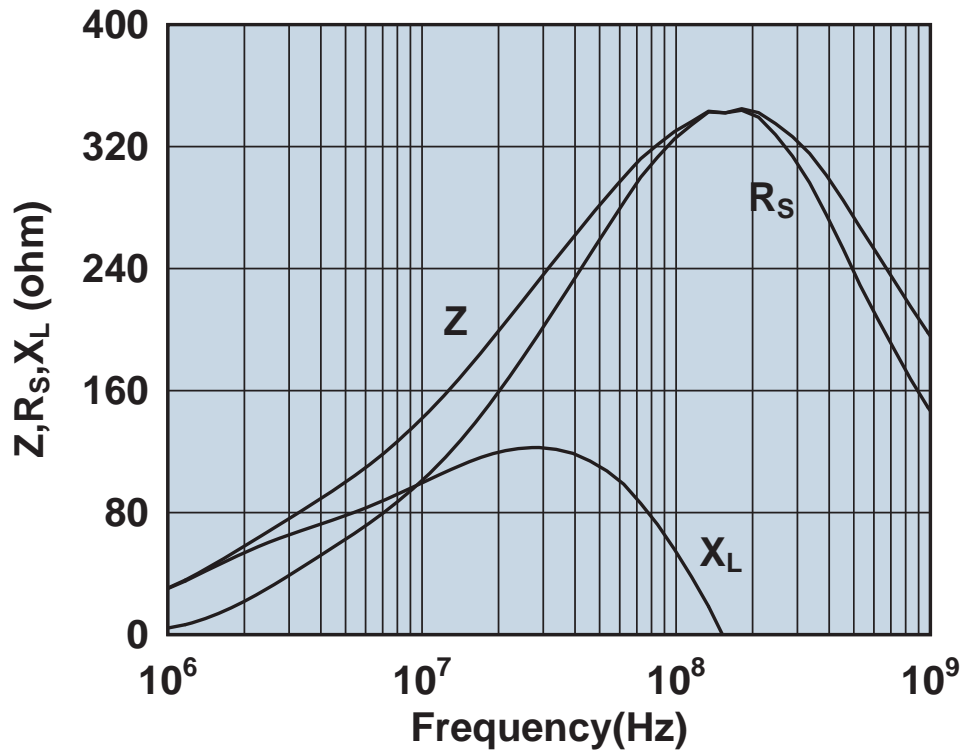

Impedance, reactance, and resistance vs. frequency.

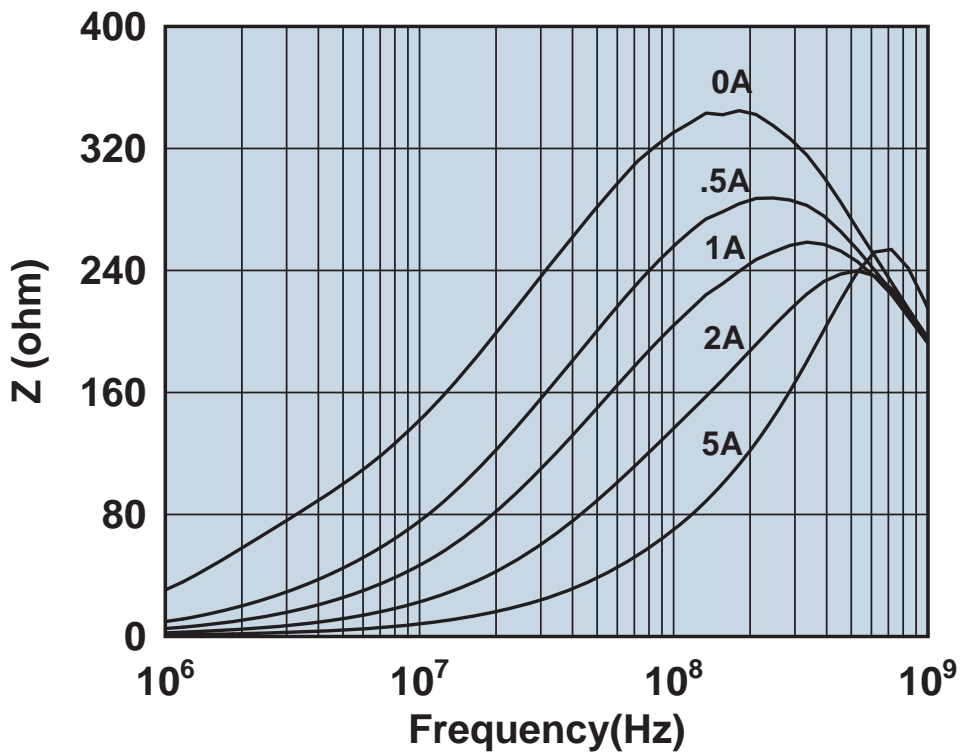

Impedance vs. frequency with dc bias.

2944780301

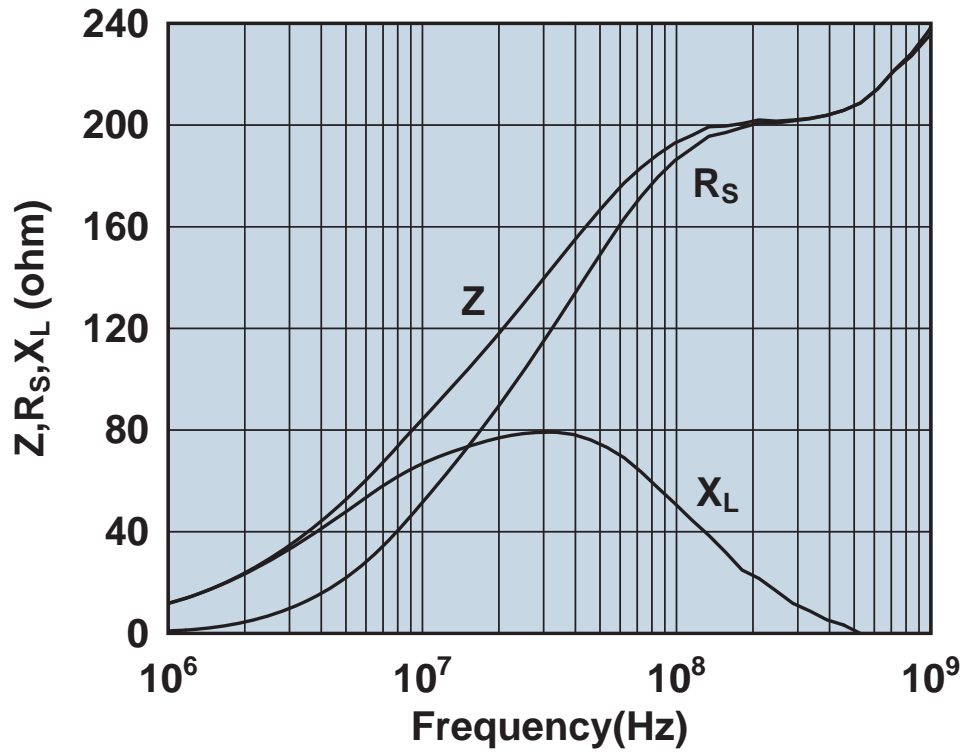

Impedance, reactance, and resistance vs. frequency.

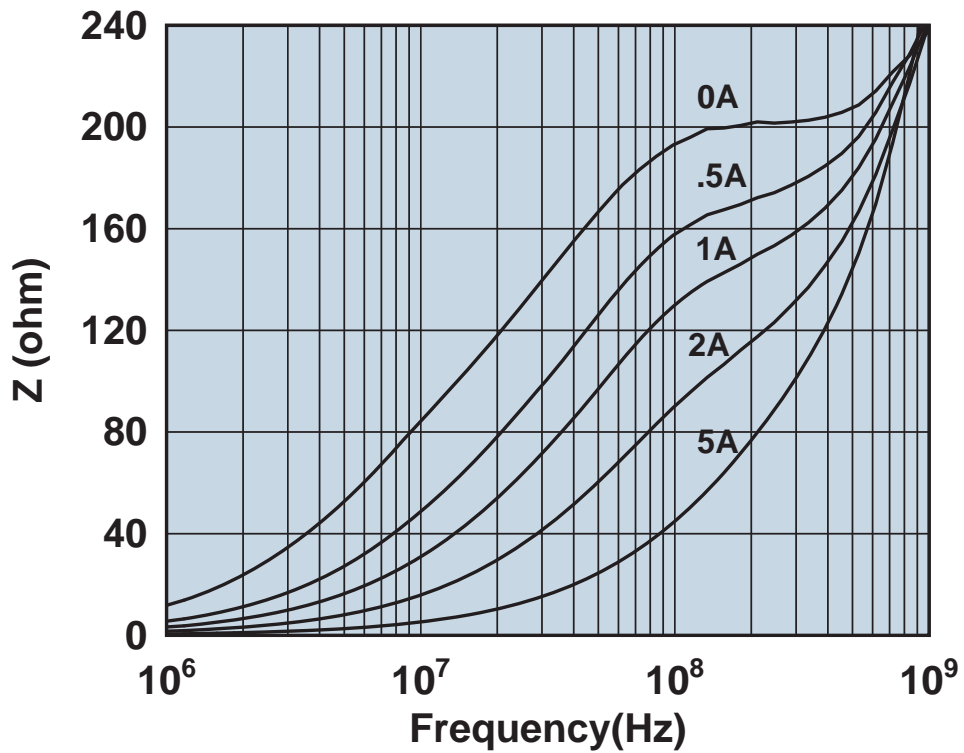

Impedance vs. frequency with dc bias.

2944786101

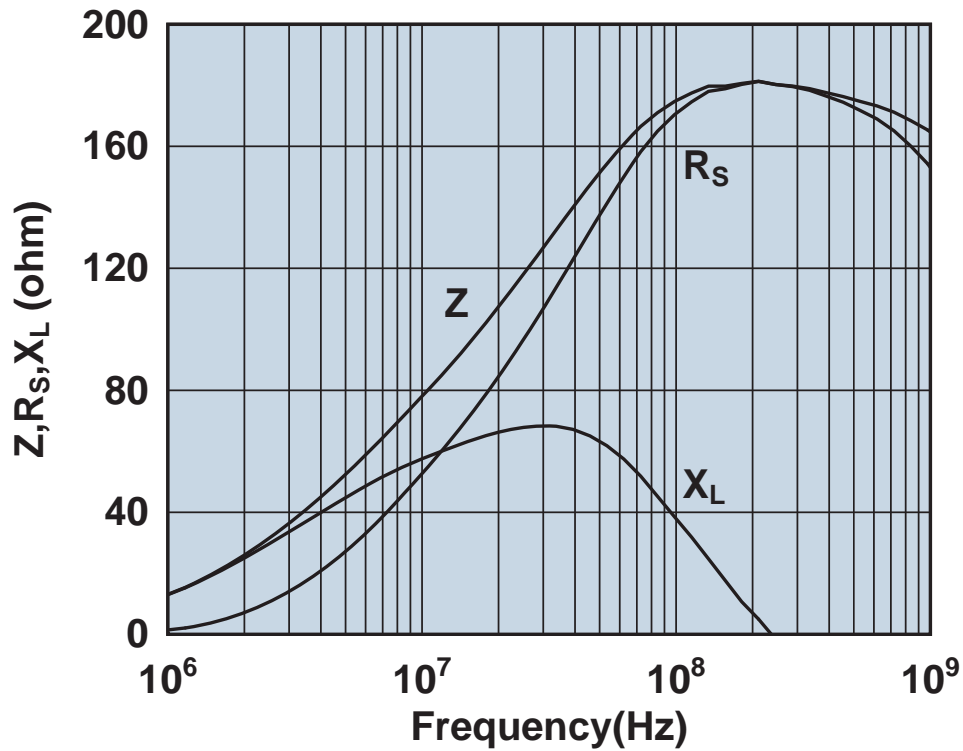

Impedance, reactance, and resistance vs. frequency.

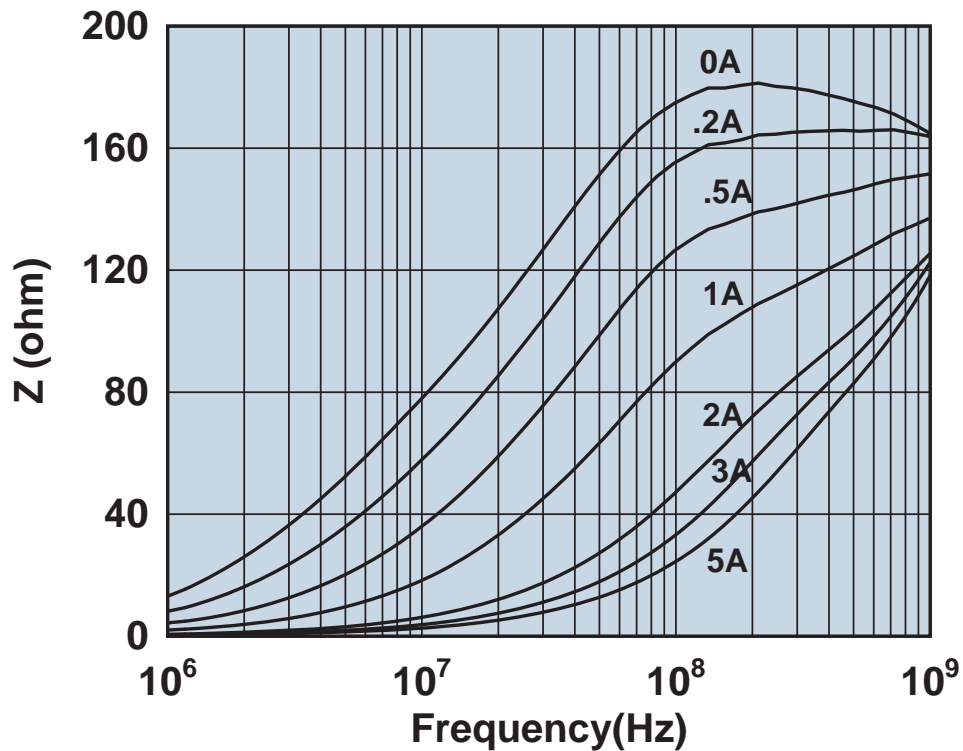

Impedance vs. frequency with dc bias.

2944788101

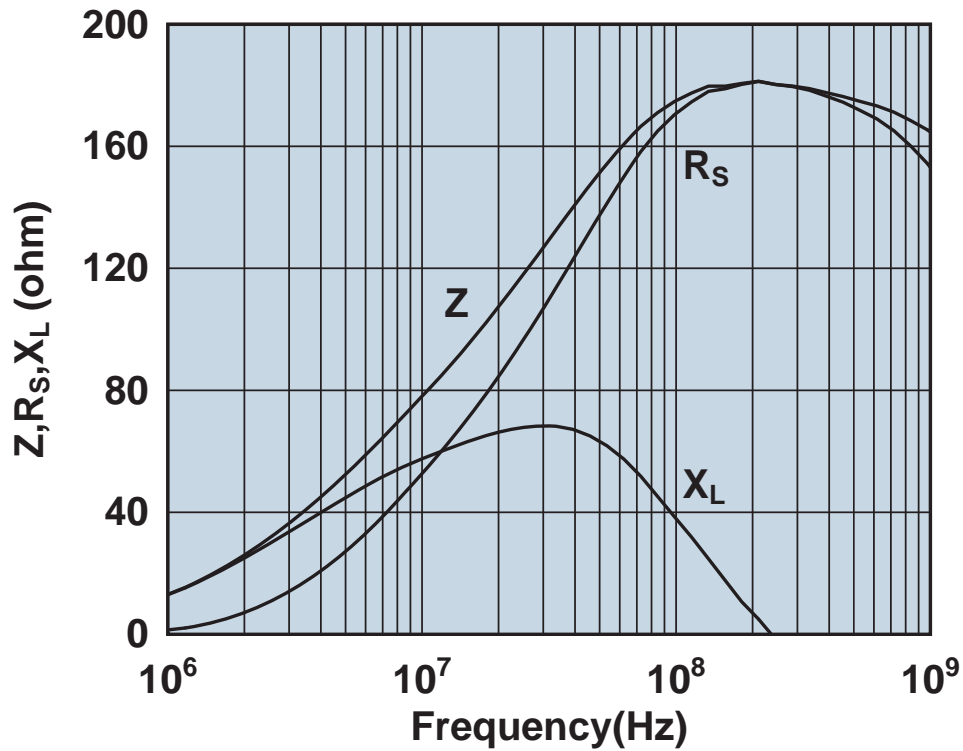

Impedance, reactance, and resistance vs. frequency.

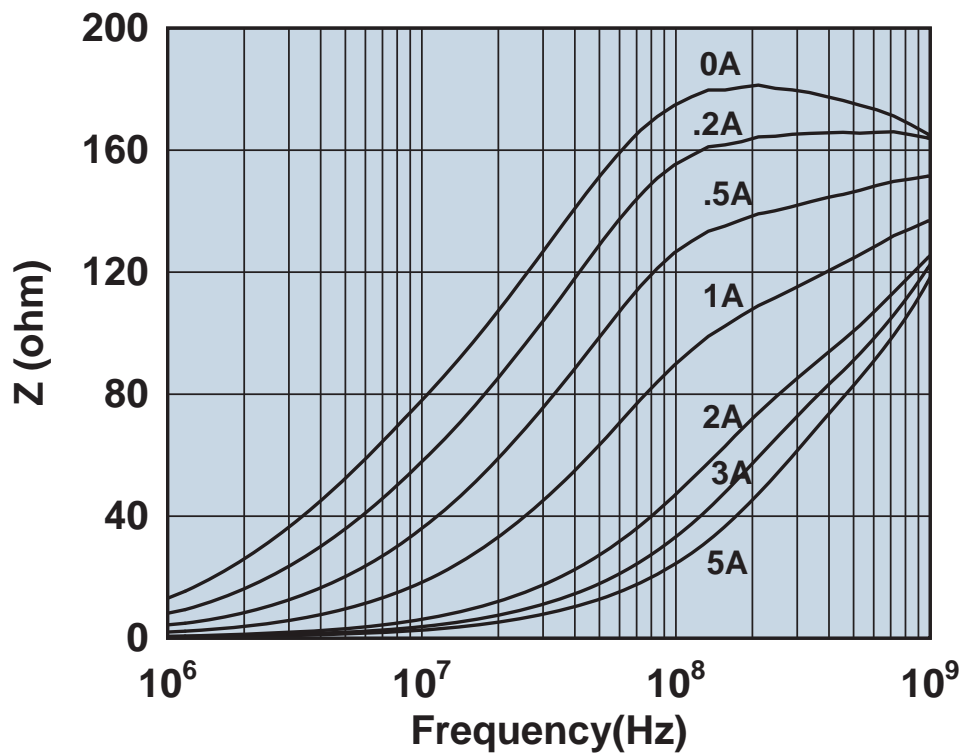

Impedance vs. frequency with dc bias.

2944788301

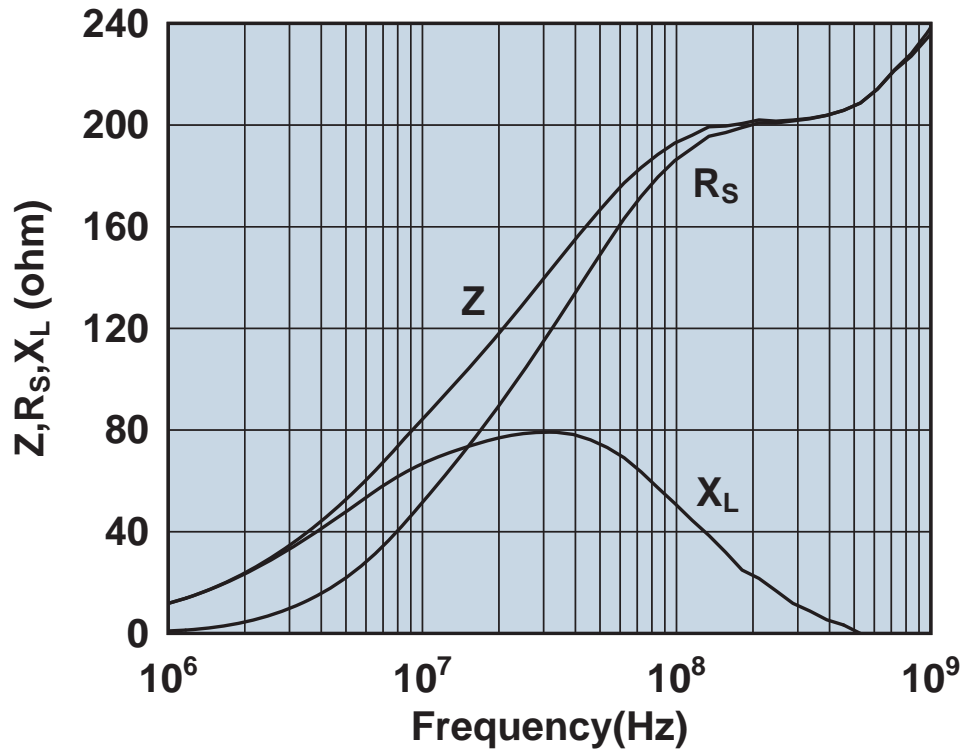

Impedance, reactance, and resistance vs. frequency.

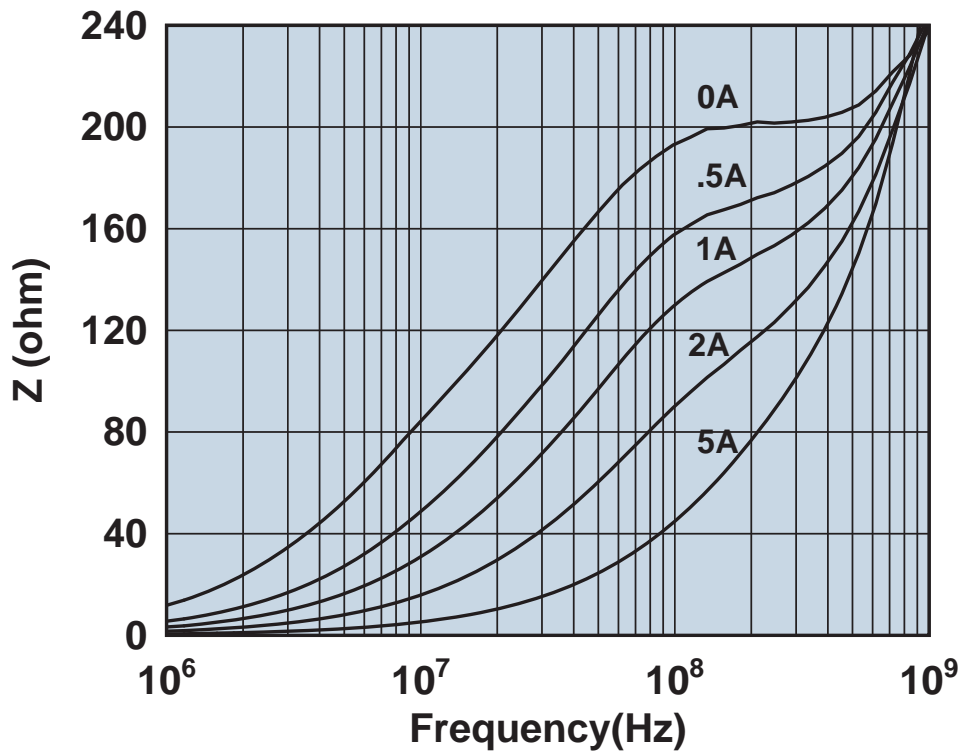

Impedance vs. frequency with dc bias.

2952770301

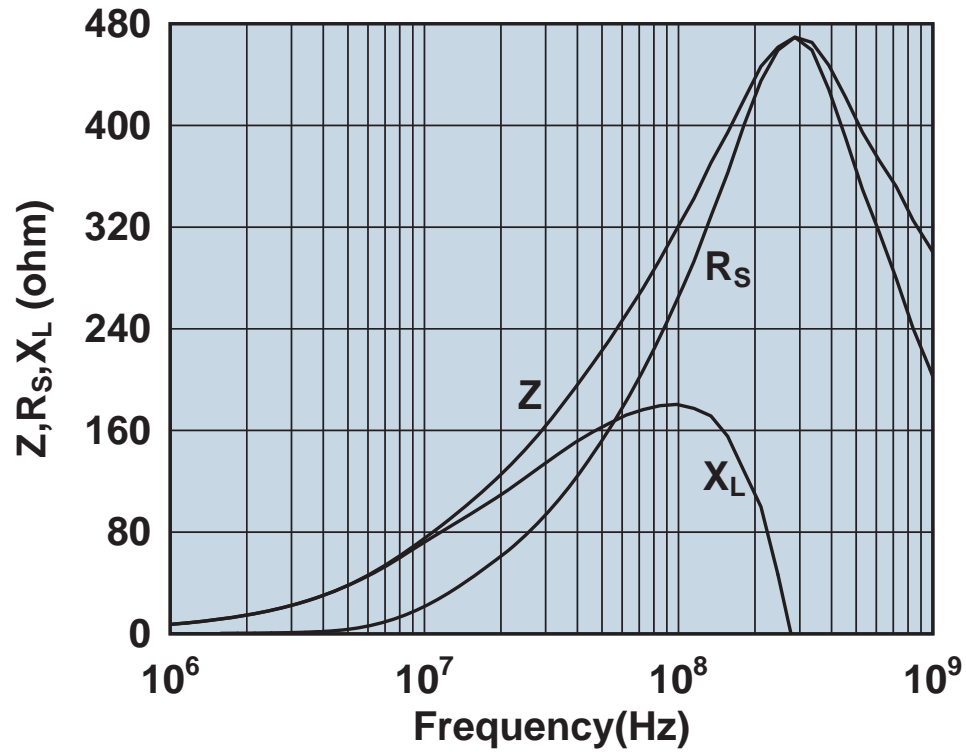

Impedance, reactance, and resistance vs. frequency.

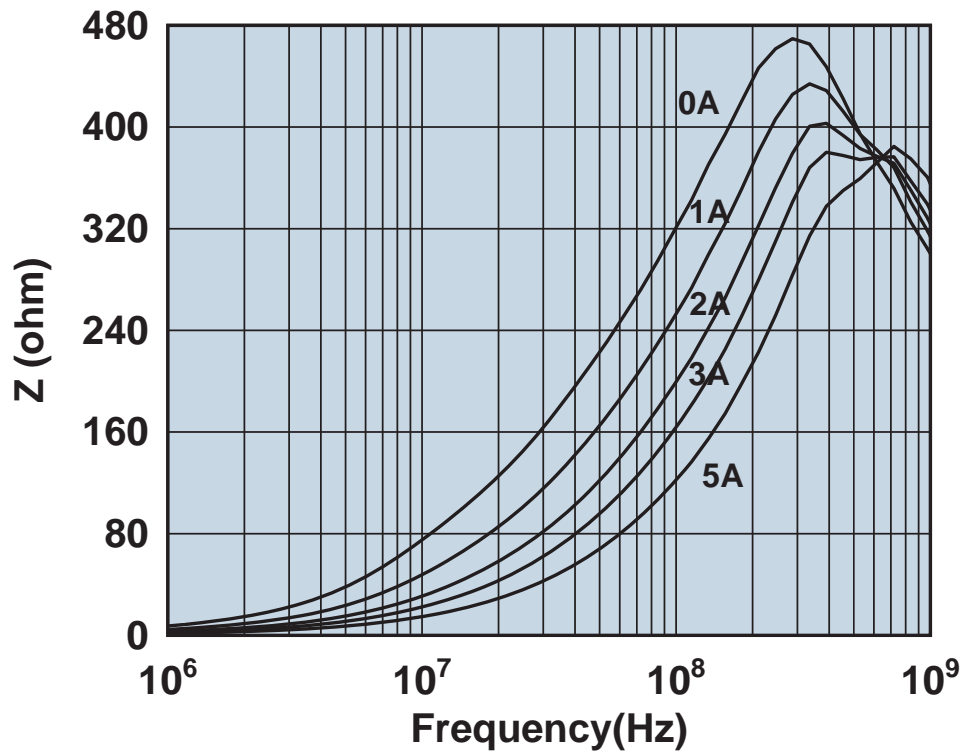

Impedance vs. frequency with dc bias.

2952776101

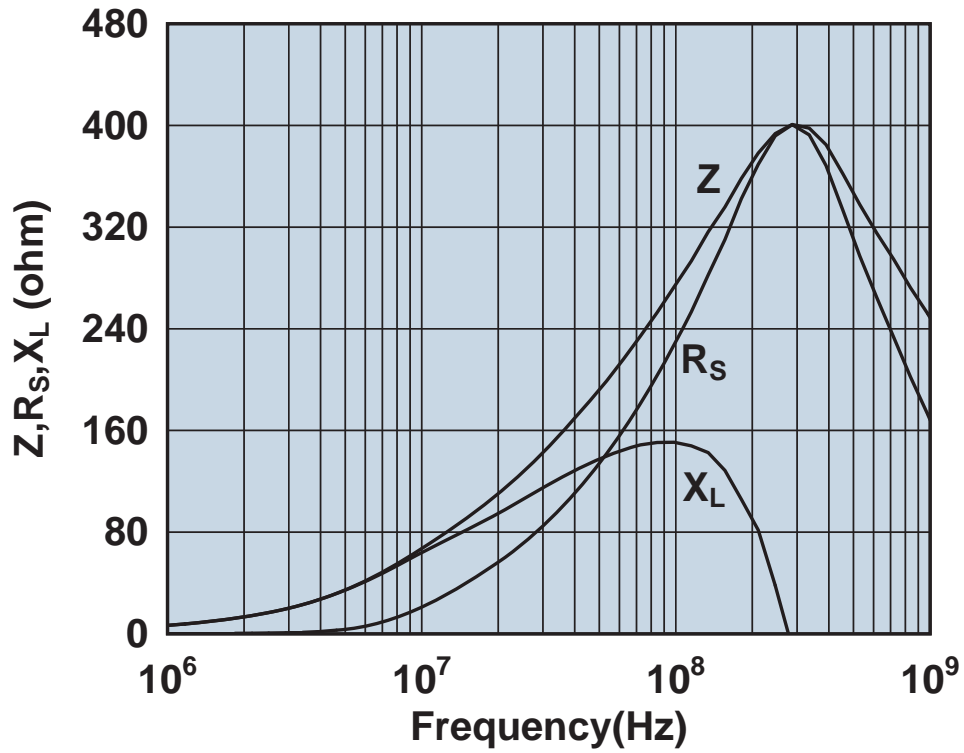

Impedance, reactance, and resistance vs. frequency.

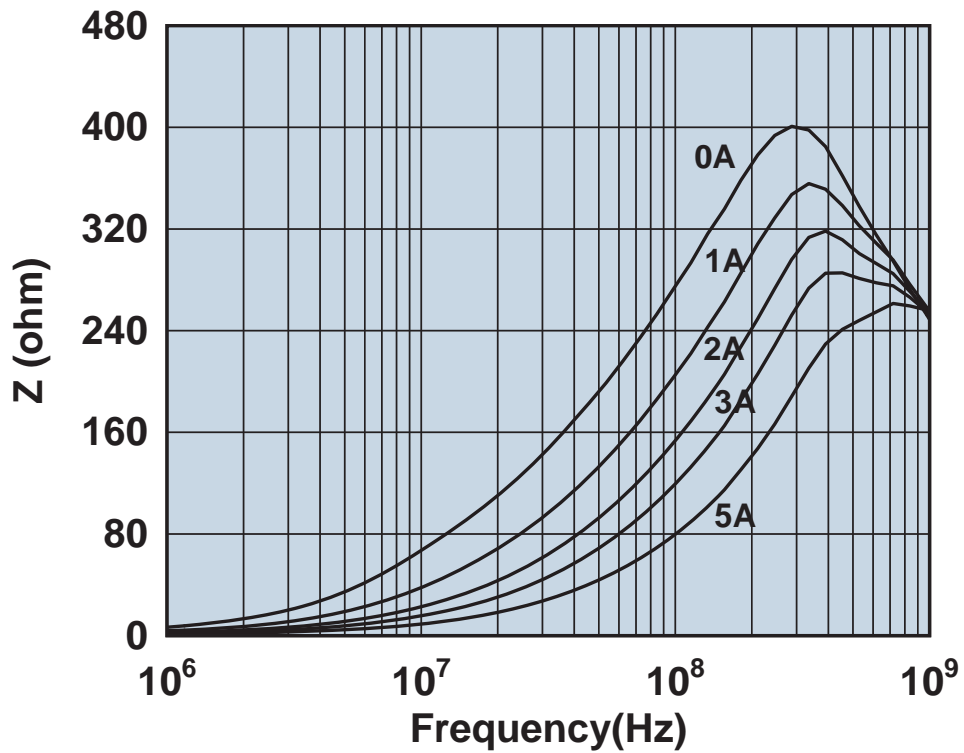

Impedance vs. frequency with dc bias.

2952778101

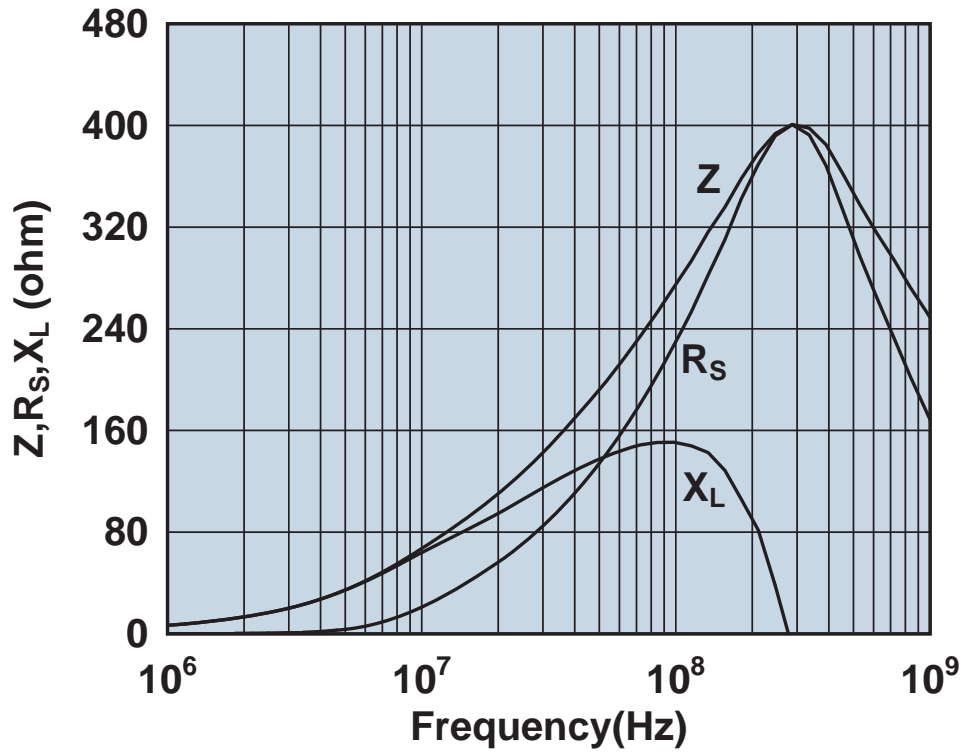

Impedance, reactance, and resistance vs. frequency.

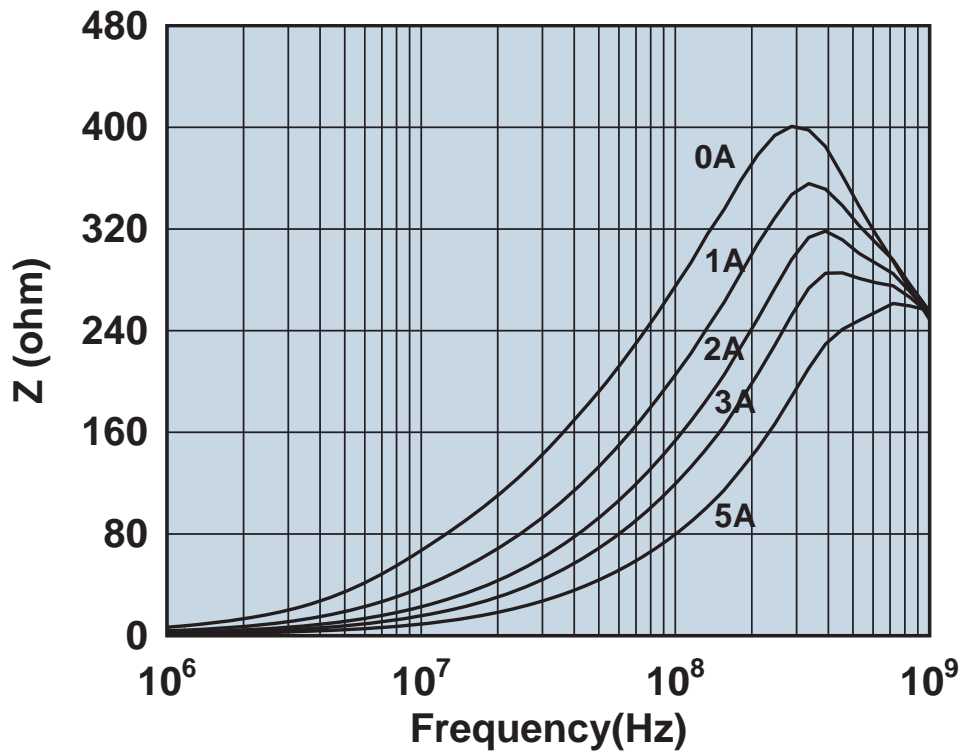

Impedance vs. frequency with dc bias.

2952778301

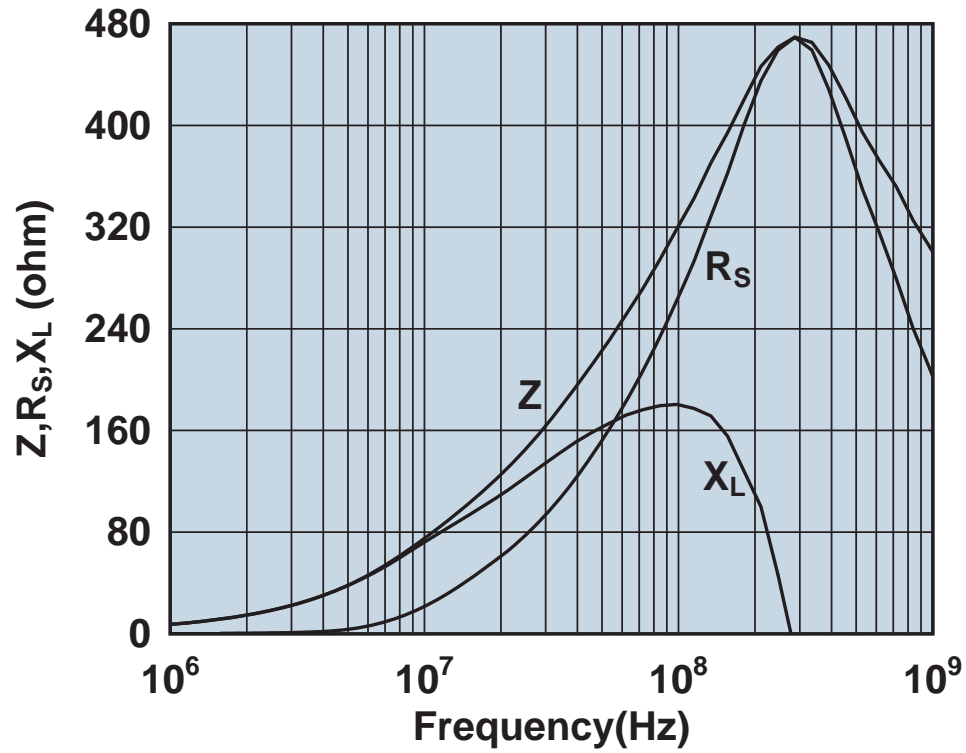

Impedance, reactance, and resistance vs. frequency.

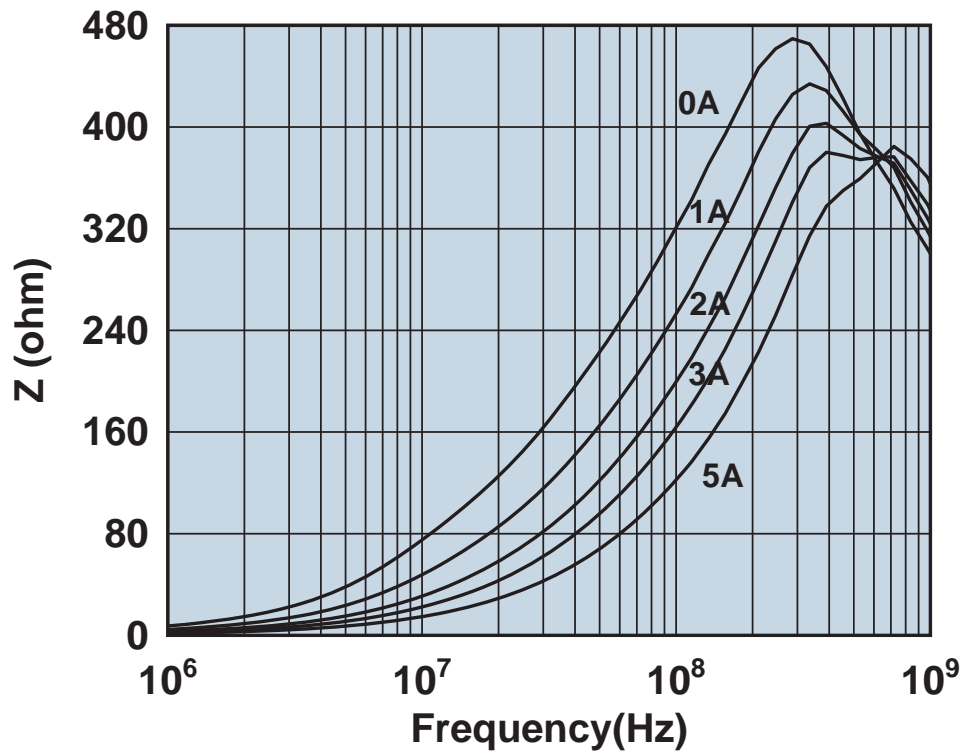

Impedance vs. frequency with dc bias.

2952780301

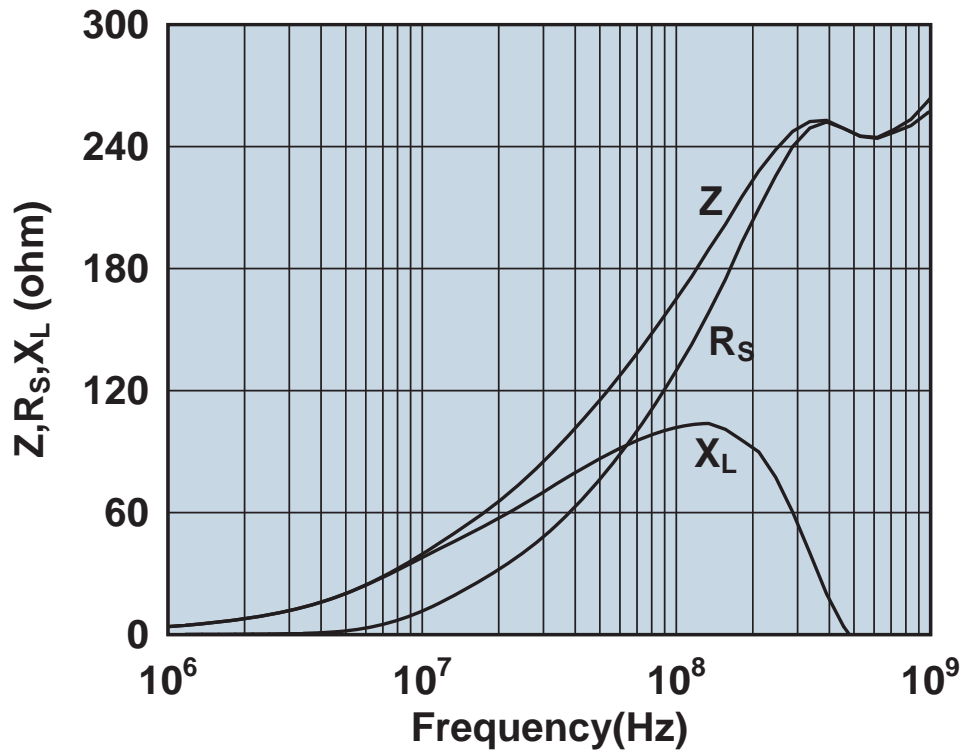

Impedance, reactance, and resistance vs. frequency.

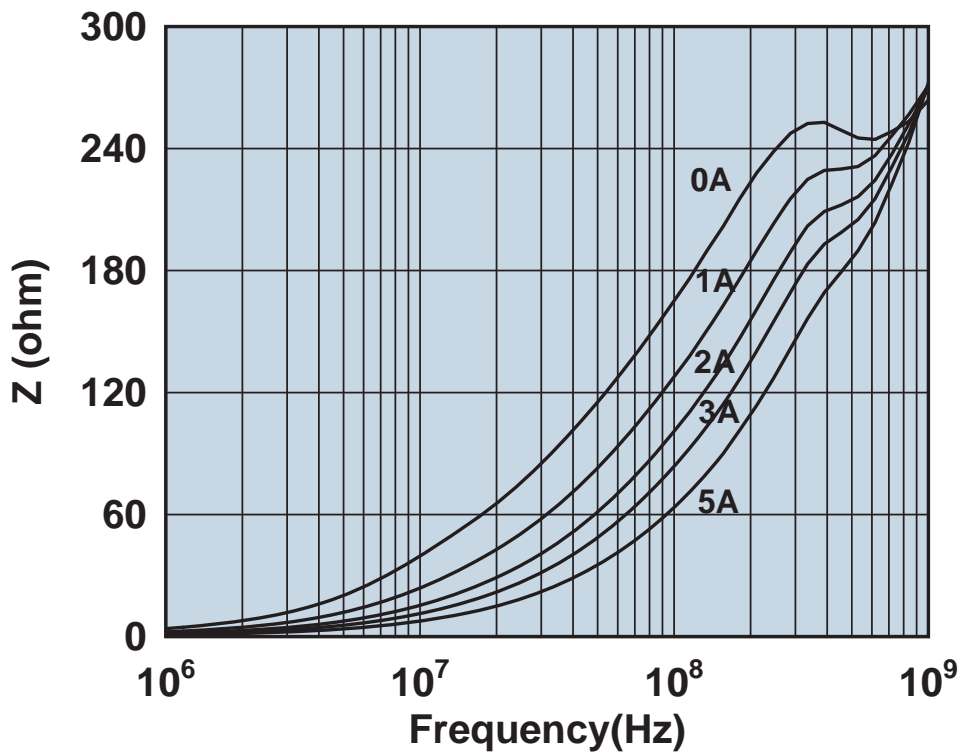

Impedance vs. frequency with dc bias.

2952786101

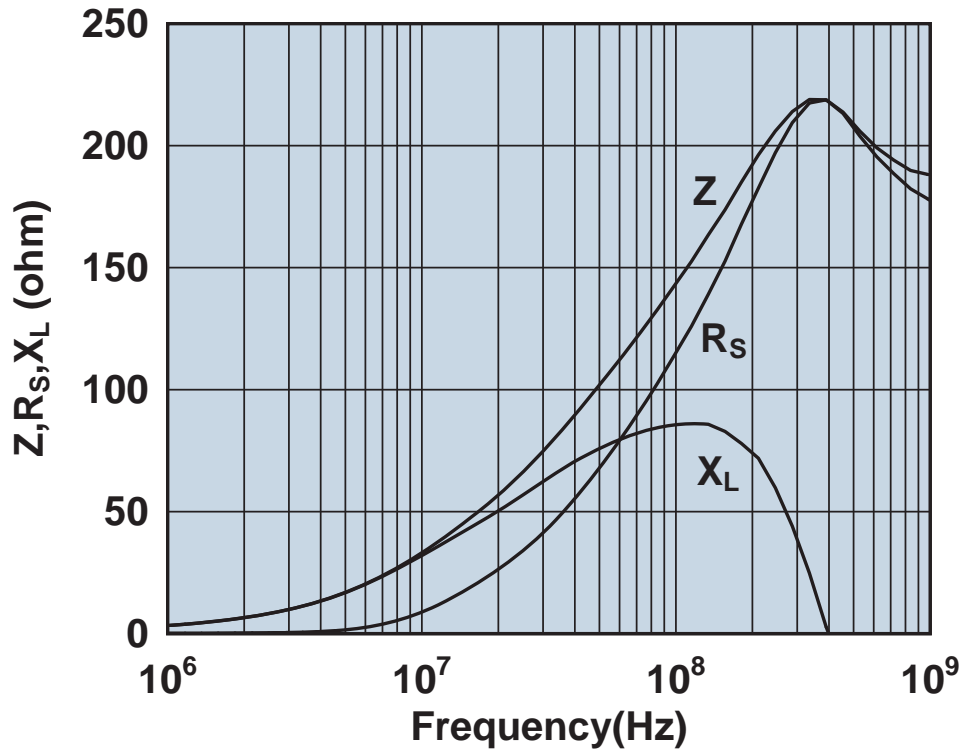

Impedance, reactance, and resistance vs. frequency.

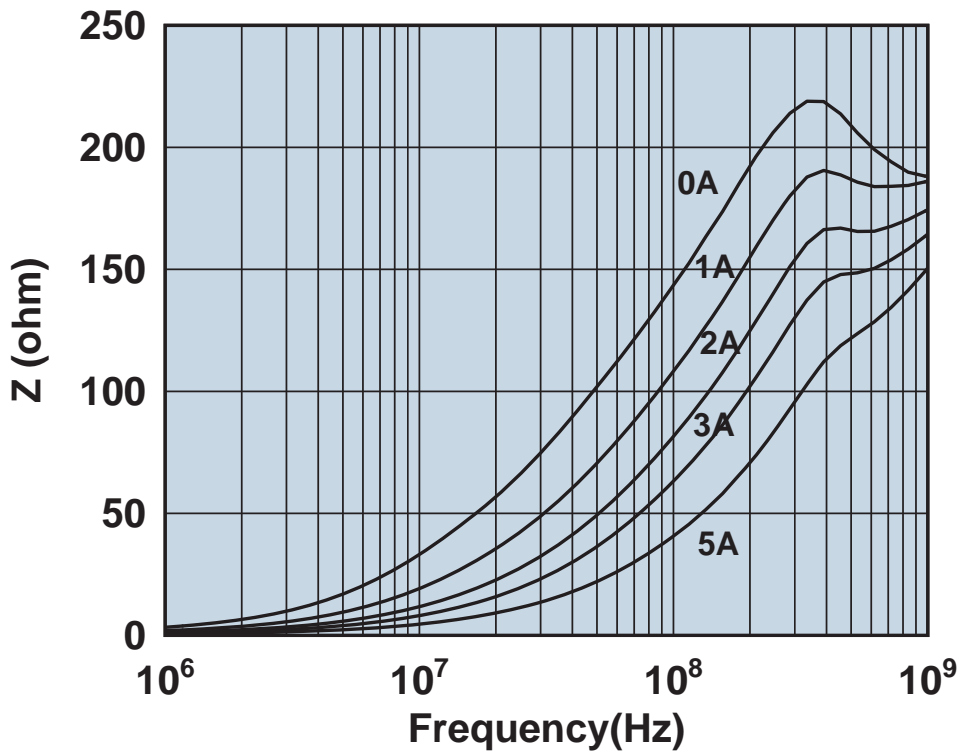

Impedance vs. frequency with dc bias.

2952788101

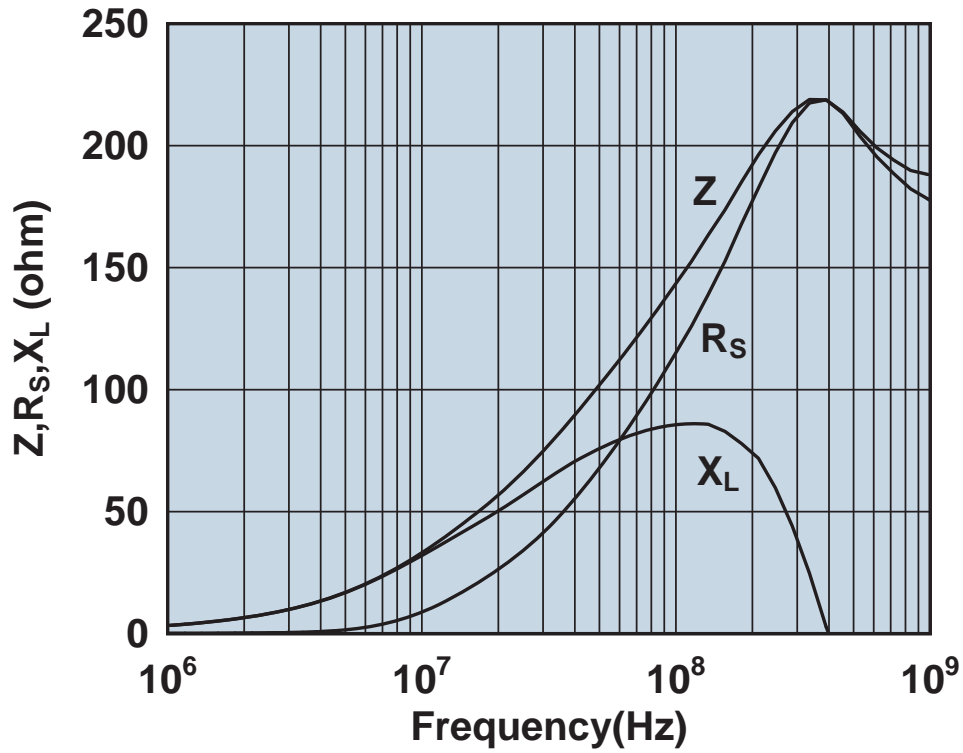

Impedance, reactance, and resistance vs. frequency.

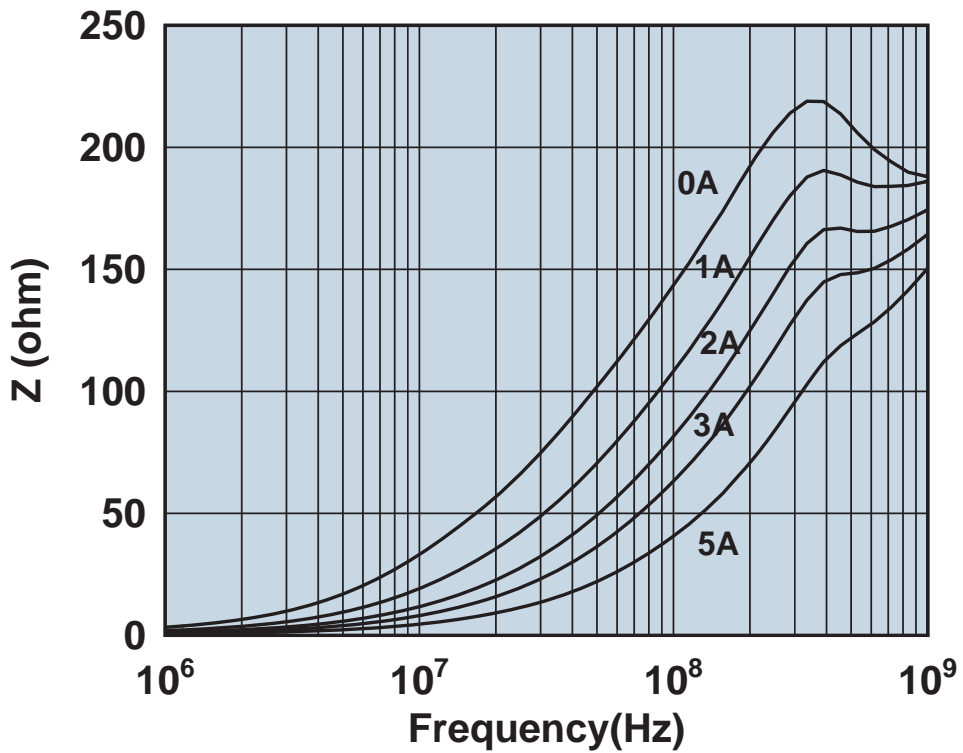

Impedance vs. frequency with dc bias.

2952788301

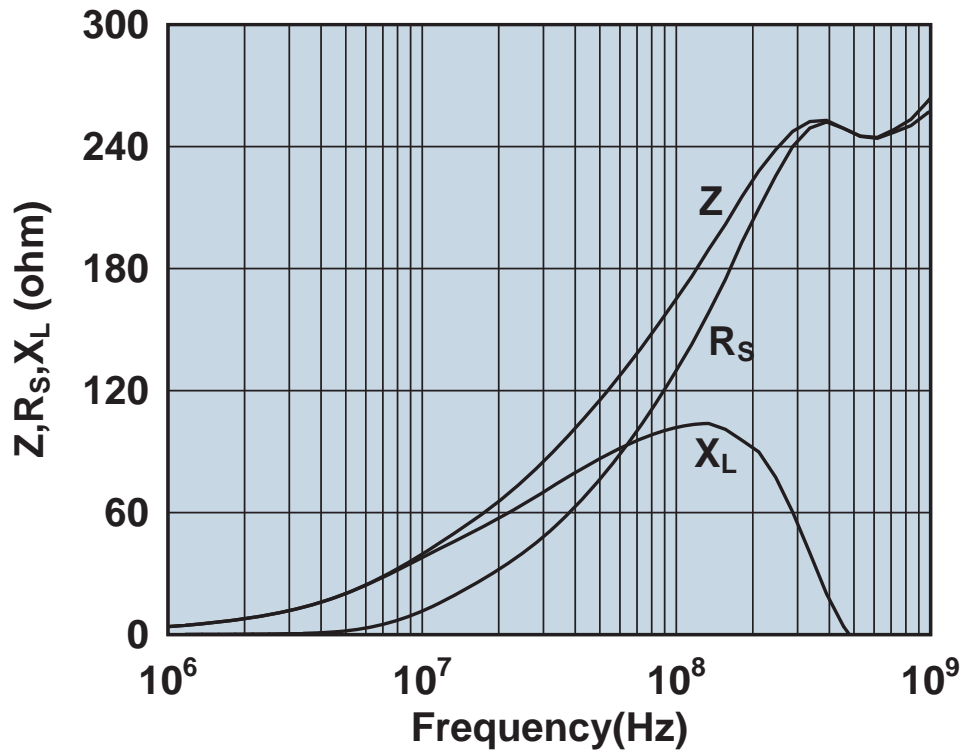

Impedance, reactance, and resistance vs. frequency.

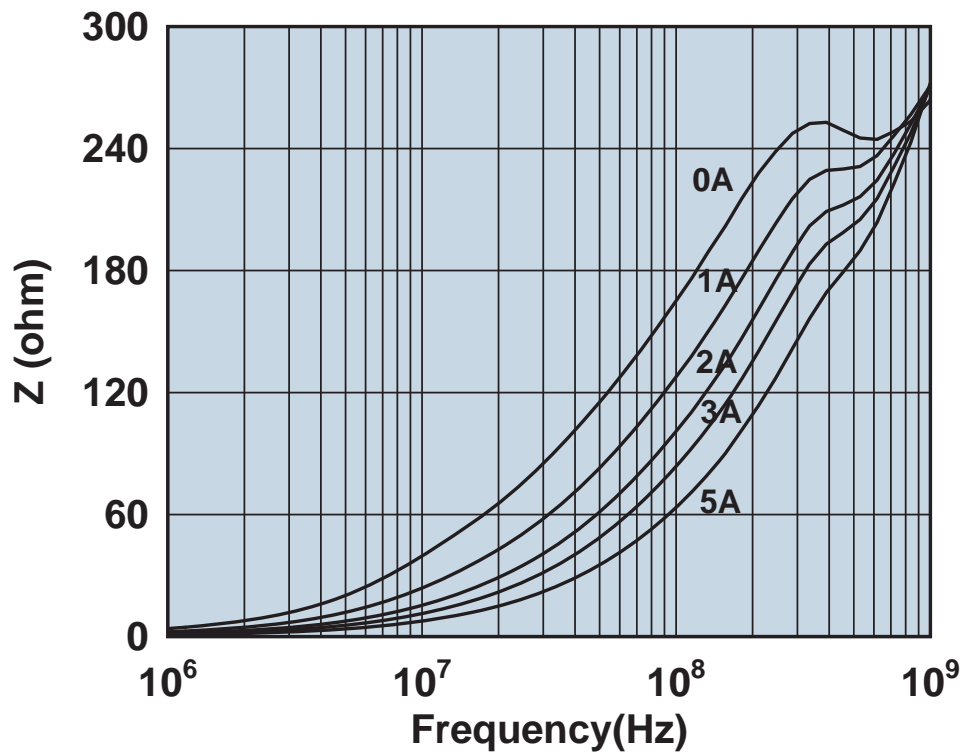

Impedance vs. frequency with dc bias.

2961666631

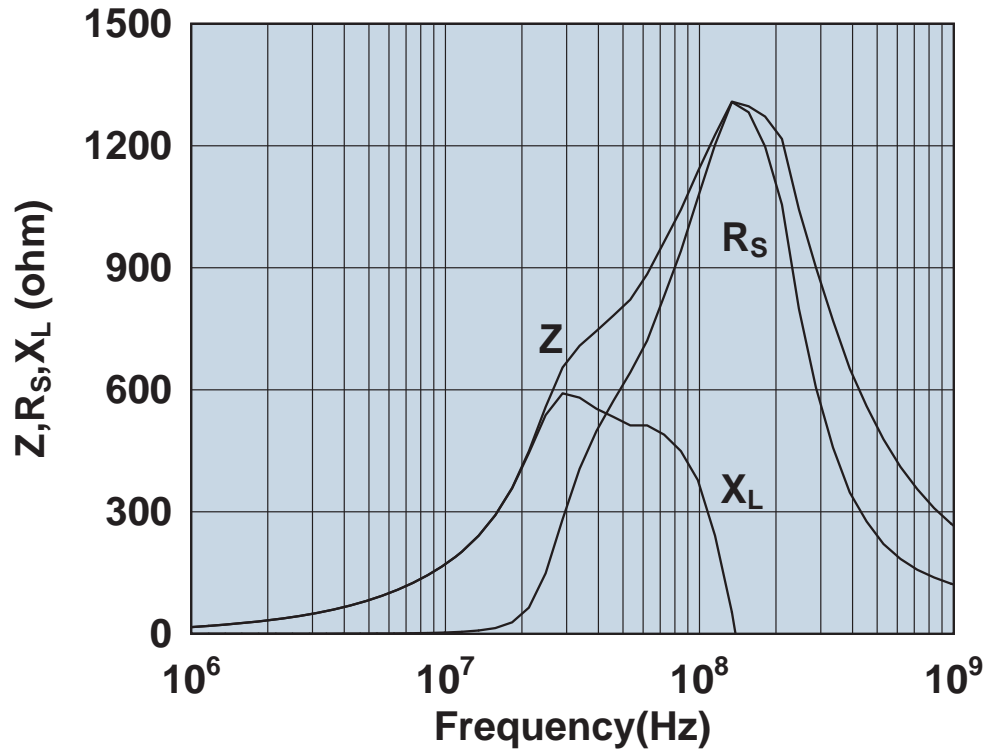

Impedance, reactance, and resistance vs. frequency.

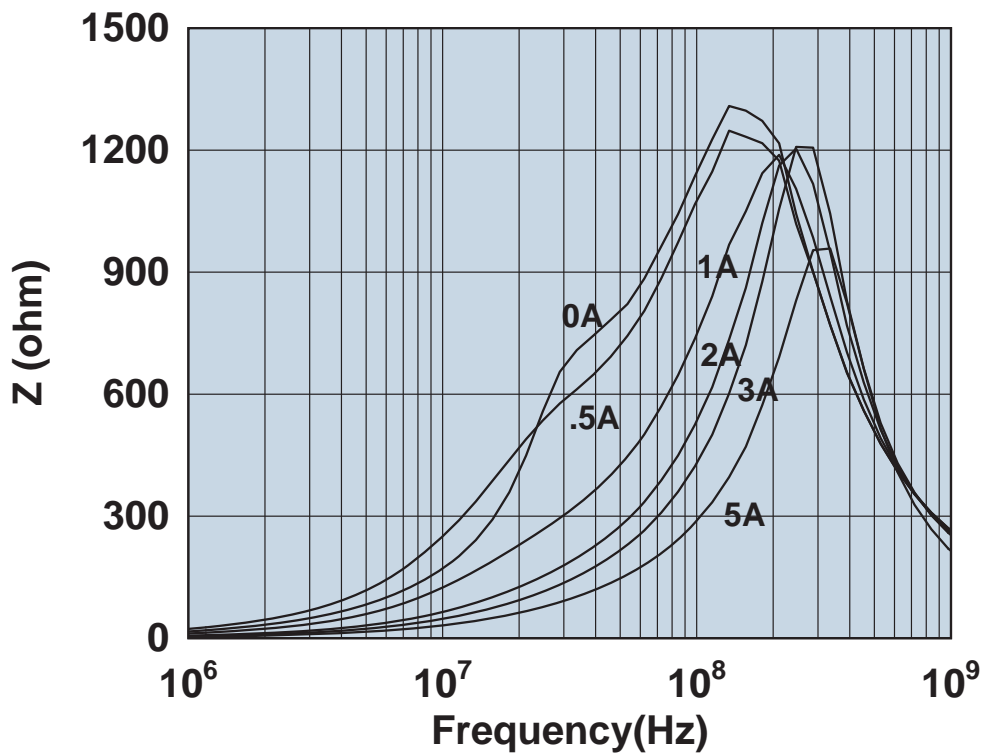

Impedance vs. frequency with dc bias.

2961666651

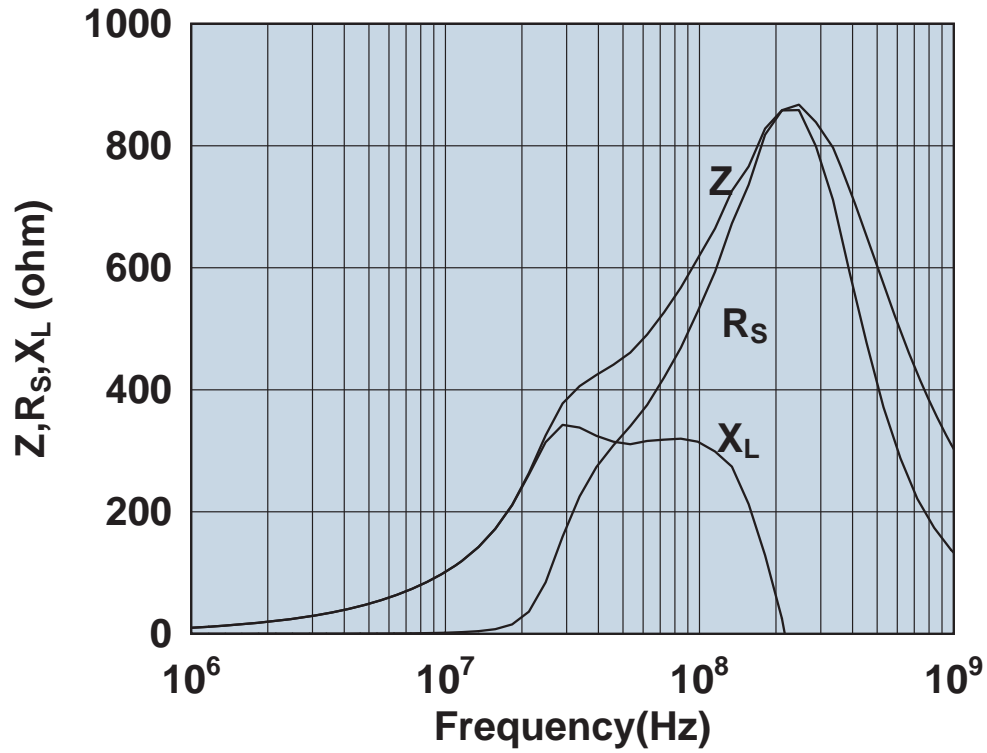

Impedance, reactance, and resistance vs. frequency.

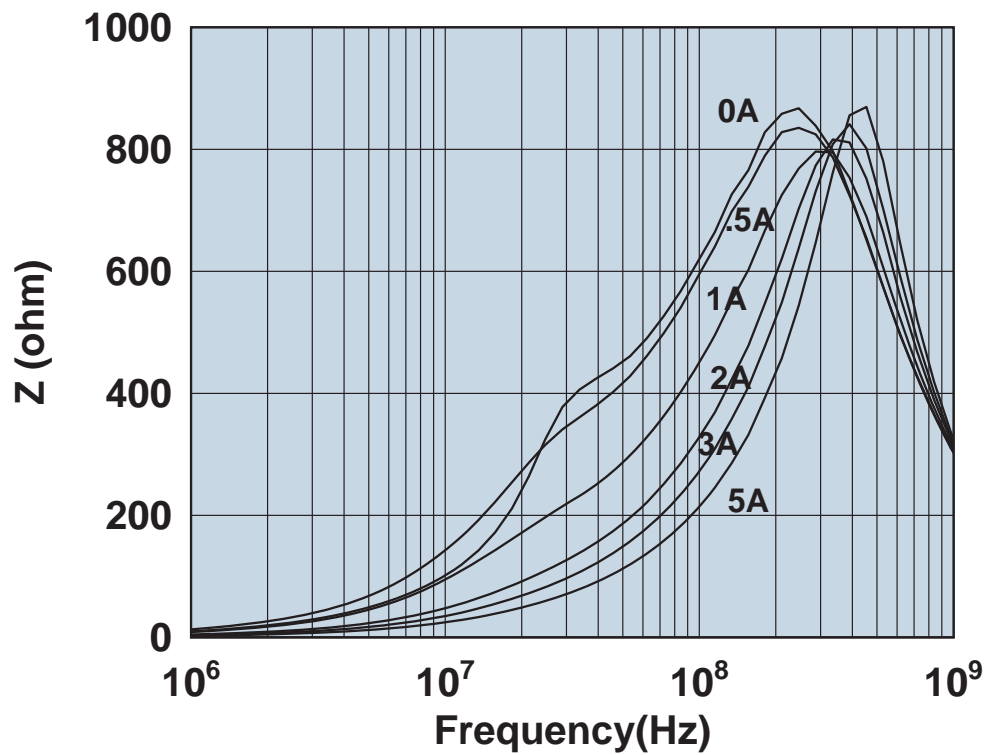

Impedance vs. frequency with dc bias.

2961666661

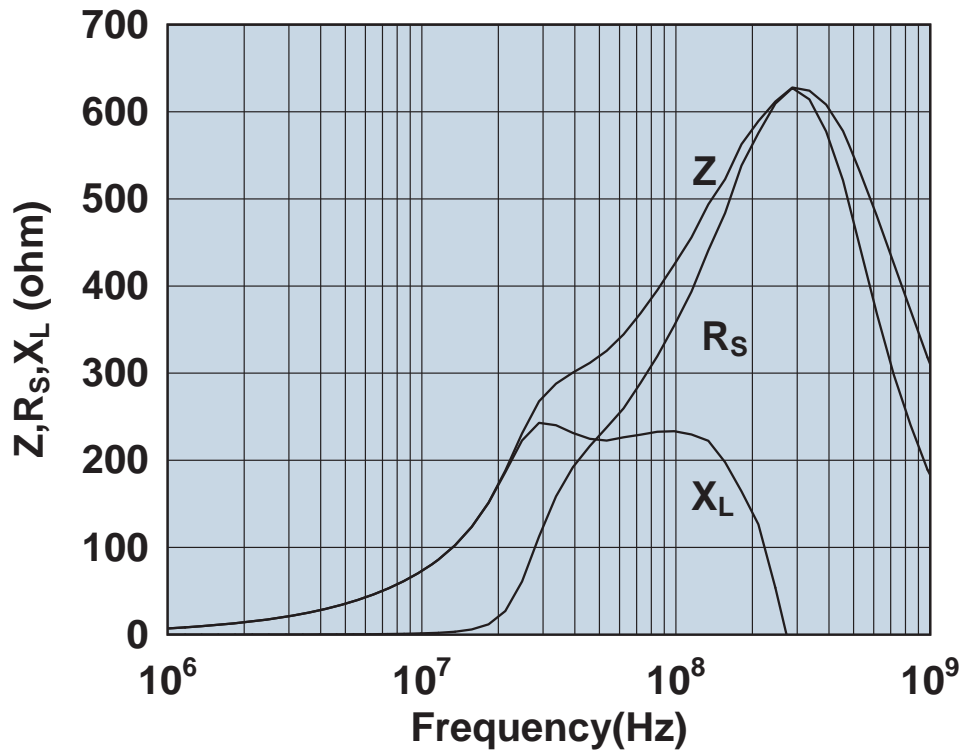

Impedance, reactance, and resistance vs. frequency.

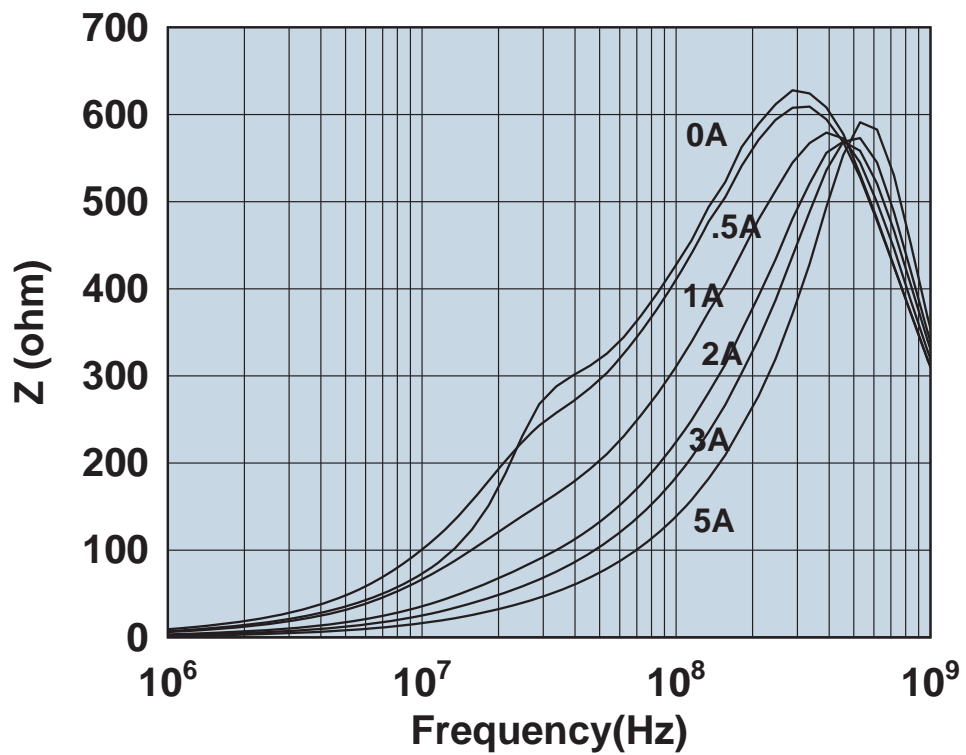

Impedance vs. frequency with dc bias.

2961666671

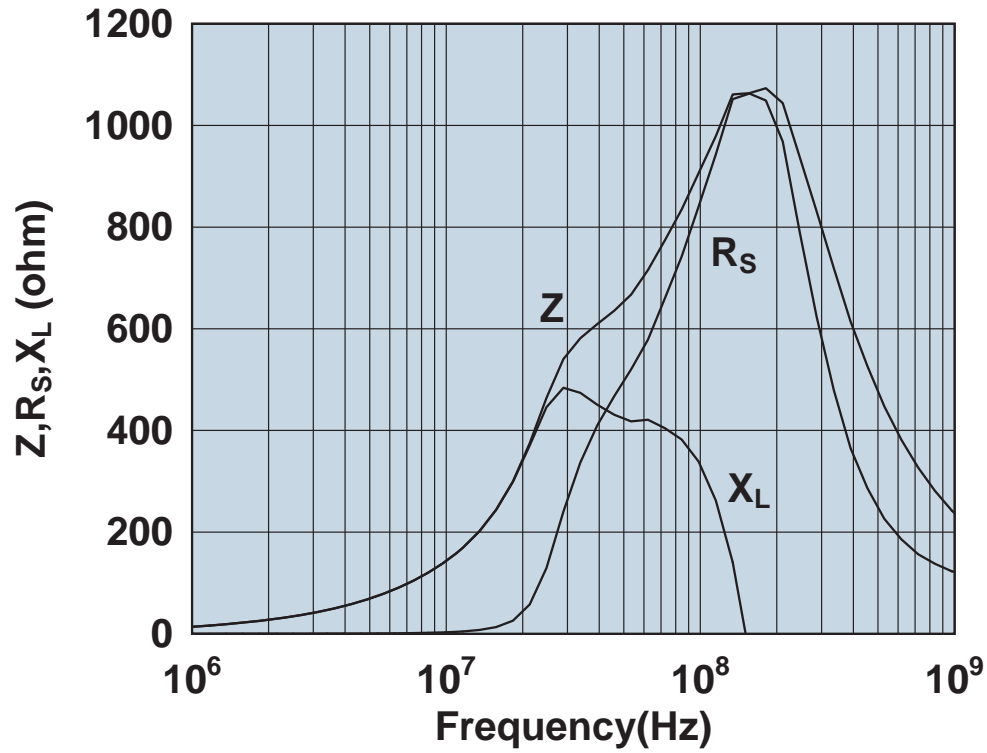

Impedance, reactance, and resistance vs. frequency.

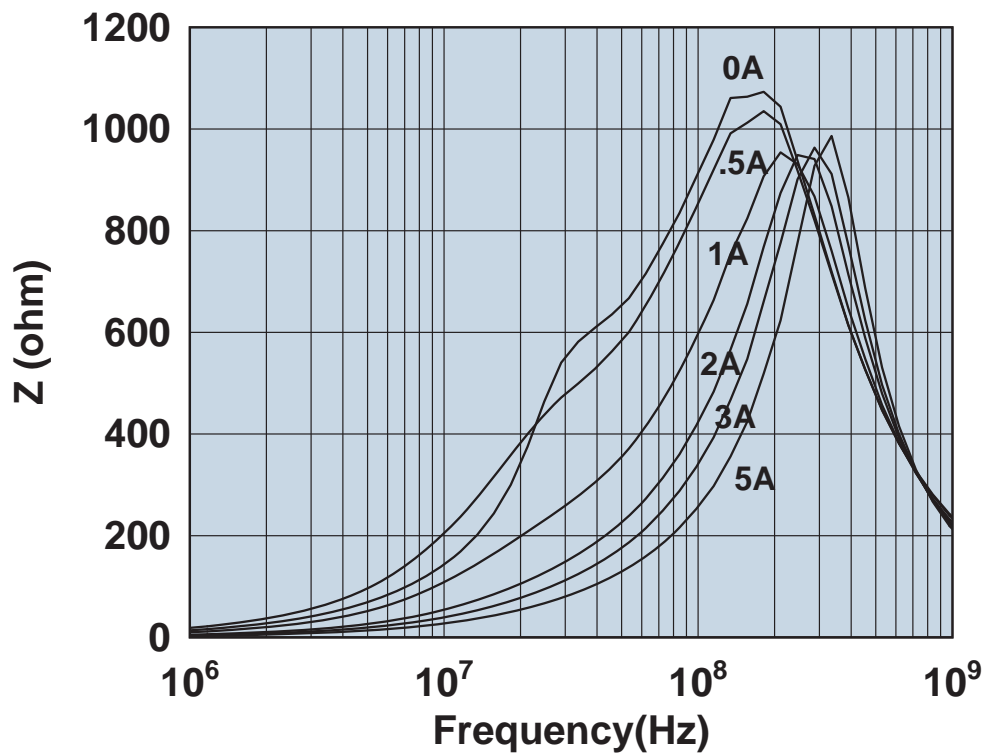

Impedance vs. frequency with dc bias.

2961666681

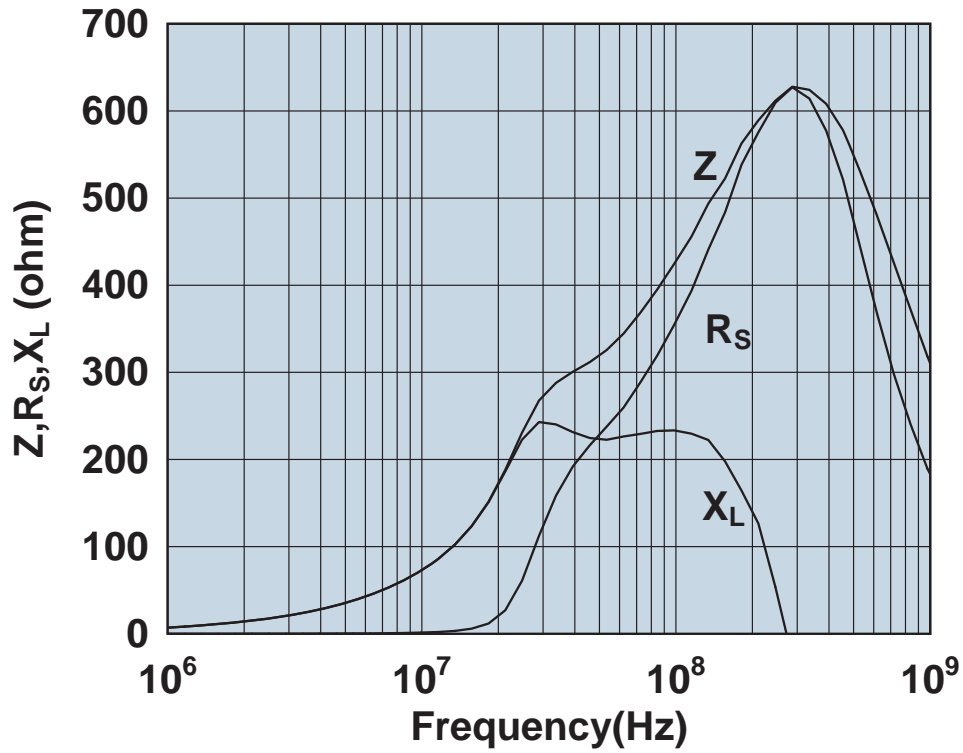

Impedance, reactance, and resistance vs. frequency.

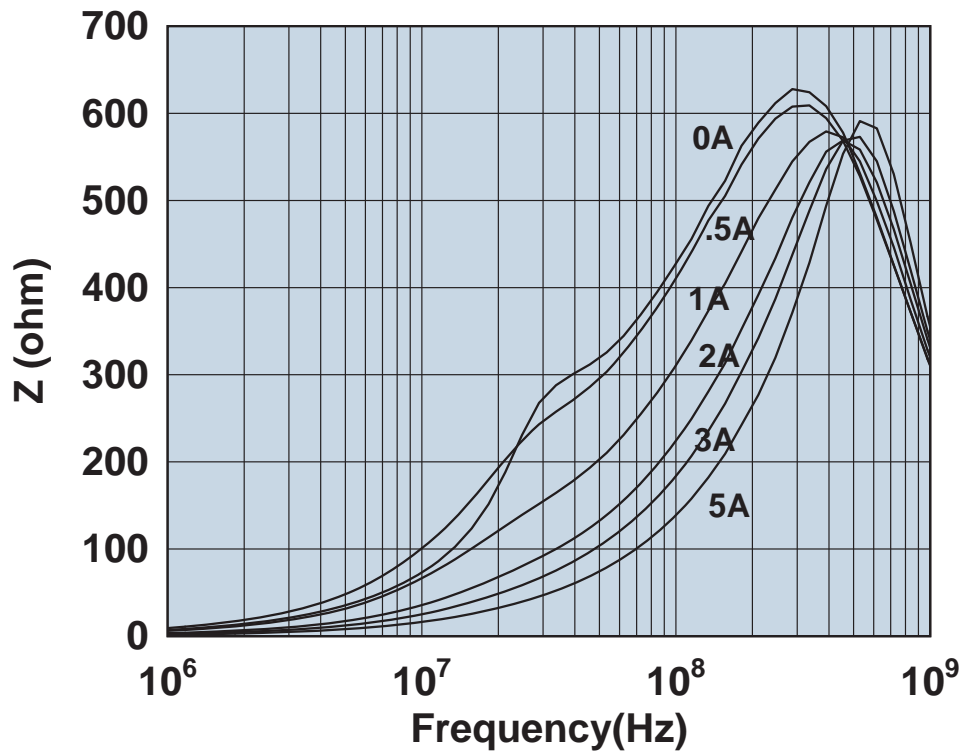

Impedance vs. frequency with dc bias.

Typical 0402 Chip Inductors (Ceramic)

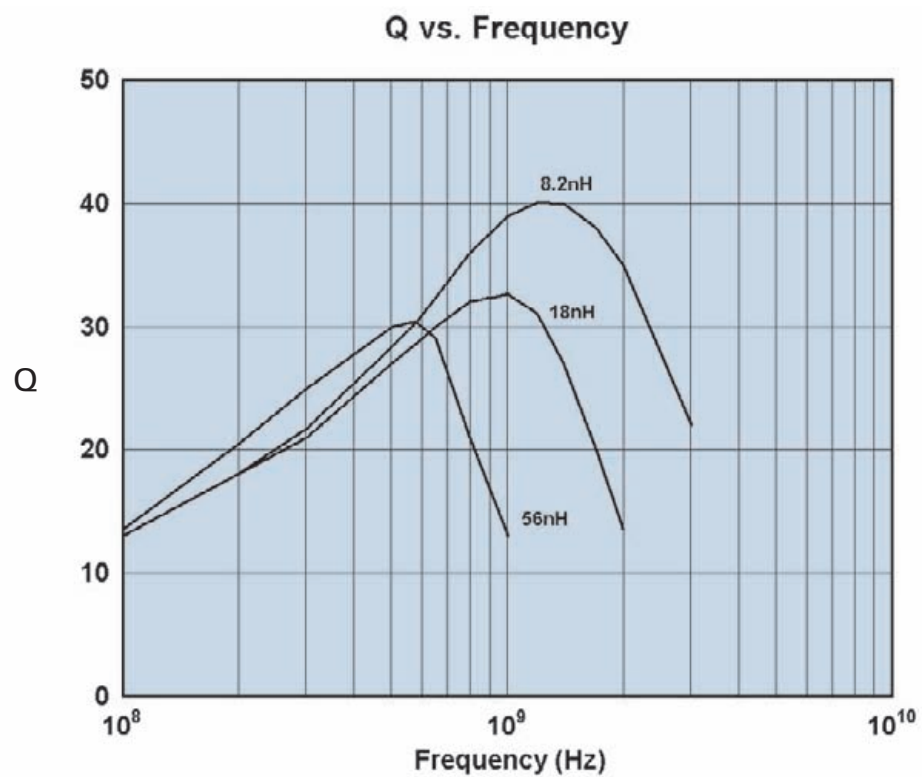
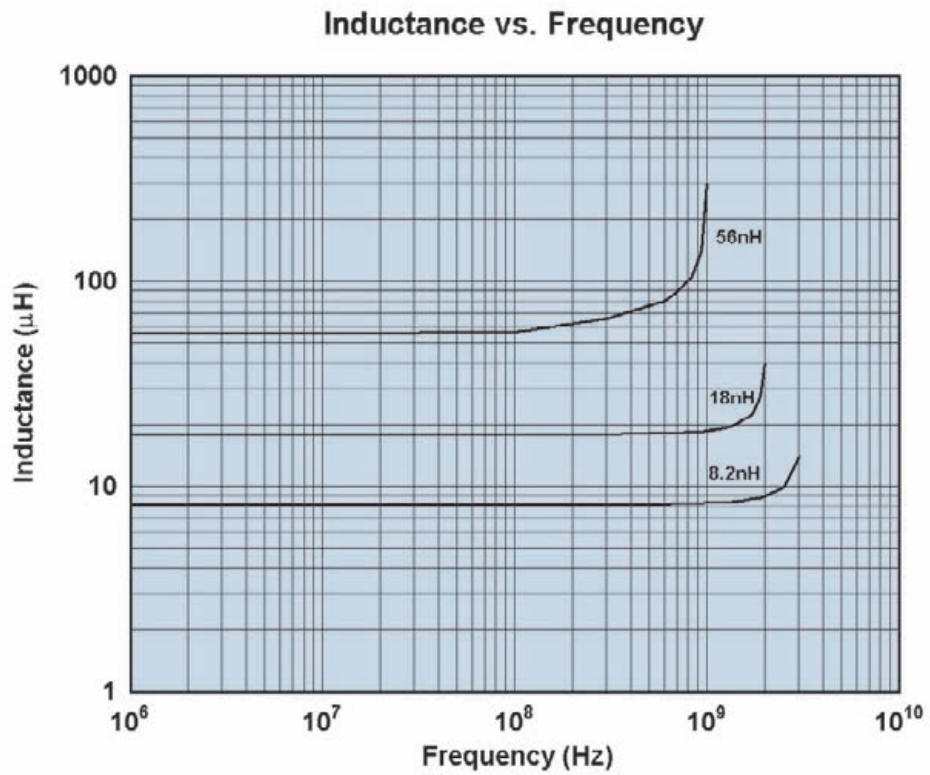

Typical 0603 Chip Inductors (Ceramic)

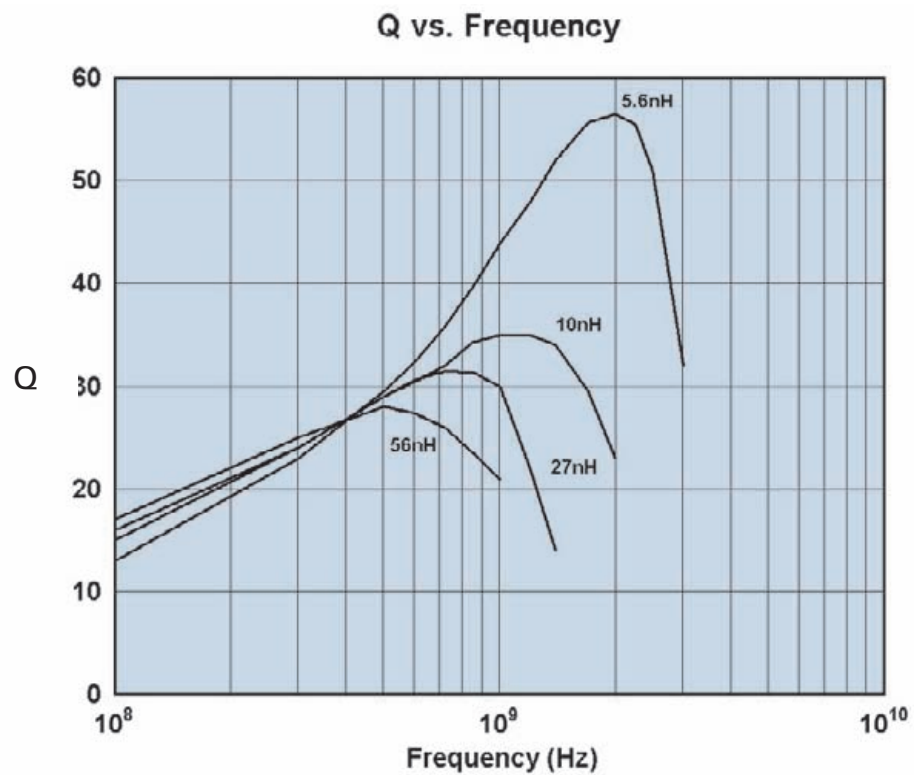
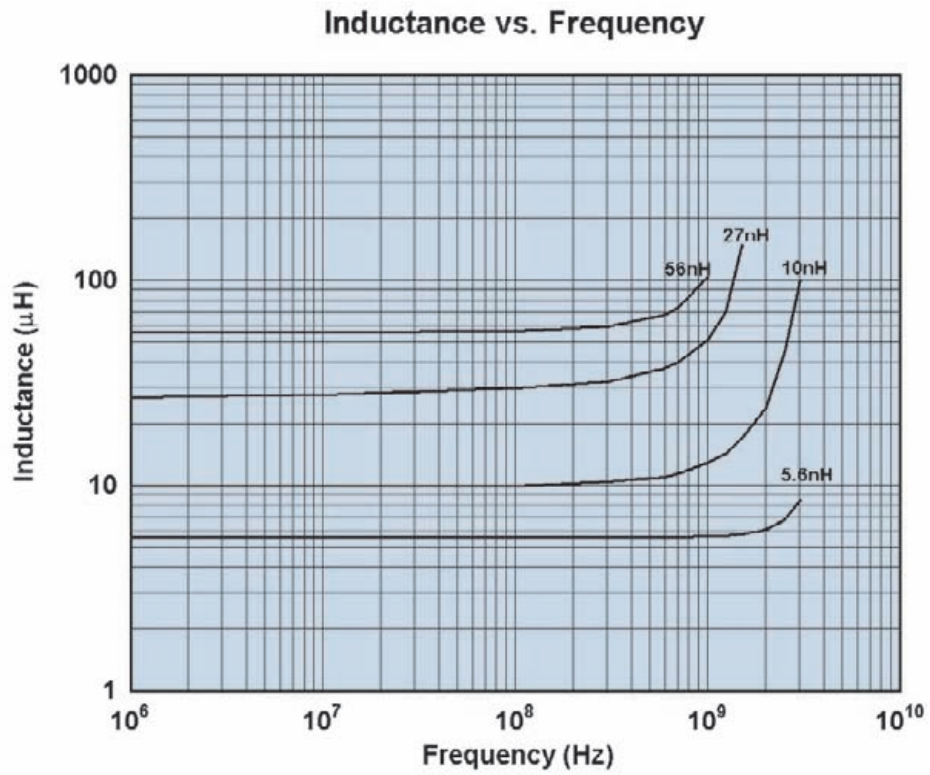

Typical 0805 Chip Inductors (Ceramic)

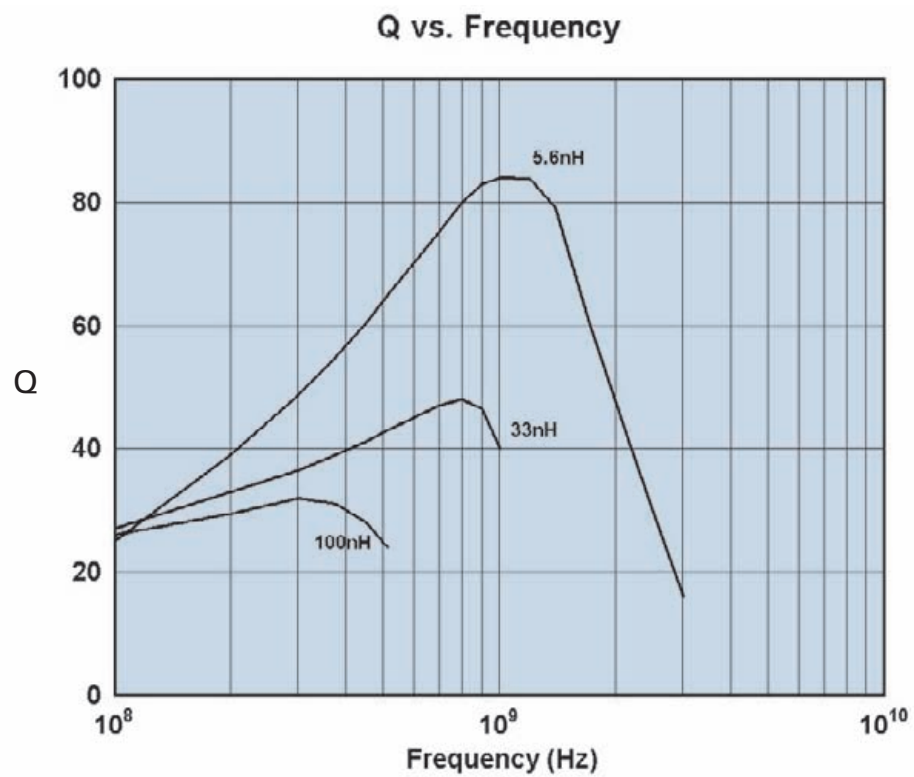
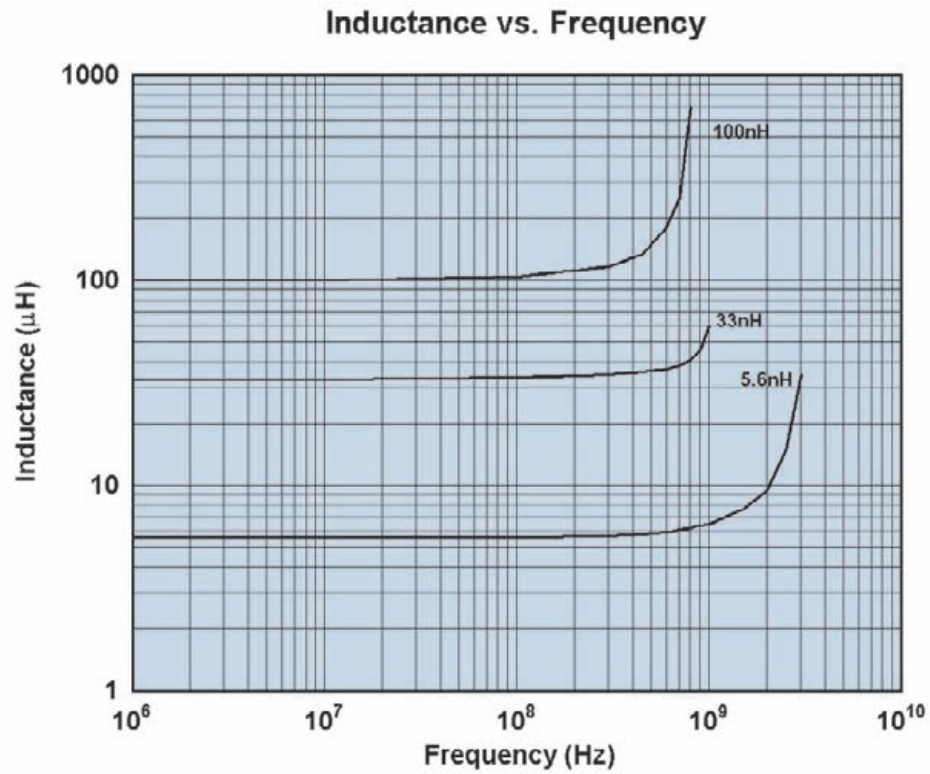

Typical 0603 Chip Inductors (Ferrite)

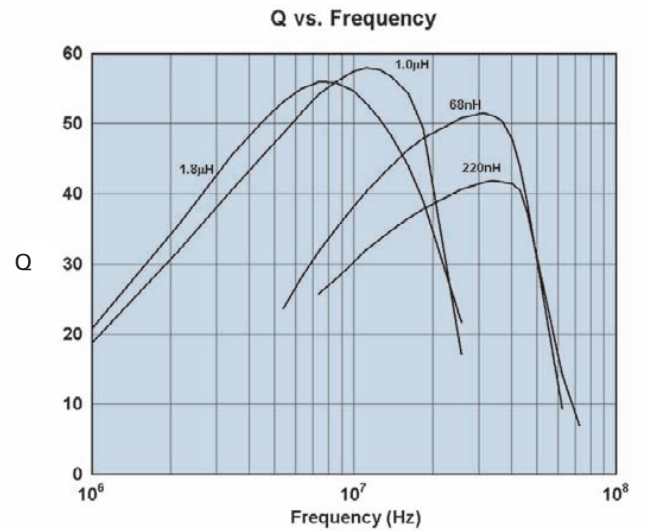
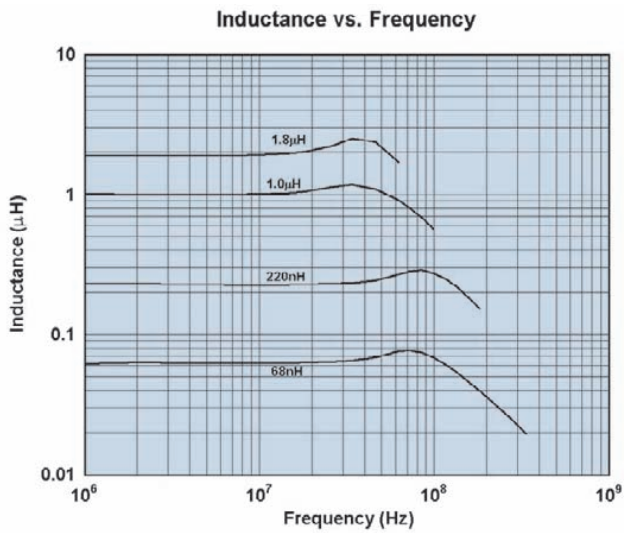
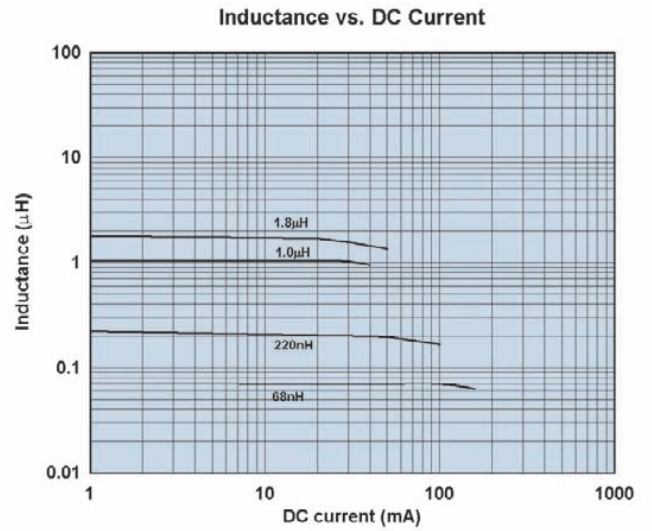
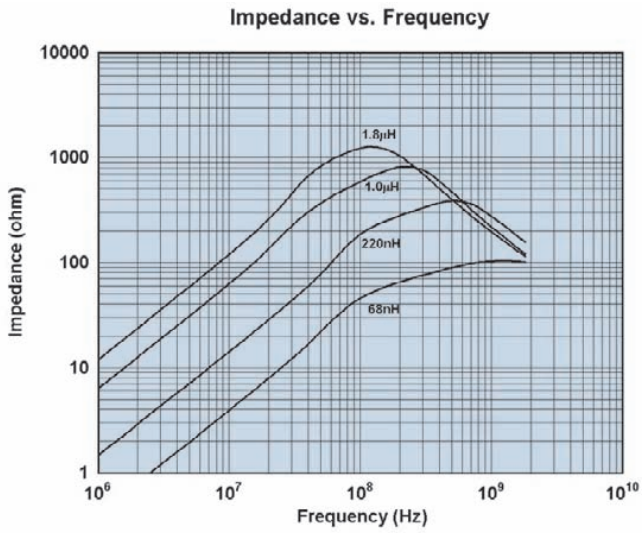

Typical 0805 Chip Inductors (Ferrite)

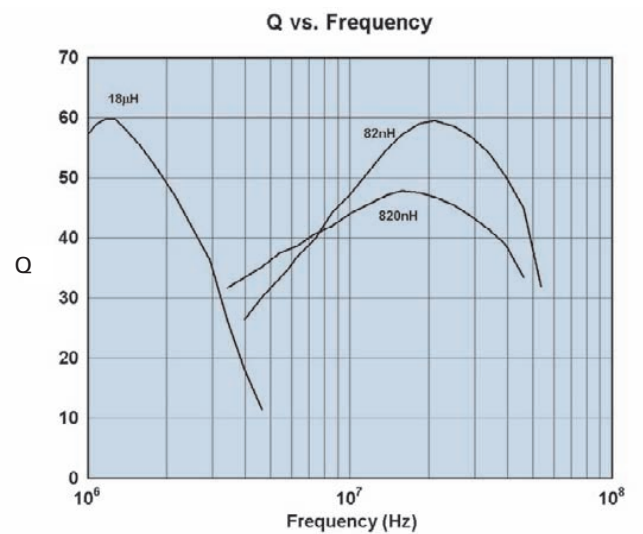
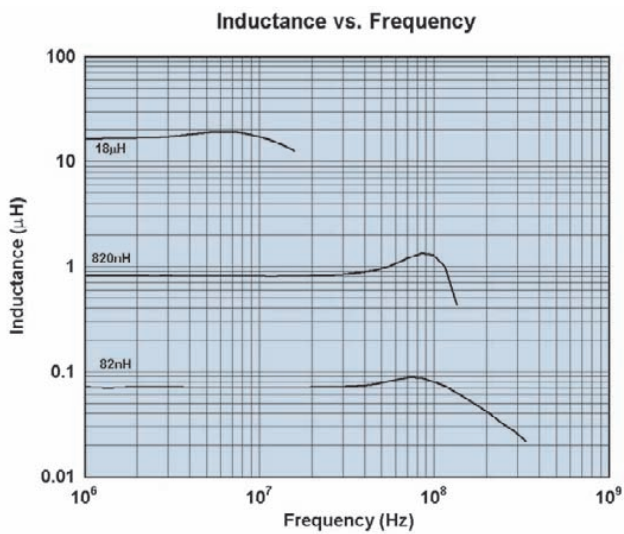
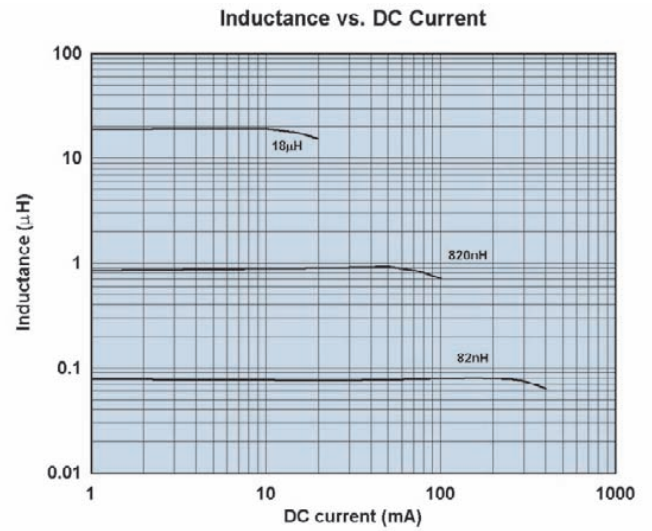
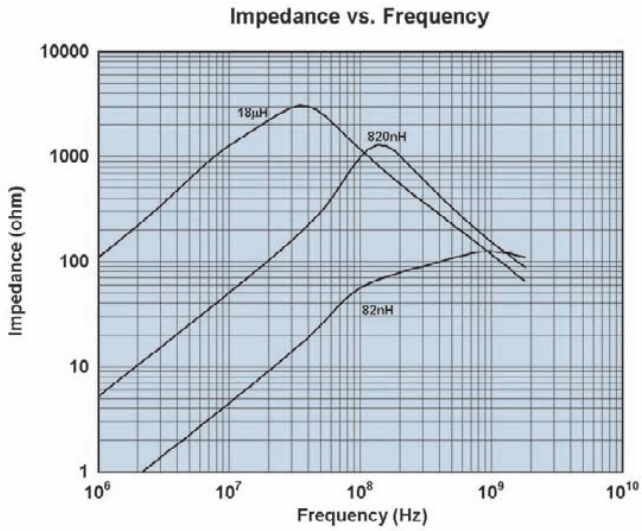

Typical 1206 Chip Inductors (Ferrite)

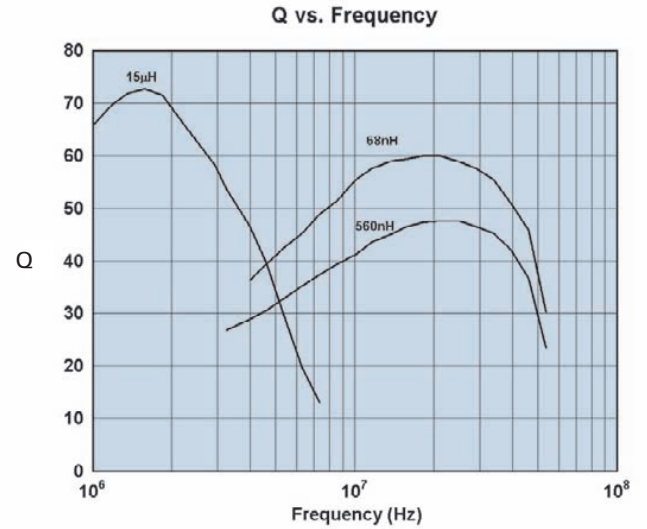
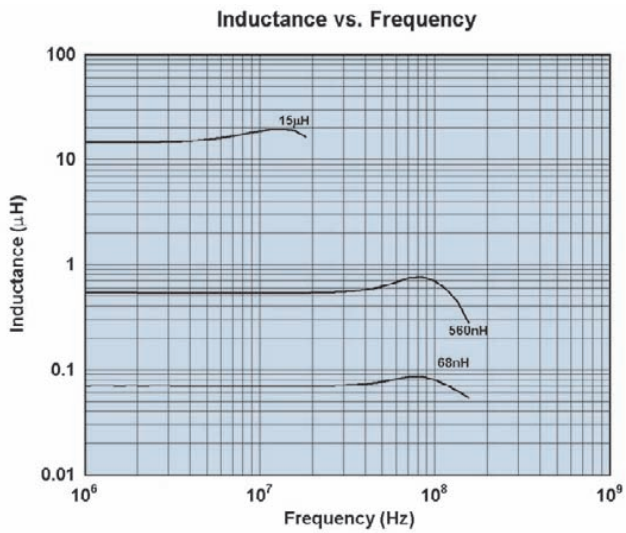
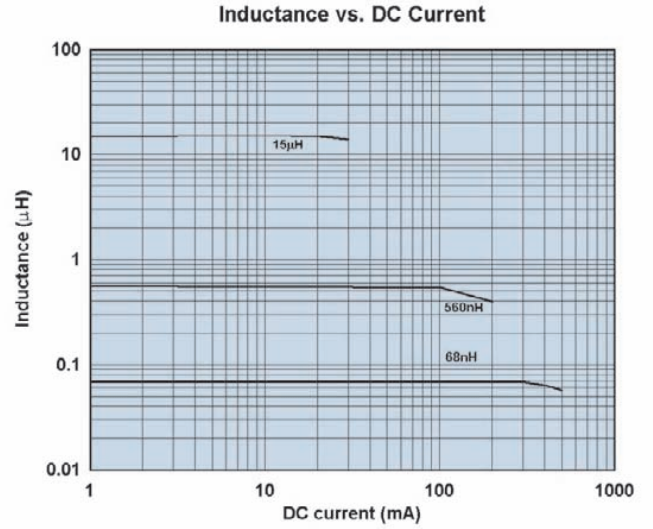
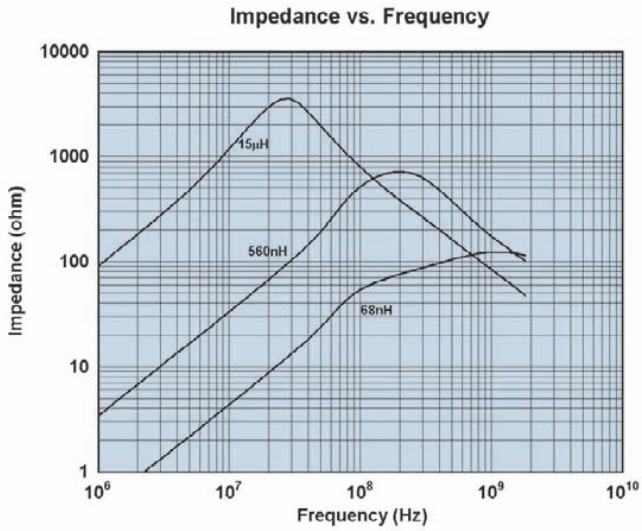

2677006302

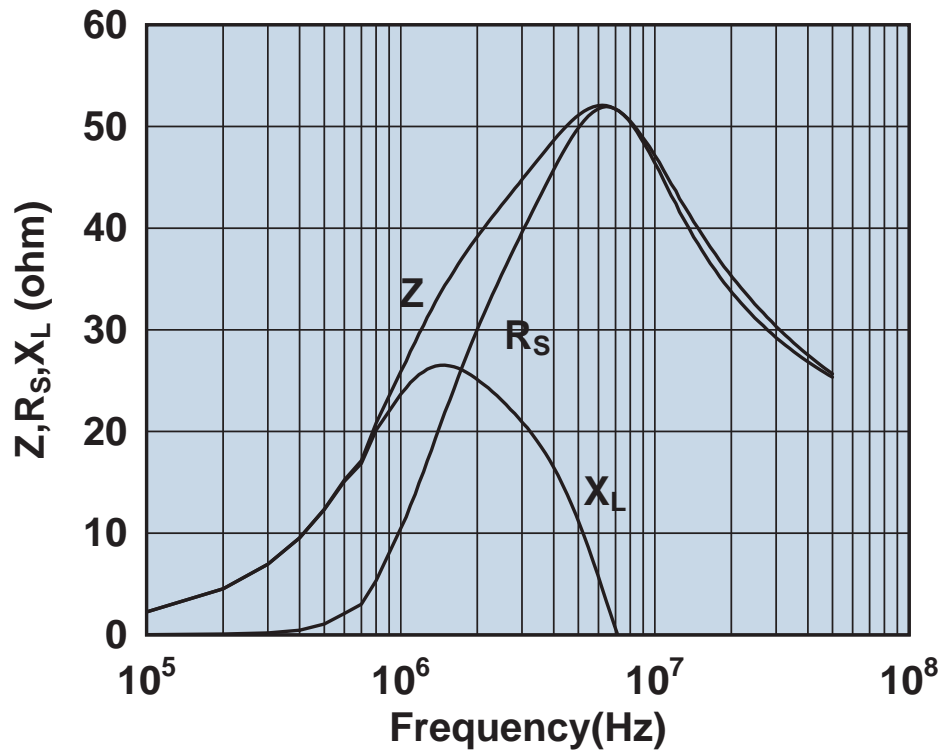

Impedance, reactance, and resistance vs. frequency.

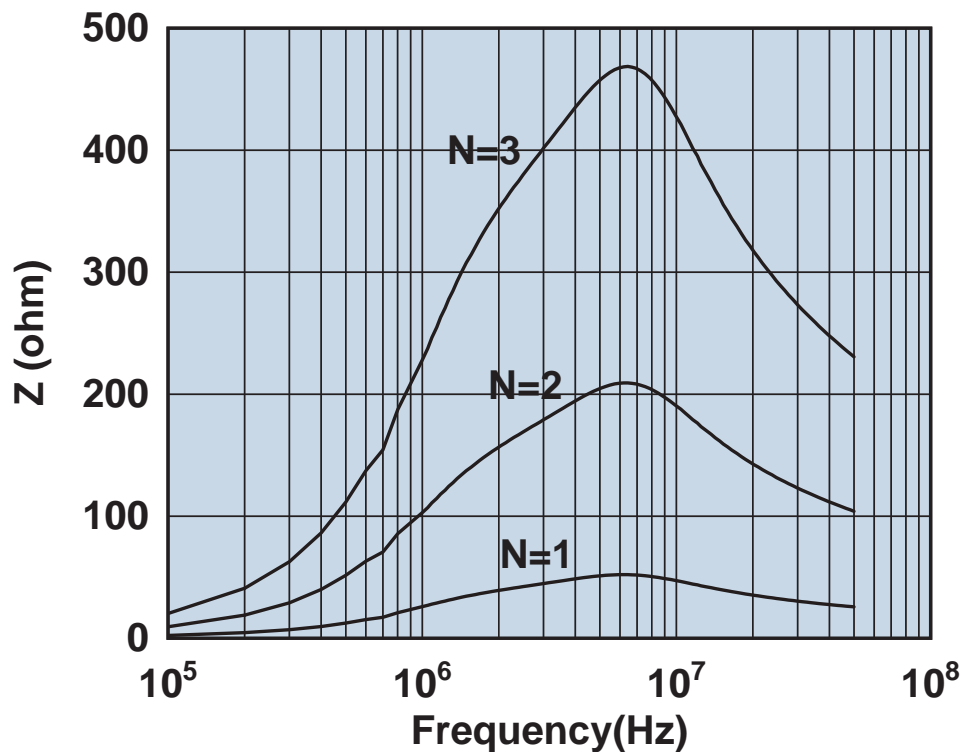

Impedance vs. frequency with one, two, and three turns.

2677102402

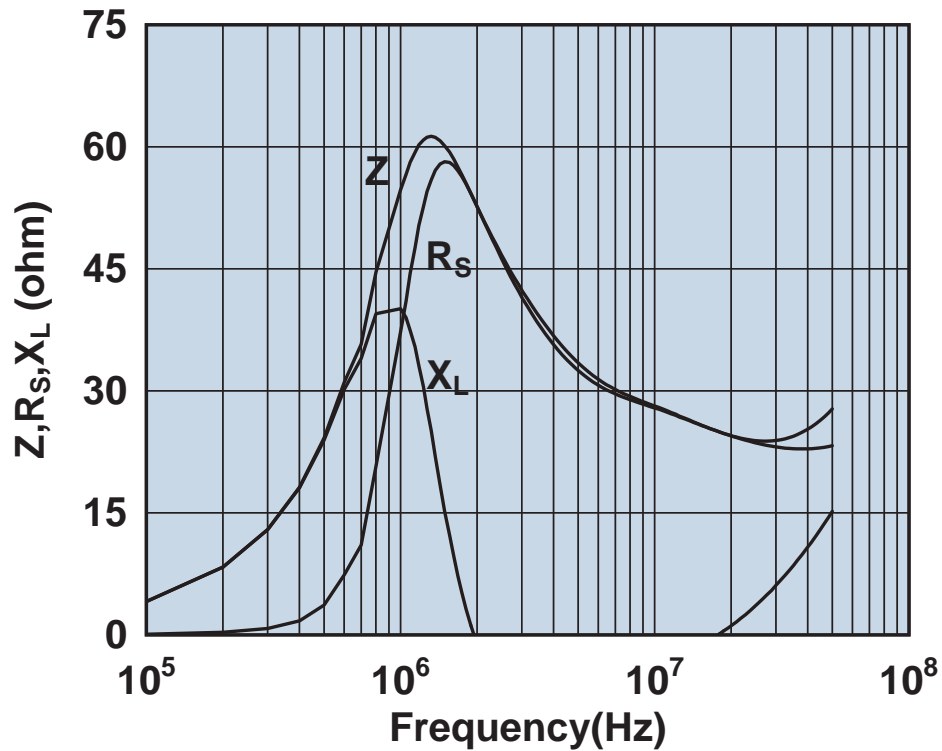

Impedance, reactance, and resistance vs. frequency.

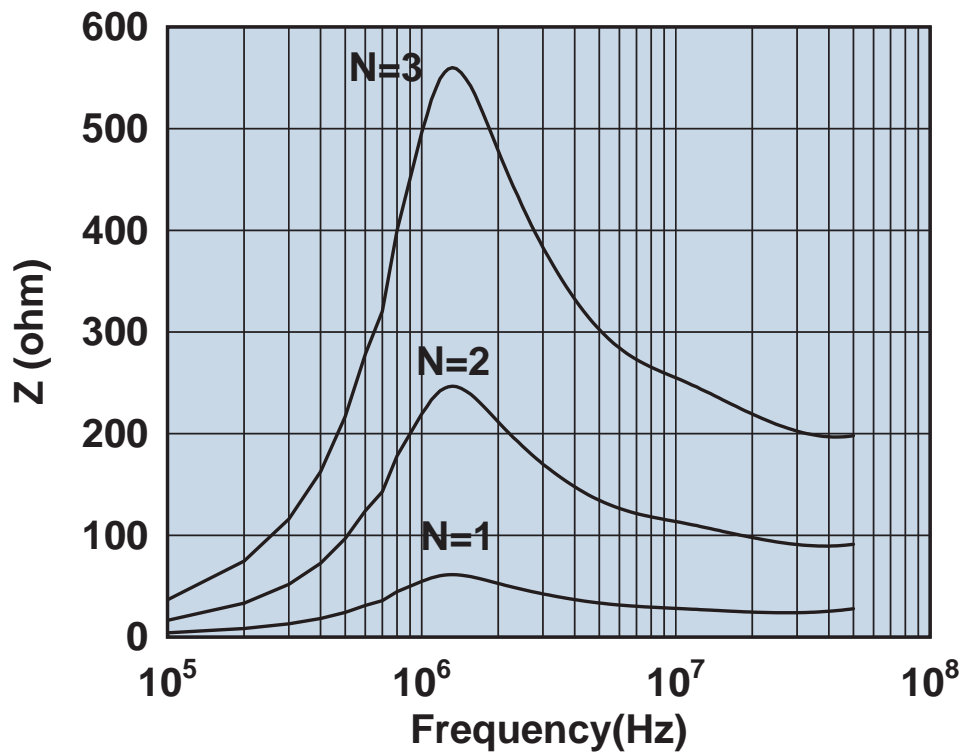

Impedance vs. frequency with one, two, and three turns.