

Ferrite for Switching Power Supplies

Original Cores

Cores

PQ20/16 to PQ50/50

LP23/8 to LP32/13

EPC10 to EPC30

EP7 to EP20

Bobbins

BPQ20/16 to BPQ50/50

BLP23/8 to BLP32/13

BEPC10 to BEPC30

BEP7 to BEP20

Accessories

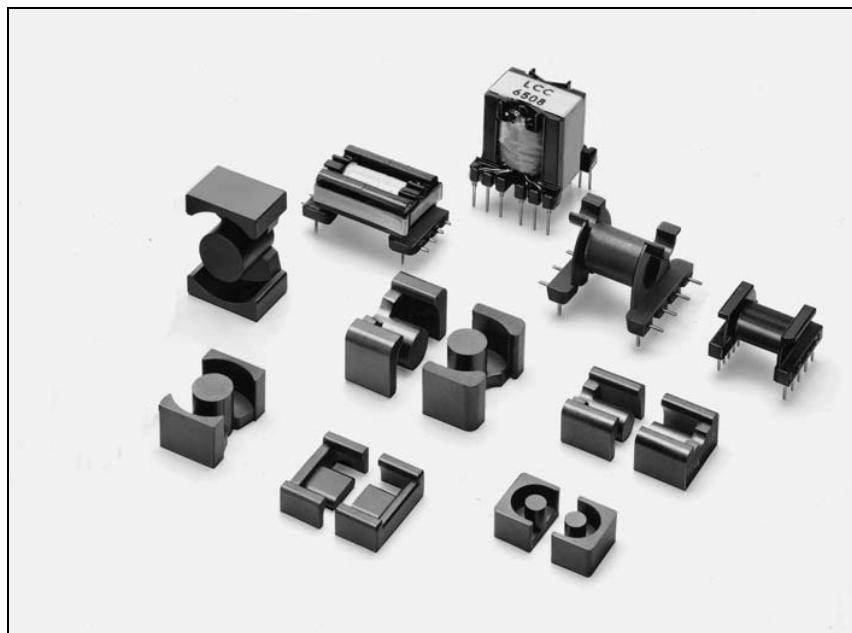

Ordering Code System

Cores

Material PC44 Size of PQ core PQ 26/25 AL-value(Z: without air gap) A400 Number of Lead Slot 2 Type 2

1: Without air gap
2: With air gap

Bobbins

Symbol of Bobbin B Size of PQ core PQ 26/25 Code of Bobbin Material 1112 Type of Terminal Pin CP Number of Terminal Pin FR Number of Section R

Accessories

Symbol of Accessory F Size of PQ core PQ 26/25 Type of Accessory A

PQ CORES



DE. PAT. 2,944,583
 DE. DES. 15,655
 EP. PAT. 26,104(DE, FR, GB, NL)
 GB. PAT. 2,035,706
 GB. DES. 990,685
 JP. U. M 1,589,580
 JP. U. M 1,621,895
 JP. U. M PUB.
 85(60)-3556 1,647,781
 JP. U. M PUB.
 86(61)-5779 1655608
 JP. DES. 580,081
 JP. DES. 649,618
 KR. U. M 23,487
 NL. PAT. 178,826
 NL. DES. 5,777
 US. PAT. 4,352,080
 US. DES. 264,959

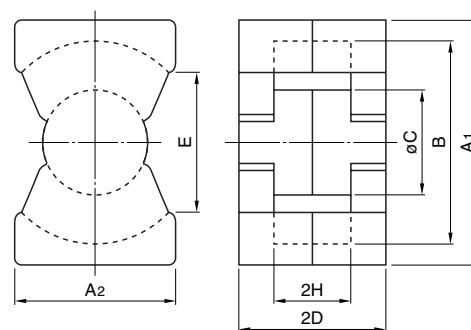

Part No.	Dimensions in mm						
	A1	A2	B	øC	2D	E min.	2H
PC44PQ20/16Z-12	20.5±0.4	14.0±0.4	18.0±0.4	8.8±0.2	16.2±0.2	12.0	10.3±0.3
PC44PQ20/20Z-12	20.5±0.4	14.0±0.4	18.0±0.4	8.8±0.2	20.2±0.2	12.0	14.3±0.3
PC50PQ20/20Z-12	20.5±0.4	14.0±0.4	18.0±0.4	8.8±0.2	20.2±0.2	12.0	14.3±0.3
PC44PQ26/20Z-12	26.5±0.45	19.0±0.45	22.5±0.45	12.0±0.2	20.15±0.25	15.5	11.5±0.3
PC44PQ26/25Z-12	26.5±0.45	19.0±0.45	22.5±0.45	12.0±0.2	24.75±0.25	15.5	16.1±0.3
PC50PQ26/25Z-12	26.5±0.45	19.0±0.45	22.5±0.45	12.0±0.2	24.75±0.25	15.5	16.1±0.3
PC44PQ32/20Z-12	32.0±0.5	22.0±0.5	27.5±0.5	13.45±0.25	20.55±0.25	19.0	11.5±0.3
PC44PQ32/30Z-12	32.0±0.5	22.0±0.5	27.5±0.5	13.45±0.25	30.35±0.25	19.0	21.3±0.3
PC44PQ35/35Z-12	35.1±0.6	26.0±0.5	32.0±0.5	14.35±0.25	34.75±0.25	23.5	25.0±0.3
PC44PQ40/40Z-12	40.5±0.9	28.0±0.6	37.0±0.6	14.9±0.3	39.75±0.25	28.0	29.5±0.3
PC44PQ50/50Z-12	50.0±0.7	32.0±0.5	44.0±0.7	20.0±0.35	49.95±0.25	31.5	36.1±0.3

Part No.	Effective parameter				Electrical characteristics			Wt (g)	Bobbin item
	C ₁ (mm ⁻¹)	A _e (mm ²)	l _e (mm)	V _e (mm ³)	AL-value (nH/N ²)*		Core loss (W) max. 100kHz, 200mT, 100°C		
					Without air gap	With air gap			
PC44PQ20/16Z-12	0.605	62	37.4	2310	3880±25%	100±5% 250±7% 400±10%	0.84	13	BPQ20/16-1114CPFR
PC44PQ20/20Z-12	0.738	62	45.4	2790	3150±25%	100±5% 250±7% 400±10%	1.02	15	BPQ20/20-1114CPFR
PC50PQ20/20Z-12	0.738	62	45.4	2790	2000±25%	100±5% 160±5% 250±7%	0.33***	15	BPQ20/20-1114CPFR
PC44PQ26/20Z-12	0.391	119	46.3	5490	6170±25%	160±5% 315±5% 630±10%	1.94	31	BPQ26/20-1112CPFR
PC44PQ26/25Z-12	0.472	118	55.5	6530	5250±25%	160±5% 315±5% 630±10%	2.32	36	BPQ26/25-1112CPFR
PC50PQ26/25Z-12	0.472	118	55.5	6530	3200±25%	100±5% 250±5% 400±7%	0.76***	36	BPQ26/25-1112CPFR
PC44PQ32/20Z-12	0.326	170	55.5	9420	7310±25%	160±5% 315±5% 630±7%	2.92	42	BPQ32/20-1112CPFR
PC44PQ32/30Z-12	0.464	161	74.6	12000	5140±25%	160±5% 315±5% 630±7%	3.92	55	BPQ32/30-1112CPFR
PC44PQ35/35Z-12	0.448	196	87.9	17300	4860±25%	160±5% 315±5% 630±7%	5.27	73	BPQ35/35-1112CPFR
PC44PQ40/40Z-12	0.508	201	102	20500	4300±25%	160±5% 315±5% 630±7%	6.56	95	BPQ40/40-1112CPFR
PC44PQ50/50Z-12	0.346	328	113	37200	6720±25%	250±5% 400±5% 630±5%	6.10**	195	BPQ50/50-1112CPFR

* AL-value: 1kHz, 0.5mA, 100Ts

** Core loss: 100kHz, 150mT, 100°C

*** Core loss: 500kHz, 50mT, 100°C

• All specifications are subject to change without notice.

PQ BOBBINS

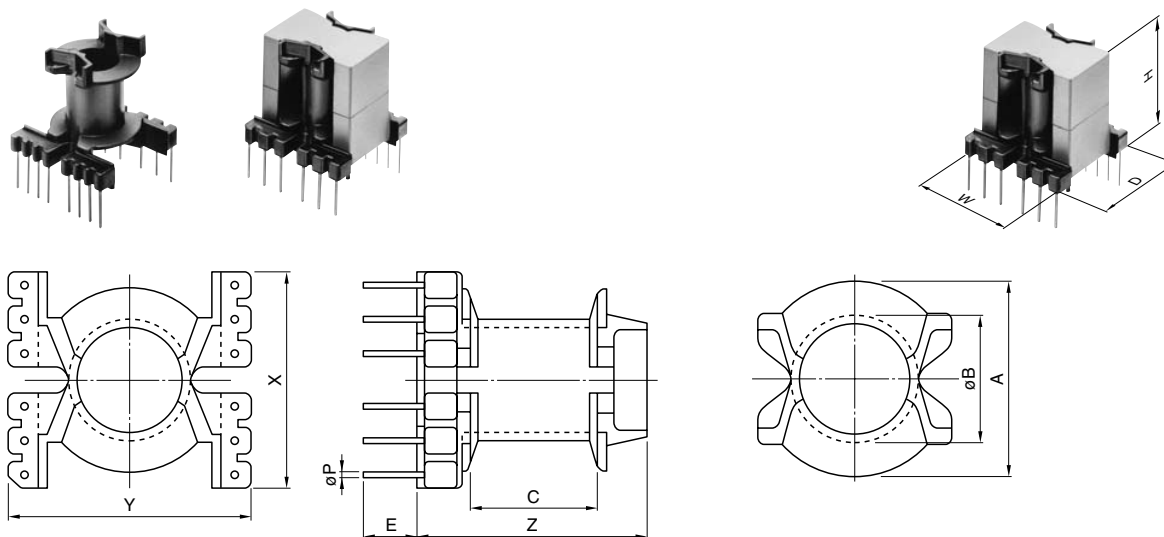

Part No.	Dimensions in mm							
	A	øB	C	E	X	Y	Z	t*
BPQ20/16-1114CPFR	17.2	10.95	8.0	6.5	23.0	23.0	18.3	0.8
BPQ20/20-1114CPFR	17.2	10.95	12.0	6.5	23.0	23.0	21.30	0.8
BPQ26/20-1112CPFR	21.6	14.3	9.2	6.5	26.5	29.3	21.5	0.8
BPQ26/25-1112CPFR	21.6	14.3	13.80	3.5	26.5	29.3	25.1	0.8
BPQ32/20-1112CPFR	26.6	16.0	8.98	7.0	32.0	34.0	22.48	0.9
BPQ32/30-1112CPFR	26.6	16.0	18.6	7.0	32.0	34.0	32.1	0.9
BPQ35/35-1112CPFR	31.1	16.9	22.50	7.5	35.0	39.0	37.4	0.9
BPQ40/40-1112CPFR	36.0	17.5	26.8	6.5	40.0	42.0	44.8	0.9
BPQ50/50-1112CPFR	42.9	23.2	30.40	10.0	51.0	51.0	52.0	1.0

Part No.	Dimensions in mm			Parameter		Wt (g)	Accessory item
	øP (mm)	Terminal pins	W D (mm) H	Aw (mm ²)	øw (mm)		
BPQ20/16-1114CPFR	0.6	14	23.0 23.0 18.3	23.4	44	2.7	FPQ20/16-A
BPQ20/20-1114CPFR	0.6	14	23.0 23.0 22.3	36.2	44	2.8	FPQ20/20-A
BPQ26/20-1112CPFR	0.8	12	26.5 29.3 21.5	30.7	56.2	4.3	FPQ26/20-A
BPQ26/25-1112CPFR	0.8	12	26.5 29.3 29.1	47.7	56.2	4.9	FPQ26/25-A
BPQ32/20-1112CPFR	1.0	12	32.0 34.0 22.5	42.9	67.1	6.6	FPQ32/20-A
BPQ32/30-1112CPFR	1.0	12	32.0 34.0 32.1	95.3	67.1	7.4	FPQ32/30-A
BPQ35/35-1112CPFR	1.0	12	35.0 39.0 37.4	154.2	75.2	11	FPQ35/35-A
BPQ40/40-1112CPFR	1.0	12	40.0 42.0 44.8	240.0	83.9	14	FPQ40/40-A
BPQ50/50-1112CPFR	1.2	12	51.0 51.0 52.0	313.0	104	22	FPQ50/50-B

UL Grade: 94V-0, Material: FR phenol, Pin material: Steel wire (Solder plated)

Maximum number of turns N that can be wound on bobbins, see section of "Maximum number of Turns on Bobbins".

* Minimum thickness of bobbin inside which core is placed, including flanges.

Connecting Pin Patterns (2.54mm/0.1 inch grids) View in mounting direction

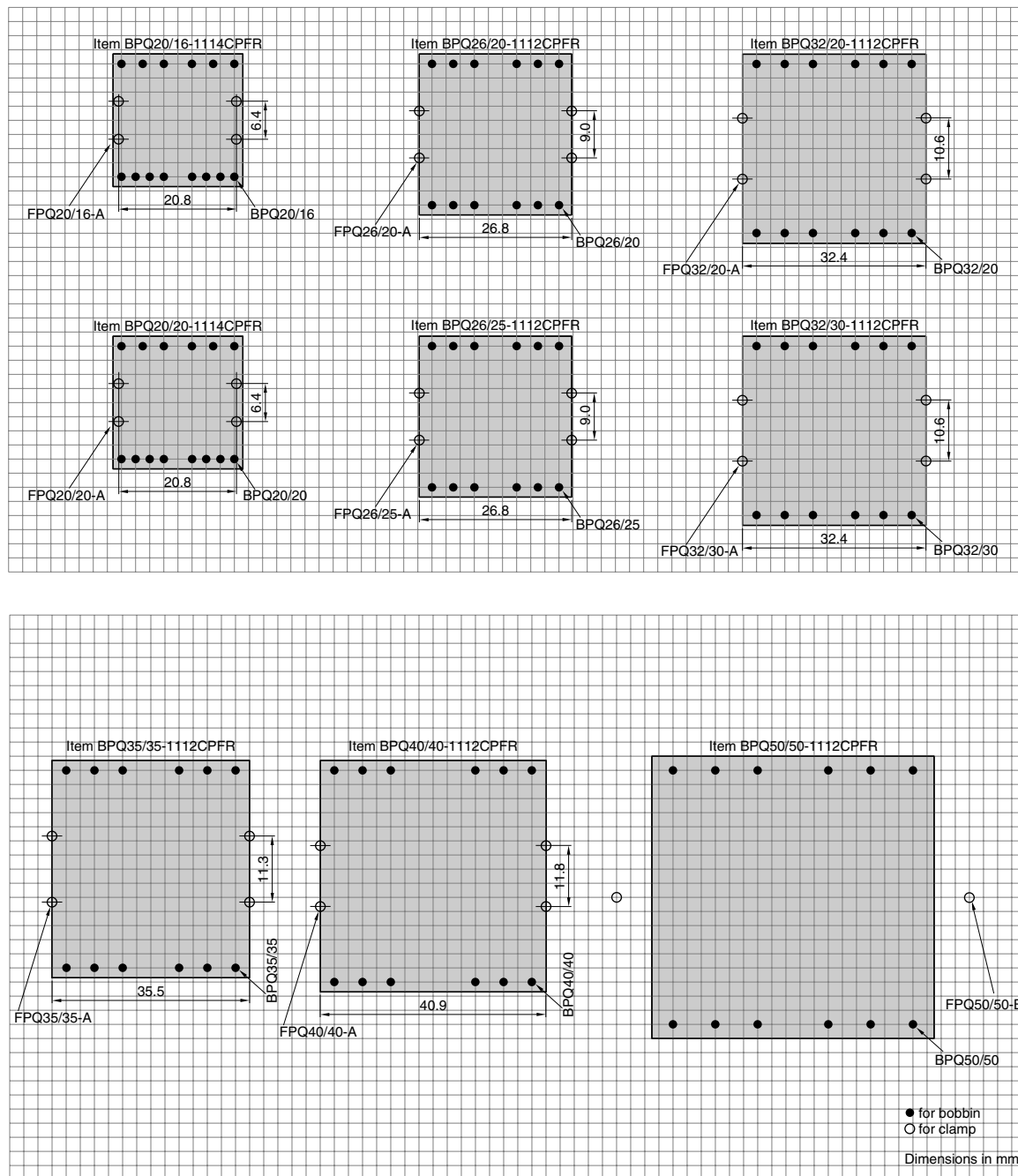

• All specifications are subject to change without notice.

LP CORES

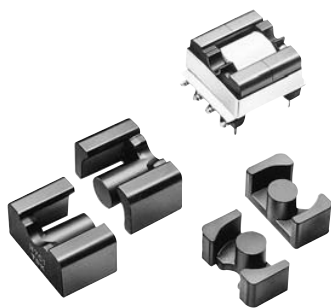

DE. DES. 19,581
 EP. PAT. 68,745(DE, FR, GB, NL)
 FR. DES. 201,586
 GB. DES. 1,007,200
 JP. U. M PRO. PUB. 82(57)-201,824
 JP. DES. 630,754
 NL. DES. 9,767
 US. PAT. 4,424,504
 US. DES. 280,810

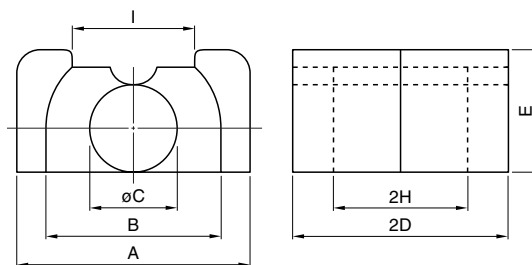

Part No.	Dimensions in mm						
	A	B	øC	2D	E	2H	I
PC44LP23/8Z-12	16.5±0.3	12.5±0.3	5.7±0.1	23.4±0.2	8.7±0.2	17.4±0.2	9.0±0.5
PC44LP22/13Z-12	25.0±0.4	19.0±0.3	8.6±0.2	22.4±0.2	12.9±0.3	16.4±0.3	13.5±0.5
PC44LP32/13Z-12	25.0±0.4	19.0±0.3	8.6±0.2	31.8±0.2	12.9±0.3	24.1±0.3	13.5±0.5

Part No.	Effective parameter				Electrical characteristics			Wt (g)	Bobbin item
	C ₁ (mm ⁻¹)	A _e (mm ²)	ℓ _e (mm)	V _e (mm ³)	AL-value (nH/N ²) [*]		Core loss (W) max. 100kHz, 200mT, 100°C		
					Without air gap	With air gap			
PC44LP23/8Z-12	1.41	31.3	44.1	1380	1600±25%	63±5% 100±7% 250±13%	0.42	9.6	BLP23/8-018PFR
PC44LP22/13Z-12	0.721	67.9	49.0	3330	3310±25%	100±5% 200±7% 400±10%	1.05	21	BLP22/13-1110CPLFR
PC44LP32/13Z-12	0.909	70.3	64.0	4500	2630±25%	100±5% 200±7% 400±10%	1.38	30	BLP32/13-1110CPLFR

^{*} AL-value: 1kHz, 0.5mA, 100Ts

LP BOBBINS

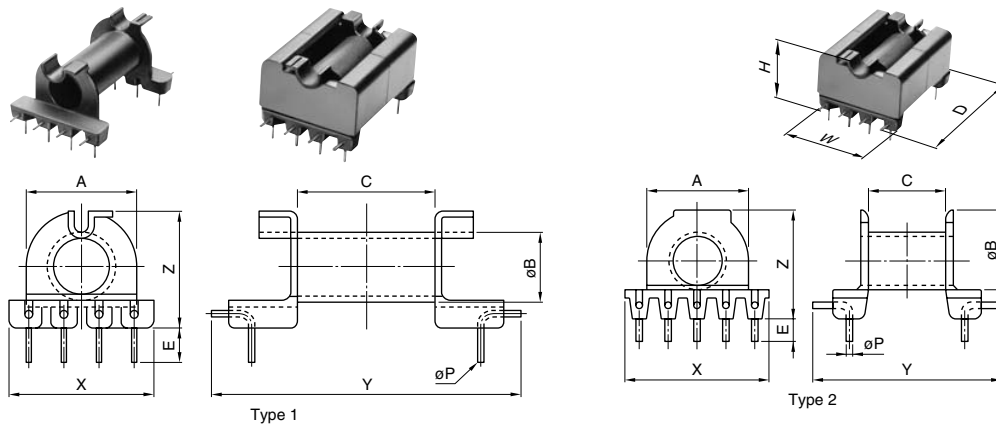

Part No.	Type	Dimensions in mm							
		A	B	C	E	X	Y	Z	t**
BLP23/8-018CPLFR	1	12.0	7.7	15.2	4.0	16.5	34.0	12.5	0.75
BLP22/13-018CPLFR	1	17.6	10.7	14.1	4.0	25.0	31.5	17.6	0.75
BLP22/13-1110CPLFR*	2	17.6	10.78	13.4	4.0	25.0	32.3	19.1	0.8
BLP32/13-018CPLFR	1	17.6	10.7	21.8	4.0	25.0	40.6	17.6	0.75
BLP32/13-1110CPLFR*	2	17.6	10.78	21.1	4.0	25.0	40.6	19.1	0.8

Part No.	Dimensions in mm			Parameter		Wt (g)	Material	Clamp item
	ϕP (mm)	Terminal pins	W D (mm) H	Aw (mm ²)	ϕw (mm)			
BLP23/8-018CPLFR	0.6	8	17.2 34.2 12.5	31.9	30.9	1.9	PPS	FLP23/8-A
BLP22/13-018CPLFR	0.8	8	27 32 17.9	51.5	45.8	3.2	PPS	FLP22/13-A
BLP22/13-1110CPLFR*	0.8	10	25.9 32.3 19.2	45.7	44.5	3.1	FR Phenol	FLP22/13-A
BLP32/13-018CPLFR	0.8	8	27 41 17.8	79.6	45.8	3.7	PPS	FLP32/13-A
BLP32/13-1110CPLFR*	0.8	10	25.9 40.6 19.2	72.0	44.5	3.7	FR Phenol	FLP32/13-A

UL Grade: 94V-0, Pin material: Phosphor bronze wire/Steel wire for "-1110-CPLFR" (Solder plated), Insulating divider's material: NOMEX®
Maximum number of turns N that can be wound on bobbins, see section of "Maximum number of Turns on Bobbins".

* Include 2 pieces of insulating dividers.

Insulating divider for BLP22/13-1110CPLFR

Part No.: ILP22/13

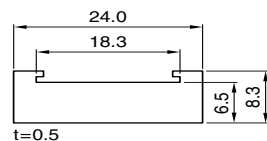

Insulating divider for BLP32/13-1110CPLFR

Part No.: ILP32/13

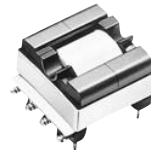
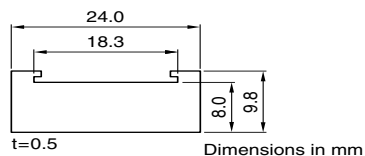

** Minimum thickness of bobbin inside which core is placed, including flanges.

PIN LAYOUT

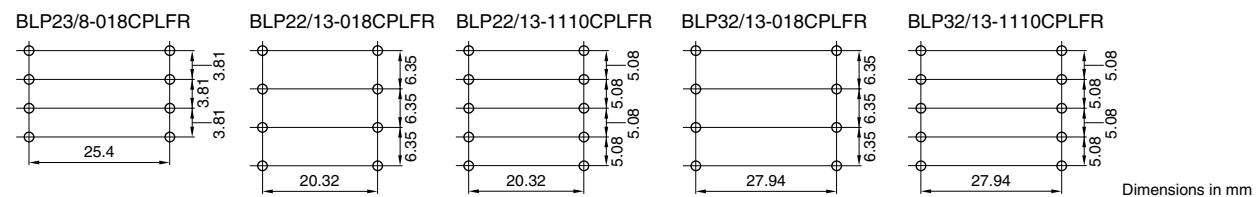

• All specifications are subject to change without notice.

EPC CORES

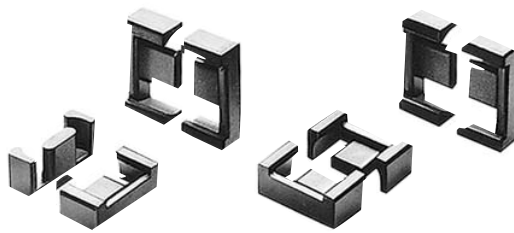

US. PAT. 4,760,366
EP. PAT. 245,083(DE, FR, GB, NL)
KS. UM 50,836
TW. UM 39,406
JP. PENDING

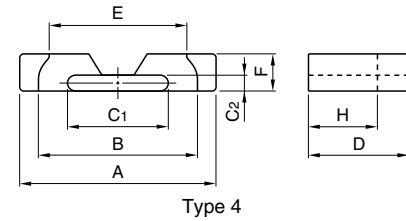
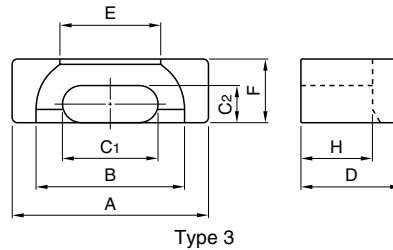
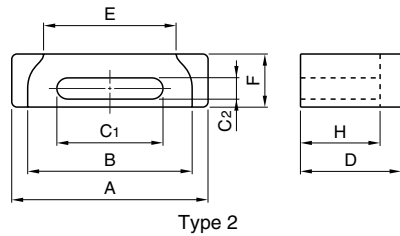
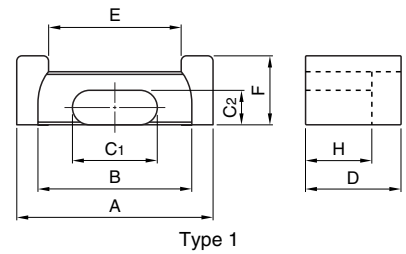

Part No.	Type	Dimensions in mm							
		A	B min.	C1	C2	D	E min.	F	H
PC44EPC10-Z PC50EPC10-Z	3	10.2±0.2	7.6	5.0±0.1	1.9±0.1	4.05±0.10	5.3	3.4±0.1	2.65±0.10
PC44EPC13-Z PC50EPC13-Z	1	13.25±0.3	10.5	5.60±0.15	2.05±0.10	6.6±0.2	8.3	4.60±0.15	4.5±0.2
PC44EPC17-Z PC50EPC17-Z	1	17.6±0.4	14.3	7.70±0.15	2.8±0.1	8.55±0.20	11.5	6.00±0.15	6.05±0.20
PC44EPC19-Z PC50EPC19-Z	1	19.1±0.4	15.8	8.50±0.15	2.5±0.1	9.75±0.20	13.1	6.00±0.15	7.25±0.20
PC44EPC25-Z PC50EPC25-Z	1	25.1±0.5	20.65	11.5±0.2	4.0±0.1	12.5±0.2	17.1	8.0±0.2	9.0±0.3
PC44EPC25B-Z PC50EPC25B-Z	2	25.1±0.5	20.4	13.8±0.2	2.50±0.15	11.43±0.15	16.5	6.5±0.2	8.78±0.15
PC44EPC27-Z PC50EPC27-Z	1	27.1±0.5	21.6	13.0±0.3	4.0±0.1	16.0±0.2	18.5	8.0±0.2	12.0±0.3
PC44EPC27N-Z	4	27.0±0.4	20.8	13.85±0.15	2.2±0.1	13.0±0.1	19.0	5.1±0.1	8.5±0.1
PC44EPC30-Z PC50EPC30-Z	1	30.1±0.5	23.6	15.0±0.3	4.0±0.1	17.5±0.2	20.0	8.0±0.2	13.0±0.3

Part No.	Effective parameter				Electrical characteristics			Wt (g)	Bobbin item
	C1 (mm ⁻¹)	Ae (mm ²)	le (mm)	Ve (mm ³)	AL-value (nH/N ²)*		Core loss (W) max. 100kHz, 200mT, 100°C		
					Without air gap	With air gap			
PC44EPC10-Z PC50EPC10-Z	1.89	9.39	17.8	167	1000±25% 660±25%	40±7% 63±10%	0.072 0.025**	1.1	BEPC10-118GAFR
PC44EPC13-Z PC50EPC13-Z	2.45	12.5	30.6	382	870±25% 560±25%	40±4% 63±5%	0.14 0.039**	2.1	BEPC13-1110CPHFR BEPC13-1110GAFR
PC44EPC17-Z PC50EPC17-Z	1.76	22.8	40.2	917	1150±25% 740±25%	80±4% 125±5%	0.35 0.1**	4.5	BEPC17-1110CPHFR BEPC17-119GAFR
PC44EPC19-Z PC50EPC19-Z	2.03	22.7	46.1	1050	940±25% 680±25%	80±4% 125±5%	0.4 0.12**	5.3	BEPC19-1111CPHFR BEPC19-1110GAFR
PC44EPC25-Z PC50EPC25-Z	1.28	46.4	59.2	2750	1560±25% 1080±25%	125±5% 200±7%	1.11 0.32**	13	BEPC25-1111CPHFR
PC44EPC25B-Z PC50EPC25B-Z	1.39	33.3	46.2	1540	1560±25% 1080±25%	80±5% 125±7%	0.65 0.22**	11	BEPC25B-1111GAFR
PC44EPC27-Z PC50EPC27-Z	1.34	54.6	73.1	4000	1540±25% 1030±25%	125±5% 200±7%	1.56 0.46**	18	BEPC27-1111CPHFR
PC44EPC27N-Z	1.70	33.0	55.9	1840	1400±25%	80±5% 125±7%	0.73	10	BEPC27N-1114CPHFR
PC44EPC30-Z PC50EPC30-Z	1.34	61.0	81.6	4980	1570±25% 1060±25%	125±5% 200±7%	2.03 0.58**	23	BEPC30-1112CPHFR

* AL-value: 1kHz, 0.5mA, 100Ts

** Core loss: 500kHz, 50mT, 100°C

• All specifications are subject to change without notice.

EPC BOBBINS

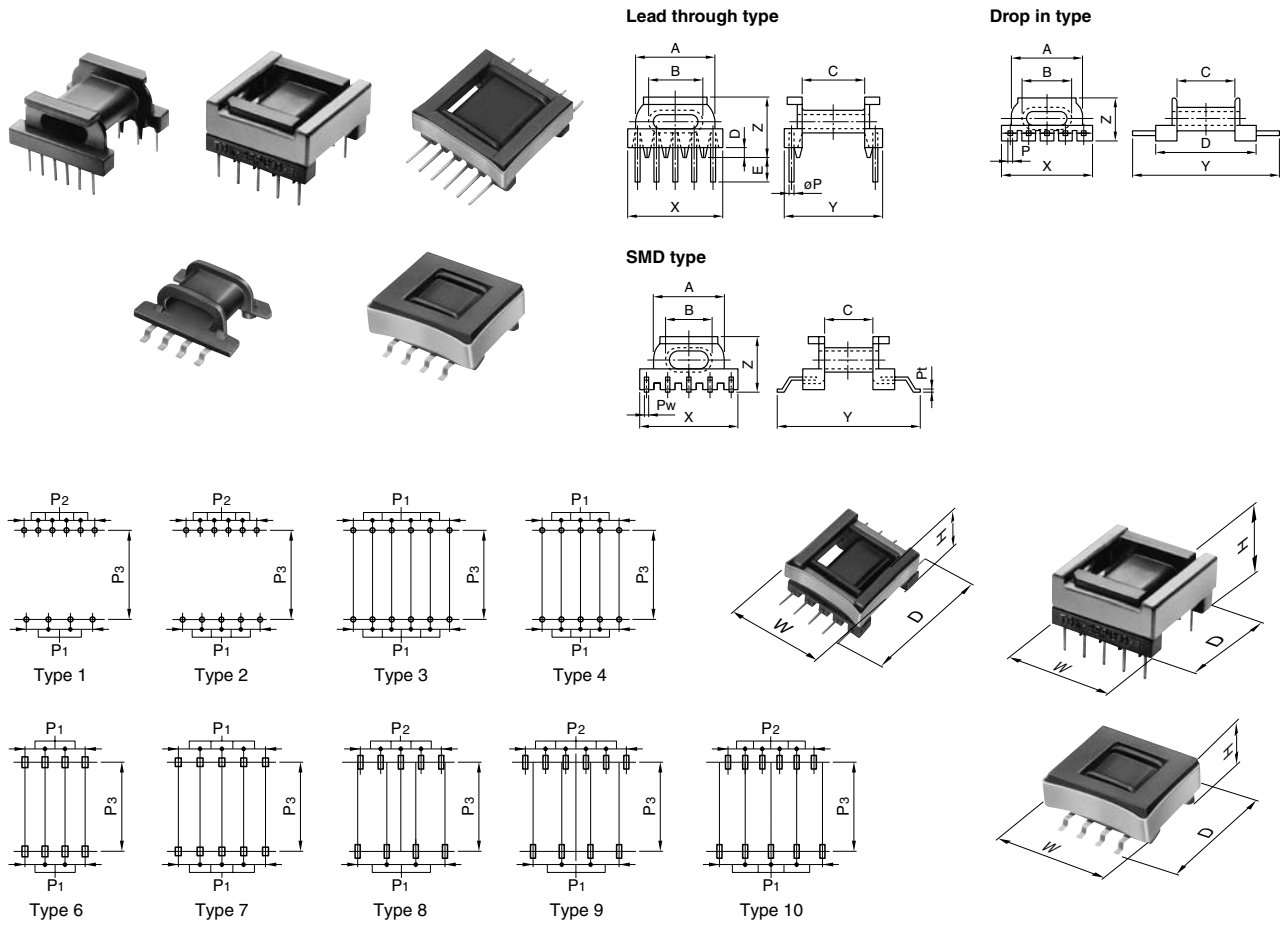

• All specifications are subject to change without notice.

EPC BOBBINS

Lead through type

Part No.	Dimensions in mm								
	A	B	C	D	E	X	Y	Z	t*
BEPC13-1110CPHFR	10.23	6.93	6.88	0.9	2.5	13.2	13.2	7.5	0.5
BEPC17-1110CPHFR	14.07	9.88	9.55	2.5	4.5	17.2	17.5	11.9	0.9
BEPC19-1111CPHFR	15.58	10.68	12.04	2.5	4.5	18.7	19.0	11.9	0.9
BEPC25-1111CPHFR	20.39	13.73	14.7	3.0	4.5	25.0	25.0	16.0	0.9
BEPC27-1111CPHFR	21.33	15.33	20.7	3.0	4.5	27.0	32.0	16.0	0.9
BEPC27N-1114CPHFR	20.5	15.9	14.10	0.3	3.5	28.2	29.8	8.7	0.8
BEPC30-1112CPHFR	23.33	17.33	22.7	3.0	4.5	30.0	35.0	16.0	0.9

Part No.	Dimensions in mm						Parameter		Wt (g)	Connecting pin pattern
	øP (mm)	P1 (mm)	P2 (mm)	P3 (mm)	Terminal pins	W D (mm) H	Aw (mm ²)	ø w (mm)		
BEPC13-1110CPHFR	□0.49	2.5	—	10.5	10	13.9 14.8 7.7	11.2	23.0	0.57	Type 4
BEPC17-1110CPHFR	□0.49	3.75	2.5	15.0	10	18.2 19.1 12.1	20.1	32.1	1.5	Type 1
BEPC19-1111CPHFR	□0.49	3.75	2.5	16.25	11	20.0 21.5 12.1	29.3	34.4	1.6	Type 2
BEPC25-1111CPHFR	0.8	5.0	3.75	20.0	11	26.1 27.0 16.2	54.4	45.0	3.9	Type 2
BEPC27-1111CPHFR	0.8	5.0	3.75	27.5	11	28.1 34.0 16.2	62.1	47.2	4.7	Type 2
BEPC27N-1114CPHFR	0.8	3.75	—	25.0	14	29.0 36.5 9.0	32.4	43.7	3.1	Type 3
BEPC30-1112CPHFR	1.0	5.1	—	30.0	12	31.1 37.0 16.2	68.1	51.1	6.0	Type 3

UL Grade: 94V-0, Material: FR phenol, Pin material: Steel wire (Solder plated), Phosphor bronze (Solder plated) for BEPC25B-1111GAFR only. Maximum number of turns N that can be wound on bobbins, see section of "Maximum number of Turns on Bobbins".

* Minimum thickness of bobbin inside which core is placed, including flanges.

SMD type

Part No.	Dimensions in mm								
	A	B	C	D	E	X	Y	Z	t*
BEPC10-118GAFR	7.5	5.95	3.9	—	—	10.8	11.5	4.85	0.35
BEPC13-1110GAFR	10.3	6.93	6.9	—	—	14.0	20.4	7.02	0.5
BEPC17-119GAFR	14.1	9.9	9.6	—	—	17.5	23.0	9.8	0.8
BEPC19-1110GAFR	15.4	10.7	12.0	—	—	20.0	25.0	9.75	0.8
BEPC25B-1111GAFR	20.1	15.7	14.7	—	—	25.0	28.7	9.8	0.8

Part No.	Dimensions in mm						Parameter		Wt (g)	Connecting pin pattern
	Pt×Pw (mm)	P1 (mm)	P2 (mm)	P3 (mm)	Terminal pins	W D (mm) H	Aw (mm ²)	ø w (mm)		
BEPC10-118GAFR	0.3×0.5	2.0	—	10.8	8	11.0 11.7 5.2	3.2	17.5	0.14	Type 6
BEPC13-1110GAFR	0.4×0.7	3.0	—	18.5	10	14.2 20.6 7.3	11.6	23.1	0.6	Type 7
BEPC17-119GAFR	0.4×0.7	5.0	3.5	21.8	9	18.2 23.2 9.9	20.1	32.1	1.1	Type 8
BEPC19-1110GAFR	0.4×0.7	5.0	3.5	23.8	10	20.2 25.2 9.9	28.2	34.4	1.3	Type 9
BEPC25B-1111GAFR	0.4×0.8	5.0	3.5	27.5	11	26.1 28.9 9.9	32.3	44.3	1.9	Type 10

UL Grade: 94V-0, Material: FR phenol, Pin material: Steel wire (Solder plated), Phosphor bronze (Solder plated) for BEPC25B-1111GAFR only. Maximum number of turns N that can be wound on bobbins, see section of "Maximum number of Turns on Bobbins".

* Minimum thickness of bobbin inside which core is placed, including flanges.

• All specifications are subject to change without notice.

EPC BOBBINS

Drop in type

Part No.	Dimensions in mm								
	A	B	C	D	E	X	Y	Z	t*
BEPC19-1110SAFR	15.6	10.7	12.0	18.6	—	20.0	26.0	9.55	0.8
BEPC25B-1111SFR	20.1	15.7	14.7	21.7	—	25.0	37.7	9.60	0.8

Part No.	Dimensions in mm					Parameter			Wt (g)	Connecting pin pattern
	Pt×Pw (mm)	P ₁ (mm)	P ₂ (mm)	P ₃ (mm)	Terminal pins	W D (mm) H	Aw (mm ²)	∅w (mm)		
BEPC19-1110SAFR	0.4×0.7	5.0	3.5	22.3	10	20.2 26.2 9.8	28.2	34.4	1.3	Type 9
BEPC25B-1111SFR	0.4×0.7	5.0	3.5	29.7	11	26.0 37.9 9.5	30.9	50.5	2.1	Type 10

UL Grade: 94V-0, Material: FR phenol, Pin material: Steel wire (Solder plated), Phosphor bronze (Solder plated) for BEPC25B-1111GAFR only.
Maximum number of turns N that can be wound on bobbins, see section of "Maximum number of Turns on Bobbins".

* Minimum thickness of bobbin inside which core is placed, including flanges.

EPC ACCESSORIES

Part No.	Dimensions in mm							Material
	A	B	C	D	E	t		
FEPC-10-A	10.8	2.8	1.5	8.0	0.8	0.2	Stainless steel	
FEPC-13-A	13.75	2.8	2.9	14.75	2.65	0.25	Stainless steel	
FEPC-17-A	18.1	3.8	2.9	19.1	3.0	0.3	Stainless steel	
FEPC-19-A	19.9	3.8	2.9	21.5	3.0	0.3	Stainless steel	
FEPC-25-A	26.0	5.6	2.9	27.0	3.0	0.3	Stainless steel	
FEPC-25B-A	26.0	5.0	2.9	24.5	3.0	0.3	Stainless steel	
FEPC-27-A	28.0	5.6	2.9	34.0	3.0	0.3	Stainless steel	
FEPC-30-A	31.0	5.6	2.9	37.0	3.0	0.3	Stainless steel	

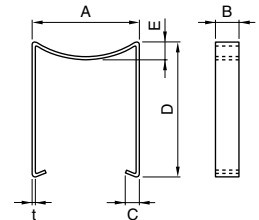

EP CORES

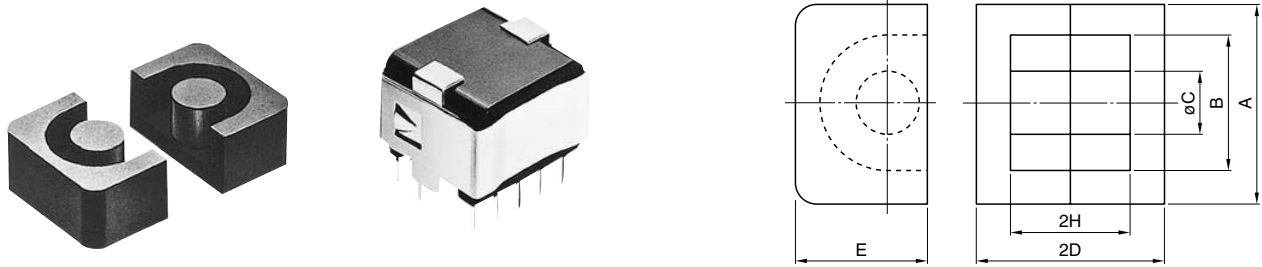

Part No.	Dimensions in mm					
	A	B	øC	2D	E	2H
PC40EP7-Z	9.2±0.2	7.4±0.2	3.3±0.1	7.4±0.1	6.35±0.15	5.2±0.2
PC40EP10-Z PC50EP10-Z	11.5±0.3	9.4±0.2	3.3±0.15	10.2±0.2	7.65±0.2	7.4±0.2
PC40EP13-Z PC50EP13-Z	12.5±0.3	10.0±0.3	4.35±0.15	12.85±0.15	8.8±0.2	9.2±0.2
PC40EP17-Z	18.0±0.4	12.0±0.4	5.68±0.18	16.8±0.2	11.0±0.25	11.3±0.3
PC40EP20-Z	24.0±0.5	16.5±0.4	8.75±0.25	21.4±0.2	14.95±0.35	14.3±0.3

Part No.	Effective parameter				Electrical characteristics			Wt (g)	Bobbin item
	C ₁ (mm ⁻¹)	A _e (mm ²)	ℓ _e (mm)	V _e (mm ³)	AL-value (nH/N ²) [*]		Core loss (W) max. 100kHz, 200mT, 100°C		
					Without air gap	With air gap			
PC40EP7-Z	1.52	10.3	15.7	162	830 min.	63±3% 100±4%	0.065	1.4	BEP7-316DFR
PC40EP10-Z PC50EP10-Z	1.70	11.3	19.2	217	800 min. 800±25%	63±3% 100±4%	0.08 0.02**	2.8	BEP10-318DFR
PC40EP13-Z PC50EP13-Z	1.24	19.5	24.2	472	1170 min. 1100±25%	100±3% 160±3%	0.17 0.044**	5.1	BEP13-3110DFR
PC40EP17-Z	0.84	33.9	28.5	966	1840 min.	100±5% 250±7%	0.33	12	BEP17-318DFR
PC40EP20-Z	0.508	78	39.8	3120	3200 min.	100±5% 250±7%	1.1	28	BEP20-8110DFR

* AL-value: 1kHz, 0.5mA, 100Ts

** Core loss: 500kHz, 50mT, 100°C

EP BOBBINS

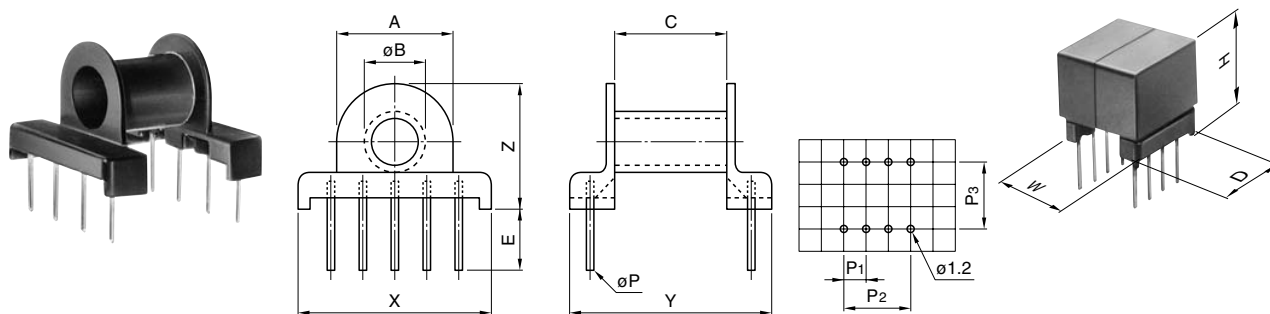

Part No.	Dimensions in mm							t*
	A	øB	C	E	X	Y	Z	
BEP7-316DFR	7.0	4.5	3.1	3.25	9.2	7.4	8.25	0.25
BEP10-318DFR	8.8	4.8	5.6	5.2	11.0	11.0	10.2	0.40
BEP13-3110DFR	9.6	5.7	7.7	5.3	13.2	13.5	10.8	0.38
BEP17-318DFR	11.4	7.2	9.4	5.0	19.0	19.0	13.2	0.35
BEP20-8110DFR	15.9	10.2	12.4	5.0	24.7	21.5	16.6	0.43

Part No.	Dimensions in mm				Terminal pins	W D (mm) H	Parameter		Wt (g)	Accessory item
	øP (mm)	P1 (mm)	P2 (mm)	P3 (mm)			Aw (mm ²)	∅w (mm)		
BEP7-316DFR	0.6	2.5	5.0	5.0	6	9.4 7.5 9.6	3.85	18.1	0.3	FEP-7-C
BEP10-318DFR	0.6	2.5	7.5	7.5	8	11.8 11.2 11.8	11.7	21.7	0.65	FEP-10-C
BEP13-3110DFR	0.6	2.5	10.0	10.0	10	13.4 13.7 12.7	16.6	23.9	0.74	FEP-13-C
BEP17-318DFR	0.6	5.0	15.0	15.0	8	19.25 19.25 15.7	19.0	29.1	1.3	FEP-17-C
BEP20-8110DFR	0.6	5.0	20.0	17.5	10	25.0 21.8 19.6	33.2	40.8	1.8	FEP-20-C

UL Grade: 94V-0, Material: FR phenol, Pin material: Phosphor bronze (Solder plated)

Maximum number of turns N that can be wound on bobbins, see section of "Maximum number of Turns on Bobbins".

* Minimum thickness of bobbin inside which core is placed, including flanges

PQ Series PQ20/16 Cores

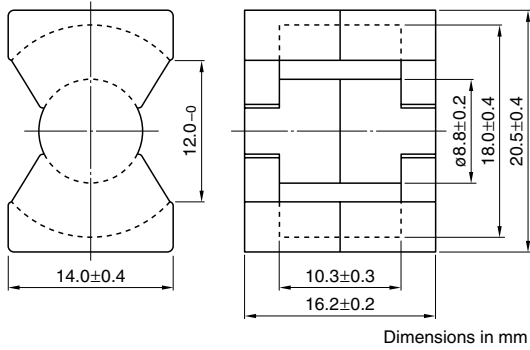

Parameter

Core factor	C1	mm ⁻¹	0.605
Effective magnetic path length	ℓ _e	mm	37.4
Effective cross-sectional area	A _e	mm ²	62
Effective core volume	V _e	mm ³	2310
Cross-sectional center pole area	A _{cp}	mm ²	60.8
Minimum cross-sectional center pole area	A _{cp min.}	mm ²	58.1
Cross-sectional winding area of core	A _{cw}	mm ²	47.4
Weight (approx.)		g	13

Part No.	AL-value (nH/N ²)	Core loss (W) at 100°C 100kHz, 200mT	Calculated output power (forward converter mode)
PC44PQ20/16Z-12	3880±25% (1kHz, 0.5mA)* 5210 min. (100kHz, 200mT)	0.84 max.	70W (100kHz)

* Coil: ø0.35 2UEW 100Ts

NI limit vs. AL-value for PC44PQ20/16 gapped core (Typical)

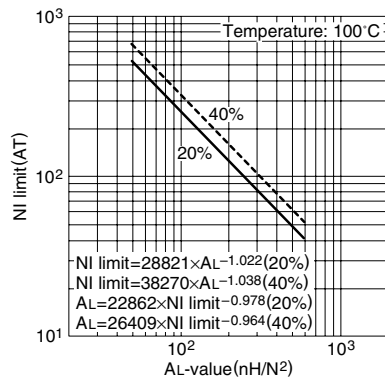

Note: NI limit shows the point where the exciting current is 20% and 40% away from its extended linear part.

AL-value vs. Air gap length for PC44PQ20/16 core (Typical)

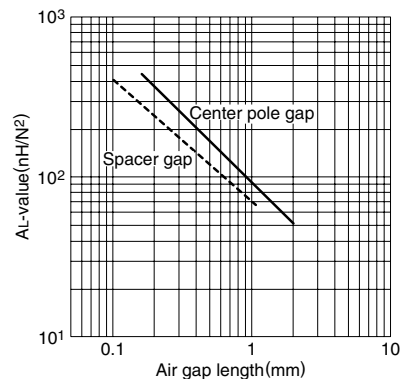

Measuring conditions • Coil: ø0.35 2UEW 100Ts
 • Frequency: 1kHz
 • Level: 0.5mA

Temperature rise vs. Total loss for PQ20/16 core (Typical) (Ambient temperature: 25°C)

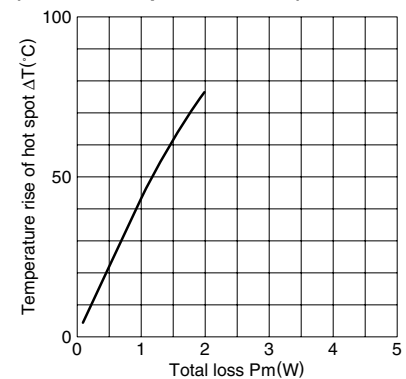

Note: The temperature rise is measured in the room whose temperature and humidity are fixed to 25°C and 45%RH, respectively. (approx. 400×300×300cm)

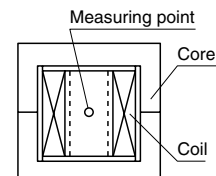

PQ Series PQ20/20 Cores

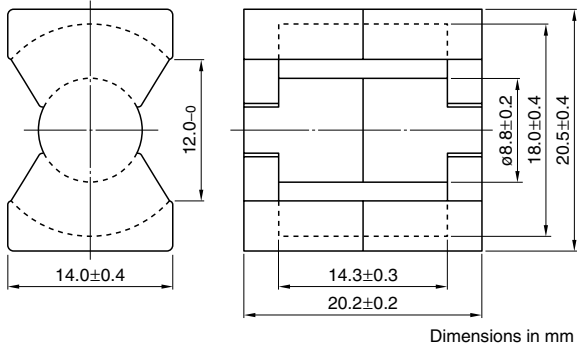

Parameter

Core factor	C1	mm ⁻¹	0.738
Effective magnetic path length	ℓ _e	mm	45.4
Effective cross-sectional area	A _e	mm ²	62
Effective core volume	V _e	mm ³	2790
Cross-sectional center pole area	A _{cp}	mm ²	60.8
Minimum cross-sectional center pole area	A _{cp min.}	mm ²	58.1
Cross-sectional winding area of core	A _{cw}	mm ²	65.8
Weight (approx.)		g	15

Part No.	AL-value (nH/N ²)	Core loss (W) at 100°C		Calculated output power (forward converter mode)
		100kHz, 200mT	500kHz, 50mT	
PC44PQ20/20Z-12	3150±25% (1kHz, 0.5mA)* 4290 min. (100kHz, 200mT)	1.02 max.		92W (100kHz)
PC50PQ20/20Z-12	2000±25% (1kHz, 0.5mA)*	0.33 max.		187W (500kHz)

* Coil: ø0.35 2UEW 100Ts

NI limit vs. AL-value for PC44PQ20/20 gapped core (Typical)

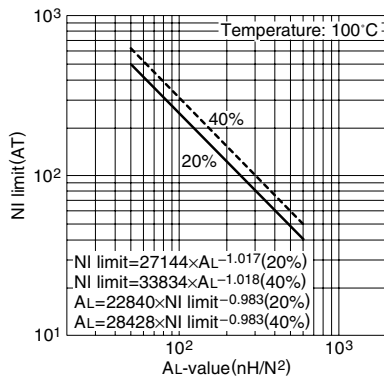

AL-value vs. Air gap length for PC44PQ20/20 core (Typical)

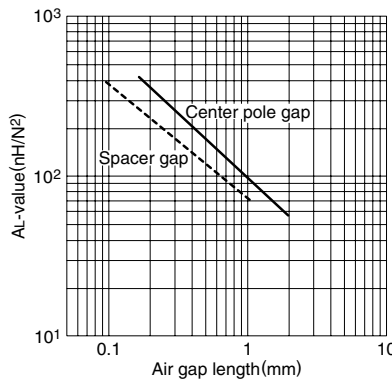

Temperature rise vs. Total loss for PQ20/20 core (Typical) (Ambient temperature: 25°C)

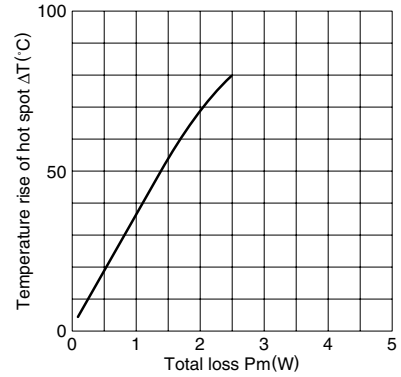

Note: The temperature rise is measured in the room whose temperature and humidity are fixed to 25°C and 45%RH, respectively. (approx. 400×300×300cm)

NI limit vs. AL-value for PC50PQ20/20 gapped core (Typical)

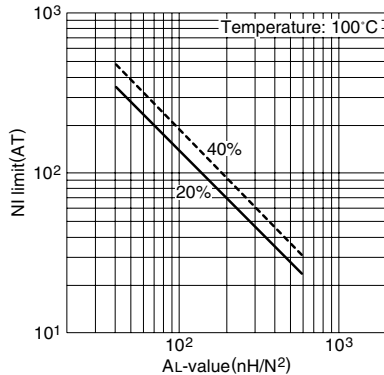

Note: NI limit shows the point where the exciting current is 20% and 40% away from its extended linear part.

AL-value vs. Air gap length for PC50PQ20/20 core (Typical)

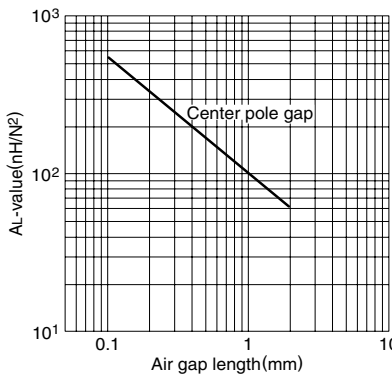

Measuring conditions • Coil: ø0.35 2UEW 100Ts
• Frequency: 1kHz
• Level: 0.5mA

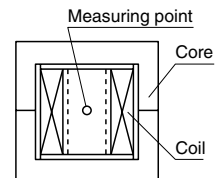

PQ Series PQ26/20 Cores

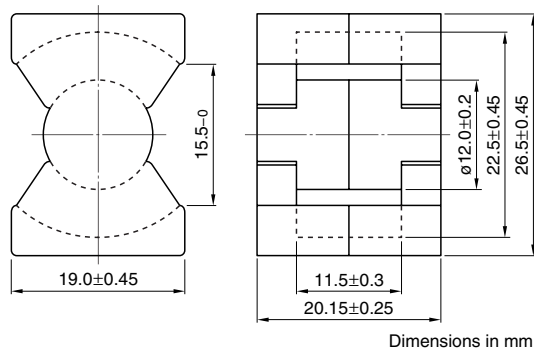

Parameter

Core factor	C1	mm ⁻¹	0.391
Effective magnetic path length	l_e	mm	46.3
Effective cross-sectional area	A_e	mm ²	119
Effective core volume	V_e	mm ³	5490
Cross-sectional center pole area	A_{cp}	mm ²	113
Minimum cross-sectional center pole area	$A_{cp \text{ min.}}$	mm ²	109
Cross-sectional winding area of core	A_{cw}	mm ²	60.4
Weight (approx.)		g	31

Part No.	AL-value (nH/N ²)	Core loss (W) at 100°C 100kHz, 200mT	Calculated output power (forward converter mode)
PC44PQ26/20Z-12	6170±25% (1kHz, 0.5mA)* 8060 min. (100kHz, 200mT)	1.94 max.	170W (100kHz)

* Coil: ø0.35 2UEW 100Ts

NI limit vs. AL-value for PC44PQ26/20 gapped core (Typical)

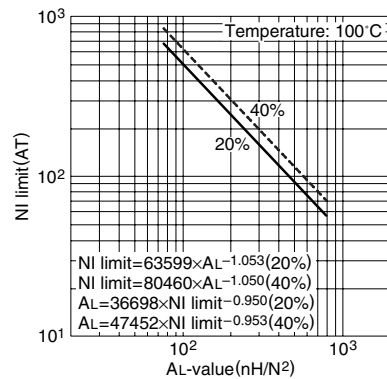

Note: NI limit shows the point where the exciting current is 20% and 40% away from its extended linear part.

AL-value vs. Air gap length for PC44PQ26/20 core (Typical)

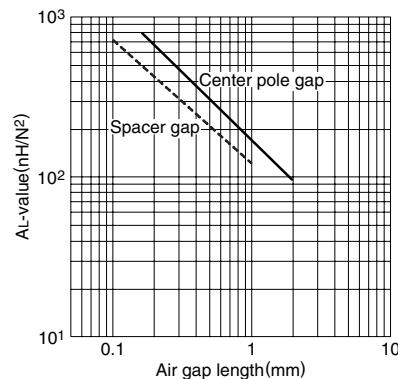

Measuring conditions • Coil: ø0.35 2UEW 100Ts
• Frequency: 1kHz
• Level: 0.5mA

Temperature rise vs. Total loss for PQ26/20 core (Typical) (Ambient temperature: 25°C)

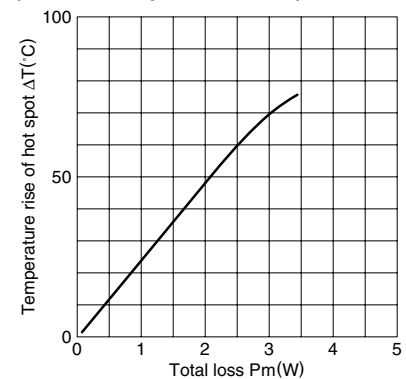

Note: The temperature rise is measured in the room whose temperature and humidity are fixed to 25°C and 45%RH, respectively. (approx. 400×300×300cm)

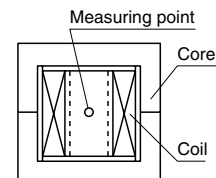

PQ Series PQ26/25 Cores

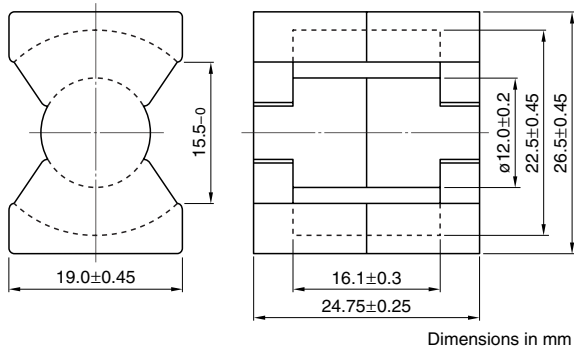

Parameter

Core factor	C1	mm ⁻¹	0.472
Effective magnetic path length	ℓ _e	mm	55.5
Effective cross-sectional area	A _e	mm ²	118
Effective core volume	V _e	mm ³	6530
Cross-sectional center pole area	A _{cp}	mm ²	113
Minimum cross-sectional center pole area	A _{cp min.}	mm ²	109
Cross-sectional winding area of core	A _{cw}	mm ²	84.5
Weight (approx.)		g	36

Part No.	AL-value (nH/N ²)	Core loss (W) at 100°C		Calculated output power (forward converter mode)
		100kHz, 200mT	500kHz, 50mT	
PC44PQ26/25Z-12	5250±25% (1kHz, 0.5mA)* 6680 min. (100kHz, 200mT)	2.32 max.		195W (100kHz)
PC50PQ26/25Z-12	3200±25% (1kHz, 0.5mA)*	0.76 max.		366W (500kHz)

* Coil: ø0.35 2UEW 100Ts

NI limit vs. AL-value for PC44PQ26/25 gapped core (Typical)

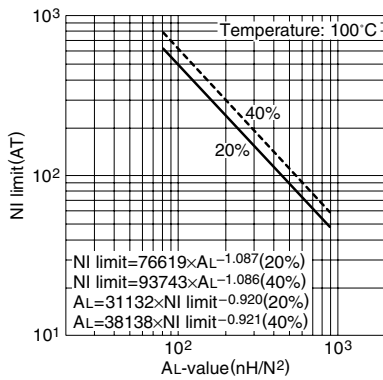

AL-value vs. Air gap length for PC44PQ26/25 core (Typical)

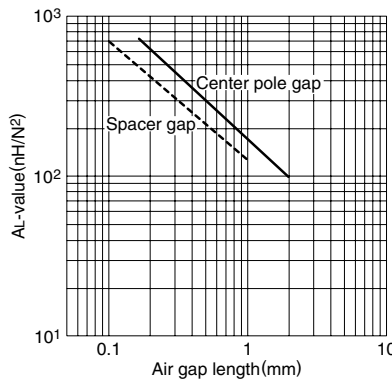

Temperature rise vs. Total loss for PQ26/25 core (Typical) (Ambient temperature: 25°C)

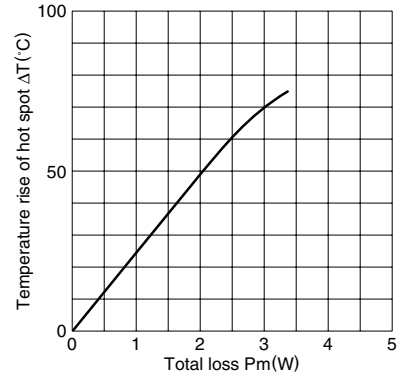

Note: The temperature rise is measured in the room whose temperature and humidity are fixed to 25°C and 45%RH, respectively. (approx. 400×300×300cm)

NI limit vs. AL-value for PC50PQ26/25 gapped core (Typical)

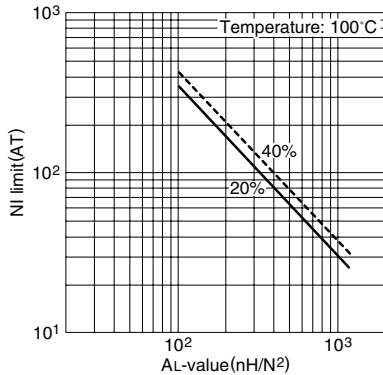

Note: NI limit shows the point where the exciting current is 20% and 40% away from its extended linear part.

AL-value vs. Air gap length for PC50PQ26/25 core (Typical)

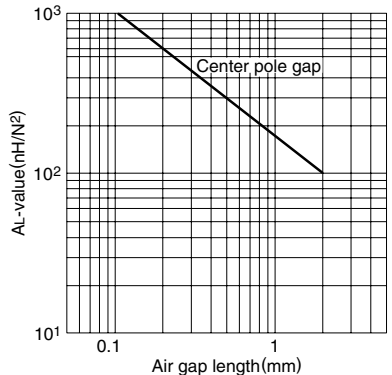

Measuring conditions • Coil: ø0.35 2UEW 100Ts
• Frequency: 1kHz
• Level: 0.5mA

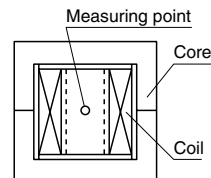

PQ Series PQ32/20 Cores

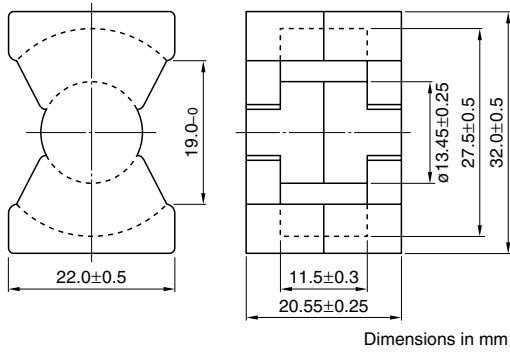

Parameter

Core factor	C1	mm ⁻¹	0.326
Effective magnetic path length	ℓ _e	mm	55.5
Effective cross-sectional area	A _e	mm ²	170
Effective core volume	V _e	mm ³	9420
Cross-sectional center pole area	A _{cp}	mm ²	142
Minimum cross-sectional center pole area	A _{cp min.}	mm ²	137
Cross-sectional winding area of core	A _{cw}	mm ²	80.8
Weight (approx.)		g	42

Part No.	AL-value (nH/N ²)	Core loss (W) at 100°C 100kHz, 200mT	Calculated output power (forward converter mode)
PC44PQ32/20Z-12	7310±25% (1kHz, 0.5mA)* 9640 min. (100kHz, 200mT)	2.92 max.	232W (100kHz)

* Coil: ø0.35 2UEW 100Ts

NI limit vs. AL-value for PC44PQ32/20 gapped core (Typical)

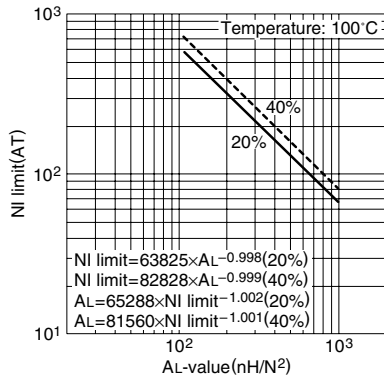

Note: NI limit shows the point where the exciting current is 20% and 40% away from its extended linear part.

AL-value vs. Air gap length for PC44PQ32/20 core (Typical)

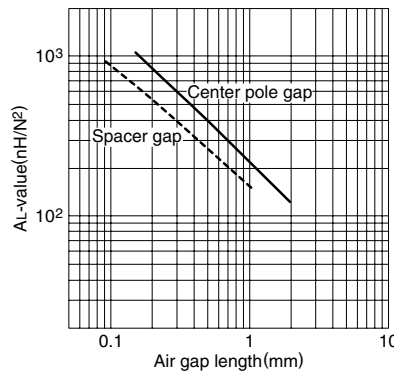

Measuring conditions • Coil: ø0.35 2UEW 100Ts
• Frequency: 1kHz
• Level: 0.5mA

Temperature rise vs. Total loss for PQ32/20 core (Typical) (Ambient temperature: 25°C)

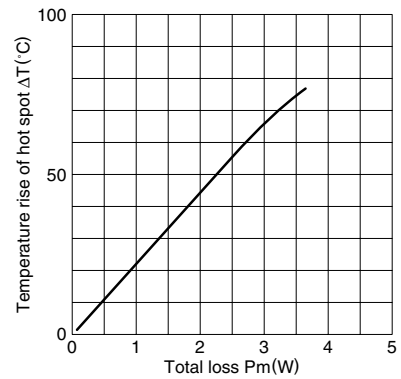

Note: The temperature rise is measured in the room whose temperature and humidity are fixed to 25°C and 45%RH, respectively. (approx. 400×300×300cm)

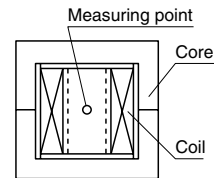

PQ Series PQ32/30 Cores

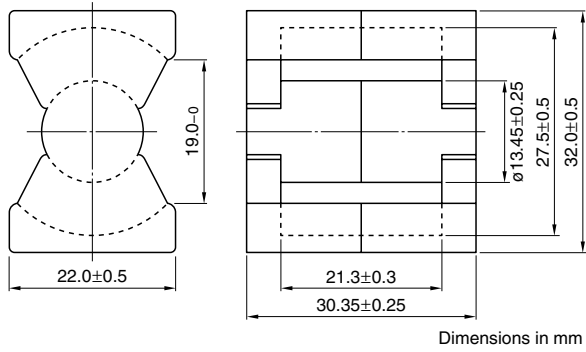

Parameter

Core factor	C1	mm ⁻¹	0.464
Effective magnetic path length	ℓ _e	mm	74.6
Effective cross-sectional area	A _e	mm ²	161
Effective core volume	V _e	mm ³	12000
Cross-sectional center pole area	A _{cp}	mm ²	142
Minimum cross-sectional center pole area	A _{cp min.}	mm ²	137
Cross-sectional winding area of core	A _{cw}	mm ²	149.6
Weight (approx.)		g	55

Part No.	AL-value (nH/N ²)	Core loss (W) at 100°C 100kHz, 200mT	Calculated output power (forward converter mode)
PC44PQ32/30Z-12	5140±25% (1kHz, 0.5mA)* 6790 min. (100kHz, 200mT)	3.92 max.	331W (100kHz)

* Coil: ø0.4 2UEW 100Ts

NI limit vs. AL-value for PC44PQ32/30 gapped core (Typical)

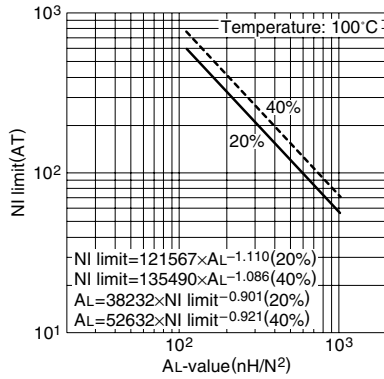

Note: NI limit shows the point where the exciting current is 20% and 40% away from its extended linear part.

AL-value vs. Air gap length for PC44PQ32/30 core (Typical)

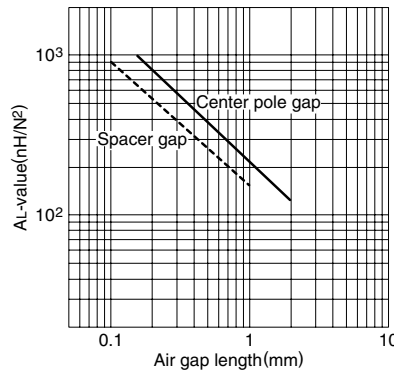

Measuring conditions • Coil: ø0.4 2UEW 100Ts
• Frequency: 1kHz
• Level: 0.5mA

Temperature rise vs. Total loss for PQ32/30 core (Typical) (Ambient temperature: 25°C)

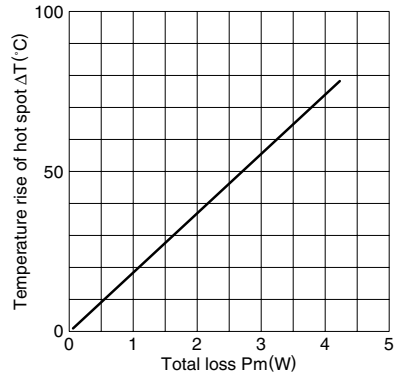

Note: The temperature rise is measured in the room whose temperature and humidity are fixed to 25°C and 45%RH, respectively. (approx. 400×300×300cm)

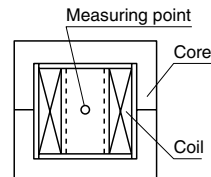

PQ Series PQ35/35 Cores

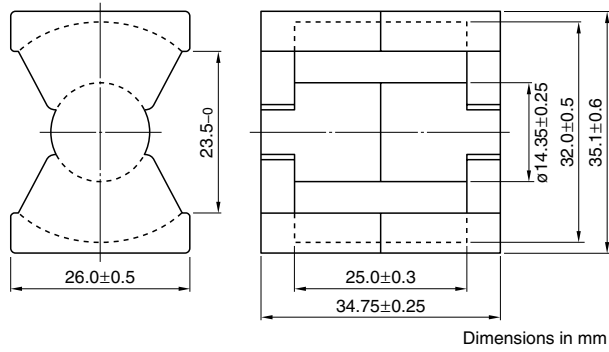

Parameter

Core factor	C1	mm ⁻¹	0.448
Effective magnetic path length	ℓ _e	mm	87.9
Effective cross-sectional area	A _e	mm ²	196
Effective core volume	V _e	mm ³	17300
Cross-sectional center pole area	A _{cp}	mm ²	162
Minimum cross-sectional center pole area	A _{cp min.}	mm ²	156
Cross-sectional winding area of core	A _{cw}	mm ²	220.6
Weight (approx.)		g	73

Part No.	AL-value (nH/N ²)	Core loss (W) at 100°C 100kHz, 200mT	Calculated output power (forward converter mode)
PC44PQ35/35Z-12	4860±25% (1kHz, 0.5mA)* 7010 min. (100kHz, 200mT)	5.27 max.	452W (100kHz)

* Coil: ø0.4 2UEW 100Ts

NI limit vs. AL-value for PC44PQ35/35 gapped core (Typical)

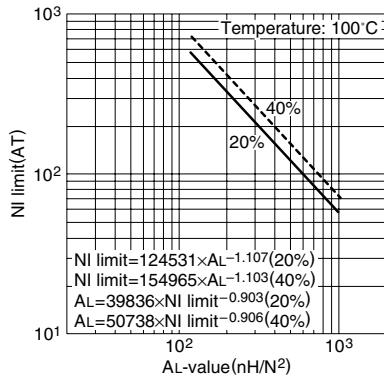

Note: NI limit shows the point where the exciting current is 20% and 40% away from its extended linear part.

AL-value vs. Air gap length for PC44PQ35/35 core (Typical)

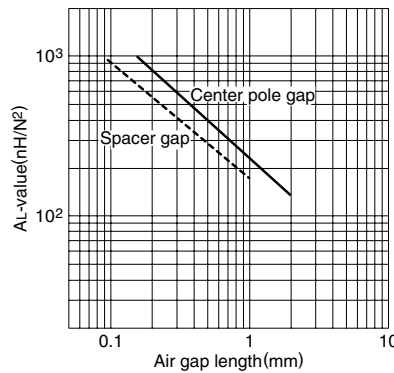

Measuring conditions • Coil: ø0.4 2UEW 100Ts
 • Frequency: 1kHz
 • Level: 0.5mA

Temperature rise vs. Total loss for PQ35/35 core (Typical) (Ambient temperature: 25°C)

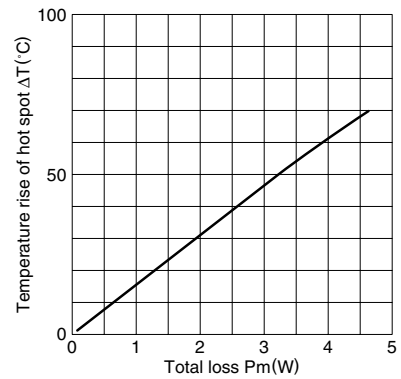

Note: The temperature rise is measured in the room whose temperature and humidity are fixed to 25°C and 45%RH, respectively. (approx. 400×300×300cm)

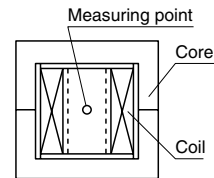

PQ Series PQ40/40 Cores

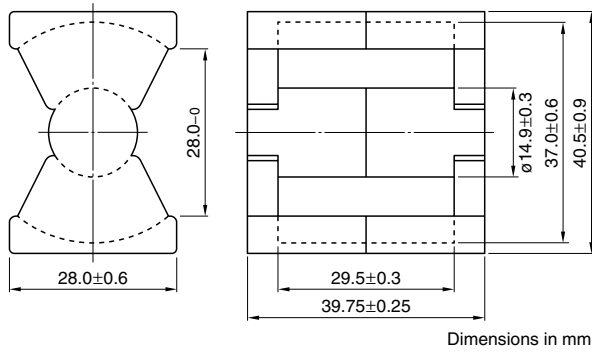

Parameter

Core factor	C1	mm ⁻¹	0.508
Effective magnetic path length	ℓ _e	mm	102
Effective cross-sectional area	A _e	mm ²	201
Effective core volume	V _e	mm ³	20500
Cross-sectional center pole area	A _{cp}	mm ²	174
Minimum cross-sectional center pole area	A _{cp min.}	mm ²	167
Cross-sectional winding area of core	A _{cw}	mm ²	326
Weight (approx.)		g	95

Part No.	AL-value (nH/N ²)	Core loss (W) at 100°C 100kHz, 200mT	Calculated output power (forward converter mode)
PC44PQ40/40Z-12	4300±25% (1kHz, 0.5mA)* 6200 min. (100kHz, 200mT)	6.56 max.	596W (100kHz)

* Coil: ø0.4 2UEW 100Ts

NI limit vs. AL-value for PC44PQ40/40 gapped core (Typical)

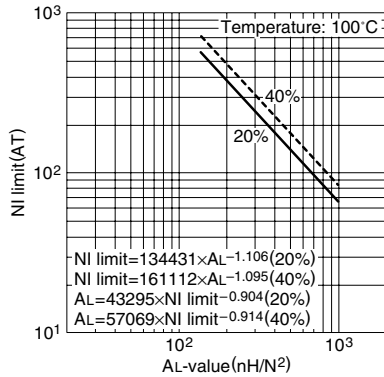

Note: NI limit shows the point where the exciting current is 20% and 40% away from its extended linear part.

AL-value vs. Air gap length for PC44PQ40/40 core (Typical)

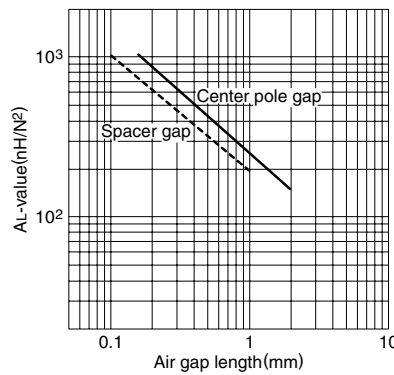

Measuring conditions • Coil: ø0.4 2UEW 100Ts
• Frequency: 1kHz
• Level: 0.5mA

Temperature rise vs. Total loss for PQ40/40 core (Typical)

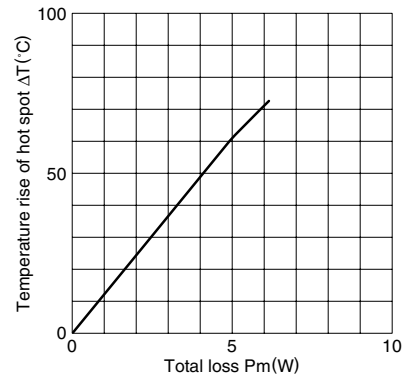

Note: The temperature rise is measured in the room whose temperature and humidity are fixed to 25°C and 45%RH, respectively. (approx. 400×300×300cm)

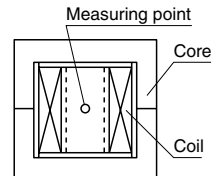

PQ Series PQ50/50 Cores

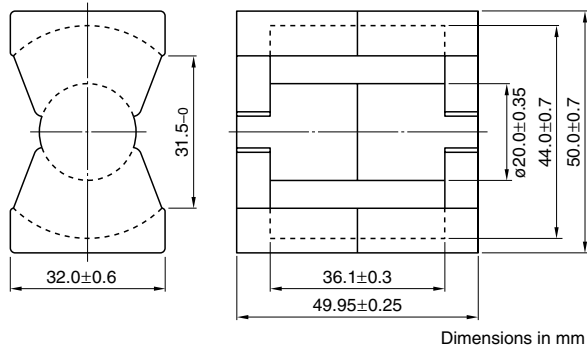

Parameter

Core factor	C1	mm ⁻¹	0.346
Effective magnetic path length	l_e	mm	113
Effective cross-sectional area	A_e	mm ²	328
Effective core volume	V_e	mm ³	37200
Cross-sectional center pole area	A_{cp}	mm ²	314
Minimum cross-sectional center pole area	$A_{cp \text{ min.}}$	mm ²	303
Cross-sectional winding area of core	A_{cw}	mm ²	433
Weight (approx.)		g	195

Part No.	AL-value (nH/N ²)	Core loss (W) at 100°C 100kHz, 150mT	Calculated output power (forward converter mode)
PC44PQ50/50Z-12	6720±25% (1kHz, 0.5mA)* 9810 min. (100kHz, 150mT)	6.1 max.	1045W (100kHz)

* Coil: $\phi 0.4$ 2UEW 100Ts

NI limit vs. AL-value for PC44PQ50/50 gapped core (Typical)

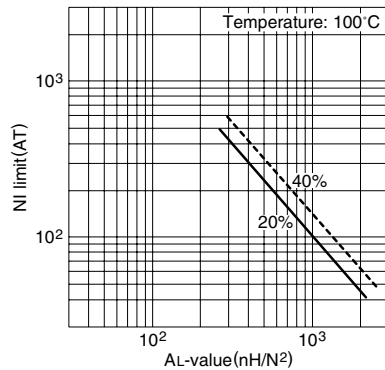

Note: NI limit shows the point where the exciting current is 20% and 40% away from its extended linear part.

AL-value vs. Air gap length for PC44PQ50/50 core (Typical)

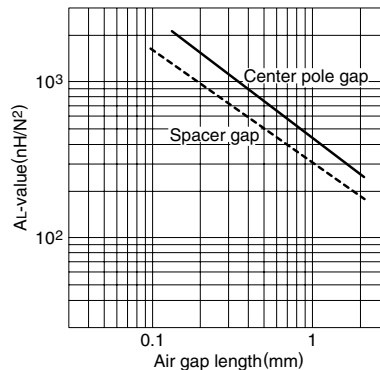

Measuring conditions • Coil: $\phi 0.4$ 2UEW 100Ts
• Frequency: 1kHz
• Level: 0.5mA

Temperature rise vs. Total loss for PQ50/50 core (Typical) (Ambient temperature: 25°C)

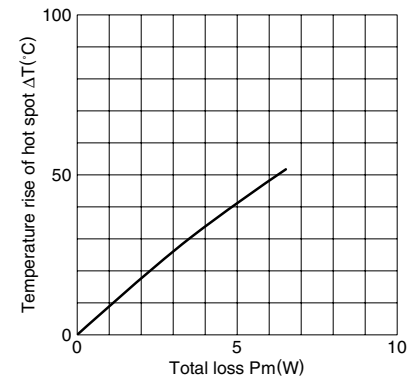

Note: The temperature rise is measured in the room whose temperature and humidity are fixed to 25°C and 45%RH, respectively. (approx. 400×300×300cm)

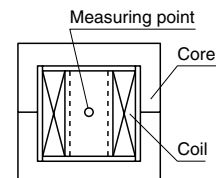

LP Series LP23/8 Cores

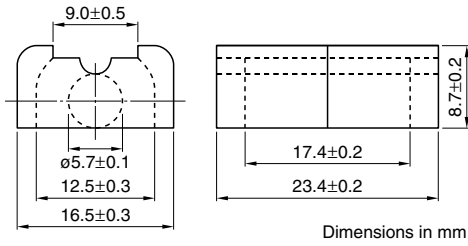

Parameter

Core factor	C1	mm ⁻¹	1.41
Effective magnetic path length	ℓ _e	mm	44.1
Effective cross-sectional area	A _e	mm ²	31.3
Effective core volume	V _e	mm ³	1380
Cross-sectional center pole area	A _{cp}	mm ²	25.5
Minimum cross-sectional center pole area	A _{cp min.}	mm ²	24.6
Cross-sectional winding area of core	A _{cw}	mm ²	59.2
Weight (approx.)		g	9.6

Part No.	AL-value (nH/N ²)	Core loss (W) at 100°C 100kHz, 200mT	Calculated output power (forward converter mode)
PC44LP23/8Z-12	1600±25% (1kHz, 0.5mA)* 2230 min. (100kHz, 200mT)	0.42 max.	50W (100kHz)

* Coil: ø0.3 2UEW 100Ts

NI limit vs. AL-value for PC44LP23/8 gapped core (Typical)

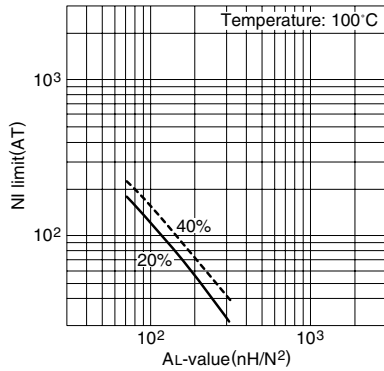

Note: NI limit shows the point where the exciting current is 20% and 40% away from its extended linear part.

AL-value vs. Air gap length for PC44LP23/8 core (Typical)

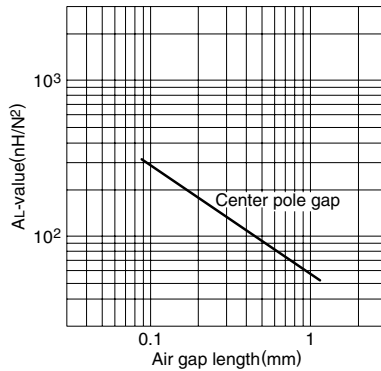

Measuring conditions • Coil: ø0.3 2UEW 100Ts
• Frequency: 1kHz
• Level: 0.5mA

Temperature rise vs. Total loss for LP23/8 core (Typical) (Ambient temperature: 25°C)

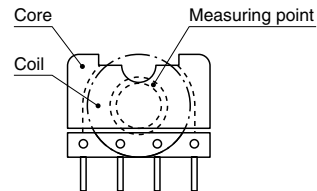
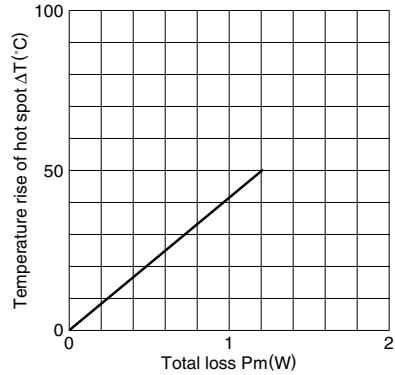

Note: The temperature rise is measured in the room whose temperature and humidity are fixed to 25°C and 45%RH, respectively. (approx. 400×300×300cm)

LP Series LP22/13 Cores

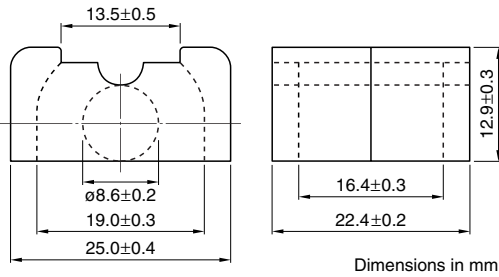

Parameter

Core factor	C1	mm ⁻¹	0.721
Effective magnetic path length	ℓ _e	mm	49.0
Effective cross-sectional area	A _e	mm ²	67.9
Effective core volume	V _e	mm ³	3330
Cross-sectional center pole area	A _{cp}	mm ²	58.1
Minimum cross-sectional center pole area	A _{cp min.}	mm ²	55.4
Cross-sectional winding area of core	A _{cw}	mm ²	84.2
Weight (approx.)		g	21

Part No.	AL-value (nH/N ²)	Core loss (W) at 100°C 100kHz, 200mT	Calculated output power (forward converter mode)
PC44LP22/13Z-12	3310±25% (1kHz, 0.5mA)* 4700 min. (100kHz, 200mT)	1.05 max.	121W (100kHz)

* Coil: ø0.35 2UEW 100Ts

NI limit vs. AL-value for PC44LP22/13 gapped core (Typical)

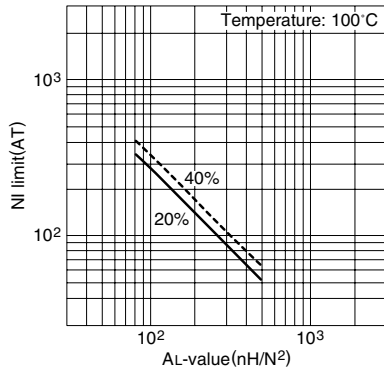

Note: NI limit shows the point where the exciting current is 20% and 40% away from its extended linear part.

AL-value vs. Air gap length for PC44LP22/13 core (Typical)

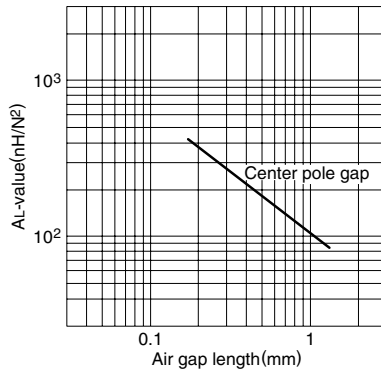

Measuring conditions • Coil: ø0.35 2UEW 100Ts
• Frequency: 1kHz
• Level: 0.5mA

Temperature rise vs. Total loss for LP22/13 core (Typical) (Ambient temperature: 25°C)

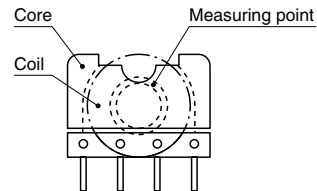
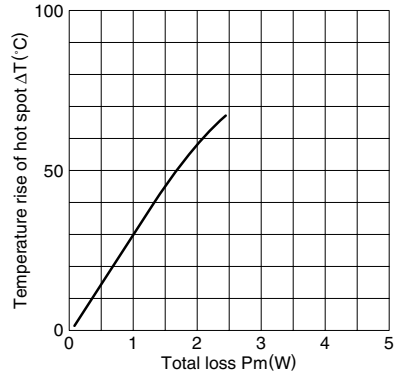

Note: The temperature rise is measured in the room whose temperature and humidity are fixed to 25°C and 45%RH, respectively. (approx. 400×300×300cm)

LP Series LP32/13 Cores

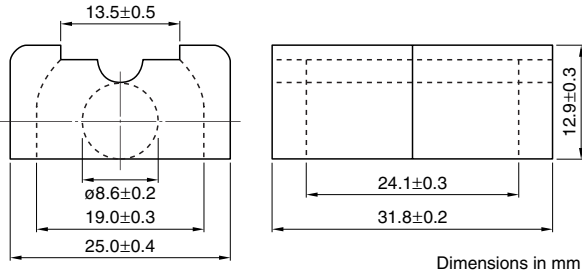

Parameter

Core factor	C1	mm ⁻¹	0.909
Effective magnetic path length	ℓ _e	mm	64.0
Effective cross-sectional area	A _e	mm ²	70.3
Effective core volume	V _e	mm ³	4500
Cross-sectional center pole area	A _{cp}	mm ²	58.1
Minimum cross-sectional center pole area	A _{cp min.}	mm ²	55.4
Cross-sectional winding area of core	A _{cw}	mm ²	125.3
Weight (approx.)		g	30

Part No.	AL-value (nH/N ²)	Core loss (W) at 100°C 100kHz, 200mT	Calculated output power (forward converter mode)
PC44LP32/13Z-12	2630±25% (1kHz, 0.5mA)* 3730 min. (100kHz, 200mT)	1.38 max.	164W (100kHz)

* Coil: ø0.35 2UEW 100Ts

NI limit vs. AL-value for PC44LP32/13 gapped core (Typical)

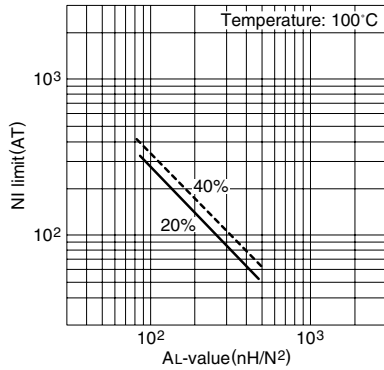

Note: NI limit shows the point where the exciting current is 20% and 40% away from its extended linear part.

AL-value vs. Air gap length for PC44LP32/13core (Typical)

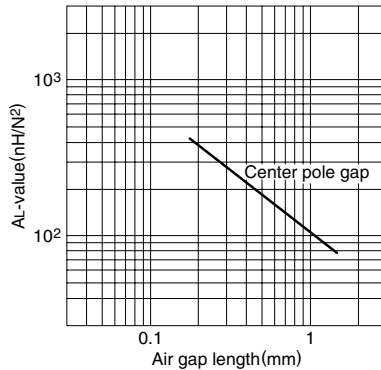

Measuring conditions • Coil: ø0.35 2UEW 100Ts
• Frequency: 1kHz
• Level: 0.5mA

Temperature rise vs. Total loss for LP32/13 core (Typical) (Ambient temperature: 25°C)

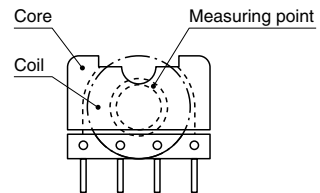
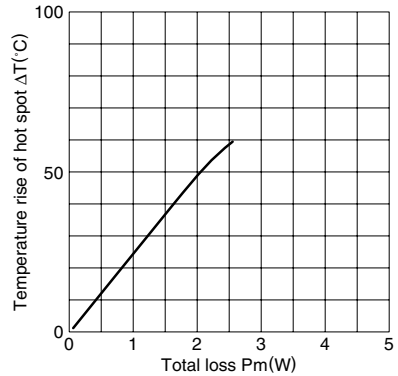

Note: The temperature rise is measured in the room whose temperature and humidity are fixed to 25°C and 45%RH, respectively. (approx. 400×300×300cm)

EPC Series EPC10 Cores

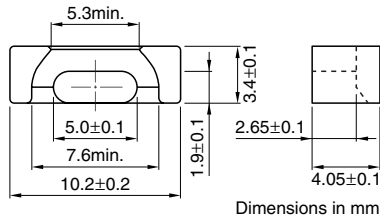

Parameter

Core factor	C1	mm ⁻¹	1.89
Effective magnetic path length	ℓ _e	mm	17.8
Effective cross-sectional area	A _e	mm ²	9.39
Effective core volume	V _e	mm ³	167
Cross-sectional center pole area	A _{cp}	mm ²	8.73
Minimum cross-sectional area	A _{cp min.}	mm ²	8.13
Cross-sectional winding area of core	A _{cw}	mm ²	7.69
Weight (approx.)	g		1.1

Part No.	AL-value (nH/N ²)	Core loss (W) at 100°C		Calculated output power (forward converter mode)
		100kHz, 200mT	500kHz, 50mT	
PC44EPC10-Z	1000±25% (1kHz, 0.5mA)*	0.072 max.		5.4W (100kHz)
PC50EPC10-Z	660±25% (1kHz, 0.5mA)*		0.025 max.	13W (500kHz)

* Coil: ø0.1 2UEW 100Ts

NI limit vs. AL-value for PC44EPC10 gapped core (Typical)

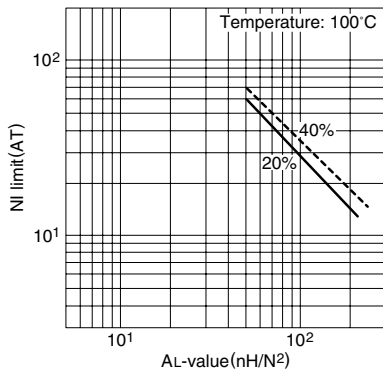

AL-value vs. Air gap length for PC44EPC10 core (Typical)

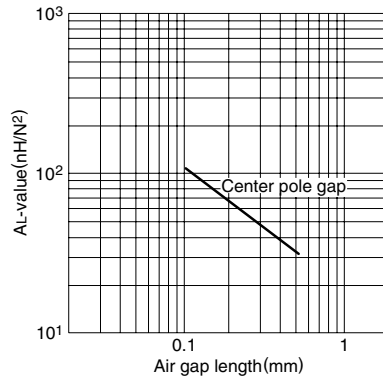

Temperature rise vs. Total loss for EPC10 core (Typical) (Ambient temperature: 25°C)

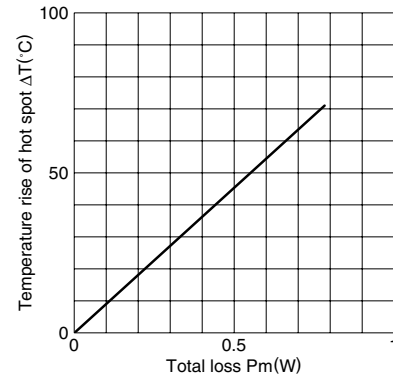

Note: The temperature rise is measured in the room whose temperature and humidity are fixed to 25°C and 45%RH, respectively. (approx. 400×300×300cm)

NI limit vs. AL-value for PC50EPC10 gapped core (Typical)

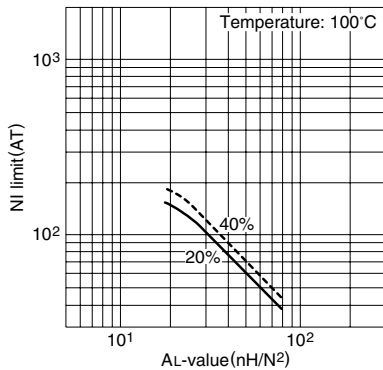

Note: NI limit shows the point where the exciting current is 20% and 40% away from its extended linear part.

AL-value vs. Air gap length for PC50EPC10 core (Typical)

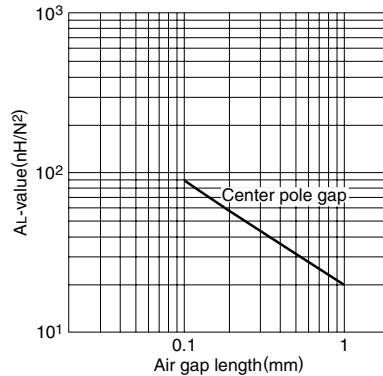

Measuring conditions • Coil: ø0.1 2UEW 100Ts
• Frequency: 1kHz
• Level: 0.5mA

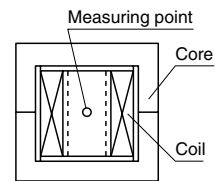

• All specifications are subject to change without notice.

EPC Series EPC13 Cores

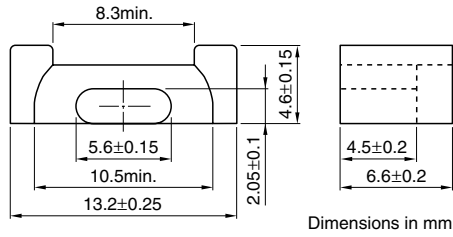

Parameter

Core factor	C1	mm ⁻¹	2.45
Effective magnetic path length	ℓ _e	mm	30.6
Effective cross-sectional area	A _e	mm ²	12.5
Effective core volume	V _e	mm ³	382
Cross-sectional center pole area	A _{cp}	mm ²	10.6
Minimum cross-sectional area	A _{cp min.}	mm ²	9.71
Cross-sectional winding area of core	A _{cw}	mm ²	23.0
Weight (approx.)		g	2.1

Part No.	AL-value (nH/N ²)	Core loss (W) at 100°C		Calculated output power (forward converter mode)
		100kHz, 200mT	500kHz, 50mT	
PC44EPC13-Z	870±25% (1kHz, 0.5mA)*	0.14 max.		8W (100kHz)
PC50EPC13-Z	560±25% (1kHz, 0.5mA)*		0.039 max.	19W (500kHz)

* Coil: ø0.2 2UEW 100Ts

NI limit vs. AL-value for PC44EPC13 gapped core (Typical)

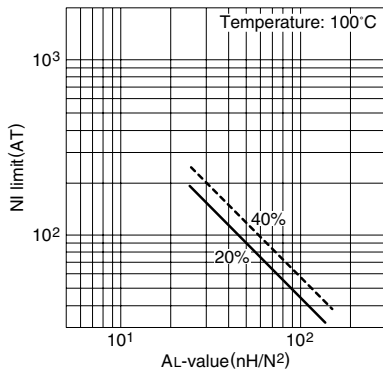

AL-value vs. Air gap length for PC44EPC13 core (Typical)

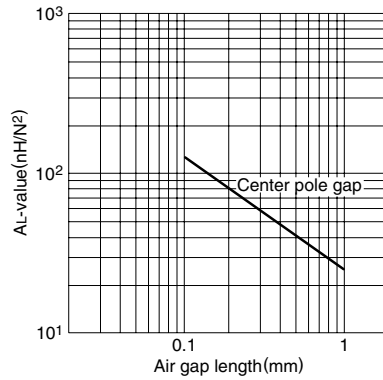

Temperature rise vs. Total loss for EPC13 core (Typical) (Ambient temperature: 25°C)

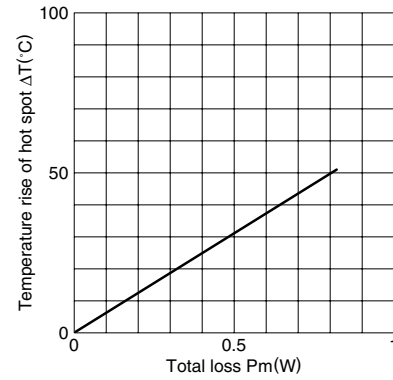

Note: The temperature rise is measured in the room whose temperature and humidity are fixed to 25°C and 45%RH, respectively. (approx. 400×300×300cm)

NI limit vs. AL-value for PC50EPC13 gapped core (Typical)

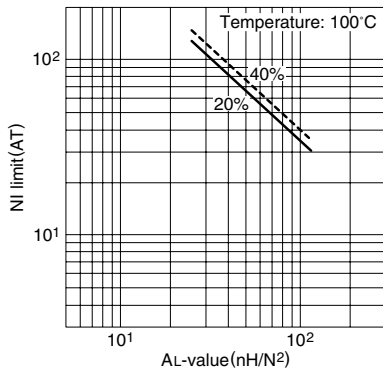

Note: NI limit shows the point where the exciting current is 20% and 40% away from its extended linear part.

AL-value vs. Air gap length for PC50EPC13 core (Typical)

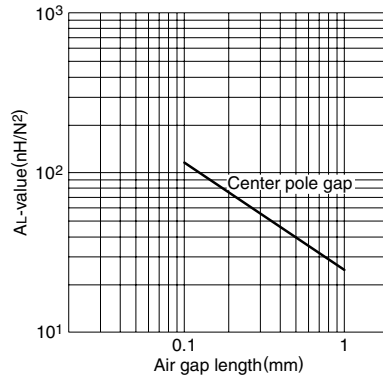

Measuring conditions • Coil: ø0.2 2UEW 100Ts
• Frequency: 1kHz
• Level: 0.5mA

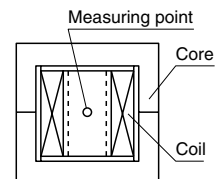

EPC Series EPC17 Cores

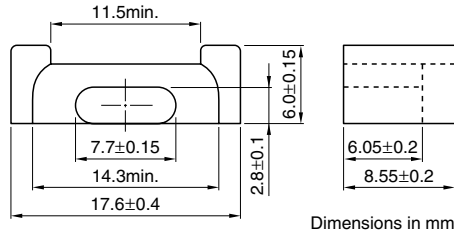

Parameter

Core factor	C1	mm ⁻¹	1.76
Effective magnetic path length	ℓ _e	mm	40.2
Effective cross-sectional area	A _e	mm ²	22.8
Effective core volume	V _e	mm ³	917
Cross-sectional center pole area	A _{cp}	mm ²	19.9
Minimum cross-sectional area	A _{cp min.}	mm ²	18.7
Cross-sectional winding area of core	A _{cw}	mm ²	41.1
Weight (approx.)		g	4.5

Part No.	AL-value (nH/N ²)	Core loss (W) at 100°C		Calculated output power (forward converter mode)
		100kHz, 200mT	500kHz, 50mT	
PC44EPC17-Z	1150±25% (1kHz, 0.5mA)*	0.35 max.		20W (100kHz)
PC50EPC17-Z	740±25% (1kHz, 0.5mA)*		0.10 max.	35W (500kHz)

* Coil: ø0.2 2UEW 100Ts

NI limit vs. AL-value for PC44EPC17 gapped core (Typical)

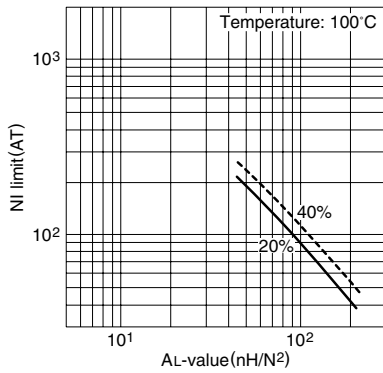

AL-value vs. Air gap length for PC44EPC17 core (Typical)

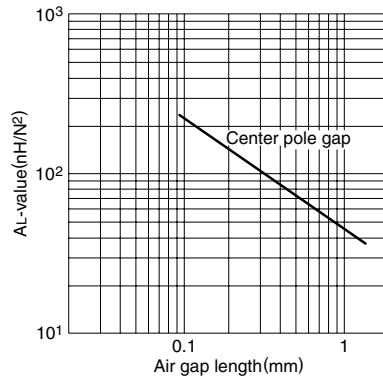

Temperature rise vs. Total loss for EPC17 core (Typical) (Ambient temperature: 25°C)

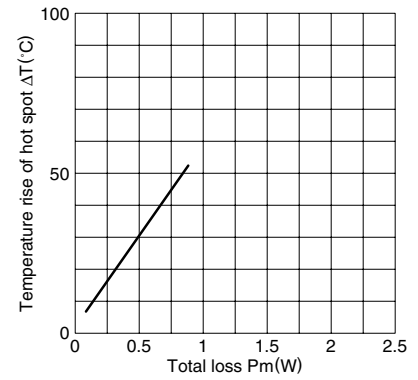

Note: The temperature rise is measured in the room whose temperature and humidity are fixed to 25°C and 45%RH, respectively. (approx. 400×300×300cm)

NI limit vs. AL-value for PC50EPC17 gapped core (Typical)

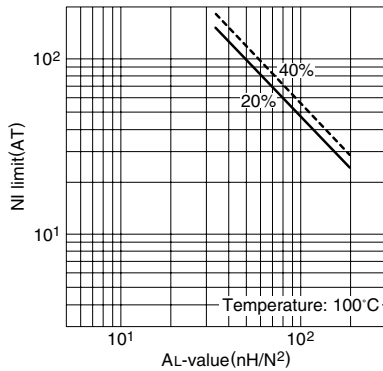

Note: NI limit shows the point where the exciting current is 20% and 40% away from its extended linear part.

AL-value vs. Air gap length for PC50EPC17 core (Typical)

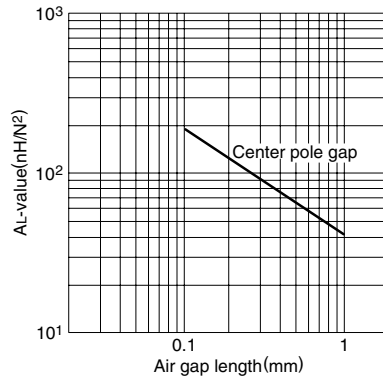

Measuring conditions • Coil: ø0.2 2UEW 100Ts
• Frequency: 1kHz
• Level: 0.5mA

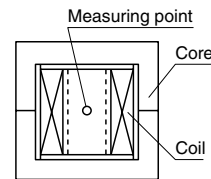

EPC Series EPC19 Cores

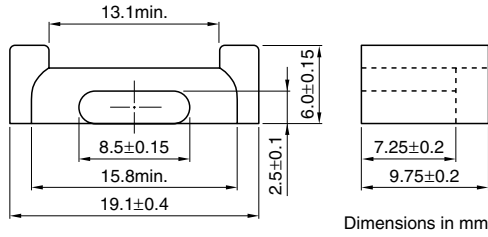

Parameter

Core factor	C1	mm ⁻¹	2.03
Effective magnetic path length	ℓ _e	mm	46.1
Effective cross-sectional area	A _e	mm ²	22.7
Effective core volume	V _e	mm ³	1050
Cross-sectional center pole area	A _{cp}	mm ²	19.9
Minimum cross-sectional area	A _{cp min.}	mm ²	18.7
Cross-sectional winding area of core	A _{cw}	mm ²	54.4
Weight (approx.)		g	5.3

Part No.	AL-value (nH/N ²)	Core loss (W) at 100°C		Calculated output power (forward converter mode)
		100kHz, 200mT	500kHz, 50mT	
PC44EPC19-Z	940±25% (1kHz, 0.5mA)*	0.4 max.		27W (100kHz)
PC50EPC19-Z	680±25% (1kHz, 0.5mA)*		0.12 max.	55W (500kHz)

* Coil: ø0.2 2UEW 100Ts

NI limit vs. AL-value for PC44EPC19 gapped core (Typical)

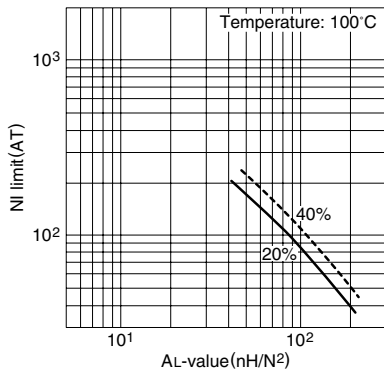

AL-value vs. Air gap length for PC44EPC19 core (Typical)

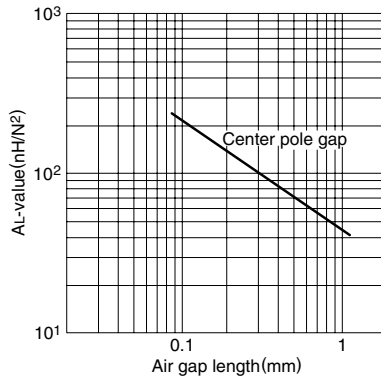

Temperature rise vs. Total loss for EPC19 core (Typical) (Ambient temperature: 25°C)

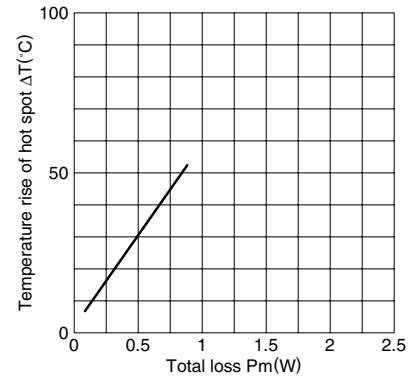

Note: The temperature rise is measured in the room whose temperature and humidity are fixed to 25°C and 45%RH, respectively. (approx. 400×300×300cm)

NI limit vs. AL-value for PC50EPC19 gapped core (Typical)

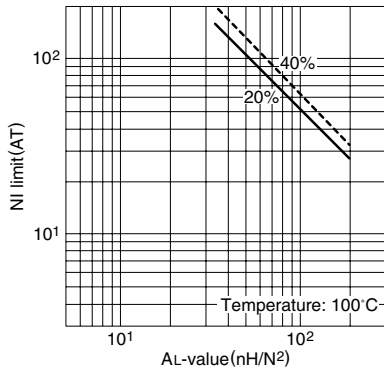

Note: NI limit shows the point where the exciting current is 20% and 40% away from its extended linear part.

AL-value vs. Air gap length for PC50EPC19 core (Typical)

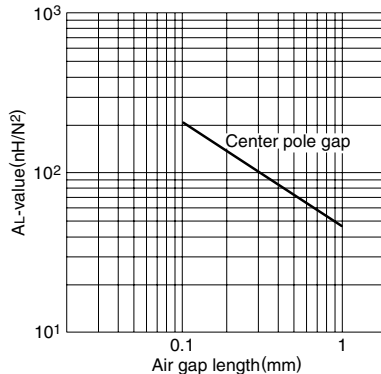

Measuring conditions • Coil: ø0.2 2UEW 100Ts
• Frequency: 1kHz
• Level: 0.5mA

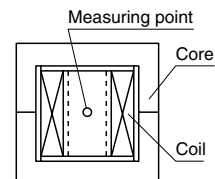

EPC Series EPC25 Cores

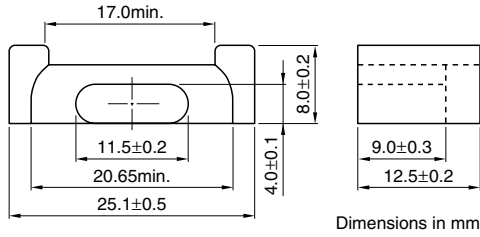

Parameter

Core factor	C1	mm ⁻¹	1.28
Effective magnetic path length	ℓ _e	mm	59.2
Effective cross-sectional area	A _e	mm ²	46.4
Effective core volume	V _e	mm ³	2750
Cross-sectional center pole area	A _{cp}	mm ²	42.6
Minimum cross-sectional area	A _{cp min.}	mm ²	40.6
Cross-sectional winding area of core	A _{cw}	mm ²	85.5
Weight (approx.)		g	13

Part No.	AL-value (nH/N ²)	Core loss (W) at 100°C		Calculated output power (forward converter mode)
		100kHz, 200mT	500kHz, 50mT	
PC44EPC25-Z	1560±25% (1kHz, 0.5mA)*	1.11 max.		63W (100kHz)
PC50EPC25-Z	1080±25% (1kHz, 0.5mA)*		0.32 max.	127W (500kHz)

* Coil: ø0.2 2UEW 100Ts

NI limit vs. AL-value for PC44EPC25 gapped core (Typical)

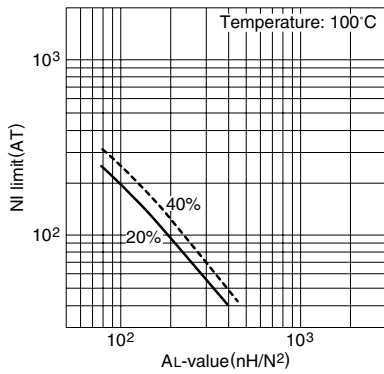

AL-value vs. Air gap length for PC44EPC25 core (Typical)

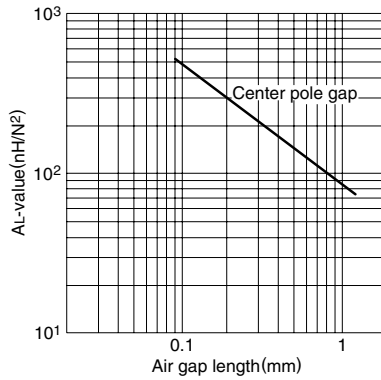

Temperature rise vs. Total loss for EPC25 core (Typical) (Ambient temperature: 25°C)

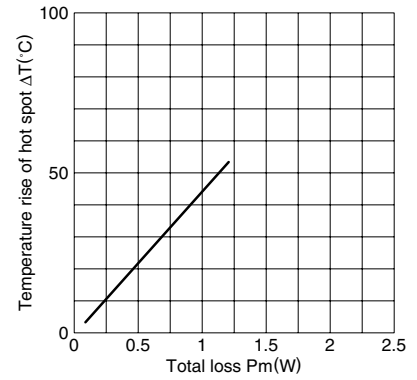

Note: The temperature rise is measured in the room whose temperature and humidity are fixed to 25°C and 45%RH, respectively. (approx. 400×300×300cm)

NI limit vs. AL-value for PC50EPC25 gapped core (Typical)

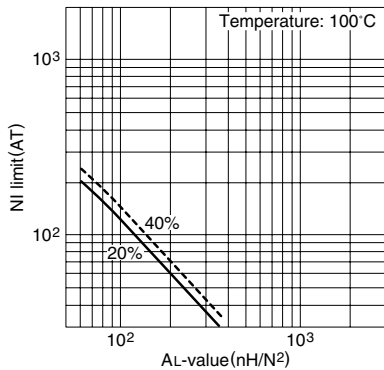

Note: NI limit shows the point where the exciting current is 20% and 40% away from its extended linear part.

AL-value vs. Air gap length for PC50EPC25 core (Typical)

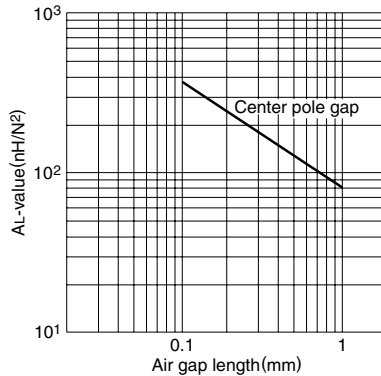

Measuring conditions • Coil: ø0.2 2UEW 100Ts
• Frequency: 1kHz
• Level: 0.5mA

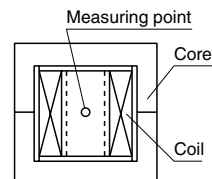

EPC Series EPC25B Cores

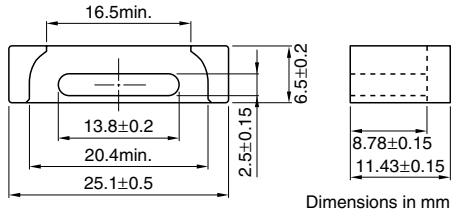

Parameter

Core factor	C1	mm ⁻¹	1.39
Effective magnetic path length	ℓ _e	mm	46.2
Effective cross-sectional area	A _e	mm ²	33.3
Effective core volume	V _e	mm ³	1540
Cross-sectional center pole area	A _{cp}	mm ²	32.4
Minimum cross-sectional area	A _{cp min.}	mm ²	30.3
Cross-sectional winding area of core	A _{cw}	mm ²	62.1
Weight (approx.)	g		11

Part No.	AL-value (nH/N ²)	Core loss (W) at 100°C		Calculated output power (forward converter mode)
		100kHz, 200mT	500kHz, 50mT	
PC44EPC25B-Z	1560±25% (1kHz, 0.5mA)*	0.65 max.		45W (100kHz)
PC50EPC25B-Z	1080±25% (1kHz, 0.5mA)*		0.22 max.	87W (500kHz)

* Coil: ø0.23 2UEW 100Ts

NI limit vs. AL-value for PC44EPC25B gapped core (Typical)

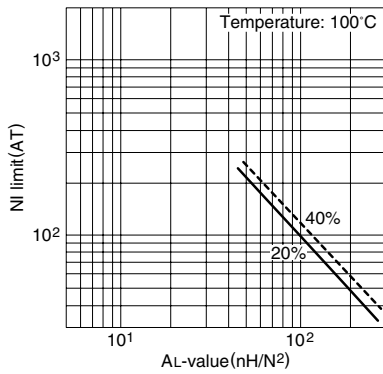

AL-value vs. Air gap length for PC44EPC25B core (Typical)

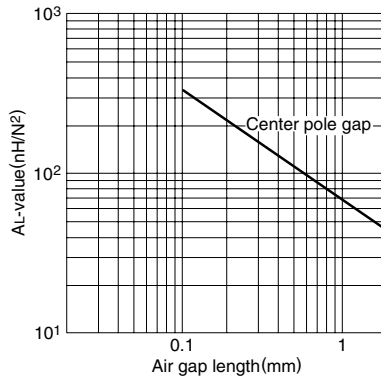

Temperature rise vs. Total loss for EPC25B core (Typical) (Ambient temperature: 25°C)

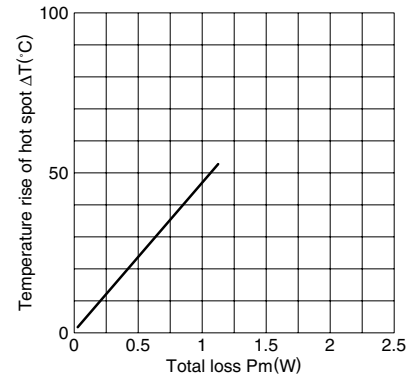

Note: The temperature rise is measured in the room whose temperature and humidity are fixed to 25°C and 45%RH, respectively. (approx. 400×300×300cm)

NI limit vs. AL-value for PC50EPC25B gapped core (Typical)

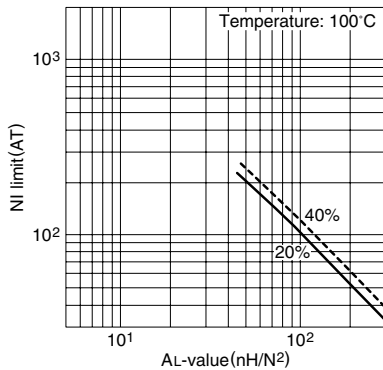

Note: NI limit shows the point where the exciting current is 20% and 40% away from its extended linear part.

AL-value vs. Air gap length for PC50EPC25B core (Typical)

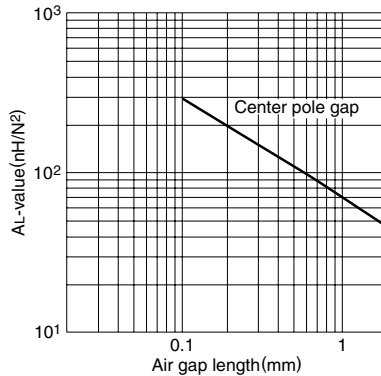

Measuring conditions • Coil: ø0.23 2UEW 100Ts
• Frequency: 1kHz
• Level: 0.5mA

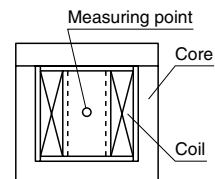

EPC Series EPC27 Cores

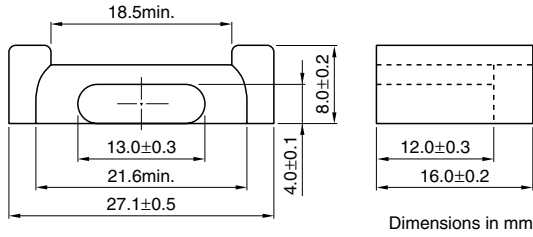

Parameter

Core factor	C1	mm ⁻¹	1.34
Effective magnetic path length	ℓ _e	mm	73.1
Effective cross-sectional area	A _e	mm ²	54.6
Effective core volume	V _e	mm ³	4000
Cross-sectional center pole area	A _{cp}	mm ²	48.6
Minimum cross-sectional area	A _{cp min.}	mm ²	46.5
Cross-sectional winding area of core	A _{cw}	mm ²	108
Weight (approx.)		g	18

Part No.	AL-value (nH/N ²)	Core loss (W) at 100°C		Calculated output power (forward converter mode)
		100kHz, 200mT	500kHz, 50mT	
PC44EPC27-Z	1540±25% (1kHz, 0.5mA)*	1.56 max.		80W (100kHz)
PC50EPC27-Z	1030±25% (1kHz, 0.5mA)*		0.46 max.	161W (500kHz)

* Coil: ø0.3 2UEW 100Ts

NI limit vs. AL-value for PC44EPC27 gapped core (Typical)

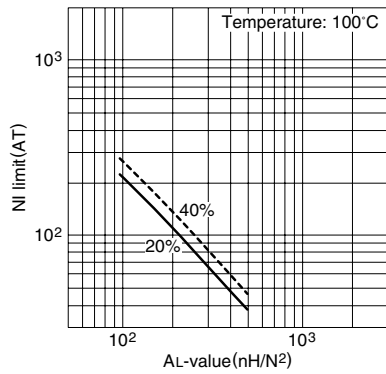

AL-value vs. Air gap length for PC44EPC27 core (Typical)

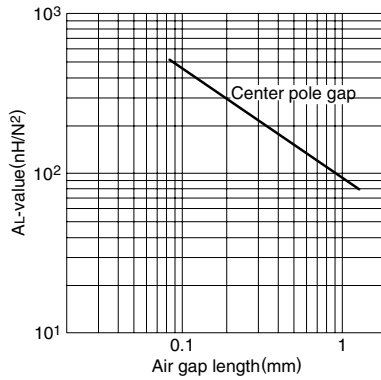

Temperature rise vs. Total loss for EPC27 core (Typical) (Ambient temperature: 25°C)

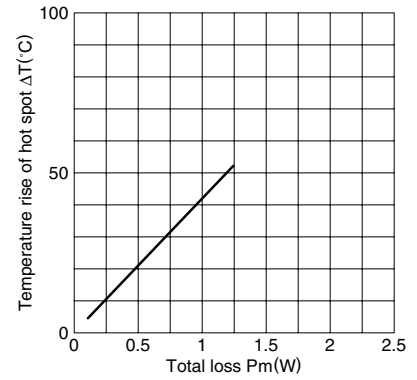

Note: The temperature rise is measured in the room whose temperature and humidity are fixed to 25°C and 45%RH, respectively. (approx. 400×300×300cm)

NI limit vs. AL-value for PC50EPC27 gapped core (Typical)

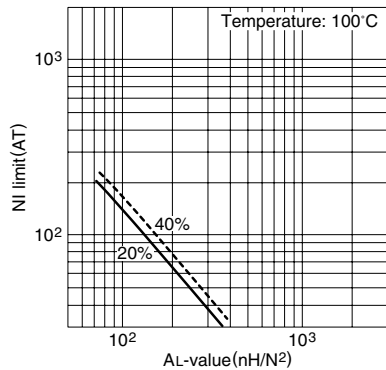

Note: NI limit shows the point where the exciting current is 20% and 40% away from its extended linear part.

AL-value vs. Air gap length for PC50EPC27 core (Typical)

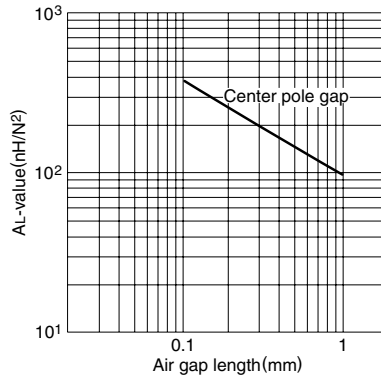

Measuring conditions • Coil: ø0.3 2UEW 100Ts
• Frequency: 1kHz
• Level: 0.5mA

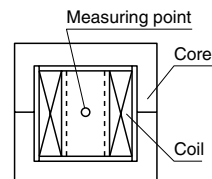

• All specifications are subject to change without notice.

EPC Series EPC27N Cores

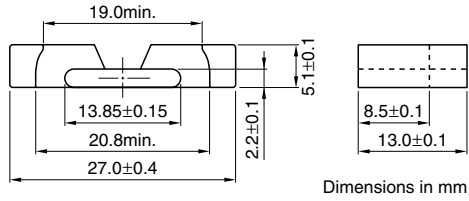

Parameter

Core factor	C1	mm ⁻¹	1.70
Effective magnetic path length	ℓ _e	mm	55.9
Effective cross-sectional area	A _e	mm ²	33.0
Effective core volume	V _e	mm ³	1840
Cross-sectional center pole area	A _{cp}	mm ²	29.7
Minimum cross-sectional center pole area	A _{cp min.}	mm ²	29.7
Cross-sectional winding area of core	A _{cw}	mm ²	60.4
Weight (approx.)	g		10

Part No.	AL-value (nH/N ²)	Core loss (W) at 100°C 100kHz, 200mT	Calculated output power (forward converter mode)
PC44EPC27N-Z	1400±25% (1kHz, 0.5mA)*	0.73 max.	43W (100kHz)

* Coil: ø0.3 2UEW 100Ts

NI limit vs. AL-value for PC44EPC27N gapped core (Typical)

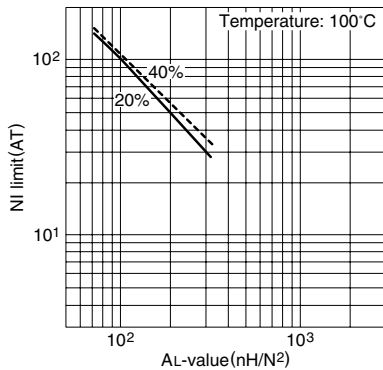

Note: NI limit shows the point where the exciting current is 20% and 40% away from its extended linear part.

AL-value vs. Air gap length for PC44EPC27N core (Typical)

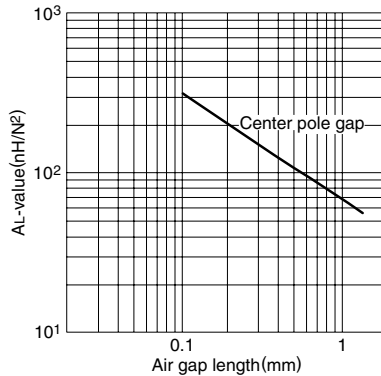

Measuring conditions • Coil: ø0.3 2UEW 100Ts
• Frequency: 1kHz
• Level: 0.5mA

Temperature rise vs. Total loss for EPC27N core (Typical)

(Ambient temperature: 25°C)

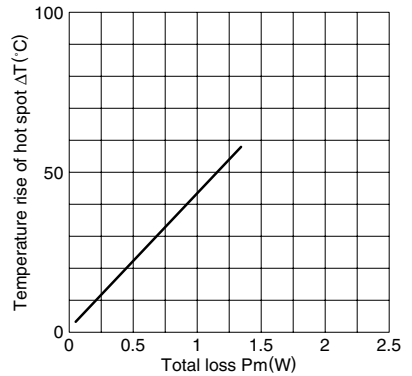

Note: The temperature rise is measured in the room whose temperature and humidity are fixed to 25°C and 45%RH, respectively. (approx. 400×300×300cm)

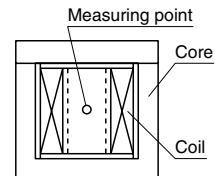

EPC Series EPC30 Cores

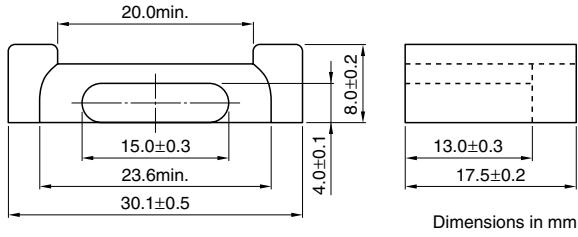

Parameter

Core factor	C1	mm ⁻¹	1.34
Effective magnetic path length	ℓ _e	mm	81.6
Effective cross-sectional area	A _e	mm ²	61.0
Effective core volume	V _e	mm ³	4980
Cross-sectional center pole area	A _{cp}	mm ²	56.6
Minimum cross-sectional area	A _{cp min.}	mm ²	54.3
Cross-sectional winding area of core	A _{cw}	mm ²	117
Weight (approx.)		g	23

Part No.	AL-value (nH/N ²)	Core loss (W) at 100°C		Calculated output power (forward converter mode)
		100kHz, 200mT	500kHz, 50mT	
PC44EPC30-Z	1570±25% (1kHz, 0.5mA)*	2.03 max.		85W (100kHz)
PC50EPC30-Z	1060±25% (1kHz, 0.5mA)*		0.58 max.	180W (500kHz)

* Coil: ø0.3 2UEW 100Ts

NI limit vs. AL-value for PC44EPC30 gapped core (Typical)

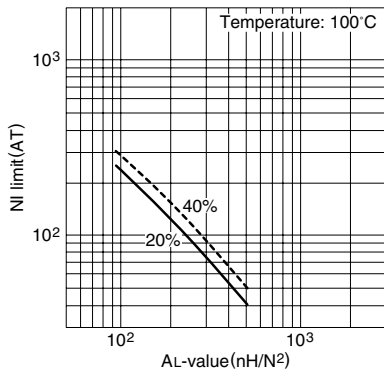

AL-value vs. Air gap length for PC44EPC30 core (Typical)

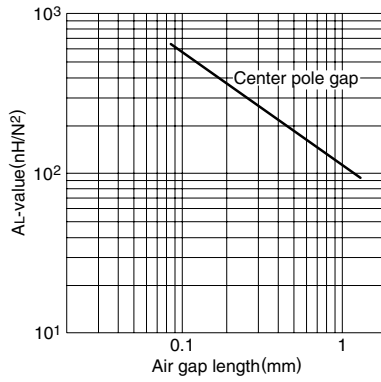

Temperature rise vs. Total loss for EPC30 core (Typical) (Ambient temperature: 25°C)

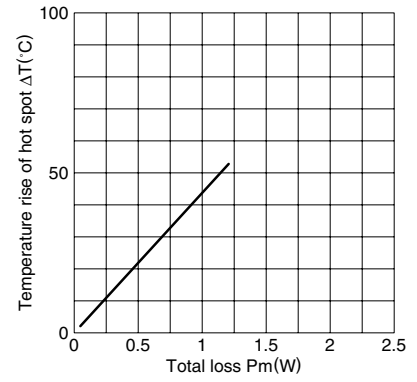

Note: The temperature rise is measured in the room whose temperature and humidity are fixed to 25°C and 45%RH, respectively. (approx. 400×300×300cm)

NI limit vs. AL-value for PC50EPC30 gapped core (Typical)

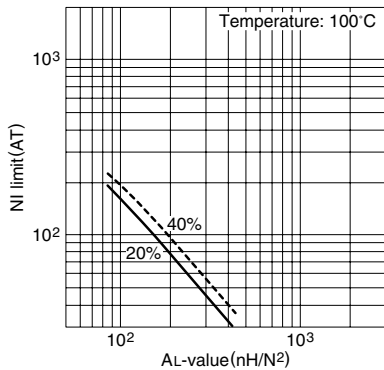

Note: NI limit shows the point where the exciting current is 20% and 40% away from its extended linear part.

AL-value vs. Air gap length for PC50EPC30 core (Typical)

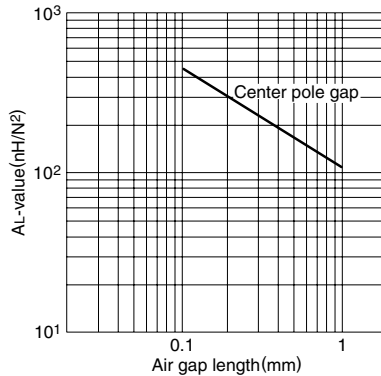

Measuring conditions • Coil: ø0.3 2UEW 100Ts
• Frequency: 1kHz
• Level: 0.5mA

