

NTC/PTC Thermistors for Automotive

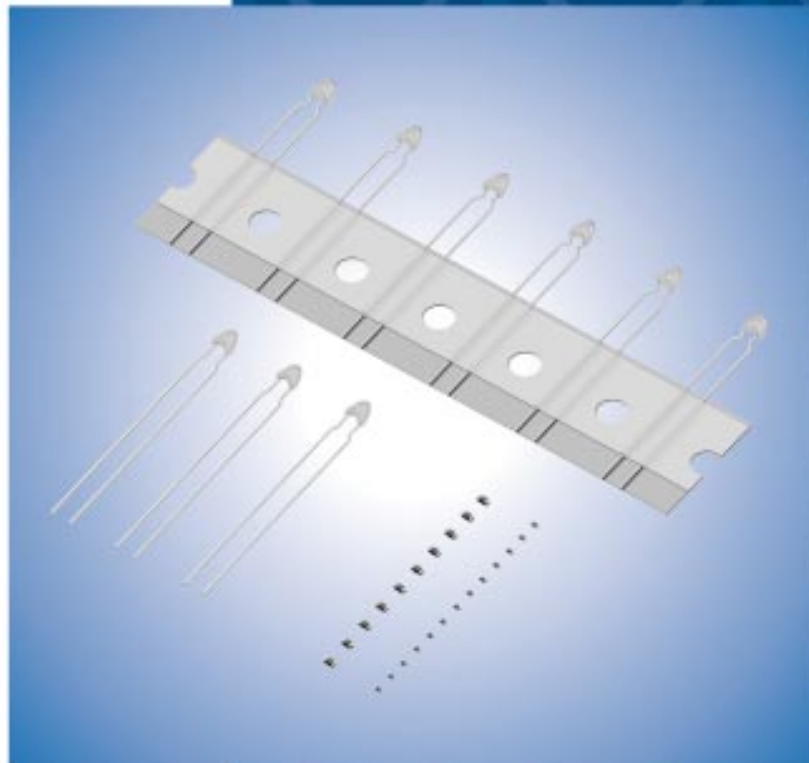

Cat.No.R03E-3

muRata *Innovator
in Electronics*
Murata
Manufacturing Co., Ltd.

CONTENTS

POSISTOR® and "POSISTOR" in this catalog are the trademarks of Murata Manufacturing Co., Ltd.

	Part Numbering	2	1
	Basic Characteristics of NTC Thermistor	6	2
	Basic Characteristics of POSISTOR®	7	
1	NTC Thermistor Chip Type 0402 (1005) Size	8	
2	NTC Thermistor Chip Type 0603 (1608) Size	10	3
	For NTC Thermistors Chip Type Standard Land Pattern Dimensions	11	
	For NTC Thermistors Chip Type Temperature Characteristics (Center Value)	12	
	For NTC Thermistors Chip Type Specifications and Test Methods	15	
	For NTC Thermistors Chip Type △Caution/Notice	17	4
3	NTC Thermistor Lead Type for Temperature Sensor	20	
	● For NTC Thermistors Lead Type Temperature Characteristics (Center Value)	21	
	● For NTC Thermistors Lead Type Specifications and Test Methods	22	5
	● For NTC Thermistors Lead Type △Caution/Notice	23	
4	PTC Thermistor (POSISTOR®) for Overheat Sensing Chip Type 0603 (1608) Size	24	
	● Chip Type of POSISTOR® for Overheat Protection Specifications and Test Methods	27	6
5	PTC Thermistor (POSISTOR®) for Overcurrent Protection Chip Type 0805 (2012) Size	29	
	● Chip Type of POSISTOR® for Overheat Protection Specifications and Test Methods	31	
	For POSISTOR® Chip Type △Caution/Notice	33	
6	PTC Thermistor (POSISTOR®) for Overcurrent Protection Lead Type	39	
	● POSISTOR® Lead Type for Overheat Protection Specifications and Test Methods	49	
	● POSISTOR® Lead Type for Overheat Protection △Caution/Notice	52	
	For NTC Thermistors Chip Type Package	53	
	For NTC Thermistors Lead Type Package	55	
	For POSISTOR® Chip Type Package	56	
	For POSISTOR® Lead Type Package	57	

● Part Numbering

NTC Thermistors for Temperature Compensation Chip Type

(Part Number)

NC	P	18	XH	103	J	0S	RB
①	②	③	④	⑤	⑥	⑦	⑧

① Product ID

Product ID	
NC	NTC Thermistors Chip Type

② Series

Code	Series
P	Plated Termination Series

③ Dimensions (L×W)

Code	Dimensions (L×W)	EIA
15	1.00×0.50mm	0402
18	1.60×0.80mm	0603

④ Temperature Characteristics

Code	Temperature Characteristics
WB	Nominal B-Constant 4050–4099K
WD	Nominal B-Constant 4150–4199K
WF	Nominal B-Constant 4250–4299K
WL	Nominal B-Constant 4450–4499K
WM	Nominal B-Constant 4500–4549K
XC	Nominal B-Constant 3100–3149K
XF	Nominal B-Constant 3250–3299K
XQ	Nominal B-Constant 3650–3699K
XH	Nominal B-Constant 3350–3399K
XM	Nominal B-Constant 3500–3549K
XV	Nominal B-Constant 3900–3949K
XW	Nominal B-Constant 3950–3999K

⑤ Resistance

Expressed by three figures. The unit is ohm (Ω). The first and second figures are significant digits, and the third figure expresses the number of zeros which follow the two figures.

Ex.)

Code	Resistance
102	1k Ω
103	10k Ω
104	100k Ω

⑥ Resistance Tolerance

Code	Resistance Tolerance
E	±3%
F	±1%
J	±5%

⑦ Individual Specifications

Structures and others are expressed by two figures.

Code	Individual Specifications
0S	for Automotive

⑧ Packaging

Code	Packaging
RB	Paper Taping 4mm Pitch (4000 pcs.)
RC	Paper Taping 2mm Pitch (10000 pcs.)

NTC Thermistors for Temperature Sensor Lead Type

(Part Number)

NT	SS0	XH	103	F	E1	B0
①	②	③	④	⑤	⑥	⑦

① Product ID

Product ID	
NT	NTC Thermistors

② Series

Code	Series
SS0	Temperature Sensors for Automotive Equipment

③ Temperature Characteristics

Code	Temperature Characteristics
WB	Nominal B-Constant 4050–4099K
WC	Nominal B-Constant 4100–4149K
WD	Nominal B-Constant 4150–4199K
WF	Nominal B-Constant 4250–4299K
XM	Nominal B-Constant 3500–3549K
XH	Nominal B-Constant 3350–3399K
XR	Nominal B-Constant 3700–3749K
XV	Nominal B-Constant 3900–3949K

④ Resistance

Expressed by three figures. The unit is ohm (Ω). The first and second figures are significant digits, and the third figure expresses the number of zeros which follow the two figures.

Ex.)

Code	Resistance
202	2k Ω
203	20k Ω

⑤ Resistance Tolerance

Code	Resistance Tolerance
E	$\pm 3\%$
F	$\pm 1\%$

⑥ Individual Specifications

A lead structure and other specifications are expressed by two digits.

Code	Individual Specifications
E1	Bulk
N6	Standard Taping

⑦ Packaging

Code	Packaging
A0	Ammo Pack
B0	Bulk

PTC Thermistors (POSISTOR®) for Overheat Sensing Chip Type

(Part Number)

PR	F	18	BB	471	Q	S2	RB
①	②	③	④	⑤	⑥	⑦	⑧

① Product ID

Product ID	
PR	PTC Thermistors Chip Type

② Series

Code	Series
F	for Overheat Sensing

③ Dimensions (L×W)

Code	Dimensions (L×W)
18	1.60×0.80mm

④ Temperature Characteristics

Code	Temperature Characteristics
AR	Curie Point 120°C
AS	Curie Point 130°C
BA	Curie Point 110°C
BB	Curie Point 100°C
BC	Curie Point 90°C
BD	Curie Point 80°C
BE	Curie Point 70°C
BF	Curie Point 60°C
BG	Curie Point 50°C

⑤ Resistance

Expressed by three figures. The unit is ohm (Ω). The first and second figures are significant digits, and the third figure expresses the number of zeros which follow the two figures.

Ex.)

Code	Resistance
471	470 Ω

⑥ Resistance Tolerance

Code	Resistance Tolerance	Sensing Temp. Tolerance
Q	Special Tolerance	$\pm 5^\circ\text{C}$
R	Special Tolerance	$\pm 3^\circ\text{C}$

⑦ Individual Specifications

Code	Individual Specifications
S2	for Automotive

⑧ Packaging

Code	Packaging
RB	Paper Taping (4mm Pitch) (4000 pcs.)

PTC Thermistors (POSISTOR®) for Circuit Protection

(Part Number)

PR	G	21	AR	420	M	S1	RA
①	②	③	④	⑤	⑥	⑦	⑧

① Product ID

Product ID	
PR	PTC Thermistors Chip Type

② Series

Code	Series
G	for Overcurrent Protection

③ Dimensions (L×W)

Code	Dimensions (L×W)
21	2.00×1.25mm

④ Temperature Characteristics

Code	Temperature Characteristics
AR	Curie Point 120°C

⑤ Resistance

Expressed by three-digit alphanumeric. The unit is ohm (Ω). The first and second figures are significant digits, and the third figure expresses the number of zeros which follow the two figures. If there is a decimal point, it is expressed by the capital letter "R". In this case, all figures are significant digits.

Ex.)

Code	Resistance
420	42 Ω
471	470 Ω

⑥ Resistance Tolerance

Code	Resistance Tolerance
M	$\pm 20\%$
Q	Special Tolerance

⑦ Individual Specifications

Code	Individual Specifications
S1	for Automotive

⑧ Packaging

Code	Packaging
RA	Embossed Taping (4mm Pitch) (4000 pcs.)
RK	Embossed Taping (4mm Pitch) (3000 pcs.)

PTC Thermistors (POSISTOR®) for Circuit Protection Lead Type

(Part Number)

PT	GL	4	S	AS	220	K	4B51	B0
①	②	③	④	⑤	⑥	⑦	⑧	⑨

① Product ID

Product ID	
PT	PTC Thermistors

② Series

Code	Series
GL	for Circuit Protection Lead Type

③ Dimensions

Code	Dimensions
4	Nominal Body Diameter 4mm Series
5	Nominal Body Diameter 5mm Series
6	Nominal Body Diameter 6mm Series
7	Nominal Body Diameter 7mm Series
9	Nominal Body Diameter 9mm Series
A	Nominal Body Diameter 10mm Series
C	Nominal Body Diameter 12mm Series
E	Nominal Body Diameter 14mm Series

④ Individual Specifications

Code	Individual Specifications
S	for Automotive

⑤ Temperature Characteristics

Code	Temperature Characteristics
AR	Curie Point 120°C
AS	Curie Point 130°C

⑥ Resistance

Expressed by three-digit alphanumerics. The unit is ohm (Ω). The first and second figures are significant digits, and the third figure expresses the number of zeros which follow the two figures. If there is a decimal point, it is expressed by the capital letter "R". In this case, all figures are significant digits.

Ex.)

Code	Resistance
R22	0.22 Ω
2R2	2.2 Ω
220	22 Ω

⑦ Resistance Tolerance

Code	Resistance Tolerance
K	$\pm 10\%$
M	$\pm 20\%$

⑧ Individual Specifications

Ex.)

Code	Individual Specifications
4B51	Lead Type, others

⑨ Packaging

Code	Packaging
A0	Ammo Pack
B0	Bulk

Basic Characteristics of NTC Thermistor

Basic Characteristics

1. Zero-power Resistance of Thermistor: R

Measured by zero-power in specified ambient temperatures.

$$R = R_0 \exp B (1/T - 1/T_0) \dots\dots\dots(1)$$

R: Resistance in ambient temperature T (K)
(K: absolute temperature)

R₀: Resistance in ambient temperature T₀ (K)

B: B-constant of Thermistor

2. B-Constant

as (1) formula

$$B = \ln (R/R_0) / (1/T - 1/T_0) \dots\dots\dots(2)$$

3. Thermal Dissipation Constant

When electric power P (mW) is spent in ambient temperature T₁ and thermistor temperature rises T₂, there is a formula as follows

$$P = C (T_2 - T_1) \dots\dots\dots(3)$$

C: Thermal dissipation constant (mW/°C)

Thermal dissipation constant is varied with dimensions, measurement conditions, etc.

4. Thermal Time Constant

Period in which Thermistor's temperature will change 63.2% of its temperature difference from ambient temperature T₀ (°C) to T₁ (°C).

5. Rated Electric Power

Shows necessary electric power that Thermistor's temperature rises 100°C by self heating in ambient temperature 25°C.

6. Permissive Operating Current

It is possible to keep Thermistor's temperature rising max. 1°C.

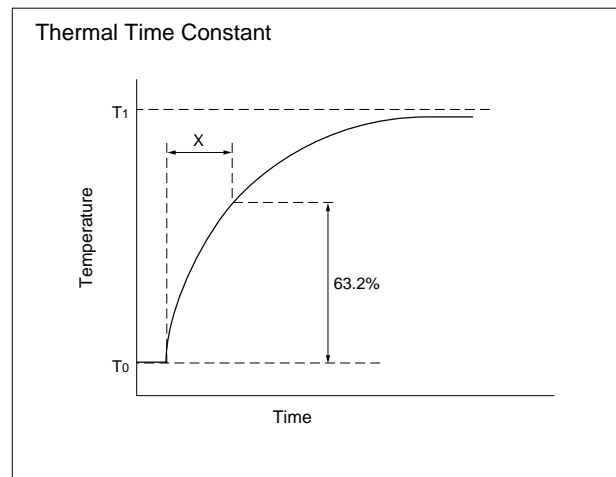
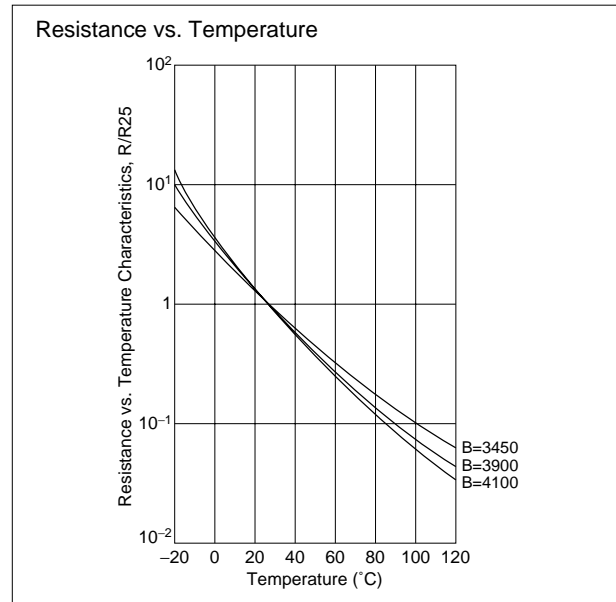

Basic Characteristics of POSISTOR®

Basic Characteristics

POSISTOR® has three main characteristics.

1. Resistance - Temperature Characteristics

Although there is a negligible difference between the normal and "Curie Point" temperature, POSISTOR® shows almost constant resistance - temperature characteristics. Yet they have resistance - temperature characteristics that cause resistance to sharply increase when the temperature exceeds the Curie Point. The Curie Point (C.P.) is defined as temperature which the resistance value is twice the one at 25 °C.

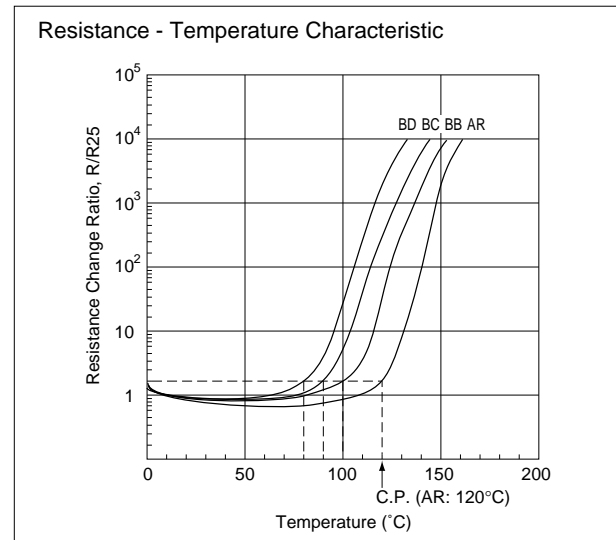

2. Current - Voltage Characteristics (Static Characteristics)

This shows the relation between applied voltage when voltage applied to POSISTOR® causes balancing of inner heating and outer thermal dissipation and stabilized current. This has both a maximum point of current and constant output power.

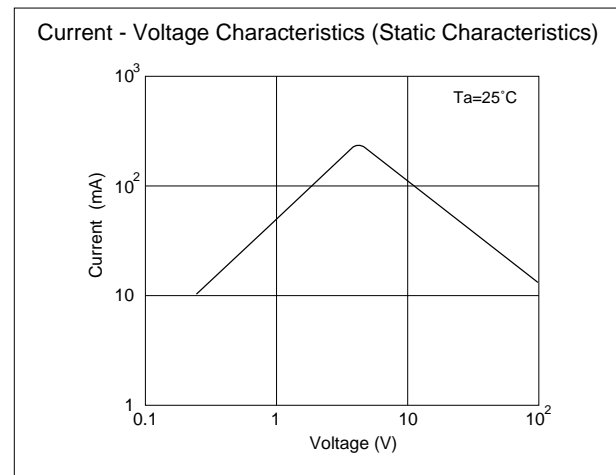

3. Current - Time Characteristics (Dynamic Characteristics)

This shows the relation between current and time before inner heating and outer thermal dissipation arrive at equilibrium state. This features having large initial current and abruptly continuous attenuating portion.

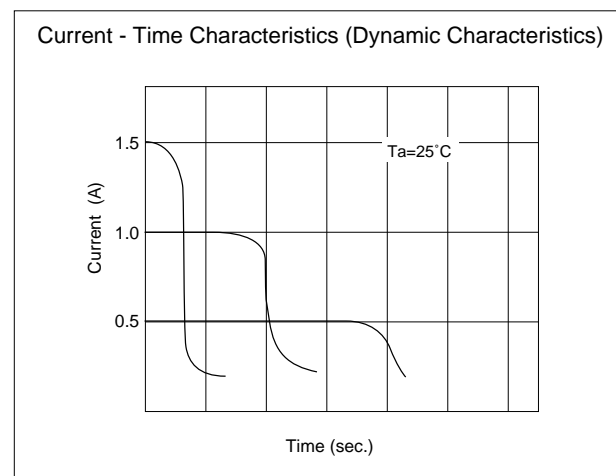

NTC/PTC Thermistors for Automotive



NTC Thermistor Chip Type 0402 (1005) Size (Meet AEC-Q200rev.C)

0402/0603 sized Chip NTC Thermistors have Ni barrier termination and provide excellent solderability and offer high stability in environment by unique inner construction.

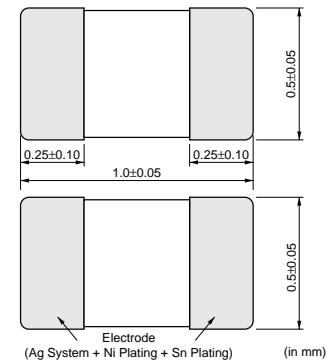

■ Features

1. NCP15xx0S series can meet AEC-Q200rev.C requirements
2. Excellent solderability and high stability in environment
3. Excellent long time aging stability
4. High accuracy in resistance and B-constant
5. Reflow soldering possible
6. Lead is not contained in the product
7. NCP15 series are recognized by UL (UL1434, File No.E137188 Vol.2, Sec.2).

■ Applications

1. Car audio, car navigation
2. Various engine control units
3. Circuits for ETC equipment
4. Various motor driving circuits
5. Temperature compensation for various circuits

Part Number	Resistance (25°C) (ohm)	B-Constant (25-50°C) (K)	Permissible Operating Current (25°C) (mA)	Rated Electric Power (25°C) (mW)	Typical Dissipation Constant (25°C) (mW/°C)	Operating Temperature Range (°C)
NCP15XC220□0SRC	22	3100 ±3%	6.70	100	1.0	-40 to 125
NCP15XC330□0SRC	33	3100 ±3%	5.50	100	1.0	-40 to 125
NCP15XC470□0SRC	47	3100 ±3%	4.60	100	1.0	-40 to 125
NCP15XC680□0SRC	68	3100 ±3%	3.80	100	1.0	-40 to 125
NCP15XF101□0SRC	100	3250 ±3%	3.10	100	1.0	-40 to 125
NCP15XF151□0SRC	150	3250 ±3%	2.50	100	1.0	-40 to 125
NCP15XM221□0SRC	220	3500 ±3%	2.10	100	1.0	-40 to 125
NCP15XM331□0SRC	330	3500 ±3%	1.70	100	1.0	-40 to 125
NCP15XQ471□0SRC	470	3650 ±2%	1.40	100	1.0	-40 to 125
NCP15XQ681□0SRC	680	3650 ±3%	1.20	100	1.0	-40 to 125
NCP15XQ102□0SRC	1.0k	3650 ±2%	1.00	100	1.0	-40 to 125
NCP15XW152□0SRC	1.5k	3950 ±3%	0.81	100	1.0	-40 to 125
NCP15XW222□0SRC	2.2k	3950 ±3%	0.67	100	1.0	-40 to 125
NCP15XW332□0SRC	3.3k	3950 ±3%	0.55	100	1.0	-40 to 125
NCP15XM472□0SRC	4.7k	3500 ±2%	0.46	100	1.0	-40 to 125
NCP15XW682□0SRC	6.8k	3950 ±3%	0.38	100	1.0	-40 to 125
NCP15XH103□0SRC	10k	3380 ±1%	0.31	100	1.0	-40 to 125
NCP15XV103□0SRC	10k	3900 ±3%	0.31	100	1.0	-40 to 125
NCP15XW153□0SRC	15k	3950 ±3%	0.25	100	1.0	-40 to 125
NCP15WL223□0SRC	22k	4485 ±1%	0.21	100	1.0	-40 to 125
NCP15XW223□0SRC	22k	3950 ±3%	0.21	100	1.0	-40 to 125
NCP15WB333□0SRC	33k	4050 ±3%	0.17	100	1.0	-40 to 125
NCP15WL333□0SRC	33k	4485 ±1%	0.17	100	1.0	-40 to 125
NCP15WB473□0SRC	47k	4050 ±1%	0.14	100	1.0	-40 to 125
NCP15WL473□0SRC	47k	4485 ±1%	0.14	100	1.0	-40 to 125
NCP15WD683□0SRC	68k	4150 ±3%	0.12	100	1.0	-40 to 125

Continued on the following page.

Continued from the preceding page.

Part Number	Resistance (25°C) (ohm)	B-Constant (25-50°C) (K)	Permissible Operating Current (25°C) (mA)	Rated Electric Power (25°C) (mW)	Typical Dissipation Constant (25°C) (mW/°C)	Operating Temperature Range (°C)
NCP15WL683□0SRC	68k	4485 ±1%	0.12	100	1.0	-40 to 125
NCP15WF104□0SRC	100k	4250 ±1%	0.10	100	1.0	-40 to 125
NCP15WL104□0SRC	100k	4485 ±1%	0.10	100	1.0	-40 to 125
NCP15WL154□0SRC	150k	4485 ±1%	0.08	100	1.0	-40 to 125
NCP15WM154□0SRC	150k	4500 ±3%	0.08	100	1.0	-40 to 125
NCP15WM224□0SRC	220k	4500 ±3%	0.06	100	1.0	-40 to 125
NCP15WM474□0SRC	470k	4500 ±3%	0.04	100	1.0	-40 to 125

A blank column is filled with resistance tolerance codes (J: ±5%). Please contact us for other tolerances.

Resistance tolerance ±1% is also available for the following type.

10k ohm: NCP15XH103F0SRC

47k ohm: NCP15WB473F0SRC

100k ohm: NCP15WF104F0SRC

NTC/PTC Thermistors for Automotive



NTC Thermistor Chip Type 0603 (1608) Size (Meet AEC-Q200rev.C)

2

0402/0603 sized Chip NTC Thermistors have Ni barrier termination and provide excellent solderability and offer high stability in environment by unique inner construction.

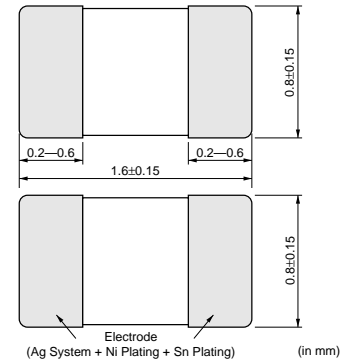

■ Features

1. NCP18xx0S series can meet AEC-Q200rev.C requirements
2. Excellent solderability and high stability in environment
3. Excellent long time aging stability
4. High accuracy in resistance and B-constant
5. Flow/Reflow soldering possible
6. Lead is not contained in the product
7. NCP18 series are recognized by UL
(UL1434, File No.E137188 Vol.2, Sec.2).

■ Applications

1. Car audio, car navigation
2. Various engine control units
3. Circuits for ETC equipment
4. Various motor driving circuits
5. Temperature compensation for various circuits

Part Number	Resistance (25°C) (ohm)	B-Constant (25-50°C) (K)	Permissible Operating Current (25°C) (mA)	Rated Electric Power (25°C) (mW)	Typical Dissipation Constant (25°C) (mW/°C)	Operating Temperature Range (°C)
NCP18XF101□0SRB	100	3250 ±3%	3.10	100	1.0	-40 to 125
NCP18XF151□0SRB	150	3250 ±3%	2.50	100	1.0	-40 to 125
NCP18XM221□0SRB	220	3500 ±3%	2.10	100	1.0	-40 to 125
NCP18XM331□0SRB	330	3500 ±3%	1.70	100	1.0	-40 to 125
NCP18XQ471□0SRB	470	3650 ±2%	1.40	100	1.0	-40 to 125
NCP18XQ681□0SRB	680	3650 ±3%	1.20	100	1.0	-40 to 125
NCP18XQ102□0SRB	1.0k	3650 ±2%	1.00	100	1.0	-40 to 125
NCP18XW152□0SRB	1.5k	3950 ±3%	0.81	100	1.0	-40 to 125
NCP18XW222□0SRB	2.2k	3950 ±3%	0.67	100	1.0	-40 to 125
NCP18XW332□0SRB	3.3k	3950 ±3%	0.55	100	1.0	-40 to 125
NCP18XM472□0SRB	4.7k	3500 ±2%	0.46	100	1.0	-40 to 125
NCP18XW682□0SRB	6.8k	3950 ±3%	0.38	100	1.0	-40 to 125
NCP18XH103□0SRB	10k	3380 ±1%	0.31	100	1.0	-40 to 125
NCP18XW153□0SRB	15k	3950 ±3%	0.25	100	1.0	-40 to 125
NCP18XW223□0SRB	22k	3950 ±3%	0.21	100	1.0	-40 to 125
NCP18WB333□0SRB	33k	4050 ±3%	0.17	100	1.0	-40 to 125
NCP18WB473□1SRB	47k	4050 ±1.5%	0.14	100	1.0	-40 to 125
NCP18WB473□0SRB	47k	4050 ±2%	0.14	100	1.0	-40 to 125
NCP18WD683□0SRB	68k	4150 ±3%	0.12	100	1.0	-40 to 125
NCP18WF104□3SRB	100k	4200 ±1%	0.10	100	1.0	-40 to 125
NCP18WF104□0SRB	100k	4250 ±2%	0.10	100	1.0	-40 to 125
NCP18WM154□0SRB	150k	4500 ±3%	0.08	100	1.0	-40 to 125
NCP18WM224□0SRB	220k	4500 ±3%	0.06	100	1.0	-40 to 125
NCP18WM474□0SRB	470k	4500 ±3%	0.04	100	1.0	-40 to 125

A blank column is filled with resistance tolerance codes (J: ±5%). Please contact us for other tolerances.

Resistance tolerance ±1% is also available for the following type.

10k ohm: NCP18XH103F0SRB

47k ohm: NCP18WB473F1SRB

100k ohm: NCP18WF104F3SRB

For NTC Thermistors Chip Type Standard Land Pattern Dimensions

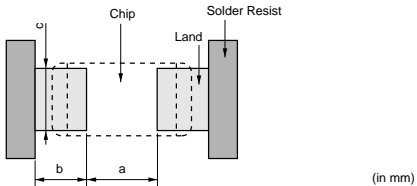

Part Number	Soldering Methods	Dimensions (mm)			
		Chip (L×W)	a	b	c
NCP15	Reflow Soldering	1.0×0.5	0.4	0.4-0.5	0.5
	Flow Soldering	1.6×0.8	0.6-1.0	0.8-0.9	0.6-0.8
Reflow Soldering	0.6-0.8		0.6-0.7	0.6-0.8	

For NTC Thermistors Chip Type Temperature Characteristics (Center Value)

Part Number	NCP□□XC220	NCP□□XC330	NCP□□XC470	NCP□□XC680	NCP□□XF101	NCP□□XF151
Resistance	22Ω	33Ω	47Ω	68Ω	100Ω	150Ω
B-Constant	3100K	3100K	3100K	3100K	3250K	3250K
Temp. (°C)	Resistance (Ω)	Resistance (Ω)	Resistance (Ω)	Resistance (Ω)	Resistance (Ω)	Resistance (Ω)
-40	355.823	533.734	760.166	1099.815	1824.175	2736.262
-35	273.975	410.962	585.310	846.832	1390.685	2086.028
-30	213.003	319.504	455.051	658.372	1070.653	1605.979
-25	166.943	250.415	356.652	516.007	831.138	1246.708
-20	131.997	197.996	281.994	407.991	650.960	976.440
-15	105.318	157.978	224.998	325.529	514.441	771.661
-10	84.670	127.005	180.886	261.707	409.700	614.550
-5	68.628	102.942	146.614	212.123	328.877	493.315
0	55.981	83.972	119.596	173.033	265.759	398.639
5	45.859	68.789	97.972	141.747	215.785	323.677
10	37.819	56.728	80.794	116.894	176.395	264.592
15	31.396	47.094	67.073	97.042	145.161	217.742
20	26.211	39.317	55.997	81.016	120.152	180.228
25	22.000	33.000	47.000	68.000	100.000	150.000
30	18.560	27.840	39.651	57.368	83.669	125.503
35	15.735	23.603	33.616	48.636	70.361	105.541
40	13.403	20.104	28.633	41.426	59.456	89.184
45	11.462	17.193	24.487	35.428	50.470	75.705
50	9.842	14.763	21.026	30.421	43.029	64.543
55	8.488	12.732	18.133	26.235	36.830	55.246
60	7.348	11.022	15.698	22.712	31.649	47.473
65	6.399	9.598	13.670	19.778	27.364	41.045
70	5.595	8.392	11.952	17.293	23.756	35.634
75	4.896	7.345	10.461	15.134	20.651	30.976
80	4.299	6.448	9.184	13.288	18.011	27.016
85	3.795	5.692	8.107	11.729	15.800	23.700
90	3.360	5.040	7.179	10.386	13.908	20.862
95	2.983	4.474	6.373	9.220	12.263	18.394
100	2.656	3.983	5.673	8.208	10.844	16.265
105	2.367	3.551	5.057	7.317	9.622	14.434
110	2.116	3.173	4.520	6.539	8.563	12.844
115	1.901	2.851	4.060	5.874	7.648	11.472
120	1.712	2.568	3.657	5.291	6.850	10.275
125	1.543	2.314	3.296	4.768	6.162	9.243

Part Number	NCP□□XM221	NCP□□XM331	NCP□□XQ471	NCP□□XQ681	NCP□□XQ102	NCP□□XW152
Resistance	220Ω	330Ω	470Ω	680Ω	1.0kΩ	1.5kΩ
B-Constant	3500K	3500K	3650K	3650K	3650K	3950K
Temp. (°C)	Resistance (Ω)	Resistance (Ω)	Resistance (Ω)	Resistance (Ω)	Resistance (kΩ)	Resistance (kΩ)
-40	4947.904	7421.856	11822.473	17104.854	25.154	51.791
-35	3703.755	5555.632	8767.745	12685.248	18.655	37.172
-30	2798.873	4198.309	6570.224	9505.855	13.979	27.005
-25	2135.887	3203.831	4971.784	7193.219	10.578	19.843
-20	1645.037	2467.555	3796.933	5493.436	8.079	14.728
-15	1278.034	1917.051	2923.400	4229.599	6.220	11.044
-10	1000.620	1500.930	2269.599	3283.675	4.829	8.362
-5	789.612	1184.418	1775.225	2568.411	3.777	6.389
0	627.752	941.628	1399.050	2024.158	2.977	4.922
5	502.474	753.711	1110.220	1606.275	2.362	3.825
10	405.010	607.514	887.257	1283.691	1.888	2.994
15	328.480	492.720	713.463	1032.245	1.518	2.361
20	268.044	402.066	577.375	835.351	1.229	1.876
25	220.000	330.000	470.000	680.000	1.000	1.500
30	181.576	272.365	384.800	556.733	0.819	1.207
35	150.668	226.002	316.757	458.287	0.674	0.978
40	125.681	188.521	262.177	379.320	0.558	0.797
45	105.336	158.004	218.069	315.504	0.464	0.653
50	88.717	133.076	182.297	263.749	0.388	0.538
55	75.059	112.588	153.150	221.579	0.326	0.446
60	63.777	95.666	129.249	186.998	0.275	0.371
65	54.415	81.622	109.551	158.499	0.233	0.311
70	46.631	69.946	93.281	134.960	0.199	0.261
75	40.115	60.172	79.750	115.383	0.170	0.221
80	34.637	51.955	68.446	99.029	0.146	0.187
85	30.013	45.019	58.996	85.356	0.126	0.160
90	26.110	39.165	51.036	73.839	0.109	0.137
95	22.790	34.186	44.332	64.140	0.094	0.117
100	19.957	29.935	38.640	55.905	0.082	0.101
105	17.541	26.312	33.790	48.888	0.072	0.088
110	15.453	23.180	29.664	42.918	0.063	0.076
115	13.663	20.494	26.123	37.795	0.056	0.067
120	12.114	18.171	23.091	33.409	0.049	0.058
125	10.778	16.168	20.472	29.618	0.044	0.051

Detailed Resistance-Temperature Tables are downloadable from the following URL.
<http://search.murata.co.jp/Ceramy/CatsearchAction.do?sLang=en>

Continued on the following page. 

For NTC Thermistors Chip Type Temperature Characteristics (Center Value)

Continued from the preceding page.

Part Number	NCP□□XW222	NCP□□XW332	NCP□□XM472	NCP□□XW682	NCP□□XH103	NCP□□XV103
Resistance	2.2kΩ	3.3kΩ	4.7kΩ	6.8kΩ	10kΩ	10kΩ
B-Constant	3950K	3950K	3500K	3950K	3380K	3900K
Temp. (°C)	Resistance (kΩ)	Resistance (kΩ)	Resistance (kΩ)	Resistance (kΩ)	Resistance (kΩ)	Resistance (kΩ)
-40	75.961	113.941	105.705	234.787	195.652	328.996
-35	54.520	81.779	79.126	168.515	148.171	237.387
-30	39.607	59.411	59.794	122.422	113.347	173.185
-25	29.103	43.654	45.630	89.953	87.559	127.773
-20	21.601	32.401	35.144	66.766	68.237	95.327
-15	16.198	24.297	27.303	50.066	53.650	71.746
-10	12.264	18.396	21.377	37.906	42.506	54.564
-5	9.370	14.055	16.869	28.963	33.892	41.813
0	7.219	10.829	13.411	22.313	27.219	32.330
5	5.609	8.414	10.735	17.338	22.021	25.194
10	4.391	6.586	8.653	13.571	17.926	19.785
15	3.463	5.195	7.018	10.705	14.674	15.651
20	2.751	4.126	5.726	8.503	12.081	12.468
25	2.200	3.300	4.700	6.800	10.000	10.000
30	1.771	2.656	3.879	5.474	8.315	8.072
35	1.434	2.152	3.219	4.434	6.948	6.556
40	1.169	1.753	2.685	3.613	5.834	5.356
45	0.958	1.437	2.250	2.961	4.917	4.401
50	0.789	1.184	1.895	2.440	4.161	3.635
55	0.654	0.981	1.604	2.022	3.535	3.019
60	0.545	0.817	1.363	1.683	3.014	2.521
65	0.456	0.684	1.163	1.409	2.586	2.115
70	0.383	0.575	0.996	1.185	2.228	1.781
75	0.324	0.486	0.857	1.001	1.925	1.509
80	0.275	0.412	0.740	0.849	1.669	1.284
85	0.234	0.351	0.641	0.724	1.452	1.097
90	0.200	0.301	0.558	0.620	1.268	0.941
95	0.172	0.258	0.487	0.532	1.110	0.810
100	0.149	0.223	0.426	0.459	0.974	0.701
105	0.129	0.193	0.375	0.398	0.858	0.608
110	0.112	0.168	0.330	0.346	0.758	0.530
115	0.098	0.146	0.292	0.302	0.672	0.463
120	0.085	0.128	0.259	0.264	0.596	0.406
125	0.075	0.113	0.230	0.232	0.531	0.358

Part Number	NCP□□XW153	NCP□□XW223	NCP□□WL223	NCP□□WB333	NCP□□WL333	NCP□□WB473
Resistance	15kΩ	22kΩ	22kΩ	33kΩ	33kΩ	47kΩ
B-Constant	3950K	3950K	4485K	4050K	4485K	4050K
Temp. (°C)	Resistance (kΩ)	Resistance (kΩ)	Resistance (kΩ)	Resistance (kΩ)	Resistance (kΩ)	Resistance (kΩ)
-40	517.912	759.605	1073.436	1227.263	1610.154	1747.920
-35	371.724	545.196	753.900	874.449	1130.850	1245.428
-30	270.048	396.070	535.073	630.851	802.609	898.485
-25	198.426	291.025	383.590	460.457	575.385	655.802
-20	147.278	216.008	277.643	339.797	416.464	483.954
-15	110.439	161.977	202.813	253.363	304.219	360.850
-10	83.617	122.638	149.462	190.766	224.193	271.697
-5	63.888	93.702	111.082	144.964	166.623	206.463
0	49.221	72.191	83.233	111.087	124.850	158.214
5	38.245	56.093	62.858	85.842	94.287	122.259
10	29.936	43.907	47.831	66.861	71.747	95.227
15	23.613	34.633	36.664	52.470	54.996	74.730
20	18.756	27.509	28.304	41.471	42.455	59.065
25	15.000	22.000	22.000	33.000	33.000	47.000
30	12.074	17.709	17.214	26.430	25.822	37.643
35	9.780	14.344	13.557	21.298	20.335	30.334
40	7.969	11.688	10.744	17.266	16.115	24.591
45	6.531	9.578	8.566	14.076	12.849	20.048
50	5.382	7.894	6.871	11.538	10.306	16.433
55	4.459	6.540	5.543	9.506	8.314	13.539
60	3.713	5.446	4.497	7.870	6.746	11.209
65	3.108	4.559	3.669	6.549	5.503	9.328
70	2.613	3.832	3.009	5.475	4.513	7.798
75	2.208	3.239	2.481	4.595	3.721	6.544
80	1.873	2.748	2.056	3.874	3.084	5.518
85	1.597	2.342	1.713	3.282	2.569	4.674
90	1.367	2.004	1.434	2.789	2.151	3.972
95	1.174	1.722	1.206	2.379	1.809	3.388
100	1.013	1.486	1.019	2.038	1.529	2.902
105	0.878	1.287	0.866	1.751	1.299	2.494
110	0.763	1.119	0.739	1.509	1.108	2.150
115	0.665	0.975	0.633	1.306	0.949	1.860
120	0.582	0.854	0.545	1.134	0.817	1.615
125	0.511	0.750	0.471	0.987	0.707	1.406

Detailed Resistance-Temperature Tables are downloadable from the following URL.
<http://search.murata.co.jp/Ceramy/CatsearchAction.do?sLang=en>

Continued on the following page.



For NTC Thermistors Chip Type Temperature Characteristics (Center Value)

Continued from the preceding page.

Part Number	NCP□□WL473	NCP□□WD683	NCP□□WL683	NCP□□WF104	NCP□□WL104	NCP□□WL154
Resistance	47kΩ	68kΩ	68kΩ	100kΩ	100kΩ	150kΩ
B-Constant	4485K	4150K	4485K	4250K *	4485K	4485K
Temp. (°C)	Resistance (kΩ)	Resistance (kΩ)	Resistance (kΩ)	Resistance (kΩ)	Resistance (kΩ)	Resistance (kΩ)
-40	2293.249	2735.359	3317.893	4397.119	4879.254	7318.881
-35	1610.605	1937.391	2330.237	3088.599	3426.818	5140.228
-30	1143.110	1389.345	1653.862	2197.225	2432.149	3648.224
-25	819.487	1008.014	1185.641	1581.881	1743.590	2615.385
-20	593.146	738.978	858.168	1151.037	1262.012	1893.018
-15	433.281	547.456	626.875	846.579	921.875	1382.813
-10	319.305	409.600	461.974	628.988	679.373	1019.059
-5	237.312	309.217	343.345	471.632	504.919	757.379
0	177.816	235.606	257.266	357.012	378.333	567.499
5	134.287	180.980	194.287	272.500	285.717	428.575
10	102.184	140.139	147.841	209.710	217.414	326.121
15	78.327	109.344	113.325	162.651	166.654	249.981
20	60.467	85.929	87.484	127.080	128.653	192.979
25	47.000	68.000	68.000	100.000	100.000	150.000
30	36.776	54.167	53.208	79.222	78.247	117.370
35	28.962	43.421	41.903	63.167	61.622	92.433
40	22.952	35.016	33.208	50.677	48.835	73.252
45	18.301	28.406	26.477	40.904	38.937	58.406
50	14.679	23.166	21.237	33.195	31.231	46.846
55	11.842	18.997	17.133	27.091	25.195	37.793
60	9.607	15.657	13.900	22.224	20.441	30.661
65	7.837	12.967	11.339	18.323	16.675	25.013
70	6.428	10.794	9.300	15.184	13.677	20.516
75	5.300	9.021	7.668	12.635	11.277	16.916
80	4.393	7.575	6.356	10.566	9.346	14.019
85	3.659	6.387	5.294	8.873	7.785	11.678
90	3.063	5.407	4.432	7.481	6.517	9.776
95	2.577	4.598	3.728	6.337	5.482	8.223
100	2.178	3.922	3.151	5.384	4.634	6.951
105	1.849	3.359	2.676	4.594	3.935	5.902
110	1.578	2.887	2.283	3.934	3.357	5.035
115	1.352	2.489	1.956	3.380	2.877	4.315
120	1.164	2.155	1.684	2.916	2.476	3.714
125	1.006	1.870	1.456	2.522	2.141	3.211

Part Number	NCP□□WM154	NCP□□WM224	NCP□□WM474
Resistance	150kΩ	220kΩ	470kΩ
B-Constant	4500K	4485K	4500K
Temp. (°C)	Resistance (kΩ)	Resistance (kΩ)	Resistance (kΩ)
-40	7899.466	11585.884	24751.661
-35	5466.118	8016.973	17127.169
-30	3834.499	5623.931	12014.762
-25	2720.523	3990.100	8524.305
-20	1951.216	2861.784	6113.811
-15	1415.565	2076.162	4435.437
-10	1036.984	1520.909	3249.216
-5	767.079	1125.049	2403.515
0	572.667	839.912	1794.358
5	431.264	632.521	1351.294
10	327.405	480.194	1025.870
15	250.538	367.455	785.018
20	193.166	283.310	605.252
25	150.000	220.000	470.000
30	117.281	172.012	367.480
35	92.293	135.364	289.186
40	73.090	107.198	229.014
45	58.240	85.419	182.485
50	46.665	68.441	146.215
55	37.605	55.153	117.828
60	30.453	44.665	95.420
65	24.804	36.379	77.718
70	20.293	29.763	63.584
75	16.679	24.462	52.260
80	13.776	20.205	43.166
85	11.428	16.761	35.808
90	9.520	13.962	29.828
95	7.966	11.684	24.961
100	6.688	9.809	20.955
105	5.639	8.270	17.668
110	4.772	6.998	14.951
115	4.052	5.942	12.695
120	3.454	5.067	10.824
125	2.955	4.334	9.259

* B-Constant of NCP18WF104F1SRB is 4200K. Please contact us for the detail data.

Detailed Resistance - Temperature Tables are downloadable from the following URL.

<http://search.murata.co.jp/Ceramy/CatsearchAction.do?sLang=en>

For NTC Thermistors Chip Type Specifications and Test Methods

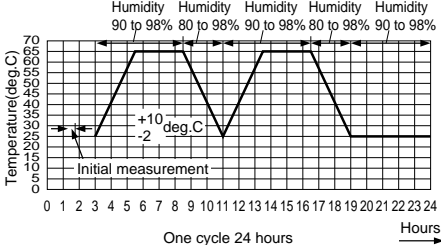
No.	AEC-Q200 Test Item	Specifications	AEC-Q200 Test Methods															
1	Pre-and Post-Stress Electrical Test	-																
2	High Temperature Exposure (Storage)	(*1) •Resistance(R ₂₅) change should be less than ±5%. •B-constant(B _{25/50}) change should be less than ±2%. •No visible damage.	125±3 °C in air for 1000 hours. Measurement at 24±2 hours after test condition.															
3	Temperature Cycling	•Resistance(R ₂₅) change should be less than ±5%. •B-constant(B _{25/50}) change should be less than ±2%. •No visible damage.	Perform the 1000 cycles according to the four heat treatments listed in the following table. <table border="1" style="margin: 10px auto; border-collapse: collapse;"> <thead> <tr> <th>Step</th> <th>1</th> <th>2</th> <th>3</th> <th>4</th> </tr> </thead> <tbody> <tr> <td>Temp. (deg.C)</td> <td>-55+0/-3</td> <td>Room Temp.</td> <td>125+3/-0</td> <td>Room Temp.</td> </tr> <tr> <td>Time (min.)</td> <td>15±3</td> <td>1</td> <td>15±3</td> <td>1</td> </tr> </tbody> </table> Measurement at 24±2 hours after test condition.	Step	1	2	3	4	Temp. (deg.C)	-55+0/-3	Room Temp.	125+3/-0	Room Temp.	Time (min.)	15±3	1	15±3	1
Step	1	2	3	4														
Temp. (deg.C)	-55+0/-3	Room Temp.	125+3/-0	Room Temp.														
Time (min.)	15±3	1	15±3	1														
4	Moisture Resistance	•Resistance(R ₂₅) change should be less than ±5%. •B-constant(B _{25/50}) change should be less than ±2%. •No visible damage.	Apply the 24 hours heat (25 to 65 °C) and humidity (80 to 98%) treatment shown below, 10 consecutive times.  Measurement at 24±2 hours after test condition.															
5	Biased Humidity	(*2) •Resistance(R ₂₅) change should be less than ±10%. •B-constant(B _{25/50}) change should be less than ±2%. •No visible damage.	85±2 °C, 85%RH in air for 1000 hours with Permissive Operating Current. Measurement at 24±2 hours after test condition.															
6	Operational Life	•Resistance(R ₂₅) change should be less than ±5%. •B-constant(B _{25/50}) change should be less than ±2%. •No visible damage.	125±3 °C in air for 1000 hours with Permissive Operating Current. Measurement at 24±2 hours after test condition.															
7	External Visual	No defects of abnormalities.	Visual Inspection.															
8	Physical Dimension	Within the specified dimensions.	Using calipers															
9	Terminal Strength (Leaded)	N/A																
10	Resistance to Solvents	•Resistance(R ₂₅) change should be less than ±5%. •B-constant(B _{25/50}) change should be less than ±2%. •No visible damage.	Per MIL-STD-202 Method 215 Solvent 1: 1 part (by volume) of isopropyl alcohol 3 part (by volume) of mineral spirits.															
11	Mechanical Shock	•Resistance(R ₂₅) change should be less than ±5%. •B-constant(B _{25/50}) change should be less than ±2%. •No visible damage.	Per MIL-STD-202 Method 213 Test Condition F 1500g's, 0.5ms, In 3 directions perpendicularly intersecting each other (total 18 times).															
12	Vibration	(*1) •Resistance(R ₂₅) change should be less than ±5%. •B-constant(B _{25/50}) change should be less than ±2%. •No visible damage.	Simple harmonic motion between 10Hz to 2.0k Hz and back to 10 Hz of max. amplitude 1.5mm for 20 minutes. This motion should be applied for 12 times in each of 3 mutually perpendicular directions (total of 36 times).															
13	Resistance to Soldering Heat	(*1) •Resistance(R ₂₅) change should be less than ±5%. •B-constant(B _{25/50}) change should be less than ±2%. •No visible damage.	Per MIL-STD-202 Method 210 Test Condition B, 260 °C for 10 +/-1 seconds															

• The Test Condition specification (*1,*2) is applied to the follow P/N.

P/N: NCP15XH103**SR*, NCP15WL233**SR*, NCP15WL333**SR*, NCP15WL473**SR*, NCP15WL683**SR*, NCP15WL104**SR*, NCP15WL154**SR*, NCP15WB473**SR*, NCP15WF104**SR*, NCP18XH103**SR*,

(*1) Resistance(R₂₅) change should be less than 1%
 B-constant(B_{25/50}) change should be less than 1%

(*2) Resistance(R₂₅) change should be less than 5%
 B-constant(B_{25/50}) change should be less than 1%

Continued on the following page.

For NTC Thermistors Chip Type Specifications and Test Methods

Continued from the preceding page.

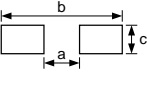
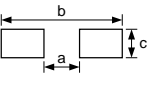
No.	AEC-Q200 Test Item	Specifications	AEC-Q200 Test Methods												
14	Thermal Shock	<ul style="list-style-type: none"> •Resistance(R₂₅) change should be less than ±5%. •B-constant(B_{25/50}) change should be less than ±2%. •No visible damage. 	Perform the 300 cycles according to the two heat treatments listed in the following table. (Maximum transfer time is 20 seconds.) <table border="1" style="margin: 10px auto;"> <thead> <tr> <th>Step</th> <th>1</th> <th>2</th> </tr> </thead> <tbody> <tr> <td>Temp. (°C)</td> <td>-55+0/-3</td> <td>125+3/-0</td> </tr> <tr> <td>Time (min.)</td> <td>15±3</td> <td>15±3</td> </tr> </tbody> </table> Measurement at 24±2 hours after test condition.	Step	1	2	Temp. (°C)	-55+0/-3	125+3/-0	Time (min.)	15±3	15±3			
Step	1	2													
Temp. (°C)	-55+0/-3	125+3/-0													
Time (min.)	15±3	15±3													
15	ESD	<ul style="list-style-type: none"> •Resistance(R₂₅) change should be less than ±5%. •B-constant(B_{25/50}) change should be less than ±2%. •No visible damage. 	Per AEC-Q200-004												
16	Solderability	Minimum 95% of the whole electrode surface should be covered with solder.	Per J-STD-002 SMD b) Method B @ 215 °C category 3.												
17	Electrical Characterization	Within the specified tolerance.	Resistance at 25 °C. B-constant (B ₂₅₋₅₀)												
18	Flammability	N/A													
19	Board Flex	(*1) <ul style="list-style-type: none"> •Resistance(R₂₅) change should be less than ±5%. •B-constant(B_{25/50}) change should be less than ±2%. •No visible damage. 	Per AEC-Q200-005 Bend the board 2.0mm for 60 seconds. Use the follow land size. <table border="1" style="margin: 10px auto;"> <thead> <tr> <th>Type</th> <th>a</th> <th>b</th> <th>c</th> </tr> </thead> <tbody> <tr> <td>NCP15****0SRC</td> <td>0.4</td> <td>1.2</td> <td>0.5</td> </tr> <tr> <td>NCP18****0SRB</td> <td>0.6</td> <td>1.8</td> <td>0.6</td> </tr> </tbody> </table> (in mm) 	Type	a	b	c	NCP15****0SRC	0.4	1.2	0.5	NCP18****0SRB	0.6	1.8	0.6
Type	a	b	c												
NCP15****0SRC	0.4	1.2	0.5												
NCP18****0SRB	0.6	1.8	0.6												
20	Terminal Strength (SMD)	(*1) <ul style="list-style-type: none"> •Resistance(R₂₅) change should be less than ±5%. •B-constant(B_{25/50}) change should be less than ±2%. •No visible damage. 	Per AEC-Q200-006 Apply an *18N force to the side of device for 60 seconds. Use follow land size. *5N (NCP15****0SRC) <table border="1" style="margin: 10px auto;"> <thead> <tr> <th>Type</th> <th>a</th> <th>b</th> <th>c</th> </tr> </thead> <tbody> <tr> <td>NCP15****0SRC</td> <td>0.4</td> <td>1.5</td> <td>0.5</td> </tr> <tr> <td>NCP18****0SRB</td> <td>1.0</td> <td>3.0</td> <td>1.2</td> </tr> </tbody> </table> (in mm) 	Type	a	b	c	NCP15****0SRC	0.4	1.5	0.5	NCP18****0SRB	1.0	3.0	1.2
Type	a	b	c												
NCP15****0SRC	0.4	1.5	0.5												
NCP18****0SRB	1.0	3.0	1.2												

• The Test Condition specification (*1,*2) is applied to the follow P/N.

P/N: NCP15XH103**SR*, NCP15WL233**SR*, NCP15WL333**SR*, NCP15WL473**SR*, NCP15WL683**SR*, NCP15WL104**SR*, NCP15WL154**SR*, NCP15WB473**SR*, NCP15WF104**SR*, NCP18XH103**SR*,

(*1) Resistance(R₂₅) change should be less than 1%
 B-constant(B_{25/50}) change should be less than 1%

(*2) Resistance(R₂₅) change should be less than 5%
 B-constant(B_{25/50}) change should be less than 1%

For NTC Thermistors Chip Type ⚠Caution/Notice

■ ⚠Caution (Storage and Operating Condition)

This product is designed for application in an ordinary environment (normal room temperature, humidity and atmospheric pressure).

Do not use under the following conditions because all these factors can deteriorate the product characteristics or cause failures and burn-out.

1. Corrosive gas or deoxidizing gas
(Chlorine gas, Hydrogen sulfide gas, Ammonia gas, Sulfuric acid gas, Nitric oxide gas, etc.)
2. Volatile or flammable gas
3. Dusty conditions
4. Under vacuum, or under high or low-pressure
5. Wet or humid locations
6. Places with salt water, oils, chemical liquids or organic solvents
7. Strong vibrations
8. Other places where similar hazardous conditions exist

■ ⚠Caution (Other)

Be sure to provide an appropriate fail-safe function on your product to prevent secondary damages that may be caused by the abnormal function or the failure of our product.

■ Notice (Storage and Operating Condition)

To keep solderability of product from declining, the following storage condition is recommended.

1. Storage condition:
Temperature -10 to +40 degrees C
Humidity less than 75%RH (not dewing condition)
2. Storage term:
Use this product within 6 months after delivery by first-in and first-out stocking system.
3. Handling after unpacking:
After unpacking, reseal product promptly or store it in a sealed container with a drying agent.
4. Storage place:
Do not store this product in corrosive gas (Sulfuric acid gas, Chlorine gas, etc.) or in direct sunlight.

■ Notice (Rating)

Use this product within the specified temperature range.

Higher temperature may cause deterioration of the characteristics or the material quality of this product.

For NTC Thermistors Chip Type ⚠Caution/Notice

■ Notice (Soldering and Mounting)

1. Mounting Position

Choose a mounting position that minimizes the stress imposed on the chip during flexing or bending of the board.

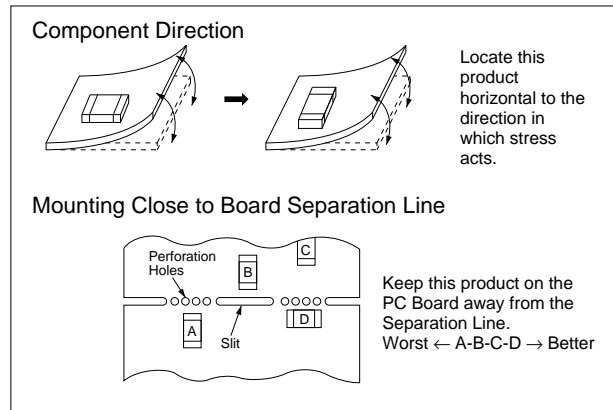

2. Reflow Soldering Conditions

Allowable Reflow Soldering Temperature and Time

(NCP15 Series)

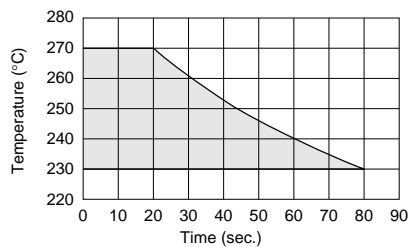

(NCP18 Series)

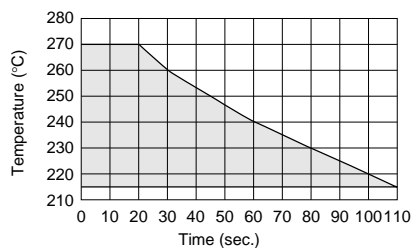

Standard Soldering Conditions

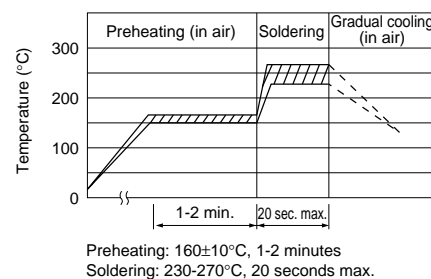
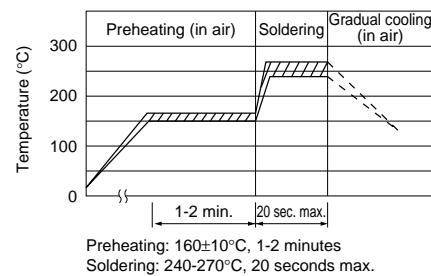

3. Flow Soldering Conditions

Allowable Flow Soldering Temperature and Time

(NCP18 Series)

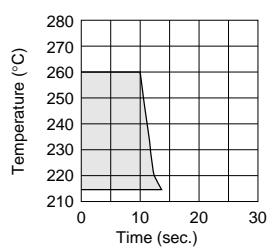

Standard Soldering Conditions

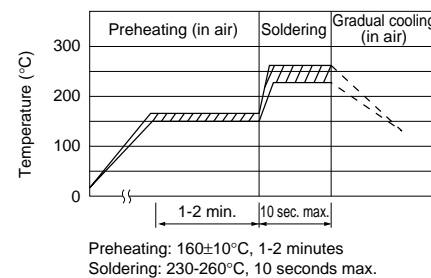

Continued on the following page. ↗

For NTC Thermistors Chip Type ⚠Caution/Notice

☒ Continued from the preceding page.

4. Solder and Flux

(1) Solder and Paste

(a) Reflow Soldering: NCP15/NCP18 Series

Use RA/RMA type or equivalent type of solder paste.

For your reference, we are using the solder paste below for any internal tests of this product.

•RMA9086 90-4-M20 (Sn:Pb=63wt%:37wt%)

(Manufactured by Alpha Metals Japan Ltd.)

•M705-221BM5-42-11

(Sn:Ag:Cu=96.5wt%:3.0wt%:0.5wt%)

(Manufactured by Senju Metal Industry Co., Ltd.)

(b) Flow Soldering: NCP18 Series

We are using the solder paste below for any internal tests of this product.

•Sn:Pb=63wt%:37wt%

•Sn:Ag:Cu=96.5wt%:3.0wt%:0.5wt%

(2) Flux

Use Rosin-based flux.

Do not use strong acidic flux (with halide content exceeding 0.2wt%)

5. Cleaning Conditions

For removing the flux after soldering, observe the following points in order to avoid deterioration of the characteristics or any change of the external electrodes' quality.

	NCP15	NCP18
Solvent	Isopropyl Alcohol	Isopropyl Alcohol
Dipping Cleaning	Less than 5 minutes at room temp. or less than 2 minutes at 40°C max.	Less than 5 minutes at room temp. or less than 2 minutes at 40°C max.
Ultrasonic Cleaning	Less than 5 minutes 20W/ℓ Frequency of 28 to 40kHz.	Less than 1 minute 20W/ℓ Frequency of several 10 to 100kHz.

6. Drying

After cleaning, promptly dry this product.

7. Printing Conditions of Solder Paste

- The amount of solder is critical. Standard height of fillet is shown in the table below.
- Too much soldering may cause mechanical stress, resulting in cracking, mechanical and/or electronic damage.

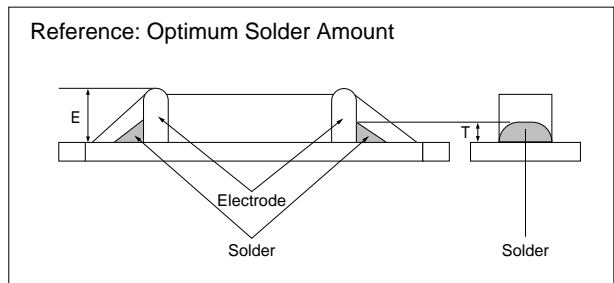

Part Number	The Solder Paste Thickness	T
NCP15	100μm	$1/3E \leq T \leq E$
NCP18	150μm	$0.2mm \leq T \leq E$

8. Adhesive Application and Curing

- Thin or insufficient adhesive may result in loose component contact with land during flow soldering.
- Low viscosity adhesive causes chips to slip after mounting.

■ Notice (Handling)

The ceramic of this product is fragile, and care must be taken to not load an excessive press-force, or to not give a shock at handling.

Such forces may cause cracking or chipping.

NTC/PTC Thermistors for Automotive



NTC Thermistor Lead Type for Temperature Sensor

This product is a sensor type NTC Thermistor to be useful in the normal temperature range developed by the unique ceramic technology and the automatic assembly.

Features

1. High-accuracy of B-Constant tolerance: $\pm 0.5\%$ $\pm 1\%$ of resistance and $\pm 0.5\%$ of B-Constant is realized due to technical advantages of the material and manufacturing process.
2. Quick response
This product provides faster response time due to its smaller size.
3. Taping type is available.
4. Strong lead strength
Original lead-wiring technique assures reliable connection. It can be formed and bent flexibly according to the mounting condition.

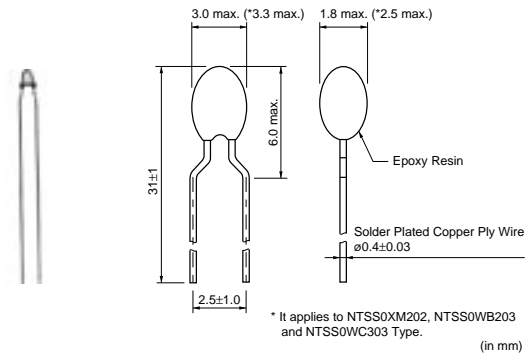

Applications

1. Car audio, car navigation
2. Various engine control units
3. Circuits for ETC equipment
4. Various motor driving circuits
5. Temperature compensation for various circuits

Part Number	Resistance (25°C) (k ohm)	B-Constant (25-50°C) (K)	Permissible Operating Current (25°C) (mA)	Rated Electric Power (25°C) (mW)	Typical Dissipation Constant (25°C) (mW/°C)	Thermal Time Constant (25°C)(s)	Operating Temperature Range (°C)
NTSS0XM202□E1B0	2.0	3500 $\pm 0.5\%$	1.05	21	2.1	7	-40 to 125
NTSS0XR502□E1B0	5.0	3700 $\pm 1\%$	0.68	15	1.5	7	-40 to 125
NTSS0XH103□E1B0	10	3380 $\pm 0.5\%$	0.38	15	1.5	7	-40 to 125
NTSS0XV103□E1B0	10	3900 $\pm 0.5\%$	0.46	15	1.5	7	-40 to 125
NTSS0WB203□E1B0	20	4050 $\pm 1\%$	0.31	21	2.1	7	-40 to 125
NTSS0WC303□E1B0	30	4100 $\pm 1\%$	0.26	21	2.1	7	-40 to 125
NTSS0WD503□E1B0	50	4150 $\pm 1\%$	0.20	15	1.5	7	-40 to 125
NTSS0WF104□E1B0	100	4250 $\pm 1\%$	0.14	15	1.5	7	-40 to 125

A blank column is filled with resistance tolerance codes (F: $\pm 1\%$, E: $\pm 3\%$).
Taping type of part numbers with "N6A0" is available (Lead spacing=5mm).

Temperature Tolerance - Temperature Characteristics

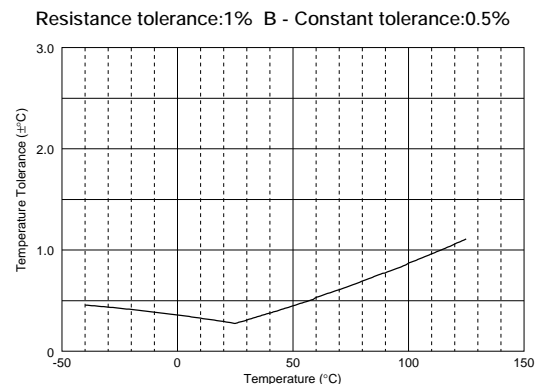
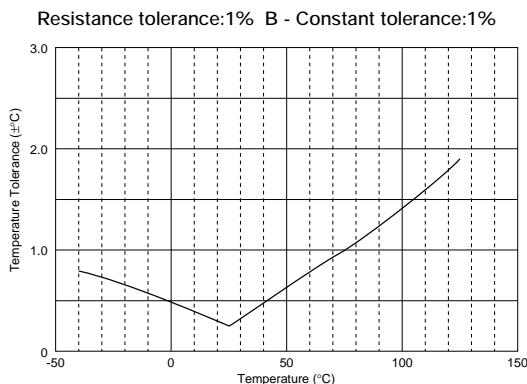

For NTC Thermistors Lead Type Temperature Characteristics (Center Value)

Part Number	NTS□□XM202	NTS□□XR502	NTS□□XH103	NTS□□XV103	NTS□□WB203	NTS□□WC303	NTS□□WD503	NTS□□WF104
Resistance	2.0kΩ	5.0kΩ	10kΩ	10kΩ	20kΩ	30kΩ	50kΩ	100kΩ
B-Constant	3500K	3700K	3380K	3900K	4050K	4100K	4150K	4250K
Temp. (°C)	Resistance (kΩ)	Resistance (kΩ)	Resistance (kΩ)	Resistance (kΩ)	Resistance (kΩ)	Resistance (kΩ)	Resistance (kΩ)	Resistance (kΩ)
-40	44.657	123.484	195.652	347.808	733.007	1149.500	1948.575	4256.752
-35	33.505	92.295	148.171	248.591	524.831	819.651	1387.289	3005.888
-30	25.388	69.614	113.347	179.973	380.184	591.391	999.456	2148.514
-25	19.402	52.860	87.559	131.832	277.845	430.529	728.895	1555.020
-20	14.961	40.480	68.237	97.679	205.260	316.870	537.039	1137.312
-15	11.644	31.275	53.650	73.119	153.642	236.337	399.167	839.314
-10	9.133	24.339	42.506	55.301	116.016	177.842	299.469	625.338
-5	7.198	19.154	33.892	42.257	88.125	134.630	226.186	469.127
0	5.716	15.148	27.219	32.582	67.522	102.816	172.393	355.224
5	4.571	11.964	22.021	25.324	52.168	79.183	132.857	272.045
10	3.682	9.520	17.926	19.847	40.617	61.460	103.089	209.803
15	2.987	7.624	14.674	15.679	31.847	48.045	80.430	162.713
20	2.437	6.160	12.081	12.478	25.151	37.834	63.201	127.117
25	2.000	5.000	10.000	10.000	20.000	30.000	50.000	100.000
30	1.651	4.082	8.315	8.068	16.014	23.955	39.825	79.215
35	1.371	3.354	6.948	6.552	12.902	19.249	31.918	63.150
40	1.143	2.773	5.834	5.353	10.457	15.560	25.733	50.649
45	0.958	2.299	4.917	4.399	8.527	12.657	20.877	40.885
50	0.807	1.914	4.161	3.635	6.993	10.354	17.034	33.195
55	0.683	1.607	3.535	3.020	5.771	8.525	13.929	27.014
60	0.582	1.356	3.014	2.521	4.789	7.058	11.439	22.079
65	0.497	1.149	2.586	2.115	3.992	5.869	9.485	18.226
70	0.426	0.978	2.228	1.783	3.343	4.905	7.906	15.124
75	0.367	0.834	1.925	1.510	2.809	4.113	6.614	12.598
80	0.318	0.714	1.669	1.284	2.376	3.472	5.558	10.542
85	0.276	0.612	1.452	1.096	2.020	2.945	4.686	8.852
90	0.240	0.527	1.268	0.939	1.724	2.509	3.967	7.463
95	0.210	0.456	1.110	0.808	1.476	2.143	3.373	6.321
100	0.183	0.396	0.974	0.698	1.264	1.832	2.878	5.374
105	0.161	0.345	0.858	0.605	1.085	1.571	2.465	4.585
110	0.142	0.302	0.758	0.527	0.935	1.350	2.118	3.925
115	0.125	0.264	0.671	0.460	0.812	1.171	1.828	3.376
120	0.111	0.232	0.596	0.403	0.708	1.019	1.583	2.913
125	0.099	0.205	0.531	0.354	0.617	0.886	1.374	2.520

Detailed Resistance-Temperature Tables are downloadable from the following URL.
<http://search.murata.co.jp/Ceramy/CatsearchAction.do?sLang=en>

For NTC Thermistors Lead Type Specifications and Test Methods

3

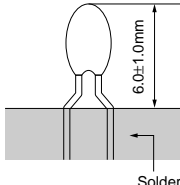
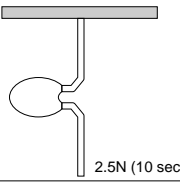
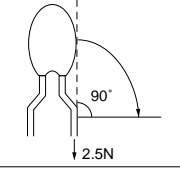
No.	Item	Rating Value	Method of Examination
1	High Temp. Test 1	<ul style="list-style-type: none"> Resistance (R25) fluctuation rate less than $\pm 2\%$ B-Constant (B25/50) fluctuation rate less than $\pm 1\%$ 	150 \pm 2°C in air, for 500 +48/-0 hours without loading
2	High Temp. Test 2		125 \pm 3°C in air, for 1000 +48/-0 hours without loading
3	Low Temp. Test	<ul style="list-style-type: none"> Resistance (R25) fluctuation rate less than $\pm 1\%$ B-Constant (B25/50) fluctuation rate less than $\pm 1\%$ 	-40 \pm 3°C in air, for 1000 +48/-0 hours without loading
4	Humidity Test		60 \pm 2°C, 90-95%RH in air, for 1000 +48/-0 hours without loading
5	High Temp. Pressure Test		121 \pm 2°C, 2atm. in saturated vapor, leave for 2 +1/-0 hours without loading
6	Heat Shock Test	<ul style="list-style-type: none"> Resistance (R25) fluctuation rate less than $\pm 2\%$ B-Constant (B25/50) fluctuation rate less than $\pm 1\%$ 	-55 \pm 3°C, 30 minutes in air 125 \pm 2°C, 30 minutes in air (1 cycle) Continuous 1000 +4/-0 cycles without loading
7	High Temp. Continuous Load Test		100 \pm 2°C in air, with Permissive Operating Current for 1000 +48/-0 hours
8	Humidity Continuous Load Test		85 \pm 2°C, 85%RH in air, with Permissive Operating Current for 1000 +48/-0 hours
9	Insulation Break-down Voltage	<ul style="list-style-type: none"> Normal appearance Normal electrical characteristics on 500Vdc, 1 minute 	2mm length of coating resin from the top of thermistor is to be dipped into beads of lead (Pb), and D.C 500V is applied to circuit between beads of lead (Pb) and lead wire.
10	Solvent Proof	<ul style="list-style-type: none"> Normal appearance Resistance (R25) fluctuation rate less than $\pm 1\%$ B-Constant (B25/50) fluctuation rate less than $\pm 1\%$ 	Using Chlorine Washing Solvents, Boiling, 10 minutes Supersonic, 10 minutes
11	Resistance to Soldering Heat	<ul style="list-style-type: none"> Resistance (R25) change less than $\pm 1\%$ B-Constant (B25/50) change less than $\pm 1\%$ 	Both lead wires are immersed into 350 \pm 10°C solder for 3.5 \pm 0.5 seconds or 260 \pm 5°C solder for 10 \pm 1 seconds according to Fig-1. (solder <JIS Z 3282 H60A>) 
12	Solderability	More than 90% of lead wire surface should be covered by solder.	Both lead wires are immersed into flux (25wt% colophony <JIS K 5902> isopropyl alcohol <JIS K 8839>) for 5-10 seconds. Then both lead wires are immersed into 235 \pm 5°C solder <JIS Z 3282 H60A> for 2 \pm 0.5 seconds. according to Fig-1.
13	Lead Wire Pull Strength	<ul style="list-style-type: none"> No visible damage Resistance (R25) change less than $\pm 1\%$ B-Constant (B25/50) change less than $\pm 1\%$ 	One end of a lead wire should be fixed and 2.5N force for 10 seconds should be applied to the other lead wire as shown in Fig-2. 
14	Lead Wire Bending Strength	No visible damage on lead wire	One lead wire is held and 2.5N force is applied. Then the body of NTC thermistor is bent 90° degrees and again bent back to the initial position. This sequence should be completed twice. See Fig-3. 
15	Drop Test		NTC Thermistor should be dropped without any force onto concrete floor from 1 meter height one time.
16	Vibration	<ul style="list-style-type: none"> No visible damage Resistance (R25) change less than $\pm 1\%$ B-Constant (B25/50) change less than $\pm 1\%$ 	NTC Thermistor is to be fixed to the vibration test equipment. Frequency: 10-2000-10Hz (20 minutes) Max amplitude: 3.0mm Vibrated for a period of 4 hours in 3 perpendicular directions each other (for total of 12 hours.)

* R25 is zero-power resistance of Thermistor in 25°C.

• After each test, NTC Thermistor should be kept for 1 hour at room temperature (normal humidity and normal atmospheric pressure). Then the resistances (R25 and R50) should be measured and the appearance should be visually examined.

For NTC Thermistors Lead Type ⚠Caution/Notice

■ ⚠Caution (Storage and Operating Condition)

This product is designed for application in an ordinary environment (normal room temperature, humidity and atmospheric pressure).

Do not use under the following conditions because all these factors can deteriorate the product characteristics or cause failures and burn-out.

1. Corrosive gas or deoxidizing gas
(Chlorine gas, Hydrogen sulfide gas, Ammonia gas, Sulfuric acid gas, Nitric oxide gas, etc.)
2. Volatile or flammable gas
3. Dusty conditions
4. Under vacuum, or under high or low-pressure
5. Wet or humid locations
6. Places with salt water, oils, chemical liquids or organic solvents
7. Strong vibrations
8. Other places where similar hazardous conditions exist

■ ⚠Caution (Other)

Be sure to provide an appropriate fail-safe function on your product to prevent secondary damages that may be caused by the abnormal function or the failure of our product.

■ Notice (Storage and Operating Condition)

To keep solderability of product from declining, the following storage condition is recommended.

1. Storage condition:
Temperature -10 to +40 degrees C
Humidity less than 75%RH (not dewing condition)
2. Storage term:
Use this product within 6 months after delivery by first-in and first-out stocking system.
3. Handling after unpacking:
After unpacking, reseal product promptly or store it in a sealed container with a drying agent.
4. Storage place:
Do not store this product in corrosive gas (Sulfuric acid gas, Chlorine gas, etc.) or in direct sunlight.

■ Notice (Rating)

Use this product within the specified temperature range.
Higher temperature may cause deterioration of the characteristics or the material quality of this product.

■ Notice (Soldering and Mounting)

1. Be sure that the preheat-up does not melt the soldering of this product. Excessive heat may cause failure to open, short or insulation break down.
2. Do not touch the body with soldering iron.
The soldering point should be min. 5mm away from the root of lead wire.

■ Notice (Handling)

1. The ceramic element of this product is fragile, and care must be taken not to load an excessive press-force or not to give a shock at handling. Such forces may cause cracking or chipping.
2. Do not apply an excessive force to the lead. Otherwise, it may cause junction between lead and element to break or crack. Holding element by side lead wire is recommended when lead wire is bent or cut.

NTC/PTC Thermistors for Automotive



PTC Thermistor (POSISTOR®) for Overheat Sensing Chip Type 0603 (1608) Size

This chip "POSISTOR" is SMD type for overheat sensing for power transistors, power diodes and power ICs in hybrid circuits.

■ Features

1. SMD type is helpful for miniaturizing the circuit because of small size and lightweight.
2. Excellent thermal response because of no coating.
3. Elements of solid-state construction provides excellent mechanical vibration and impact resistance.
4. Contactless operation provides prolonged service life and noiseless operation.
5. Lead is not contained in the terminations.

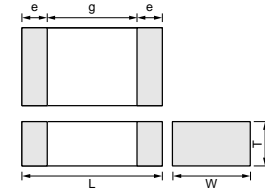

Part Number	Dimensions (mm)				
	L	W	T	e	g
PRF18_RB	1.6±0.15	0.8±0.15	0.8±0.15	0.1 to 0.6	-

4

Part Number	Sensing Temperature (at 4.7k ohm) (°C)	Maximum Voltage (V)	Resistance (at 25°C) (ohm)	Temperature Range (°C)
PRF18BG471QS2RB	65 ±5°C	32	470 ±50%	-40 to 150
PRF18BF471QS2RB	75 ±5°C	32	470 ±50%	-40 to 150
PRF18BE471QS2RB	85 ±5°C	32	470 ±50%	-40 to 150
PRF18BD471QS2RB	95 ±5°C	32	470 ±50%	-40 to 150
PRF18BC471QS2RB	105 ±5°C	32	470 ±50%	-40 to 150
PRF18BB471QS2RB	115 ±5°C	32	470 ±50%	-40 to 150
PRF18BA471QS2RB	125 ±5°C	32	470 ±50%	-40 to 150
PRF18AR471QS2RB	135 ±5°C	32	470 ±50%	-40 to 150
PRF18AS471QS2RB	145 ±5°C	32	470 ±50%	-40 to 150

Please contact us for UL recognized products.

■ Standard Land Pattern Dimensions

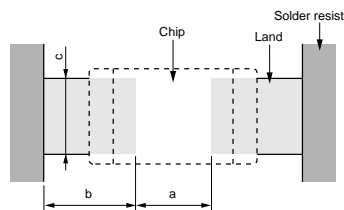

(in mm)

Part Number	Soldering Methods	Dimensions (mm)			
		Chip (L×W)	a	b	c
PRF18	Flow Soldering	1.6×0.8	0.6-1.0	0.8-0.9	0.6-0.8
	Reflow Soldering	1.6×0.8	0.6-0.8	0.6-0.7	0.6-0.8

■ Resistance - Temperature Characteristics (Typical)

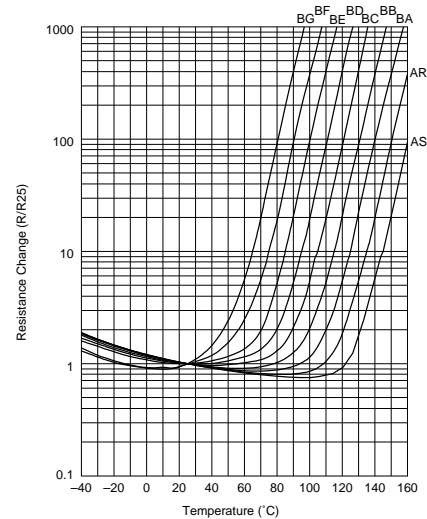

Continued on the following page. ↗

Continued from the preceding page.

Overheat Protection Circuit

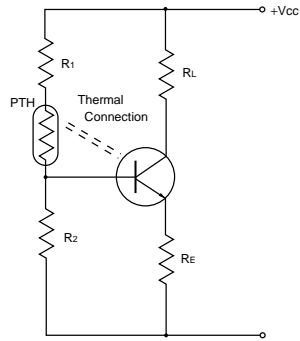

Overheat Sensing Circuit

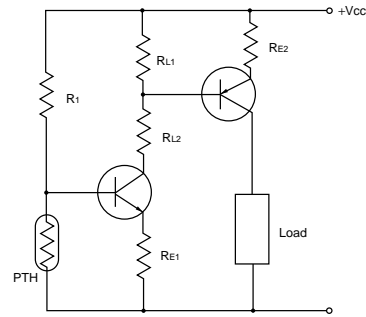

Resistance - Temperature Characteristics Range (Ref. Only)

PRF18BG471QS2RB

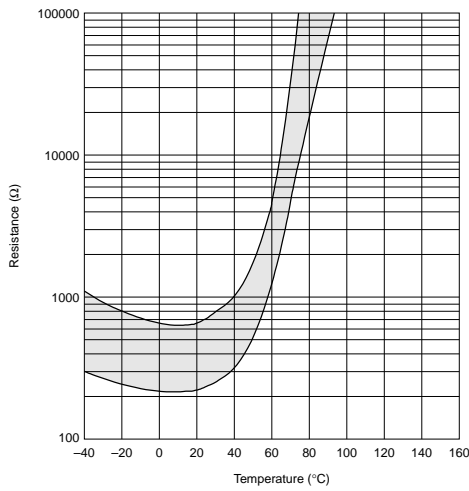

PRF18BF471QS2RB

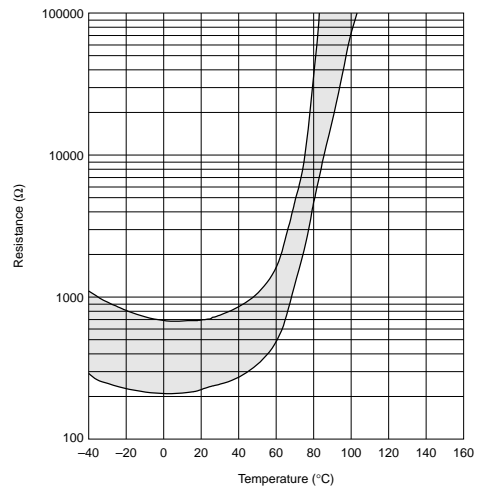

PRF18BE471QS2RB

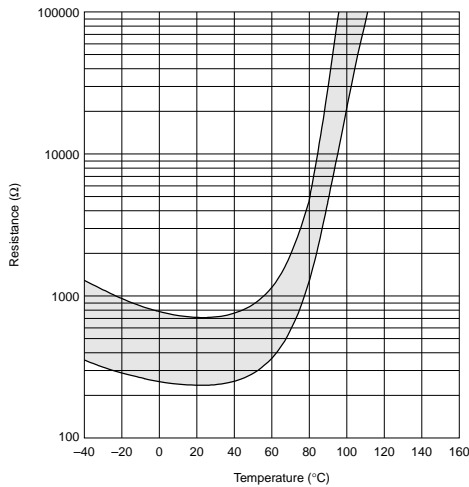

PRF18BD471QS2RB

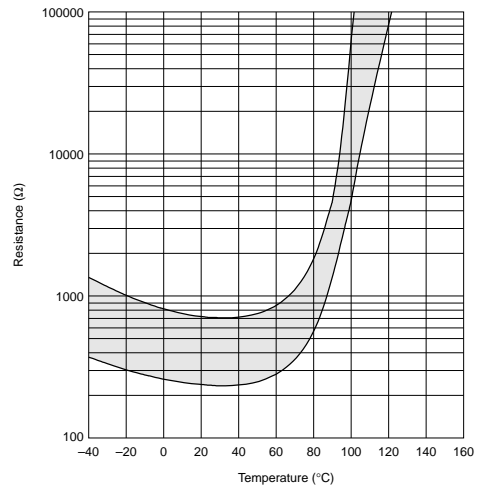

4

Continued on the following page. ↗

☞ Continued from the preceding page.

■ Resistance - Temperature Characteristics Range (Ref. Only)

PRF18BC471QS2RB

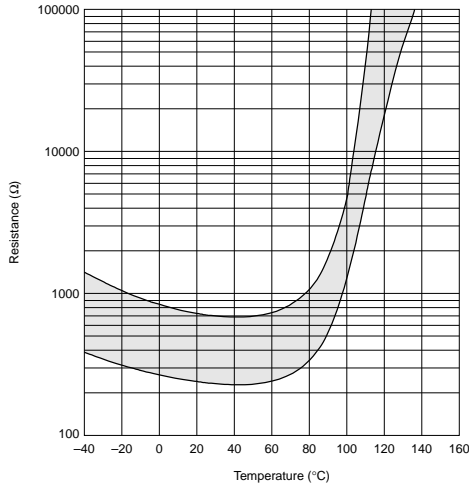

PRF18BB471QS2RB

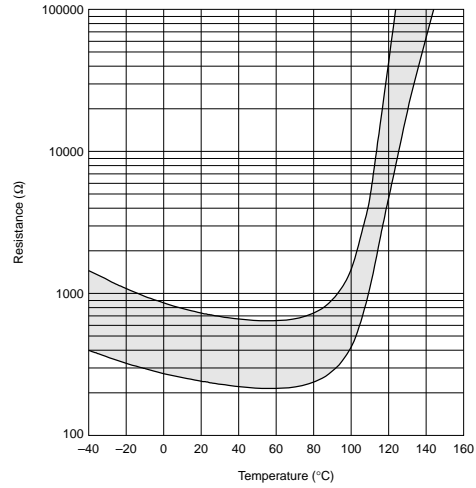

PRF18BA471QS2RB

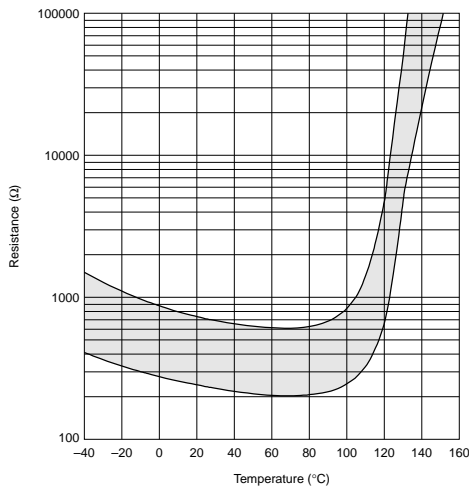

PRF18AR471QS2RB

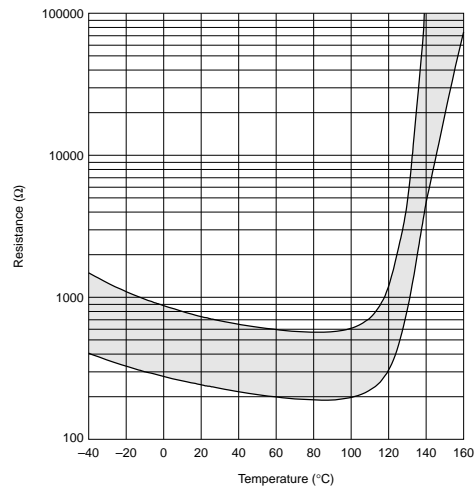

PRF18AS471QS2RB

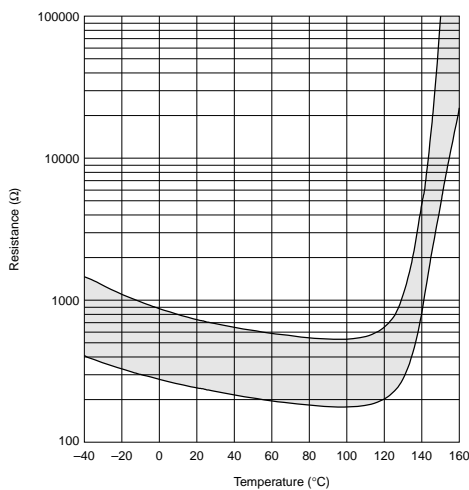

Chip Type of POSISTOR[®] for Overheat Protection Specifications and Test Methods

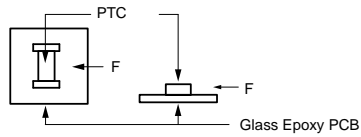
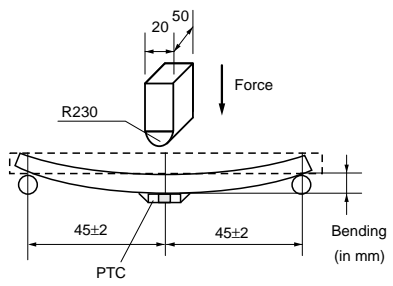
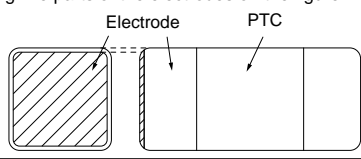
No.	Item	Rating Value	Method of Examination									
1	Resistance Value (at 25°C)	The resistance value should be within the specified tolerance.	After applying maximum operating voltage for 3 minutes and leaving for 2 hours at 25°C, measured by applying voltage of less than 1.5Vdc (by a direct current of less than 10mA).									
2	Adhesive Strength	There is no detachment sign of electrode.	EIAJ ET-7403 term 9 Prepare soldered PTC to PCB *1 and add the force of 5.0N in the direction shown below. (PTC=POSISTOR [®]) 									
3	Vibration Resistance	Normal appearance Resistance change: not to exceed $\pm 20\%^2$	Soldered PTC to PCB*1 Vibration: 10-2000-10Hz (20 minutes) Max. Amplitude: 3.0mm Vibrate for 4 hours in each of 3 mutually perpendicular planes for a total of 12 hours. This test condition is according to "MIL-STD-204D"									
4	Resistance to Bending of Substance	Normal appearance Resistance change: not to exceed $\pm 20\%^2$	Soldered PTC on Test Board*1, and apply force on back side of Test Board shown below: Bending Speed: 1.0mm/s Bending Strength: 2.0mm Hold time: 5 \pm 1 seconds Board Dimension: 100 \times 40 \times 1.6t mm Board Material: Glass Epoxy 									
5	Solderability	Min. 95% electrode is covered with new solder. Resistance change: not to exceed $\pm 20\%^2$	JIS C 5102 term 8.4 Solder temp.: 230 \pm 5°C Solder: Sn63%/Pb37% (or 60%/40%) Soaking time: 3 \pm 0.5 seconds Soaking position: Until a whole electrode is soaked									
6	Soldering Heat Resistance	Resistance change: not exceed $\pm 20\%^2$ Normal appearance on the section showed by slanting line parts of the electrodes on the figure. 	Solder temp.: 260 \pm 5°C Solder: Sn63%/Pb37% (or 60%/40%) Flux: Containing less than 0.2wt% of chlorine. Soaking time: 10 \pm 0.5 seconds Soaking position: Until a whole electrode is soaked. Preheating: 150 \pm 5°C 3 minutes									
7	Dry Heat Resistance	Normal appearance Resistance change: not to exceed $\pm 20\%^2$	Soldered PTC to PCB*1 +150 \pm 3°C leave for 1000 \pm 12 hours									
8	Cold Resistance		Soldered PTC to PCB*1 -40 \pm 3°C leave for 1000 \pm 12 hours									
9	Damp Heat Resistance		Soldered PTC to PCB*1 +85 \pm 3°C 80-85%RH leave for 1000 \pm 12 hours									
10	Thermal Shock*3		Soldered PTC to PCB*1 Cycles: 1000 cycles <table border="1" data-bbox="933 1753 1307 1827"> <thead> <tr> <th>Step</th> <th>Temp. (°C)</th> <th>Time (minutes)</th> </tr> </thead> <tbody> <tr> <td>1</td> <td>-55+0, -3</td> <td>30</td> </tr> <tr> <td>2</td> <td>+125+3, -0</td> <td>30</td> </tr> </tbody> </table>	Step	Temp. (°C)	Time (minutes)	1	-55+0, -3	30	2	+125+3, -0	30
Step	Temp. (°C)		Time (minutes)									
1	-55+0, -3	30										
2	+125+3, -0	30										
11	High Temperature Humidity Load	Soldered PTC to PCB*1 85 \pm 3°C, 80-85%RH (in air), load max. operating voltage for 1000 \pm 12 hours										

4

Continued on the following page.

Chip Type of POSISTOR[®] for Overheat Protection Specifications and Test Methods

 Continued from the preceding page.

No.	Item	Rating Value	Method of Examination
12	High Temperature Load	Normal appearance Resistance change: not to exceed $\pm 20\%$ *2	Soldered PTC to PCB*1 $+85\pm 3^{\circ}\text{C}$ (in air), load max. operating voltage for 1000 ± 12 hours.

*1 Above mentioned soldering is done under the following conditions at our site.

- Glass-Epoxy PC board
- Standard land dimension
- Standard solder paste
- Standard solder profile

Above conditions are mentioned in Notice.

*2 Measure resistance after the test by applying voltage of less than 1.5Vdc by a direct current of less than 10mA after product is left at $25\pm 2^{\circ}\text{C}$ for 2 hours.

*3 We cannot guarantee the resistance change in Thermal Shock (No.10) in case of defective mounting.

NTC/PTC Thermistors for Automotive



PTC Thermistor (POSISTOR®) for Overcurrent Protection Chip Type 0805 (2012) Size

Overcurrent Protection device with resettable function suitable for current limiting resistor.

This product is chip type PTC thermistor for overcurrent protection which is suitable for the following

- Countermeasure for short circuit testing
- Current limiting resistor

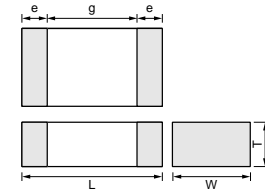

Part Number	Dimensions (mm)				
	L	W	T	e	g
PRG21_RA	2.0±0.2	1.25±0.2	0.9±0.2	0.2 min.	0.5 min.
PRG21_RK	2.0±0.2	1.25±0.2	1.25±0.2	0.2 min.	0.5 min.

■ Features

1. Rapid operation to protect the circuit in an overcurrent condition abnormality such as a short circuit.
By removing the overcurrent condition, these products automatically return to the initial condition and can be used repeatedly.
2. Suitable for countermeasure to short circuit test in safety standard
3. Stable resistance after operation due to ceramic PTC
4. Similar size (0603 size) is possible due to the large capacity for electric power.
5. Possible to use these products as current limiting resistors with overcurrent protection functions
6. SMD type is helpful for miniaturizing circuits because of its small size and lightweight
7. Lead is not contained in the terminations

5

Part Number	Max. Voltage (V)	Non-operating Current (at +85°C) (mA)	Non-operating Current (at +105°C) (mA)	Trip Current (at -40°C) (mA)	Max. Current (mA)	Resistance (at 25°C) (ohm)	Temperature Range (°C)
PRG21AR420MS1RA	20	25	15	130	590	42 ±20%	-40 to 105
PRG21AR220MS1RK	16	45	25	250	900	22 ±20%	-40 to 105

■ Standard Land Pattern Dimensions

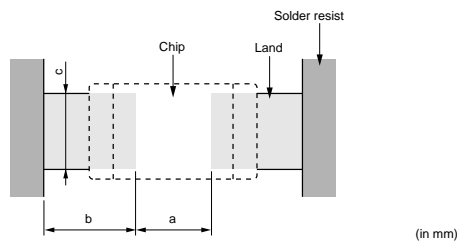

Part Number	Soldering Methods	Dimensions (mm)			
		Chip (L×W)	a	b	c
PRG21	Reflow Soldering	2.0×1.25	1.0-1.2	0.5-0.7	1.0-1.2

■ Protective Threshold Current Range

PRG21AR220MS1RK

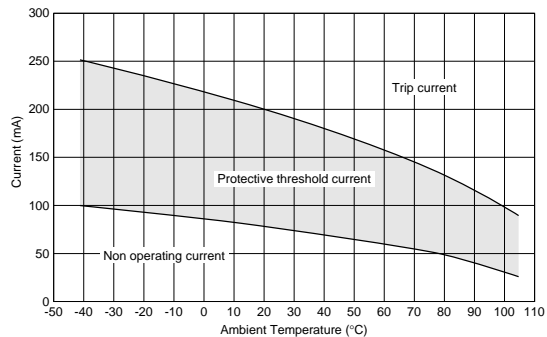

PRG21AR420MS1RA

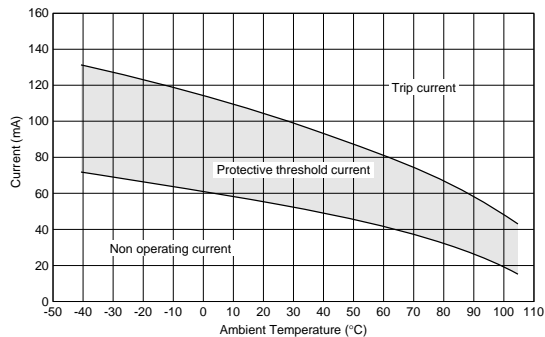

■ Operating Time (Typical Curve)

PRG21AR220MS1RK

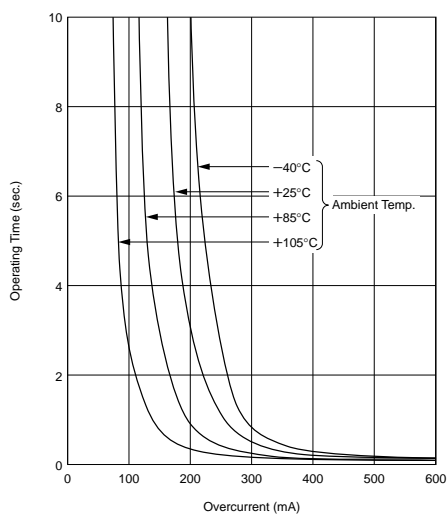

PRG21AR420MS1RA

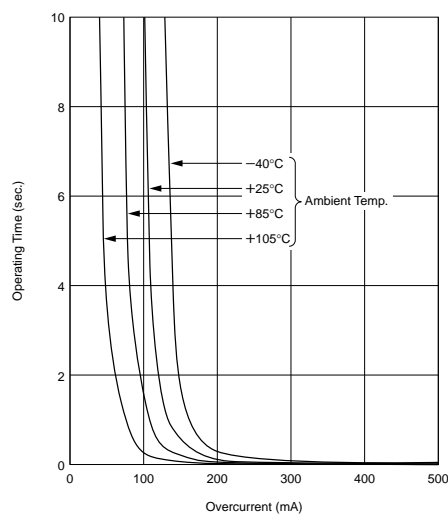

Chip Type of POSISTOR[®] for Overheat Protection Specifications and Test Methods

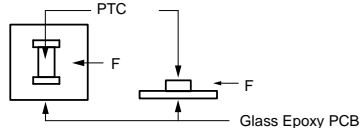
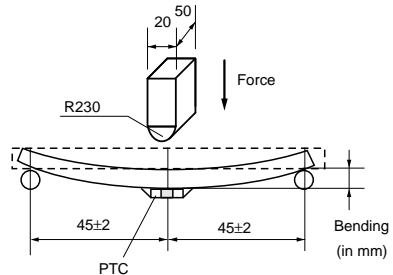
No.	Item	Rating Value	Method of Examination								
1	Operating Temp. 1	-40 to +105°C	The temperature range with maximum voltage applied to the POSISTOR [®] .								
2	Operating Temp. 2	-40 to +125°C	The temperature range which with zero voltage applied to POSISTOR [®] after it was soldered to PCB.								
3	Resistance Value (at 25°C)	The resistance value shall be within the specified tolerance.	After applying maximum operating voltage for 3 minutes and leaving for 2 hours at 25°C, measured by applying voltage of less than 1.5Vdc (by a direct current of less than 10mA).								
4	Withstanding Voltage	Without damage	We apply 120% of the maximum voltage to PTC by rising gradually for 180±5 seconds at 25°C. (A protective resistor is to be connected in series, and the inrush current through PTC must be limited below maximum rated value.)								
5	Adhesive Strength	There is no detachment sign of electrode.	EIAJ ET-7403 term 9 Prepare soldered PTC to PCB *1 and add a force of 5.0N in the direction shown below. (PTC=POSISTOR [®]) 								
6	Vibration Resistance	Normal appearance Resistance change: not to exceed ±20%*2	Soldered PTC to PCB *1 Vibration: 10-2000-10Hz (20 min.) Max. Amplitude: 3.0mm Vibrate for 4 hours in each of 3 mutually perpendicular planes for a total of 12 hours. This test condition is according to "MIL-STD-204D"								
7	Resistance to Bending of Substance	Normal appearance Resistance change: not to exceed ±20%*2	Soldered PTC on Test Board *1, and apply force on back side of Test Board shown below: Bending Speed: 1.0mm/s Bending Strength: 2.0mm Hold Time: 5±1 seconds Board Dimension: 100×40×1.6t mm Board Material: Glass Epoxy 								
8	Solderability	Min. 95% electrode is covered with new solder. Resistance change: not to exceed ±20%*2	JIS C 5102 term 8.4 Solder Temp.: 230±5°C Solder: Sn63%/Pb37% (or 60%/40%) Soaking Time: 3±0.5 seconds Soaking Position: Until a whole electrode is soaked								
9	Soldering Heat Resistance	Normal appearance Resistance change: not to exceed ±20%*2	Solder: Sn 63%/Pb 37% (or 60%/40%) solder paste Flux: Containing less than 0.2wt% of chlorine. Preheating: 150±5°C 3 minutes Peak Temp.: 260±5°C 10±5 seconds (reflow) PCB: JIS C 6484 Glass Epoxy PCB								
10	Dry Heat Resistance	Normal appearance Resistance change: not to exceed ±20%*2	Soldered PTC to PCB*1 +125±3°C leave for 1000±12 hours.								
11	Cold Resistance		Soldered PTC to PCB*1 -40±3°C leave for 1000±12 hours.								
12	Damp Heat Resistance		Soldered PTC to PCB*1 +85±3°C 80-85%RH leave for 1000±12 hours.								
13	Thermal Shock*3		Soldered PTC to PCB*1 Cycles: 1000 cycles <table border="1" style="margin-left: auto; margin-right: auto;"> <thead> <tr> <th>Step</th> <th>Temp. (°C)</th> <th>Time (minutes)</th> </tr> </thead> <tbody> <tr> <td>1</td> <td>-55+0, -3</td> <td>30</td> </tr> <tr> <td>2</td> <td>+125+3, -0</td> <td>30</td> </tr> </tbody> </table>	Step	Temp. (°C)	Time (minutes)	1	-55+0, -3	30	2	+125+3, -0
Step	Temp. (°C)	Time (minutes)									
1	-55+0, -3	30									
2	+125+3, -0	30									

5

Continued on the following page.

Chip Type of POSISTOR[®] for Overheat Protection Specifications and Test Methods

☒ Continued from the preceding page.

No.	Item	Rating Value	Method of Examination
14	High Temperature Humidity Load	Normal appearance Resistance change: not to exceed $\pm 20\%$ *2	Soldered PTC to PCB*1 85 \pm 3°C, 80-85%RH (in air), load max. operating voltage for 1000 \pm 12 hours.
15	High Temperature Load		Soldered PTC to PCB*1 125 \pm 3°C (in air), PTC is applied max. operating voltage for 1.5 hours on and 0.5 hours off. This cycle is repeated for 1000 \pm 10 hours.

*1 Above mentioned soldering is done under the following conditions at our site.

- Glass-Epoxy PC board
- Standard land dimension
- Standard solder paste
- Standard solder profile

Above conditions are mentioned in Notice.

*2 Measure resistance after the test by applying voltage of less than 1.5Vdc by a direct current of less than 10mA after product is left at 25 \pm 2°C for 2 hours.

*3 We cannot guarantee the resistance change in Thermal Shock (No.10) in case of defective mounting.

For POSISTOR[®] Chip Type ⚠Caution/Notice

■ ⚠Caution (Storage and Operating Condition)

This product is designed for application in an ordinary environment (normal room temperature, humidity and atmospheric pressure). Do not use under the following conditions because all these factors can deteriorate the characteristics or cause product failure and burn-out.

1. Corrosive gas or deoxidizing gas (Chlorine gas, Hydrogen sulfide gas, Ammonia gas, Sulfuric acid gas, Nitric oxide gas, etc.)
2. Volatile or flammable gas
3. Dusty conditions
4. Under vacuum, or under high or low-pressure
5. Wet or humid conditions
6. Places with salt water, oils, chemical liquids or organic solvents
7. Strong vibrations
8. Other places where similar hazardous conditions exist

■ ⚠Caution (Other)

Be sure to provide an appropriate fail-safe function on your product to prevent secondary damage that may be caused by the abnormal function or the failure of our product.

■ Notice (Storage and Operating Condition)

To keep solderability of product from declining, following storage condition is recommended.

1. Storage condition:
 - Temperature -10 to +40 degrees C
 - Humidity less than 75%RH (not dewing condition)
2. Storage term:
 - Use this product within 6 months after delivery by first-in and first-out stocking system.
3. Handling after unpacking:
 - After unpacking, promptly reseal this product or store it in a sealed container with a drying agent.
4. Storage place:
 - Do not store this product in corrosive gas (Sulfuric acid, Chlorine, etc.) or in direct sunlight.

For POSISTOR[®] Chip Type ⚠ Caution/Notice

■ Notice (Soldering and Mounting) 0603 (1608) Size

1. Solder and Flux

(1) Solder Paste

(a) Flow Soldering: Use Sn:Pb=60:40wt%,
Sn:Pb=63:37wt%, Sn:Ag:Cu=96.5:3.0:0.5wt% or equivalent type of solder.

(b) Reflow Soldering: Use Sn:Pb=60:40wt%,
Sn:Pb=63:37wt%, Sn:Ag:Cu=96.5:3.0:0.5wt% or equivalent type of solder paste.

For your reference, we are using '63Sn/37Pb RMA9086 90-3-M18', manufactured by Alpha Metals Japan Ltd., '96.5Sn/3.0Ag/0.5Cu M705-221BM5-42-11', manufactured by Senju Metal Industry Co., Ltd. for any Internal tests of this product.

(2) Flux

Use rosin-based flux. Do not use strong acidic flux (with halide content exceeding 0.2wt%).

2. Cleaning Conditions and Drying

To remove the flux after soldering, observe the following points in order to avoid deterioration of the characteristics or any change to the external electrodes quality.

(1) Cleaning Conditions

Solvent	Dipping Cleaning	Ultrasonic Cleaning
2-propanol	Less than 5 minutes at room temp. or Less than 2 minutes at 40°C max.	Less than 1 minute 20W/L Frequency of several 10kHz to 100kHz.

A sufficient cleaning should be applied to remove flux completely.

(2) Drying

After cleaning, promptly dry this product.

3. Soldering Conditions

In your mounting process, observe the following points in order to avoid deterioration of the characteristics or destruction of this product. The mounting quality of this product may also be affected by the mounting conditions, shown in the points below.

(1) Printing Conditions of Solder Paste

- (a) Recommended thickness of solder paste printing should be from 0.15 to 0.20mm.
- (b) After soldering, the solder fillet should be a height from 0.2 mm to the thickness of this product (see the figure at right).
- (c) Too much solder gives too strong mechanical stress to this product. Such stress may cause cracking or other mechanical damage. Also, it can destroy the electrical performance of this product.

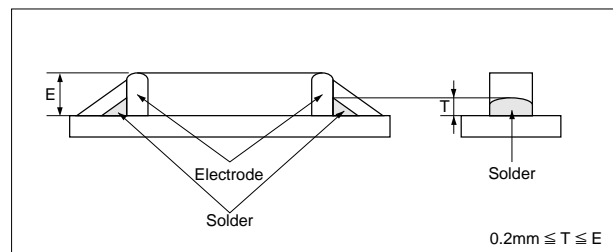

Continued on the following page. ↗

For POSISTOR® Chip Type ⚠Caution/Notice

Continued from the preceding page.

(2) Adhesive Application and Curing

- (a) If insufficient adhesive is applied, or if the adhesive is not sufficiently hardened, this product may have a loose contact with the land, during flow soldering.
- (b) Too low viscosity of adhesive causes this product to slip on board, after mounting.

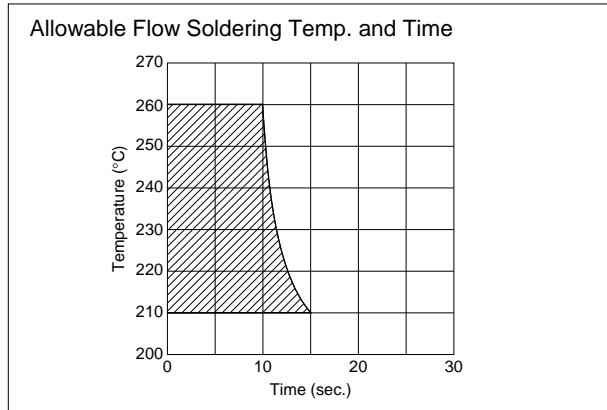

(3) Allowable Soldering Temperature and Time

- (a) Solder within the temperature and time combinations, indicated by the slanted lines in the following graphs.
- (b) The excessive soldering conditions may cause dissolution of metallization or deterioration of solder-wetting on the external electrode.
- (c) In the event that soldering is repeated more than twice, the allowable reflow soldering time should be the accumulated soldering time.

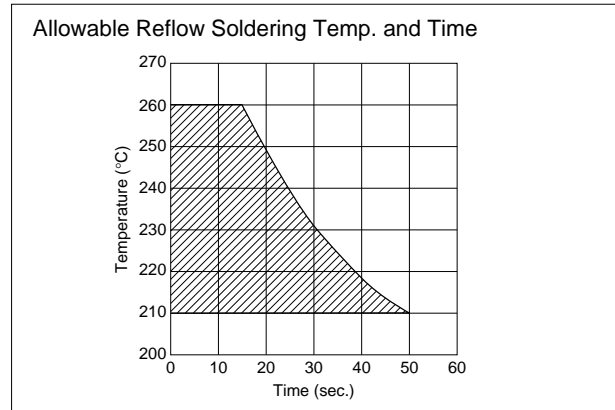

(4) Recommendable Temperature Profile for Soldering

- (a) Insufficient preheating may cause a crack on ceramic body. Difference between preheating temperature and maximum temperature in the profile should be 100°C.
- (b) Rapid cooling by dipping in solvent or by other means is not recommended.

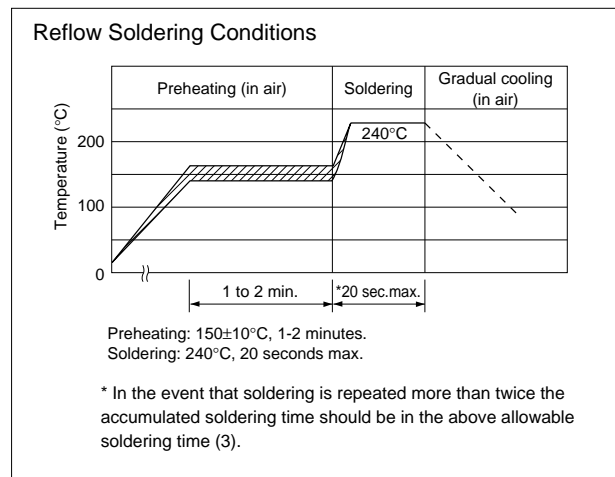
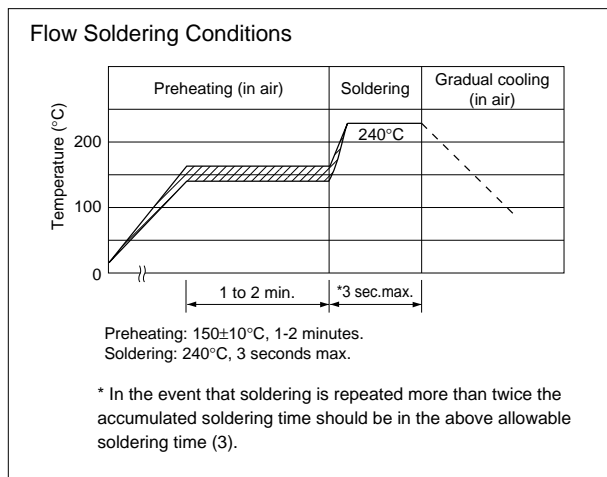

- (5) There may be a risk of unexpected failures (tombstone, insufficient solder-wetting, etc.) in the mounting process caused by the mounting conditions. Please make sure that this product is correctly mounted under specified mounting conditions.

For POSISTOR[®] Chip Type ⚠ Caution/Notice

■ Notice (Soldering and Mounting) 0805 (2012) Size

1. Solder and Flux

(1) Solder Paste

Use solder paste Sn:Pb=63:37wt%.

For your reference, we are using

63Sn/37Pb RMA9086 90-3-M18,

manufactured by Alpha Metals Japan Ltd.

96.5Sn/3.0Ag/0.5Cu M705-221BM5-42-11,

manufactured by Senju Metal Industry Co., LTD for any

Internal tests of this product.

(2) Flux

Use rosin-based flux. Do not use strong acidic flux (with halide content exceeding 0.2wt%).

2. Cleaning Conditions and Drying

To remove the flux after soldering, observe the following points in order to avoid deterioration of the characteristics or any change to the external electrodes quality.

(1) Cleaning Conditions

Solvent	Dipping Cleaning	Ultrasonic Cleaning
2-propanol	Less than 5 minutes at room temp. or Less than 2 minutes at 40°C max.	Less than 1 minute 20W/L Frequency of several 10kHz to 100kHz.

A sufficient cleaning should be applied to remove flux completely.

(2) Drying

After cleaning, promptly dry this product.

3. Soldering Conditions

In your mounting process, observe the following points in order to avoid deterioration of the characteristics or destruction of this product. The mounting quality of this product may also be affected by the mounting conditions, shown in the points below.

This product is for reflow soldering only. Flow soldering should not be allowed.

(1) Printing Conditions of Solder Paste

(a) Standard thickness of solder paste printing should be from 0.15 to 0.20 mm.

(b) After soldering, the solder fillet should be a height from 0.2 mm to the thickness of this product (see the figure at right).

(c) Too much solder gives too strong mechanical stress to this product. Such stress may cause cracking or other mechanical damage. Also, it can destroy the electrical performance of this product.

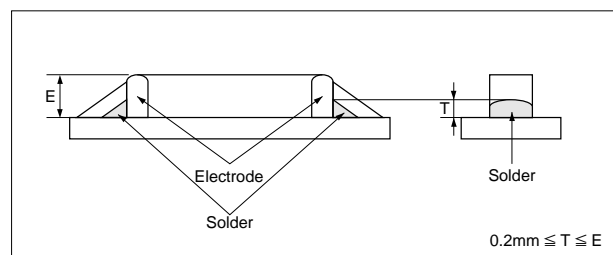

Continued on the following page. ↗

For POSISTOR[®] Chip Type ⚠Caution/Notice

☐ Continued from the preceding page.

(2) Allowable Soldering Temperature and Time

- (a) Solder within the temperature and time combinations, indicated by the slanted lines in the graphs at right.
- (b) The excessive soldering conditions may cause dissolution of metallization or deterioration of solder-wetting on the external electrode.
- (c) In the event that soldering is repeated more than twice, the allowable reflow soldering time should be the accumulated soldering time.

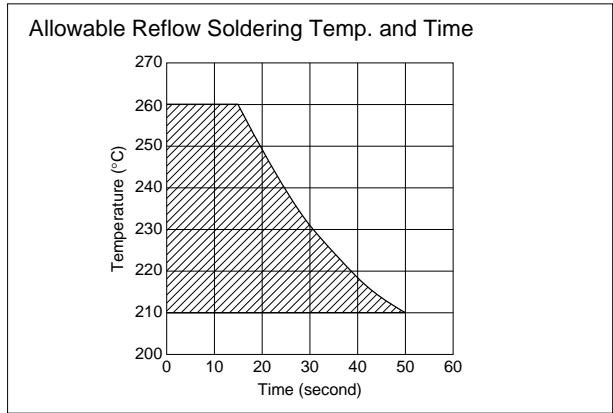

(3) Standard Temperature Profile for Soldering

- (a) Insufficient preheating may cause a crack on ceramic body. Difference between preheating temperature and maximum temperature in the profile should be 100°C.
- (b) Rapid cooling by dipping in solvent or by other means is not recommended.

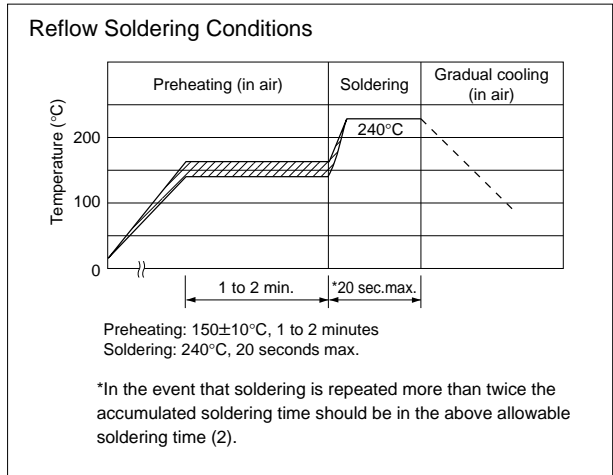

- (4) There may be a risk of unexpected failures (tombstone, insufficient solder-wetting, etc.) in the mounting process, caused by the mounting conditions. Please make sure that this product is correctly mounted under specified mounting conditions.

For POSISTOR[®] Chip Type ⚠ Caution/Notice

■ Notice (Handling)

1. Do not give this product a strong press-force nor a mechanical shock, because such mechanical forces may cause cracking or chipping of this ceramic product.
2. Rapid cooling or heating during soldering is not recommended.
Such treatment may destroy the element.
3. Resin coating
Please select a resin material with minimum hardness.
Shrinkage is much less if selecting a resin material.
4. Location on Printed Circuit Board (PC Board)
Choose a mounting position that minimizes the stress imposed on the chip during flexing or bending of the board.

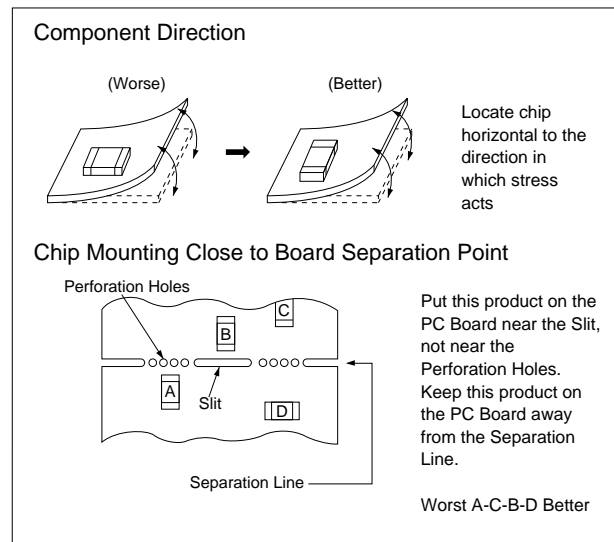

NTC/PTC Thermistors for Automotive



PTC Thermistor (POSISTOR®) for Overcurrent Protection Lead Type

16V Series

This low-voltage, low-resistance type "POSISTOR" is a circuit protector whose resistance value in normal operation is very low and in abnormal situations like motor lock or short circuit, will be increased to restrain over current. This "POSISTOR" is most suitable for low-voltage circuits and motor protection for automotive grade applications.

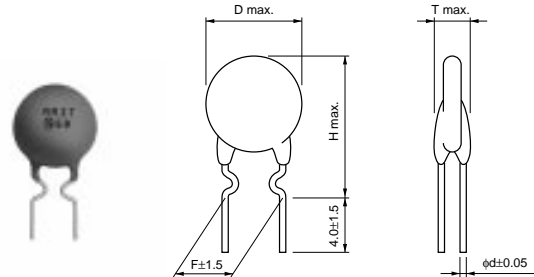

(in mm)

■ Features

1. Best suited to meet the requirements for power supply and motor protection. Error-free operation is assured by rush current.
2. Circuit is protected until current is turned off.
3. Restores the original low resistance value automatically once the overload is removed.
4. Non-contact design leads to long life and no noise. Durable and strong against mechanical vibration and shock because it is a solid element.
5. Lead (Pb) is not contained in the terminations.

Part Number	Max. Voltage (V)	Non-operating Current (at +85°C) (mA)	Trip Current (at -30°C) (mA)	Max. Current (A)	Resistance (at 25°C) (ohm)	Temperature Range (°C)	Body Diameter (D) (mm)	Thickness (T) (mm)	Height (H) (mm)	Lead Space (F) (mm)	Lead Diameter (phi d)(mm)
PTGL5SAR1R0M1B51B0	16	252	1095	2.0	1.0 ±20%	-30 to 85	6.0	3.5	9.5	5.0	0.6
PTGL6SAR0R8M1B51B0	16	274	1193	3.0	0.8 ±20%	-30 to 85	6.5	3.5	10.0	5.0	0.6
PTGL7SARR47M1B51B0	16	376	1634	5.0	0.47 ±20%	-30 to 85	7.5	3.5	12.0	5.0	0.6
PTGL9SARR33M1B51B0	16	466	2026	7.0	0.33 ±20%	-30 to 85	9.0	3.5	14.0	5.0	0.6
PTGLASARR27M1B51B0	16	545	2369	8.0	0.27 ±20%	-30 to 85	10.1	3.5	15.0	5.0	0.6
PTGLCSAR0R2M1B51B0	16	692	3006	9.0	0.2 ±20%	-30 to 85	11.3	3.5	16.0	5.0	0.6
PTGLESARR15M1B51B0	16	820	3561	10	0.15 ±20%	-30 to 85	13.5	3.5	18.5	5.0	0.6

Maximum Current shows typical capacities of the transformer which can be used.
 Taping type of part numbers with "A0" is available (Except PTGLESARR15M1B51B0).

6

30-140V Series

New leaded type POSISTOR for overcurrent protection as automotive grade can be used with wide temperature range. This product is suitable for short-protect and current limiting resistor on power supply equipment.

■ Features

1. This product has useful Protective threshold current range with wide temperature range.
2. Small fluctuation in the circuit due to resistance tolerance +/-10%.
3. Quick operating time due to small size compared with conventional products.
4. Best suited to meet the requirements for power supply and motor protector. Error-free operations are assured by rush current.
5. Circuit is protected until current is turned off.
6. Restores the original low resistance value automatically once the overload is removed.
7. Non-contact design leads to long life and no noise. Durable and strong against mechanical vibration and shock because it is a solid element.
8. Lead (Pb) is not contained in the terminations.

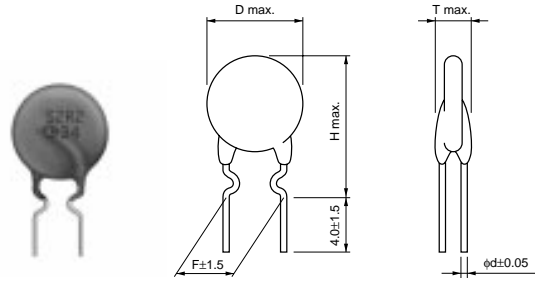

(in mm)

Part Number	Max. Voltage (V)	Non-operating Current (at +85°C) (mA)	Non-operating Current (at +105°C) (mA)	Trip Current (at -40°C) (mA)	Max. Current (A)	Resistance (at 25°C) (ohm)	Temperature Range (°C)	Body Diameter (D) (mm)	Thickness (T) (mm)	Height (H) (mm)	Lead Space (F) (mm)	Lead Diameter (phi d)(mm)
PTGL4SAS100K2N51B0	30	92	65	261	1.5	10 ±10%	-40 to 125	4.5	3.5	9.5	5.0	0.5
PTGL4SAS100K2B51B0	30	127	89	359	2.0	10 ±10%	-40 to 125	4.5	3.5	9.5	5.0	0.6
PTGL5SAS3R9K2B51B0	30	204	143	576	3.5	3.9 ±10%	-40 to 125	5.5	3.5	10.5	5.0	0.6
PTGL7SAS2R7K2B51B0	30	255	179	720	4.5	2.7 ±10%	-40 to 125	7.3	3.5	12.3	5.0	0.6
PTGL7SAS1R8K2B51B0	30	319	223	902	5.0	1.8 ±10%	-40 to 125	7.3	3.5	12.3	5.0	0.6
PTGL9SAS1R2K2B51B0	30	422	296	1193	6.0	1.2 ±10%	-40 to 125	9.3	3.5	14.3	5.0	0.6
PTGLCSAS0R8K2B51B0	30	520	364	1470	7.0	0.8 ±10%	-40 to 125	11.5	3.5	16.5	5.0	0.6
PTGL4SAS100K3B51B0	51	128	89	361	1.0	10 ±10%	-40 to 125	4.5	3.5	9.5	5.0	0.6
PTGL5SAS6R8K3B51B0	51	149	105	422	1.5	6.8 ±10%	-40 to 125	5.5	3.5	10.5	5.0	0.6
PTGL7SAS3R3K3B51B0	51	233	163	659	3.0	3.3 ±10%	-40 to 125	7.3	3.5	12.3	5.0	0.6
PTGL9SAS2R2K3B51B0	51	313	219	885	4.0	2.2 ±10%	-40 to 125	9.3	3.5	14.3	5.0	0.6
PTGLCSAS1R2K3B51B0	51	449	315	1270	5.0	1.2 ±10%	-40 to 125	11.5	3.5	16.5	5.0	0.6
PTGL4SAS220K4N51B0	60	67	47	190	1.0	22 ±10%	-40 to 125	4.5	3.5	9.5	5.0	0.5
PTGL4SAS220K4B51B0	60	87	61	246	1.0	22 ±10%	-40 to 125	4.5	3.5	9.5	5.0	0.6
PTGL5SAS100K4B51B0	60	129	90	364	1.5	10 ±10%	-40 to 125	5.5	3.5	10.5	5.0	0.6
PTGL7SAS5R6K4N51B0	60	142	99	400	2.2	5.6 ±10%	-40 to 125	7.3	3.5	12.3	5.0	0.5
PTGL7SAS5R6K4B51B0	60	174	122	492	3.0	5.6 ±10%	-40 to 125	7.3	3.5	12.3	5.0	0.6
PTGL9SAS3R3K4B51B0	60	253	177	714	4.0	3.3 ±10%	-40 to 125	9.3	3.5	14.3	5.0	0.6
PTGLCSAS2R2K4B51B0	60	334	234	942	5.0	2.2 ±10%	-40 to 125	11.5	3.5	16.5	5.0	0.6
PTGL4SAS560K6B51B0	140	56	39	159	0.5	56 ±10%	-40 to 125	5.5	4.5	10.5	5.0	0.6
PTGL5SAS270K6B51B0	140	80	56	227	1.0	27 ±10%	-40 to 125	5.5	4.5	10.5	5.0	0.6
PTGL7SAS150K6B51B0	140	112	79	317	1.5	15 ±10%	-40 to 125	7.3	4.5	12.3	5.0	0.6
PTGL9SAS120K6B51B0	140	146	102	413	2.0	12 ±10%	-40 to 125	9.3	4.5	14.3	5.0	0.6
PTGL9SAS7R6K6B51B0	140	172	121	486	2.2	7.6 ±10%	-40 to 125	9.3	4.5	14.3	5.0	0.6
PTGLCSAS4R7K6B51B0	140	236	165	666	3.5	4.7 ±10%	-40 to 125	11.5	4.5	16.5	5.0	0.6

Maximum Current shows typical capacities of the transformer which can be used.
 These series are recognized by UL.
 Taping type is also available (PTGL_A0 series).

■ Protective Threshold Current Range (16V Series)

PTGL5SAR1R0M1B51B0

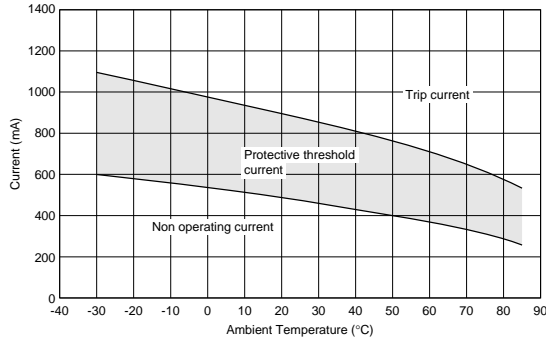

PTGL6SAR0R8M1B51B0

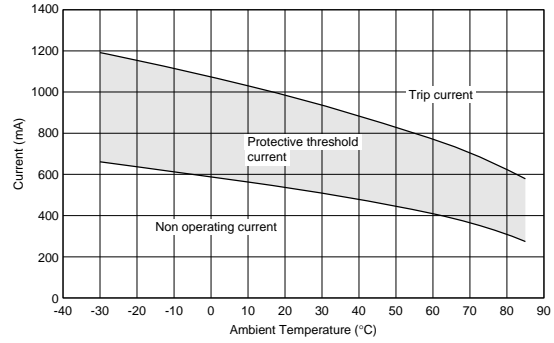

PTGL7SARR47M1B51B0

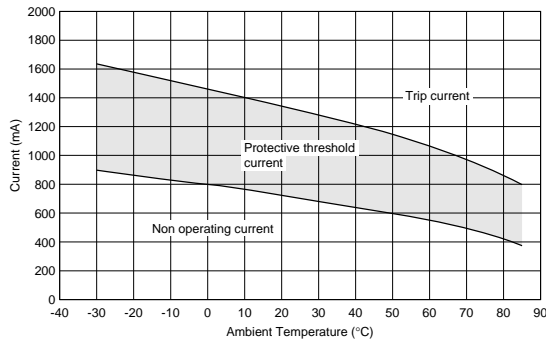

PTGL9SARR33M1B51B0

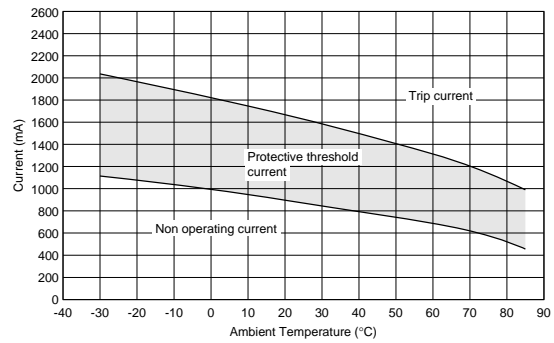

PTGLASARR27M1B51B0

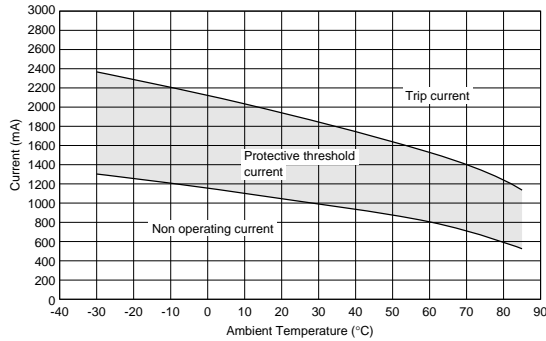

PTGLCSAR0R2M1B51B0

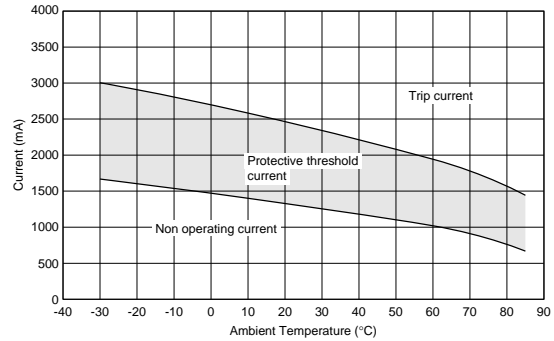

6

PTGLESARR15M1B51B0

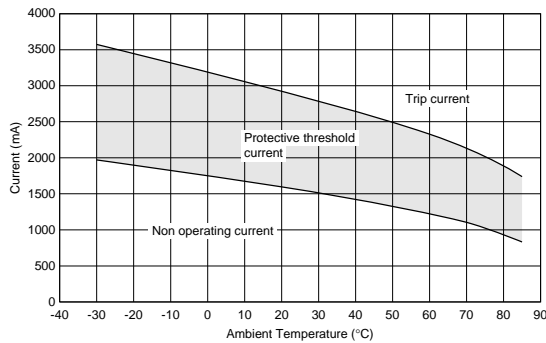

■ Protective Threshold Current Range (30V Series)

PTGL4SAS100K2N51B0

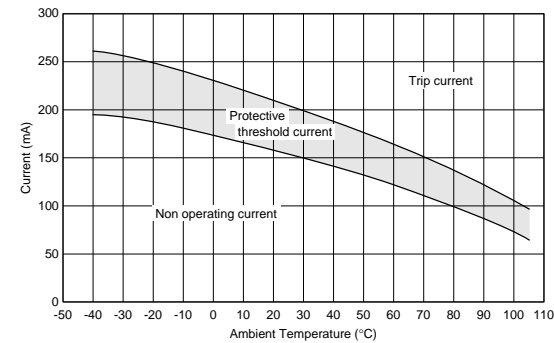

Continued on the following page. ↗

Continued from the preceding page.

■ Protective Threshold Current Range (30V Series)

PTGL4SAS100K2B51B0

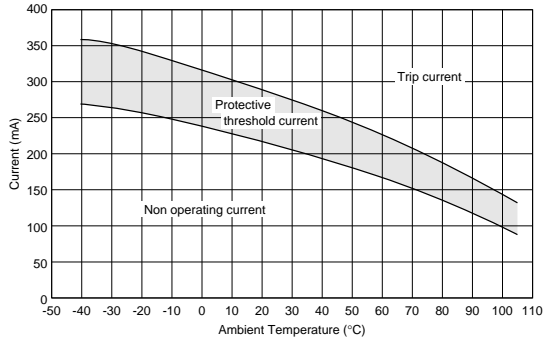

PTGL5SAS3R9K2B51B0

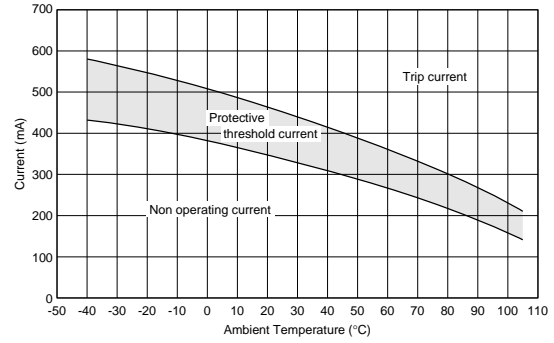

PTGL7SAS2R7K2B51B0

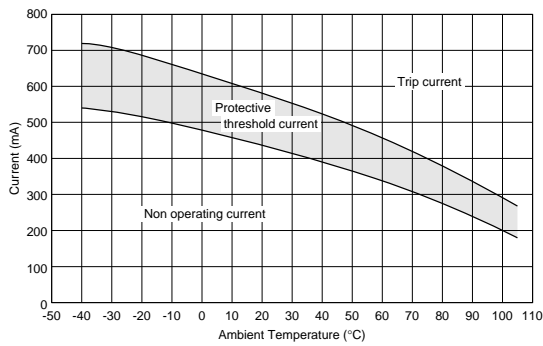

PTGL7SAS1R8K2B51B0

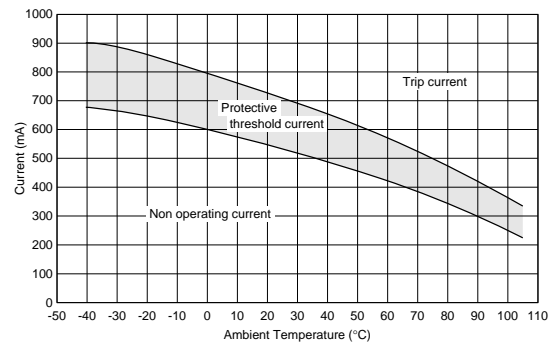

PTGL9SAS1R2K2B51B0

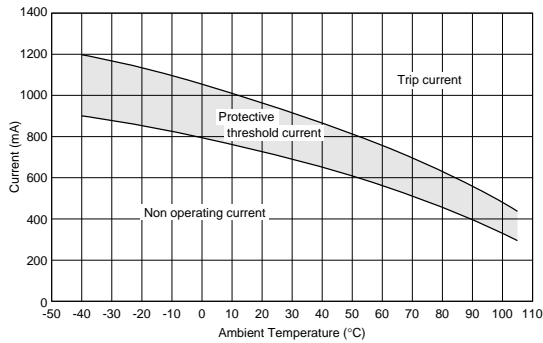

PTGLCSAS0R8K2B51B0

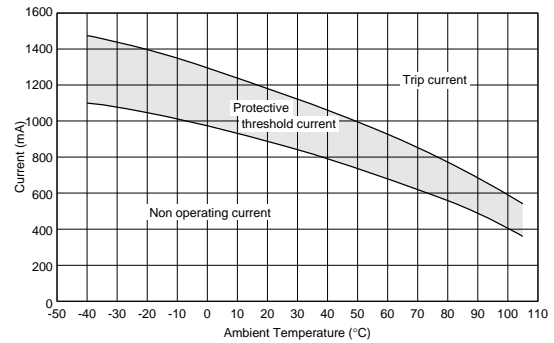

6

■ Protective Threshold Current Range (51V Series)

PTGL4SAS100K3B51B0

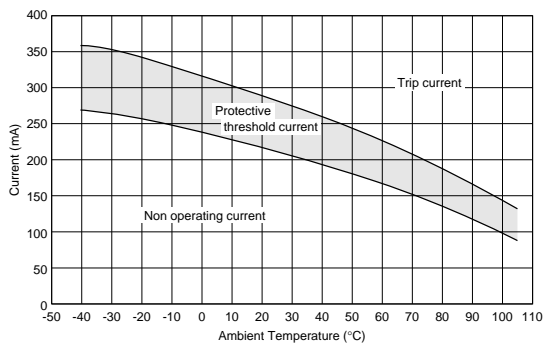

PTGL5SAS6R8K3B51B0

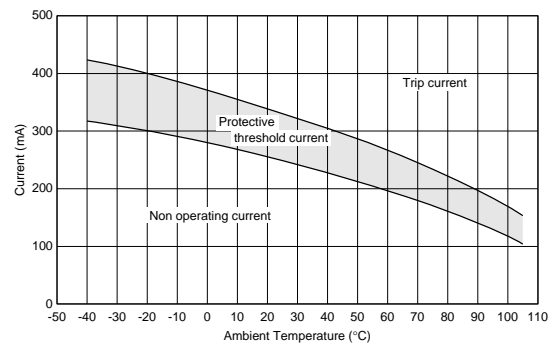

Continued on the following page. ↗

Continued from the preceding page.

■ Protective Threshold Current Range (51V Series)

PTGL7SAS3R3K3B51B0

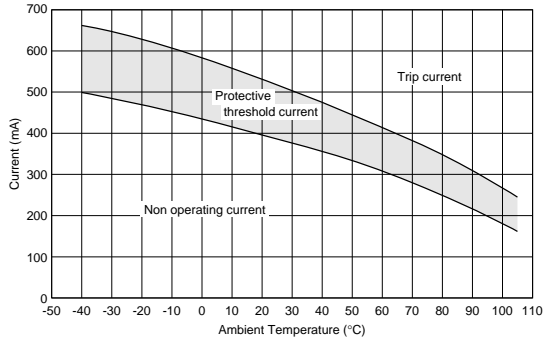

PTGL9SAS2R2K3B51B0

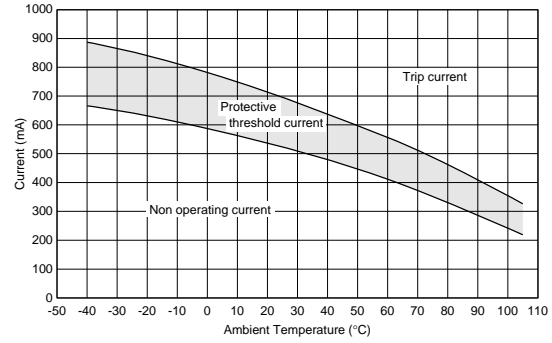

PTGLCSAS1R2K3B51B0

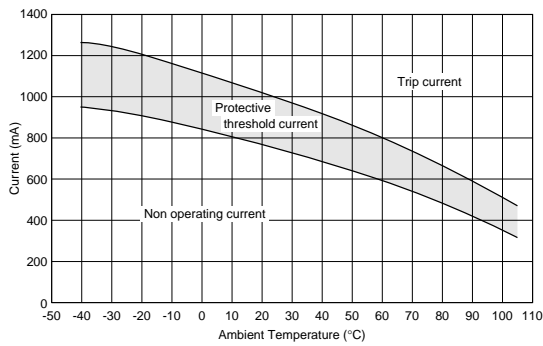

PTGL4SAS220K4N51B0

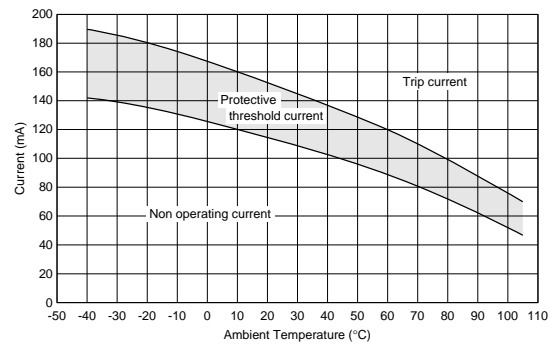

PTGL4SAS220K4B51B0

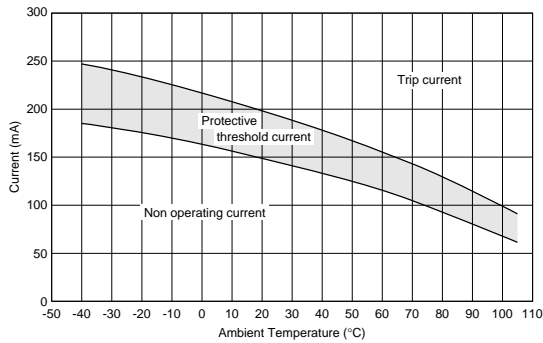

PTGL5SAS100K4B51B0

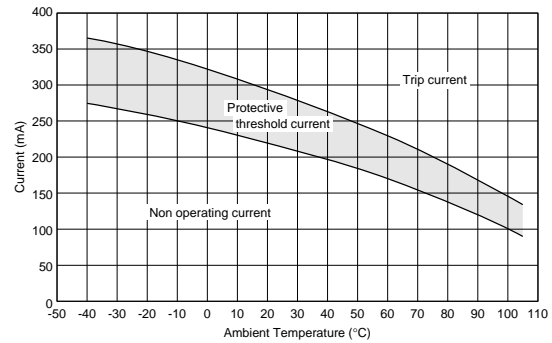

PTGL7SAS5R6K4N51B0

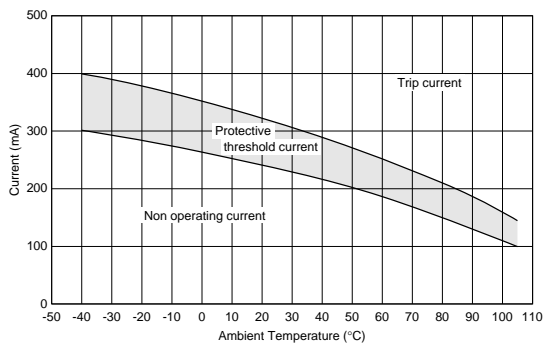

PTGL7SAS5R6K4B51B0

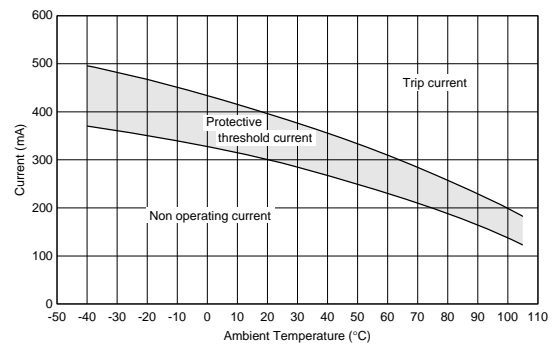

6

Continued on the following page. ↗

Continued from the preceding page.

■ Protective Threshold Current Range (60V Series)

PTGL9SAS3R3K4B51B0

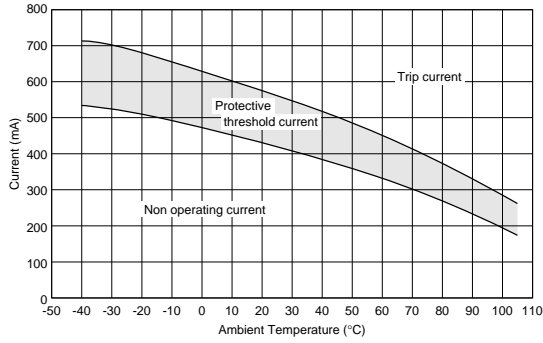

PTGLCSAS2R2K4B51B0

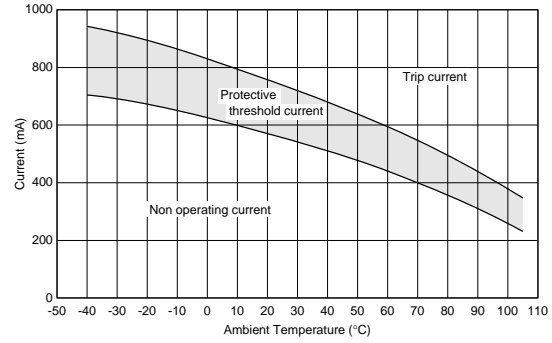

■ Protective Threshold Current Range (140V Series)

PTGL4SAS560K6B51B0

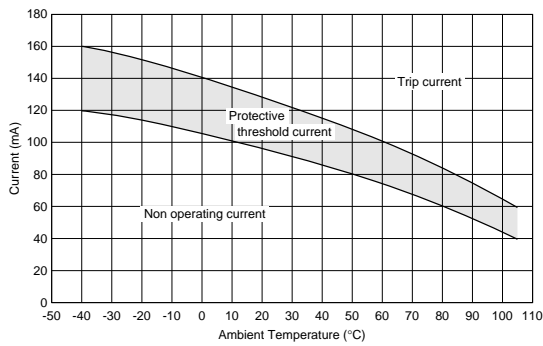

PTGL5SAS270K6B51B0

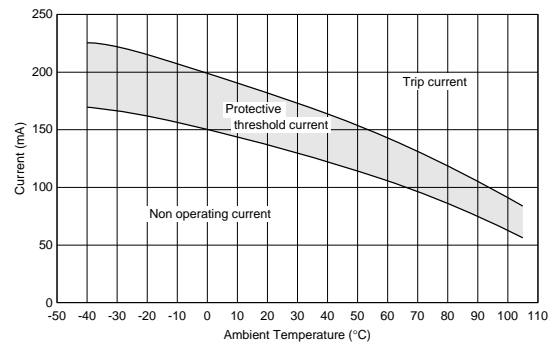

PTGL7SAS150K6B51B0

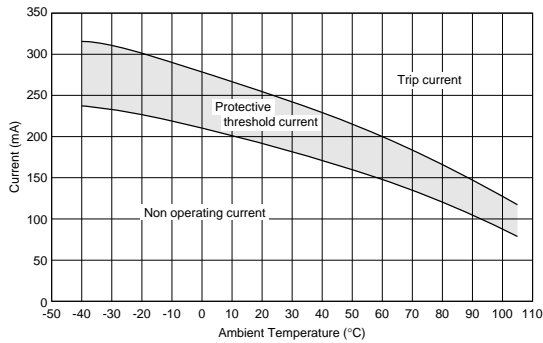

PTGL9SAS120K6B51B0

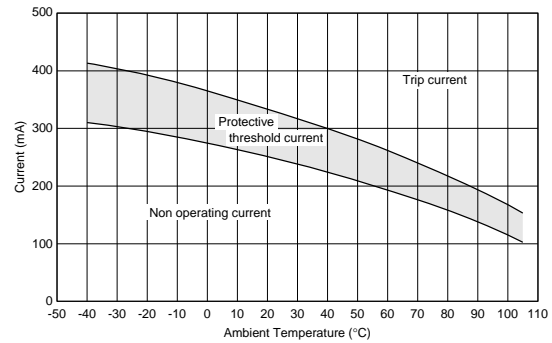

PTGL9SAS7R6K6B51B0

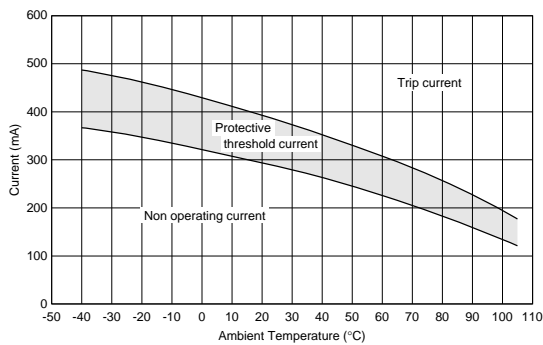

PTGLCSAS4R7K6B51B0

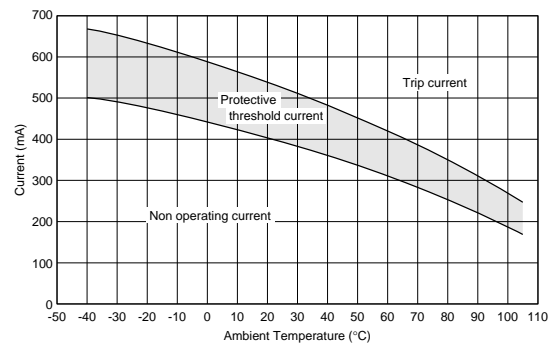

6

Continued on the following page. ↗

Continued from the preceding page.

■ Operating Time (Typical Curve) (16V Series)

PTGL5SAR1R0M1B51B0

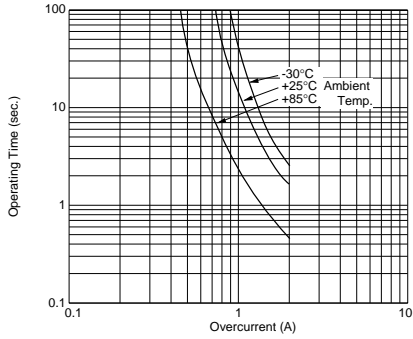

PTGL6SAR0R8M1B51B0

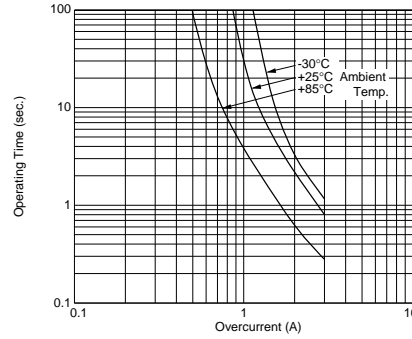

PTGL7SARR47M1B51B0

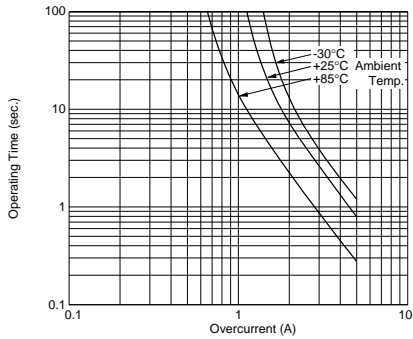

PTGL9SARR33M1B51B0

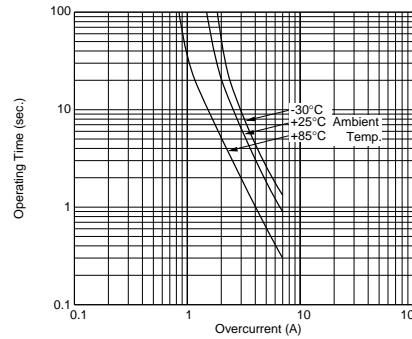

PTGLASARR27M1B51B0

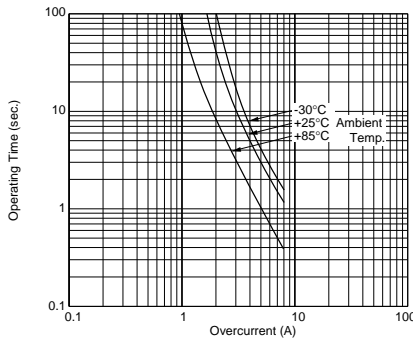

PTGLCSAR0R2M1B51B0

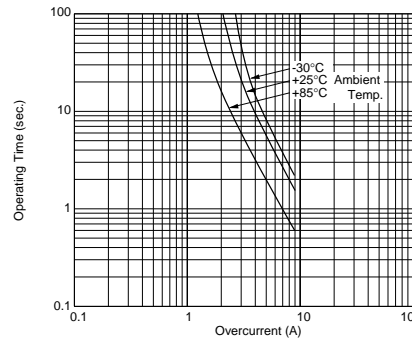

6

■ Operating Time (Typical Curve) (30V Series)

PTGLESARR15M1B51B0

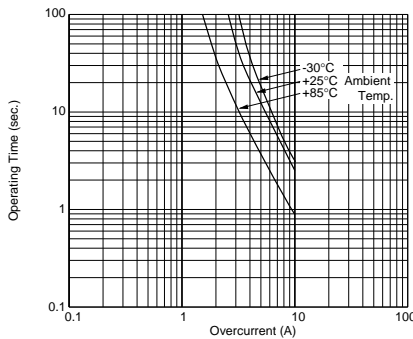

PTGL4SAS100K2N51B0

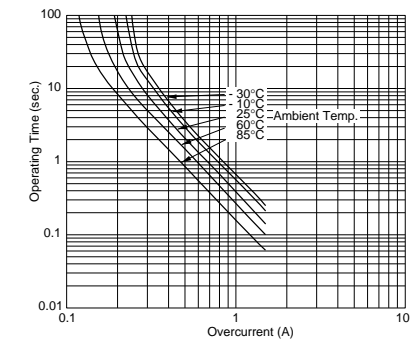

Continued on the following page. ↗

Continued from the preceding page.

Operating Time (Typical Curve) (30V Series)

PTGL4SAS100K2B51B0

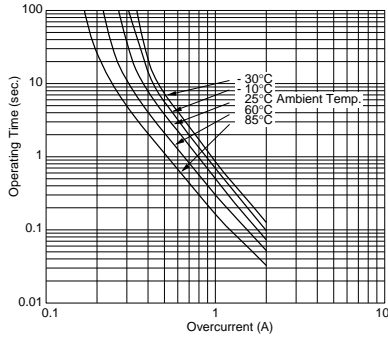

PTGL5SAS3R9K2B51B0

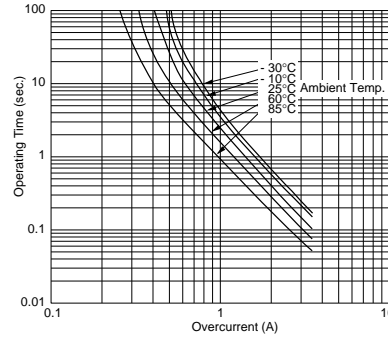

PTGL7SAS2R7K2B51B0

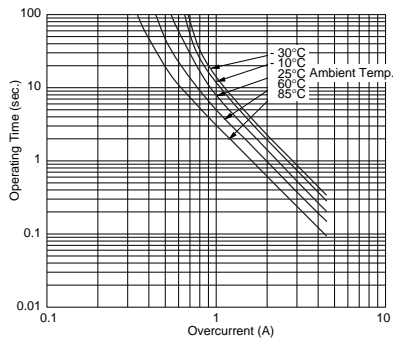

PTGL7SAS1R8K2B51B0

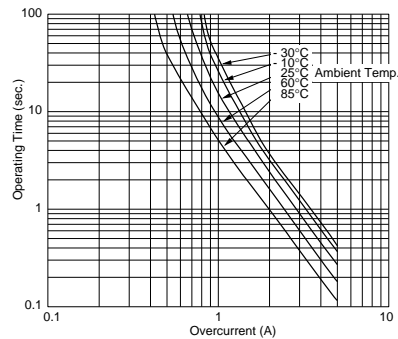

PTGL9SAS1R2K2B51B0

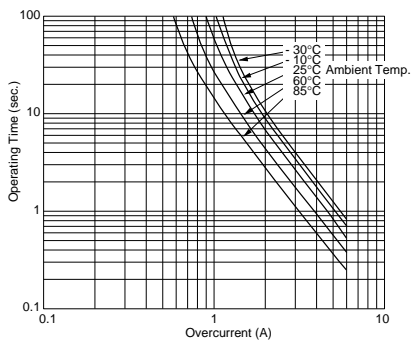

PTGLCSAS0R8K2B51B0

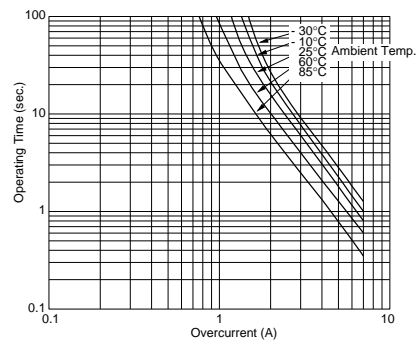

6

Operating Time (Typical Curve) (51V Series)

PTGL4SAS100K3B51B0

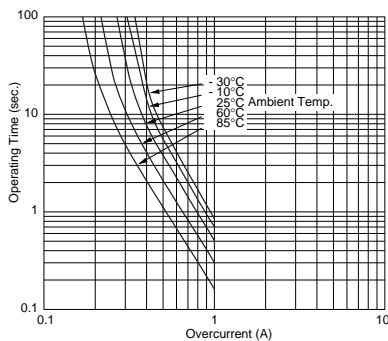

PTGL5SAS6R8K3B51B0

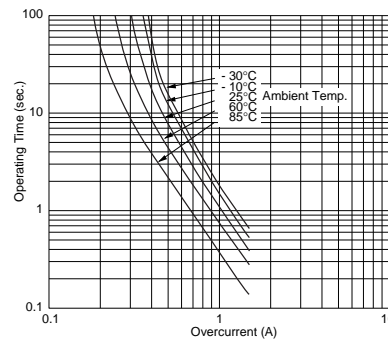

Continued on the following page. ↗

Continued from the preceding page.

■ Operating Time (Typical Curve) (51V Series)

PTGL7SAS3R3K3B51B0

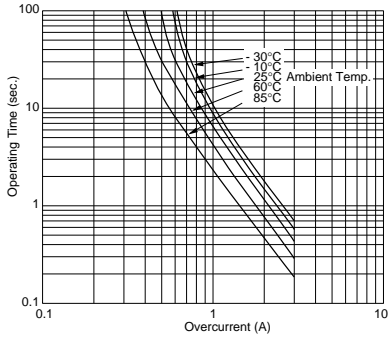

PTGL9SAS2R2K3B51B0

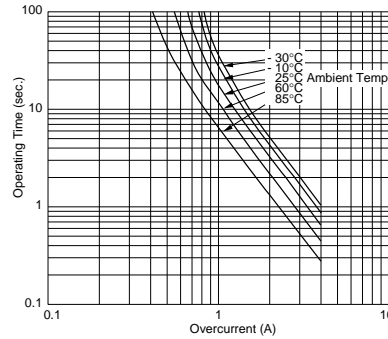

■ Operating Time (Typical Curve) (60V Series)

PTGLCSAS1R2K3B51B0

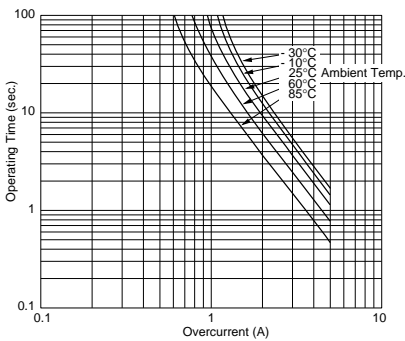

PTGL4SAS220K4N51B0

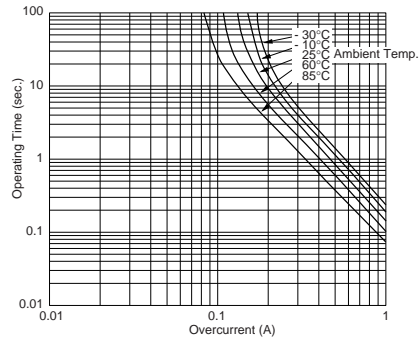

PTGL4SAS220K4B51B0

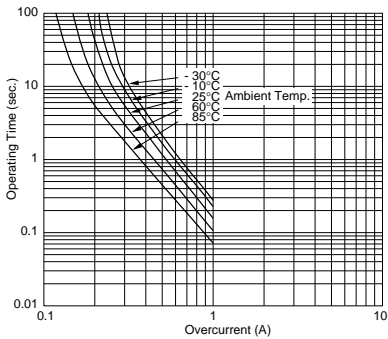

PTGL5SAS100K4B51B0

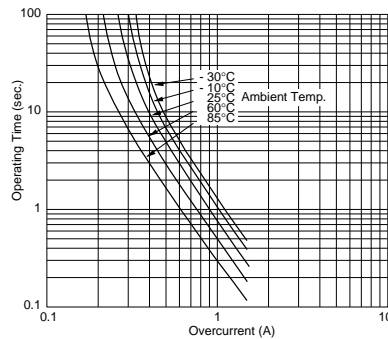

PTGL7SAS5R6K4N51B0

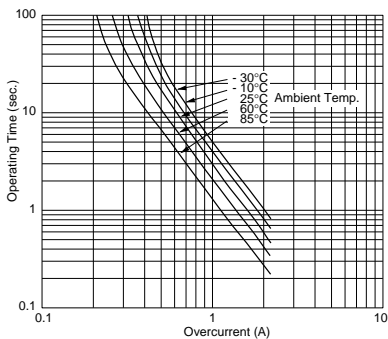

PTGL7SAS5R6K4B51B0

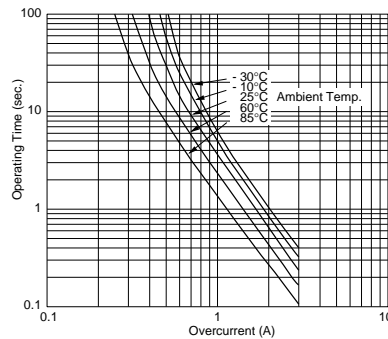

6

Continued on the following page. ↗

Continued from the preceding page.

■ Operating Time (Typical Curve) (60V Series)

PTGL9SAS3R3K4B51B0

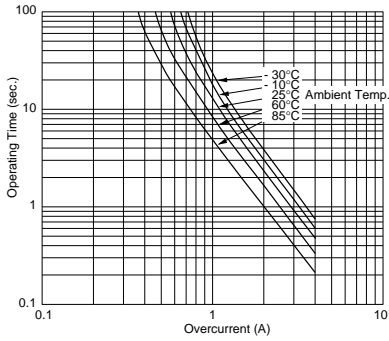

PTGLCSAS2R2K4B51B0

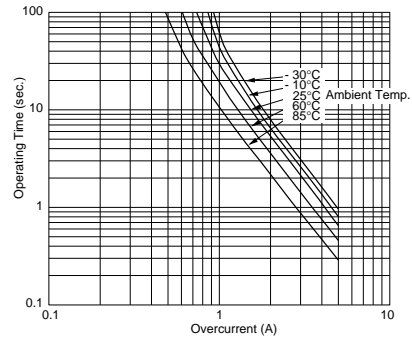

■ Operating Time (Typical Curve) (140V Series)

PTGL4SAS560K6B51B0

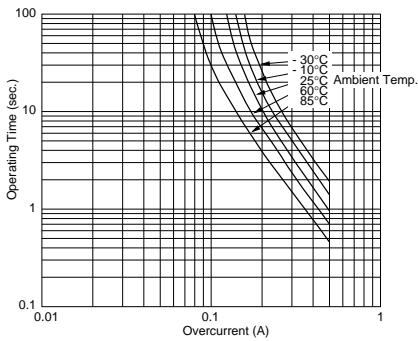

PTGL5SAS270K6B51B0

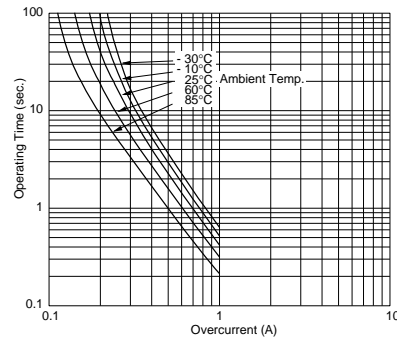

PTGL7SAS150K6B51B0

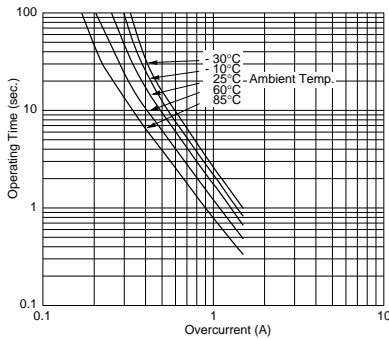

PTGL9SAS120K6B51B0

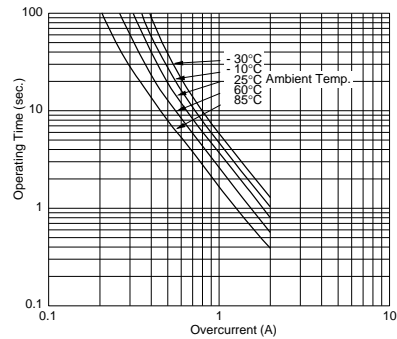

PTGL9SAS7R6K6B51B0

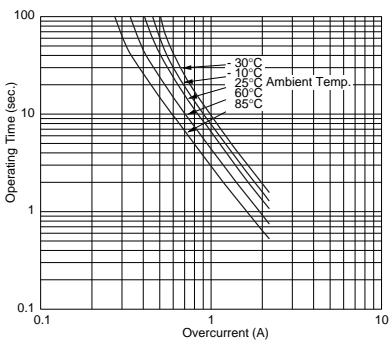

PTGLCSAS4R7K6B51B0

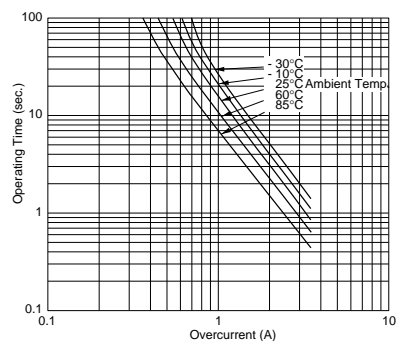

POSISTOR® Lead Type for Overheat Protection Specifications and Test Methods

■16V Series

No.	Item	Rating Value	Method of Examination
1	Operating Temperature	-30 to +85°C	The temperature range with maximum voltage applied to the POSISTOR®.
2	Resistance (R25)	Satisfies specification	Resistance value is measured by applying voltage under 1.5Vdc (by a direct current of less than 10mA) at 25°C. (But it must be measured after maximum voltage is applied 180 seconds and then is left for 2 hours at 25°C.)
3	Withstanding Voltage	No problem	We apply AC voltage 110% that of the maximum voltage to POSISTOR® by raising voltage gradually for 180±5 seconds at 25°C. (A protective resistor is to be connected in series, and the inrush current through POSISTOR® must be limited below maximum rated value.)
4	Protective Threshold Current	Satisfies ratings (Trip Current, Non-operating Current)	Maximum current measured in this examination. Voltage is applied to POSISTOR® in 3 minutes step by step on still air. Stable current is measured at each step.
5	Tensile Strength of Lead Wire Terminal	No damage	The load is gradually applied to each terminal of POSISTOR® until the force of 4.9N in the axial direction with fixing POSISTOR®'s body itself and this load is being kept for 10 seconds.
6	Bending Strength of Lead Wire Terminal	Lead wire does not come off	POSISTOR® is held so that it is perpendicular to the lead wire with 2.45N in the axial direction of the lead wire. The lead wire is slowly bent toward 90° and returned; then it is slowly bent in the opposite direction and returned to original state.
7	Solderability	Solder is applied around the lead wire covering 3/4 or more of the circumference without gap in the axial direction.	The lead wire of POSISTOR® is soaked in a Isopropyl Alcohol (JIS K 8839) solution (about 25wt%) of colophony (JIS K 5902) for 5-10 seconds. And, each lead wire is soaked in molten solder (JIS Z 3282 H60A) at 235±5°C from the bottom to a point of 2.0-2.5mm for 2±0.5 seconds.
8	Terminal Durability of Soldering	$\Delta R/R25 \leq \pm 15\%$	The lead wire of POSISTOR® is soaked in molten solder (JIS Z 3282 H60A) at 350±10°C from the bottom to a point of 2.0-2.5mm for 3.5±0.5 seconds. After the device is left at room temperature (25°C) for 24±4 hours, the resistance is measured.
9	Heat Resistant	$\Delta R/R25 \leq \pm 20\%$ No damage about marking	At 85±3°C chamber, POSISTOR® is applied max. voltage for 1.5 hr on and 0.5 hr off. This cycle is repeated for 500±10 hours, and after the device is left at room temperature (25°C) for 1 hour, the resistance measurement is performed. (A protective resistance is to be connected in series and the inrush current through POSISTOR® must be limited below max. rated value.)
10	Resistance to Damp Heat	$\Delta R/R25 \leq \pm 20\%$ No damage about marking	POSISTOR® is set in an environmental chamber at 40±2°C and 90% to 95% humidity, for 500±4 hours. And, after the device is left at room temperature (25°C) for 1 hour, the resistance measurement is performed.

POSISTOR® Lead Type for Overheat Protection Specifications and Test Methods

■30-140V Series

No.	Item	Rating Value	Method of Examination
1	Operating Temperature 1	-30 to +125°C	The temperature range with maximum voltage applied to the POSISTOR®.
2	Operating Temperature 2	-40 to +125°C	The temperature range with following voltage applied to the POSISTOR®. <applied voltage> 30V and 51V series: max. 16V, 60V series: max. 30V, 140V series: max. 140V
3	Resistance (R25)	Satisfies ratings	Resistance value is measured by applying voltage under 1.0Vdc (by a direct current of less than 10mA) at 25°C. (But it must be measured after it is applied maximum voltage for 180 seconds and then is left for 2 hours at 25°C.)
4	Withstanding Voltage	No problem	We apply AC voltage 120% that of the maximum voltage to POSISTOR® by raising voltage gradually for 180±5 seconds at 25°C. (A protective resistor is to be connected in series, and the inrush current through POSISTOR® must be limited below max. rated value.)
5	Protective Threshold Current	Satisfies ratings (Trip Current, Non-operating Current)	Maximum current measured in this examination. Voltage is applied to POSISTOR® in 3 minutes step by step on still air based on "Protective Threshold Current Test Conditions" shown in next page. Stable current is measured at each step.
6	Tensile Strength of Lead Wire Terminal	No damage	The load is gradually applied to each terminal of POSISTOR® until the force of 4.9N in the axial direction with fixing POSISTOR®'s body itself and this load is being kept for 10 seconds.
7	Bending Strength of Lead Wire Terminal	Lead wire does not come off	POSISTOR® is held so that it is perpendicular to the lead wire with 2.45N in the axial direction of the lead wire. The lead wire is slowly bent toward 90° and returned; then it is slowly bent in the opposite direction and returned to original state.
8	Solderability	Solder is applied around the lead wire covering 3/4 or more of the circumference without gap in the axial direction.	The lead wire of POSISTOR® is soaked in a Isopropyl Alcohol (JIS K 8839) solution (about 25wt%) of colophony (JIS K 5902) for 5-10 sec. And, each lead wire is soaked in molten solder (JIS Z 3282 H60A) at 235±5°C from the bottom to a point of 2.0-2.5mm for 2±0.5 seconds.
9	Terminal Durability of Soldering	$\Delta R/R25 \leq \pm 15\%$	The lead wire of POSISTOR® is soaked in molten solder (JIS Z 3282 H60A) at 350±10°C from the bottom to a point of 2.0-2.5mm for 3.5±0.5 sec. After the device is left at room temperature (25°C) for 24±4 hours, the resistance is measured.
10	Vibration Resistant	$\Delta R/R25 \leq \pm 20\%$	Acceleration: 98m/s ² (10G) Width: 1.5mm Vibration: 10-500-10Hz Vibrate for 11minutes X 24 cycles in each of 3 mutually perpendicular planes for a total of 13.5 hours.
11	Heat Resistant	$\Delta R/R25 \leq \pm 20\%$	POSISTOR® is set in an environmental chamber at 125±3°C for 1000±12 hours. After the device is left at room temperature (25°C) for one hour, the resistance measurement is performed.
12	Cold Resistant	$\Delta R/R25 \leq \pm 20\%$	POSISTOR® is set in an environmental chamber at -40±3°C for 1000±12 hours. After the device is left at room temperature (25°C) for one hour, the resistance measurement is performed.
13	Resistance to Damp Heat	$\Delta R/R25 \leq \pm 20\%$	POSISTOR® is set in an environmental chamber at 85±3°C and 80-85% humidity for 1000±12 hours. After the device is left at room temperature (25°C) for one hour, the resistance measurement is performed.

Continued on the following page. 

POSISTOR® Lead Type for Overheat Protection Specifications and Test Methods

☒ Continued from the preceding page.

■ Protective Threshold current test conditions

(1) Substrate

Materials: Phenol

Size: 50x50x1.6mm

Land Pattern: Cu land without through hole

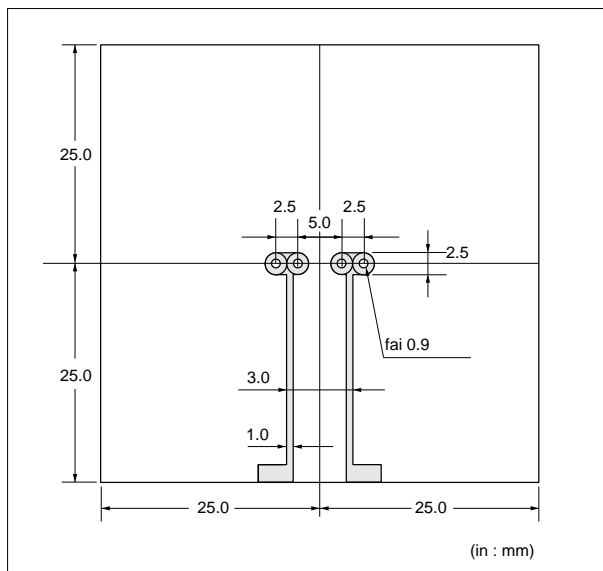

(2) Measurement condition

Solder POSISTOR® on the substrate, then put the cover (150mm cubed) surround POSISTOR® to prevent flow of wind.

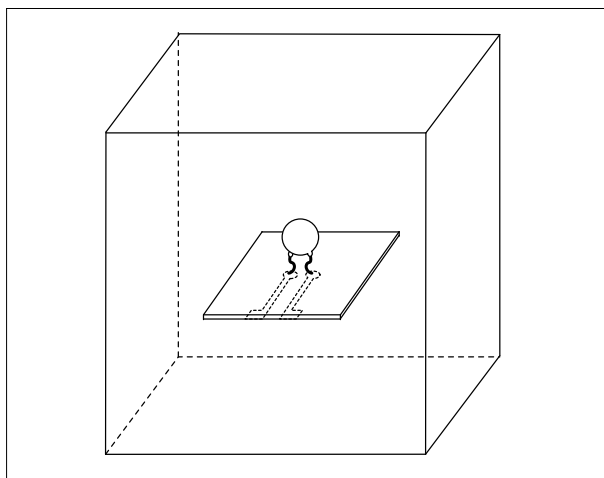

(3) Measurement circuit

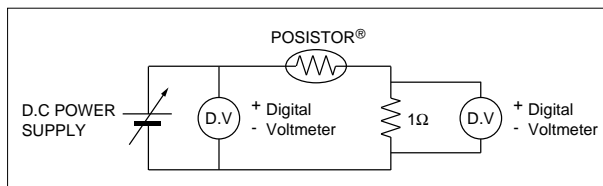

POSISTOR® Lead Type for Overheat Protection ⚠Caution/Notice

■ ⚠Caution (Storage and Operating Condition)

This product is designed for application in an ordinary environment (normal room temperature, humidity and atmospheric pressure). Do not use under the following conditions because all these factors can deteriorate the characteristics or cause product failure and burn-out.

1. Corrosive gas or deoxidizing gas (Chlorine gas, Hydrogen sulfide gas, Ammonia gas, Sulfuric acid gas, Nitric oxide gas, etc.)
2. Volatile or flammable gas
3. Dusty conditions
4. Under vacuum, or under high or low-pressure
5. Wet or humid conditions
6. Places with salt water, oils, chemical liquids or organic solvents
7. Strong vibrations
8. Other places where similar hazardous conditions exist

■ ⚠Caution (Other)

Be sure to provide an appropriate fail-safe function on your product to prevent secondary damage that may be caused by the abnormal function or the failure of our product.

■ Notice (Storage and Operating Condition)

To keep solderability of product from declining, following storage condition is recommended.

1. Storage condition:
 - Temperature -10 to +40 degrees C
 - Humidity less than 75%RH (not dewing condition)
2. Storage term:
 - Use this product within 6 months after delivery by first-in and first-out stocking system.
3. Handling after unpacking:
 - After unpacking, promptly reseal this product or store it in a sealed container with a drying agent.
4. Storage place:
 - Do not store this product in corrosive gas (Sulfuric acid, Chlorine, etc.) or in direct sunlight.

6

■ Notice (Soldering and Mounting)

When the lead of this product is soldered, pay attention as follows to avoid the decline of element characteristics or break-down of the element.

1. Use Rosin type flux or non-activated flux
2. Do not dip the body into flux (flux should be coated to lead wire only for soldering).
3. Be sure that preheating does not melt the soldering of this product.

■ Notice (Handling)

1. Do not apply an excessive force to the lead. Otherwise, it may cause the junction between lead and element to break, or may crack the element. Therefore, holding the element side lead wire is recommended when lead wire is bent or cut.
2. This product does not have waterproof construction. Splashed water may cause failure mode such as decline of characteristics or current leak.
3. When this product is operated, temperature of some areas may be over 100 to 160 degrees C. Be sure that surrounding parts and inserting material can withstand the temperature. If the surrounding part and material are kept under such conditions, they may deteriorate or produce harmful gas (Chlorine gas, Hydrogen sulfide gas, Ammonia gas, Sulfuric acid gas, Nitric oxide gas, etc.). And such harmful gas may deteriorate the element.

For NTC Thermistors Chip Type Package

■ Minimum Quantity Guide

Part Number	Quantity (pcs.)	
	Paper Tape	Embossed Tape
NCP15	10000	-
NCP18	4000	-

■ Tape Carrier Packaging

1. Dimensions of Reel

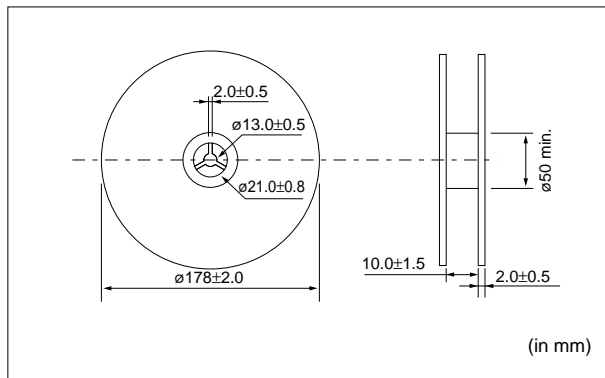

2. Taping Method

- (1) A tape in a reel contains Leader unit and Trailer unit where products are not packed. (Please refer to the figure at right.)
- (2) The top and base tapes or plastic and cover tape are not stuck at the first five pitches minimum.
- (3) A label should be attached on the reel. (MURATA's part number, inspection number and quantity should be marked on the label.)
- (4) Taping reels are packed in a package.

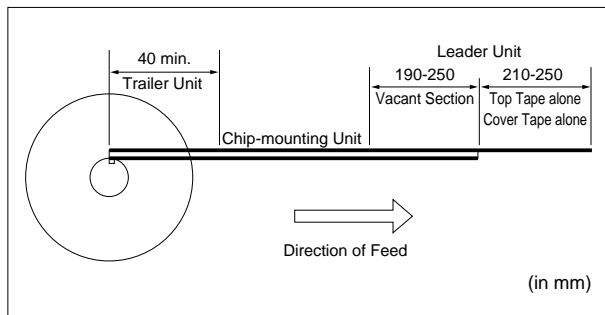

Continued on the following page.

For NTC Thermistors Chip Type Package

Continued from the preceding page.

3. Paper Tape (NCP15/18 Series)

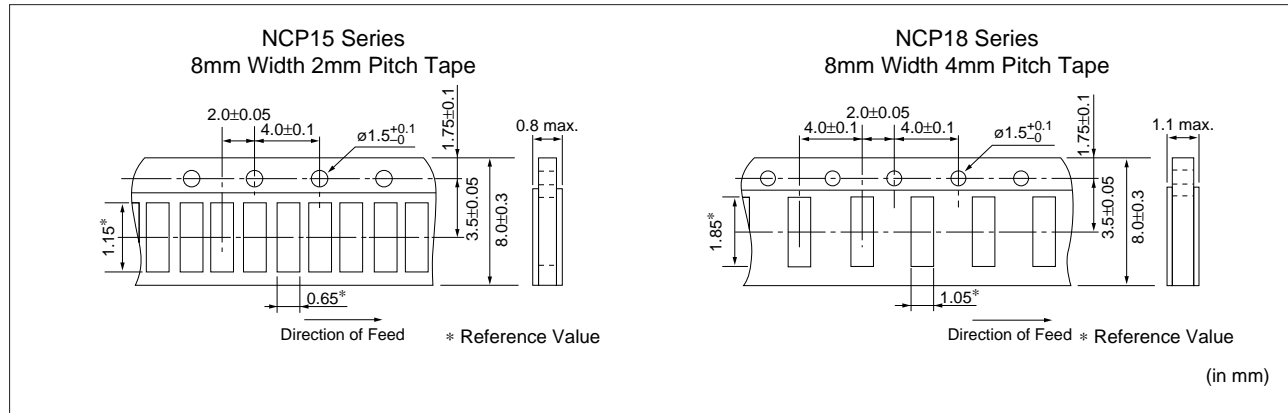

(1) Other Conditions

① Packaging

Products are packaged in the cavity of the base tape and sealed by top tape and bottom tape.

② Tape

Top tape and bottom tape have no joints and products are packaged and sealed in the cavity of the base tape, continuously.

(2) Peeling Force of Top Tape

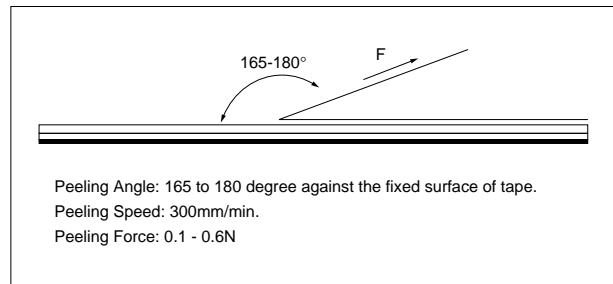

(3) Pull Strength

Pull strength of top tape is specified at 10N minimum.

Pull strength of bottom tape shall be specified 5N minimum.

For NTC Thermistors Lead Type Package

■ Minimum Quantity Guide

Part Number	Minimum Quantity (pcs.)	
	Taping (Ammo Pack)	Bulk*
NTSS	3000	100

* This quantity differs from actual delivery quantity in a package.

■ Taping Dimension (NTSS_N6A0 Series)

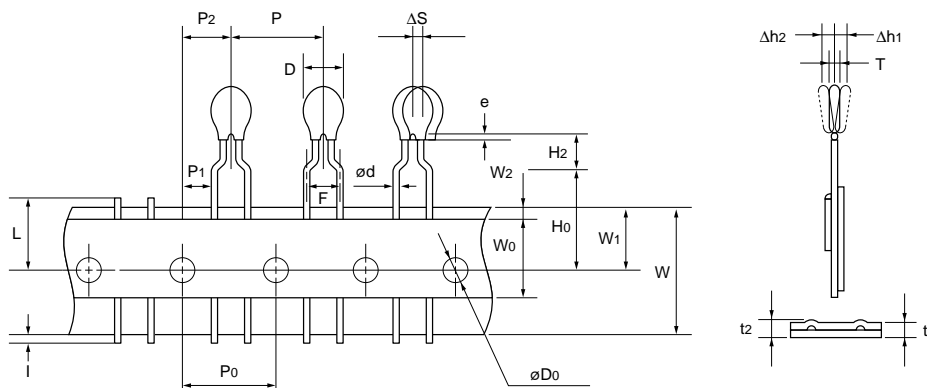

Item	Code	Dimension (mm)
Pitch of Component	P	12.7
Pitch of Sprocket Hole	P0	12.7±0.3
Lead Spacing	F	5.0+0.8/-0.2
Length from Hole Center to Component Center	P2	6.35±1.3
Length from Hole Center to Lead	P1	3.85±0.8
Body Diameter	D	3.5 max.
Deviation along Tape, Left or Right Defect	ΔS	0±2.0
Carrier Tape Width	W	18.0±0.5
Position of Sprocket Hole	W1	9.0±0.5
Lead Distance between Reference and Bottom Planes	H0	16.0±1.0
Height of Component	H2	4.0 max.
Protrusion Length	l	+0.5 to -1.0
Diameter of Sprocket Hole	D0	4.0±0.1
Lead Diameter	d	0.50±0.03
Total Tape Thickness	t1	0.6±0.3
Total Thickness, Tape and Lead Wire	t2	1.6 max.
Deviation across Tape	Δh1, Δh2	1.0 max.
Portion to Cut in Case of Defect	L	11.0+0/-2.0
Hole Down Tape Width	W0	11.0 min.
Hole Down Tape Position	W2	1.5±1.5
Coating Extension on Lead	e	Up to the crimp point
Body Thickness	T	2.6 max.

(in mm)

For POSISTOR[®] Chip Type Package

Minimum Quantity Guide

Part Number	Quantity (pcs.)	
	Paper Tape	Embossed Tape
PR*18_RB	4000	-
PR*21_RA	-	4000
PR*21_RK	-	3000

Tape Dimensions

PR*18_RB Series: Paper Tape

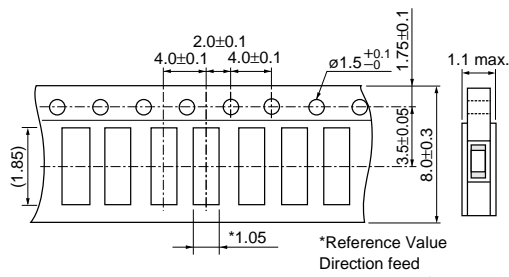

PR*21_RA Series: Embossed Tape

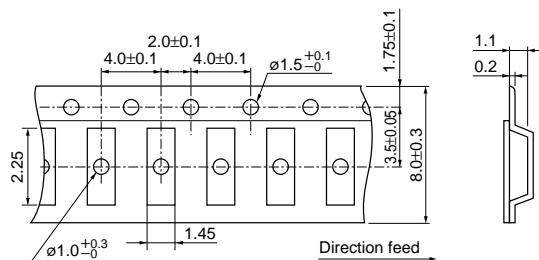

PR*21_RK Series: Embossed Tape

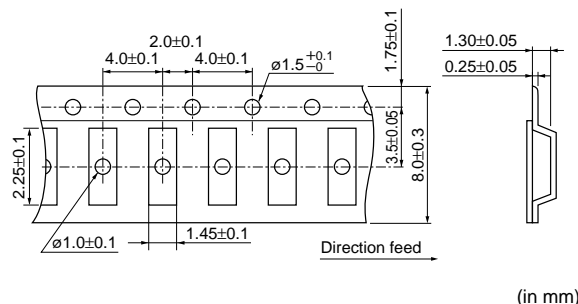

(in mm)

Reel Dimensions

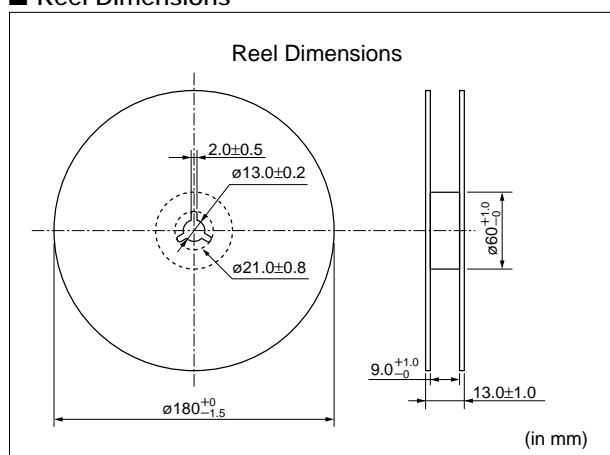

(in mm)

For POSISTOR® Lead Type Package

Minimum Quantity Guide

Part Number	Minimum Quantity (pcs.)	
	Taping (Ammo Pack)	Bulk*
PTGL (16V Series)	2000	100
PTGL (30 to 140V Series)	1500	100

* This quantity differs from actual delivery quantity in a package.

Taping Dimension (PTGL_A0 Series)

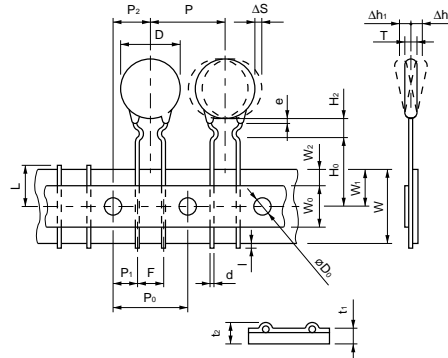

Item	Code	Dimensions (mm)	Note
Pitch of Component	P	12.7	Tolerance is determined by ΔS .
Pitch of Sprocket Hole	P ₀	12.7±0.3	
Lead Spacing	F	5.0 ^{+0.8} _{-0.3}	
Length from Hole Center to Lead	P ₁	3.85±0.8	
Length from Hole Center to Component Center	P ₂	6.35±1.3	Deviation in the feeding direction
Body Diameter	D	Please see in Ratings	
Body Thickness	T	Please see in Ratings	
Deviation along Tape, Left or Right Defect	ΔS	±1.5	Including the inclination caused by lead bending
Carrier Tape Width	W	18.0±0.5	
Position of Sprocket Hole	W ₁	9.0 ^{+0.5} _{-0.75}	Deviation of tape width
Lead Distance between Reference and Bottom Planes	H ₀	16.0±1.0	
	H ₂	6.0 max.	
Protrusion Length	l	+0.5 — -1.0	
Diameter of Sprocket Hole	D ₀	4.0±0.2	
Lead Diameter	d	Please see in Ratings	
Total Tape Thickness	t ₁	0.6±0.3	
Total Thickness of Tape and Lead Wire	t ₂	2.0 max.	
Deviation across Tape	$\Delta h_1, \Delta h_2$	1.5 max.	
Portion to cut in Case of Defect	L	11.0 ⁺⁰ _{-2.0}	
Hold Down Tape Width	W ₀	11.0 min.	
Hold Down Tape Position	W ₂	4.0 max.	
Coating Extension on Lead	e	Up to the center of crimp	

△Note:

1. Export Control

〈For customers outside Japan〉

No muRata products should be used or sold, through any channels, for use in the design, development, production, utilization, maintenance or operation of, or otherwise contribution to (1) any weapons (Weapons of Mass Destruction (nuclear, chemical or biological weapons or missiles) or conventional weapons) or (2) goods or systems specially designed or intended for military end-use or utilization by military end-users.

〈For customers in Japan〉

For products which are controlled items subject to the "Foreign Exchange and Foreign Trade Law" of Japan, the export license specified by the law is required for export.

2. Please contact our sales representatives or product engineers before using the products in this catalog for the applications listed below, which require especially high reliability for the prevention of defects which might directly damage a third party's life, body or property, or when one of our products is intended for use in applications other than those specified in this catalog.

- | | |
|-----------------------------|--|
| ① Aircraft equipment | ② Aerospace equipment |
| ③ Undersea equipment | ④ Power plant equipment |
| ⑤ Medical equipment | ⑥ Transportation equipment (vehicles, trains, ships, etc.) |
| ⑦ Traffic signal equipment | ⑧ Disaster prevention / crime prevention equipment |
| ⑨ Data-processing equipment | ⑩ Application of similar complexity and/or reliability requirements to the applications listed above |

3. Product specifications in this catalog are as of January 2007. They are subject to change or our products in it may be discontinued without advance notice. Please check with our sales representatives or product engineers before ordering. If there are any questions, please contact our sales representatives or product engineers.

4. Please read rating and △CAUTION (for storage, operating, rating, soldering, mounting and handling) in this catalog to prevent smoking and/or burning, etc.

5. This catalog has only typical specifications because there is no space for detailed specifications. Therefore, please approve our product specifications or transact the approval sheet for product specifications before ordering.

6. Please note that unless otherwise specified, we shall assume no responsibility whatsoever for any conflict or dispute that may occur in connection with the effect of our and/or a third party's intellectual property rights and other related rights in consideration of your use of our products and/or information described or contained in our catalogs. In this connection, no representation shall be made to the effect that any third parties are authorized to use the rights mentioned above under licenses without our consent.

7. No ozone depleting substances (ODS) under the Montreal Protocol are used in our manufacturing process.



<http://www.murata.com/>

Head Office
1-10-1, Higashi Kotari, Nagaokakyo-shi, Kyoto 617-8555, Japan
Phone: 81-75-951-9111

International Division
3-29-12, Shibuya, Shibuya-ku, Tokyo 150-0002, Japan
Phone: 81-3-5469-6123 Fax: 81-3-5469-6155 E-mail: intl@murata.co.jp