

RoHS  **218 Series, 5 x 20 mm, Time-Lag (Slo-Blo®) Fuse**         



### Description

5x20mm time-Lag glass body cartridge fuse designed to IEC specification.











### Features

- Designed to International (IEC) Standards for use globally
- Meets the IEC 60127-2, Sheet 3 specification for time-Lag fuses
- Available in cartridge and axial lead form
- RoHS compliant and lead-free

### Applications

Used as supplementary protection in appliance or utilization equipment to provide individual protection for components or internal circuits.

### Agency Approvals

Agency	Agency File Number	Ampere Range
	Cartridge Certificates: NBK120802-E10480 A&C Leaded Certificates: NBK120802-E10480 B&D	1A – 5A 6.3A – 15A
	Certificates: 2002010207007596	32mA – 6.3A
	Certificates: SU05001-3005 SU05001-2008 SU05001-2009	32mA – 40mA 50mA – 800mA 1A – 10A
	Recognised File: E10480 Guide: JDYX2	32mA – 16A
	File: 029862 Acc. Class: LR1422-30	32mA – 15A
	License: KM41462	80mA – 6.3A
	File: 9850004, 9843043, 811742, 304650, 416270	32mA – 6.3A
	License: 40013496	32mA – 10A
	License: 40016604	15A*
		32mA – 16A

\* Approval for Cartridge versions only

### Electrical Characteristics

% of Ampere Rating	Ampere Rating	Opening Time
150%	32mA–100mA	60 minutes, Minimum
	125mA-6.3A	60 minutes, Minimum
	8A-15A	30 minutes, Minimum
210%	32mA-100mA	120 sec., Maximum
	125mA-6.3A	120 sec., Maximum
	8A-15A	120 sec., Maximum
275%	32mA-100mA	200 ms., Min.; 10 sec. Max.
	125mA-6.3A	600 ms., Min.; 10 sec. Max.
	8A-15A	600 ms., Min.; 10 sec. Max.
400%	32mA-100mA	40 ms., Min.; 3 sec. Max.
	125mA-6.3A	150 ms., Min.; 3 sec. Max.
	8A-15A	150 ms., Min.; 3 sec. Max.
1000%	32mA-100mA	10 ms., Min.; 300 ms. Max.
	125mA-6.3A	20 ms., Min.; 300 ms. Max.
	8A-15A	20 ms., Min.; 300 ms. Max.

218 Series

### Electrical Characteristics

Amp Code	Amp Rating (A)	Voltage Rating (V)	Interrupting Rating	Nominal Cold Resistance (Ohms)	Nominal Melting I <sup>2</sup> t (A <sup>2</sup> ·sec)	Nominal Voltage Drop at Rated Current (mV)	Nominal Power Dissipation At Rated Current (W)	Agency Approvals									
								UL	CCC	PS	RU	SP	S	CE	DVE	UL	
.032	0.032	250	35A@250Vac	58.4500	0.00297	5000	1.6	x	x		x	x	x	x	x		
.040	0.04	250		35.7000	0.00536	4000	1.6	x	x		x	x	x	x	x		
.050	0.05	250		23.3000	0.00692	3500	1.6	x	x		x	x	x	x	x		
.063	0.063	250		17.6500	0.0117	3000	1.6	x	x		x	x	x	x	x		
.080	0.08	250		12.6000	0.0258	2500	1.6	x	x		x	x	x	x	x	x	
.100	0.1	250		8.9050	0.0482	2000	1.6	x	x		x	x	x	x	x	x	
.125	0.125	250		4.2000	0.1465	1900	1.6	x	x		x	x	x	x	x	x	
.160	0.16	250		2.5500	0.2190	1500	1.6	x	x		x	x	x	x	x	x	
.200	0.2	250		1.6000	0.3410	1300	1.6	x	x		x	x	x	x	x	x	
.250	0.25	250		1.0495	0.5405	1100	1.6	x	x		x	x	x	x	x	x	
.315	0.315	250		0.8475	1.1100	1000	1.6	x	x		x	x	x	x	x	x	
.400	0.4	250		0.5350	1.3250	900	1.6	x	x		x	x	x	x	x	x	
.500	0.5	250		0.3700	2.8250	300	1.6	x	x		x	x	x	x	x	x	
.630	0.63	250		0.2750	4.6750	250	1.6	x	x		x	x	x	x	x	x	
.800	0.8	250		0.0813	3.370	150	1.6	x	x		x	x	x	x	x	x	
001.	1	250		0.0613	6.730	150	1.6	x	x	x	x	x	x	x	x	x	
1.25	1.25	250		0.0446	12.650	150	1.6	x	x	x	x	x	x	x	x	x	
01.6	1.6	250		0.0336	23.350	150	1.6	x	x	x	x	x	x	x	x	x	
002.	2	250		0.0293	14.450	150	1.6	x	x	x	x	x	x	x	x	x	
02.5	2.5	250		0.0219	23.250	120	1.6	x	x	x	x	x	x	x	x	x	
3.15	3.15	250	0.0173	38.150	100	1.6	x	x	x	x	x	x	x	x	x		
004.	4	250	40A @ 250Vac	0.0129	69.10	100	1.6	x	x	x	x	x	x	x	x		
005.	5	250	50A @ 250Vac	0.0104	111.00	100	1.6	x	x	x	x	x	x	x	x		
06.3	6.3	250	63A @ 250Vac	0.0076	198.50	100	1.6	x	x	x	x	x	x	x	x		
008.	8	250	80A @ 250Vac	0.0059	341.50	100	4	x		x	x	x		x	x		
010.	10	250	100A @ 250Vac	0.0045	568.00	100	4	x		x	x	x		x	x		
12.5	12.5	250	63A @ 250Vac	0.0034	889.00	100	4			x	x						
015.	15	250	100A @ 250Vac	0.0028	1405.00	100	4			x	x	x			x*		
016.	16	250	63A @ 250Vac	0.0021	1955.00	100	4				x			x			

\* Approval for cartridge versions only.

### Temperature Derating Curve

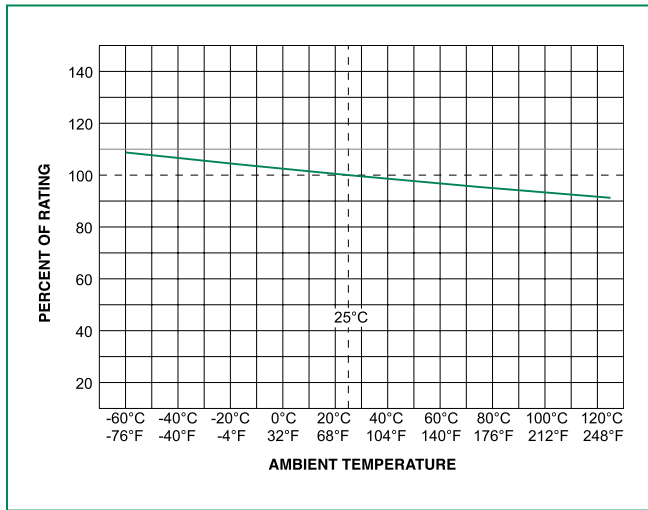

### Average Time Current Curves

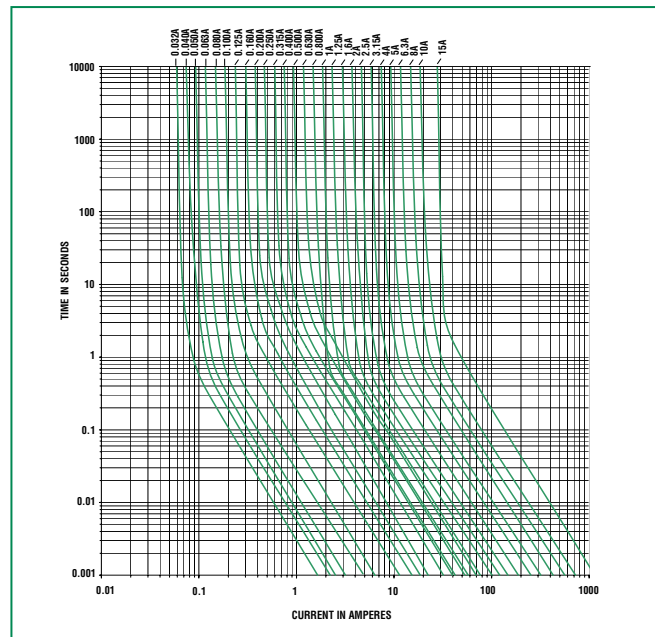

### Soldering Parameters - Wave Soldering

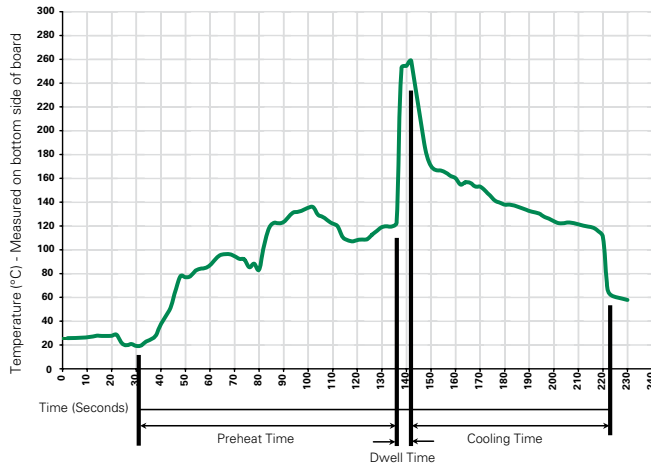

#### Recommended Process Parameters:

Wave Parameter	Lead-Free Recommendation
<b>Preheat:</b> (Depends on Flux Activation Temperature) (Typical Industry Recommendation)	
Temperature Minimum:	100° C
Temperature Maximum:	150° C
Preheat Time:	60-180 seconds
<b>Solder Pot Temperature:</b>	260° C Maximum
<b>Solder Dwell Time:</b>	2-5 seconds

#### Recommended Hand-Solder Parameters:

Solder Iron Temperature: 350° C +/- 5° C  
 Heating Time: 5 seconds max.

**Note: These devices are not recommended for IR or Convection Reflow process.**

### Product Characteristics

<b>Material</b>	Body: Glass Cap: Nickel-plated brass Leads: Tin-plated Copper
<b>Terminal Strength</b>	MIL-STD-202G, Method 211A, Test Condition A
<b>Solderability</b>	Reference IEC 60127 Second Edition 2003-01 Annex A
<b>Product Marking</b>	Cap1: Brand logo, current and voltage ratings Cap2: Agency approval marks
<b>Packaging</b>	Available in Bulk (M=1000 pcs/pkg) or on Tape/Reel (MRET1=1000 pcs/reel)

<b>Operating Temperature</b>	-55°C to +125°C
<b>Thermal Shock</b>	MIL-STD-202G, Method 107G, Test Condition B: (5 cycles -65°C to +125°C)
<b>Vibration</b>	MIL-STD-202G, Method 201A
<b>Humidity</b>	MIL-STD-202G, Method 103B, Test Condition A. high RH (95%) and elevated temperature (40°C) for 240 hours.
<b>Salt Spray</b>	MIL-STD-202G, Method 101D, Test Condition B

### Dimensions

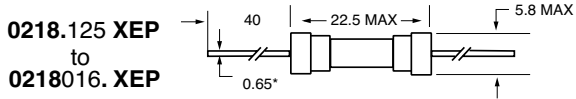
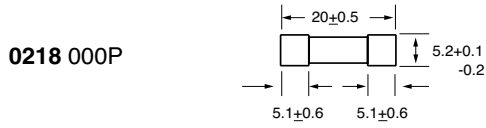

All dimensions in mm

Notes:  
 \* Ratings above 6.3A have 0.8 mm dia lead

### Part Numbering System

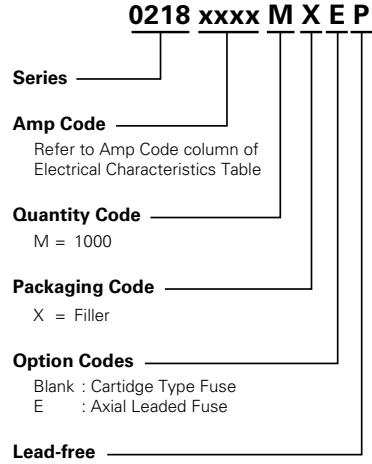

### Packaging

Packaging Option	Packaging Specification	Quantity	Quantity & Packaging Code	Taping Width
Bulk	N/A	1000	MX	N/A
Bulk	N/A	1000	MXE	N/A
Reel and Tape	EIA 296-E	1000	MRET1	T1=52mm (2.062")