

Description

- Fast acting
- Optional axial leads available
- 5mm x 20mm physical size
- Ceramic tube, nickel brass endcap construction
- Designed to IEC 60127-2



ELECTRICAL CHARACTERISTICS									
In	1.5 In		2.1 In		2.75 In		4 In		10 In
	min	max	min	max	min	max	min	max	max
50mA-3.15A	60 min	30 min	10 ms	2 sec	3 ms	300 ms	300 ms	300 ms	20 ms
4A-10A	60 min	30 min	10 ms	3 sec	3 ms	300 ms	300 ms	300 ms	20 ms

Agency Information

- UL Recognized Card: (50mA-10A) Guide JDYX2, File E19180
- CSA Component Acceptance: File 53787
- cURus Recognition: Guide JDYX8, File E19180
- SEMKO Approval 50mA, 160mA-10A
- VDE Approval 160mA-10A
- IMQ Approval 50mA-10A
- CCC Approval 160mA-10A

Ordering

- Specify packaging, product, and option code
- For -R option, drop mA or A from product code (i.e. S501-2-R)

Dimensions

Drawing Not to Scale

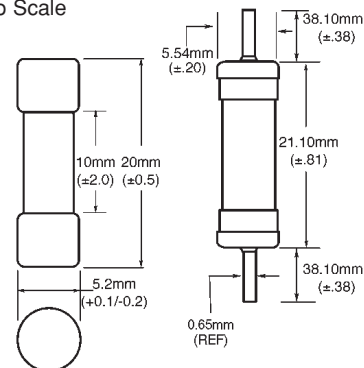

- Ratings above 6.3A have a 0.8mm diameter lead
- With TR2 packaging code, lead wire length is 19.05mm

SPECIFICATIONS				
Product Code	Voltage Rating AC	Interrupting Rating at Rated Voltage AC	Typical Melting I ² t (A ² Sec) AC	Typical Voltage Drop (mV)‡
S501-50mA	250V	1500A	0.0017	9000
S501-63mA	250V	1500A	0.0005	3300
S501-80mA	250V	1500A	0.0011	2600
S501-100mA	250V	1500A	0.0018	2300
S501-125mA	250V	1500A	0.0037	1900
S501-160mA	250V	1500A	0.008	1600
S501-200mA	250V	1500A	0.020	1350
S501-250mA	250V	1500A	0.027	1300
S501-315mA	250V	1500A	0.010	1400
S501-400mA	250V	1500A	0.018	1200
S501-500mA	250V	1500A	0.038	1050
S501-630mA	250V	1500A	0.064	1200
S501-800mA	250V	1500A	0.097	490
S501-1A	250V	1500A	0.480	230
S501-1.25A	250V	1500A	0.9	200
S501-1.6A	250V	1500A	1.9	180
S501-2A	250V	1500A	2.0	205
S501-2.5A	250V	1500A	3.9	190
S501-3.15A	250V	1500A	8.1	160
S501-4A	250V	1500A	14	160
S501-5A	250V	1500A	25	155
S501-6.3A	250V	1500A	48	150
S501-8A	250V	1500A	N/A	N/A
S501-10A	250V	1500A	N/A	N/A

‡ Typical Voltage Drop (Voltage drop was measured at 20°C ambient temperature at rated current)

TIME CURRENT CURVE

Time-Current Characteristic Curves—Average Melt

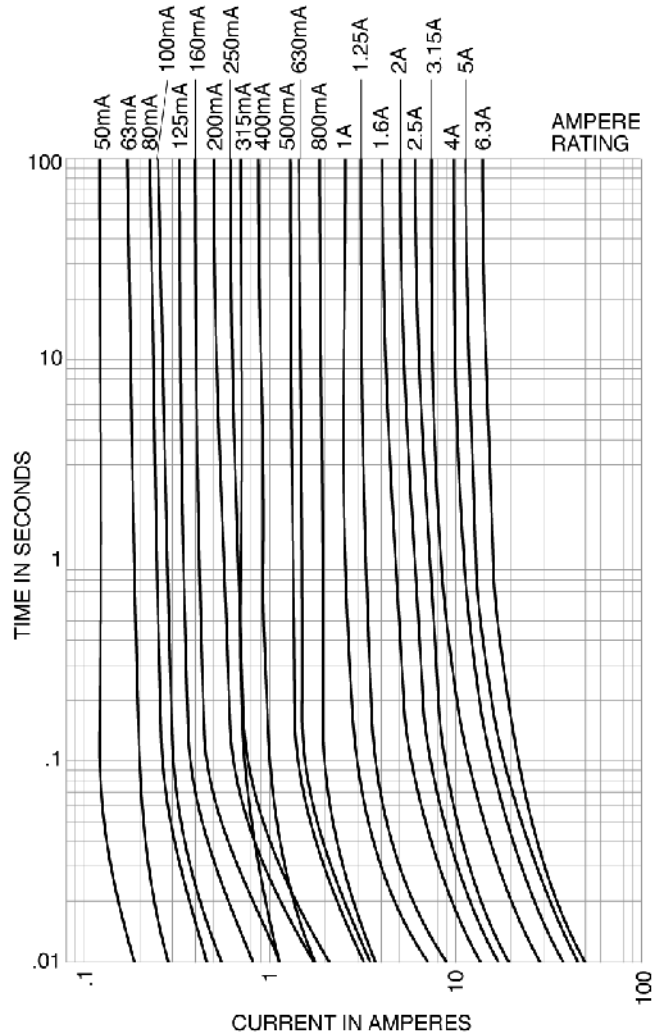

PACKAGING CODE	
Packaging Code	Description
BK	100 pieces of fuses packed into a cardboard carton
BK1	1,000 pieces of fuses packed into a poly bag
TR2	1,500 pieces of fuses packed into tape on a reel (19.05mm lead wire length)

OPTION CODE	
Option Code	Description
V	Axial leads - copper tinned wire with nickel plated brass overcaps
-R	RoHS compliant version