

## Interference Suppression Film Capacitors MKP Radial Potted Type

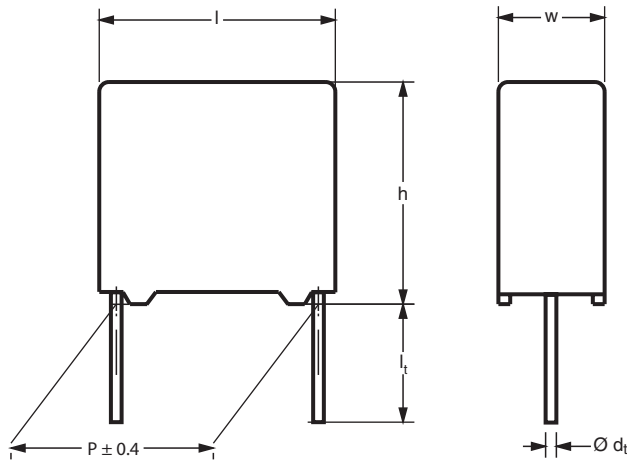

Dimensions in mm

### APPLICATIONS

For standard across the line X2 applications

See also application note:

[www.vishay.com/doc?28153](http://www.vishay.com/doc?28153)

### REFERENCE STANDARDS

"IEC 60384-14 ed 3 and EN 60384-14"

"IEC 60065, pass. flamm. class B"

CSA-C22.2 No 1; UL1414

ENEC; CQC

UL1283; CSA E384-14

### MARKING

C-value; tolerance; rated voltage; sub-class; manufacturer's type designation; code for dielectric material; manufacturer location; manufacturer's logo; year and week; safety approvals

### DIELECTRIC

Polypropylene film

### ELECTRODES

Metallized film

### FEATURES

10 mm to 27.5 mm lead pitch. Supplied loose in box, taped on reel

Compliant to RoHS directive 2002/95/EC

### CONSTRUCTION

Mono construction

### RATED VOLTAGE

AC 310 V; 50 Hz to 60 Hz

### PERMISSIBLE DC VOLTAGE

DC 630 V

### ENCAPSULATION

Plastic case, epoxy resin sealed, flame retardant UL-class 94 V-0

### CLIMATIC TESTING CLASS ACC. TO IEC 60068-1

55/110/56/B

### CAPACITANCE RANGE (E12 SERIES)

E12 series 0.001  $\mu$ F to 2.2  $\mu$ F

Preferred values acc. to E6

### CAPACITANCE TOLERANCE

$\pm 20\%$ ;  $\pm 10\%$ ;  $\pm 5\%$

### LEADS

Tinned wire

### MAXIMUM APPLICATION TEMPERATURE

$C \leq 470$  nF: 110 °C (125 °C for less than 1000 h)

$C > 470$  nF: 110 °C

### DETAIL SPECIFICATION

For more detailed data and test requirements, contact:

[RFI@vishay.com](mailto:RFI@vishay.com)



**RoHS**  
COMPLIANT

## COMPOSITION OF CATALOG NUMBER

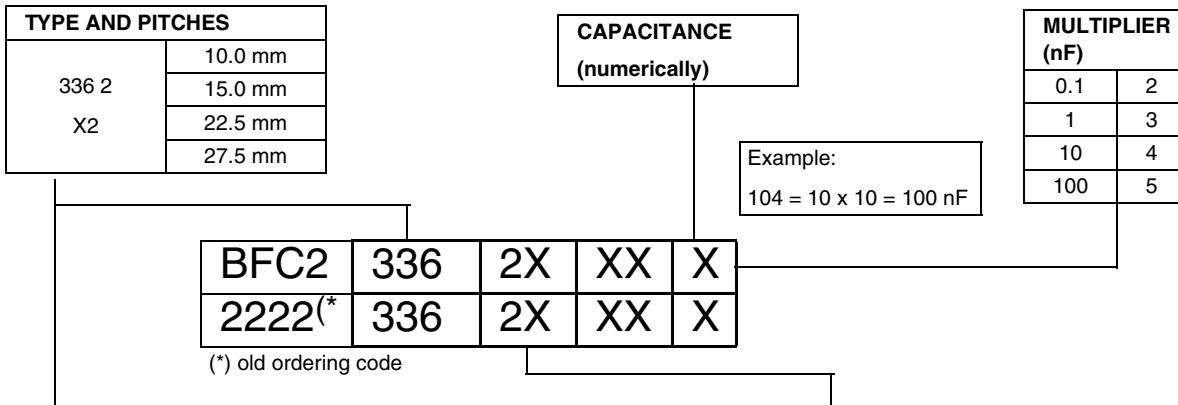

TYPE	PACKAGING	STANDARD DIMENSIONS	C-TOL.	CODE NUMBER	
336 2 X2	Loose in box	Lead length 3.5 + 1/-0.5 mm or 3.5 ± 0.3 mm	± 20 %	BFC2 336 20...	
		Lead length 5.0 ± 1.0 mm		See tables	
		Lead length 25.0 ± 2.0 mm		BFC2 336 26...	
	Taped on reel <sup>(1)</sup>	H = 18.5 mm; P <sub>0</sub> = 12.7 mm			BFC2 336 23...
	Loose in box	Loose in box	Lead length 3.5 + 1/-0.5 mm or 3.5 ± 0.3 mm	± 10 %	BFC2 336 21...
			Lead length 5.0 ± 1.0 mm		See tables
			Lead length 25.0 ± 2.0 mm		BFC2 336 27...
	Taped on reel <sup>(1)</sup>	H = 18.5 mm; P <sub>0</sub> = 12.7 mm			BFC2 336 24...
	Loose in box	Loose in box	Lead length 3.5 + 1/-0.5 mm or 3.5 ± 0.3 mm	± 5 %	BFC2 336 22...
			Lead length 5.0 ± 1.0 mm		See tables
			Lead length 25.0 ± 2.0 mm		BFC2 336 28...
	Taped on reel	H = 18.5 mm; P <sub>0</sub> = 12.7 mm			BFC2 336 25...
		<b>PACKAGING</b>	<b>ALTERNATIVE LARGER PITCH SIZES</b>	<b>C-TOL.</b>	<b>CODE NUMBER</b>
	Loose in box	Loose in box	Lead length 3.5 + 1/-0.5 mm or 3.5 ± 0.3 mm	± 20 %	See tables for details
Lead length 5.0 ± 1.0 mm					
Lead length 25.0 ± 2.0 mm					
Taped on reel <sup>(1)</sup>	H = 18.5 mm; P <sub>0</sub> = 12.7 mm				
Loose in box	Loose in box	Lead length 3.5 + 1/-0.5 mm or 3.5 ± 0.3 mm	± 10 %		
		Lead length 5.0 ± 1.0 mm			
		Lead length 25.0 ± 2.0 mm			
Taped on reel <sup>(1)</sup>	H = 18.5 mm P <sub>0</sub> = 12.7 mm				

### Notes

<sup>(1)</sup> For detailed tape specifications refer to "Packaging Information": [www.vishay.com/doc/?28139](http://www.vishay.com/doc/?28139)



**SPECIFIC REFERENCE DATA**

DESCRIPTION	VALUE	
Rated AC voltage $U_{Rac}$	310 V	
Permissible DC voltage $U_{Rdc}$	630 V	
Tangent of loss angle:	at 1 kHz	at 10 kHz
$C < 470$ nF	$\leq 10 \times 10^{-4}$	$\leq 20 \times 10^{-4}$
$470$ nF $\leq C \leq 1$ $\mu$ F	$\leq 20 \times 10^{-4}$	$\leq 70 \times 10^{-4}$
$C > 1$ $\mu$ F	$\leq 30 \times 10^{-4}$	-
Rated voltage pulse slope $(dU/dt)_R$ at 435 Vdc	-	
Pitch = 10 mm	600 V/ $\mu$ s	
Pitch = 15 mm and 7.5 mm (bent back)	400 V/ $\mu$ s	
Pitch = 22.5 mm	150 V/ $\mu$ s	
Pitch = 27.5 mm	100 V/ $\mu$ s	
R between leads, for $C \leq 0.33$ $\mu$ F at 100 V; 1 min	$> 15\,000$ M $\Omega$	
RC between leads, for $C > 0.33$ $\mu$ F at 100 V; 1 min	$> 5000$ s	
R between leads and case; 100 V; 1 min	$> 30\,000$ M $\Omega$	
Withstanding (DC) voltage (cut off current 10 mA); rise time 100 V/s:		
$C \leq 1$ $\mu$ F	2200 V; 1 min	
$C > 1$ $\mu$ F	1800 V; 1 min	
Withstanding (AC) voltage between leads and case	2120 V; 1 min	
Max. application temperature for $0.001$ $\mu$ F $\leq C \leq 0.47$ $\mu$ F	110 °C (125 °C for less than 1000 h)	
Max. application temperature for $C > 0.47$ $\mu$ F	110 °C	

**Pitch: 10.0 mm; C-tol. =  $\pm 20$  %**

C ( $\mu$ F)	DIMENSIONS w x h x l (mm)	Mass (g) <sup>(3)</sup>	CATALOG NUMBER BFC2 336 ..... AND PACKAGING							
			LOOSE IN BOX					REEL (500 mm) <sup>(1)(2)</sup>		
			SHORT LEADS			LONG LEADS		H = 18.5 mm P <sub>0</sub> = 12.7 mm		
			$l_t = 3.5 + 1/-0.5$ mm	$l_t = 5.0 \pm 1.0$ mm	SPQ	$l_t = 25.0 \pm 2.0$ mm	SPQ		SPQ	
<b>Pitch: 10.0 mm <math>\pm</math> 0.4 mm; <math>d_t = 0.6</math> mm <math>\pm</math> 0.06 mm</b>										
0.001	4.0 x 10.0 x 12.5	0.6	20102	29131	1000	26102	1250	23102	1100	
0.0015			20152	29132		26152		23152		1400
0.0022			20222	29133		26222		23222		
0.0033			20332	29134		26332	1000	23332		
0.0047			20472	29135		26472		23472		
0.0068			20682	29136		26682		23682		
0.01			20103	29137		26103		23103		
0.015			20153	29138		26153		23153		
0.022			20223	29139		26223		23223		
0.033			20333	29141		750		26333		750

**Notes**

- (1) H = in-tape height; P<sub>0</sub> = sprocket hole distance; for detailed specifications refer to "Packaging Information"
- (2) Reel diameter = 356 mm is available on request
- (3) Weight for short lead product only
- SPQ = Standard Packing Quantity



Pitch: 10.0 mm; C-tol. = ± 10 %

C (µF)	DIMENSIONS w x h x l (mm)	MASS (g) <sup>(3)</sup>	CATALOG NUMBER BFC2 336 ..... AND PACKAGING						
			LOOSE IN BOX					REEL (500 mm) <sup>(1)(2)</sup>	
			SHORT LEADS			LONG LEADS		H = 18.5 mm P <sub>0</sub> = 12.7 mm	
			l <sub>t</sub> = 3.5 + 1/-0.5 mm	l <sub>t</sub> = 5.0 ± 1.0 mm	SPQ	l <sub>t</sub> = 25.0 ± 2.0 mm	SPQ		SPQ
Pitch = 10.0 mm ± 0.4 mm, d <sub>t</sub> = 0.6 mm ± 0.06 mm									
0.001	4.0 x 10.0 x 12.5	0.6	21102	29154	1000	27102	1250	24102	1400
0.0012			21122	-		27122		24122	
0.0015			21152	29155		27152		24152	
0.0018			21182	-		27182		24182	
0.0022			21222	29156		27222		24222	
0.0027			21272	-		27272	24272		
0.0033			21332	29157		27332	24332		
0.0039			21392	-		27392	24392		
0.0047			21472	29158		27472	24472		
0.0056			21562	-		27562	24562		
0.0068			21682	29159	27682	24682			
0.0082			21822	-	27822	24822			
0.01			21103	29161	27103	24103			
0.012			21123	-	27123	24123			
0.015			21153	29162	27153	24153			
0.018			21183	-	27183	24183			
0.022			21223	29163	27223	24223			
0.027			21273	-	27273	24273			
0.033			21333	29164	750	27333	750	24333	900

**Notes**

- (1) H = in-tape height; P<sub>0</sub> = sprocket hole distance; for detailed specifications refer to "Packaging Information"
- (2) Reel diameter = 356 mm is available on request
- (3) Weight for short lead product only
- SPQ = Standard Packing Quantity



Interference Suppression Film Capacitors Vishay BCcomponents  
MKP Radial Potted Type

Pitch: 10.0 mm; C-tol. = ± 5 %

C (μF)	DIMENSIONS w x h x l (mm)	MASS (g) <sup>(3)</sup>	CATALOG NUMBER BFC2 336 ..... AND PACKAGING							
			LOOSE IN BOX					REEL (500 mm) <sup>(1)(2)</sup>		
			SHORT LEADS			LONG LEADS		H = 18.5 mm P <sub>0</sub> = 12.7 mm		
			l <sub>t</sub> = 3.5 + 1/-0.5 mm	l <sub>t</sub> = 5.0 ± 1.0 mm	SPQ	l <sub>t</sub> = 25.0 ± 2.0 mm	SPQ		SPQ	
Pitch = 10.0 mm ± 0.4 mm, d <sub>t</sub> = 0.6 mm ± 0.06 mm										
0.001	4.0 x 10.0 x 12.5	0.6	22102	-	1000	28102	1250	25102	1400	
0.0012			22122	-		28122		25122		
0.0015			22152	-		28152		25152		
0.0018			22182	-		28182		25182		
0.0022			22222	-		28222		25222		
0.0027			22272	-		28272	1000	25272	1100	
0.0033			22332	-		28332		25332		
0.0039			22392	-		28392		25392		
0.0047			22472	-		28472		25472		
0.0056			22562	-		28562		25562		
0.0068			22682	-		28682		1000		25682
0.0082			22822	-		28822				25822
0.01			22103	-		28103				25103
0.012			22123	-		28123		25123		
0.015			22153	-		28153		25153		
0.018			22183	-		28183	25183			
0.022			22223	-		28223	25223			
0.027			22273	-		750	28273	750	25273	900
0.033			22333	-			28333		25333	

**Notes**

- (1) H = in-tape height; P<sub>0</sub> = sprocket hole distance; for detailed specifications refer to "Packaging Information"
- (2) Reel diameter = 356 mm is available on request
- (3) Weight for short lead product only
- SPQ = Standard Packing Quantity



Pitch: 15.0 mm; C-tol. = ± 20 %

C ( $\mu$ F)	DIMENSIONS w x h x l (mm)	MASS (g) <sup>(3)</sup>	CATALOG NUMBER BFC2 336 ..... AND PACKAGING							
			LOOSE IN BOX					REEL (500 mm) <sup>(1)(2)</sup>		
			SHORT LEADS			LONG LEADS		H = 18.5 mm P <sub>0</sub> = 12.7 mm		
			$l_t = 3.5 \pm 0.3$ mm	$l_t = 5.0 \pm 1.0$ mm	SPQ	$l_t = 25.0 \pm 2.0$ mm	SPQ		SPQ	
<b>Pitch = 15 ± 0.4 mm; d<sub>t</sub> = 0.60 ± 0.06 mm</b>										
0.01	5.0 x 11.0 x 17.5	0.98	29001	29273	1000	29097	1000	29004	1100	
0.015			29011	29274		29071		29014		
0.022			29021	29275		29076		29024		
0.033			29031	29276		29082		29034		
0.047			20473	29142		26473		23473		
0.068			20683	29143		26683		23683		
0.1			20104	29144		26104		23104	900	
0.15	6.0 x 12.0 x 17.5	1.4	20154	29145		26154	500	23154	650	
<b>Pitch = 15 ± 0.4 mm; d<sub>t</sub> = 0.80 ± 0.08 mm</b>										
0.22	7.0 x 13.5 x 17.5	1.8	20224	29146	500	26224	500	23224	600	

**Notes**

- (1) H = in-tape height; P<sub>0</sub> = sprocket hole distance; for detailed specifications refer to "Packaging Information"
- (2) Reel diameter = 356 mm is available on request
- (3) Weight for short lead product only
- SPQ = Standard Packing Quantity

Pitch: 15.0 mm; C-tol. = ± 10 %

C ( $\mu$ F)	DIMENSIONS w x h x l (mm)	MASS (g) <sup>(3)</sup>	CATALOG NUMBER BFC2 336 ..... AND PACKAGING							
			LOOSE IN BOX					REEL (500 mm) <sup>(1)(2)</sup>		
			SHORT LEADS			LONG LEADS		H = 18.5 mm P <sub>0</sub> = 12.7 mm		
			$l_t = 3.5 \pm 0.3$ mm	$l_t = 5.0 \pm 1.0$ mm	SPQ	$l_t = 25.0 \pm 2.0$ mm	SPQ		SPQ	
<b>Pitch = 15 ± 0.4 mm; d<sub>t</sub> = 0.60 ± 0.06 mm</b>										
0.01	5.0 x 11.0 x 17.5	0.98	29002	29281	1000	29066	1000	29005	1100	
0.012			29007	-		29068		29009		
0.015			29012	29282		29072		29015		
0.018			29017	-		29074		29019		
0.022			29022	29283		29077		29025		
0.027			29027	-		29079		29029		
0.033			29032	29284		29083		29035		
0.039			21393	-		27393		24393		
0.047			21473	29165		27473		24473		
0.056			21563	-		27563		24563		
0.068			21683	29166		27683		24683		900
0.082	21823	-	27823	24823						
0.1	21104	29167	27104	24104	800					
0.12	6.0 x 12.0 x 17.5	1.4	21124	-	500	27124	500	24124	650	
0.15			21154	29168		27154		24154		
<b>Pitch = 15 ± 0.4 mm; d<sub>t</sub> = 0.80 ± 0.08 mm</b>										
0.18	7.0 x 13.5 x 17.5	1.8	21184	-	500	27184	500	24184	600	
0.22			21224	29169		27224		24224		

**Notes**

- (1) H = in-tape height; P<sub>0</sub> = sprocket hole distance; for detailed specifications refer to "Packaging Information"
- (2) Reel diameter = 356 mm is available on request
- (3) Weight for short lead product only
- SPQ = Standard Packing Quantity



Interference Suppression Film Capacitors Vishay BCcomponents  
MKP Radial Potted Type

Pitch: 15.0 mm; C-tol. = ± 5 %

C (µF)	DIMENSIONS w x h x l (mm)	MASS (g) <sup>(3)</sup>	CATALOG NUMBER BFC2 336 ..... AND PACKAGING						
			LOOSE IN BOX					REEL (500 mm) <sup>(1)(2)</sup>	
			SHORT LEADS			LONG LEADS		H = 18.5 mm P <sub>0</sub> = 12.7 mm	
			l <sub>t</sub> = 3.5 ± 0.3 mm	l <sub>t</sub> = 5.0 ± 1.0 mm	SPQ	l <sub>t</sub> = 25.0 ± 2.0 mm	SPQ		SPQ
<b>Pitch = 15 ± 0.4 mm; d<sub>t</sub> = 0.60 ± 0.06 mm</b>									
0.01	5.0 x 11.0 x 17.5	0.98	29003	-		29067		29006	1100
0.012			29008	-		29069		29061	
0.015			29013	-		29073		29016	
0.018			29018	-		29075		29062	
0.022			29023	-		29078		29026	
0.027			29028	-		29081		29063	
0.033			29033	-		29084		29036	
0.039			22393	-	1000	28393		25393	
0.047			22473	-		28473		25473	
0.056			22563	-		28563		25563	
0.068			22683	-		28683		25683	900
0.082			22823	-		28823		25823	
0.1			22104	-		28104		25104	800
0.12	6.0 x 12.0 x 17.5	1.4	22124	-		28124		25124	650
0.15			22154	-		28154		25154	
<b>Pitch = 15 ± 0.4 mm; d<sub>t</sub> = 0.80 ± 0.08 mm</b>									
0.18	7.0 x 13.5 x 17.5	1.8	22184	-	500	28184	500	25184	600

Notes

- (1) H = in-tape height; P<sub>0</sub> = sprocket hole distance; for detailed specifications refer to "Packaging Information"
- (2) Reel diameter = 356 mm is available on request
- (3) Weight for short lead product only
- SPQ = Standard Packing Quantity

Pitch: 22.5 mm; C-tol. = ± 20 %

C (µF)	DIMENSIONS w x h x l (mm)	MASS (g) <sup>(3)</sup>	CATALOG NUMBER BFC2 336 ..... AND PACKAGING						
			LOOSE IN BOX					REEL (500 mm) <sup>(1)(2)</sup>	
			SHORT LEADS			LONG LEADS		H = 18.5 mm P <sub>0</sub> = 12.7 mm	
			l <sub>t</sub> = 3.5 ± 0.3 mm	l <sub>t</sub> = 5.0 ± 1.0 mm	SPQ	l <sub>t</sub> = 25.0 ± 2.0 mm	SPQ		SPQ
<b>Pitch = 22.5 ± 0.4 mm; d<sub>t</sub> = 0.80 ± 0.08 mm</b>									
0.15	6.0 x 15.5 x 26.0	2.4	29041	29277		29087		29044	600
0.22			29051	29278	300	29093	500	29053	550
0.33			20334	29147		26334		23334	450
0.47	7.0 x 16.5 x 26.0	2.9	20474	29148	200	26474	500	23474	400

Notes

- (1) H = in-tape height; P<sub>0</sub> = sprocket hole distance; for detailed specifications refer to "Packaging Information"
- (2) Reel diameter = 356 mm is available on request
- (3) Weight for short lead product only
- SPQ = Standard Packing Quantity



Pitch: 22.5 mm; C-tol. = ± 10 %

C ( $\mu$ F)	DIMENSIONS w x h x l (mm)	MASS (g) <sup>(3)</sup>	CATALOG NUMBER BFC2 336 ..... AND PACKAGING						
			LOOSE IN BOX					REEL (500 mm) <sup>(1)(2)</sup>	
			SHORT LEADS			LONG LEADS		H = 18.5 mm P <sub>0</sub> = 12.7 mm	
			l <sub>t</sub> = 3.5 ± 0.3 mm	l <sub>t</sub> = 5.0 ± 1.0 mm	SPQ	l <sub>t</sub> = 25.0 ± 2.0 mm	SPQ		SPQ
<b>Pitch = 22.5 ± 0.4 mm; d<sub>t</sub> = 0.80 ± 0.08 mm</b>									
0.12	6.0 x 15.5 x 26.0	2.4	29037	-	300	29085	500	29039	600
0.15			29042	29285		29088		29045	
0.18			29047	-		29091		29049	
0.22			29052	29286		29094		29054	
0.27			21274	-		27274		24274	
0.33	21334	29171	27334	24334	450				
0.39	21394	-	27394	24394					
0.47	7.0 x 16.5 x 26.0	2.9	21474	29172	200	27474	24474	400	

**Notes**

- (1) H = in-tape height; P<sub>0</sub> = sprocket hole distance; for detailed specifications refer to "Packaging Information"
- (2) Reel diameter = 356 mm is available on request
- (3) Weight for short lead product only
- SPQ = Standard Packing Quantity

Pitch: 22.5 mm; C-tol. = ± 5 %

C ( $\mu$ F)	DIMENSIONS w x h x l (mm)	MASS (g) <sup>(3)</sup>	CATALOG NUMBER BFC2 336 ..... AND PACKAGING						
			LOOSE IN BOX					REEL (500 mm) <sup>(1)(2)</sup>	
			SHORT LEADS			LONG LEADS		H = 18.5 mm P <sub>0</sub> = 12.7 mm	
			l <sub>t</sub> = 3.5 ± 0.3 mm	l <sub>t</sub> = 5.0 ± 1.0 mm	SPQ	l <sub>t</sub> = 25.0 ± 2.0 mm	SPQ		SPQ
<b>Pitch = 22.5 ± 0.4 mm; d<sub>t</sub> = 0.80 ± 0.08 mm</b>									
0.12	6.0 x 15.5 x 26.0	2.4	29038	-	300	29086	500	29064	600
0.15			29043	-		29089		29046	
0.18			29048	-		29092		29065	
0.22			22224	-		28224		25224	
0.27			22274	-		28274		25274	
0.33	7.0 x 16.5 x 26.0	2.9	22334	-	200	28334		25334	450
0.39			22394	-		28394		25394	

**Notes**

- (1) H = in-tape height; P<sub>0</sub> = sprocket hole distance; for detailed specifications refer to "Packaging Information"
- (2) Reel diameter = 356 mm is available on request
- (3) Weight for short lead product only
- SPQ = Standard Packing Quantity





Interference Suppression Film Capacitors Vishay BCcomponents  
MKP Radial Potted Type

Pitch: 27.5 mm; C-tol. = ± 20 %

C (µF)	DIMENSIONS w x h x l (mm)	MASS (g) <sup>(1)</sup>	CATALOG NUMBER BFC2 336 ..... AND PACKAGING				
			LOOSE IN BOX				
			SHORT LEADS			LONG LEADS	
			l <sub>t</sub> = 3.5 ± 0.3 mm	l <sub>t</sub> = 5.0 ± 1.0 mm	SPQ	l <sub>t</sub> = 25.0 ± 2.0 mm	SPQ
<b>Pitch = 27.5 ± 0.4 mm; d<sub>t</sub> = 0.80 ± 0.08 mm</b>							
0.47	9.0 x 19.0 x 31.5	5.5	29055	29279	100	29095	150
0.68			20684	29149	100	26684	125
1.0	11.0 x 21.0 x 31.0	7.4	20105	29151	100	26105	125
1.5	13.0 x 23.0 x 31.0	9.2	20155	29152	100	26155	125
2.2	15.0 x 25.0 x 31.5	12.3	20225	29153	100	26225	75

Notes

- <sup>(1)</sup> Weight for short lead product only
- SPQ = Standard Packing Quantity

Pitch: 27.5 mm; C-tol. = ± 10 %

C (µF)	DIMENSIONS w x h x l (mm)	MASS (g) <sup>(1)</sup>	CATALOG NUMBER BFC2 336 ..... AND PACKAGING				
			LOOSE IN BOX				
			SHORT LEADS			LONG LEADS	
			l <sub>t</sub> = 3.5 ± 0.3 mm	l <sub>t</sub> = 5.0 ± 1.0 mm	SPQ	l <sub>t</sub> = 25.0 ± 2.0 mm	SPQ
<b>Pitch = 27.5 ± 0.4 mm; d<sub>t</sub> = 0.80 ± 0.08 mm</b>							
0.47	9.0 x 19.0 x 31.5	5.5	29056	29287	100	29096	150
0.56			21564	-		27564	
0.68			21684	29173		27684	
0.82	11.0 x 21.0 x 31.0	7.4	21824	-	100	27824	125
1.0			21105	29174		27105	
1.2	13.0 x 23.0 x 31.0	9.2	21125	-	100	27125	125
1.5			21155	29175		27155	
1.8	15.0 x 25.0 x 31.5	12.3	21185	-	100	27185	75
2.2			21225	29176		27225	

Notes

- <sup>(1)</sup> Weight for short lead product only
- SPQ = Standard Packing Quantity





Pitch: 27.5 mm; C-tol. = ± 5 %

C (µF)	DIMENSIONS w x h x l (mm)	MASS (g) <sup>(1)</sup>	CATALOG NUMBER BFC2 336 ..... AND PACKAGING				
			LOOSE IN BOX				
			SHORT LEADS			LONG LEADS	
			l <sub>t</sub> = 3.5 ± 0.3 mm	l <sub>t</sub> = 5.0 ± 1.0 mm	SPQ	l <sub>t</sub> = 25.0 ± 2.0 mm	SPQ
<b>Pitch = 27.5 ± 0.4 mm; d<sub>t</sub> = 0.80 ± 0.08 mm</b>							
0.47	9.0 x 19.0 x 31.5	5.5	22474	-	100	28474	125
0.56			22564	-		28564	
0.68			22684	-		28684	
0.82	11.0 x 21.0 x 31.0	7.4	22824	-	100	28824	125
1.0			22105	-		28105	
1.2	13.0 x 23.0 x 31.0	9.2	22125	-	100	28125	125
1.5			22155	-		28155	
1.8	15.0 x 25.0 x 31.5	12.3	22185	-	100	28185	75
2.2			22225	-		28225	

Notes

- <sup>(1)</sup> Weight for short lead product only
- SPQ = Standard Packing Quantity

## APPROVALS

SAFETY APPROVALS X2	VOLTAGE	VALUE	FILE NUMBERS
EN 60384-14 ed 3 (ENEC) (= IEC 60384-14 ed 3)	310 Vac	1 nF to 2.2 μF	FI 2008038
UL1414 and CSA-C22.2 No. 1	250 Vac	1 nF to 1 μF	E112471
UL1283	305 Vac	1 nF to 2.2 μF	E109565
CSA-E 384-14	310 Vac	1 nF to 2.2 μF	2123580
CQC	310 Vac	1 nF to 2.2 μF	CQC07001021280 (L)
			CQC04001009254 (S)
			CQC04001009262 (F)
CB Test Certificate	310 Vac	1 nF to 2.2 μF	FI 5123
The Enec-approval together with the CB-Certificate replace all national marks of the following countries (they have already signed the ENEC-Agreement): Austria; Belgium; Czech. Republic; Denmark; Finland; France; Germany; Greece; Hungary; Ireland; Italy; Luxembourg; Netherlands; Norway; Portugal; Slovenian; Spain; Sweden; Switzerland and United Kingdom.			
   			

## MOUNTING

### Normal Use

The capacitors are designed for mounting on printed -circuit boards. The capacitors packed in bandoliers are designed for mounting in pined-circuit boards by means of automatic insertion machines. For detailed tape specifications refer to "Packaging information": [www.vishay.com/doc?28139](http://www.vishay.com/doc?28139)

### Specific Method of Mounting to Withstand Vibration and Shock

In order to withstand vibration and shock tests, it must be insured that the stand-off pips are in good contact with the printed circuit board:

- For pitches  $\leq 15$  mm capacitors shall be mechanically fixed by the leads
- For larger pitches the capacitors shall be mounted in the same way and the body clamped.

### Space Requirements on Printed Circuit Board

The maximum length and width of film capacitors is shown in the figure:

- Eccentricity as in drawing. The maximum eccentricity is smaller than or equal to lead diameter of the product concerned
- Product height with seating plane as given by "IEC 60717" as reference height:  $h_{max.} \leq h + 0.3$  mm or  $h_{max.} \leq h' + 0.3$  mm

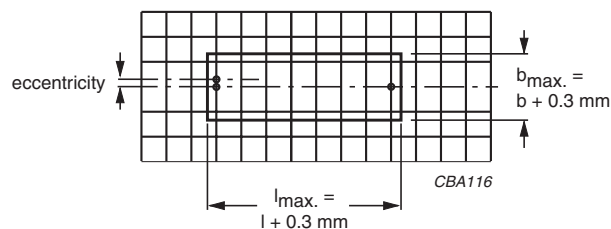

### Storage Temperature

- Storage temperature:  $T_{stg} = -25$  °C to  $+40$  °C with RH maximum 80 % without condensation

### Ratings and Characteristics Reference Conditions

Unless otherwise specified, all electrical values apply to an ambient temperature of  $23 \pm 1$  °C, an atmospheric pressure of 86 kPa to 106 kPa and a relative humidity of  $50 \pm 2$  %.

For reference testing, a conditioning period shall be applied over  $96 \pm 4$  hours by heating the products in a circulating air oven at the rated temperature and a relative humidity not exceeding 20 %.

**CHARACTERISTICS**

Capacitance as a function of ambient temperature (typical curve)

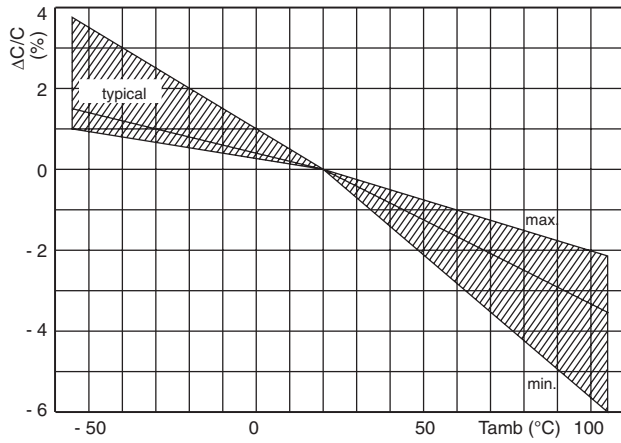

Impedance as a function of frequency (typical curve)

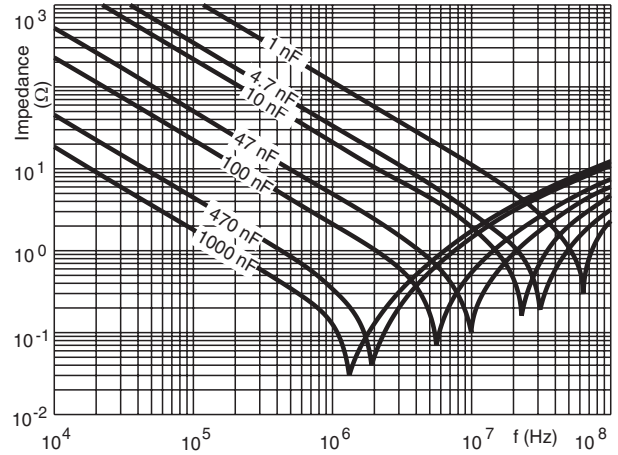

Tangent of loss angle as a function of frequency (typical curve)

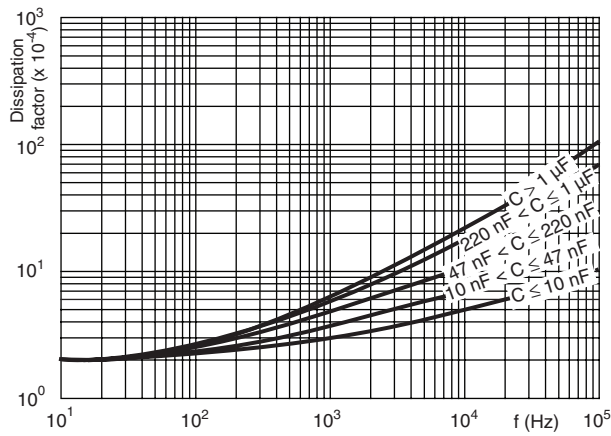

Resonant frequency as a function of capacitance (typical curve)

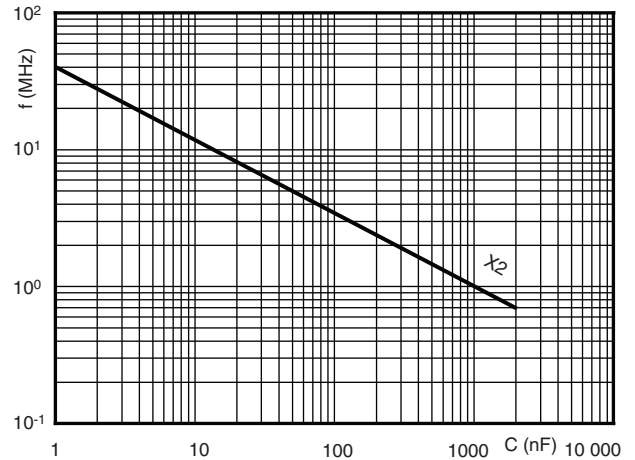

Max. RMS voltage as a function of frequency (typical curve)

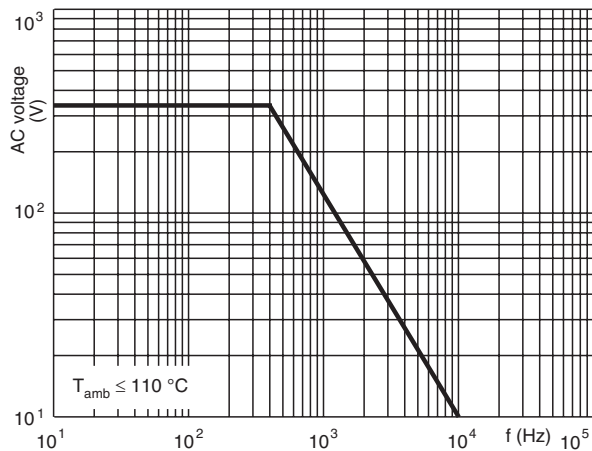

Max. RMS current as a function of frequency (typical curve)

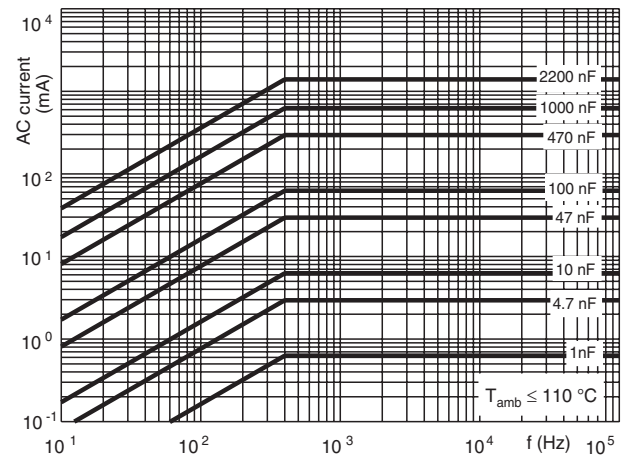

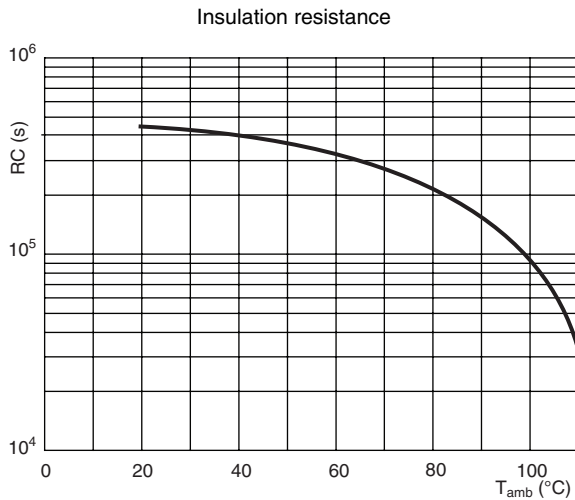

## APPLICATION NOTES

- For X2 electromagnetic interference suppression in **standard across the line applications** (50/60 Hz) with a maximum mains voltage of 310 Vac
- For series impedance applications we refer to the application note [www.vishay.com/doc?28153](http://www.vishay.com/doc?28153)
- These capacitors are not intended for continuous pulse applications. For these situations, capacitors of the AC and pulse programs must be used.
- The maximum ambient temperature must not exceed 110 °C (125 °C for less than 1000 h) for C ≤ 470 nF and 110 °C for C > 470 nF
- Rated voltage pulse slope:  
If the pulse voltage is lower than the rated voltage, the values of the specific reference data can be multiplied by 435 Vdc and divided by the applied voltage

## INSPECTION REQUIREMENTS

### GENERAL NOTES

Sub-clause numbers of tests and performance requirements refer to the “Sectional Specification, IEC publication IEC 60384-14 ed 3 and Specific Reference Data”.

### Group C inspection requirements

SUB-CLAUSE NUMBER AND TEST	CONDITIONS	PERFORMANCE REQUIREMENTS
<b>SUB-GROUP C1A PART OF SAMPLE OF SUB-GROUP C1</b>		
4.1 Dimensions (detail)		As specified in chapters “General Data” of this specification
Initial measurements	Capacitance Tangent of loss angle: For C ≤ 1 μF at 10 kHz For C > 1 μF at 1 kHz	
4.3 Robustness of terminations	Tensile: Load 10 N; 10 s Bending: Load 5 N; 4 x 90°	No visible damage



Interference Suppression Film Capacitors Vishay BCcomponents  
MKP Radial Potted Type

SUB-CLAUSE NUMBER AND TEST	CONDITIONS	PERFORMANCE REQUIREMENTS
4.4 Resistance to soldering heat  4.19 Component solvent resistance  4.4.2 Final measurements	No pre-drying Method: 1A Solder bath: 280 °C ± 5 °C Duration: 10 s  Isopropylalcohol at room temperature Method: 2 Immersion time: 5 ± 0.5 min Recovery time: Min. 1 h, max. 2 h  Visual examination  Capacitance Tangent of loss angle  Insulation resistance	No visible damage Legible marking $ \Delta C/C  \leq 5\%$ of the value measured initially. Increase of tan $\delta$ : $\leq 0.008$ for: $C \leq 1 \mu\text{F}$ or $\leq 0.005$ for: $C > 1 \mu\text{F}$ Compared to values measured initially As specified in section "Insulation Resistance" of this specification
SUB-GROUP C1B PART OF SAMPLE OF SUB-GROUP C1	CONDITIONS	PERFORMANCE REQUIREMENTS
Initial measurements  4.20 Solvent resistance of the marking: see Section "General notes"; item 5.  4.6 Rapid change of temperature  4.6.1 Inspection 4.7 Vibration  4.7.2 Final inspection 4.9 Shock	Capacitance Tangent of loss angle: For $C \leq 1 \mu\text{F}$ at 10 kHz For $C > 1 \mu\text{F}$ at 1 kHz  Isopropylalcohol at room temperature Method: 1 Rubbing material: cotton wool Immersion time: 5 ± 0.5 min  $\theta_A = -55\text{ °C}$ $\theta_B = +110\text{ °C}$ 5 cycles Duration $t = 30$ min  Visual examination  Mounting: See section "Mounting" of this specification Procedure B4 Frequency range: 10 to 55 Hz Amplitude: 0.75 mm or Acceleration 98 m/s <sup>2</sup> (whichever is less severe) Total duration 6 h  Visual examination  Mounting: See section "Mounting" for more information Pulse shape: half sine Acceleration: 490 m/s <sup>2</sup> Duration of pulse: 11 ms	No visible damage Legible marking   No visible damage   No visible damage

SUB-CLAUSE NUMBER AND TEST	CONDITIONS	PERFORMANCE REQUIREMENTS
4.9.2 Final measurements	Visual examination  Capacitance  Tangent of loss angle  Insulation resistance	No visible damage  $ \Delta C/C  \leq 5\%$ of the value measured initially.  Increase of $\tan \delta$ : $\leq 0.008$ for: $C \leq 1 \mu\text{F}$ or $\leq 0.005$ for: $C > 1 \mu\text{F}$  Compared to values measured initially As specified in section "Insulation Resistance" of this specification
<b>SUB-GROUP C1 COMBINED SAMPLE OF SPECIMENS OF SUB-GROUPS C1A AND C1B</b>		
4.11 Climatic sequence  4.11.1 Initial measurements  4.11.2 Dry heat  4.11.3 Damp heat cyclic Test Db First cycle  4.11.4 Cold  4.11.5 Damp heat cyclic Test Db remaining cycles  4.11.6 Final measurements	Capacitance Measured in 4.4.2 and 4.9.2  Tangent of loss angle: Measured initially in C1A and C1B  Temperature: 110 °C  Duration: 16 h  Temperature: - 55 °C  Duration: 2 h  Visual examination  Capacitance  Tangent of loss angle  Voltage proof 1350 Vdc; 1 min between terminations  Insulation resistance	No visible damage Legible marking  $ \Delta C/C  \leq 5\%$ of the value measured in 4.11.1.  Increase of $\tan \delta$ : $\leq 0.008$ for: $C \leq 1 \mu\text{F}$ or $\leq 0.005$ for: $C > 1 \mu\text{F}$  Compared to values measured in 4.11.1.  No permanent breakdown or flash-over  $\geq 50\%$ of values specified in section "Insulation Resistance" of this specification



Interference Suppression Film Capacitors Vishay BCcomponents  
MKP Radial Potted Type

SUB-CLAUSE NUMBER AND TEST	CONDITIONS	PERFORMANCE REQUIREMENTS
<b>SUB GROUP C2</b>		
4.12 Damp heat steady state  4.12.1 Initial measurements  4.12.3 Final measurements	56 days, 40 °C, 90 to 95 % RH No load  Capacitance Tangent of loss angle at 1 kHz  Visual examination  Capacitance  Tangent of loss angle  Voltage proof 1350 Vdc; 1 min between terminations  Insulation resistance	No visible damage Legible marking $ \Delta C/C  \leq 5\%$ of the value measured in 4.12.1.  Increase of $\tan \delta$ : $\leq 0.008$ for: $C \leq 1 \mu\text{F}$ or $\leq 0.005$ for: $C > 1 \mu\text{F}$  Compared to values measured in 4.12.1. No permanent breakdown or flash-over  $\geq 50\%$ of values specified in section "Insulation Resistance" of this specification
<b>SUB-GROUP C3</b>		
4.13.1 Initial measurements  4.13 Impulse voltage  4.14 Endurance  4.14.7 Final measurements	Capacitance Tangent of loss angle: For $C \leq 1 \mu\text{F}$ at 10 kHz For $C > 1 \mu\text{F}$ at 1 kHz  3 successive impulses, full wave, peak voltage: 2.5 kV for $C \leq 1 \mu\text{F}$ 2.5 kV/ $\sqrt{C}$ for $C > 1 \mu\text{F}$ Max. 24 pulses  Duration: 1000 h 1.25 x $U_{\text{Rac}}$ at 110 °C Once in every hour the voltage is increased to 1000 $V_{\text{rms}}$ for 0.1 s via resistor of $47 \Omega \pm 5\%$  Visual examination  Capacitance  Tangent of loss angle  Voltage proof 1350 Vdc; 1 min between terminations 2120 Vac; 1 min between terminations and case  Insulation resistance	No selfhealing breakdowns or flashover  No visible damage Legible marking  $ \Delta C/C  \leq 10\%$ compared to values measured in 4.13.1.  Increase of $\tan \delta$ : $\leq 0.008$ for: $C \leq 1 \mu\text{F}$ or $\leq 0.005$ for: $C > 1 \mu\text{F}$  Compared to values measured in 4.13.1.  No permanent breakdown or flash-over  $\geq 50\%$ of values specified in section "Insulation Resistance" of this specification

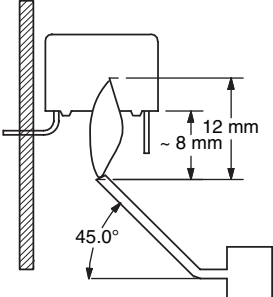
SUB-CLAUSE NUMBER AND TEST	CONDITIONS	PERFORMANCE REQUIREMENTS
<b>SUB-GROUP C4</b>		
<p>4.15 Charge and discharge</p> <p>4.15.1 Initial measurements</p> <p>4.15.3 Final measurements</p>	<p>10 000 cycles Charged to 435 Vdc Discharge resistance:</p> $R = \frac{435 \text{ Vdc}}{1.25 \times C (dU/dt)}$ <p>Capacitance Tangent of loss angle: For <math>C \leq 1 \mu\text{F}</math> at 10 kHz For <math>C &gt; 1 \mu\text{F}</math> at 1 kHz</p> <p>Capacitance</p> <p>Tangent of loss angle</p> <p>Insulation resistance</p>	<p><math> \Delta C/C  \leq 10\%</math> compared to values measured in 4.15.1.</p> <p>Increase of <math>\tan \delta</math>: <math>\leq 0.008</math> for: <math>C \leq 1 \mu\text{F}</math> or <math>\leq 0.005</math> for: <math>C &gt; 1 \mu\text{F}</math></p> <p>Compared to values measured in 4.15.1.</p> <p><math>\geq 50\%</math> of values specified in section "Insulation Resistance" of this specification</p>
<b>SUB-GROUP C5</b>		
<p>4.16 Radio frequency characteristic</p>	<p>Resonance frequency</p>	<p><math>\geq 0.9</math> times the value as specified in section "Resonant Frequency" of this specification</p>
<b>SUB-GROUP C6</b>		
<p>4.17 Passive flammability Class B</p>	<p>Bore of gas jet: <math>\varnothing 0.5 \text{ mm}</math> Fuel: Butane Test duration for actual volume <math>V</math> in <math>\text{mm}^3</math>: <math>V \leq 250</math>: 10 s <math>250 &lt; V \leq 500</math>: 20 s <math>500 &lt; V \leq 1750</math>: 30 s <math>V &gt; 1750</math>: 60 s One flame application</p> 	<p>After removing test flame from capacitor, the capacitor must not continue to burn for more than 10 s. No burning particle must drop from the sample.</p>
<b>SUB-GROUP C7</b>		
<p>4.18 Active flammability</p>	<p>20 cycles of 2.5 kV discharges on the test capacitor connected to <math>U_{\text{Rac}}</math></p>	<p>The cheese cloth around the capacitors shall not burn with a flame. No electrical measurements are required.</p>





## Disclaimer

All product specifications and data are subject to change without notice.

Vishay Intertechnology, Inc., its affiliates, agents, and employees, and all persons acting on its or their behalf (collectively, "Vishay"), disclaim any and all liability for any errors, inaccuracies or incompleteness contained herein or in any other disclosure relating to any product.

Vishay disclaims any and all liability arising out of the use or application of any product described herein or of any information provided herein to the maximum extent permitted by law. The product specifications do not expand or otherwise modify Vishay's terms and conditions of purchase, including but not limited to the warranty expressed therein, which apply to these products.

No license, express or implied, by estoppel or otherwise, to any intellectual property rights is granted by this document or by any conduct of Vishay.

The products shown herein are not designed for use in medical, life-saving, or life-sustaining applications unless otherwise expressly indicated. Customers using or selling Vishay products not expressly indicated for use in such applications do so entirely at their own risk and agree to fully indemnify Vishay for any damages arising or resulting from such use or sale. Please contact authorized Vishay personnel to obtain written terms and conditions regarding products designed for such applications.

Product names and markings noted herein may be trademarks of their respective owners.