

Metallized Polyester Film Capacitors

MKT Radial Epoxy Lacquered Type

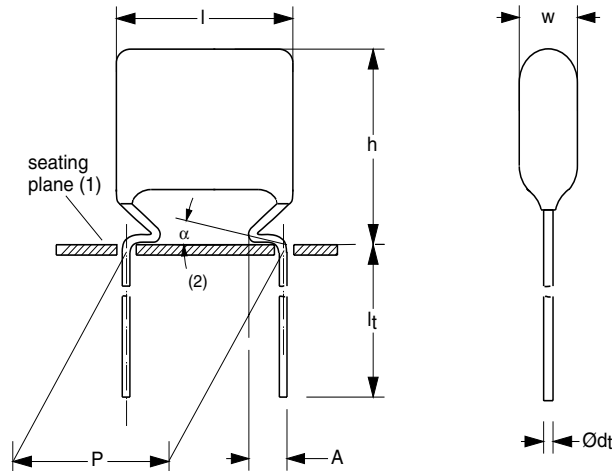

Dimensions in mm

- (1) Hole \varnothing 1.0 for $d_t = 0.6$ mm
Hole \varnothing 1.3 for $d_t = 0.8$ mm
- (2) $0 \leq \alpha < 50^\circ$
- (3) $A = 2.0 + 1.0/-0.5$ mm (pitch = 10.0 mm)
 $A = 2.5 + 1.4/-0.5$ mm (pitch = 15.0 mm, 22.5 mm and 27.5 mm)

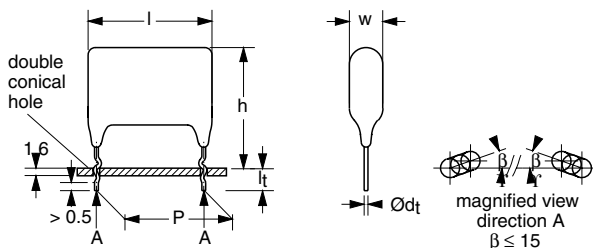

Dimensions in mm

APPLICATIONS

Blocking and coupling. Bypass and energy reservoir

MARKING

C-value; tolerance; rated voltage

DIELECTRIC

Polyester film

ELECTRODES

Vacuum deposited aluminium

FEATURES

- Available taped on reel and loose in box
- Lead (Pb)-free product
- RoHS-compliant product



RoHS
COMPLIANT

COATING

Flame retardant epoxy material (UL-class 94 V-0)

CONSTRUCTION

Wound mono construction

LEADS

Tinned wire

CAPACITANCE RANGE (E12 SERIES)

0.001 to 1.0 μ F

CAPACITANCE TOLERANCE

$\pm 10\%$; $\pm 5\%$

RATED (DC) VOLTAGE

63 V; 100 V; 250 V; 400 V; 630 V

RATED (AC) VOLTAGE

40 V; 63 V; 160 V; 220 V; 250 V

CLIMATIC CATEGORY

55/105/56

RATED TEMPERATURE

85 °C

MAXIMUM APPLICATION TEMPERATURE

105 °C

REFERENCE SPECIFICATIONS

IEC 60384-2

PERFORMANCE GRADE

Grade 1 (long life)

DETAIL SPECIFICATION

For more detailed data and test requirements see "Type detail specification HQN-384-02/101"



COMPOSITION OF CATALOG NUMBER

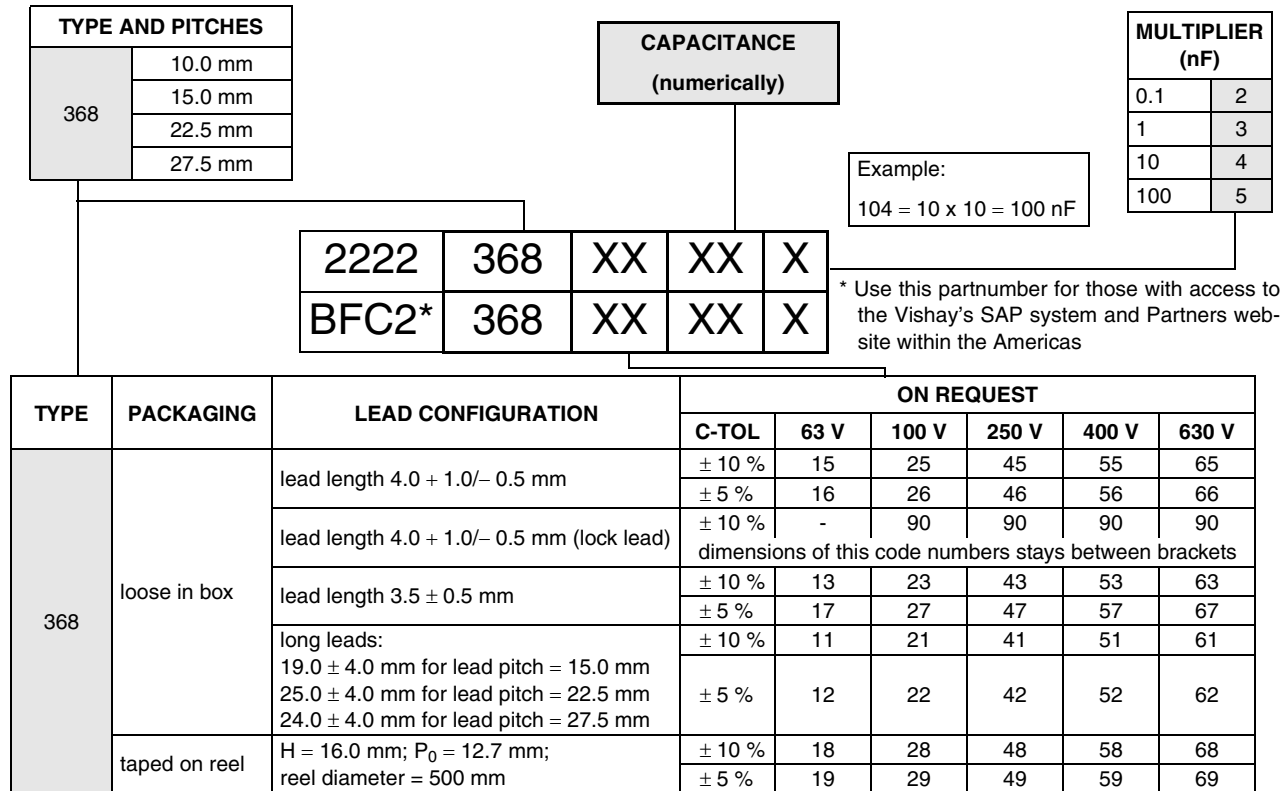

SPECIFIC REFERENCE DATA

DESCRIPTION	VALUE				
	at 1 kHz		at 10 kHz	at 100 kHz	
Tangent of loss angle:					
C ≤ 0.1 μF	≤ 75 × 10 ⁻⁴		≤ 130 × 10 ⁻⁴	≤ 225 × 10 ⁻⁴	
0.1 μF < C ≤ 0.47 μF	≤ 75 × 10 ⁻⁴		≤ 130 × 10 ⁻⁴	≤ 300 × 10 ⁻⁴	
0.47 μF < C ≤ 1.0 μF	≤ 75 × 10 ⁻⁴		≤ 130 × 10 ⁻⁴	-	
Rated voltage pulse slope (dU/dt) _R	at 63 V (DC)	at 100 V (DC)	at 250 V (DC)	at 400 V (DC)	at 630 V (DC)
P = 10 mm	30 V/μs	30 V/μs	70 V/μs	110 V/μs	70 V/μs
P = 15 mm		20 V/μs	28 V/μs	44 V/μs	70 V/μs
P = 22.5 mm		8 V/μs	12 V/μs	20 V/μs	28 V/μs
P = 27.5 mm		7 V/μs	10 V/μs	16 V/μs	24 V/μs
R between leads, for C ≤ 0.33 μF:					
at 10 V; 1 minute	> 15000 MΩ				
at 100 V; 1 minute		> 15000 MΩ	> 30000 MΩ	> 30000 MΩ	
at 500 V; 1 minute					> 30000 MΩ
RC between leads, for C > 0.33 μF:					
at 10 V; 1 minute	> 5000 s				
at 100 V; 1 minute		> 5000 s	> 10000 s	> 10000 s	
at 500 V; 1 minute					> 10000 s
R between interconnecting leads and casing;					
at 10 V; 1 minute	> 30000 MΩ				
at 100 V; 1 minute		> 30000 MΩ	> 30000 MΩ	> 30000 MΩ	
at 500 V; 1 minute					> 30000 MΩ
Withstanding (DC) voltage (cut off current 10 mA); rise time 100 V/s	100 V; 1 minute	160 V; 1 minute	400 V; 1 minute	640 V; 1 minute	1008 V; 1 minute
Withstanding (DC) voltage between leads and case	200 V; 1 minute	200 V; 1 minute	500 V; 1 minute	800 V; 1 minute	1260 V; 1 minute



Metallized Polyester Film Capacitors Vishay BCcomponents
MKT Radial Epoxy Lacquered Type

U_{Rdc} = 63 V; U_{Rac} = 40 V

C (μ F)	DIMENSIONS $w_{max} \times h_{max} \times l_{max}$ (mm)	MASS (g)	CATALOG NUMBER 2222 368 AND PACKAGING					
			LOOSE IN BOX			REEL	LOOSE IN BOX	
			$l_t =$ 4.0 + 1.0/- 0.5 mm	short leads	long leads	SPQ	$l_t =$ 4.0 + 1.0/- 0.5 mm	SPQ
			C-tol = \pm 10 %				C-tol = \pm 10 %	
last 5 digits of catalog number	SPQ	SPQ	SPQ	last 5 digits of catalog number	SPQ			
Pitch = 10.0 \pm 0.4 mm; $d_t = 0.60 \pm 0.06$ mm							lock lead	
0.22	4.2 \times 13.2 (15.5) \times 12.5	0.5	15224	2000	1000	1300	90316	1100
0.27	4.0 \times 12.8 (15.5) \times 12.5	0.5	15274	2000	1000	1300	90317	1100
0.33	4.3 \times 13.1 (15.5) \times 12.5	0.5	15334	2000	1000	1300	90318	1100
0.39	4.2 \times 12.9 (15.5) \times 12.5	0.5	15394	2000	1000	1300	90319	1100
0.47	4.3 \times 13.4 (16.0) \times 12.5	0.5	15474	2000	1000	1200	90321	1000
0.56	4.7 \times 13.7 (16.0) \times 12.5	0.5	15564	2000	1000	1200	90322	1000
0.68	5.1 \times 14.1 (16.5) \times 12.5	0.6	15684	2000	1000	1100	90323	1500
0.82	5.5 \times 14.5 (17.0) \times 12.5	0.6	15824	2000	1000	1000	90324	1250
1	6.0 \times 15.0 (17.5) \times 12.5	0.8	15105	2000	1000	900	90325	1250

U_{Rdc} = 100 V; U_{Rac} = 63 V

C (μ F)	DIMENSIONS $w_{max} \times h_{max} \times l_{max}$ (mm)	MASS (g)	CATALOG NUMBER 2222 368 AND PACKAGING					
			LOOSE IN BOX			REEL	LOOSE IN BOX	
			$l_t =$ 4.0 + 1.0/- 0.5 mm	short leads	long leads	SPQ	$l_t =$ 4.0 + 1.0/- 0.5 mm	SPQ
			C-tol = \pm 10 %				C-tol = \pm 10 %	
last 5 digits of catalog number	SPQ	SPQ	SPQ	last 5 digits of catalog number	SPQ			
Pitch = 10.0 \pm 0.4 mm; $d_t = 0.60 \pm 0.06$ mm							lock lead	
0.056	4.0 \times 13.0 (15.0) \times 12.5	0.4	25563	2000	1000	1500	90205	1250
0.068			25683				90206	
0.082	3.7 \times 12.7 (15.0) \times 12.5	0.4	25823	2000	1000	1500	90207	1250
0.1	4.0 \times 13.0 (15.0) \times 12.5	0.4	25104	2000	1000	1500	90208	1250
0.12	4.3 \times 13.3 (15.0) \times 12.5	0.4	25124	2000	1000	1500	90209	1250
0.15	3.9 \times 12.9 (15.0) \times 12.5	0.4	25154	2000	1000	1500	90211	1250
0.18	4.2 \times 13.2 (15.5) \times 12.5	0.5	25184	2000	1000	1300	90212	1100
0.22	4.5 \times 13.6 (16.0) \times 12.5	0.5	25224	2000	1000	1200	90213	1000
Pitch = 15.0 \pm 0.4 mm; $d_t = 0.80 \pm 0.08$ mm							lock lead	
0.27	5.0 \times 14.0 (17.0) \times 17.5	0.6	25274	2000	1000	1200	90214	1750
0.33			25334				90215	
0.39			25394				90216	
0.47	5.5 \times 14.5 (17.5) \times 17.5	0.7	25474	2000	1000	1100	90217	1500
0.56			25564				90218	
0.68	6.0 \times 15.0 (18.0) \times 17.5	0.9	25684	2000	1000	1000	90219	1500
0.82	6.5 \times 15.5 (18.5) \times 17.5	1.0	25824	1000	1000	900	90221	1250
1	7.5 \times 16.5 (19.5) \times 17.5	1.3	25105	1000	1000	800	90222	1000



C (μ F)	DIMENSIONS $w_{max} \times h_{max} \times l_{max}$ (mm)	MASS (g)	CATALOG NUMBER 2222 368 AND PACKAGING					
			LOOSE IN BOX			REEL	LOOSE IN BOX	
			$l_t =$ 4.0 + 1.0/- 0.5 mm	short leads	long leads	SPQ	$l_t =$ 4.0 + 1.0/- 0.5 mm	SPQ
			C-tol = \pm 10 %				C-tol = \pm 10 %	
last 5 digits of catalog number	SPQ	SPQ	SPQ	last 5 digits of catalog number	SPQ			
Pitch = 22.5 \pm 0.4 mm; $d_t = 0.80 \pm 0.08$ mm							lock lead	
1.2	6.0 \times 18.0 (21.0) \times 26.0	2.5	25125	1000	1000	650	90223	1000
1.5			25155				90224	
1.8	7.0 \times 19.0 (22.0) \times 26.0	3.2	25185	1000	1000	650	90225	900
2.2	7.5 \times 19.5 (23.0) \times 26.0	3.5	25225	1000	500	600	90226	750
2.7	8.5 \times 21.5 (24.0) \times 26.0	4.1	25275	1000	500	500	90227	600
3.3	9.0 \times 22.0 (24.5) \times 26.0	4.5	25335	1000	500	450	90228	600
Pitch = 27.5 \pm 0.4 mm; $d_t = 0.80 \pm 0.08$ mm							lock lead	
3.9	9.0 \times 22.0 (24.0) \times 30.0	4.8	25395	500	500		90229	500
4.7	10.0 \times 23.0 (25.0) \times 30.0	5.5	25475	500	500		90178	400
5.6	11.0 \times 24.0 (26.0) \times 30.0	6.2	25565	500	250		90231	350
6.8	12.0 \times 25.0 (27.0) \times 30.0	6.8	25685	500	250		90232	350

$U_{Rdc} = 250$ V; $U_{Rac} = 160$ V

C (μ F)	DIMENSIONS $w_{max} \times h_{max} \times l_{max}$ (mm)	MASS (g)	CATALOG NUMBER 2222 368 AND PACKAGING					
			LOOSE IN BOX			REEL	LOOSE IN BOX	
			$l_t =$ 4.0 + 1.0/- 0.5 mm	short leads	long leads	SPQ	$l_t =$ 4.0 + 1.0/- 0.5 mm	SPQ
			C-tol = \pm 10 %				C-tol = \pm 10 %	
last 5 digits of catalog number	SPQ	SPQ	SPQ	last 5 digits of catalog number	SPQ			
Pitch = 10.0 \pm 0.4 mm; $d_t = 0.60 \pm 0.06$ mm							lock lead	
0.027	4.2 \times 13.0 (15.0) \times 12.5	0.4	45273	2000	1000	1500	90233	1250
0.033			45333				90234	
0.039	4.0 \times 13.0 (15.0) \times 12.5	0.4	45393	2000	1000	1500	90235	1250
0.047	4.5 \times 13.5 (15.5) \times 12.5	0.5	45473	2000	1000	1500	90176	1250
0.056	4.6 \times 13.5 (15.5) \times 12.5	0.5	45563	2000	1000	1300	90236	1100
0.068			45683				90237	
0.082	4.4 \times 13.4 (16.0) \times 12.5	0.5	45823	2000	1000	1200	90238	1000
0.1	4.7 \times 13.7 (16.0) \times 12.5	0.5	45104	2000	1000	1200	90177	1000
Pitch = 15.0 \pm 0.4 mm; $d_t = 0.80 \pm 0.08$ mm							lock lead	
0.12	5.0 \times 14.0 (17.0) \times 17.5	0.6	45124	2000	1000	1200	90239	1750
0.15			45154				90241	
0.18	5.5 \times 14.5 (17.5) \times 17.5	0.7	45184	2000	1000	1100	90242	1500
0.22	6.0 \times 15.0 (18.0) \times 17.5	0.9	45224	2000	1000	1000	90243	1500
0.27	6.0 \times 15.5 (18.5) \times 17.5	1.0	45274	2000	1000	900	90244	1250
0.33	6.8 \times 16.0 (19.0) \times 17.5	1.2	45334	1000	1000	800	90245	1250
Pitch = 22.5 \pm 0.4 mm; $d_t = 0.80 \pm 0.08$ mm							lock lead	
0.39	5.0 \times 17.0 (20.0) \times 26.0	1.8	45394	1000	1000	800	90246	1250
0.47	5.5 \times 17.5 (20.5) \times 26.0	2.2	45474	1000	1000	750	90247	1250
0.56	6.0 \times 18.0 (21.0) \times 26.0	2.5	45564	1000	1000	650	90248	1000
0.68	6.6 \times 18.5 (21.5) \times 26.0	2.8	45684	1000	1000	600	90249	1000
0.82	7.2 \times 19.0 (22.0) \times 26.0	3.2	45824	1000	1000	550	90251	900
1	8.0 \times 20.0 (23.0) \times 26.0	3.8	45105	1000	500	500	90252	750



Metallized Polyester Film Capacitors Vishay BCcomponents
MKT Radial Epoxy Lacquered Type

C (μ F)	DIMENSIONS $w_{max} \times h_{max} \times l_{max}$ (mm)	MASS (g)	CATALOG NUMBER 2222 368 AND PACKAGING					
			LOOSE IN BOX			REEL	LOOSE IN BOX	
			$l_t =$ 4.0 + 1.0/- 0.5 mm	short leads	long leads	SPQ	$l_t =$ 4.0 + 1.0/- 0.5 mm	SPQ
			C-tol = \pm 10 %				C-tol = \pm 10 %	
last 5 digits of catalog number	SPQ	SPQ	SPQ	last 5 digits of catalog number	SPQ			
Pitch = 27.5 \pm 0.4 mm; $d_t = 0.80 \pm 0.08$ mm							lock lead	
1.2	8.0 \times 21.0 (23.0) \times 30.0	4.1	45125	500	500		90253	600
1.5	9.0 \times 22.0 (25.0) \times 30.0	4.8	45155	500	500		90254	450
1.8	10.0 \times 23.0 (26.0) \times 30.0	5.5	45185	500	500		90255	400
2.2	11.0 \times 24.0 (27.0) \times 30.0	6.2	45225	500	250		90256	350

$U_{Rdc} = 400$ V; $U_{Rac} = 220$ V

C (μ F)	DIMENSIONS $w_{max} \times h_{max} \times l_{max}$ (mm)	MASS (g)	CATALOG NUMBER 2222 368 AND PACKAGING					
			LOOSE IN BOX			REEL	LOOSE IN BOX	
			$l_t =$ 4.0 + 1.0/- 0.5 mm	short leads	long leads	SPQ	$l_t =$ 4.0 + 1.0/- 0.5 mm	SPQ
			C-tol = \pm 10 %				C-tol = \pm 10 %	
last 5 digits of catalog number	SPQ	SPQ	SPQ	last 5 digits of catalog number	SPQ			
Pitch = 10.0 \pm 0.4 mm; $d_t = 0.60 \pm 0.06$ mm							lock lead	
0.001	4.5 \times 13.5 (15.5) \times 12.5	0.5	55102	2000	1000	1500	90257	1100
0.0012			55122				90258	
0.0015			55152				90259	
0.0018			55182				90261	
0.0022	4.0 \times 13.0 (15.5) \times 12.5	0.5	55222	2000	1000	1500	90262	1100
0.0027	4.3 \times 13.3 (15.5) \times 12.5	0.5	55272	2000	1000	1500	90263	1100
0.0033	4.6 \times 13.6 (15.5) \times 12.5	0.5	55332	2000	1000	1500	90264	1100
0.0039	4.0 \times 13.0 (15.5) \times 12.5	0.5	55392	2000	1000	1500	90265	1100
0.0047	4.1 \times 13.2 (15.5) \times 12.5	0.5	55472	2000	1000	1500	90266	1100
0.0056	4.6 \times 13.6 (15.5) \times 12.5	0.5	55562	2000	1000	1500	90267	1100
0.0068			55682				90268	
0.0082			55822				90269	
0.01			55103				90271	
0.012	4.0 \times 13.0 (15.5) \times 12.5	0.5	55123	2000	1000	1500	90272	1100
0.015	4.1 \times 13.0 (15.5) \times 12.5	0.5	55153	2000	1000	1300	90273	1100
0.018	4.4 \times 13.0 (15.5) \times 12.5	0.5	55183	2000	1000	1500	90274	1100
0.022	4.2 \times 12.9 (15.5) \times 12.5	0.5	55223	2000	1000	1500	90175	1100
0.027	4.2 \times 13.2 (15.5) \times 12.5	0.5	55273	2000	1000	1300	90275	1100
0.033	4.6 \times 13.7 (15.5) \times 12.5	0.5	55333	2000	1000	1300	90188	1100
Pitch = 15.0 \pm 0.4 mm; $d_t = 0.80 \pm 0.08$ mm							lock lead	
0.039	5.0 \times 13.9 (16.5) \times 17.5	0.6	55393	2000	1000	1200	90276	2000
0.047	5.4 \times 14.5 (17.0) \times 17.5	0.7	55473	2000	1000	1200	90277	1750
0.056	5.0 \times 13.7 (16.5) \times 17.5	0.6	55563	2000	1000	1200	90278	2000
0.068	5.0 \times 13.5 (16.5) \times 17.5	0.6	55683	2000	1000	1200	90279	2000
0.082	4.8 \times 14.0 (16.5) \times 17.5	0.6	55823	2000	1000	1100	90281	2000
0.1	5.3 \times 14.5 (17.5) \times 17.5	0.7	55104	2000	1000	1000	90186	1500
0.12	5.7 \times 15.0 (18.0) \times 17.5	0.9	55124	1000	1000	900	90282	1500
0.15	6.4 \times 15.5 (18.5) \times 17.5	1.0	55154	1000	1000	800	90187	1250



C (μ F)	DIMENSIONS $W_{max} \times h_{max} \times l_{max}$ (mm)	MASS (g)	CATALOG NUMBER 2222 368 AND PACKAGING					
			LOOSE IN BOX			REEL	LOOSE IN BOX	
			$l_t =$ 4.0 + 1.0/- 0.5 mm	short leads	long leads	SPQ	$l_t =$ 4.0 + 1.0/- 0.5 mm	SPQ
			C-tol = \pm 10 %				C-tol = \pm 10 %	
last 5 digits of catalog number	SPQ	SPQ	SPQ	last 5 digits of catalog number	SPQ			
Pitch = 22.5 \pm 0.4 mm; d_t = 0.80 \pm 0.08 mm							lock lead	
0.18	5.6 \times 17.5 (20.5) \times 26.0	2.2	55184	1000	1000	800	90283	1250
0.22	6.3 \times 18.5 (21.5) \times 26.0	2.8	55224	1000	1000	650	90284	1000
0.27	6.0 \times 18.0 (21.0) \times 26.0	2.5	55274	1000	1000	650	90285	1000
0.33	6.4 \times 18.5 (21.5) \times 26.0	2.8	55334	1000	1000	650	90286	1000
0.39	7.1 \times 19.0 (21.5) \times 26.0	2.8	55394	1000	1000	550	90287	900
0.47	8.0 \times 20.0 (22.5) \times 26.0	3.8	55474	1000	500	500	90179	750
Pitch = 27.5 \pm 0.4 mm; d_t = 0.80 \pm 0.08 mm							lock lead	
0.56	7.5 \times 20.5 (22.5) \times 30.0	3.8	55564	500	500		90288	600
0.68	8.5 \times 21.5 (23.5) \times 30.0	4.5	55684	500	500		90289	500
0.82	9.5 \times 22.5 (24.5) \times 30.0	5.2	55824	500	500		90291	450
1	10.5 \times 23.5 (26.5) \times 30.0	5.8	55105	500	250		90292	350

$U_{Rdc} = 630$ V; $U_{Rac} = 250$ V

C (μ F)	DIMENSIONS $W_{max} \times h_{max} \times l_{max}$ (mm)	MASS (g)	CATALOG NUMBER 2222 368 AND PACKAGING					
			LOOSE IN BOX			REEL	LOOSE IN BOX	
			$l_t =$ 4.0 + 1.0/- 0.5 mm	short leads	long leads	SPQ	$l_t =$ 4.0 + 1.0/- 0.5 mm	SPQ
			C-tol = \pm 10 %				C-tol = \pm 10 %	
last 5 digits of catalog number	SPQ	SPQ	SPQ	last 5 digits of catalog number	SPQ			
Pitch = 10.0 \pm 0.4 mm; d_t = 0.60 \pm 0.06 mm							lock lead	
0.01	4.3 \times 13.1 (15.5) \times 12.5	0.5	65103	2000	1000	1300	90293	1100
0.012	4.6 \times 13.4 (16.0) \times 12.5	0.5	65123	2000	1000	1200	90294	1000
0.015	4.9 \times 13.9 (16.5) \times 12.5	0.6	65153	2000	1000	1100	90295	1500
0.018	5.3 \times 14.3 (17.0) \times 12.5	0.6	65183	2000	1000	1000	90296	1250
0.022	5.9 \times 14.9 (17.5) \times 12.5	0.8	65223	2000	1000	900	90297	1250
Pitch = 15.0 \pm 0.4 mm; d_t = 0.80 \pm 0.08 mm							lock lead	
0.027	5.5 \times 14.5 (17.5) \times 17.5	0.7	65273	2000	1000	1100	90298	1500
0.033	6.0 \times 15.0 (18.0) \times 17.5	0.9	65333	2000	1000	1000	90299	1500
0.039	6.3 \times 15.5 (18.5) \times 17.5	1.0	65393	2000	1000	900	90301	1250
0.047	7.0 \times 16.0 (19.0) \times 17.5	1.2	65473	2000	1000	800	90302	1250
0.056	7.5 \times 16.5 (19.5) \times 17.5	1.3	65563	1000	1000	800	90303	1000
0.068	8.0 \times 17.0 (20.0) \times 17.5	1.4	65683	1000	1000	750	90304	1000
Pitch = 22.5 \pm 0.4 mm; d_t = 0.80 \pm 0.08 mm							lock lead	
0.082	6.1 \times 18.0 (21.0) \times 26.0	2.5	65823	1000	1000	750	90305	1000
0.1	7.0 \times 19.0 (22.0) \times 26.0	3.2	65104	1000	1000	650	90306	900
0.12	7.2 \times 19.5 (22.5) \times 26.0	3.5	65124	1000	1000	550	90307	750
0.15	8.0 \times 21.0 (23.0) \times 26.0	3.8	65154	1000	500	500	90308	750
0.18	9.0 \times 22.0 (24.0) \times 26.0	4.5	65184	1000	500	450	90309	600
0.22	10.0 \times 23.0 (25.0) \times 26.0	5.2	65224	1000	500	400	90311	550



C (μ F)	DIMENSIONS $w_{max} \times h_{max} \times l_{max}$ (mm)	MASS (g)	CATALOG NUMBER 2222 368 AND PACKAGING					
			LOOSE IN BOX			REEL	LOOSE IN BOX	
			$l_t =$ 4.0 + 1.0/- 0.5 mm	short leads	long leads	SPQ	$l_t =$ 4.0 + 1.0/- 0.5 mm	SPQ
			C-tol = $\pm 10\%$				C-tol = $\pm 10\%$	
			last 5 digits of catalog number	SPQ	SPQ	SPQ	last 5 digits of catalog number	SPQ
Pitch = 27.5 \pm 0.4 mm; $d_t = 0.80 \pm 0.08$ mm							lock lead	
0.27	10.0 \times 23.0 (25.0) \times 30.0	5.5	65274	500	500		90312	400
0.33	11.5 \times 24.5 (26.5) \times 30.0	6.5	65334	500	250		90313	350
0.39	12.5 \times 25.5 (28.5) \times 30.0	7.1	65394	500	250		90314	300
0.47	14.0 \times 27.0 (30.0) \times 30.0	8.2	65474	250	250		90315	250

CAPACITANCE

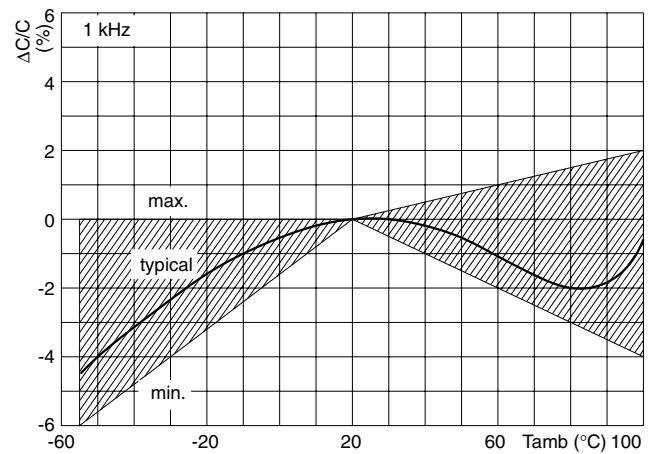
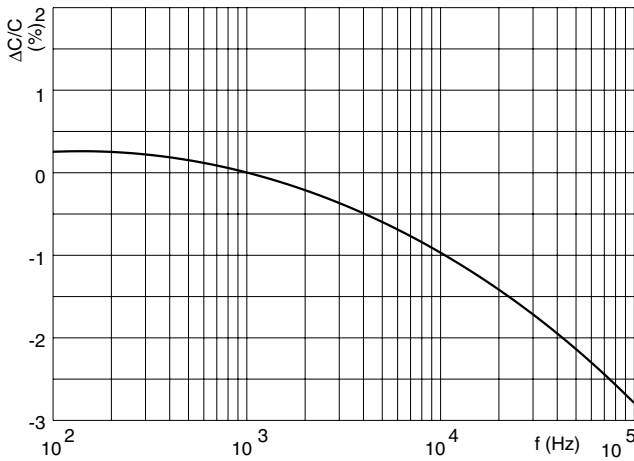

IMPEDANCE

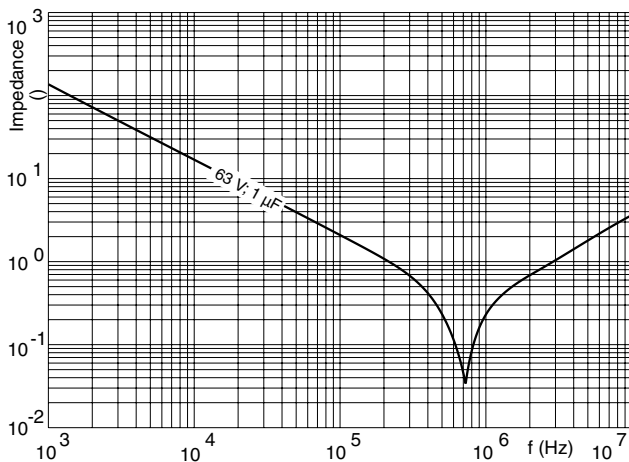

MAXIMUM RMS VOLTAGE (SINEWAVE) AS A FUNCTION OF FREQUENCY

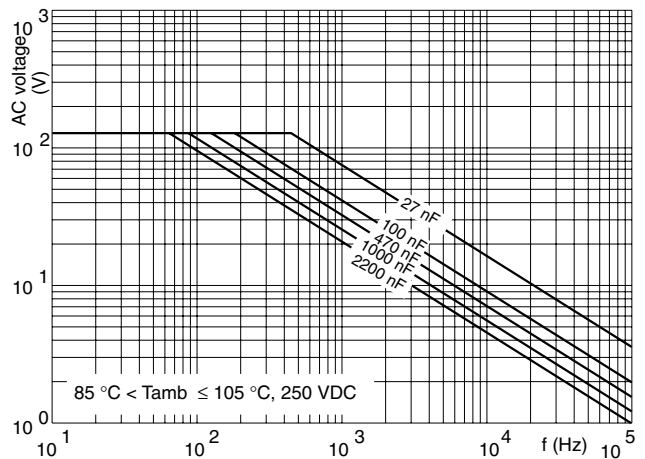
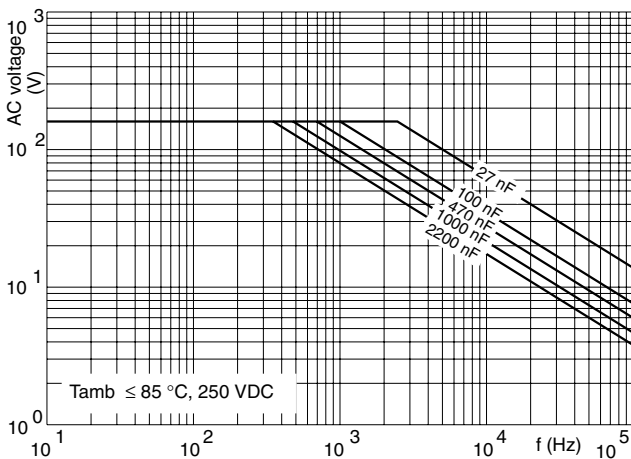
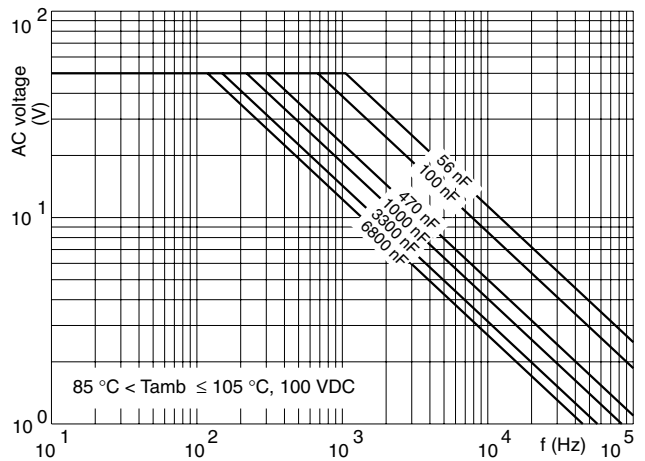
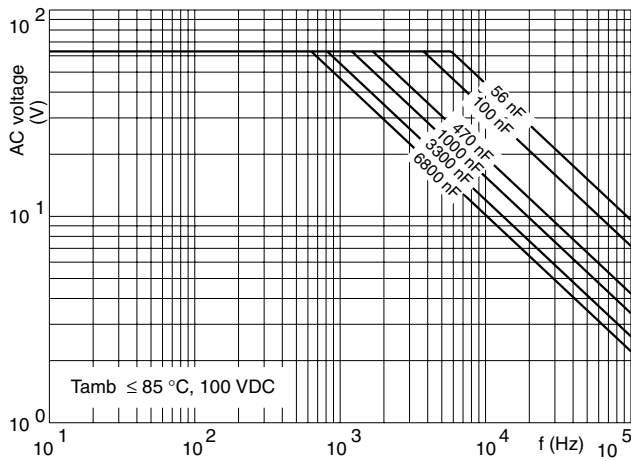
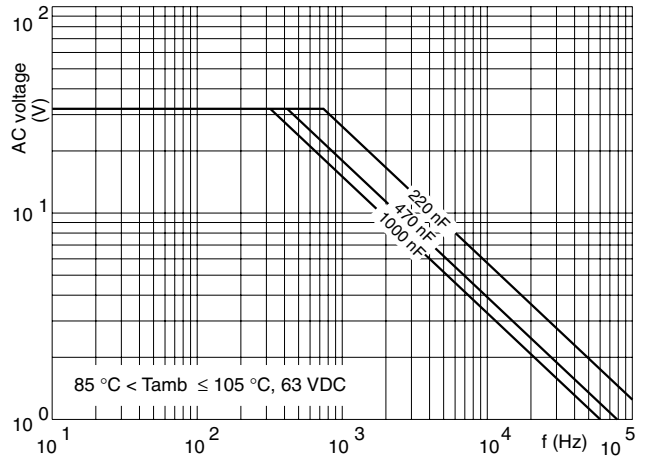
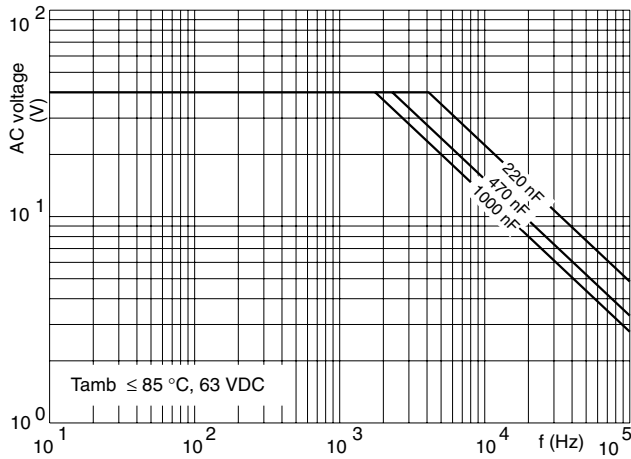

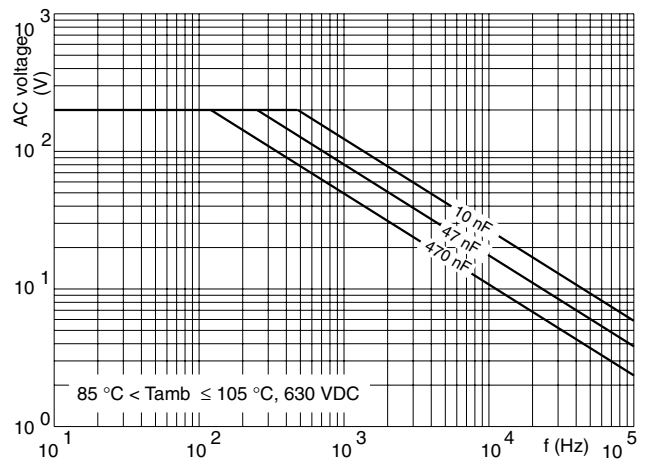
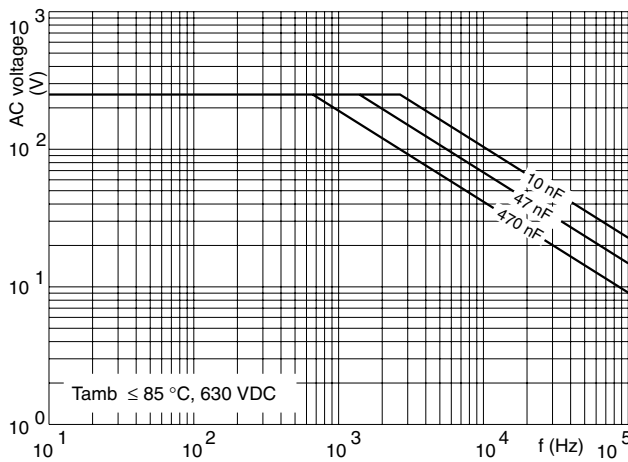
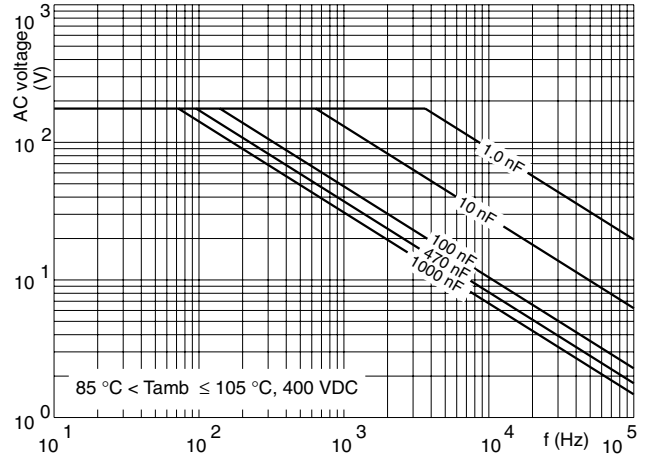
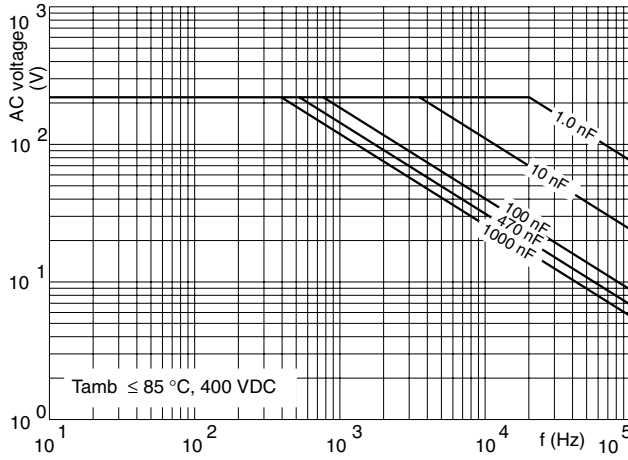



Disclaimer

All product specifications and data are subject to change without notice.

Vishay Intertechnology, Inc., its affiliates, agents, and employees, and all persons acting on its or their behalf (collectively, "Vishay"), disclaim any and all liability for any errors, inaccuracies or incompleteness contained herein or in any other disclosure relating to any product.

Vishay disclaims any and all liability arising out of the use or application of any product described herein or of any information provided herein to the maximum extent permitted by law. The product specifications do not expand or otherwise modify Vishay's terms and conditions of purchase, including but not limited to the warranty expressed therein, which apply to these products.

No license, express or implied, by estoppel or otherwise, to any intellectual property rights is granted by this document or by any conduct of Vishay.

The products shown herein are not designed for use in medical, life-saving, or life-sustaining applications unless otherwise expressly indicated. Customers using or selling Vishay products not expressly indicated for use in such applications do so entirely at their own risk and agree to fully indemnify Vishay for any damages arising or resulting from such use or sale. Please contact authorized Vishay personnel to obtain written terms and conditions regarding products designed for such applications.

Product names and markings noted herein may be trademarks of their respective owners.