

BT 07/10/15/22/27

CPM-85 — 7.5/10/15/22.5/27.5 Radial Leads

63/100/160/250/400/630 V-



APPLICATIONS

Non-inductive, self-healing, metallized polyester film capacitor. Insulated* thermoplastic casing, epoxy resin sealed with stand-offs*. Radial connections.

* Flame retardant resin and case according to UL 94 VO.

Some examples of use:

Supply decoupling, filter, integrators, treatment of analog signals, rejection of line perturbations, etc.

STANDARDIZATION

Generic specifications:

CEI 384-1/CECC 30000/UTE 83100

Sectional specifications:

CEI 384-2/CECC 30400/UTE 83151

On the LNZ list:

Complies with type CPM85 – CPM-R

Schematic Cross Section

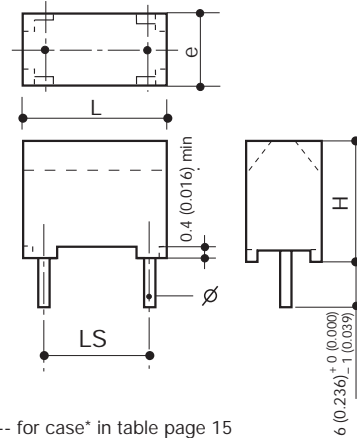
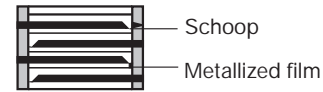

---- for case* in table page 15

DIMENSIONS:

Size Code	L max.	H max.	e max.	LS ±0.4	ø ^{+10%} _{-0.05}	Observations
07	9.25 ... 10.1 (0.364 ... 0.398)	8.0 ... 12.0 (0.315 ... 0.472)	3.25 ... 6.0 (0.128 ... 0.236)	7.5 (0.295)	0.6 (0.024)	1nF ≤ C _R ≤ 1μF
10	12.5 (0.492)	9.0 ... 13.5 (0.354 ... 0.531)	4.0 / 5.0 (0.157 / 0.197)	10.0 (0.394)	0.6 (0.024)	4.7nF ≤ C _R ≤ 470nF
15	17.5 (0.689)	10.5 ... 14.5 (0.413 ... 0.571)	5.0 ... 8.5 (0.197 ... 0.335)	15.0 (0.591)	0.8 (0.031)	33nF ≤ C _R ≤ 2.2μF
22	26.25 (1.033)	15.0 ... 19.5 (0.591 ... 0.768)	7.5 / 10.0 (0.295 / 0.394)	22.5 (0.886)	0.8 (0.031)	100nF ≤ C _R ≤ 6.8μF
27	31.25 (1.230)	19.5 ... 30.0 (0.768 ... 1.181)	10.0 ... 17.5 (0.394 ... 0.689)	27.5 (1.083)	0.8 (0.031)	330nF ≤ C _R ≤ 22μF

HOW TO ORDER

BT 10
Type

4
Class

G
Voltage

0104
Capacitance Value

K
Tolerance

--
Suffix
Tape and Reel
See page 27

PERFORMANCE CHARACTERISTICS

Climatic category: 55/100/56 - Performance Class 1

Capacitance range: C_R 1 nF to 2.2 μF (E6)

Tolerances on C_R: ±5%, ±10%, ±20%
(other values on request)

Nominal voltages: V_{R-} 63/100/160/250/400/630 V
V_{R-} 40/63/80/160/200/220 V

Category voltage: V_C = 0.8 V_{R-} at 100°C

Test voltage: V_e = 1.6 V_{R-}/2 s at 25°C

Tangent of loss angle: D.F. (see page 4)

Insulation resistance: IR (see page 5)

Max. voltage gradient: (dv/dt)_R (see page 5)

Size	V _{R-}					
	63	100	160	250	400	630
07	35	50	-	72	150	300
10	18	28	30	45	90	180
15	12	15	20	30	55	100
22	4	5	-	9	12	20
27	3	4	6	7	10	15

MARKING

Logo

Nominal capacitance

Tolerance (EIA code)

DC nominal voltage

**NOMINAL VOLTAGE (V_R) AND CAPACITANCE VALUES (C_R)
DEPENDING ON THE DIMENSIONS**

S i z e	C a s e	DIMENSIONS: millimeters (inches)					Reference					
							BT					
		Max L	Max H	Max e	\varnothing <small>+10% -0.05</small>	LS ± 0.4	V_{R+}/V_{R-}					
							63/40	100/63	160/80	250/160	400/200	630/220
Range of Capacitance (C_R min. ... max.)												
07	1	9.25 (0.364)	8.0 (0.315)	3.25 (0.128)	0.6 (0.024)	7.5 (0.295)	68 nF ... 220 nF	22 nF ... 150 nF	-	6.8 nF ... 47 nF	1 nF ... 22 nF	1 nF ... 3.3 nF
	2	10.1 (0.398)	10.0 (0.394)	5.0 (0.197)	0.6 (0.024)		330 nF/470 nF	220 nF/330 nF	-	68 nF ... 100 nF	-	4.7 nF/6.8 nF
	C	10.1 (0.398)	11.0 (0.433)	5.0 (0.197)	0.6 (0.024)		680 nF	-	-	-	-	10 nF
	D	10.1 (0.398)	12.0 (0.472)	6.0 (0.236)	0.6 (0.024)		1 μ F	-	-	150 nF	33 nF ... 47 nF	15 nF
10	EO	12.5 (0.492)	9.0 (0.354)	4.0 (0.157)	0.6 (0.024)	10.0 (0.394)	220 nF ... 470 nF	100 nF ... 220 nF	100 nF ... 220 nF	33 nF ... 100 nF	6.8 nF ... 33 nF	-
	4	12.5 (0.492)	10.0 (0.394)	5.0 (0.197)	0.6 (0.024)		-	-	-	-	47 nF	4.7 nF/22 nF
15	6	17.5 (0.689)	10.5 (0.413)	5.0 (0.197)	0.8 (0.031)	15.0 (0.591)	680 nF ... 1 μ F	150 nF ... 1 μ F	330 nF/470 nF	68 nF ... 220 nF	47 nF/68 nF	33 nF
	7	17.5 (0.689)	13.5 (0.531)	5.0 (0.197)	0.8 (0.031)		-	-	-	-	100 nF	-
	IO	17.5 (0.689)	12.0 (0.472)	6.0 (0.236)	0.8 (0.031)		2.2 μ F	-	680 nF	330 nF	-	-
	8	17.5 (0.689)	13.5 (0.531)	6.25 (0.246)	0.8 (0.031)		-	-	1 μ F	390 nF	150 nF	47 nF
	9	17.5 (0.689)	14.5 (0.571)	8.5 (0.335)	0.8 (0.031)		-	-	2.2 μ F	-	-	68 nF
22	11	26.25 (1.033)	15.0 (0.591)	7.5 (0.295)	0.8 (0.031)	22.5 (0.886)	-	1.5 μ F	-	470 nF/680 nF	220 nF	100 nF
	12	26.25 (1.033)	17.5 (0.689)	7.5 (0.295)	0.8 (0.031)		3.3 μ F	2.2 μ F	-	-	330 nF	150 nF
	13	26.25 (1.033)	19.5 (0.768)	10.0 (0.394)	0.8 (0.031)		4.7 μ F/6.8 μ F	3.3 μ F	-	1 μ F/1.5 μ F	470 nF	220 nF
27	16	31.25 (1.230)	19.5 (0.768)	10.0 (0.394)	0.8 (0.031)	27.5 (1.083)	6.8 μ F	4.7 μ F	3.3 μ F	1.5 μ F	470 nF 680 nF	330 nF
	17*	31.25 (1.230)	22.5 (0.886)	12.5 (0.492)	0.8 (0.031)		10 μ F	6.8 μ F	-	2.2 μ F	1 μ F	470 nF
	18*	31.25 (1.230)	26.0 (1.024)	15.0 (0.591)	0.8 (0.031)		15 μ F	10 μ F	-	3.3 μ F	1.5 μ F	680 nF
	19*	31.25 (1.230)	30.0 (1.181)	17.5 (0.689)	0.8 (0.031)		22 μ F	-	-	4.7 μ F	2.2 μ F	1 μ F

CHARACTERISTIC CURVES

Influence of the frequency on the impedance (room temperature)

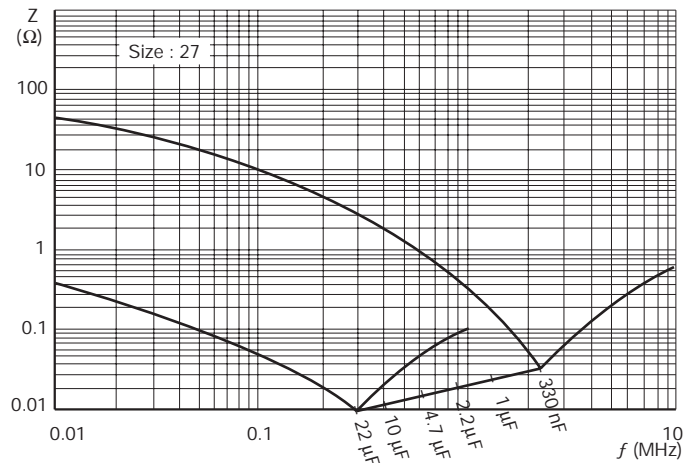
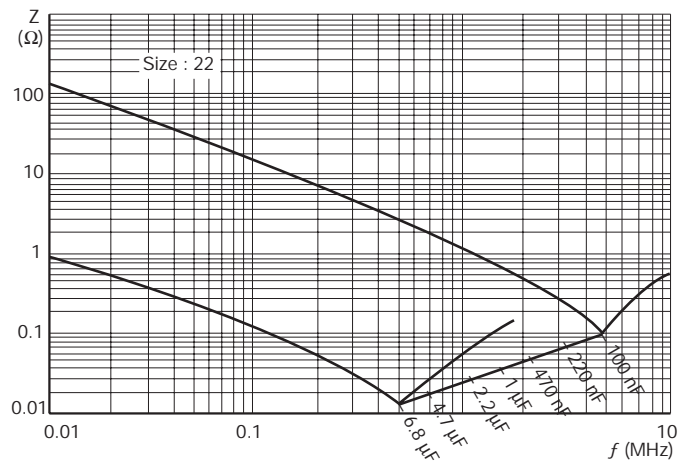
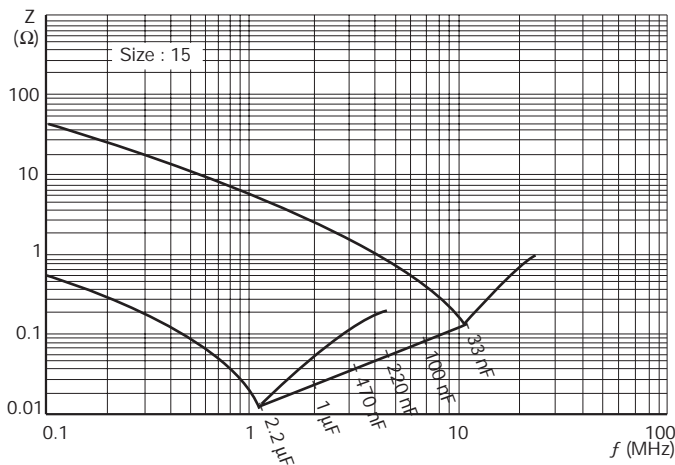
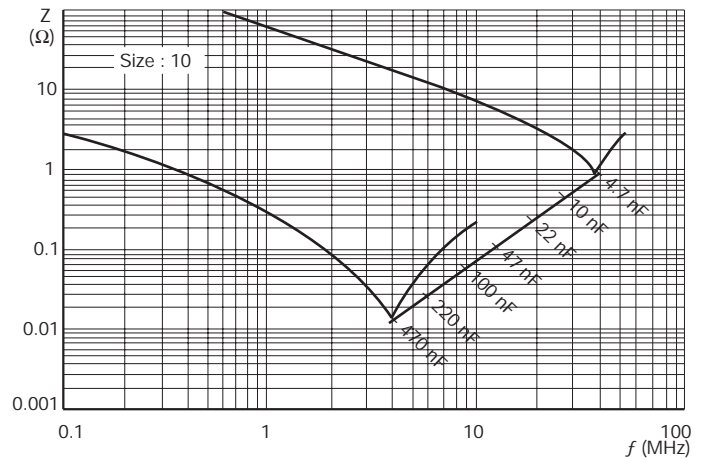
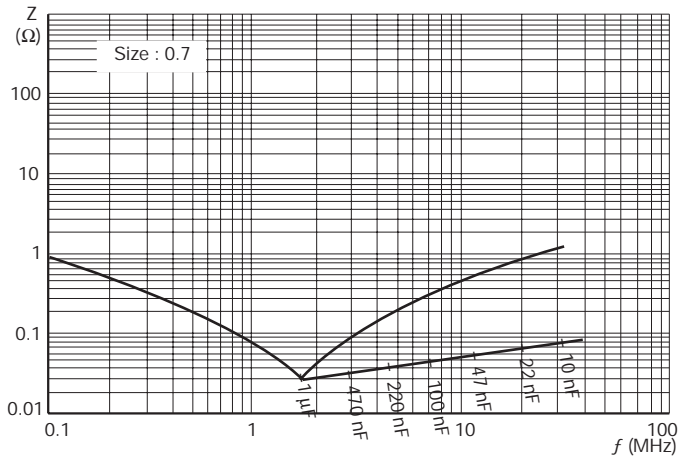

CHARACTERISTIC CURVES

Nominal RMS voltage vs. frequency (room temperature) allowing a 10°C increase of the external temperature of the box.

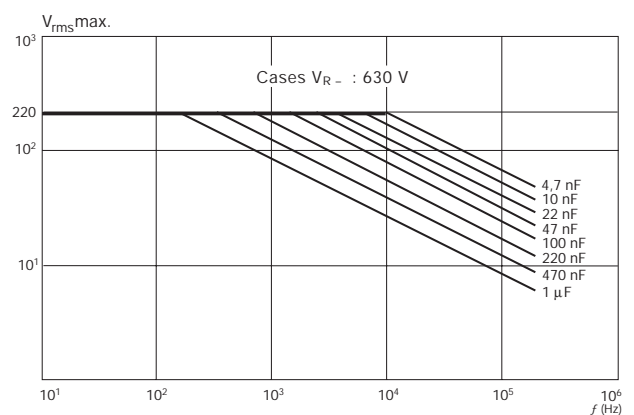
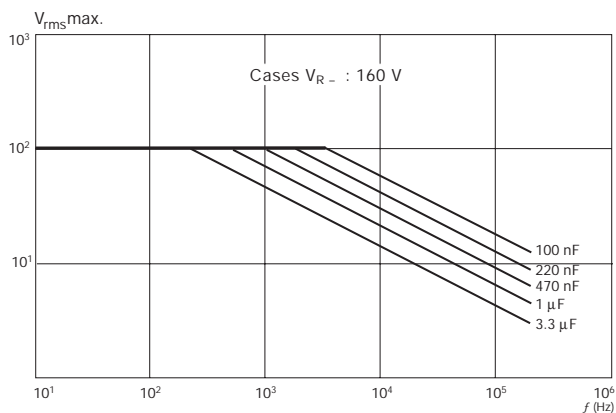
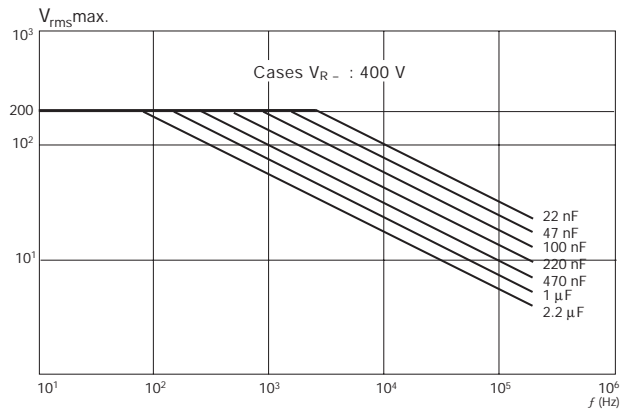
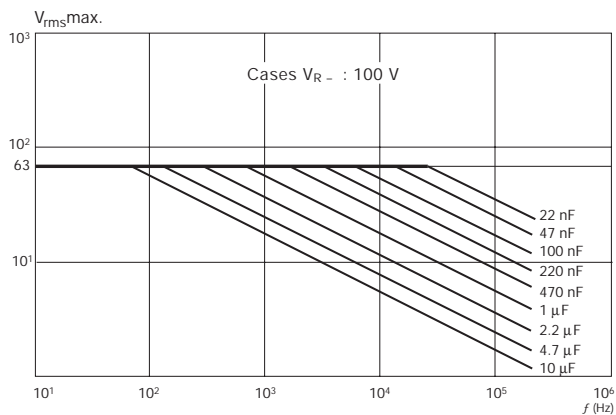
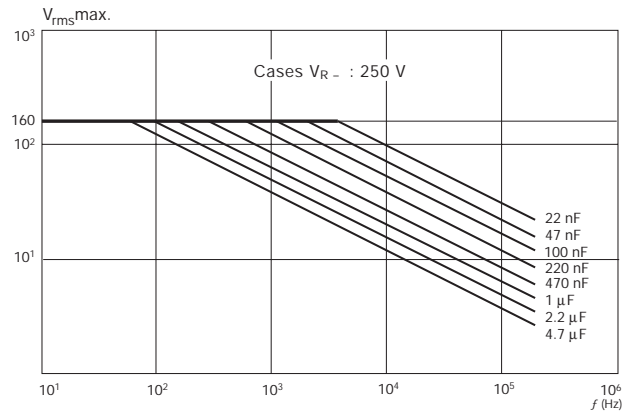
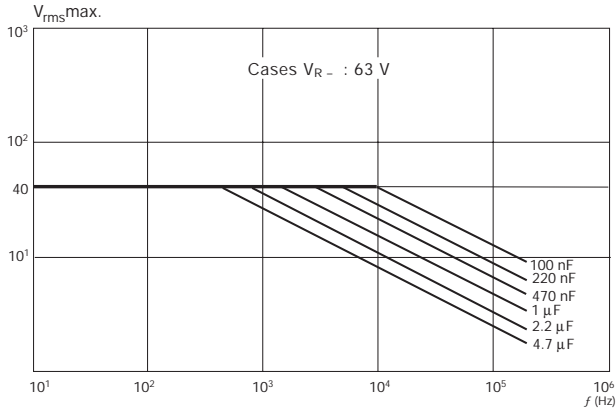

CHARACTERISTICS OF THE REEL –

Suffixes to be used (see page 7) millimeters (inches)

	Taping Suffix EN		
	Lead Spacing tol ± 0.4 (0.016)		
	7.5 (0.295)	10 (0.394)	15 (0.590)
P	12.7 \pm 1.0 (0.5 \pm 0.039)	25.4 \pm 1.0 (1.0 \pm 0.039)	
H	16.5 \pm 0.3 (0.650 \pm 0.012)		16 $^{+1.5}_{-0.5}$ (0.630 $^{+0.059}_{-0.020}$)

PACKAGING

Size	Case Code	Minimum Quantity*	
		Reel	Bulk
7.5	1	2000	3000
	2	1250	1750
	C	1250	1500
	D	1000	1000
10	E0	850	1750
	4	700	1250
	5	700	1000
	6	1000	750
15	7	1000	3000
	10	1000	750
	8	833	3000
	9	625	2000
	10	-	225
	11	-	200
22	12	-	200
	13	-	150
	14	-	160
27	15	-	140
	16	-	120
	17	-	100
	18	-	80
	19	-	65

* Ordering quantities must be a multiple of the above figures

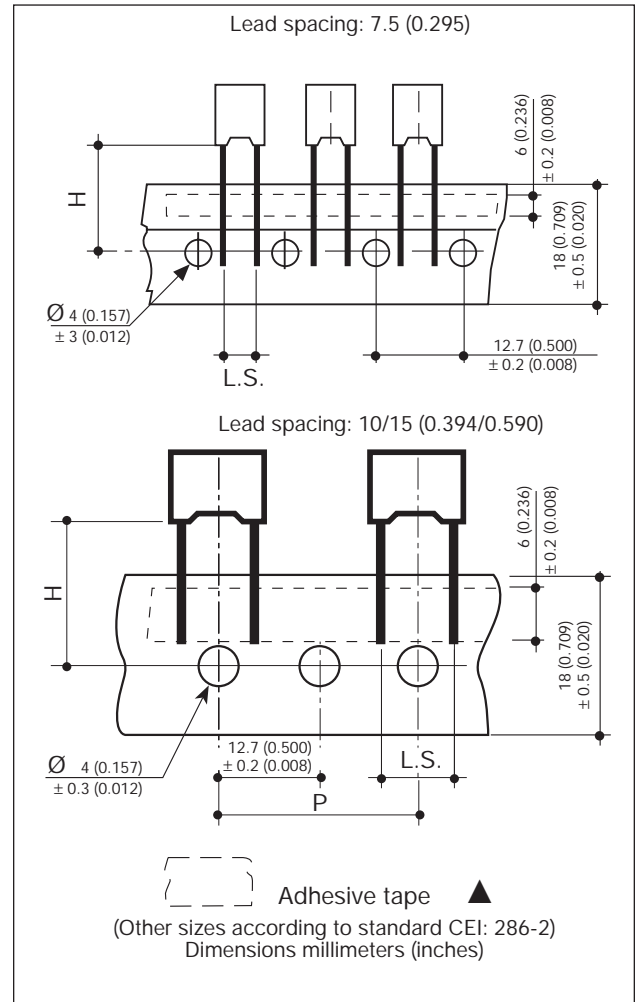

Lead Spacing	D	E (ext)
7.5/10	360 (14.173)	48 (1.890)
15	500 (19.685)	52 (2.047)

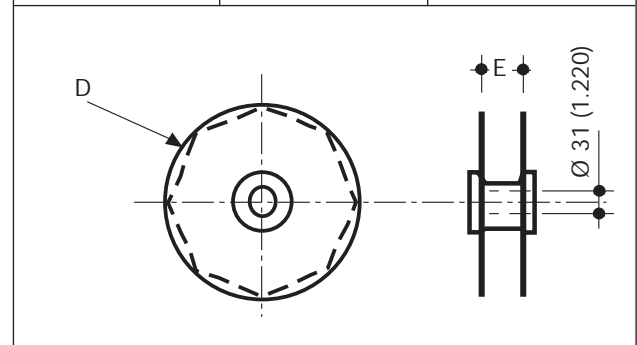

Metallized Polyester Film Dielectric Capacitors



Type Selection Guide

Presentation	Type		Nominal Voltage		Capacitance Range (C_R)	Tolerance on C_R (Series)	Lead Spacing mm (inches)
	TPC	UTE	V_R (V)	V_R (V)			
Radial Leads	BF	CPM-83	63 ... 400	40 ... 200	1 nF ... 2.2 μ F	$\pm 5\%$ (E6 - E12)	5.08 (0.200)
		C83151				$\pm 10\%$ (E6 - E12)	
	BH	CPM-N	63 ... 400	40 ... 200	1 nF ... 2.2 μ F	$\pm 5\%$ (E6 - E12)	5.08 (0.200)
		C83151				$\pm 10\%$ (E6 - E12)	
	BT	CPM85	63 ... 630	40 ... 220	1 nF ... 22 μ F	$\pm 5\%$ (E6 - E12)	7.5 (0.295)
		C83151				$\pm 10\%$ (E6 - E12)	10.0 (0.394)
	BG	CPM85	63 ... 1,000	40 ... 250	1 nF ... 22 μ F	$\pm 5\%$ (E6 - E12)	15.0 (0.591)
C83151		$\pm 10\%$ (E6 - E12)				22.5 (0.886)	
BC / BD			250	-	0.47 μ F ... 2.2 μ F	$\pm 5\%$	15.0 (0.591)
						$\pm 10\%$	
BO	CPM50	40 ... 400	25 ... 200	1 nF ... 22 μ F	$\pm 5\%$ (E6 - E12)	7.5 (0.295)	
	C83151				$\pm 10\%$ (E6 - E12)	10.0 (0.394)	
S4	CPM13	63 ... 400	40 ... 200	1 nF ... 10 μ F	$\pm 5\%$ (E6 - E12)	7.62 (0.300)	
	C83151				$\pm 10\%$ (E6 - E12)	10.16 (0.400)	
					$\pm 20\%$ (E6 - E12)	15.24 (0.600)	
						$\pm 20\%$ (E6 - E12)	27.94 (1.100)

Axial Leads	S8	CPM8	63 ... 400	40 ... 200	1 nF ... 10 μ F	$\pm 5\%$ (E6 - E12)	
		C83151				$\pm 10\%$ (E6 - E12)	
	SH	CPM8	63 ... 1,000	40 ... 250	1 nF ... 22 μ F	$\pm 5\%$ (E6 - E12)	
		C83151				$\pm 10\%$ (E6 - E12)	
	S9	CPM72	100 ... 630	40 ... 220	1 nF ... 10 μ F	$\pm 5\%$ (E6 - E12)	
C83151		$\pm 10\%$ (E6 - E12)					
SG	CPM72	63 ... 1,000	40 ... 250	1 nF ... 22 μ F	$\pm 5\%$ (E6 - E12)		
	C83151				$\pm 10\%$ (E6 - E12)		
ST		630 ... 10,000			100 pF ... 1.5 μ F	$\pm 5\%$ (E6 - E12)	
						$\pm 10\%$ (E6 - E12)	
						$\pm 20\%$ (E6 - E12)	

Metallized Polyester Film Dielectric Capacitors



HOW TO ORDER

Example of an order: how to order a CPM85 100 nF $\pm 10\%$ 100 V.

BT07	4	E	0104	K	--
Identification Code	Dielectric Class	Voltage Code	Capacitance (EIA code)	Tolerance Code	Suffix
	4				
Radial Leads		C = 25/40 V D = 50/63 V E = 100 V F = 160/200 V G = 250 V H = 275/300 V I = 400 V J = 500 V K = 600/630 V L = 1000 V M = 1600 V N = 2000 V P = 2500 V Q = 3000 V R = 4000 V S = 5000 V T = 6000/6300 V U = 8000 V V = 10 kV	Capacitance expressed by 2 significant figures 1st digit: 0 (zero) 2nd and 3rd digit: the 2 significant figures of the capacitance value 4th digit: - for values ≥ 10 pF and ≤ 990 μ F: the number of zeros to be added to the capacitance values - for values ≥ 1 pF and ≤ 9.9 pF: the numerical 9 signifying that the capacitance value is to be multiplied by 0.1 - for values < 1 pF: the numerical 8 signifying that the capacitance value is to be multiplied by 0.01 Example: 1000 pF = 0102 8.2 pF = 0829 0.47 pF = 0478	J = $\pm 5\%$ K = $\pm 10\%$ M = $\pm 20\%$	DA - DB - DC - DD: lead spacing 5.08 mm taped on reel or ammpack EN Radial types: lead spacing 7.5/10/15 mm taped on reel H=16.5 mm Axial type: (SG series only) Ammopack EP: Taped on reel H=18.5 mm (only for BG type) GA or GB: standard axial taped (S8, S9, ST types) -- Bulk
CPM83 BF 01 CPM83 BF 02 CPM83 BF 05 CPM83 BF 06 CPM83 BF 07 CPM-N BH 01 CPM-N BH 02 CPM-N BH 05 CPM-N BH 06 CPM-N BH 07 CPM85 BT 07 CPM85 BT 10 CPM85 BT 15 CPM85 BT 22 CPM85 BT 27 CPM85 BG 07 CPM85 BG 10 CPM85 BG 15 CPM85 BG 22 CPM85 BG 27 - BC 15 - BD 15 CPM50 BO 07 CPM50 BO 10 CPM50 BO 15 CPM50 BO 27 CPM13 S4 07 CPM13 S4 10 CPM13 S4 15 CPM13 S4 27			Capacitance expressed by 3 significant figures 1st, 2nd and 3rd digit: the 3 significant figures of the capacitance value 4th digit: - for values > 100 pF and ≤ 999 μ F: the number of zeros to be added to the capacitance values - for values > 10 pF and < 100 pF: the numerical 9 signifying that the capacitance value is to be multiplied by 0.1 - for values > 1 pF and < 10 pF: the numerical 8 signifying that the capacitance value is to be multiplied by 0.1 Example: 196 pF = 1960 47.2 pF = 4729 8.28 pF = 8288		
Axial Leads					
CPM8 S8 10 CPM8 S8 14 CPM8 S8 18 CPM8 S8 31 CPM8 SH 13 CPM8 SH 18 CPM8 SH 25 CPM8 SH 30 CPM8 SH 40 CPM72 S9 10 CPM72 S9 14 CPM72 S9 18 CPM72 S9 27 CPM72 S9 31 CPM72 SG 13 CPM72 SG 18 CPM72 SG 25 CPM72 SG 30 CPM72 SG 40 - ST 22 - ST 36					