

REV	DESCRIP	DATE	APPRVD

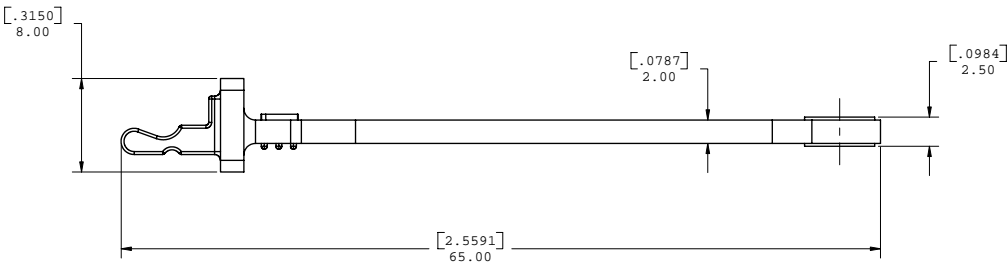

PART NUMBER FOR ORDER	COLOR
MUSB-2A111-014-BP	GREY
MUSB-2A111-024-BP	BLACK

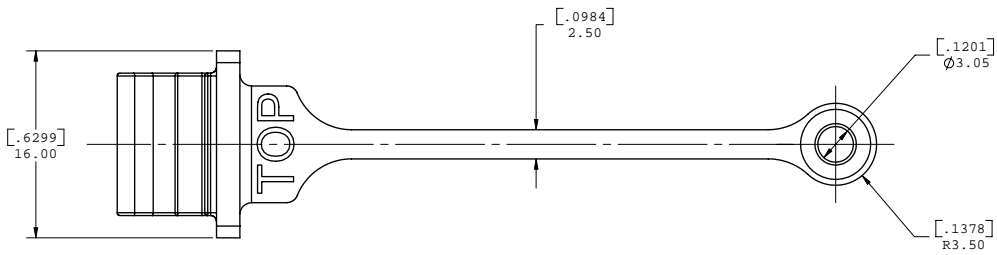
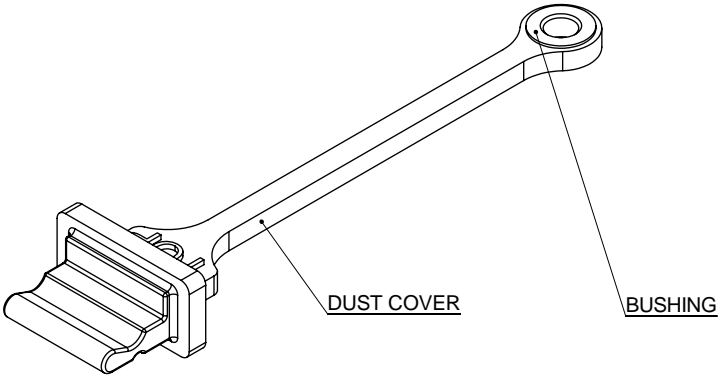

- NOTES:
- MATERIAL:
 - DUST COVER - SILICONE RUBBER, COLOR - SEE TABLE 1.
 - BUSHING - BRASS, NICKEL PLATED.
 - OPERATING TEMPERATURE: -40°C TO +105°C.
 - PART IS ROHS COMPLIANT PER EU DIRECTIVE 2002/95/EC AND AMENDMENTS.

UNLESS OTHERWISE SPECIFIED DIMENSIONS ARE IN MILLIMETER TOLERANCES ARE:		APPROVALS	DATE	Amphenol Canada Corp.		
DECIMALS	ANGLES	DRAWN	APR24/06	TITLE MUSB TYPE A CONNECTOR WITH DUST COVER		
.XX ±.10	±1°	S.SEMENOV	APR24/06			
.X ±.25		DESIGNED				
		S.SEMENOV				
MATERIAL AND FINISH		CHECKED		SIZE	DWG. NO.	REV.
		QA APP'D		C	P-MUSB-2A111-0X4	3
REF.		IE APP'D		SCALE	PROJECT	SHEET
		DWG APP'D		4:1	MUSB	1 OF 3
CODE IDENT. NO.		K.BOUTROS	APR24/06			

DO NOT SCALE DRAWING
 THIS DOCUMENT CONTAINS PROPRIETARY INFORMATION AND SUCH INFORMATION MAY NOT BE DISCLOSED TO OTHERS FOR ANY PURPOSE OR USED FOR MANUFACTURING PURPOSES WITHOUT PERMISSION FROM AMPHENOL CANADA CORP.

REV - DESCRIPT - DATE - APPRVD

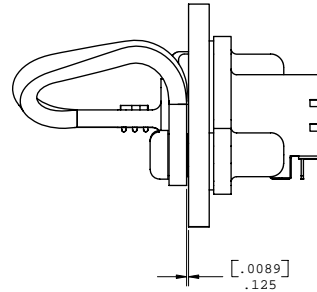
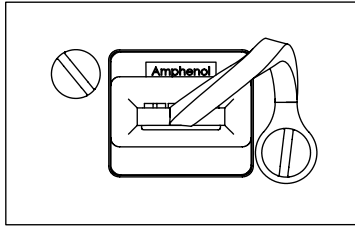

COVER HANDLE WITH MARK "TOP"

DUST COVER

SINGLE MUSB RECEPTACLE

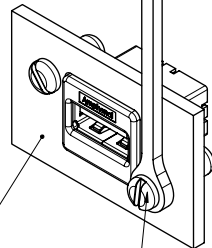
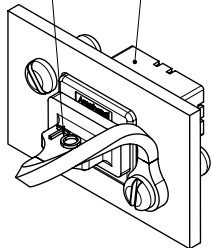

SINGLE MUSB WITH DUST COVER

PANEL
4-40 SCREW
(NOT SUPPLIED)

UNLESS OTHERWISE SPECIFIED DIMENSIONS ARE IN MILLIMETER TOLERANCES ARE: DECIMALS ANGLES .XX ±.10 ±1° .X ±.25	APPROVALS	DATE	Amphenol Canada Corp.		
	DRAWN S.SEMENOV	APR24/06			
	DESIGNED S.SEMENOV	APR24/06	SIZE C	DWG. NO. P-MUSB-2A111-0X4	REV. 3
	MATERIAL AND FINISH	CHECKED	QA APPD	SCALE 1:0.3	PROJECT MUSB
REF.	IE APPD				
CODE IDENT. NO.	DWG APPD K.BOUTROS	APR24/06			

DO NOT SCALE DRAWING
 THIS DOCUMENT CONTAINS PROPRIETARY INFORMATION AND SUCH INFORMATION MAY NOT BE DISCLOSED TO OTHERS FOR ANY PURPOSE
 OR USED FOR MANUFACTURING PURPOSES WITHOUT PERMISSION FROM AMPHENOL CANADA CORP.

REV - DESCRIPT - DATE - APPRVD

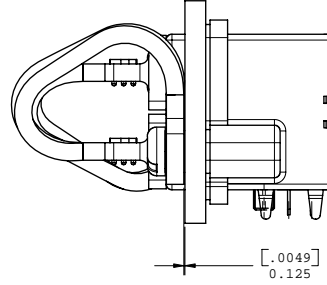
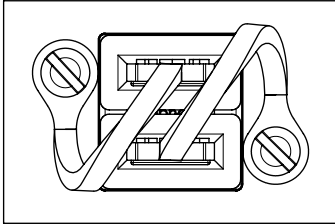

COVER HANDLE WITH MARK "TOP"

DOUBLE MUSB RECEPTACLE

DUST COVER

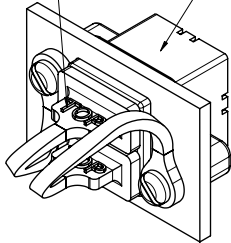

4-40 SCREW
(NOT SUPPLIED)

PANEL

DOUBLE MUSB WITH DUST COVER

UNLESS OTHERWISE SPECIFIED DIMENSIONS ARE IN MILLIMETER TOLERANCES ARE: DECIMALS ANGLES .XX ±.10 ±1° .X ±.25	APPROVALS	DATE	Amphenol Canada Corp.		
	DRAWN S.SEMENOV	APR24/06			
	DESIGNED S.SEMENOV	APR24/06	SIZE C	DWG. NO. P-MUSB-2A111-0X4	REV. 3
	MATERIAL AND FINISH	CHECKED	QA APP'D	SCALE 1:0.3	PROJECT MUSB
REF.	IE APP'D				
CODE IDENT. NO.	DWG APP'D K.BOUTROS	APR24/06			

DO NOT SCALE DRAWING
 THIS DOCUMENT CONTAINS PROPRIETARY INFORMATION AND SUCH INFORMATION MAY NOT BE DISCLOSED TO OTHERS FOR ANY PURPOSE
 OR USED FOR MANUFACTURING PURPOSES WITHOUT PERMISSION FROM AMPHENOL CANADA CORP.