

THIS DRAWING IS UNPUBLISHED. RELEASED FOR PUBLICATION  
 © COPYRIGHT BY TYCO ELECTRONICS CORPORATION. ALL RIGHTS RESERVED.

LOC	DIST	REVISIONS			
P	LTR	DESCRIPTION	DATE	DWN	APVD
DW		SEE SHEET 1.			

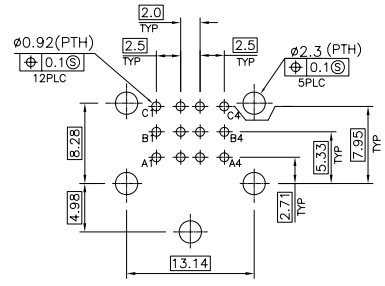

RECOMMENDED PCB LAYOUT  
 TOLERANCE: ±0.05mm

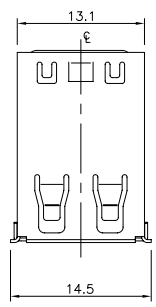
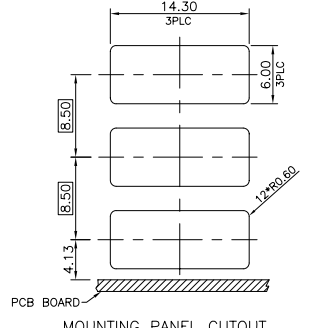

WITHOUT SPRING

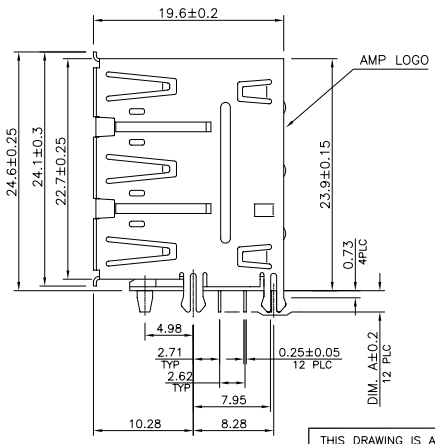
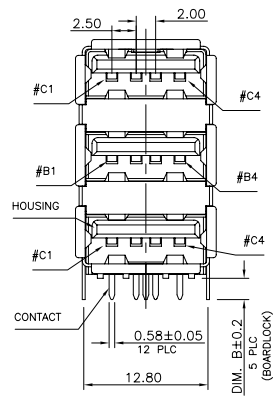

	2.84	2.84	BLACK (426C)	15u"	5-1734309-7
△ OBSOLETE			-BEIGE (726C)	15u"	3-1734309-8
△ OBSOLETE			-BLACK (426C)	15u"	3-1734309-7
△ OBSOLETE			-BEIGE (726C)	30u"	3-1734309-6
			BLACK (426C)	30u"	3-1734309-5
			-BEIGE (726C)	5u"	3-1734309-4
			-BLACK (426C)	5u"	3-1734309-3
			-BEIGE (726C)	G/F	3-1734309-2
			-BLACK (426C)	G/F	3-1734309-1
			-BEIGE (726C)	15u"	1-1734309-8
			BLACK (426C)	15u"	1-1734309-7
			-BEIGE (726C)	30u"	1-1734309-6
			BLACK (426C)	30u"	1-1734309-5
			-BEIGE (726C)	5u"	1-1734309-4
			-BLACK (426C)	5u"	1-1734309-3
			-BEIGE (726C)	G/F	1-1734309-2
			-BLACK (426C)	G/F	1-1734309-1

THIS DRAWING IS A CONTROLLED DOCUMENT.

DIMENSIONS:	TOLERANCES UNLESS OTHERWISE SPECIFIED:	DWN	CHK	APVD	NAME
MM	0 PLC ± -				TRIPLE STACKED USB, A TYPE, RECEPTACLE, R/A, DIP CONN.
	1 PLC ± 0.30				SIZE CAGE CODE DRAWING NO
	2 PLC ± 0.25				A3 00779 C=1734309
	3 PLC ± 0.20				RESTRICTED TO
	4 PLC ± -				
	ANGLES ± 3°				
MATERIAL	FINISH	WEIGHT	9.0 GRAMS	CUSTOMER DRAWING	SCALE SHEET 2 of 3 REV C3

Tyco Electronics Corporation  
 Taipei, Taiwan

THIS DRAWING IS UNPUBLISHED. RELEASED FOR PUBLICATION  
 © COPYRIGHT BY TYCO ELECTRONICS CORPORATION. ALL RIGHTS RESERVED.

LOC	DIST	REVISIONS					
DW		P	LTR	DESCRIPTION	DATE	DWN	APVD
				SEE SHEET 1.			

100PCS/TRAY

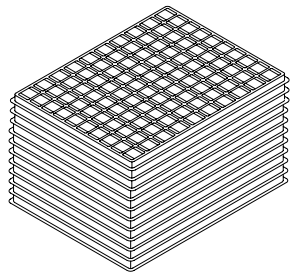
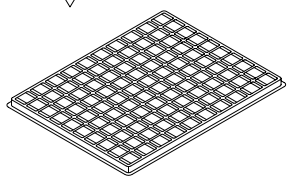

10 LAYERS

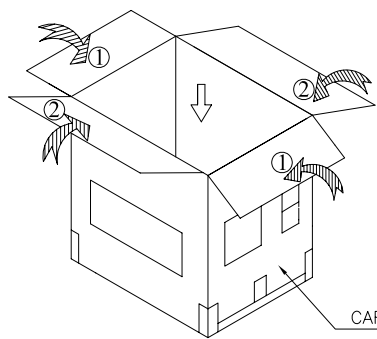

CARTON

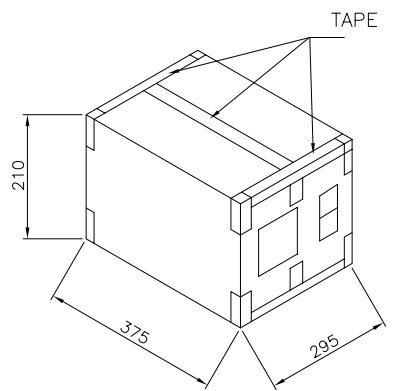

13.0	12.0	100	10	1000
G/W (KG)	N/W (KG)	PCS/TRAY	TRAY/CARTON	PCS/CARTON

Tyco Electronics Corporation  
 Taipei, Taiwan

THIS DRAWING IS A CONTROLLED DOCUMENT.		DWN		
DIMENSIONS: MM		CHK		
		APVD	NAME	
TOLERANCES UNLESS OTHERWISE SPECIFIED: 0 PLC ± - 1 PLC ± - 2 PLC ± - 3 PLC ± - 4 PLC ± - ANGLES ± -		PRODUCT SPEC	TRIPLE STACKED USB, A TYPE, RECEPTACLE, R/A, DIP CONN.	
MATERIAL		APPLICATION SPEC	SIZE	CAGE CODE
FINISH		WEIGHT	A3	00779
		CUSTOMER DRAWING	DRAWING NO	C=1734309
			RESTRICTED TO	
		SCALE	SHEET	REV
			3 of 3	C3