

NUMBER C-1775010
3RD ANGLE PROJECTION
METRIC

NOTE:
RoHS 2002/95/EC COMPLIANT

- MATERIAL:
HOUSING: THERMOPLASTIC HIGH TEMPERATURE, UL 94V-0, COLOR: BLACK.
CONTACT: PHOSPHOR BRONZE, THICKNESS=0.25mm.
SHELL: PHOSPHOR BRONZE, THICKNESS=0.30mm.
- FINISH:
CONTACT: Δ GOLD FLASH IN CONTACT AREA, Δ 30u" MIN. GOLD PLATED IN CONTACT AREA, 100u" MIN. TIN-Cu PLATED ON SOLDER TAILS, 50u" MIN. NICKEL UNDERPLATED ALL OVER.
SHELL: 30u" ~ 90u" NICKEL PLATED OVER ALL.
- PANEL THICKNESS OF 2.67 mm MAXIMUM IF RECEPTACLE CONNECTOR IS MOUNTED BEHIND A PANEL.
- REFLOW SOLDER CAPABLE TO 245°C PER TYCO SPEC 109-201, CONDITION A.

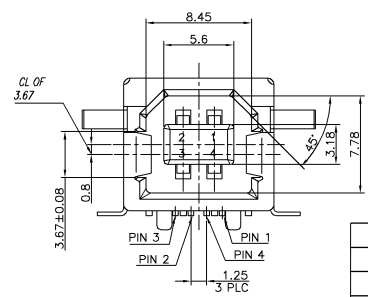
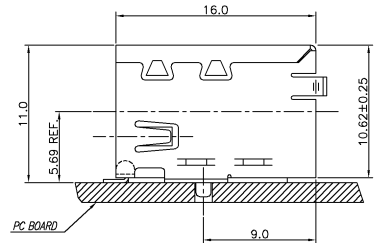
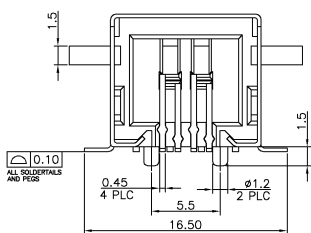
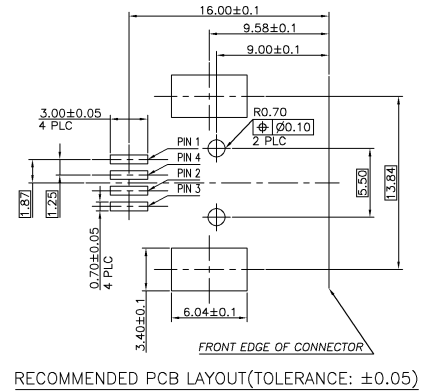
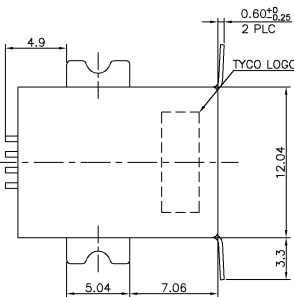

	WHITE	1775010-4
	BLACK	1775010-3
	WHITE	1775010-2
	BLACK	1775010-1
FINISH	HSG. COLOR	PART NUMBER

TOLERANCES UNLESS OTHERWISE SPECIFIED: 0 PLC ± 0.38 1 PLC ± 0.25 2 PLC ± 0.13 3 PLC ± 0.05 ANGLES ±	DWN O. HU 25-APR-2005 CHK S. HOU 25-APR-2005	tyco Electronics TYCO HOLDINGS (BERMUDA) VII LTD, TAIWAN BRANCH
MATERIAL	APVD W.J. KE 25-APR-2005	RECEPTACLE ASS'Y., R/A, SMT TYPE B, 4 POS., USB
SEE NOTE	PRODUCT SPECIFICATION 108-57538	LOC SIZE DRAWING NO DW A ₃ C-1775010
SEE NOTE	QUALIFICATION TEST REPORT 501-57618	REV A
FINISH	WEIGHT	SCALE SHEET -- 1 OF 2

A	CHANGE PLATING SPEC	ECR-05-014060	OH SH	28OCT 2005
O	FIRST RELEASED		OH SH	25APR 2005
LTR	REVISION RECORD	ECN	DWN CHK	DATE

THIS INFORMATION IS CONFIDENTIAL AND IS RELEASED TO YOU ON THE CONDITION THAT NO FURTHER DISCLOSURE IS MADE BY YOU TO OTHER THAN AMP PERSONNEL WITHOUT DIMENSIONS IN MILLIMETERS. DO NOT SCALE PRINT.

NUMBER C-1775010
3RD ANGLE PROJECTION
METRIC

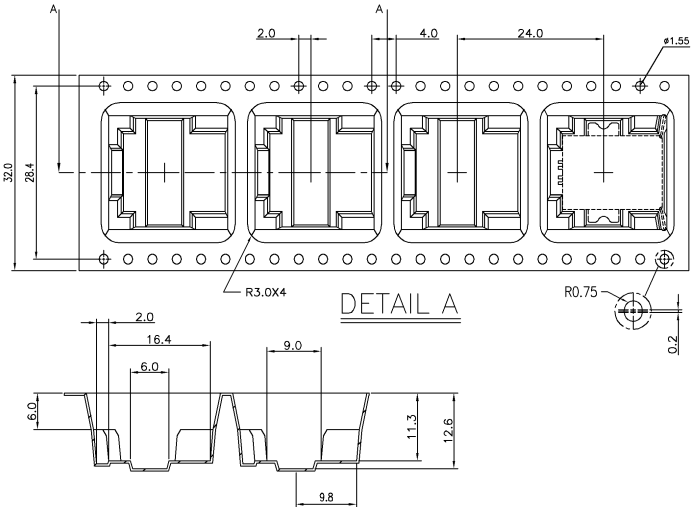

DETAIL A

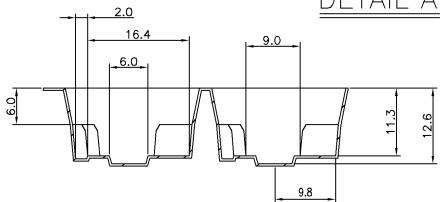

SECTION A-A

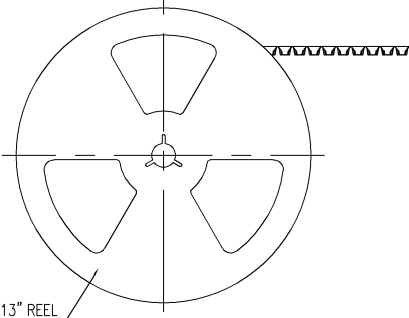
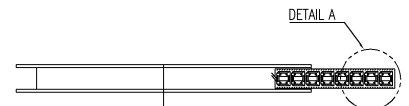
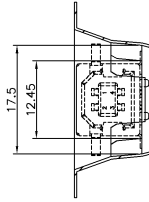

13" REEL

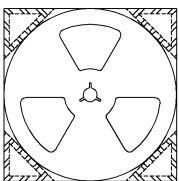
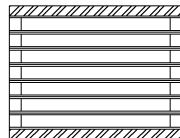
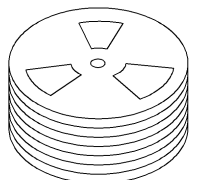

PACKING BOX

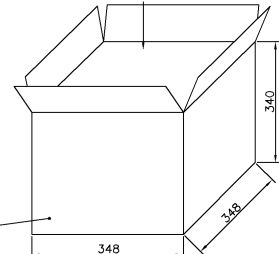

BOX

NOTES:

1. APPLICABLE DOCUMENT : EIA-481-3
2. PACKAGE: 200 PCS/REEL , 8 REEL/BOX
(W.G. : 10.5Kg, N.G. : 9.5Kg)
3. 1 DESICCANT/PACKAGE, 1 REEL/PACKAGE
4. USE THE TAPE TO FIX THE PACKAGE

THIS INFORMATION IS CONFIDENTIAL AND IS RELEASED TO YOU ON THE CONDITION THAT NO FURTHER DISCLOSURE WILL BE MADE BY YOU TO OTHER THAN AMP PERSONNEL WITHOUT THE WRITTEN PERMISSION OF AMP. DIMENSIONS IN MILLIMETERS. DO NOT SCALE PRINT.

PRINT DW
DWN
CHK

SEE SHEET 1.	ECN	DWN/CHK	DATE
LTR	REVISION RECORD		

TOLERANCES UNLESS OTHERWISE SPECIFIED: 0 PLC ± 0.5 1 PLC ± 0.2 2 PLC ± 0.1 3 PLC ± 0.05 ANGLES ± 3°	DWN	O. HU 25-APR-2005	tyco Electronica TYCO HOLDINGS (BERMUDA) VII LTD, TAIWAN BRANCH
	CHK	S. HOU 25-APR-2005	
MATERIAL	APVD	W.J. KE 25-APR-2005	RECEPTACLE ASS'Y., R/A, SMT TYPE B, 4 POS., USB
SEE NOTE	PRODUCT SPECIFICATION	-	
FINISH	QUALIFICATION TEST REPORT	-	
SEE NOTE	WEIGHT	-	
	LOC	SIZE	DRAWING NO
	DW	A ₃	C-1775010
	SCALE		SHEET
	--		2 OF 2

CUSTOMER DRAWING 1