

REV	DATE	DESCRIPTION	BY	CHK	APP
CM 00					
B		REVISED PER 647334-04			

- PARTS MUST COMPLY WITH AMP SOLDERABILITY SPECIFICATION 109-11-3.
- WIRE RANGE: 0.8 - 2.0 mm² [18 - 14 AWG].
- INSULATION RANGE: 2.29 - 3.81 [.090 - .150] DIAMETER
- FITS A 1.57 [.062] THICK P.C. BOARD.

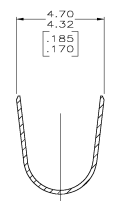

YES	0.0050B [.000200] BRIGHT TIN	0.198 [.0078] PH BRZ	3-647334-1
NO	0.0050B [.000200] BRIGHT TIN-LEAD	0.198 [.0078] PH BRZ	647334-1
LEAD FREE	FINISH	MATERIAL	PART NUMBER

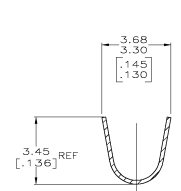
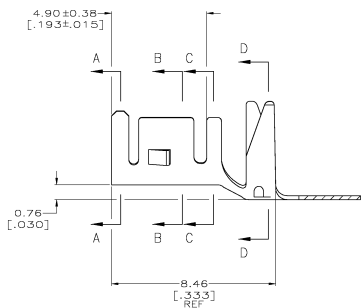
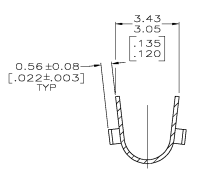
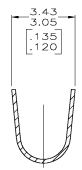
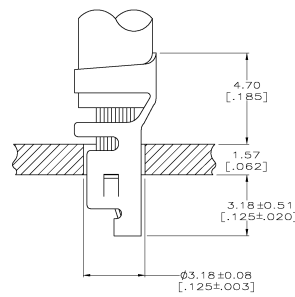
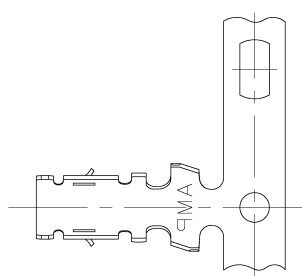

THIS DRAWING IS A CONTROLLED DOCUMENT.		BY: MB/TACKER	DATE: 13001094	Avnet Tyco Electronics Corporation Greensboro, NC 27409
DIMENSIONS: mm DIMENSIONAL TOLERANCES: F: FRACTIONAL D: DECIMAL P: POSITIONAL R: RADII S: SURFACE T: TYPICAL REF: REFERENCE	CHECKED BY: ELLS DATE: 13001094 REVISED BY: WAT DATE: 13001094 REVISED BY: WAT DATE: 13001094	PART NUMBER: 3-647334-1 DESCRIPTION: TERMINAL, MINI AMP-IN™ 2000	SEE: 647334 DRAWING NO: A100779 CUSTOMER DRAWING: 647334	