

MATERIAL NO.	ALTERNATE NO.	WIRE RANGE AWG(mm ²)	HOUSING COLOR
192160011	WT-2218	22-18(.34-.75)	RED
192160010	WT-1814	18-14(.75-2.5)	BLUE
192160009	WT-12	12(4.0)	YELLOW

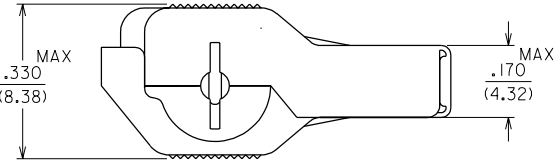

CLOSED POSITION AFTER ASSEMBLY ON WIRE

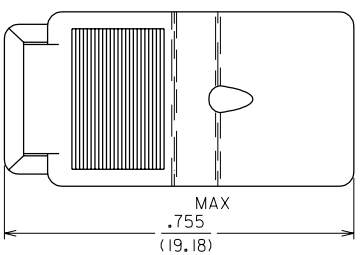
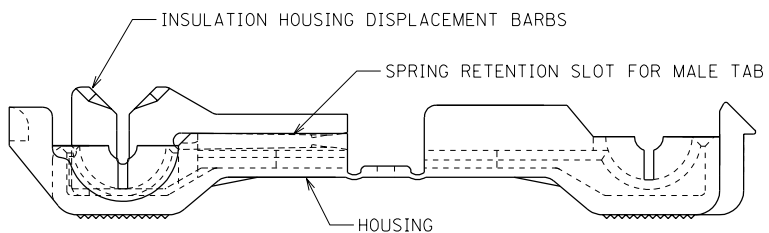

OPEN POSITION PRIOR TO ASSEMBLY ON WIRE

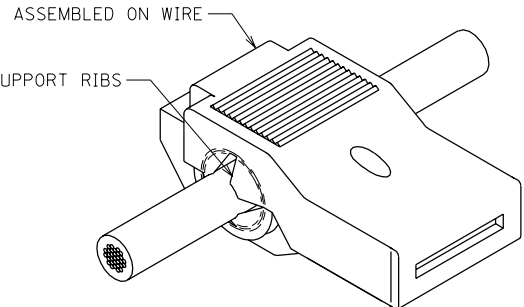
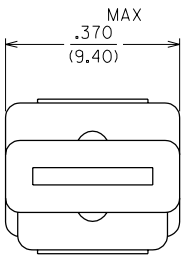

- NOTES:
- MATERIALS
 HOUSING: UNFILLED NYLON UL FLAMMABILITY RATING 94V-2
 COLOR: SEE TABLE
 TERMINAL: COPPER ALLOY
 - FINISH
 TERMINAL: TIN

B	VOIDS DWG. WT-CD ETC2000-0001 HEB 99/7/2
A	SEE ECN# 1137 09/08/94 RCM
LTR.	REVISIONS

CUSTOMER DRAWING

DIMENSIONS SHOWN (METRIC) INCH UNLESS OTHERWISE SPECIFIED TOLERANCES: ANGULAR ± 1/2°		REVISE ONLY ON CAD SYSTEM													
<table border="1"> <thead> <tr> <th></th> <th>INCH</th> <th>METRIC</th> </tr> </thead> <tbody> <tr> <td>3 PLACE</td> <td>± .005</td> <td>± ---</td> </tr> <tr> <td>2 PLACE</td> <td>± .01</td> <td>± 0.13</td> </tr> <tr> <td>1 PLACE</td> <td>± ---</td> <td>± 0.25</td> </tr> </tbody> </table>			INCH	METRIC	3 PLACE	± .005	± ---	2 PLACE	± .01	± 0.13	1 PLACE	± ---	± 0.25	TITLE WIRE TAP MULTIMATE	
	INCH	METRIC													
3 PLACE	± .005	± ---													
2 PLACE	± .01	± 0.13													
1 PLACE	± ---	± 0.25													
DRAFT WHERE APPLICABLE MUST REMAIN WITHIN DIMENSIONS		SHEET NO. DATE 1 OF 1 09/07/94													
DRWG. BY: RCM APP'D. BY: FP		ETC INC. PINELLAS PARK, FLA. 33701 U.S.A. PART NO. SEE TABLE DRWG. NO. SD-19216-001													
CHK'D. BY: JM SCALE: 5:1		THIS DRAWING CONTAINS INFORMATION THAT IS PROPRIETARY TO ETC INC. AND SHOULD NOT BE USED WITHOUT WRITTEN PERMISSION.													



ENGINEERING SPECIFICATION

INSTALLATION INSTRUCTION SHEETS

1.0 SCOPE

This specification consists of installation instructions for wire taps.

2.0 PURPOSE

To clarify installation instructions for end users of wire taps.

3.0 REFERENCE MATERIAL NUMBERS

See page 2 for the actual instruction sheets. This page can be used as originals when cut into fourths.

4.0 DEFINITIONS

Not applicable.

5.0 PROCEDURES

Place one (1) instruction sheet (1/4 of next sheet) in the smallest unit container.

6.0 IMPLEMENTATION

August 10, 2010

REVISION: A	ECR/ECN INFORMATION: EC No: WNA2011-0136 DATE: 2010 / 08 / 10	TITLE: WIRE TAP INSTALLATION INSTRUCTIONS 22 THROUGH 12 AWG WIRE	SHEET No. 1 of 2
DOCUMENT NUMBER: SD-19216-008	CREATED / REVISED BY: ETHRODAHL	CHECKED BY: JMACNEIL	APPROVED BY: JMACNEIL

TEMPLATE FILENAME: ENGINEERING_SPEC[SIZE_A](V.1).DOC

Assembly Instructions for Wire Tap Splices

Engineering P/N	Wire Range
WT-2218	22-18 AWG
WT-1814	18-14 AWG
WT-12	12 AWG

For use with only stranded copper wire and copper alloy tabs 600V, 105°C

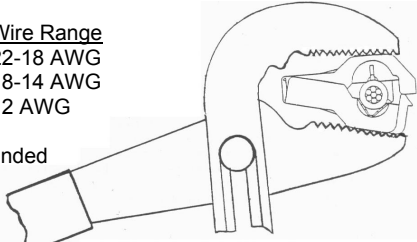

Fig.1

For 22-16 AWG wires, refer to Fig. 1

1. Insert the correct size wire properly into the connector.
2. Position the connector into the tongue-and-groove pliers as shown and carefully squeeze until the latch engages.

For 14-12 AWG wires, refer to Fig. 2, 3, and 1.

1. Bend the wire support membranes outward with wire (Fig.2)
2. Place the correct size wire into the nest of the metal and gently squeeze the wire into position with tongue-and-groove pliers without distorting (flattening) the wire insulation (Fig.3).
3. Position the connector into the tongue-and-groove pliers as shown and carefully squeeze until the latch engages (Fig.1).

Fig. 2

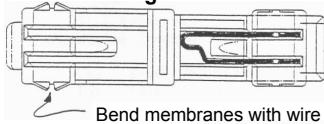

Bend membranes with wire

Fig. 3

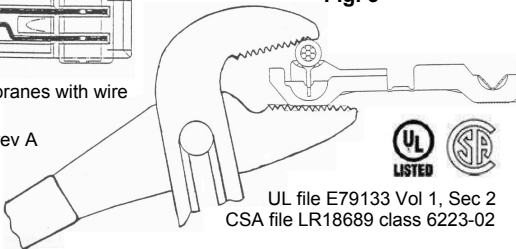

Lit p/n 192160127, rev A

4650 62nd Avenue N
Pinellas Park, FL
33781



UL file E79133 Vol 1, Sec 2
CSA file LR18689 class 6223-02

Assembly Instructions for Wire Tap Splices

Engineering P/N	Wire Range
WT-2218	22-18 AWG
WT-1814	18-14 AWG
WT-12	12 AWG

For use with only stranded copper wire and copper alloy tabs 600V, 105°C

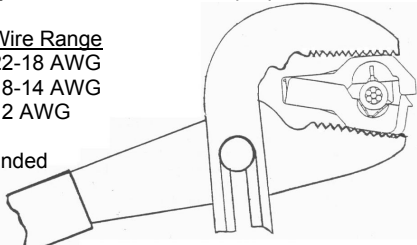

Fig.1

For 22-16 AWG wires, refer to Fig. 1

1. Insert the correct size wire properly into the connector.
2. Position the connector into the tongue-and-groove pliers as shown and carefully squeeze until the latch engages.

For 14-12 AWG wires, refer to Fig. 2, 3, and 1.

1. Bend the wire support membranes outward with wire (Fig.2)
2. Place the correct size wire into the nest of the metal and gently squeeze the wire into position with tongue-and-groove pliers without distorting (flattening) the wire insulation (Fig.3).
3. Position the connector into the tongue-and-groove pliers as shown and carefully squeeze until the latch engages (Fig.1).

Fig. 2

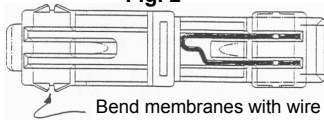

Bend membranes with wire

Fig. 3

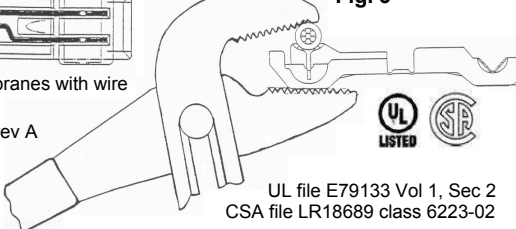

Lit p/n 192160127, rev A

4650 62nd Avenue N
Pinellas Park, FL
33781



UL file E79133 Vol 1, Sec 2
CSA file LR18689 class 6223-02

Assembly Instructions for Wire Tap Splices

Engineering P/N	Wire Range
WT-2218	22-18 AWG
WT-1814	18-14 AWG
WT-12	12 AWG

For use with only stranded copper wire and copper alloy tabs 600V, 105°C

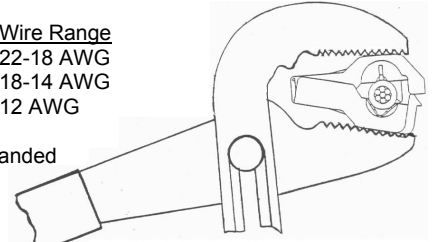

Fig.1

For 22-16 AWG wires, refer to Fig. 1

1. Insert the correct size wire properly into the connector.
2. Position the connector into the tongue-and-groove pliers as shown and carefully squeeze until the latch engages.

For 14-12 AWG wires, refer to Fig. 2, 3, and 1.

1. Bend the wire support membranes outward with wire (Fig.2)
2. Place the correct size wire into the nest of the metal and gently squeeze the wire into position with tongue-and-groove pliers without distorting (flattening) the wire insulation (Fig.3).
3. Position the connector into the tongue-and-groove pliers as shown and carefully squeeze until the latch engages (Fig.1).

Fig. 2

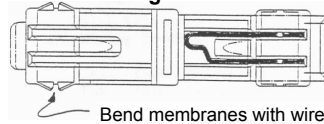

Bend membranes with wire

Fig. 3

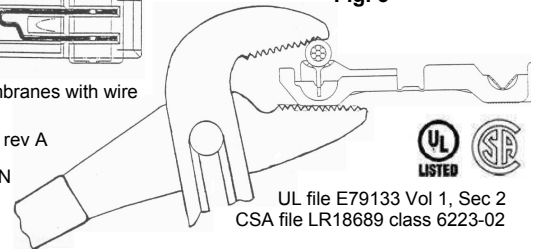

Lit p/n 192160127, rev A

4650 62nd Avenue N
Pinellas Park, FL
33781



UL file E79133 Vol 1, Sec 2
CSA file LR18689 class 6223-02

Assembly Instructions for Wire Tap Splices

Engineering P/N	Wire Range
WT-2218	22-18 AWG
WT-1814	18-14 AWG
WT-12	12 AWG

For use with only stranded copper wire and copper alloy tabs 600V, 105°C

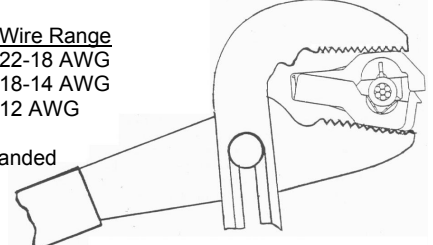

Fig.1

For 22-16 AWG wires, refer to Fig. 1

1. Insert the correct size wire properly into the connector.
2. Position the connector into the tongue-and-groove pliers as shown and carefully squeeze until the latch engages.

For 14-12 AWG wires, refer to Fig. 2, 3, and 1.

1. Bend the wire support membranes outward with wire (Fig.2)
2. Place the correct size wire into the nest of the metal and gently squeeze the wire into position with tongue-and-groove pliers without distorting (flattening) the wire insulation (Fig.3).
3. Position the connector into the tongue-and-groove pliers as shown and carefully squeeze until the latch engages (Fig.1).

Fig. 2

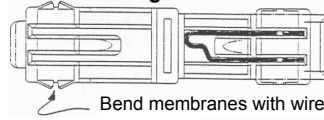

Bend membranes with wire

Fig. 3

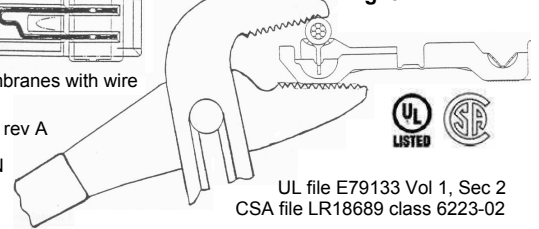

Lit p/n 192160127, rev A

4650 62nd Avenue N
Pinellas Park, FL
33781



UL file E79133 Vol 1, Sec 2
CSA file LR18689 class 6223-02