

REV	DATE	DESCRIPTION	BY	CHK	APP
B		REV PER ECR-07-018790	HANDEL	JR	TM

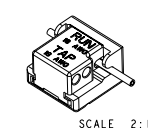

1811027-1

1811027-2

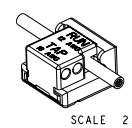
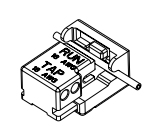
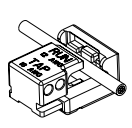
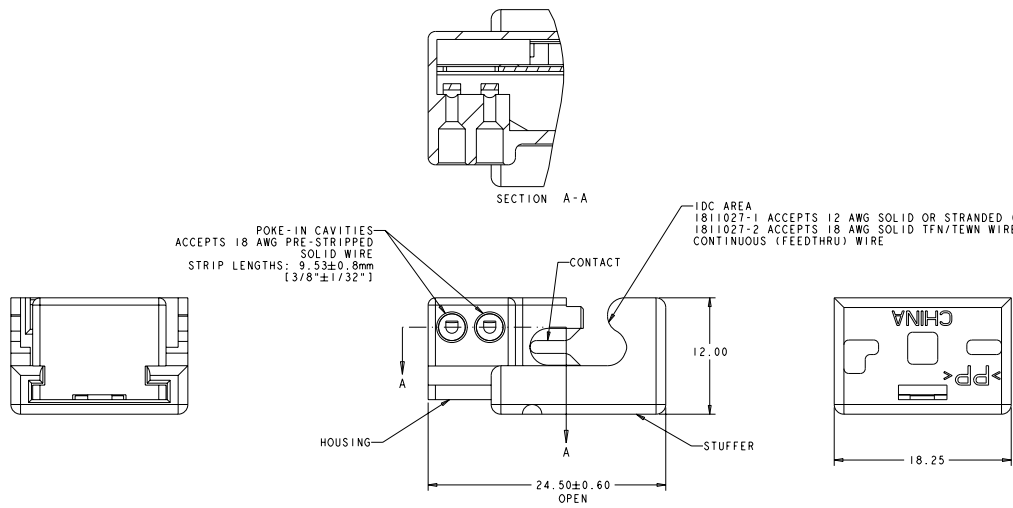
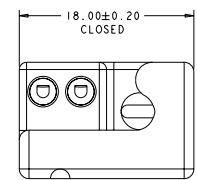
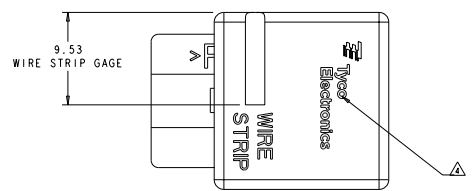

TERMINATED DETAIL

- △ MATERIAL:  
 HOUSING: THERMOPLASTIC, COLOR: SEE TABLE  
 STUFFER: THERMOPLASTIC, COLOR: SEE TABLE  
 CONTACT: COPPER ALLOY, 0.50 THICK
- △ FINISH:  
 CONTACT: TIN PLATE
- 3. PRODUCT SPECIFICATION: 108-2219  
 APPLICATION SPECIFICATION: 114-13151
- △ THE LOGO MAY BE JUST "TYCO" UNTIL COMPONENTS ARE CONVERTED.

CONNECTOR COLOR	FEED THRU WIRE SIZE	PART NUMBER
BLUE	18 AWG	1811027-2
BROWN	12 AWG	1811027-1

DATE: 28-OCT-04 BY: ALLISON CHECKED: 14-NOV-07 TITLE: 108-2219 PROJECT CODE: 114-13151 MATERIAL: CUSTOMER DRAWING	Tyco Electronics Harrisburg, PA 17105-3600 ASSEMBLY, WIRE SPLICE IDC / POKE-IN SCALE CODE: 5:1 PART NUMBER: 1811027-2 SHEET: 1 OF 1
--	---