

PC SCREW TERMINALS

These easy-to-mount, multipurpose screw type terminals are a practical, low-cost alternative to PC screw type edge connectors, barrier blocks, terminal boards and terminal strips. Steadfast and easy to install, will accommodate solid or stranded wire, crimp type terminals or lugs. Multi-placement of these low-profile terminals make them ideally suited for high density packaging. Supplied unassembled or with screw installed and captivated.

PRINCIPAL FEATURES

- Low profile
- Stable, no-rock design with exclusive anti-rotational feature
- Easily mounts with four legs into pre-drilled or punched holes
- Accepts 14-22 AWG solid or stranded wire, crimp type terminals or lugs
- Ideally suited for high-density packaging
- Available in horizontal or vertical mounting
- Space-saving and time saving
- Easy accessibility for PC board testing
- Binding screw is positioned above board level to avoid wicking during wave soldering
- Terminals are made of Brass with Tin Plate
- Supplied with a combination drive 6-32 binding head screw
- Color coded screws available (add color screw suffix to Cat. No.)

CAT. NO. COLOR SUFFIX
 Ex: XXXX -X

COLOR SELECTION:
 Select desired screw terminal and add color suffix to the screw terminal Cat. No.

HEAD COLOR	SUFFIX
RED	-2
BLACK	-3
WHITE	-4
BLUE	-5
GREEN	-6
YELLOW	-7
NICKEL	none

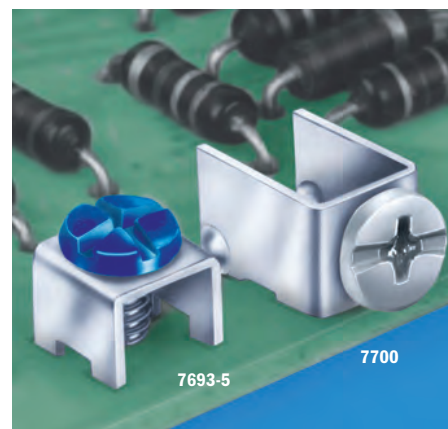

SCREW TERMINALS



7692-2
SNAP-IN PC MOUNT

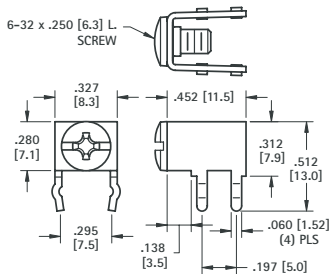

- CAT. NO. 7779** (Supplied Less Screw)
- CAT. NO. 7690** (Screw Supplied Unassembled)
- CAT. NO. 7692** (Screw Installed & Captivated)

HORIZONTAL TYPE

SPECIFICATIONS
Rated: 15 Amps
Terminal: .032 (.81) thick Brass, Tin Plate
Binding Head Screw: Brass, Nickel Plate

Mounting Detail

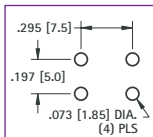

Color coded screws available (add color screw suffix to Cat. No.)

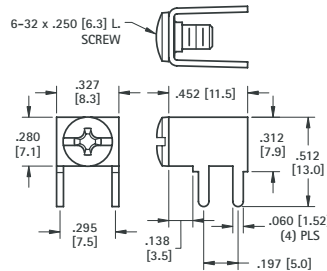

7700-3
PC MOUNT

- CAT. NO. 7781** (Supplied Less Screw)
- CAT. NO. 8190** (Screw Supplied Unassembled)
- CAT. NO. 7700** (Screw Installed & Captivated)

VERTICAL TYPE

SPECIFICATIONS
Rated: 15 Amps
Terminal: .032 (.81) thick Brass, Tin Plate
Binding Head Screw: Brass, Nickel Plate

Mounting Detail

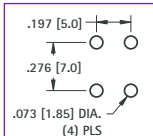

Color coded screws available (add color screw suffix to Cat. No.)

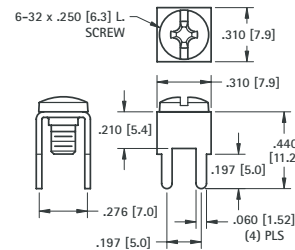

7701
PC MOUNT

- CAT. NO. 7782** (Supplied Less Screw)
- CAT. NO. 8191** (Screw Supplied Unassembled)
- CAT. NO. 7701** (Screw Installed & Captivated)



7693-4
SNAP-IN PC MOUNT

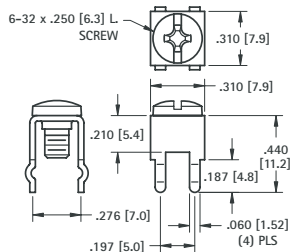

- CAT. NO. 7780** (Supplied Less Screw)
- CAT. NO. 7691** (Screw Supplied Unassembled)
- CAT. NO. 7693** (Screw Installed & Captivated)

EXTENDED

SPECIFICATIONS
Rated: 15 Amps
Terminal: .032 (.81) thick Brass, Tin Plate
Binding Head Screw: Brass, Nickel Plate

Color coded screws available (add color screw suffix to Cat. No.)

Mounting Detail

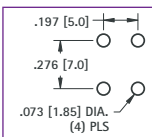

- CAT. NO. 7789** (Supplied Less Screw)
- CAT. NO. 7697** (Screw Supplied Unassembled)
- CAT. NO. 7699** (Screw Installed & Captivated)

45°

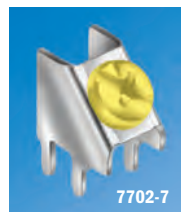
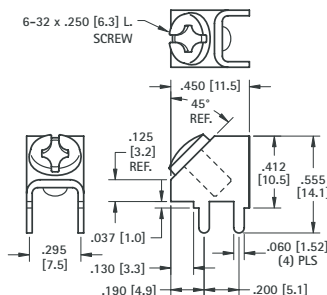

7702-7
PC MOUNT

Mounting Detail

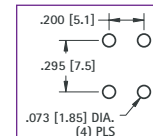

- CAT. NO. 7783** (Supplied Less Screw)
- CAT. NO. 8189** (Screw Supplied Unassembled)
- CAT. NO. 7702** (Screw Installed & Captivated)