

RoHS
Ready 



FASTON Terminals Insulated and Uninsulated

 **Tyco Electronics**
Our commitment. Your advantage.

Table of Contents

FASTON Terminals
 Introduction 3
 Information 4
 Product Information and Crimp Styles 5, 6
 Receptacle Lines 7
 Product Specifications 8-10

FASTON Receptacles
 Introduction 11
 312 Series 12
 250 Series 12-20
 205 Series 21
 187 Series 22-26
 125 Series 27
 110 Series 27-29
 AMPLIVAR Receptacles (for use with Magnet Wire) 30, 31
 Miscellaneous Tab Receptacles 32

FASTON Tabs
 312 and 250 Series (High Temperature) 33
 250 through .060 Series 34, 35
 AMPLIVAR Tabs (for use with Magnet Wire) 36
 312 through 187 Series 37-40
 Test Tabs 41, 42
 FASTON Tab Adapters 43

FASTON Printed Circuit Board Tabs and Receptacles
 Introduction 44
 250 Series through 110 Series 45-50
 Right Angle Printed Circuit Board Tabs 49, 50
 RAST 5 Tab Header Assembly 51, 52

FASTON Housings 53-61

FASTIN-FASTON Product Line 62-70

FASTON Terminals Strip/Loose Piece Cross Reference 71

Positive Lock Receptacles
 Introduction 72
 Mark I Series 73, 74
 Mark II Series 75-80
 Mark III Series 81, 82
 110 Series 83

Positive Lock RAST 5 Connector System 84, 85

Ultra-Fast Fully Insulated FASTON Receptacles and Tabs 86-89

Ultra-Fast Plus Fully Insulated FASTON Receptacles and Tabs 90, 91

Ultra-Pod Fully Insulated FASTON Receptacles and Tabs 92-95

PIDG FASTON Receptacles and Tabs 96-100

Application Tooling 101-107

Technical Documents 108

Part Number Index 109-112

Disclaimer

While Tyco Electronics Corporation and its affiliates referenced herein ("Tyco Electronics") have made every reasonable effort to ensure the accuracy of the information in this catalog, Tyco Electronics does not guarantee that it is error-free, nor does Tyco Electronics make any other representation, warranty or guarantee that the information is accurate, correct, reliable or current.

Tyco Electronics reserves the right to make any adjustments to the information contained herein at any time without notice. Tyco Electronics expressly disclaims all implied warranties regarding the information contained herein, including, but not limited to, any implied warranties of merchantability or fitness for a particular purpose. Tyco Electronics' only obligations are those in the Tyco Electronics Standard Terms and Conditions of Sale, and in no case will Tyco Electronics be responsible for any incidental, indirect, or consequential damages arising from the sale, resale, use, or misuse of its products. Users should independently evaluate the suitability of, and test each product for, their application.

The dimensions, specifications, designs, construction, materials and processes in this catalog are for reference purposes only and are subject to change without notice. Please consult Tyco Electronics for the most current product information.

The export of certain Tyco Electronics products is restricted by the Arms Export Control Act (Title 22, U.S.C. Sec 2751, et seq.) or the Export Administration Act of 1979, as amended (Title 50, U.S.C., App. 2401 et seq.). Orders may be subject to export approval by the U.S. Government. Buyer must comply with all applicable export laws of all applicable jurisdictions.

© Copyright 2007, 2006, 2004, 1998, 1990, 1989, 1979, 1977, 1974, 1970, 1966 and 1963 by Tyco Electronics Corporation. All International Rights Reserved.

AMP, AMPIP, AMPLIVAR, AMP MONO-SHAPE, AMP-O-LECTRIC, AMPOMATOR, AMP-TAPETRONIC, CERTI-CRIMP, Comp-U-Sertor, EDGE, FASTIN-FASTON, FASTON, PIDG, PRO-CRIMPER, TETRA-CRIMP, TE LOGO and TYCO ELECTRONICS are trademarks.

Other products, logos, and company names mentioned herein may be trademarks of their respective owners.

See inside back cover for Global Contacts and phone numbers.

FASTON Products Meet or Exceed Industry Standards UL-310 Listed UL file No. E66717.



Recognized under the Component Program of Underwriters Laboratories Inc. Electrical UL File No. E28476, and E13288



CSA certified File No. LR 7189A-509



■ **Produced under a Quality Management System certified to ISO 9001**

A copy of the certificate is available upon request.



Introduction

The FASTON Terminal product line includes Ultra-Fast, Ultra-Fast Plus and Ultra-Pod fully insulated FASTON terminals, as well as Positive Lock receptacles consisting of receptacles, tabs and splices specifically designed for quick connections. FASTON products are grouped according to tab width dimensions in series "312", "250", "205", "187", "125" and "110". This product line offers speed of application, uniform reliability and low per line cost. These advantages have made FASTON products the number one choice of many leaders in the appliance and automotive industries. Other industries for FASTON products are computer and peripheral equipment,

industrial controllers, test equipment and telecommunications equipment manufacturers.

Speed of application is achieved through the use of application tools for which a complete line has been developed specifically for these terminals. See Application Tooling Section in back of catalog for general information. Specific rates and capabilities can be obtained by contacting Technical Support at the numbers listed below.

Precisely controlled crimping specifications for each FASTON terminal allow all connections to perform as specified. Low per line costs are derived from low initial product costs, high application speeds, and plug-in

assemblies of the finished termination. While it's true that we have over fifty years of proven reliability behind our product, we are not content to rest. We are constantly striving to introduce new and improved products to add to our quick connect family. Positive Lock RAST 5 Connectors, Ultra-Pod Positive Lock, C-Crimp flags and our ever expanding offering of Printed Circuit Board tabs and receptacles are examples of recent additions to the FASTON product family.

It is our commitment to innovation and continuous improvement that allows the FASTON terminal product line to remain the leader in the industry.

Need more information?

Call Technical Support at the numbers listed in the footer of every page.

Technical Support is staffed with specialists well versed in all Tyco Electronics products. They can provide you with:

- Technical Support
- Catalogs
- Technical Documents
- Product Samples
- Tyco Electronics Authorized Distributor Locations

Restriction on the use of Hazardous Substances (RoHS)

At Tyco Electronics, we're ready to support your RoHS requirements. We've assessed more than 1.5 million end items/components for RoHS compliance, and issued new part numbers where any change was required to eliminate the restricted materials. Part numbers in this catalog are identified as:

RoHS Compliant — Part numbers in this catalog are RoHS Compliant, unless marked otherwise. These products comply with European Union Directive 2002/95/EC as amended 1 January 2006 that restricts the use of lead, mercury, cadmium, hexavalent chromium, PBB, and PBDE in certain electrical and electronic products sold into the EU as of 1 July 2006.

NOTE: For purposes of this Catalog, included within the definition of RoHS Compliant are products that are clearly "Out of Scope" of the RoHS Directive such as hand tools and other non-electrical accessories.

NOTE: Information regarding RoHS compliance is provided based on reasonable inquiry of our suppliers and represents our current actual knowledge based on the information provided by our suppliers. This information is subject to change. For latest compliance status, refer to our website referenced at right.

Getting the Information You Need

Our comprehensive on-line RoHS Customer Support Center provides a forum to answer your questions and support your RoHS needs. A RoHS FAQ (Frequently Asked Questions) is available with links to more detailed information. You can also submit RoHS questions and receive a response within 24 hours during a normal work week. The Support Center also provides:

- Cross-Reference from Non-compliant to Compliant Products
- Ability to browse RoHS Compliant Products in our on-line catalog
- Downloadable Technical Data Customer Information Presentation
- More detailed information regarding the definitions used above
- So whatever your questions when it comes to RoHS, we have the answers at www.tycoelectronics.com/leadfree



Introduction (Continued)

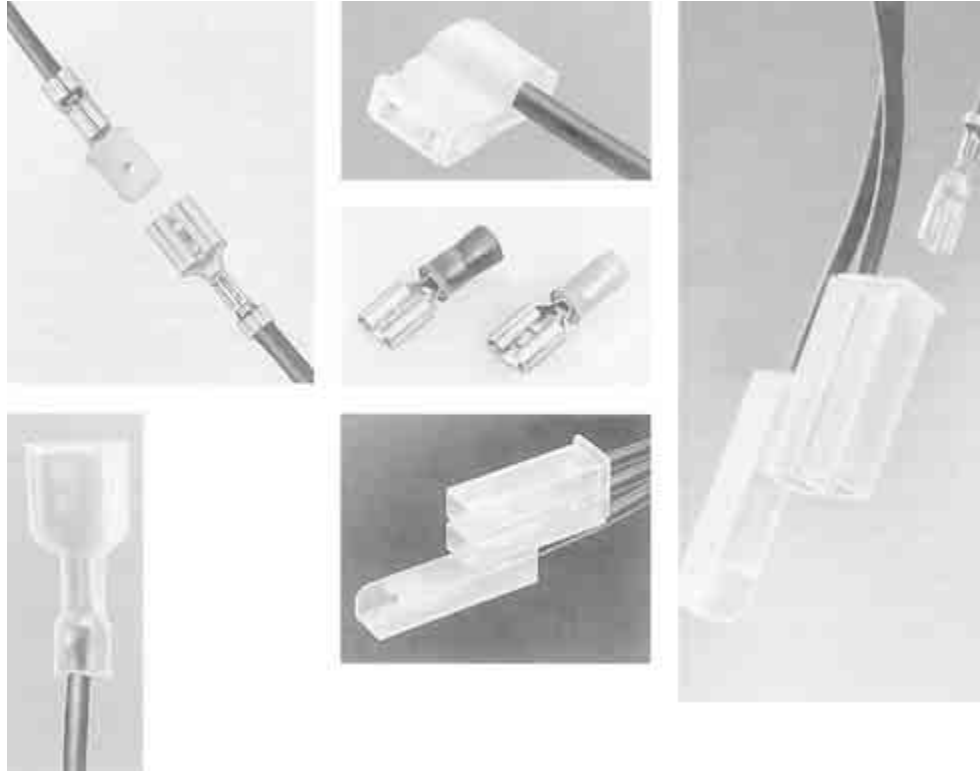

Tyco Electronics has made great effort to prepare this catalog as accurately as possible. All information contained herein, including illustrations, specifications and dimensions, is believed to be reliable as of the date of publication. However, errors may occur and product information can change quickly. Circumstances may require that adjustments to the information be made after printing. Tyco Electronics reserves the right to make any such adjustments at any time without notice.

Current sales drawings and specifications are available upon request. Tyco Electronics makes no claims or warranties, express or implied, as to the application of these products or their suitability or fitness for any particular purpose. Accordingly, it is recommended that each user independently test and evaluate products for their intended use.

We welcome your comments about the catalog so we can continue to improve the quality of the technical information we provide about our products.

The Tyco Electronics family of quick connects provides the right product for most applications. All styles provide features to enhance quality and reliability of interconnections. All lines meet the applicable requirements of UL-310. The FASTON product line consists of two mating parts—the receptacle and the tab. Receptacles are available in both straight and flag configurations and come in a variety of sizes. They are designed numerically by a series number that corresponds to the width of the mating tab. There are six series of both straight-on and flag receptacles “312”, “250”, “205”, “187”, “125”, and “110”.

The Products

Product Styles

Flag Receptacles



The Flag Receptacle is a reliable termination for those applications where space is a critical factor. Connection with mating tab is at right-angle to axis of conductor. Typical installations include bussing switches in back-splashes of ranges or in similar heavy duty applications.

Straight Receptacles



Straight receptacles are made with or without insulation support. Insulation diameters of .040-.230 are accommodated by the insulation support receptacle. Another feature of this type is a step-down insulation support barrel to compensate for insulation thickness to maintain axial alignment of the conductor strands. Over-insertion of shoulderless tabs is prevented by tapering walls at the rear of the receptacle.

Wire Crimp Tabs

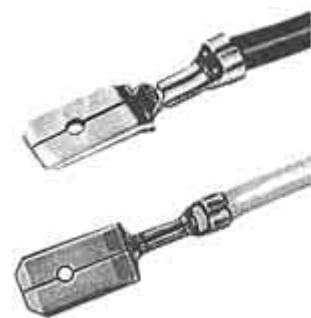

The wire crimp tabs are designed for line splices and other special applications. They can be applied to 22-14 AWG wire with “F” crimp termination and include insulation support. The wire crimp tab is also available with AMPLIVAR connector type serrations for magnet wire applications.

Printed Circuit Board Tabs

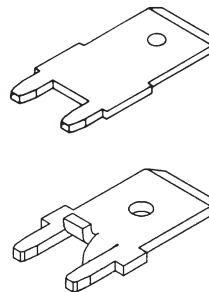

These tabs are designed to be inserted into holes in PC Boards, then attached permanently during the soldering operation. They can be hand inserted or machine inserted using Tyco Electronics application equipment.

Board Mount Tabs



Board mount tabs are available in all the series. These tabs are mounted using rivets or screws through stud holes. They are available in single 90 degree configurations, straight and angled versions, dual versions (90, 45 degree and Straight), weld tab versions and special configurations.

Locking Action and Contact Area



Since corrosion and oxidation tend to affect performance by cutting down contact areas and increasing the constriction resistance of connections, maximum contact areas are incorporated in the design of FASTON receptacles and tabs. The design also includes a dimple detent and web section which not only increases contact surfaces but also locks in the tab and receptacles at proper insertion depth for firm retention.

The Products (Continued)

Crimp Styles

The "F" Crimp

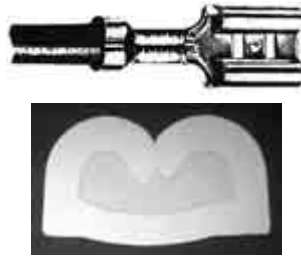

The standard crimp on all straight and certain flag type FASTON Terminals is the "F" crimp. Experience over widespread segments of the industry has proved this crimp the most effective way of providing stable electrical and mechanical performance. Applied with match-mated tooling, the "F" crimp offers the optimum combination of mechanical strength and electrical conductivity. This method of termination also provides maximum resistance to vibration and corrosion.

Tab-Lok Crimp for FASTON Flag Terminals



In making this crimp, a tab on the wire barrel, is inserted through a slot in the terminal itself. The crimping action is continued by flattening the tab between two lances which in turn are locked over the tab. The wire connection is locked in to offer reliable electrical and mechanical performance. This receptacle design includes a lance-tab stop at its rear to avoid over-insertion of shoulderless tabs.

The "C" Crimp

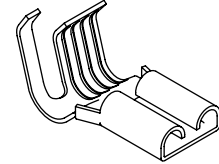

A new style crimp with wrap-around barrel design with the standard, reliable FASTON receptacle. The special barrel design provides a maximum contact area and when applied with the matched tooling, will provide reliable electrical and mechanical performance at a minimum terminal profile.

Available in the 187 series for both .020 and .032 thick tabs, brass or phosphorous bronze base materials in either plain or tin plated.

TETRA-CRIMP Terminal Crimp



This reliable crimp is used on PIDG FASTON Receptacles. The terminals feature nylon insulation fitted over a copper support sleeve. PIDG FASTON Receptacles are of the straight variety only, and are available in strip form or tape mounted for high-speed application with automatic crimping machines, or in loose piece form for application with hand tools.

Corrugated Keystone Barrel Serrations

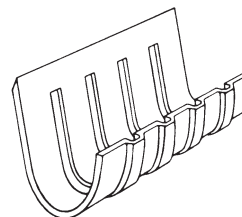

This special terminal wire barrel design provides maximum contact area between terminal and bare conductor. During the crimping process, bulk deformation forces the conductor into these serration channels creating a scrubbing action on oxide film on the wire. The termination is also resistant to vibration and shock.

AMPLIVAR Terminal Crimp

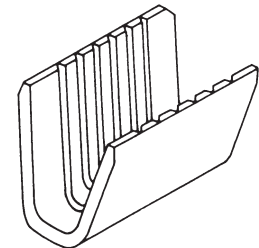

This crimp is designed for reliable, high-speed connection of magnet wire. The conductor(s) is automatically multiple-ring stripped and forced into sharp serrations with a single precision-controlled solderless crimp. This operation produces a strong, air-tight termination that is as resistant to corrosion and many other environmental effects as the insulated conductor itself.

Receptacle Product Lines

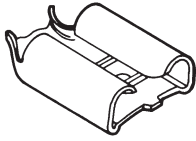

Premier

The receptacle configuration of the Premier line, with its resilient rolls and double slot bottom allows maximum compliancy while retaining the high normal forces necessary to provide good wiping action and highly reliable interface. The basis to the resiliency of the Premier line receptacle is in the *thermal stress relieving* each terminal receives. This extra processing step relieves the residual stresses the stamping process imparts and allows the receptacle to resist the effects of over-stressing, while retaining the normal forces which provide good cleaning action and low, stable resistance under a variety of operating conditions.

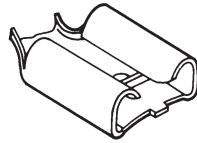

Budget

The Budget line receptacles are constructed similar to the Premier line and are easily distinguished by the single slot. The single most important difference between the Budget line and Premier line is that the Budget line does not receive the special processing of the Premier line. In addition, in the .250 series, the Budget line receptacles are constructed of lighter .016 brass.



Economy

The Economy line receptacle is separated from its counterparts by the large lead-in provided by its flared, relatively low, roll construction. This roll construction and lead-in, with tab contact coming on the mill finish of the brass instead of a profiled edge, makes for lower average insertion forces at relatively high normal forces.

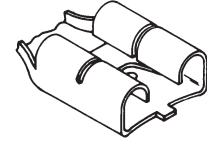

Low Insertion Force

The Low Insertion Force (LIF) type receptacle offers lower insertion forces than the other receptacle styles thru the unique design features of a two-stage receptacle and a cantilever mounted locking dimple.

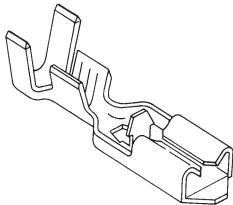

Positive Lock

Positive Lock receptacles are designed with reduced mating forces, and a large locking dimple on a flexible latch. This locking feature acknowledges proper mating with an audible "snap" of the dimple into the mating hole. This enhances safety and reliability of the mated pair for isolated and hard to reach areas. Until the release latch is depressed manually the receptacle cannot be removed.

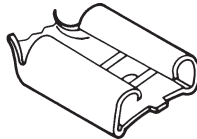

Hermetic

The Hermetic receptacle is a Premier line receptacle which has been designed to mate with the posted header tabs in hermetic motor applications. This receptacle provides all the features and benefits of the Premier line.

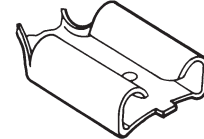

Moldable

The moldable receptacle is available in many of the same configurations shown and is produced without slots or openings in the floor of the receptacle to facilitate over-molding.

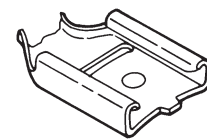

Commercial

The commercial receptacles, with their abbreviated roll construction, conserve stock, have generally higher insertion forces and somewhat lower tolerance for general abuse.

Test Specifications

Operating Temperatures of Materials and Finishes

FASTON Terminals are made available in brass and phosphor bronze which can be plated with tin or silver. The line also includes a selection of nickel plated steel tabs and receptacles.

Certain products are available in either pre-tin or tin plated. Tin plate is the electro-depositing of tin on base metal over the entire surface of the terminal following the fabrication of

the terminal. Pre-tin plate is the plating of tin on base metal prior to fabrication which produces exposed base metal in the terminal edge areas after stamping.

Brass

Plain

Allowable Connection Temperature* — 110°C.

Plain brass is used frequently, where applications have optimal environmental conditions.

Tin Plated

Allowable Connection Temperature — 110°C.

Tin plating of receptacle and tab improves operation at higher temperatures, and in addition helps to protect the connection against corrosion.

Silver Plated

Allowable Connection Temperature — 130°C.

Silver plated connections allow the highest operating temperature for brass and a higher current-carrying capacity.

* Allowable Connection Temperature is the ambient temperature plus temperature rise of the terminal at normal operating conditions.

Phosphor Bronze

Plain

Allowable Connection Temperature — 110°C.

Phosphor bronze is used in applications where brass would normally be corroded, for example the various freezing mixtures and ammonias.

Tin Plated

Allowable Connection Temperature — 110°C.

Tin plating of receptacle and tab improves operation at higher temperatures, and in addition helps to protect the connection against corrosion.

Silver Plated

Allowable Connection Temperature — 130°C.

Silver plated connections allow the highest operating temperature for phosphor bronze and higher current-carrying capacity.

Steel

Nickel Plated

Allowable Connection Temperature — 250°C.

This combination allows a reliable connection at high temperatures, for example in stoves, cooking appliances, etc. For optimum performance, these nickel plated receptacles are used with compatible lead wires and tabs that can be welded to heating units.

Plastics (Insulation)

Material Temperature Rating —

The following list shows various plastics and their application temperatures.

High Temp. Polyamide (Nylon)	150°C
Polyamide, (Nylon)	125°C
Polypropylene	105°C
Polyester	90°C
Polyethylene	75°C
A.B.S.	70°C
PVC	60°C

Note: For information related to Glow Wire temperature ratings, contact Tyco Electronics Engineering.

Stress Relieving of Brass or Steel Receptacles

The process of stress relieving is unique to Tyco Electronics quick connects and is most commonly used in the production of those receptacles designated as Premier line, including Ultra-Fast, Ultra-Fast Plus FASTON and PIDG receptacles. Stress is introduced into copper alloy or steel terminals during the stamping process. When metal strip

is formed into the receptacle, the material is deformed beyond its yield stress to form it into its new shape. This forming operation leaves a residual stress in the grain structure. The orientations and magnitudes of the forming stresses are complex, but can exist in the same direction as the applied load. Thus, residual stresses can reduce the force necessary to open the

receptacle during the tab insertion. Stress relieving the terminal restores the elastic spring properties and improves receptacle performance by reducing the residual stresses. After stress relieving, the receptacle resists opening when a tab is inserted, especially where difficult or awkward mating situations may cause mechanical abuse.

Test Specifications (Continued)

Test Specifications

The following information and related charts are taken from the qualification requirements as defined in UL-310, the Safety Standard

for Electrical Quick-Connect Terminals. Throughout this catalog, when a reference is made to a part being UL Listed, that part has been

qualified to the standards shown in these charts.

Temperature Rise and Millivolt Drop

The temperature rise and millivolt drop characteristics are the lowest in the industry. They comply with safety requirements and exhibit extreme stability during extended time tests.

When using FASTON terminals, the allowable connection temperatures can be adjusted, based on the application, by considering actual current(s) and related temperature rise,

time at this temperature, humidity, corrosion environment, vibration, base metal, plating (if any), and other environmental considerations.

Test Parameters for FASTON Terminals (Based on UL-310 Temperature Rise and Current Requirements)

Contact Size	Wire Size (Strand Count)	Continuous Current	Intermittent Current	
250 Series	10 (105)	24	48	
	12 (65)	20	40	
	14 (41)	15	30	
	205 Series	16 (26)	10	20
		18 (16)	7	14
		20 (10)	4	8
		22 (7)	3	6
	187 Series	16 (26)	5	10
		18 (16)	4	8
		20 (10)	3	6
22 (7)		2	4	
110 Series	16 (26)	5	10	
	18 (16)	4	8	
	20 (10)	3	6	
	22 (7)	2	4	

Note: This information applies only to UL listed (UL) terminals. A part with a Component Recognition (CR) status deviates from the electrical or other requirements defined in the UL-310 safety standard.

This table can be used as a guide for selecting a characteristic such as Contact Size, Wire Size, or Current (either Continuous or Intermittent Operating Current) when the other two are known. This table also identifies the possible receptacle sizes available for a given wire size. The continuous current column highlights the maximum current that should be applied to a given receptacle and wire combination to meet a 30°C maximum temperature rise. Intermittent Current can be defined as a one hour cycle consisting of 45 minutes on and 15 minutes off. The temperature rise of the connector using the intermittent current on the corresponding wire size will be less than 85° C. The wire used in the testing to meet these electrical requirements is tin plated copper with stranding as indicated above in parentheses for terminals intended for internal wiring connections.

Tensile Strength (forces for crimp pull-out)

Maximum tensile strength of the wire to terminal connection does not insure reliable electrical performance. An acceptable compromise between maximum tensile strength and electrical stability is recommended.

Normally the tensile strength is much greater than the force required to disconnect the tab from the receptacle; therefore, no difficulties or hazards are encountered.

Forces for Crimp Pull-out Test (UL-310 Specification)

Wire Size		Minimum Force	
AWG	(mm²)	pounds	N
22	0.32	8	36
20	0.52	13	58
18	0.82	20	89
16	1.3	30	133
14	2.1	50	223
12	3.3	70	311
10	5.3	80	356

The forces shown for the crimp pull out test represent the minimum force required to separate the wire from the crimped terminal in an axis parallel to the wire exit direction from the contact. This force does not include the holding force of the insulation crimp (if applicable).

Insertion and Withdrawal Forces for Engagement-Disengagement

The UL-310 Safety Standard defines a broad range for the insertion and extraction value of each connector series. Many of

the FASTON product families (such as Premier line, Budget line, Low Insertion Force type, etc.) have been designed for

specific applications and to address forces within the overall range as defined in the chart.

Insertion and Withdrawal Forces for Engagement-Disengagement Test (UL-310 Specification)

Tab Size	First Insertion, Maximum Individual	Force, pounds (N)				
		Maximum	First withdrawal		Sixth withdrawal	
			Minimum		Minimum	
		Average	Individual	Average	Individual	
Test Tab and Unplated Connector						
.250 6.30	18 (80)	18 (80)	6 (27)	4 (18)	5 (22)	4 (18)
.205 5.20	15 (67)	20 (89)	5 (22)	3 (13)	3 (13)	2 (9)
.187 4.80						
.125 3.20	12 (53)	14 (62)	3 (13)	2 (9)	2 (9)	1 (4)
.110 2.80						
Test Tab and Tin Plated Connector						
.250 6.30	17 (76)	17 (76)	5 (22)	3 (13)	4 (18)	3 (13)
.205 5.20	15 (67)	20 (89)	5 (22)	3 (13)	3 (13)	2 (9)
.187 4.80						
.125 3.20	12 (53)	14 (62)	3 (13)	2 (9)	2 (9)	1 (4)
.110 2.80						

This chart show the forces required to engage and disengage a connector from a **plain brass test tab** (tab for mechanical testing as shown in the tab section of this catalog). The force is measured with a testing device capable of holding the reading and providing accurate alignment with slow and steady engagement and disengagement of the connector and test tab.

Vibration Resistance

In applications where conductors are subjected to flexing at termination points, circuit failure is avoided because resistance to

vibration is enhanced through Tyco Electronics insulation support, even on conductors with oversized insulation.

Wire Range

FASTON Receptacles are available in various wire ranges from 26-10 AWG, depending on series size.

The chart below is designed to show our recommended two-wire combinations.

Recommended Two-Wire Combinations

Wire Ranges																
8-10	12-10	14-10	14-12	16-12	16-14	18-12	18-14	(2) 18 (2) 16	18-14	18-16	20-14	20-16	20-16	20-18	22-16	22-18
Two-Wire Combinations																
10-22 ¹	12-22 ¹	14-14	18-16	16-22	18-18	18-18	16-16	16-16	22-18	18-22 ¹	20-22	18-18	20-18	20-20	18-22 ¹	22-20 ¹
10-20	12-20	14-16	18-14	16-20	18-20	18-16	16-22 ¹	18-18	20-18	18-20	20-20	18-20	20-20	20-22 ¹	18-20	22-22
10-18	12-18	14-18	16-16	16-18	16-22 ¹	18-14	16-20	16-18 ¹	18-18	18-18	20-18	20-20	22-18 ¹	22-22	20-20	
10-16	12-16	14-20	14-22 ¹	16-16	16-20	18-20	16-18		20-20	20-20	20-16	22-20	22-22		20-22	
10-14	14-16	14-22	14-20	18-18	18-22	18-18			20-16	18-22	18-22 ¹	22-20				
12-14	14-14	16-16		18-20	16-22	18-20			22-16 ¹		18-18					
	14-12	16-18		18-14	16-18	18-22					18-16					
		16-12		20-14	16-16	20-20					16-22 ¹					
		18-12			14-22 ¹	20-22										
		20-12		22-14 ¹	14-20											
		22-12 ¹														

¹ Min/Max Wire Size Combinations

FASTON Receptacles

Product Facts

- Full line of Premier, Budget, LIF, moldable and hermetic uninsulated receptacles
- Straight, right-angle and receptacle and tab combinations available
- Receptacles available in .312, .250, .205, .187, .125 and .110 sizes
- Available in 8-30 AWG wire ranges
- Receptacles mate with .032 and .020 thick tabs
- Available with or without secondary wire support
- Base materials brass, phosphor bronze and steel available
- Tin, silver and nickel plated products available
- Products designed and manufactured to meet UL 310 specifications
- Products designed and manufactured to meet CSA C22.2 specifications

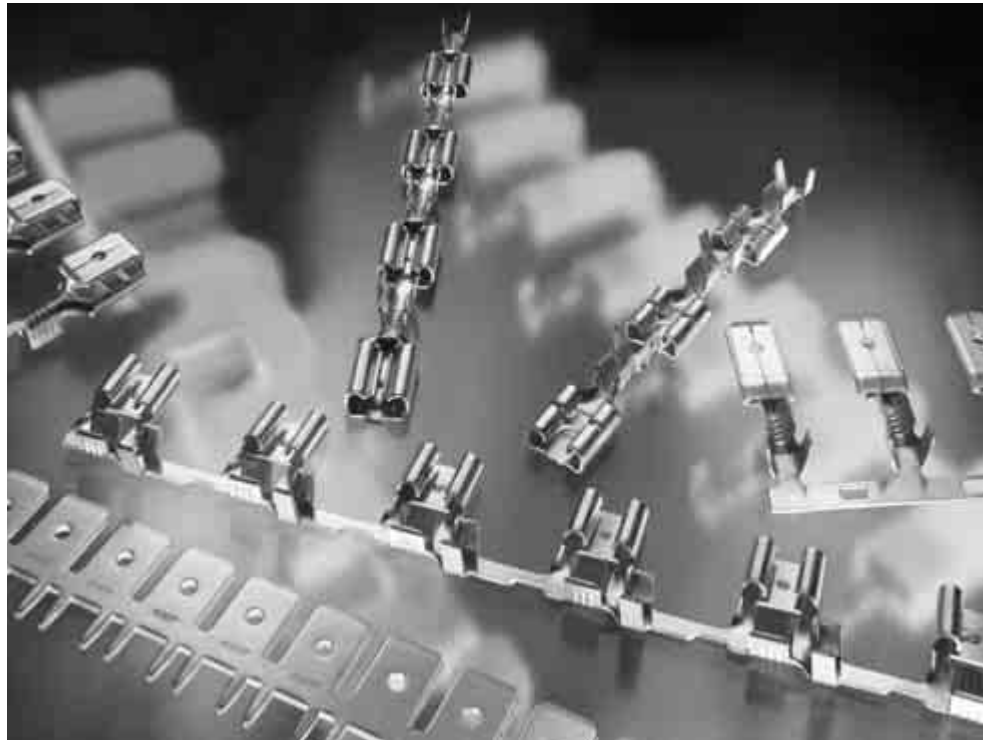

Tyco Electronics offers a full line of Uninsulated quick connects. We offer products for a wide variety of applications in almost every market and industry we serve. It is important to choose the correct terminal for each application. The following is a list of application specific characteristics that must be considered when determining the best terminal for each individual application.

Mating Tab

Size (312, 250, 205, 187, 110, etc.)

Wire Type

Magnet or Stranded

Wire Orientation

Straight or Flag

Temperature/Environment

Base metal
Plating requirements

Insulator required

Pre-insulated
Housing required

Agency Approvals (UL/CSA)

Application
Continuous Strip or
Loose Piece

Special Applications

Moldable
Hermetic
Printed Circuit Board
Piggyback (Straight/Flag)
Reversible Flags
Center Strip
Positive Locking

312 Series Receptacles

**Straight Receptacles,
Insulation Support**

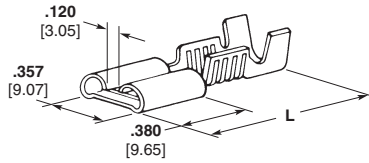

A — Premier Line

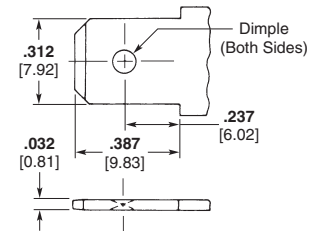

Mating 312 Series Tab Dimensions
Dimple (Both Sides)

Wire Range AWG	Style	Tab Fit	Insulation Diameter	Material and Finish	Stock Thickness	L (Overall Length)	UL	RA	SP	Terminal Part Number
18-14	A	.032 0.81	.090-.120 2.29-3.05	Brass	.016 0.41	.900 22.86	—	X	X	62092-1
		.032 0.81	.160 or (2) .110 4.06 or 2.79	Brass, Tin Plated	.016 0.41	.900 22.86	—	X	X	61399-1
16-12	A	.032 0.81	.160 or (2) .110 4.06 or 2.79	Brass, Silver Plated	.016 0.41	.900 22.86	—	X	X	63225-2
		.032 0.81	.160 or (2) .110 4.06 or 2.79	Brass, Tin Plated	.016 0.41	.900 22.86	—	X	X	63677-1 ¹
		.032 0.81	.160 or (2) .110 4.06 or 2.79	Brass	.016 0.41	.900 22.86	—	X	X	63677-2 ¹
		.032 0.81	.150-.200 3.81-5.08	Brass, Silver Plated	.018 0.46	.900 22.86	—	X	X	63820-1

¹ Low Insertion Force

250 Series Receptacles

**Straight Receptacles,
Insulation Support**

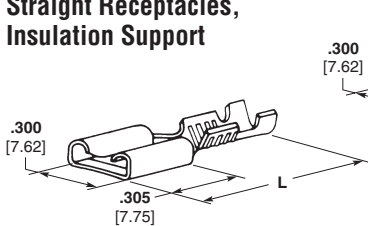

A — Premier Line

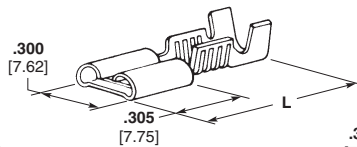

B — Budget Line

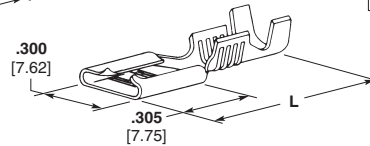

C — Economy Line

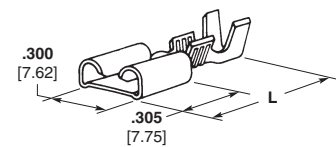

D — Moldable Line

Wire Range AWG	Style	Tab Fit	Insulation Diameter	Material and Finish	Stock Thickness	L (Overall Length)	UL	RA	SP	Terminal Part Number
26-22	C	.032 0.81	.040-.060 1.02-1.52	Brass	.016 0.41	.755 19.18	X ¹	—	X ¹	61202-1
24-20	A	.032 0.81	.030-.070 0.76-1.78	Brass, Tin Plated	.016 0.41	.755 19.18	X ²	—	X ²	61368-1
		.032 0.81	.060-.100 1.52-2.54	Brass	.016 0.41	.755 19.18	X	—	X	42640-1
	A	.032 0.81	.060-.100 1.52-2.54	Brass, Tin Plated	.016 0.41	.755 19.18	X	—	X	42640-2
		.032 0.81	.090-.130 2.29-3.30	Brass	.016 0.41	.755 19.18	X	—	X	41771
		.032 0.81	.090-.130 2.29-3.30	Brass, Tin Plated	.016 0.41	.755 19.18	X	—	X	41772
22-18	B	.032 0.81	.090-.130 2.29-3.30	Brass	.016 0.41	.755 19.18	X	—	X	42510-1
		.032 0.81	.090-.130 2.29-3.30	Brass, Tin Plated	.016 0.41	.755 19.18	X	—	X	42510-2
	C	.032 0.81	.090-.130 2.29-3.30	Brass	.016 0.41	.755 19.18	X	—	X	42743-1
		.032 0.81	.090-.130 2.29-3.30	Brass, Tin Plated	.016 0.41	.755 19.18	X	—	X	42743-2
	D	.032 0.81	.090-.130 2.29-3.30	Brass	.016 0.41	.755 19.18	—	—	—	63127-1

¹ UL listed and CSA certified for 22 AWG.

² UL listed and CSA certified for 22-20 AWG.

³ Mates with a .020 [0.51] thick tab.

⁴ 9,600 CMA max.

⁵ UL/CSA - 10 AWG only.

⁶ Stress relieved.

⁷ Recommended for external use only.

⁸ Recommended for internal or external use.

Note: All part numbers are RoHS compliant.

250 Series Receptacles (Continued)

Straight Receptacles, Insulation Support
(Continued)

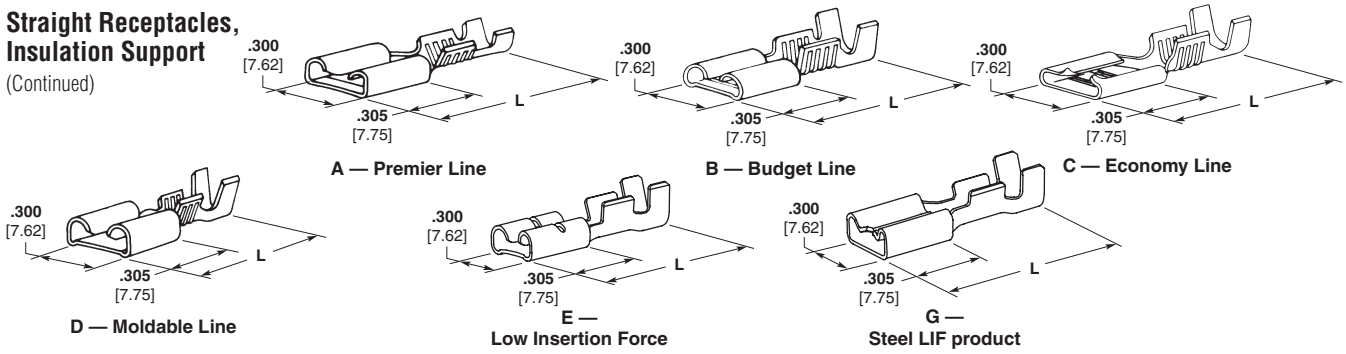

Wire Range AWG	Style	Tab Fit	Insulation Diameter	Material and Finish	Stock Thickness	L (Overall Length)	UL	CSA	RoHS	Terminal Part Number	
22-18	E	.032 0.81	.090-130 2.29-3.30	Brass	.016 0.41	.755 19.18	X	—	X	63693-1 ⁶	
		.032 0.81	.090-130 2.29-3.30	Brass	.016 0.41	.755 19.18	X	—	X	63609-1	
		.032 0.81	.090-130 2.29-3.30	Brass, Tin Plated	.016 0.41	.755 19.18	X	—	X	63609-2	
		.020 0.51	.120-170 3.05-4.32	Brass, Tin Plated	.018 0.46	.755 19.18	X	—	X	63655-1 ³	
		.032 0.81	.060-110 1.52-2.79	Brass, Tin Plated	.018 0.46	.755 19.18	X	—	X	61375-1	
		.032 0.81	.060-110 1.52-2.79	Steel, Nickel Plated	.016 0.41	.755 19.18	—	—	—	63688-1	
	18-14	A	.032 0.81	.120-170 3.05-4.32	Steel, Nickel Plated	.016 0.41	.755 19.18	—	X	X	42219-1
			.032 0.81	.120-170 3.05-4.32	Brass	.018 0.46	.755 19.18	X	—	X	41202
			.032 0.81	.120-170 3.05-4.32	Brass, Tin Plated	.018 0.46	.755 19.18	X	—	X	41274
			.032 0.81	.120-170 3.05-4.32	Brass	.016 0.41	.750 19.05	X	—	X	42400-1
			.032 0.81	.120-170 3.05-4.32	Brass, Tin Plated	.016 0.41	.750 19.05	X	—	X	42400-2
			.032 0.81	.120-170 3.05-4.32	Brass, Silver Plated	.016 0.41	.755 19.18	X	—	X	61107-1 ⁶
C		.032 0.81	.120-170 3.05-4.32	Brass	.016 0.41	.755 19.18	X	—	X	42660-1	
		.032 0.81	.120-170 3.05-4.32	Brass, Tin Plated	.016 0.41	.755 19.18	X	—	X	42660-2	
		.032 0.81	.150-210 3.81-5.33	Brass	.016 0.41	.780 19.81	X	—	X	42692-1	
		.032 0.81	.150-210 3.81-5.33	Brass, Tin Plated	.016 0.41	.780 19.81	X	—	X	42692-2	
		.032 0.81	.120-170 3.05-4.32	Brass	.016 0.41	.750 19.05	X	—	X	60650-1	
		.032 0.81	.120-170 3.05-4.32	Brass, Tin Plated	.016 0.41	.750 19.05	X	—	X	60650-2	
E	D	.032 0.81	.120-170 3.05-4.32	Brass, Tin Plated	.018 0.46	.750 19.05	X	—	X	63500-1 ⁶	
		.020 0.51	.120-170 3.05-4.32	Brass, Tin Plated	.018 0.46	.775 19.69	X	—	X	63993-1 ^{3,6}	
		.032 0.81	.120-170 3.05-4.32	Brass	.018 0.46	.755 19.18	X	—	X	63537-1 ⁶	
		.032 0.81	.120-170 3.05-4.32	Brass, Tin Plated	.018 0.46	.755 19.18	X	—	X	63537-2 ⁶	
		.032 0.81	.120-170 3.05-4.32	Steel, Nickel Plated	.016 0.41	.755 19.18	—	X	X	63674-1 ⁶	
		.032 0.81	.120-170 3.05-4.32	Brass	.016 0.41	.755 19.18	X	—	X	63306-1	
	G	.032 0.81	.120-170 3.05-4.32	Brass, Tin Plated	.016 0.41	.755 19.18	X	—	X	63306-2	
		.032 0.81	.120-170 3.05-4.32	Steel, Nickel Plated	.016 0.41	.755 19.18	—	X	—	1742198-1	

¹ UL listed and CSA certified for 22 AWG.

² UL listed and CSA certified for 22-20 AWG.

³ Mates with a .020 [0.51] thick tab.

⁴ 9,600 CMA max.

⁵ UL/CSA - 10 AWG only.

⁶ Stress relieved.

⁷ Recommended for external use only.

⁸ Recommended for internal or external use.

Note: All part numbers are RoHS compliant.

250 Series Receptacles (Continued)

Straight Receptacles, Insulation Support (Continued)

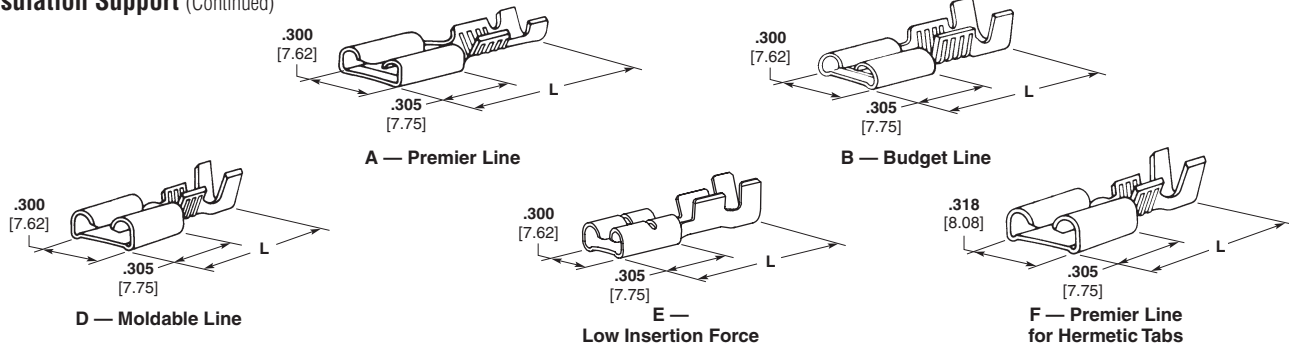

FASTON Receptacles

Wire Range AWG	Style	Tab Fit	Insulation Diameter	Material and Finish	Stock Thickness	L (Overall Length)	UL	CSA	RoHS	Terminal Part Number
18-14	F	.032 0.81	.120-.170 3.05-4.32	Brass	.018 0.46	.750 19.05	X	—	X	62500-1 ⁷
		.032 0.81	.120-.170 3.05-4.32	Brass, Tin Plated	.018 0.46	.750 19.05	X	—	X	62500-2 ⁷
		.032 0.81	.120-.170 3.05-4.32	Phos Brz, Tin Plated	.018 0.46	.750 19.05	X	—	X	41774 ⁸
16-12 (2) 16	B	.032 0.81	.160-.210 4.06-5.33 (2) .130 3.30	Brass	.016 0.41	.750 19.05	X	—	X	63896-1
16-12	A	.032 0.81	.210-.265 5.33-6.73	Steel, Nickel Plated	.018 0.46	.830 21.08	—	X	X	42579-1
16-12 (2) 18	A	.032 0.81	.210-.265 5.33-6.73 (2) .120 3.05 Max.	Brass	.018 0.46	.820 20.93	X	—	X	41727
				Brass, Tin Plated	.018 0.46	.820 20.93	X	—	X	41728
	E	.032 0.81	.210-.265 5.33-6.73 (2) .120 3.05 Max.	Brass	.018 0.46	.755 19.18	X	—	X	63757-1
				Steel, Nickel Plated	.018 0.46	.755 19.18	—	X	X	63757-2
	A	.032 0.81	.150-.200 3.81-5.08	Brass	.018 0.46	.770 19.56	X	—	X	41449 ⁴
				Brass, Tin Plated	.018 0.46	.770 19.56	X	—	X	41450 ⁴
	B	.032 0.81	.150-.200 3.81-5.08	Brass, Silver Plated	.018 0.46	.750 19.05	X	—	X	61095-1 ⁴
				Brass, Silver Plated	.018 0.46	.755 19.18	X	—	X	63435-1 ^{4,6}
14-10	E	.032 0.81	.150-.200 3.81-5.08	Brass	.018 0.46	.775 19.69	X	—	X	63365-1 ⁴
				Brass, Tin Plated	.018 0.46	.775 19.69	X	—	X	63365-2 ⁴
	F	.032 0.81	.150-.200 3.81-5.08	Brass, Tin Plated	.018 0.46	.770 19.56	X	—	X	42437-2 ^{4,7}
				Phos Brz, Tin Plated	.018 0.46	.770 19.56	X	—	X	42437-5 ^{4,8}
14-10 (2) 14	A	.032 0.81	.225-.275 5.72-6.99 (2) .140 3.56	Brass, Tin Plated	.018 0.46	.775 19.69	X	—	X	60635-1 ⁴
				Brass, Silver Plated	.018 0.46	.775 19.69	X	—	X	60635-2 ⁴
				Brass	.018 0.46	.775 19.69	X	—	X	60635-3 ⁴
	D	.032 0.81	.225-.275 5.72-6.99 (2) .140 3.56	Brass, Tin Plated	.018 0.46	.750 19.05	—	—	—	63419-1 ^{4,6}
	E	.032 0.81	.225-.275 5.72-6.99 (2) .140 3.56	Brass, Tin Plated	.018 0.46	.755 19.18	X	—	X	63539-1 ^{4,6}

¹ UL listed and CSA certified for 22 AWG.

² UL listed and CSA certified for 22-20 AWG.

³ Mates with a .020 [0.51] thick tab.

⁴ 9,600 CMA max.

⁵ UL/CSA - 10 AWG only.

⁶ Stress relieved.

⁷ Recommended for external use only.

⁸ Recommended for internal or external use.

Note: All part numbers are RoHS compliant.

250 Series Receptacles (Continued)

FASTON Receptacles

Straight Receptacles, Insulation Support (Continued)

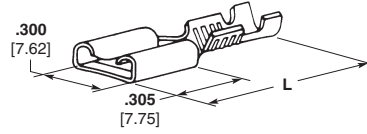

A — Premier Line

Wire Range AWG	Style	Tab Fit	Insulation Diameter	Material and Finish	Stock Thickness	L (Overall Length)	UL	RU	SP	Terminal Part Number
12-10	A	.032	.150-.220	Brass,	.018	.775	X	—	X	62428-2
		0.81	3.81-5.59	Tin Plated	0.46	19.69				
12-10	A	.032	.150-.220	Phos Brz,	.018	.775	X	—	X	62428-3
		0.81	3.81-5.59	Tin Plated	0.46	19.69				
10-8	A	.032	.230-.280 ^{or}	Brass,	.018	.775	X	—	X	62998-2 ⁵
		0.81	5.84-7.11 (2) .160 4.06							

¹ UL listed and CSA certified for 22 AWG.
² UL listed and CSA certified for 22-20 AWG.
³ Mates with a .020 [0.51] thick tab.

⁴ 9,600 CMA max.
⁵ UL/CSA - 10 AWG only.
⁶ Stress relieved.

⁷ Recommended for external use only.
⁸ Recommended for internal or external use.

Receptacle and Tab Combinations

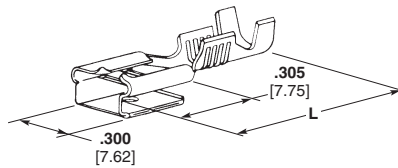

A — Economy Line

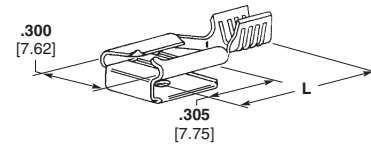

B — Economy Line
Non-Insulation Support

Wire Range AWG	Style	Tab Fit	Insulation Diameter	Material and Finish	Stock Thickness	L (Overall Length)	UL	RU	SP	Terminal Part Number		
22-18	A	.032	.060-.100	Brass	.015	.770	X	—	X	61988-1		
		0.81	1.52-2.79		0.38	19.56						
		.032	.060-.100	Brass,	.015	.770	X	—	X	61988-2		
		0.81	1.52-2.79	Tin Plated	0.38	19.56						
22-18	A	.032	.060-.100	Brass,	.015	.770	X	—	X	61988-3 ²		
		0.81	1.52-2.79		Tin Plated	0.38					19.56	
		.032	.120-.170	Brass	.015	.770	X	—	X	61944-1		
		0.81	3.05-4.32		0.38	19.56						
18-14	A	.032	.120-.170	Brass,	.015	.770	X	—	X	61944-2		
		0.81	3.05-4.32		Tin Plated	0.38					19.56	
		.032	.120-.170	Brass	.032-.016	.770	X	—	X	62109-1 ¹		
		0.81	3.05-4.32		0.81-0.41	19.56						
18-14	A	.032	.120-.170	Brass,	.032-.016	.770	X	—	X	62109-2 ¹		
		0.81	3.05-4.32		Tin Plated	0.81-0.41					19.56	
		.032	.120-.170	Brass	.015	.770	X	—	X	62223-1 ²		
		0.81	3.05-4.32		0.38	19.56						
18-14	B	.032	—	Pre-Tin Brass	.015	.610	X	—	X	62276-1		
		0.81	—		0.38	15.49						
		14-10	A	.032	.150-.200	Brass	.015	.770	X	—	X	62253-1 ³
				0.81	3.81-5.08		0.38	19.56				
.032	.150-.200			Brass,	.015	.770	X	—	X	62253-2 ³		
0.81	3.81-5.08				Tin Plated	0.38					19.56	
14-10	A	.032	.150-.200	Brass,	.032-.016	.770	X	—	X	1217043-1 ^{1,3}		
		0.81	3.81-5.08		Tin Plated	0.81-0.41					19.56	
14-10	B	.032	—	Pre-Tin Brass	.015	.610	X	—	X	62068-1 ³		
		0.81	—		0.38	15.49						

¹ Dual Thickness.
² Stress relieved.
³ 9600 CMA Max.

Note: All part numbers are RoHS compliant.

250 Series Receptacles (Continued)

Straight Receptacles, Non-Insulation Support

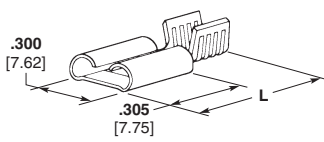

A — Premier Line

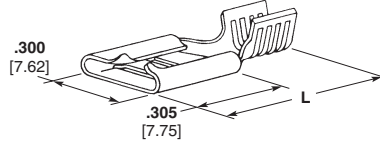

B — Economy Line

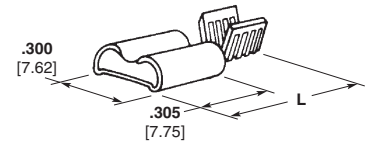

C — Moldable Line

Wire Range AWG	Style	Tab Fit	Insulation Diameter	Material and Finish	Stock Thickness	L (Overall Length)	UL	RA	SP	Terminal Part Number
18-14	A	.032 0.81	—	Brass, Tin Plated	.018 0.46	.655 16.64	X	—	X	41194
		.032 0.81	—	Steel, Nickel Plated	.018 0.46	.655 16.64	—	X	X	41143-1
	B	.032 0.81	—	Brass	.016 0.41	.595 15.11	X	—	X	42845-1
		.032 0.81	—	Brass, Tin Plated	.016 0.41	.595 15.11	X	—	X	42845-2
	C	.032 0.81	—	Brass	.016 0.41	.655 16.64	X	—	X	60938-1
		.032 0.81	—	Brass, Tin Plated	.016 0.41	.655 16.64	X	—	X	60938-2
		.032 0.81	—	Brass, Tin Plated	.016 0.41	.655 16.64	—	—	—	63981-1 ¹

¹ No dimple.

250 Series Tab-Lok Flags

Flag Receptacles, Insulation Support

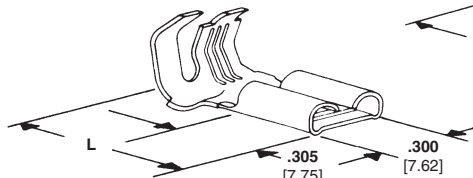

A — Premier Line

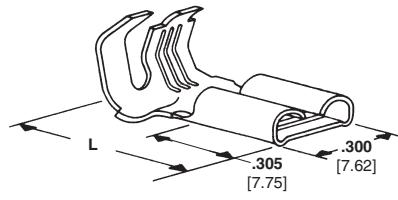

B — Budget Line

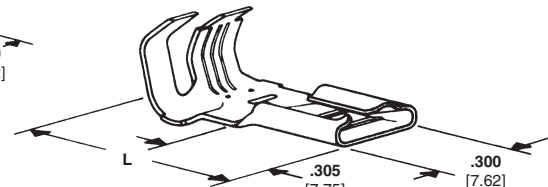

C — Economy Line

Wire Range AWG	Style	Tab Fit	Insulation Diameter	Material and Finish	Stock Thickness	L (Overall Length)	UL	RA	SP	Terminal Part Number
22-16	C	.032 0.81	.070 - .130 1.78-3.30	Brass	.016 0.41	.670 17.02	X	—	X	63577-1
		.032 0.81	.110-210 2.79-5.33	Brass	.018 0.46	.670 17.02	X	—	X	41531
18-12	A	.032 0.81	.110-210 2.79-5.33	Brass, Tin Plated	.018 0.46	.670 17.02	X	—	X	41532
		.032 0.81	.110-210 2.79-5.33	Brass, Silver Plated	.018 0.46	.670 17.02	X	—	X	61156-1
		.032 0.81	.110-210 2.79-5.33	Steel, Nickel Plated	.018 0.46	.670 17.02	—	X	X	41531-1
		.032 0.81	.110-210 2.79-5.33	Steel, Nickel Plated	.016 0.41	.670 17.02	—	X	X	42404-1
	B	.032 0.81	.110-210 2.79-5.33	Brass	.016 0.41	.670 17.02	X	—	X	42511-1
		.032 0.81	.110-210 2.79-5.33	Brass, Tin Plated	.016 0.41	.670 17.02	X	—	X	42511-2
	C	.032 0.81	.110-210 2.79-5.33	Brass	.016 0.41	.670 17.02	X	—	X	42742-1
		.032 0.81	.110-210 2.79-5.33	Brass, Tin Plated	.016 0.41	.670 17.02	X	—	X	42742-2

Note: All part numbers are RoHS compliant.

250 Series Tab-Lok Flags (Continued)

FASTON Receptacles

Flag Receptacles, Insulation Support (Continued)

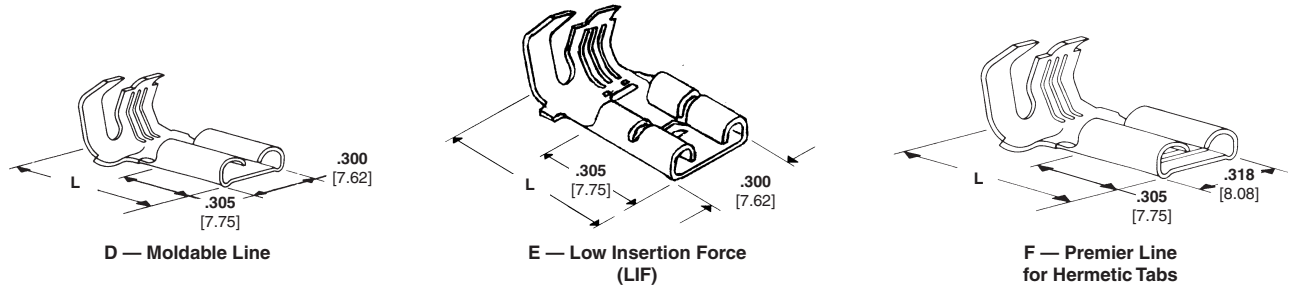

Wire Range AWG	Style	Tab Fit	Insulation Diameter	Material and Finish	Stock Thickness	L (Overall Length)	UL	RA	SF	Terminal Part Number
18-12	D	.032	.110-.210	Brass	.018	.670	X	—	X	60645-1 ²
		0.81	2.79-5.33		0.46	17.02				
		.032	.110-.210	Brass	.016	.670	X	—	X	60641-1
			0.81	2.79-5.33		0.41	17.02			
	E	.032	.110-.210	Brass	.016	.670	X	—	X	63445-1
		0.81	2.79-5.33		0.41	17.02				
		.032	.110-.210	Brass, Tin Plated	.016	.670	X	—	X	63445-2
		0.81	2.79-5.33		0.41	17.02				
		.032	.110-.210	Brass, Tin Plated	.016	.670	X	—	X	63445-4 ²
		0.81	2.79-5.33	Steel, Nickel Plated	.016	.670	—	X ¹	X ¹	63604-1 ²
			0.81	2.79-5.33		0.41	17.02			
	F	.032	.110-.210	Brass	.018	.670	X	—	X	63555-1 ²
0.81		2.79-5.33		0.46	17.02					
.032		.110-.210	Brass, Tin Plated	.018	.670	X	—	X	63555-2 ²	
0.81		2.79-5.33		0.46	17.02					
.032		.110-.210	Phos Bronze, Tin Plated	.018	.670	X	—	X	41800 ⁴	
0.81		2.79-5.33		0.46	17.02					
12-10	F	.032	.110-.210	Brass	.018	.670	X	—	X	41801 ³
		0.81	2.79-5.33		0.46	17.02				
		.032	.110-.210	Brass, Tin Plated	.018	.670	X	—	X	41802 ³
			0.81	2.79-5.33		0.46	17.02			
	F	.032	.110-.210	Phos Bronze, Silver Plated	.018	.670	X	—	X	42041 ⁴
		0.81	2.79-5.33		0.46	17.02				
		.032	.110-.210	Phos Bronze, Tin Plated	.018	.670	X	—	X	60274-2 ^{4,5}
		0.81	2.79-5.33		0.46	17.02				
		.032	.110-.210	Phos Bronze, Tin Plated	.018	.670	X	—	X	63651-1 ^{4,6}
		0.81	2.79-5.33		0.46	17.02				
	F	.032	.110-.210	Brass, Tin Plated	.018	.670	X	—	X	60851-1 ³
		0.81	2.79-5.33		0.46	17.02				
.032		.110-.210	Brass, Silver Plated	.018	.670	X	—	X	60851-2 ³	
0.81		2.79-5.33		0.46	17.02					
.032		.110-.210	Brass	.018	.670	X	—	X	60851-4 ³	
0.81		2.79-5.33		0.46	17.02					
F	.032	.110-.210	Phos Bronze, Silver Plated	.018	.670	X	—	X	42563-6 ⁴	
	0.81	2.79-5.33		0.46	17.02					
	.032	.110-.210	Steel, Nickel Plated	.018	.670	—	—	—	42563-9	
	0.81	2.79-5.33		0.46	17.02					
F	.032	.110-.210	Phos Bronze, Tin Plated	.018	.670	X	—	X	42563-8 ⁴	
	0.81	2.79-5.33		0.46	17.02					
F	.032	.110-.265	Brass	.018	.670	X	—	X	63617-1 ⁶	
	0.81	2.79-6.73		0.46	17.02					

¹ 18 AWG only.
² Stress relieved.
³ Recommended for external use only.
⁴ For internal or external use.
⁵ Left handed flag.
⁶ Non-stress relieved.

Note: All part numbers are RoHS compliant.

250 Series Tab-Lok Flags (Continued)

**Flag Receptacles,
Non-Insulation Support**

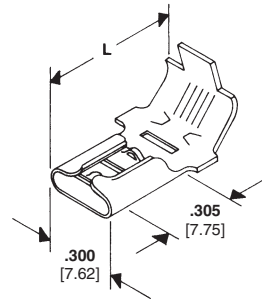

A — Economy Line

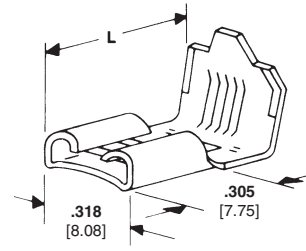

**B — Premier Line
for Hermetic Tabs**

Wire Range AWG	Style	Tab Fit	Insulation Diameter	Material and Finish	Stock Thickness	L (Overall Length)	UL	RA	SP	Terminal Part Number		
18-12	A	.032 0.81	—	Brass, Pre-Tin Plated	.016 0.41	.600 15.24	X	—	X	61177-2 ³		
		.032 0.81	—	Brass, Pre-Tin Plated	.016 0.41	.600 15.24	X	—	X	61177-3 ⁴		
		.032 0.81	—	Brass	.016 0.41	.600 15.24	X	—	X	62091-1 ⁵		
		.032 0.81	—	Brass, Pre-Tin Plated	.016 0.41	.600 15.24	X	—	X	62091-2 ⁵		
	B	.032 0.81	—	Pho. Brz, Silver Plated	.018 0.46	.610 15.49	X	—	X	62021-1 ⁵		
		.032 0.81	—	Brass, Tin Plated	.018 0.46	.610 15.49	X	—	X	62021-3 ⁵		
		.032 0.81	—	Pho. Brz, Silver Plated	.018 0.46	.670 17.02	X	—	X	62056-11 ³		
		.032 0.81	—	Pho. Brz, Silver Plated	.018 0.46	.670 17.02	X	—	X	62056-21 ^{2,4}		
		.032 0.81	—	Pho. Brz, Tin Plated	.018 0.46	.670 17.02	X	—	X	62056-6 ^{2,3}		
		.032 0.81	—	Pho. Brz, Tin Plated	.018 0.46	.670 17.02	X	—	X	62056-71 ^{2,4}		
		.032 0.81	—	Brass, Tin Plated	.018 0.46	.670 17.02	X	—	X	62056-3 ^{2,3}		
		.032 0.81	—	Brass, Tin Plated	.018 0.46	.670 17.02	X	—	X	62056-4 ⁴		
		12-10 or (2) 14	A	.032 0.81	—	Brass	.016 0.41	.670 17.02	X	—	X	62011-1 ⁵
				.032 0.81	—	Brass, Pre-Tin Plated	.016 0.41	.670 17.02	X	—	X	62011-2 ⁵
.032 0.81	—			Pho. Brz, Silver Plated	.018 0.46	.670 17.02	X	—	X	62057-11 ³		
12-10	B	.032 0.81	—	Brass, Tin Plated	.018 0.46	.670 17.02	X	—	X	62057-3 ³		
		.032 0.81	—	Brass, Tin Plated	.018 0.46	.670 17.02	X	—	X	62057-4 ⁴		
		.032 0.81	—	Pho. Brz, Silver Plated	.018 0.46	.670 17.02	X	—	X	62057-7 ⁴		
		.032 0.81	—	Pho. Brz, Silver Plated	.018 0.46	.670 17.02	X	—	X	62022-1 ⁵		
		.032 0.81	—	Brass, Tin Plated	.018 0.46	.670 17.02	X	—	X	62022-2 ⁵		

¹ For internal or external use.

² Reverse reel.

³ Right handed flag.

⁴ Left handed flag.

⁵ Right or left handed. Carrier out front for through splicing.

Note: All part numbers are RoHS compliant.

250 Series F-Crimp Flags

Flag Receptacles

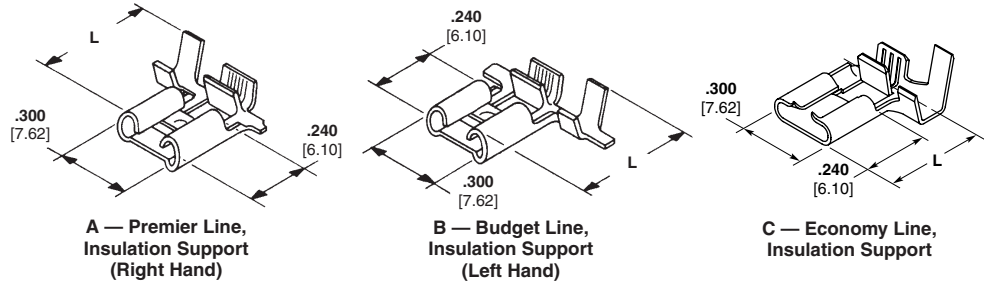

Wire Range AWG	Style	Tab Fit	Insulation Diameter	Material and Finish	Stock Thickness	L (Overall Length)	UL	RA	SP	Terminal Part Number
22-18	A	.032 0.81	.060 -.110 1.52-2.79	Brass	.016 0.41	.540 13.72	X	—	X	62813-1 ²
		.032 0.81	.060 -.110 1.52-2.79	Brass, Tin Plated	.016 0.41	.540 13.72	X	—	X	62813-2 ²
		.032 0.81	.060 -.110 1.52-2.79	Brass	.016 0.41	.540 13.72	X	—	X	62814-1 ³
	B	.032 0.81	.060 -.110 1.52-2.79	Brass	.016 0.41	.540 13.72	X	—	X	62718-1 ³
		.032 0.81	.060 -.110 1.52-2.79	Brass, Tin Plated	.016 0.41	.540 13.72	X	—	X	62718-2 ³
		.032 0.81	.060 -.110 1.52-2.79	Brass	.016 0.41	.540 13.72	X	—	X	63538-1 ^{1,2}
18-14 or (2)18	A	.032 0.81	.110-.200 2.79-5.08	Steel, Nickel Plated	.016 0.41	.540 13.72	—	X	—	63963-1 ²
		.032 0.81	.110-.160 2.79-4.06	Brass, Tin Plated	.016 0.41	.540 13.72	X	—	X	63901-1 ^{1,3}
18-14	A	.032 0.81	.110-.160 2.79-4.06	Brass	.016 0.41	.540 13.72	X	—	X	63901-2 ^{1,3}
		.032 0.81	.110-.160 2.79-4.06	Brass	.016 0.41	.540 13.72	X	—	X	63011-1 ²
		.032 0.81	.110-.160 2.79-4.06	Brass, Tin Plated	.016 0.41	.540 13.72	X	—	X	63011-2 ²
		.032 0.81	.110-.160 2.79-4.06	Brass	.016 0.41	.540 13.72	X	—	X	63012-1 ³
		.032 0.81	.110-.160 2.79-4.06	Brass, Tin Plated	.016 0.41	.540 13.72	X	—	X	63012-2 ³
	B	.032 0.81	.110-.160 2.79-4.06	Brass	.016 0.41	.540 13.72	X	—	X	63009-1 ²
		.032 0.81	.110-.160 2.79-4.06	Brass, Tin Plated	.016 0.41	.540 13.72	X	—	X	63009-2 ²
		.032 0.81	.110-.160 2.79-4.06	Brass	.016 0.41	.540 13.72	X	—	X	63010-1 ³
		.032 0.81	.110-.160 2.79-4.06	Brass, Tin Plated	.016 0.41	.540 13.72	X	—	X	63010-2 ³
		.032 0.81	—	Brass	.016 0.41	.430 10.92	X	—	X	63508-1 ⁴
C	.032 0.81	.110-.160 2.79-4.06	Brass	.016 0.41	.540 13.72	X	—	X	63096-1 ²	
	.032 0.81	.110-.160 2.79-4.06	Brass, Tin Plated	.016 0.41	.540 13.72	X	—	X	63096-2 ²	

¹ Low Insertion Force.
² Left Handed Flag.
³ Right Handed Flag.
⁴ No insulation support.

Note: All part numbers are RoHS compliant.

250 Series F-Crimp Flags (Continued)

Flag Receptacles (Continued)

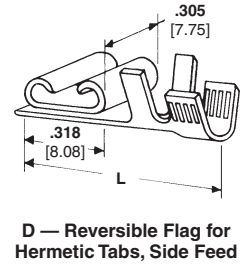
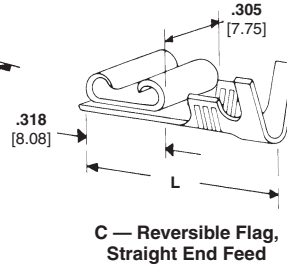
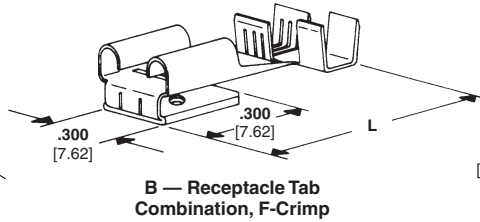
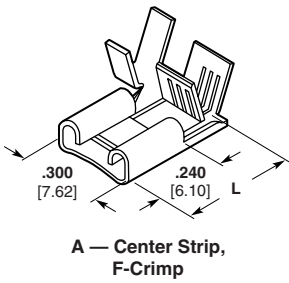

Wire Range AWG	Style	Tab Fit	Insulation Diameter	Material and Finish	Stock Thickness	L (Overall Length)	UL	RU	SR	Terminal Part Number
20-16	D	.032 0.81	.085-.150 2.16-3.81	Phos Brz, Tin Plated	.018 0.46	.640 16.26	X	—	X	63137-1
		.032 0.81	—	Brass	.016 0.41	.430 10.92	X	—	X	63315-1 ³
	A	.032 0.81	—	Brass, Tin Plated	.016 0.41	.430 10.92	X	—	X	63315-2 ³
		.032 0.81	.110-.160 2.79-4.06	Brass	.016 0.41	.540 13.72	X	—	X	63314-1
		.032 0.81	.110-.160 2.79-4.06	Brass, Tin Plated	.016 0.41	.540 13.72	X	—	X	63314-2
		.032 0.81	.120-.170 3.05-4.32	Brass, Tin Plated	.016 0.41	.630 16.00	X	—	X	151321-4
18-14	C	.032 0.81	.090-.130 2.29-3.30	Brass	.016 0.41	.710 18.03	X	—	X	62048-1
		.032 0.81	.090-.130 2.29-3.30	Brass, Tin Plated	.016 0.41	.710 18.03	X	—	X	62048-2
	D	.032 0.81	.170-.220 4.32-5.59	Brass, Tin Plated	.016 0.41	.710 18.03	X	—	X	60764-2
		.032 0.81	—	Brass	.018 0.46	.640 16.26	—	—	—	63647-1 ^{1,3}
		.032 0.81	—	Phos Brz, Tin Plated	.018 0.46	.640 16.26	—	—	—	63647-2 ^{1,3}
		.032 0.81	—	Brass, Tin Plated	.018 0.46	.640 16.26	—	—	—	63647-3 ^{1,3}
16-12	D	.032 0.81	.130-.170 3.30-4.32	Phos Brz, Tin Plated	.018 0.46	.640 16.26	X	—	X	61188-1 ²
12-10	D	.032 0.81	.130-.170 3.30-4.32	Phos Brz, Tin Plated	.018 0.46	.640 16.26	X	—	X	61187-1 ²
		.032 0.81	.130-.170 3.30-4.32	Phos Brz, Silver Plated	.018 0.46	.640 16.26	X	—	X	61187-2 ²

¹ No Dimple.

² Bends terminal 90°. For 180° bend use applicator 687616-2 with Press 694234-7.

³ No insulation support.

Note: All part numbers are RoHS compliant.

205 Series Receptacles

Straight Receptacles

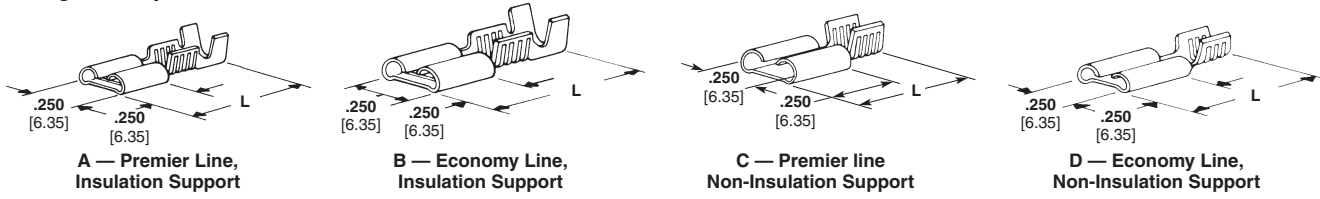

Wire Range AWG	Style	Tab Fit	Insulation Diameter	Material and Finish	Stock Thickness	L (Overall Length)	UL	RA	SP	Terminal Part Number
26-22	A	.020	.050-.070	Brass, Tin Plated	.012	.620	X	—	X	60674-1 ¹
		0.51	1.27-1.78	Brass	0.31	15.75	X	—	X	42198-1
	A	.020	.085-.125	Brass, Tin Plated	.012	.615	X	—	X	42198-2
		0.51	2.16-3.18	Brass, Tin Plated	0.31	15.62	X	—	X	42299-2
22-18	B	.020	.085-.125	Brass	.012	.615	X	—	X	42710-1
		0.51	2.16-3.18	Brass, Tin Plated	0.31	15.62	X	—	X	42710-2
		0.81	2.16-3.18	Brass, Tin Plated	0.31	15.62	X	—	X	60904-2
	C	.020	—	Brass, Tin Plated	.012	.470	X	—	X	42197-2 ²
		0.51	—	Brass, Tin Plated	0.31	11.94	X	—	X	42233-2
		0.81	—	Phos Brz, Tin Plated	0.41	15.62	X	—	X	42233-7
18-14	B	.020	.130-.180	Brass, Tin Plated	.012	.615	X	—	X	42713-2
		0.51	3.30-4.57	Brass, Tin Plated	0.31	15.62	X	—	X	42781-2
		0.81	3.30-4.57	Brass, Tin Plated	0.41	15.62	X	—	X	42781-2
	C	.020	.130-.180	Brass, Tin Plated	.016	.615	X	—	X	42781-2
		0.51	3.30-4.57	Brass, Tin Plated	0.41	15.62	X	—	X	42781-2
		0.81	3.30-4.57	Phos Brz, Tin Plated	0.41	11.94	X	—	X	42239-4
D	.020	—	Brass, Tin Plated	.012	.470	X	—	X	42712-2 ²	
0.51	—	Brass, Tin Plated	0.31	11.94	X	—	X	42712-2 ²		

¹ UL listed and CSA certified for 22 AWG.

² Moldable.

Flag Receptacles

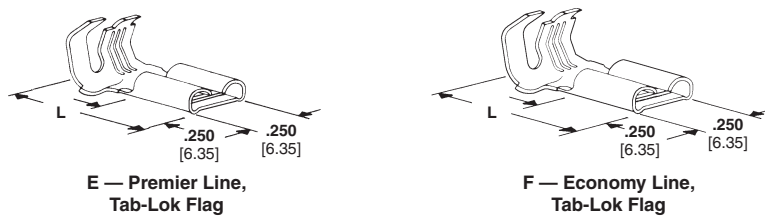

Wire Range AWG	Style	Tab Fit	Insulation Diameter	Material and Finish	Stock Thickness	L (Overall Length)	UL	RA	SP	Terminal Part Number
20-16	E	.020	.110-.170	Brass	.012	.530	X	—	X	42199-1
		0.51	2.79-4.32	Brass, Tin Plated	0.31	13.46	X	—	X	42199-2
	E	.020	.110-.170	Brass, Tin Plated	.016	.530	X	—	X	62354-1
		0.51	2.79-4.32	Brass, Tin Plated	0.41	13.46	X	—	X	42234-2
20-14	F	.020	.110-.170	Brass	.016	.530	X	—	X	60195-1 ¹
		0.81	2.79-4.32	Brass	0.41	13.46	X	—	X	60195-1 ¹
	F	.032	.110-.170	Brass, Tin Plated	.016	.530	X	—	X	60195-2 ¹
		0.81	2.79-4.32	Brass, Tin Plated	0.41	13.46	X	—	X	60195-2 ¹

¹ Moldable.

Note: All part numbers are RoHS compliant.

187 Series Receptacles

Straight Receptacles

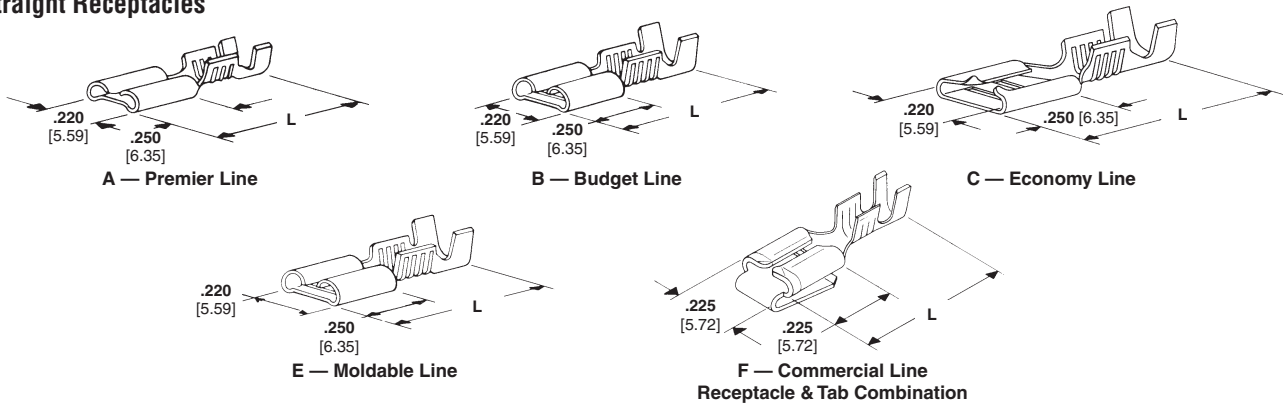

FASTON Receptacles

Wire Range AWG	Style	Tab Fit	Insulation Diameter	Material and Finish	Stock Thickness	L (Overall Length)	UL	RU	CS	Terminal Part Number
24-20	A	.020	.040-.070	Brass, Tin Plated	.012	.590	X ²	—	X ²	60573-1
		0.51	1.02-1.78		0.31	14.99				
		.020	.040-.070	Brass	.012	.590	X ²	—	X ²	60573-2
		0.51	1.02-1.78		0.31	14.99				
		.020	.040-.070	Phos Brz, Tin Plated	.012	.590	X	—	X	62187-2
		0.51	1.02-1.78		0.31	14.99				
		.020	.060-.110	Brass, Tin Plated	.012	.585	X ²	—	X ²	62138-1
		0.51	1.52-2.79		0.31	14.86				
22-18	B	.020	.060-.110	Brass	.012	.585	X ²	—	X ²	62138-2
		0.51	1.52-2.79		0.31	14.86				
	C	.021	.060-.110	Brass, Tin Plated	.012	.590	—	—	—	1217129-1
		0.53	1.52-2.79		0.31	14.99				
	E	.032	.040-.070	Brass, Tin Plated	.012	.590	X ²	—	X ²	62181-1
		0.81	1.02-1.78		0.31	14.99				
		.032	.090-.150	Brass, Tin Plated	.012	.585	X	—	X	63931-1
		0.81	2.29-3.81		0.31	14.86				
F	.020	.090-.130	Brass	.012	.590	X	—	X	63347-1	
	0.51	2.29-3.30		0.31	14.99					
20-16	A	.020	.090-.130	Brass	.012	.585	X	—	X	63905-1
		0.51	2.29-3.30		0.31	14.86				
	F	.020	.060-.100	Brass, Tin Plated	.014	.615	X	—	X	63873-1 ⁵
		0.51	1.52-2.54		0.36	15.62				
	A	.020	.090-.130	Brass, Tin Plated	.014	.615	X	—	X	1217084-1 ⁵
		0.51	2.29-3.30		0.36	15.62				
		.015	—	Brass, Tin Plated	.012	.470	—	—	—	42374-2 ¹
		0.38			0.31	11.94				
.015		.090-.130	Brass, Tin Plated	.012	.590	—	—	—	42453-2	
0.38		2.29-3.30		0.31	14.99					
.017		.090-.130	Phos Brz, Silver Plated	.012	.585	—	—	—	61084-1	
0.43		2.29-3.30		0.31	14.86					
A	.020	—	Brass, Tin Plated	.012	.470	X	—	X	42373-2 ¹	
	0.51			0.31	11.94					
	.020	—	Steel, Nickel Plated	.012	.470	—	X	—	42373-3 ¹	
	0.51			0.31	11.94					
	.020	.060-.110	Brass	.012	.585	X	—	X	62137-1	
	0.51	1.52-2.79		0.31	14.86					
	.020	.060-.110	Brass, Tin Plated	.012	.585	X	—	X	62137-2	
	0.51	1.52-2.79		0.31	14.86					
A	.020	.090-.130	Brass	.012	.590	X	—	X	42452-1	
	0.51	2.29-3.30		0.31	14.99					
	.020	.090-.130	Brass, Tin Plated	.012	.590	X	—	X	42452-2	
	0.51	2.29-3.30		0.31	14.99					
	.020	.090-.130	Phos Brz, Tin Plated	.012	.590	X	—	X	42452-5	
	0.51	2.29-3.30		0.31	14.99					
	.020	.090-.130	Steel, Nickel Plated	.012	.590	—	X	X	60621-1	
	0.51	2.29-3.30		0.31	14.99					

¹ No Insulation support.
² UL listed and CSA certified for 22- 20 AWG.
³ Also capable of accepting (2) 20 AWG wires.

⁴ Stress relieved.
⁵ Tab stock thickness .020 [0.51].

Note: All part numbers are RoHS compliant.

187 Series Receptacles (Continued)

Straight Receptacles (Continued)

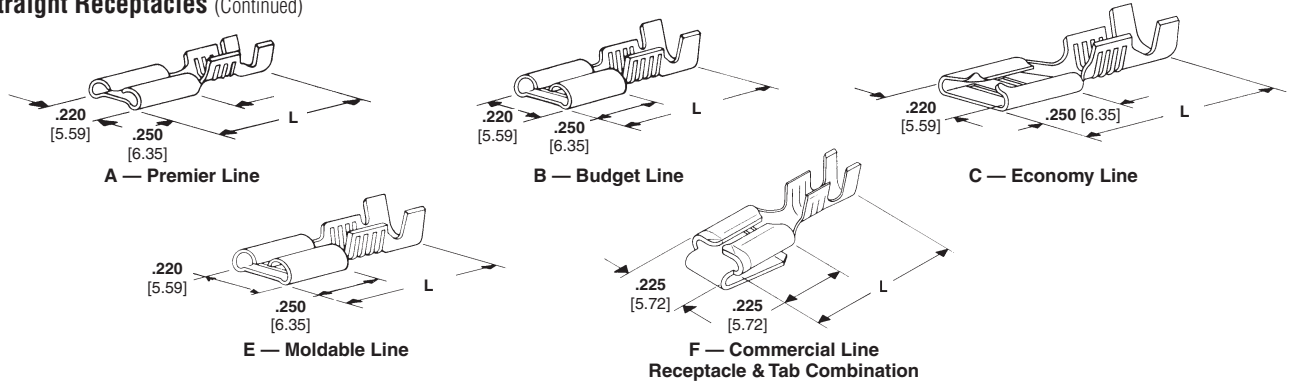

Wire Range AWG	Style	Tab Fit	Insulation Diameter	Material and Finish	Stock Thickness	L (Overall Length)	UL	SA	SP	Terminal Part Number	
20-16	A	.032 0.81	.090-.130 2.29-3.30	Steel, Nickel Plated	.012 0.31	.590 14.99	—	X	X	63850-1	
		.032 0.81	.090-.130 2.29-3.30	Brass	.012 0.31	.585 14.86	X	—	X	61758-1	
		.032 0.81	.090-.130 2.29-3.30	Brass, Tin Plated	.012 0.31	.585 14.86	X	—	X	61758-2	
		.020 0.51	.090-.130 2.29-3.30	Brass	.012 0.31	.585 14.86	X	—	X	42617-1	
	B	.020 0.51	.090-.130 2.29-3.30	Steel, Nickel Plated	.012 0.31	.585 14.86	—	X	X	63959-1	
		.020 0.51	.090-.130 2.29-3.30	Brass, Tin Plated	.012 0.31	.585 14.86	X	—	X	42617-2	
		.032 0.81	—	Brass	.012 0.31	.475 12.07	X	—	X	63785-1 ¹	
		.032 0.81	.090-.130 2.29-3.30	Brass	.012 0.31	.585 14.86	X	—	X	63477-1	
		.032 0.81	.090-.130 2.29-3.30	Brass, Tin Plated	.012 0.31	.585 14.86	X	—	X	63477-2	
		.020 0.51	—	Brass	.012 0.31	.475 12.07	X	—	X	42799-1 ¹	
	C	.020 0.51	—	Brass, Tin Plated	.012 0.31	.475 12.07	X	—	X	42799-2 ¹	
		.020 0.51	.090-.130 2.29-3.30	Brass	.012 0.31	.590 14.99	X	—	X	42801-1	
		.020 0.51	.090-.130 2.29-3.30	Brass, Tin Plated	.012 0.31	.590 14.99	X	—	X	42801-2	
		.020 0.51	.090-.130 2.29-3.30 or (2) 2.29	Brass	.012 0.31	.590 14.99	X	—	X	61892-1 ³	
		.032 0.81	—	Brass, Tin Plated	.012 0.31	.475 12.07	X	—	X	61969-1 ¹	
		.032 0.81	.090-.130 2.29-3.30	Brass	.012 0.31	.590 14.99	X	—	X	60196-1	
		.032 0.81	.090-.130 2.29-3.30	Brass, Tin Plated	.012 0.31	.590 14.99	X	—	X	60196-2	
		.039 0.99	.090-.130 2.29-3.30	Brass, Tin Plated	.012 0.31	.590 14.99	—	—	—	63751-1	
		E	.020 0.51	.090-.130 2.29-3.30	Brass	.012 0.31	.585 14.86	X	—	X	60214-1
			.020 0.51	.090-.130 2.29-3.30	Brass, Tin Plated	.012 0.31	.585 14.86	X	—	X	60214-2
F	.020 0.51	.060-.110 1.52-2.79	Brass, Tin Plated	.014 0.36	.615 15.62	X	—	X	62139-1 ⁵		
	.020 0.51	.090-.130 2.29-3.30	Brass, Tin Plated	.014 0.36	.615 15.62	X	—	X	62026-1 ⁵		
	.020 0.51	.090-.130 2.29-3.30	Brass	.014 0.36	.615 15.62	X	—	X	62026-2 ⁵		
	.032 0.81	.090-.130 2.29-3.30	Brass	.014 0.36	.615 15.62	X	—	X	63646-1 ⁵		
		.032 0.81	.090-.130 2.29-3.30	Brass, Tin Plated	.014 0.36	.615 15.62	X	—	X	63646-2 ⁵	

¹ No Insulation support.

² UL listed and CSA certified for 22- 20 AWG.

³ Also capable of accepting (2) 20 AWG wires.

Note: All part numbers are RoHS compliant.

⁴ Stress relieved.

⁵ Tab stock thickness .020 [0.51].

187 Series Receptacles (Continued)

Straight Receptacles (Continued)

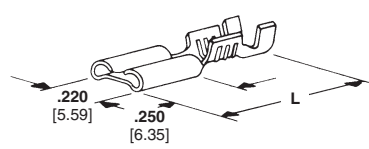

A — Premier Line

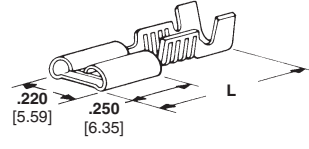

B — Budget Line

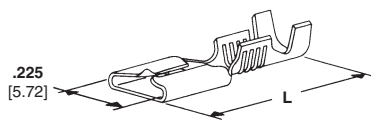

D — Commercial Line

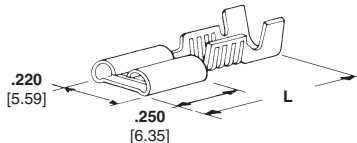

E — Moldable Line

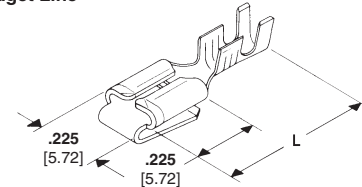

F — Commercial Line Receptacle & Tab Combination

Wire Range AWG	Style	Tab Fit	Insulation Diameter	Material and Finish	Stock Thickness	L (Overall Length)	UL	RA	SP	Terminal Part Number
18-16 or (2) 18	A	.020 0.51	.105-.210 2.67-5.33	Brass, Tin Plated	.012 0.31	.590 14.99	X	—	X	60487-2
			(2) .105 Max. 2.67	Brass	.012 0.31	.590 14.99	X	—	X	60487-1
		.032 0.81	.105-.210 2.67-5.33	Brass, Tin Plated	.012 0.31	.590 14.99	X	—	X	61945-1
			(2) .105 Max. 2.67	Steel, Nickel Plated	.012 0.31	.590 14.99	—	X	X	61945-2
	B	.032 0.81	.105-.210 2.67-5.33	Brass	.012 0.31	.585 14.86	X	—	X	63769-1
	E	.020 0.51	.105-.210 2.67-5.33	Brass	.012 0.31	.615 15.62	X	—	X	63470-1
18-14 or (2) 16	D	.020 0.51	.180-.230 4.57-5.84 or	Brass	.014 0.36	.640 16.26	X	—	X	60742-1
			(2) .110 Max. 2.79	Brass, Tin Plated	.014 0.36	.640 16.26	X	—	X	60742-2
			(2) .110 Max. 2.79	Brass, Tin Plated	.014 0.36	.640 16.26	X	—	X	63749-2 ⁴
		.025 0.64	.180-.230 4.57-5.84 or	Brass	.014 0.36	.640 16.26	—	—	—	63832-1
			(2) .110 Max. 2.79	Brass, Tin Plated	.014 0.36	.640 16.26	—	—	—	63832-2
			(2) .110 Max. 2.79	Brass	.014 0.36	.640 16.26	X	—	X	63596-1
18-14	A	.020 0.51	.110-.160 2.79-4.06	Brass, Tin Plated	.012 0.31	.590 14.99	X	—	X	1217149-1
			.150-.190 3.81-4.83	Brass	.014 0.36	.640 16.26	X	—	X	62016-1
	D	.020 0.51	.150-.190 3.81-4.83	Brass, Tin Plated	.014 0.36	.640 16.26	X	—	X	62016-2
			.150-.190 3.81-4.83	Brass, Pre-Tin	.014 0.36	.640 16.26	X	—	X	63697-1
	F	.020 0.51	.110-.160 2.79-4.06	Brass, Tin Plated	.014 0.36	.615 15.62	—	—	—	1217151-1 ⁵
			.150-.190 3.81-4.83	Brass, Pre-Tin	.014 0.36	.640 16.26	X	—	X	63697-1

¹ No Insulation support.

² UL listed and CSA certified for 22- 20 AWG.

³ Also capable of accepting (2) 20 AWG wires.

⁴ Stress relieved.

⁵ Tab stock thickness .020 [0.51].

Note: All part numbers are RoHS compliant.

187 Series Tab-Lok Flags

**Flag Receptacles,
Insulation Support**

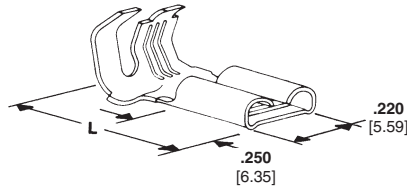

A — Premier Line

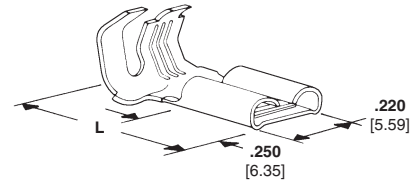

B — Budget Line

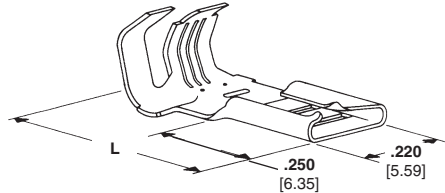

C — Economy Line

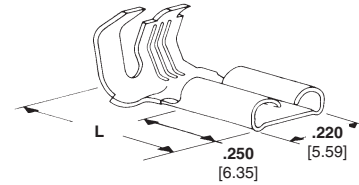

D — Moldable Line

Wire Range AWG	Style	Tab Fit	Insulation Diameter	Material and Finish	Stock Thickness	L (Overall Length)	UL	RA	CFR	Terminal Part Number	
20-16	A	.020 0.51	.110-.170 2.79-4.32	Brass	.012 0.31	.530 13.46	X	—	X	42486-1	
		.020 0.51	.110-.170 2.79-4.32	Brass, Tin Plated	.012 0.31	.530 13.46	X	—	X	42486-2	
		.020 0.51	.110-.170 2.79-4.32	Steel, Nickel Plated	.012 0.31	.530 13.46	—	X	X	42486-3	
		.020 0.51	.110-.170 2.79-4.32	Brass, Silver Plated	.012 0.31	.530 13.46	X	—	X	42486-4	
		.032 0.81	.110-.170 2.79-4.32	Brass, Tin Plated	.012 0.31	.530 13.46	X	—	X	62591-1	
		.032 0.81	.110-.170 2.79-4.32	Steel, Nickel Plated	.012 0.31	.530 13.46	—	X	X	63696-1	
		.020 0.51	.110-.170 2.79-4.32	Brass	.012 0.31	.530 13.46	X	—	X	42618-1	
		.020 0.51	.110-.170 2.79-4.32	Brass, Tin Plated	.012 0.31	.530 13.46	X	—	X	42618-2	
		.020 0.51	.170-.225 4.32-5.72	Brass	.012 0.31	.575 14.61	X	—	X	62817-1	
		.032 0.81	.110-.170 2.79-4.32	Brass	.012 0.31	.530 13.46	X	—	X	63748-1	
	C	.020 0.51	.110-.170 2.79-4.32	Brass	.012 0.31	.530 13.46	X	—	X	42800-1	
		.020 0.51	.110-.170 2.79-4.32	Brass, Tin Plated	.012 0.31	.530 13.46	X	—	X	42800-2	
		.032 0.81	.110-.170 2.79-4.32	Brass	.012 0.31	.530 13.46	X	—	X	60529-1	
		.032 0.81	.110-.170 2.79-4.32	Brass, Tin Plated	.012 0.31	.530 13.46	X	—	X	60529-2	
		D	.020 0.51	.110-.170 2.79-4.32	Brass	.012 0.31	.530 13.46	X	—	X	61029-1
			.020 0.51	.110-.170 2.79-4.32	Brass, Tin Plated	.012 0.31	.530 13.46	X	—	X	61029-2
	18-14 (2)18	B	.032 0.81	.110-.190 2.79-4.83 (2) .105 Max. 2.67	Brass, Tin Plated	.014 0.36	.530 14.36	X	—	X	1217027-1

Note: All part numbers are RoHS compliant.

187 Series C-Crimp Flag Receptacles

C-Crimp Line

A — 187 Series C-Crimp Flag Receptacles

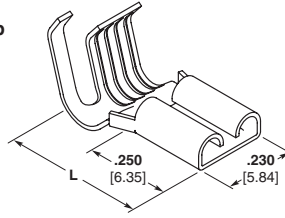

Wire Range AWG	Style	Tab Fit	Insulation Diameter	Material and Finish	Stock Thickness	L (Overall Length)	UL	RU	SP	Terminal Part Number
20-16	A	.020 0.51	.090-.130 2.29-3.30	Brass	.014 0.36	.522 13.26	X	—	X	1217009-1
		.020 0.51	.090-.130 2.29-3.30	Brass, Tin Plated	.014 0.36	.522 13.26	X	—	X	1217009-2
		.032 0.81	.090-.130 2.29-3.30	Brass	.014 0.36	.522 13.26	X	—	X	1217010-1
		.032 0.81	.090-.130 2.29-3.30	Brass, Tin Plated	.014 0.36	.522 13.26	X	—	X	1217010-2
18-14	A	.032 0.81	.100-.155 2.54-3.94	Brass	.016 0.41	.535 13.59	X ¹	—	X ¹	1217244-1
		.032 0.81	.100-.155 2.54-3.94	Brass, Tin Plated	.016 0.41	.535 13.59	X	—	X	1217244-2
		.032 0.81	.100-.155 2.54-3.94	Phos. Bronze	.016 0.41	.535 13.59	X ¹	—	X ¹	1217527-1
		.032 0.81	.100-.155 2.54-3.94	Phos. Bronze, Tin Plated	.016 0.41	.535 13.59	X	—	X	1217527-2

¹ 16 & 18 AWG only.

187 Series F-Crimp Flags

F-Crimp Line

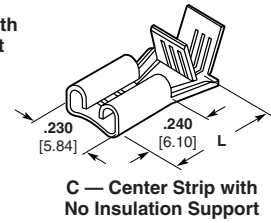
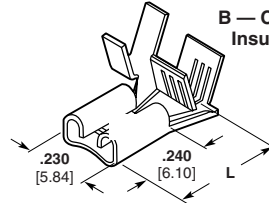
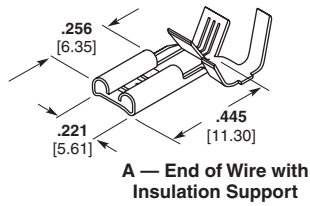

Wire Range AWG	Style	Tab Fit	Insulation Diameter	Material and Finish	Stock Thickness	L (Overall Length)	UL	RU	SP	Terminal Part Number
22-18	A	.020 0.51	.060-.110 1.52-2.79	Brass	0.012 0.31	0.445 11.30	X	—	X	1742086-1
		.020 0.51	.060-.110 1.52-2.79	Brass, Tin Plated	0.012 0.31	0.445 11.30	X	—	X	1742086-2
		.032 0.81	.060-.110 1.52-2.79	Brass	0.012 0.31	0.445 11.30	X	—	X	1742087-1
		.032 0.81	.060-.110 1.52-2.79	Brass, Tin Plated	0.012 0.31	0.445 11.30	X	—	X	1742087-2
20-16	B	.020 0.51	.090-.130 2.29-3.30	Brass	.012 0.31	.596 15.14	—	—	—	626412-1
		.020 0.51	.060-.150 1.52-3.81	Brass	.016 0.41	.430 10.92	X	—	X	63512-1
18-14	B	.032 0.81	.060-.150 1.52-3.81	Brass	.016 0.41	.430 10.92	X	—	X	63316-1
		.032 0.81	.060-.150 1.52-3.81	Brass, Tin Plated	.016 0.41	.430 10.92	X	—	X	63316-2
	C	.032 0.81	—	Steel, Nickel Plated	.016 0.41	.430 10.92	—	X	X	63316-3
		.032 0.81	—	Brass	.016 0.41	.430 10.92	X	—	X	63317-1
18-14 or (2) 18	A	.020 0.51	.110-.150 or 2-110 2.79-3.81 or 2-2.79 max	Brass	0.012 0.31	0.445 11.30	X ¹	—	X ¹	1742088-1
		.020 0.51	.110-.150 or 2-110 2.79-3.81 or 2-2.79 max	Brass, Tin Plated	0.012 0.31	0.445 11.30	X ¹	—	X ¹	1742088-2
		.032 0.81	.110-.150 or 2-110 2.79-3.81 or 2-2.79 max	Brass	0.012 0.31	0.445 11.30	X ¹	—	X ¹	1742089-1
		.032 0.81	.110-.150 or 2-110 2.79-3.81 or 2-2.79 max	Brass, Tin Plated	0.012 0.31	0.445 11.30	X ¹	—	X ¹	1742089-2
18 or (2) 18	A	.020 0.51	.110-.150 or 2-110 2.79-3.81 or 2-2.79 max	Steel, Nickel Plated	0.012 0.31	0.445 11.30	—	X ¹	—	1742312-1
		.032 0.81	.110-.150 or 2-110 2.79-3.81 or 2-2.79 max	Steel, Nickel Plated	0.012 0.31	0.445 11.30	—	X ¹	—	1742049-1

¹ UL/CSA Approved for 18 & 16 AWG only

Note: All part numbers are RoHS compliant.

125 Series Receptacles

Insulation Support

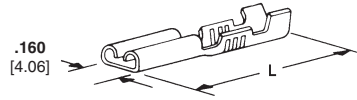

A- Receptacle with Insulation Support

Wire Range AWG	Style	Tab Fit	Insulation Diameter	Material and Finish	Stock Thickness	L (Overall Length)	UL	RA	SP	Terminal Part Number
22-18	A	.020 0.51	.090-.110 2.29-2.79	Brass	.010 0.25	.635 16.13	—	—	—	63705-1

110 Series Receptacles

Straight Receptacles

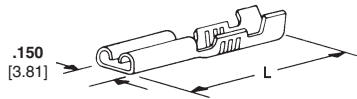

A — FASTON Receptacles with Insulation Support

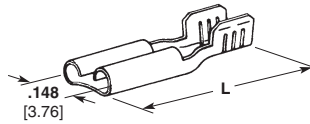

B — FASTON Receptacles with No Insulation Support

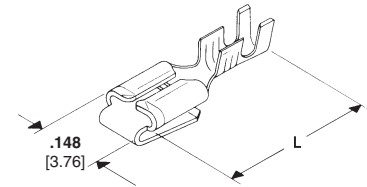

C — Commercial Line Receptacle and Tab Combination

Wire Range AWG	Style	Fits Tab Type ⁷	Tab Fit	Insulation Diameter	Material and Finish	Stock Thickness	L (Overall Length)	UL	RA	SP	Terminal Part Number
30-28	A	1	.020 0.51	.020-.040 0.51-1.02	Brass, Pre-Tin	.010 0.25	.560 14.22	—	—	—	62585-1
26-22	B	—	.020 0.51	—	Brass, Tin Plated	.010 0.25	.327 8.31	—	—	—	63837-1
		—	.016 0.41	—	Brass	.010 0.25	.327 8.31	—	—	—	61818-1
24-22	A	1	.016 0.41	.040-.060 1.02-1.52	Brass, Pre-Tin	.010 0.25	.635 16.13	—	—	—	42415-1
		1	.020 0.51	.040-.060 1.02-1.52	Brass, Pre-Tin	.010 0.25	.635 16.13	X ¹	—	X	42067-1
		1	.020 0.51	.040-.060 1.02-1.52	Brass, Pre-Tin	.010 0.25	.510 12.95	X	—	X	60089-2
		1	.032 0.81	.040-.060 1.02-1.52	Brass, Pre-Tin	.010 0.25	.635 16.13	X ¹	—	X	63634-1
22-20	A	2	.020 0.51	.060-.100 1.52-2.54	Brass, Pre-Tin	.010 0.25	.635 16.13	X	—	X	42236-1
22-18	A	1	.012 0.31	.060-.100 1.52-2.54	Brass, Pre-Tin	.010 0.25	.635 16.13	—	—	—	60415-1
		1	.016 0.41	.060-.100 1.52-2.54	Brass, Pre-Tin	.010 0.25	.635 16.13	—	—	—	60118-1
		2	.016 0.41	.090-.130 1.52-2.54	Brass, Pre-Tin	.010 0.25	.635 16.13	—	—	—	62523-1
		1	.020 0.51	.060-.100 1.52-2.54	Brass	.010 0.25	.635 16.13	X	—	X	42068
		1	.020 0.51	.060-.100 1.52-2.54	Brass, Pre-Tin	.010 0.25	.635 16.13	X	—	X	42068-1
		1	.020 0.51	.090-.130 1.52-2.54	Brass, Pre-Tin	.010 0.25	.635 16.13	X	—	X	62094-1
		1	.020 0.51	.090-.130 1.52-2.54	Brass	.010 0.25	.635 16.13	X	—	X	62094-2
		2	.020 0.51	.120-.140 3.05-3.56	Brass, Pre-Tin	.010 0.25	.635 16.13	X	—	X	60729-1
		2	.025 0.51	.120-.140 3.05-3.56	Brass, Pre-Tin	.010 0.25	.635 16.13	—	—	—	63568-1
		1	.025 0.51	.120-.140 3.05-3.56	Brass, Pre-Tin	.010 0.25	.635 16.13	—	—	—	61158-1
		1	.032 0.81	.060-.100 1.52-2.54	Brass, Pre-Tin	.010 0.25	.635 16.13	X	—	X	60197-1
3	.032 0.81	.060-.100 1.52-2.54	Brass, Pre-Tin	.010 0.25	.635 16.13	X	—	X	60577-1		

¹ UL listed 22 AWG wire only.

² No Dimple.

⁴ Side feed.

³ Dimple at special location.

⁵ Tab Thickness .020 [0.51].

⁶ Tab Thickness .032 [0.81].

⁷ Stress relieved.

⁸ See page 29 for Mating Tab Designs.

Note: All part numbers are RoHS compliant.

110 Series Receptacles (Continued)

Straight Receptacles (Continued)

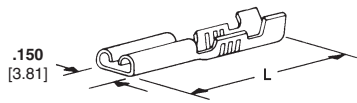

A — FASTON Receptacles with Insulation Support

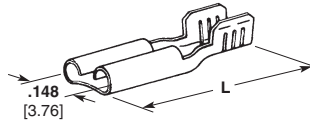

B — FASTON Receptacles with No Insulation Support

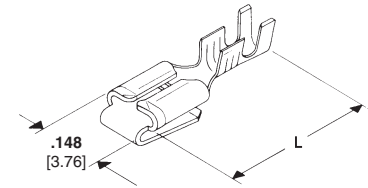

C — Commercial Line Receptacle and Tab Combination

FASTON Receptacles

Wire Range AWG	Style	Fits Tab Type ^a	Tab Fit	Insulation Diameter	Material and Finish	Stock Thickness	L (Overall Length)	UL	RA	SP	Terminal Part Number
22-18	A	1	.032 0.81	.120-.140 3.05-3.56	Brass, Pre-Tin	.010 0.25	.635 16.13	X	—	X	63954-1
		1	.018 0.46	.080-.120 2.03-3.05	Brass	.010 0.25	.630 16.00	—	—	—	63242-1 ⁵
	C	1	.020 0.51	.060-.100 1.52-2.54	Brass	.010 0.25	.630 16.00	X	—	X	62003-1 ⁵
		1	.020 0.51	.060-.100 1.52-2.54	Brass, Tin Plated	.010 0.25	.630 16.00	X	—	X	62003-2 ⁵
		1	.032 0.81	.080-.120 2.03-3.05	Brass, Tin Plated	.010 0.25	.630 16.00	X	—	X	63961-1 ⁵
		1	.032 0.81	.080-.120 2.03-3.05	Brass, Tin Plated	.010 0.25	.630 16.00	—	—	—	1217145-1 ⁶
20-18 (2) 20	B	1	.016 0.41	—	Brass, Pre-Tin	.010 0.25	.475 12.07	—	—	—	42398-1
		2	.016 0.41	—	Brass, Pre-Tin	.010 0.25	.475 12.07	X	—	X	60967-1
		1	.020 0.51	—	Brass, Pre-Tin	.010 0.25	.475 12.07	X	—	X	42399-1
		1	.020 0.51	—	Brass	.010 0.25	.475 12.07	X	—	X	42399-2
		1	.025 0.64	—	Brass, Pre-Tin	.010 0.25	.475 12.07	—	—	—	62345-1
		1	.032 0.81	—	Brass, Pre-Tin	.010 0.25	.475 12.07	X	—	X	60601-1
20-18	B	—	.020 0.51	—	Brass, Pre-Tin	.010 0.25	.380 9.65	X	—	X	62850-1 ²
		—	.020 0.51	—	Brass, Tin Plated	.010 0.25	.380 9.65	X	—	X	62850-2 ²
20-16	A	1	.010 0.25	.060-.100 1.52-2.54	Brass, Pre-Tin	.010 0.25	.625 15.88	—	—	—	62968-1
		1	.020 0.51	.060-.100 1.52-2.54	Brass, Pre-Tin	.010 0.25	.635 16.13	X	—	X	61408-1
		1	.020 0.51	.060-.100 1.52-2.54	Steel, Nickel Plated	.010 0.25	.635 16.13	—	X	X	1217102-1
		1	.020 0.51	.120-.140 3.05-3.56	Brass, Pre-Tin	.010 0.25	.635 16.13	X	—	X	61400-1
	B	1	.020 0.51	.150-.170 3.81-4.32	Brass, Tin Plated	.010 0.25	.635 16.13	X	—	X	62191-1
		1	.032 0.81	.120-.140 3.05-3.56	Brass, Pre-Tin	.010 0.25	.635 16.13	X	—	X	62050-1
		1	.032 0.81	.120-.140 3.05-3.56	Steel, Nickel Plated	.010 0.25	.635 16.13	—	X	X	62050-2
		2	.032 0.81	.120-.140 3.05-3.56	Brass, Pre-Tin	.010 0.25	.635 16.13	X	—	X	63703-1
		1	.016 0.41	—	Brass, Pre-Tin	.010 0.25	.537 13.64	—	—	—	61457-1
		2	.020 0.51	—	Brass, Pre-Tin	.010 0.25	.537 13.64	X	—	X	63471-1
18-14	A	—	.032 0.81	.110-.190 2.79-4.83	Brass, Tin Plated	.012 0.30	.625 15.88	—	—	—	63093-1 ^{2,7}
		—	.020 0.51	—	Brass, Tin Plated	.010 0.25	.475 12.07	X	—	X	62474-1 ^{3,4}
	B	1	.020 0.51	—	Brass, Pre-Tin	.010 0.25	.475 12.07	X	—	X	62852-1 ⁴

¹ UL listed 22 AWG wire only.

² No Dimple.

⁴ Side feed.

³ Dimple at special location.

⁵ Tab Thickness .020 [0.51].

⁶ Tab Thickness .032 [0.81].

⁷ Stress relieved.

⁸ See page 29 for Mating Tab Designs.

Note: All part numbers are RoHS compliant.

110 Series F-Crimp Flags

Flag Receptacles

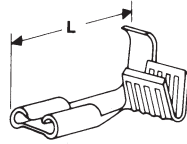

A — FASTON Flag Receptacle with Insulation Support

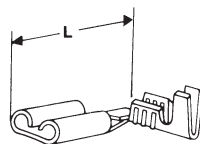

B — FASTON Flag Receptacle with Insulation Support

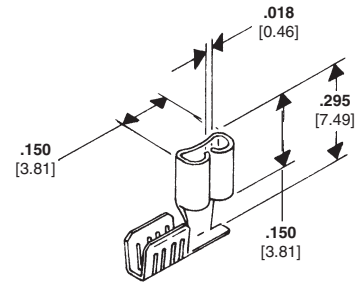

C — FASTON Flag Receptacle with No Insulation Support

Wire Range AWG	Style	Fits Tab Type ²	Tab Fit	Insulation Diameter	Material and Finish	Stock Thickness	L (Overall Length)	UL	CSA	RoHS	Terminal Part Number
26-22	B	*	.020 0.51	.040-.080 1.02-2.03	Brass, Pre-Tin	.010 0.25	.430 10.92	X ³	—	X ³	1742219-1
		*	.016 0.41	.065-.100 1.65-2.54	Brass, Pre-Tin	.010 0.25	.460 11.68	—	—	—	61459-1
		*	.020 0.51	.065-.100 1.65-2.54	Brass, Pre-Tin	.010 0.25	.460 11.68	X	—	X	61372-1
	A	*	.020 0.51	.065-.100 1.65-2.54	Brass, Tin Plated	.012 0.30	.460 11.68	X	—	X	60605-1
		*	.025 0.64	.065-.100 1.65-2.54	Brass, Pre-Tin	.010 0.25	.460 11.68	—	—	—	61530-1
		*	.025 0.64	.065-.100 1.65-2.54	Brass, Tin Plated	.012 0.30	.460 11.68	—	—	—	63592-1
22-18	A	*	.032 0.81	.065-.100 1.65-2.54	Brass, Pre-Tin	.010 0.25	.460 11.68	X	—	X	61971-1
		*	.020 0.51	.060-.100 1.52-2.54	Brass, Pre-Tin	.010 0.25	.430 10.92	X	—	X	61481-1
		*	.020 0.51	.060-.100 1.52-2.54	Brass, Tin Plated	.012 0.30	.430 10.92	X	—	X	61070-1
	B	*	.020 0.51	.060-.100 1.52-2.54	Brass	.012 0.30	.430 10.92	X	—	X	61070-2
		*	.025 0.64	.060-.100 1.52-2.54	Brass, Pre-Tin	.010 0.25	.430 10.92	—	—	—	1217138-1
		*	.032 0.81	.060-.100 1.52-2.54	Brass, Pre-Tin	.010 0.25	.430 10.92	X	—	X	62336-1
22-16	C	—	.015 0.38	—	Brass, Pre-Tin	.010 0.25	.295 7.49	—	—	—	63990-1
		—	.020 0.51	—	Brass	.012 0.30	.295 7.49	X ¹	—	X	60991-1
		—	.020 0.51	—	Brass, Pre-Tin	.010 0.25	.295 7.49	X ¹	—	X	61549-1
	1	.020 0.51	—	Brass, Pre-Tin	.010 0.25	.295 7.49	X ¹	—	X	62321-1	

* No Tab Type
¹ UL listed and CSA certified for 22-18 AWG.
² See below for Mating Tab Designs.
³ UL listed and CSA certified for 22 AWG wire only.

Mating 110 Series Tab Designs

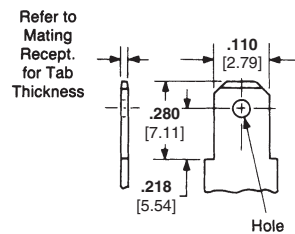

Mating 110 Series Tab Dimension Type 1

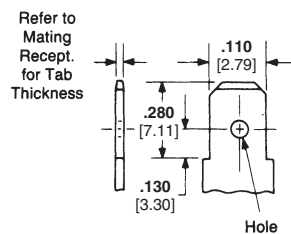

Mating 110 Series Tab Dimensions Type 2

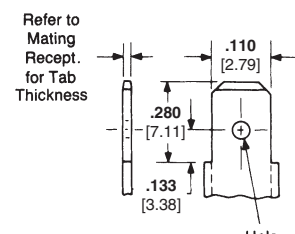

Mating 110 Series Tab Dimensions Type 3

Note: All part numbers are RoHS compliant.

AMPLIVAR Receptacles

250 Series FASTON Receptacles

Stock Thickness — .016 [0.41]

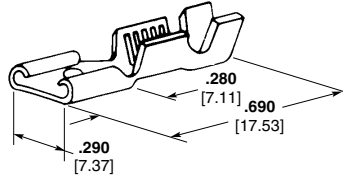

Magnet Wire Range AWG	mm ²	Insulation Diameter	Mating Tab Thk.	Material	Material Thickness	Part Number	Applicator No.
24-19	0.23-0.70	.050-.080 1.30-2.00	.020 0.51	Brass Tin Plated Brass	.016 0.41	63623-1 ¹ 63623-2 ¹	567451-2 ²
23-19 or (2) 24 or (2) 26	0.29-0.70 or (2) 0.23 or (2) 0.15	.050-.100 1.30-2.55	.025 0.64	Brass	.016 0.41	62069-1 ³	567343-2 ²
20-16 or (2) 23 or (2) 20	0.57-1.39 or (2) 0.29 or (2) 0.57	.100-.140 2.55-3.55 or (2) .060 Max. 1.52	.032 [0.81]	Brass Tin Plated Brass	.016 0.41	60384-1 60384-2	466010-1 ²
20-16	0.57-1.39	.100-.140 2.55-3.55	.020 0.51	Brass	.016 0.41	62080-1	466010-1 ²
18-14 or (2) 17	0.88-2.19 or (2) 1.11	.120-.170 3.05-4.30 or (2) .060 Max. 1.52	.032 [0.81]	Tin Plated Brass	.016 0.41	60385-2	466816-1 ²
18-14 or (2) 19	0.88-2.19 or (2) 0.70	.120-.170 3.05-4.30	.020 0.51	Brass	.016 0.41	63622-1 ¹	466816-1 ²
18-14 or (2) 19	0.88-2.19 or (2) 0.70	.120-.170 3.05-4.30	.032 0.81	Brass	.016 0.41	1217835-1	466816-1 ²

¹ Low insertion force

² Quick-Change Applicator for AMP-O-LECTRIC Machine 565435-5.

³ Mates to .025 [0.64] thick tab.

Note: All part numbers are RoHS compliant.

FASTON Receptacles

AMPLIVAR Receptacles (Continued)

187 Series FASTON Flag Receptacles

Stock Thickness — .016 [0.41]

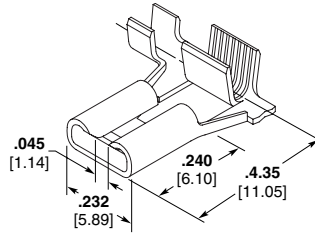

Magnet Wire Range		Insulation Diameter	Mating Tab Thk.	Material	Material Thickness	Part Number	Applicator No.
CMA	mm ²						
500-1200	0.25-0.61	.020-.040 0.51-1.02	.020 0.51	Tin Plated Brass	.016 0.41	63942-1	566411-1 ¹
24-20 AWG	0.2-0.5	.020-.040 0.51-1.02	.032 0.81	Tin Plated Brass	.016 0.41	1217624-1	566411-1 ¹
1200-2350	0.61-1.19	.020-.040 0.51-1.02	.020 0.51	Tin Plated Brass	.016 0.41	63941-1	566410-1 ¹
2000-4000	1.01-2.03	.020-.040 0.51-1.02	.032 0.81	Tin Plated Brass	.016 0.41	1217955-1	566429-1
2000-4050	1.01-2.05	.020-.040 0.51-1.02	.020 0.51	Tin Plated Brass	.016 0.41	63940-1	680353-3 ²
2000-4050	1.01-2.05	.020-.040 0.51-1.02	.032 0.81	Tin Plated Brass	.016 0.41	1217417-1	680353-3 ²
3000-6000	1.52-3.04	.020-.040 0.51-1.02	.020 0.51	Tin Plated Brass	.016 0.41	1217899-1	566426-1

¹ Standard Applicator for "G" Splice Terminator No. 356462-2.

² Quick-Change Applicator for "G" Splice Terminator No. 356462-1.

250 Series FASTON Flag Receptacles

Stock Thickness — .018 [0.45]

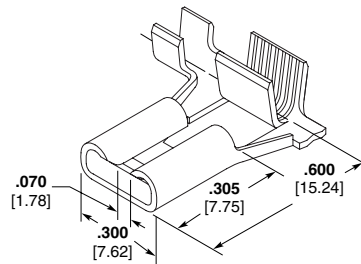

Magnet Wire Range		Insulation Diameter	Mating Tab Thk.	Material	Material Thickness	Part Number	Applicator No.
AWG	mm ²						
16-12	1.39-3.47	.120-.170 3.05-4.32	.032 0.81	Tin Plated Phos Bronze	.018 0.45	63944-1	680421-3 ¹

¹ Quick-Change Applicator for "G" Splice Terminator No. 356462-1.

Note: All part numbers are RoHS compliant.

Miscellaneous Tab Receptacles

Tab Receptacles

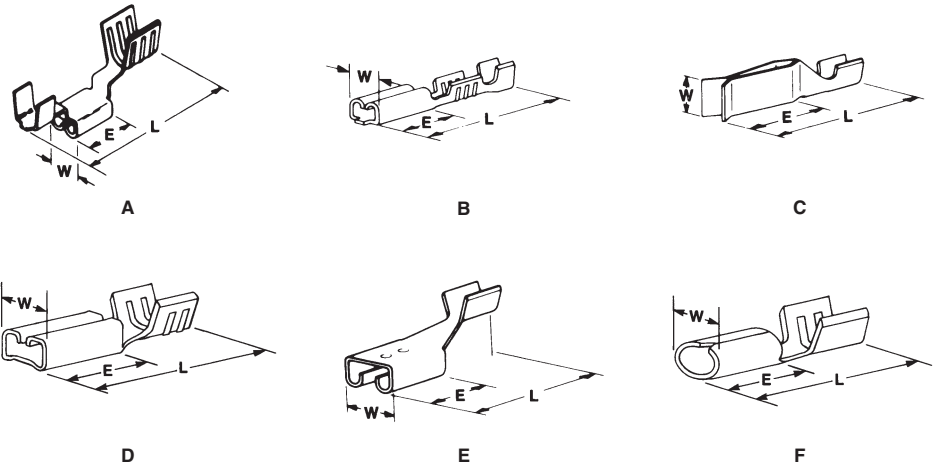

FASTON Receptacles

Wire Range		Type	Insul. Dia. Range	Stock Thk.	Material and Finish	Fits Tab	Dimensions			Part No.		
AWG	mm ²						E	L	W			
26-22	0.12-0.4	B	.035-.065 0.89-1.65	.010 .025	Pre-Tin Brass	.031 x .093 0.79 x 2.36	.190	.475	.120	61813-1 ⁵		
		4.83					12.06	3.05				
24-20	0.2-0.6	A	.040-.080 1.02-2.03	.010 0.25	Brass	.045 x .045 1.14 x 1.14	.130	.372	.095	60524-1		
							3.3	9.45	2.41			
							Tin Plated Beryllium Copper	.130	.372		.095	
								3.3	9.45		2.41	
		B	.040-.080 1.02-2.03	.010 0.25	Tin Plated Brass	.031 x .062 0.79 x 1.57	.187	.462	.090	60900-1 ¹		
							4.75	11.73	2.29			
							Gold Plated Brass	.187	.462		.090	
								4.75	11.73		2.29	
							Tin Plated Brass	.031 x .062 0.79 x 1.57	.187		.462	.090
								4.75	11.73		2.29	
F	—	.010 0.25	Tin Plated Brass	.015 x .050 0.38 x 1.27	.145	.310	.070	62352-1				
					3.68	7.87	1.78					
22-20	0.3-0.6	E	—	.010 0.25	Tin Plated Brass	.037 x .125 0.94 x 3.18	.190	.425	.160	41989		
							4.83	10.8	4.06			
22-18	0.3-0.9	A	.060-.110 1.52-2.79	.010 0.25	Tin Plated Brass	.031 x .062 0.79 x 1.57	.130	.372	.090	61489-1		
							3.3	9.45	2.29			
		B			.050-.085 1.27-2.16	.010 0.25	Pre-Tin Brass	.010 x .093 0.25 x 2.36	.190	.480	.120	63391-1 ^{3,4}
									4.83	12.19	3.05	
20-18	0.5-0.9	B	.080-.120 2.03-3.05	.010 0.25	Pre-Tin Brass	.032 x .103 0.81 x 2.62	.200	.480	.126	60252-1 ⁶		
							5.08	12.19	3.2			
							Tin Plated Brass	.020 x .103 0.51 x 2.62	.200		.480	.126
		5.08			12.19	3.2						
		D			—	.010 0.25	Brass	.010 x .110 0.25 x 2.79	.200	.380	.148	62589-1
									5.08	9.65	3.76	
18-14	0.8-2.0	C	—	.025 0.64	Brass	.060 x .250 1.52 x 6.35	.520	.985	.250	60312-1		
							13.2	25.02	6.35			

¹ Available in loose piece form, order Part Number 61454-1.
² Reverse reel of 60900-1.
³ Loose piece form of Part Number 63391-2.
⁴ Mechanically compliant base.
⁵ No dimple.
⁶ Dimple.
⁷ Reverse reel of Part Number 60900-2.

Note: All part numbers are RoHS compliant.