

4

3

2

1

THIS DRAWING IS UNPUBLISHED. RELEASED FOR PUBLICATION .19
COPYRIGHT 19 BY AMP INCORPORATED. ALL RIGHTS RESERVED.

CAD
DO NOT REVISE
EXCEPT BY CAD

LOC	DIST	REVISED			
AP	-	P	LTR	DESCRIPTION	DATE
		B	LT	NEW DASHES ADDED EC-111/04	06APR04
				REVISION	DWN
				DESCRIPTION	DES
				BY	APVD
					APR
					PLF

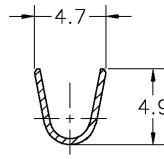
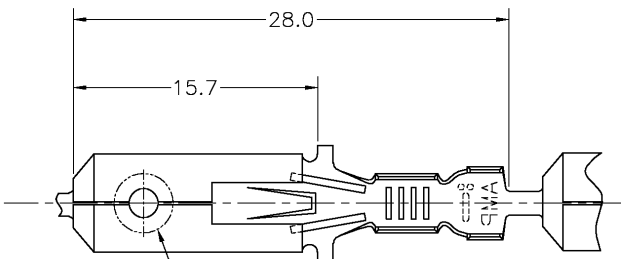

SECTION B-B

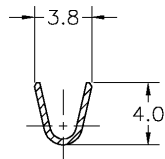

SECTION A-A

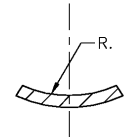

SECTION D-D

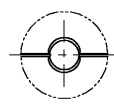

DETAIL Z
CONSTRUÇÃO OPCIONAL
OPTIONAL CONSTRUCTION

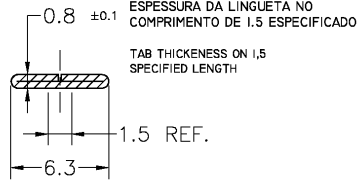
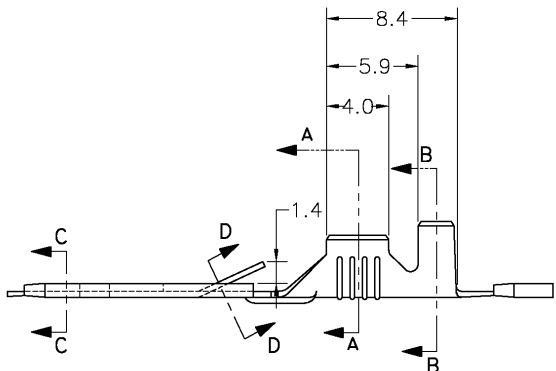

SECTION C-C

WIRE RANGE (mm ²)	>1,0 - 2,5 mm ²
INSUL. RANGE (g mm ²)	2,1 - 2,9 mm

THIS DRAWING IS A CONTROLLED DOCUMENT.	
DIMENSIONS: DIMENSÕES MM	TOLERANCES UNLESS OTHERWISE SPECIFIED: TOLERÂNCIAS NÃO ESPECIFICADAS
0 PLC/DEC ± -	1 PLC/DEC ± 0,3
1 PLC/DEC ± -	2 PLC/DEC ± -
2 PLC/DEC ± -	3 PLC/DEC ± -
3 PLC/DEC ± -	4 PLC/DEC ± -
4 PLC/DEC ± -	ANGLES/ANGULARES ± 1°
MATERIAL SEE TABLE	FINISH ACABAMENTO SEE TABLE

① TIN PLATED / ESTANHADO	BRONZE FOSF./PHOSP. BRONZE	444152-4
② ---/---	BRONZE FOSF./PHOSP. BRONZE	444152-3
TIN PLATED / ESTANHADO	LATÃO / BRASS	444152-2
---/---	LATÃO / BRASS	444152-1
FINISH	MATERIAL	PART NUMBER

DWN/DES	A. PERUSSI	15SEP99
CHK/CH	P. L. FARIA	-
APVD/APP	L. G. DALTO	-
PRODUCT SPEC	-	-
APPLICATION SPEC	-	-
WEIGHT	-	-
SIZE	CAGE CODE	DRAWING NO
A3	00779	444152
CUSTOMER DRAWING/DESENHO DE CLIENTE		RESTRICTED TO
SCALE	SHEET	REV
ESCALA 4:1	FOLHA 1 DE 1	B

AMP AMP do BRASIL Ltda.
São Paulo - Brasil

.250 SER. FASTIN - FASTON TAB