

THIS DRAWING IS UNPUBLISHED. REPRODUCED FOR INFORMATION ONLY.
 © 2008 Tyco Electronics Corporation. ALL RIGHTS RESERVED.

REV	DATE	DESCRIPTION	BY	CHKD
AF 58				
C1		REV PER EDR 10-08603	DMR10	JR PD

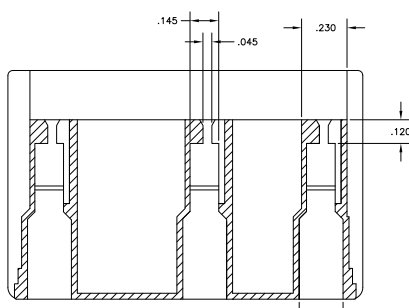
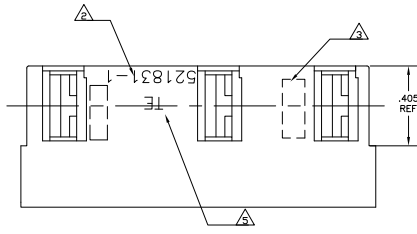
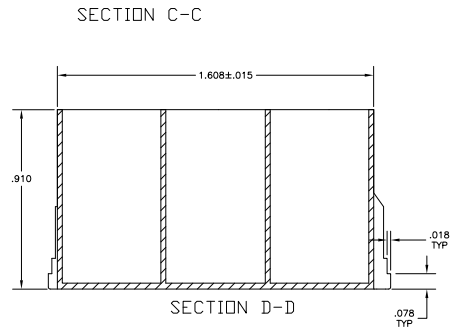
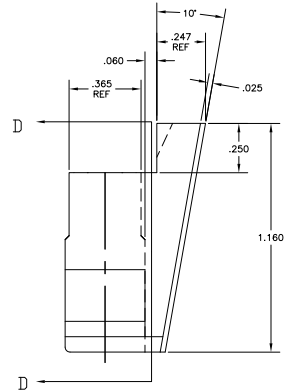
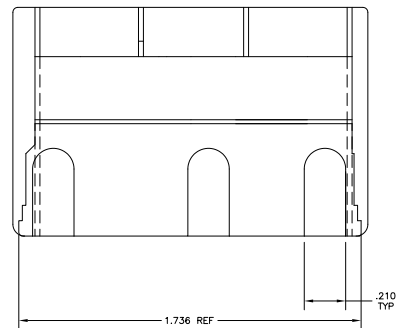
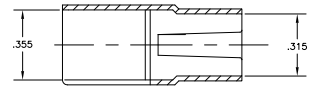
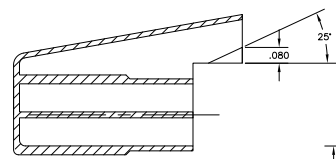
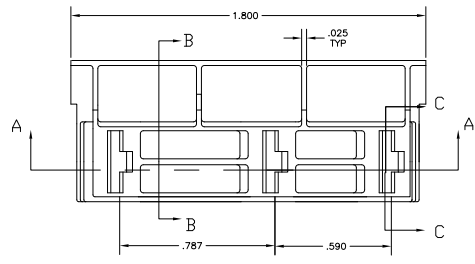

- 1 ALL 3 INTERNAL CAVITY ARE IDENTICAL.
- △ TE LOGG, SIZE AND LOCATION APPROX AS SHOWN
- △ DFE SYMBOL >PA66/G<, LOCATED APPROX AS SHOWN.
- 4 PART TO BE USED WITH TERMINAL 1742291-1
- △ TE P/N, LOCATED APPROX AS SHOWN

521831-1
PART NO

THIS DRAWING IS A CONTROLLED DOCUMENT.		REV	DATE	BY	CHKD
DRAWING NO: 521831-1		AF 58			
REVISED BY: C1					
DATE: 10/08/08					
BY: JRM					
CHKD: JRM					
TITLE: HOUSING, RECEPTACLE, FASTEN-FASTON, .250 SERIES, 3 POSITION					
MATERIAL: 66/A NYLON, V0					
COLOR: WHITE					
CUSTOMER DRAWING					
SIZE: A1					
DRAWING NO: 00779					
PART NO: 521831					
SCALE: 1:1					
SHEET: 1					
OF: 1					