

PTA 1,5/14-3,5

Order No.: 1989078

The figure shows a 10-position version of the product

<http://eshop.phoenixcontact.de/phoenix/treeViewClick.do?UID=1989078>

PC terminal block, Nominal current: 17.5 A, Nom. voltage: 160 V, Pitch: 3.5 mm, Number of positions: 14, Type of connection: Screw connection, Assembly: Soldering, Conductor/PCB connection direction: 45 °, Color: green

Commercial data

EAN	4046356037068
Pack	50 pcs.
Customs tariff	85369010
Weight/Piece	0.00707 KG
Catalog page information	Page 467 (CC-2009)

Product notes

WEEE/RoHS-compliant since:
08/26/2003

<http://www.download.phoenixcontact.com>
Please note that the data given here has been taken from the online catalog. For comprehensive information and data, please refer to the user documentation. The General Terms and Conditions of Use apply to Internet downloads.

Technical data

Dimensions / positions

Pitch	3.5 mm
Dimension a	45.5 mm
Number of positions	14

Pin dimensions	0,9 mm
Pin spacing	3.5 mm
Hole diameter	1.2 mm
Screw thread	M2
Tightening torque, min	0.22 Nm
Tightening torque max	0.25 Nm

Technical data

Insulating material group	I
Rated surge voltage (III/3)	2.5 kV
Rated surge voltage (III/2)	2.5 kV
Rated surge voltage (II/2)	2.5 kV
Rated voltage (III/2)	200 V
Rated voltage (II/2)	400 V
Connection in acc. with standard	EN-VDE
Nominal current I_N	17.5 A
Nominal voltage U_N	160 V
Nominal cross section	1.5 mm ²
Maximum load current	17.5 A (current values dependent on no. of pos., dimensioning of printed circuits, and ambient temperature)
Insulating material	PA
Inflammability class acc. to UL 94	V0
Stripping length	5 mm

Connection data

Conductor cross section solid min.	0.14 mm ²
Conductor cross section solid max.	1.5 mm ²
Conductor cross section stranded min.	0.14 mm ²
Conductor cross section stranded max.	1.5 mm ²
Conductor cross section stranded, with ferrule with plastic sleeve min.	0.25 mm ²
Conductor cross section stranded, with ferrule with plastic sleeve max.	0.75 mm ²
Conductor cross section AWG/kcmil min.	26
Conductor cross section AWG/kcmil max	16
2 conductors with same cross section, solid min.	0.14 mm ²
2 conductors with same cross section, solid max.	0.5 mm ²

2 conductors with same cross section, stranded min.	0.14 mm ²
2 conductors with same cross section, stranded max.	0.5 mm ²

Certificates / Approvals



Certification CUL, UL

CUL

Nominal voltage U _N	300 V
Nominal current I _N	10 A
AWG/kcmil	26-16

UL

Nominal voltage U _N	300 V
Nominal current I _N	10 A
AWG/kcmil	26-16

Accessories

Item	Designation	Description
Marking		
0804073	SK 3,5/2,8:FORTL.ZAHLEN	Marker card, printed horizontally, self-adhesive, 10-section marker strip, 14 identical decades marked 1-10, 11-20 etc. up to 91-100, sufficient for 140 terminal blocks
Tools		
1205037	SZS 0,4X2,5	Screwdriver, bladed, matches all screw terminal blocks up to 1.5 mm ² connection cross section, blade: 0.4 x 2.5 mm

Diagrams/Drawings

Drilling plan/solder pad geometry

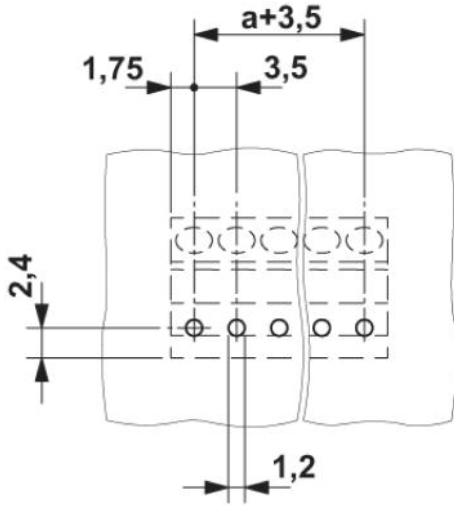

Diagram

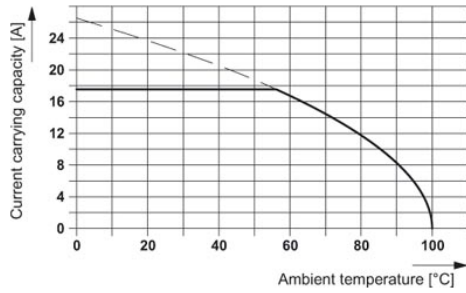

Dimensioned drawing

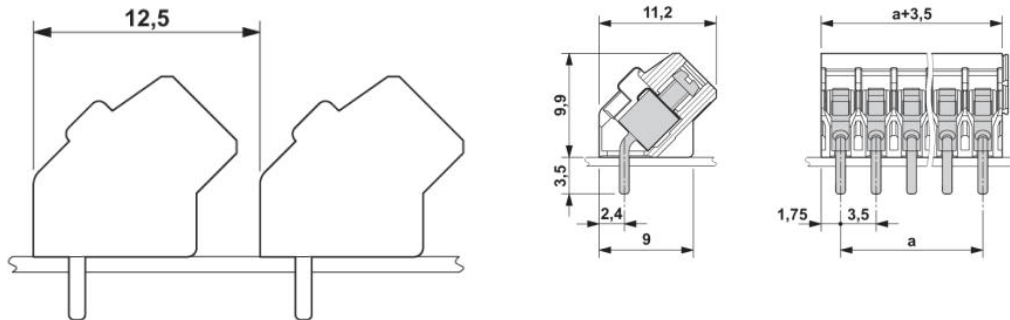

Address

PHOENIX CONTACT Inc., USA
586 Fulling Mill Road
Middletown, PA 17057, USA
Phone (800) 888-7388
Fax (717) 944-1625
<http://www.phoenixcon.com>



© 2010 Phoenix Contact
Technical modifications reserved;