

PTSM 0,5/ 4-2,5-V THR R44

Order No.: 1770979

<http://eshop.phoenixcontact.de/phoenix/treeViewClick.do?UID=1770979>

PC terminal block, Nominal current: 6 A, Nom. voltage: 63 V, Pitch: 2.5 mm, Number of positions: 4, Type of connection: Spring-cage conn., Assembly: SMD/THT/THR, Conductor/PCB connection direction: 90 °, Color: black

Commercial data

EAN	4046356459556
Pack	310 pcs.
Customs tariff	85369010
Weight/Piece	0.00272 KG
Catalog page information	Page 463 (CC-2009)

<http://www.download.phoenixcontact.com>
Please note that the data given here has been taken from the online catalog. For comprehensive information and data, please refer to the user documentation. The General Terms and Conditions of Use apply to Internet downloads.

Technical data**Dimensions / positions**

Length	5 mm
Pitch	2.5 mm
Dimension a	7.5 mm
Number of positions	4
Pin dimensions	0,3 X 0,8 mm
Pin spacing	2.5 mm
Hole diameter	1.2 mm

Technical data

Insulating material group	IIIa
Rated surge voltage (III/3)	2.5 kV
Rated surge voltage (III/2)	2.5 kV
Rated surge voltage (II/2)	2.5 kV
Rated voltage (III/2)	200 V
Rated voltage (II/2)	200 V
Connection in acc. with standard	EN-VDE
Nominal current I_N	6 A
Nominal voltage U_N	63 V
Nominal cross section	0.5 mm ²
Maximum load current	6 A
Insulating material	LCP
Inflammability class acc. to UL 94	V0
Stripping length	6 mm

Connection data

Conductor cross section solid min.	0.14 mm ²
Conductor cross section solid max.	0.5 mm ²
Conductor cross section stranded min.	0.2 mm ²
Conductor cross section stranded max.	0.5 mm ²
Conductor cross section stranded, with ferrule without plastic sleeve min.	0.25 mm ²
Conductor cross section stranded, with ferrule without plastic sleeve max.	0.5 mm ²
Conductor cross section AWG/kcmil min.	24
Conductor cross section AWG/kcmil max	20

Certificates / Approvals

Certification CUL, UL

CUL

Nominal voltage U_N	150 V
Nominal current I_N	5 A
AWG/kcmil	26-20

UL

Nominal voltage U_N	150 V
Nominal current I_N	5 A
AWG/kcmil	26-20

Accessories

Item	Designation	Description
1205202	SZS 0,4X2,0	Screwdriver, bladed, matches all screw terminal blocks up to 1.5 mm ² connection cross section, blade width: 2.5 mm, without approvals

Tools

Diagrams/Drawings

Drilling plan/solder pad geometry

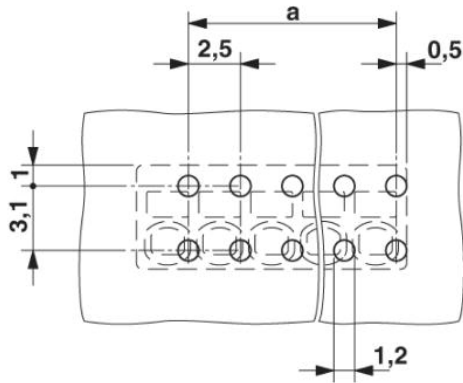

Diagram

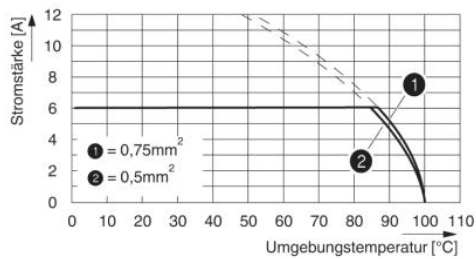

Dimensioned drawing

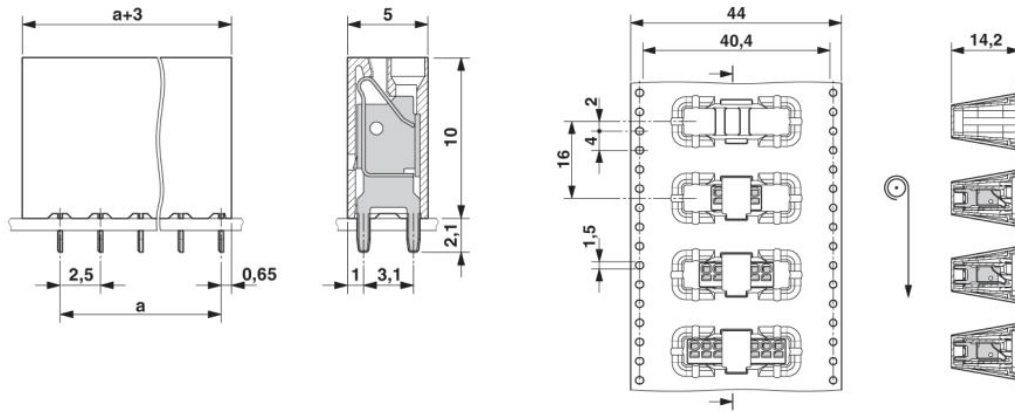

Address

PHOENIX CONTACT Inc., USA
586 Fulling Mill Road
Middletown, PA 17057, USA
Phone (800) 888-7388
Fax (717) 944-1625
<http://www.phoenixcon.com>



© 2010 Phoenix Contact
Technical modifications reserved;