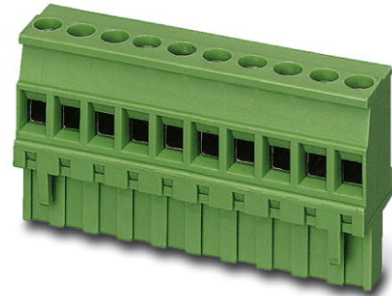

MVSTBR 2,5/ 8-ST

Order No.: 1792074

The figure shows a 10-position version of the product

<http://eshop.phoenixcontact.de/phoenix/treeViewClick.do?UID=1792074>

Plug component, Nominal current: 12 A, Nom. voltage: 250 V, Pitch:
5 mm, Number of positions: 8, Connection type: Screw connection,
Color: green

Commercial data

EAN	4017918044558
Pack	50 pcs.
Customs tariff	85366990
Weight/Piece	0.01711 KG
Catalog page information	Page 202 (CC-2009)

Product notes

WEEE/RoHS-compliant since:
01/01/2003



<http://www.download.phoenixcontact.com>
Please note that the data given here has been taken from the online catalog. For comprehensive information and data, please refer to the user documentation. The General Terms and Conditions of Use apply to Internet downloads.

Technical data

Dimensions / positions

Pitch	5 mm
Dimension a	35 mm
Number of positions	8
Screw thread	M3

Tightening torque, min	0.5 Nm
Tightening torque max	0.6 Nm

Technical data

Insulating material group	I
Rated surge voltage (III/3)	4 kV
Rated surge voltage (III/2)	4 kV
Rated surge voltage (II/2)	4 kV
Rated voltage (III/2)	320 V
Rated voltage (II/2)	630 V
Connection in acc. with standard	EN-VDE
Nominal current I_N	12 A
Nominal voltage U_N	250 V
Nominal cross section	2.5 mm ²
Maximum load current	12 A (with 2.5 mm ² conductor cross section)
Insulating material	PA
Inflammability class acc. to UL 94	V0
Internal cylindrical gage	A3
Stripping length	7 mm

Connection data

Conductor cross section solid min.	0.2 mm ²
Conductor cross section solid max.	2.5 mm ²
Conductor cross section stranded min.	0.2 mm ²
Conductor cross section stranded max.	2.5 mm ²
Conductor cross section stranded, with ferrule without plastic sleeve min.	0.25 mm ²
Conductor cross section stranded, with ferrule without plastic sleeve max.	2.5 mm ²
Conductor cross section stranded, with ferrule with plastic sleeve min.	0.25 mm ²
Conductor cross section stranded, with ferrule with plastic sleeve max.	2.5 mm ²
Conductor cross section AWG/kcmil min.	24
Conductor cross section AWG/kcmil max	12
2 conductors with same cross section, solid min.	0.2 mm ²
2 conductors with same cross section, solid max.	1 mm ²

2 conductors with same cross section, stranded min.	0.2 mm ²
2 conductors with same cross section, stranded max.	1.5 mm ²
2 conductors with same cross section, stranded, ferrules without plastic sleeve, min.	0.25 mm ²
2 conductors with same cross section, stranded, ferrules without plastic sleeve, max.	1 mm ²
2 conductors with same cross section, stranded, TWIN ferrules with plastic sleeve, min.	0.5 mm ²
2 conductors with same cross section, stranded, TWIN ferrules with plastic sleeve, max.	1.5 mm ²

Certificates / Approvals



Certification

CB, CSA, CUL, GOST, UL, VDE-PZI

CSA

Nominal voltage U _N	300 V
Nominal current I _N	10 A
AWG/kcmil	28-12

CUL

Nominal voltage U _N	300 V
Nominal current I _N	10 A
AWG/kcmil	30-12

UL

Nominal voltage U _N	300 V
Nominal current I _N	10 A
AWG/kcmil	30-12

Additional products

Item	Designation	Description
General		
0707060	DFK-MSTB 2,5/ 8-G	Plug component, Nominal current: 12 A, Nom. voltage: 320 V, Nom. voltage: 320 V, Pitch: 5 mm, Number of positions: 8, Color: green, Assembly: Direct mounting
1899906	EMSTBA 2,5/ 8-G	Header, Nominal current: 12 A, Nom. voltage: 250 V, Pitch: 5 mm, Number of positions: 8, Color: green, Assembly: Press-in
1914917	EMSTBVA 2,5/ 8-G	Header, Nominal current: 12 A, Nom. voltage: 200 V, Pitch: 5 mm, Number of positions: 8, Color: green, Assembly: Press-in
1762758	MDSTB 2,5/ 8-G1	Header, Nominal current: 10 A, Nom. voltage: 250 V, Pitch: 5 mm, Number of positions: 8, Color: green, Assembly: Soldering
1846577	MDSTBA 2,5/ 8-G	Header, Nominal current: 10 A, Nom. voltage: 250 V, Pitch: 5 mm, Number of positions: 8, Color: green, Assembly: Soldering
1762907	MDSTBV 2,5/ 8-G1	Header, Nominal current: 10 A, Nom. voltage: 250 V, Pitch: 5 mm, Number of positions: 8, Color: green, Assembly: Soldering
1845840	MDSTBVA 2,5/ 8-G	Header, Nominal current: 10 A, Nom. voltage: 250 V, Pitch: 5 mm, Number of positions: 8, Color: green, Assembly: Soldering
1754559	MSTB 2,5/ 8-G	Header, Nominal current: 12 A, Nom. voltage: 250 V, Pitch: 5 mm, Number of positions: 8, Color: green, Assembly: Soldering
1768244	MSTB 2,5/ 8-G-LA	Header, Nominal current: 12 A, Nom. voltage: 250 V, Pitch: 5 mm, Number of positions: 8, Assembly: Soldering
1757527	MSTBA 2,5/ 8-G	Header, Nominal current: 12 A, Nom. voltage: 250 V, Pitch: 5 mm, Number of positions: 8, Color: green, Assembly: Soldering
1770546	MSTBA 2,5/ 8-G-LA	Header, Nominal current: 12 A, Nom. voltage: 250 V, Pitch: 5 mm, Number of positions: 8, Assembly: Soldering
1753550	MSTBV 2,5/ 8-G	Header, Nominal current: 12 A, Nom. voltage: 250 V, Pitch: 5 mm, Number of positions: 8, Color: green, Assembly: Soldering
1755574	MSTBVA 2,5/ 8-G	Header, Nominal current: 12 A, Nom. voltage: 250 V, Pitch: 5 mm, Number of positions: 8, Color: green, Assembly: Soldering
1736056	MSTBW 2,5/ 8-G	Header, Nominal current: 12 A, Nom. voltage: 250 V, Pitch: 5 mm, Number of positions: 8, Color: green, Assembly: Soldering
1769298	SMSTB 2,5/ 8-G	Header, Nominal current: 12 A, Nom. voltage: 250 V, Pitch: 5 mm, Number of positions: 8, Color: green, Assembly: Soldering
1769861	SMSTBA 2,5/ 8-G	Header, Nominal current: 12 A, Nom. voltage: 250 V, Pitch: 5 mm, Number of positions: 8, Color: green, Assembly: Soldering

Diagrams/Drawings

Diagram

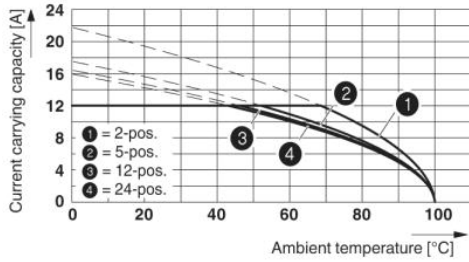

Type: MVSTBR 2,5/...-ST(5,08) with MSTBA 2,5/...-G(-5,08)

Dimensioned drawing

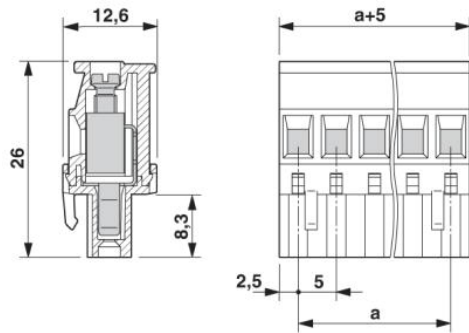

Address

PHOENIX CONTACT Inc., USA
586 Fulling Mill Road
Middletown, PA 17057, USA
Phone (800) 888-7388
Fax (717) 944-1625
<http://www.phoenixcon.com>



© 2010 Phoenix Contact
Technical modifications reserved;